



Shenzhen Huaxia Testing Technology Co., Ltd

1F., Block A of Tongsheng Technology Building, Huahui Road, Dalang Street, Longhua District, Shenzhen, China

Telephone: +86-755-26648640
Fax: +86-755-26648637
Website: www.cqa-cert.com

Report Template Version: V03
Report Template Revision Date: Mar.1st, 2017

Test Report

Report No. : CQASZ20210701105E-01
Applicant: XIAMEN COMFORT SCIENCE & TECHNOLOGY GROUP CO., LTD.
Address of Applicant: (5/F) NO.168, QIANPU ROAD, SIMING DISTRICT, XIAMEN, CHINA.
Equipment Under Test (EUT):
Product: Massage Chair
All Model No.: AM-3D Pro Tecno, EI-6501A, Osaki-Pro 3D Prestige, Pro-Prestige 3D, EI-6501C, Titan Pro-Prestige, Titan Pro-3D Prestige, 6501F, AmaMedic-Premium
Test Model No.: AM-3D Pro Tecno
Brand Name: N/A
FCC ID: YMX-EI6501A-01
Standards: 47 CFR Part 15, Subpart C
Date of Test: 2021-7-19 to 2021-8-9
Date of Issue: 2021-08-30
Test Result : **PASS***

Tested By:

Lewis Zhou

(Lewis Zhou)

Reviewed By:

Jun Li

(Jun Li)

Approved By:

Jack ai

(Jack ai)



* In the configuration tested, the EUT complied with the standards specified above.

The test report is effective only with both signature and specialized stamp, The result(s) shown in this report refer only to the sample(s) tested. Without written approval of CQA, this report can't be reproduced except in full.

1 Version

Revision History Of Report

Report No.	Version	Description	Issue Date
CQASZ20210701105E-01	Rev.01	Initial report	2021-08-30

2 Test Summary

Test Item	Test Requirement	Test method	Result
Antenna Requirement	47 CFR Part 15, Subpart C Section 15.203/15.247 (c)	ANSI C63.10 (2013)	PASS
AC Power Line Conducted Emission	47 CFR Part 15, Subpart C Section 15.207	ANSI C63.10 (2013)	PASS
Conducted Peak Output Power	47 CFR Part 15, Subpart C Section 15.247 (b)(1)	ANSI C63.10 (2013)	PASS
20dB Occupied Bandwidth	47 CFR Part 15, Subpart C Section 15.247 (a)(1)	ANSI C63.10 (2013)	PASS
Carrier Frequencies Separation	47 CFR Part 15, Subpart C Section 15.247 (a)(1)	ANSI C63.10 (2013)	PASS
Hopping Channel Number	47 CFR Part 15, Subpart C Section 15.247 (a)(1)	ANSI C63.10 (2013)	PASS
Dwell Time	47 CFR Part 15, Subpart C Section 15.247 (a)(1)	ANSI C63.10 (2013)	PASS
Pseudorandom Frequency Hopping Sequence	47 CFR Part 15, Subpart C Section 15.247(b)(4)&TCB Exclusion List (7 July 2002)	ANSI C63.10 (2013)	PASS
Band-edge for RF Conducted Emissions	47 CFR Part 15, Subpart C Section 15.247(d)	ANSI C63.10 (2013)	PASS
RF Conducted Spurious Emissions	47 CFR Part 15, Subpart C Section 15.247(d)	ANSI C63.10 (2013)	PASS
Radiated Spurious emissions	47 CFR Part 15, Subpart C Section 15.205/15.209	ANSI C63.10 (2013)	PASS
Restricted bands around fundamental frequency (Radiated Emission)	47 CFR Part 15, Subpart C Section 15.205/15.209	ANSI C63.10 (2013)	PASS

3 Contents

	Page
1 VERSION.....	2
2 TEST SUMMARY.....	3
3 CONTENTS.....	4
4 GENERAL INFORMATION.....	5
4.1 CLIENT INFORMATION.....	5
4.2 GENERAL DESCRIPTION OF EUT.....	5
4.3 ADDITIONAL INSTRUCTIONS.....	7
4.4 TEST ENVIRONMENT.....	8
4.5 DESCRIPTION OF SUPPORT UNITS.....	8
4.6 STATEMENT OF THE MEASUREMENT UNCERTAINTY.....	9
4.7 TEST LOCATION.....	10
4.8 TEST FACILITY.....	10
4.9 ABNORMALITIES FROM STANDARD CONDITIONS.....	10
4.10 OTHER INFORMATION REQUESTED BY THE CUSTOMER.....	10
4.11 EQUIPMENT LIST.....	11
5 TEST RESULTS AND MEASUREMENT DATA.....	12
5.1 ANTENNA REQUIREMENT.....	12
5.2 CONDUCTED EMISSIONS.....	13
5.3 CONDUCTED PEAK OUTPUT POWER.....	17
5.4 20dB OCCUPY BANDWIDTH.....	22
5.5 CARRIER FREQUENCIES SEPARATION.....	26
5.6 HOPPING CHANNEL NUMBER.....	31
5.7 DWELL TIME.....	33
5.8 BAND-EDGE FOR RF CONDUCTED EMISSIONS.....	44
5.9 SPURIOUS RF CONDUCTED EMISSIONS.....	50
5.10 OTHER REQUIREMENTS FREQUENCY HOPPING SPREAD SPECTRUM SYSTEM.....	63
5.11 RADIATED SPURIOUS EMISSION & RESTRICTED BANDS.....	65
5.11.1 Radiated Emission below 1GHz.....	68
5.11.2 Transmitter Emission above 1GHz.....	70
6 PHOTOGRAPHS - EUT TEST SETUP.....	71
6.1 RADIATED EMISSION.....	71
6.2 CONDUCTED EMISSION.....	72
7 PHOTOGRAPHS - EUT CONSTRUCTIONAL DETAILS.....	73

4 General Information

4.1 Client Information

Applicant:	XIAMEN COMFORT SCIENCE & TECHNOLOGY GROUP CO., LTD.
Address of Applicant:	(5/F) NO.168, QIANPU ROAD, SIMING DISTRICT, XIAMEN, CHINA.
Manufacturer:	XIAMEN HEALTHCARE ELECTRONIC CO., LTD.
Address of Manufacturer:	65-66#, 62-63#Building, Siming Zone, Tongan Industrial District, Xiamen City, Fujian Province, P.R. China
Factory:	XIAMEN HEALTHCARE ELECTRONIC CO., LTD.
Address of Factory:	65-66#, 62-63#Building, Siming Zone, Tongan Industrial District, Xiamen City, Fujian Province, P.R. China

4.2 General Description of EUT

Product Name:	Massage Chair
All Model No.:	AM-3D Pro Tecno, EI-6501A, Osaki-Pro 3D Prestige, Pro-Prestige 3D, EI-6501C, Titan Pro-Prestige, Titan Pro-3D Prestige, 6501F, AmaMedic-Premium
Test Model No.:	AM-3D Pro Tecno
Trade Mark:	N/A
Hardware Version:	V1.1
Software Version:	V1.0
Operation Frequency:	2402MHz~2480MHz
Bluetooth Version:	V5.0
Modulation Technique:	Frequency Hopping Spread Spectrum(FHSS)
Modulation Type:	GFSK, $\pi/4$ DQPSK
Transfer Rate:	1Mbps/2Mbps
Number of Channel:	79
Hopping Channel Type:	Adaptive Frequency Hopping systems
Product Type:	<input type="checkbox"/> Mobile <input type="checkbox"/> Portable <input checked="" type="checkbox"/> Fix Location
Test Software of EUT:	FCC Assist 1.0.0.2
Antenna Type:	PCB antenna
Antenna Gain:	-1.39dBi
Power Supply:	Input voltage: 110V-120V~, 60Hz Rated current: 1.1A

Note:

All model:AM-3D Pro Tecno, EI-6501A, Osaki-Pro 3D Prestige, Pro-Prestige 3D, EI-6501C, Titan Pro-Prestige, Titan Pro-3D Prestige, 6501F, AmaMedic-Premium

Only the model AM-3D Pro Tecno was tested, since the electrical circuit design, layout, components used and internal wiring were identical for the above models, with difference being color of appearance and model name.

Operation Frequency each of channel							
Channel	Frequency	Channel	Frequency	Channel	Frequency	Channel	Frequency
0	2402MHz	20	2422MHz	40	2442MHz	60	2462MHz
1	2403MHz	21	2423MHz	41	2443MHz	61	2463MHz
2	2404MHz	22	2424MHz	42	2444MHz	62	2464MHz
3	2405MHz	23	2425MHz	43	2445MHz	63	2465MHz
4	2406MHz	24	2426MHz	44	2446MHz	64	2466MHz
5	2407MHz	25	2427MHz	45	2447MHz	65	2467MHz
6	2408MHz	26	2428MHz	46	2448MHz	66	2468MHz
7	2409MHz	27	2429MHz	47	2449MHz	67	2469MHz
8	2410MHz	28	2430MHz	48	2450MHz	68	2470MHz
9	2411MHz	29	2431MHz	49	2451MHz	69	2471MHz
10	2412MHz	30	2432MHz	50	2452MHz	70	2472MHz
11	2413MHz	31	2433MHz	51	2453MHz	71	2473MHz
12	2414MHz	32	2434MHz	52	2454MHz	72	2474MHz
13	2415MHz	33	2435MHz	53	2455MHz	73	2475MHz
14	2416MHz	34	2436MHz	54	2456MHz	74	2476MHz
15	2417MHz	35	2437MHz	55	2457MHz	75	2477MHz
16	2418MHz	36	2438MHz	56	2458MHz	76	2478MHz
17	2419MHz	37	2439MHz	57	2459MHz	77	2479MHz
18	2420MHz	38	2440MHz	58	2460MHz	78	2480MHz
19	2421MHz	39	2441MHz	59	2461MHz		

Note:

In section 15.31(m), regards to the operating frequency range over 10 MHz, the Lowest frequency, the middle frequency, and the highest frequency of channel were selected to perform the test, and the selected channel see below:

Channel	Frequency
The Lowest channel	2402MHz
The Middle channel	2441MHz
The Highest channel	2480MHz

4.3 Additional Instructions

EUT Test Software Settings:		
Mode:	<input checked="" type="checkbox"/> Special software is used. <input type="checkbox"/> Through engineering command into the engineering mode. engineering command: ###3646633###	
EUT Power level:	Class2 (Power level is built-in set parameters and cannot be changed and selected)	
Use test software to set the lowest frequency, the middle frequency and the highest frequency keep transmitting of the EUT.		
Mode	Channel	Frequency(MHz)
DH1/DH3/DH5	CH0	2402
	CH39	2441
	CH78	2480
2DH1/2DH3/2DH5	CH0	2402
	CH39	2441
	CH78	2480

Run Software:

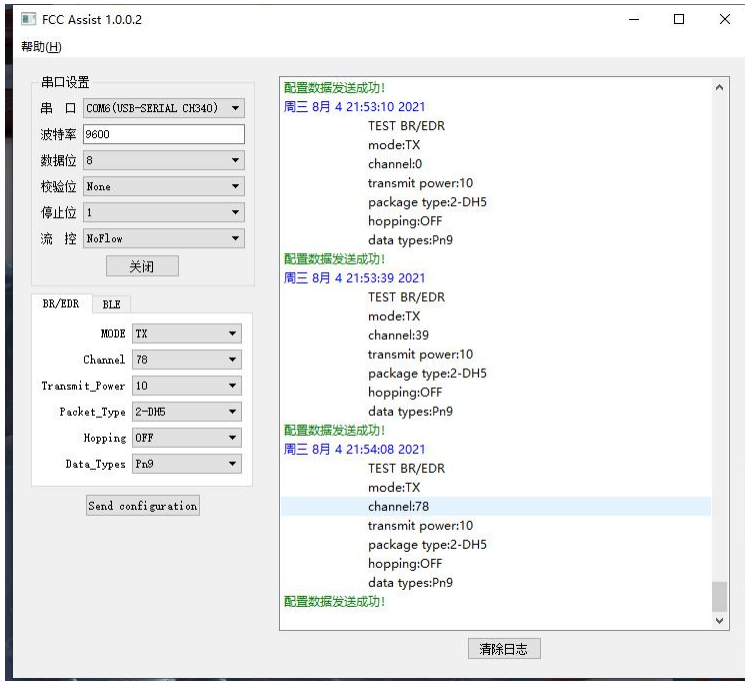

4.4 Test Environment

Operating Environment:	
Temperature:	25.5 °C
Humidity:	53 % RH
Atmospheric Pressure:	1009mbar
Test Mode:	Use test software to set the lowest frequency, the middle frequency and the highest frequency keep transmitting of the EUT.

4.5 Description of Support Units

The EUT has been tested with associated equipment below.

Description	Manufacturer	Model No.	Remark	FCC certification
/	/	/	/	/

4.6 Statement of the measurement uncertainty

The data and results referenced in this document are true and accurate.

The reader is cautioned that there may be errors within the calibration limits of the equipment and facilities.

The measurement uncertainty was calculated for all measurements listed in this test report acc. to CISPR 16 - 4 „Specification for radio disturbance and immunity measuring apparatus and methods – Part 4: Uncertainty in EMC Measurements“ and is documented in the **Shenzhen Huaxia Testing Technology Co., Ltd.** quality system acc. to DIN EN ISO/IEC 17025.

Furthermore, component and process variability of devices similar to that tested may result in additional deviation. The manufacturer has the sole responsibility of continued compliance of the device.

Hereafter the best measurement capability for CQA laboratory is reported:

No.	Item	Uncertainty	Notes
1	Radiated Emission (Below 1GHz)	±5.12dB	(1)
2	Radiated Emission (Above 1GHz)	±4.60dB	(1)
3	Conducted Disturbance (0.15~30MHz)	±3.34dB	(1)
4	Radio Frequency	3×10^{-8}	(1)
5	Duty cycle	0.6 %.	(1)
6	Occupied Bandwidth	1.1%	(1)
7	RF conducted power	0.86dB	(1)
8	RF power density	0.74	(1)
9	Conducted Spurious emissions	0.86dB	(1)
10	Temperature test	0.8°C	(1)
11	Humidity test	2.0%	(1)
12	Supply voltages	0.5 %.	(1)
13	time	0.6 %.	(1)
14	Frequency Error	5.5 Hz	(1)

(1) This uncertainty represents an expanded uncertainty expressed at approximately the 95% confidence level using a coverage factor of k=2.

4.7 Test Location

Shenzhen Huaxia Testing Technology Co., Ltd,

1F., Block A of Tongsheng Technology Building, Huahui Road, Dalang Street, Longhua District, Shenzhen, China

4.8 Test Facility

The test facility is recognized, certified, or accredited by the following organizations:

IC Registration No.: 22984-1

The 3m Semi-anechoic chamber of Shenzhen Huaxia Testing Technology Co., Ltd. has been registered by Certification and Engineering Bureau of Industry Canada for radio equipment testing

The test facility is recognized, certified, or accredited by the following organizations:

• **CNAS (No. CNAS L5785)**

CNAS has accredited Shenzhen Huaxia Testing Technology Co., Ltd. Shenzhen Branch EMC Lab to ISO/IEC 17025:2005 General Requirements for the Competence of Testing and Calibration Laboratories (CNAS-CL01 Accreditation Criteria for the Competence of Testing and Calibration Laboratories) for the competence in the field of testing.

• **A2LA (Certificate No. 4742.01)**

Shenzhen Huaxia Testing Technology Co., Ltd., Shenzhen EMC Laboratory is accredited by the American Association for Laboratory Accreditation(A2LA). Certificate No. 4742.01.

• **FCC Registration No.: 522263**

Shenzhen Huaxia Testing Technology Co., Ltd., Shenzhen EMC Laboratory has been registered and fully described in a report filed with the (FCC) Federal Communications Commission. The acceptance letter from the FCC is maintained in our files. Registration No.:522263

4.9 Abnormalities from Standard Conditions

None.

4.10 Other Information Requested by the Customer

None.

4.11 Equipment List

Test Equipment	Manufacturer	Model No.	Instrument No.	Calibration Date	Calibration Due Date
EMI Test Receiver	R&S	ESR7	CQA-005	2020/9/26	2021/9/25
Spectrum analyzer	R&S	FSU26	CQA-038	2020/10/28	2021/10/27
Preamplifier	MITEQ	AFS4-00010300-18-10P-4	CQA-035	2020/9/26	2021/9/25
Preamplifier	MITEQ	AMF-6D-02001800-29-20P	CQA-036	2020/11/2	2021/11/1
Loop antenna	Schwarzbeck	FMZB1516	CQA-087	2020/10/28	2021/10/27
Bilog Antenna	R&S	HL562	CQA-011	2020/9/26	2021/9/25
Horn Antenna	R&S	HF906	CQA-012	2020/9/26	2021/9/25
Horn Antenna	Schwarzbeck	BBHA 9170	CQA-088	2020/9/26	2021/9/25
Coaxial Cable (Above 1GHz)	CQA	N/A	C019	2020/9/26	2021/9/25
Coaxial Cable (Below 1GHz)	CQA	N/A	C020	2020/9/26	2021/9/25
Antenna Connector	CQA	RFC-01	CQA-080	2020/9/26	2021/9/25
RF cable(9KHz~40GHz)	CQA	RF-01	CQA-079	2020/9/26	2021/9/25
Power divider	MIDWEST	PWD-2533-02-SMA-79	CQA-067	2020/9/26	2021/9/25
EMI Test Receiver	R&S	ESPI3	CQA-013	2020/9/26	2021/9/25
LISN	R&S	ENV216	CQA-003	2020/11/5	2021/11/4
Coaxial cable	CQA	N/A	CQA-C009	2020/9/26	2021/9/25

Note:

The temporary antenna connector is soldered on the PCB board in order to perform conducted tests and this temporary antenna connector is listed in the equipment list.

5 Test results and Measurement Data

5.1 Antenna Requirement

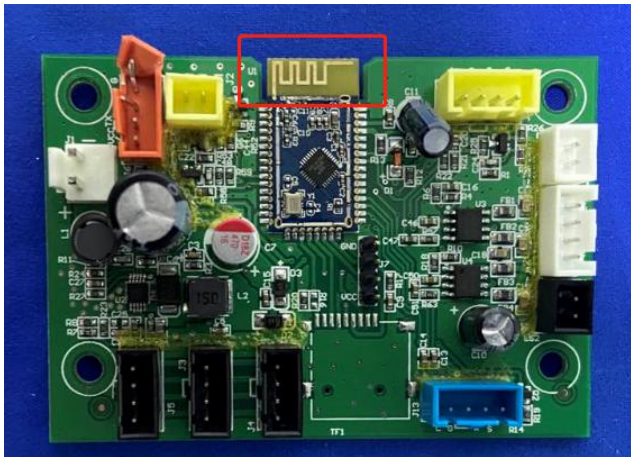
Standard requirement:	47 CFR Part 15C Section 15.203 /247(c)
<p>15.203 requirement: An intentional radiator shall be designed to ensure that no antenna other than that furnished by the responsible party shall be used with the device. The use of a permanently attached antenna or of an antenna that uses a unique coupling to the intentional radiator, the manufacturer may design the unit so that a broken antenna can be replaced by the user, but the use of a standard antenna jack or electrical connector is prohibited.</p> <p>15.247(b) (4) requirement: The conducted output power limit specified in paragraph (b) of this section is based on the use of antennas with directional gains that do not exceed 6 dBi. Except as shown in paragraph (c) of this section, if transmitting antennas of directional gain greater than 6 dBi are used, the conducted output power from the intentional radiator shall be reduced below the stated values in paragraphs (b)(1), (b)(2), and (b)(3) of this section, as appropriate, by the amount in dB that the directional gain of the antenna exceeds 6 dBi.</p>	
EUT Antenna:	
<p>The antenna is PCB antenna. The best case gain of the antenna is -1.39dBi.</p>	

5.2 Conducted Emissions

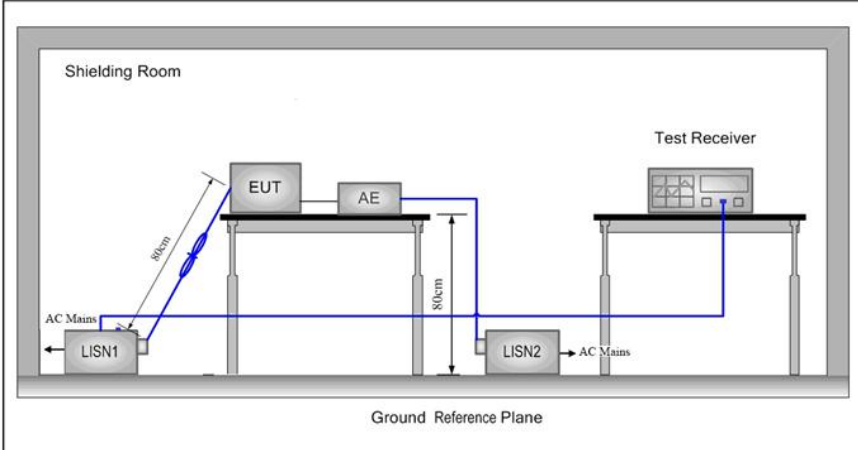
Test Requirement:	47 CFR Part 15C Section 15.207		
Test Method:	ANSI C63.10: 2013		
Test Frequency Range:	150kHz to 30MHz		
Limit:	Frequency range (MHz)	Limit (dBuV)	
		Quasi-peak	Average
	0.15-0.5	66 to 56*	56 to 46*
	0.5-5	56	46
	5-30	60	50
	* Decreases with the logarithm of the frequency.		
Test Procedure:	<ol style="list-style-type: none"> 1) The mains terminal disturbance voltage test was conducted in a shielded room. 2) The EUT was connected to AC power source through a LISN 1 (Line Impedance Stabilization Network) which provides a $50\Omega/50\mu\text{H} + 5\Omega$ linear impedance. The power cables of all other units of the EUT were connected to a second LISN 2, which was bonded to the ground reference plane in the same way as the LISN 1 for the unit being measured. A multiple socket outlet strip was used to connect multiple power cables to a single LISN provided the rating of the LISN was not exceeded. 3) The tabletop EUT was placed upon a non-metallic table 0.8m above the ground reference plane. And for floor-standing arrangement, the EUT was placed on the horizontal ground reference plane, 4) The test was performed with a vertical ground reference plane. The rear of the EUT shall be 0.4 m from the vertical ground reference plane. The vertical ground reference plane was bonded to the horizontal ground reference plane. The LISN 1 was placed 0.8 m from the boundary of the unit under test and bonded to a ground reference plane for LISNs mounted on top of the ground reference plane. This distance was between the closest points of the LISN 1 and the EUT. All other units of the EUT and associated equipment was at least 0.8 m from the LISN 2. 5) In order to find the maximum emission, the relative positions of equipment and all of the interface cables must be changed according to ANSI C63.10: 2013 on conducted measurement. 		
Test Setup:			

Exploratory Test Mode:	Non-hopping transmitting mode with all kind of modulation and all kind of data type at the lowest, middle, high channel.
Final Test Mode:	Through Pre-scan, find the DH5 of data type and GFSK modulation at the lowest channel is the worst case. Only the worst case is recorded in the report.
Test Voltage:	AC 120V/60Hz
Test Results:	Pass

Measurement Data

Live line:

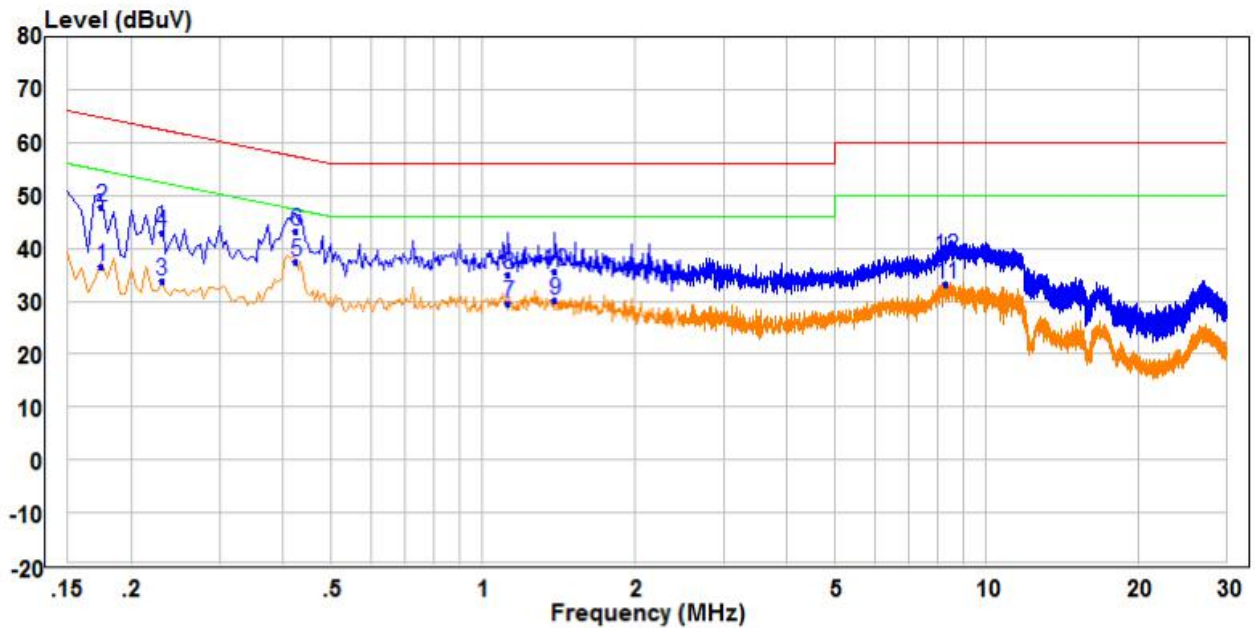

	Freq	Read Level	Factor	Level	Limit Line	Over Limit	Remark	Pol/Phase
	MHz	dBuV	dB	dBuV	dBuV	dB		
1	0.175	26.94	9.49	36.43	54.72	-18.29	Average	Line
2	0.175	38.37	9.49	47.86	64.72	-16.86	QP	Line
3	0.230	24.37	9.49	33.86	52.45	-18.59	Average	Line
4	0.230	33.59	9.49	43.08	62.45	-19.37	QP	Line
5 PP	0.425	27.86	9.51	37.37	47.35	-9.98	Average	Line
6 QP	0.425	33.83	9.51	43.34	57.35	-14.01	QP	Line
7	1.125	20.16	9.53	29.69	46.00	-16.31	Average	Line
8	1.125	25.53	9.53	35.06	56.00	-20.94	QP	Line
9	1.390	20.65	9.53	30.18	46.00	-15.82	Average	Line
10	1.390	25.99	9.53	35.52	56.00	-20.48	QP	Line
11	8.325	23.52	9.74	33.26	50.00	-16.74	Average	Line
12	8.325	28.55	9.74	38.29	60.00	-21.71	QP	Line

Remark:

1. The following Quasi-Peak and Average measurements were performed on the EUT:
2. Final Test Level = Receiver Reading + LISN Factor + Cable Loss.
3. If the Peak value under Average limit, the Average value is not recorded in the report.

Neutral line:

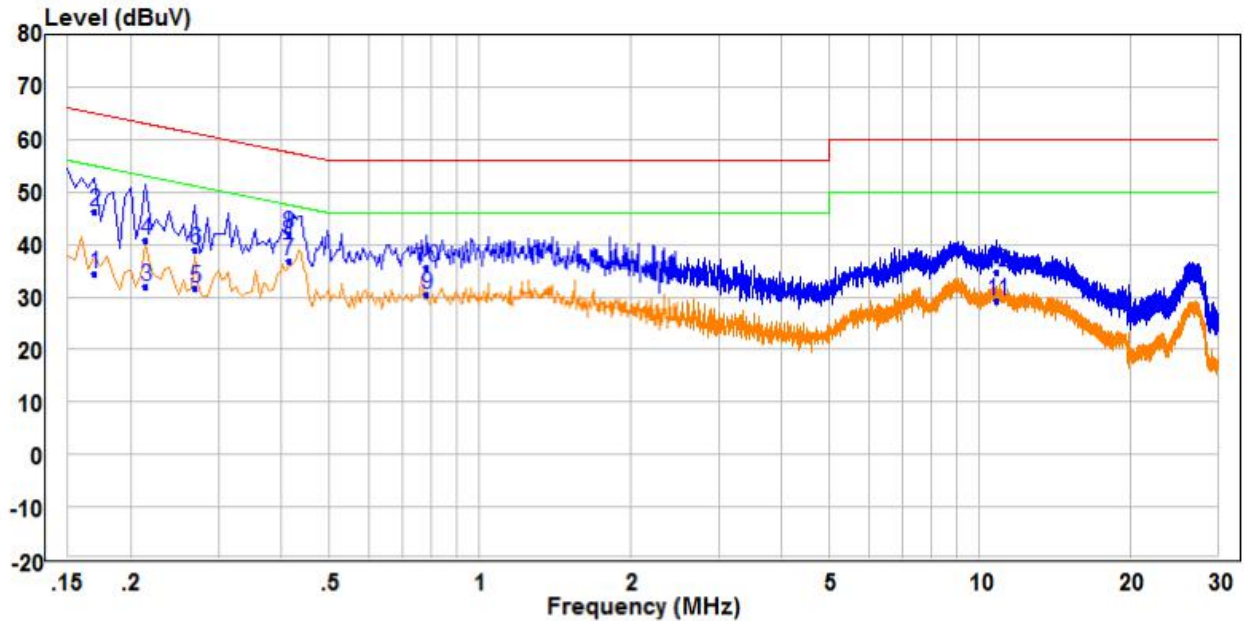

	Freq	Read Level	Factor	Level	Limit Line	Over Limit	Remark	Pol/Phase
	MHz	dBuV	dB	dBuV	dBuV	dB		
1	0.170	25.01	9.48	34.49	54.96	-20.47	Average	Neutral
2	0.170	36.90	9.48	46.38	64.96	-18.58	QP	Neutral
3	0.215	22.66	9.48	32.14	53.01	-20.87	Average	Neutral
4	0.215	31.20	9.48	40.68	63.01	-22.33	QP	Neutral
5	0.270	22.14	9.48	31.62	51.12	-19.50	Average	Neutral
6	0.270	29.47	9.48	38.95	61.12	-22.17	QP	Neutral
7 PP	0.415	27.16	9.55	36.71	47.55	-10.84	Average	Neutral
8 QP	0.415	32.61	9.55	42.16	57.55	-15.39	QP	Neutral
9	0.785	20.56	9.80	30.36	46.00	-15.64	Average	Neutral
10	0.785	25.85	9.80	35.65	56.00	-20.35	QP	Neutral
11	10.825	19.24	9.95	29.19	50.00	-20.81	Average	Neutral
12	10.825	24.73	9.95	34.68	60.00	-25.32	QP	Neutral

Remark:

1. The following Quasi-Peak and Average measurements were performed on the EUT:
2. Final Test Level =Receiver Reading + LISN Factor + Cable Loss.
3. If the Peak value under Average limit, the Average value is not recorded in the report.

5.3 Conducted Peak Output Power

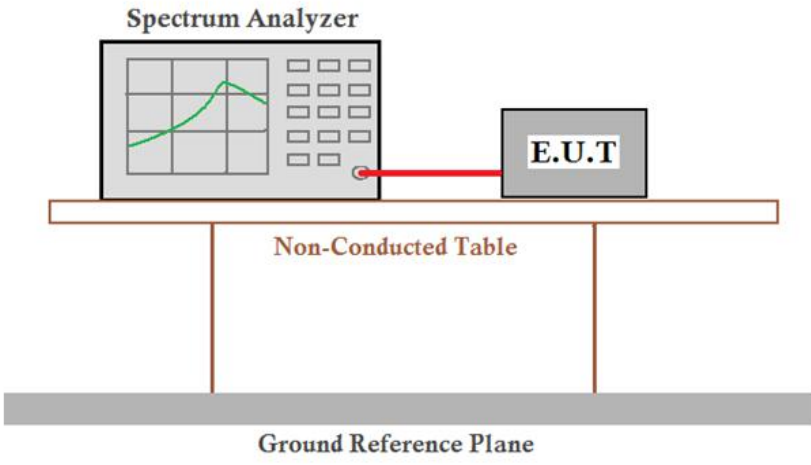
Test Requirement:	47 CFR Part 15C Section 15.247 (b)(1)
Test Method:	ANSI C63.10:2013
Test Setup:	 <p style="text-align: center;"><i>Remark: Offset=Cable loss+ attenuation factor.</i></p>
Limit:	21dBm
Exploratory Test Mode:	Non-hopping transmitting with all kind of modulation and all kind of data type
Final Test Mode:	Through Pre-scan, find the DH5 of data type is the worst case of GFSK modulation type, 2-DH5 of data type is the worst case of $\pi/4$ DQPSK modulation type, 3-DH5 of data type is the worst case of 8DPSK modulation type. Only the worst case is recorded in the report.
Test Results:	Pass

Measurement Data

GFSK mode			
Test channel	Peak Output Power (dBm)	Limit (dBm)	Result
Lowest	-0.700	21.00	Pass
Middle	0.390	21.00	Pass
Highest	1.920	21.00	Pass
$\pi/4$ DQPSK mode			
Test channel	Peak Output Power (dBm)	Limit (dBm)	Result
Lowest	0.000	21.00	Pass
Middle	1.010	21.00	Pass
Highest	2.460	21.00	Pass

Test plot as follows:

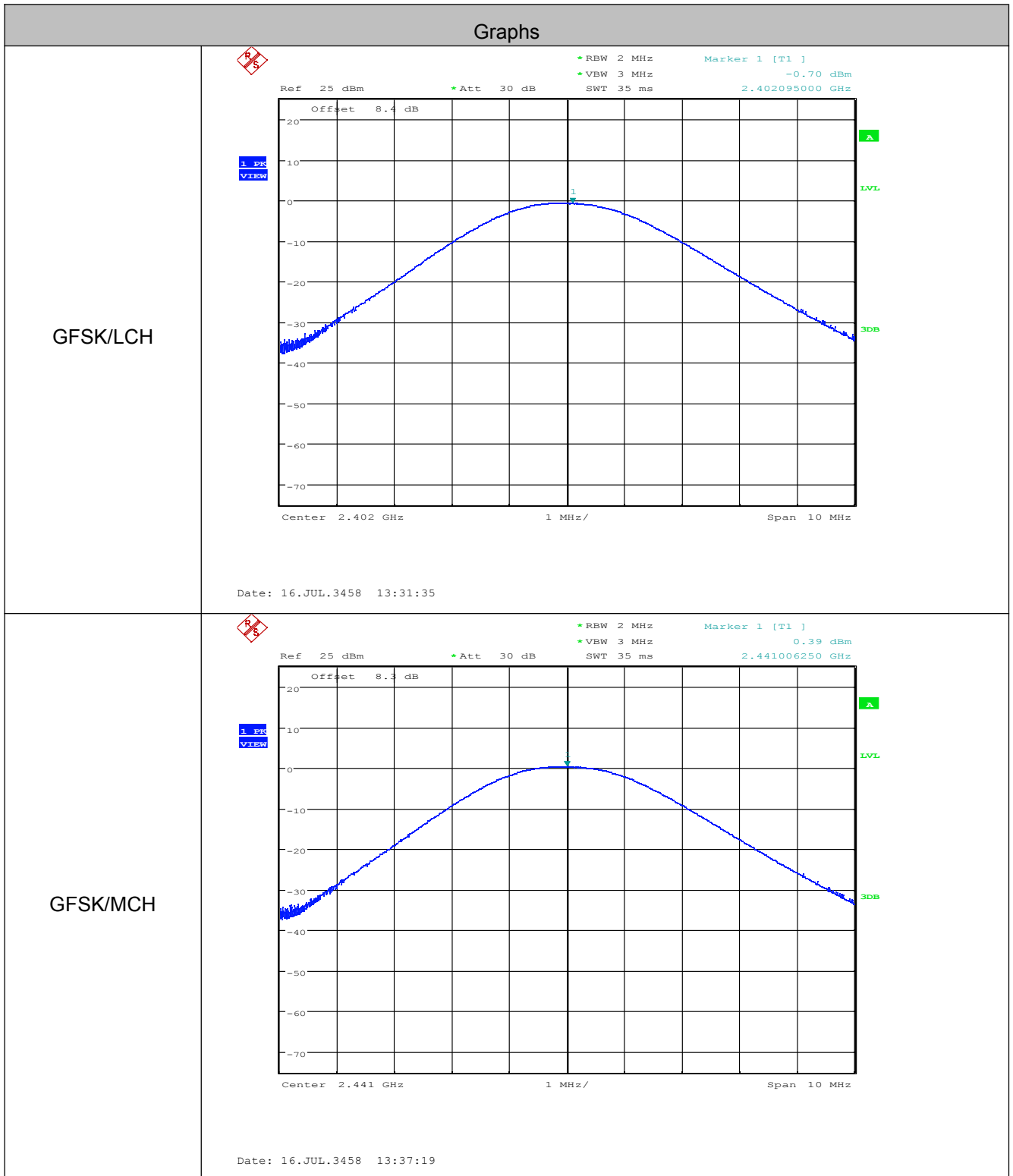

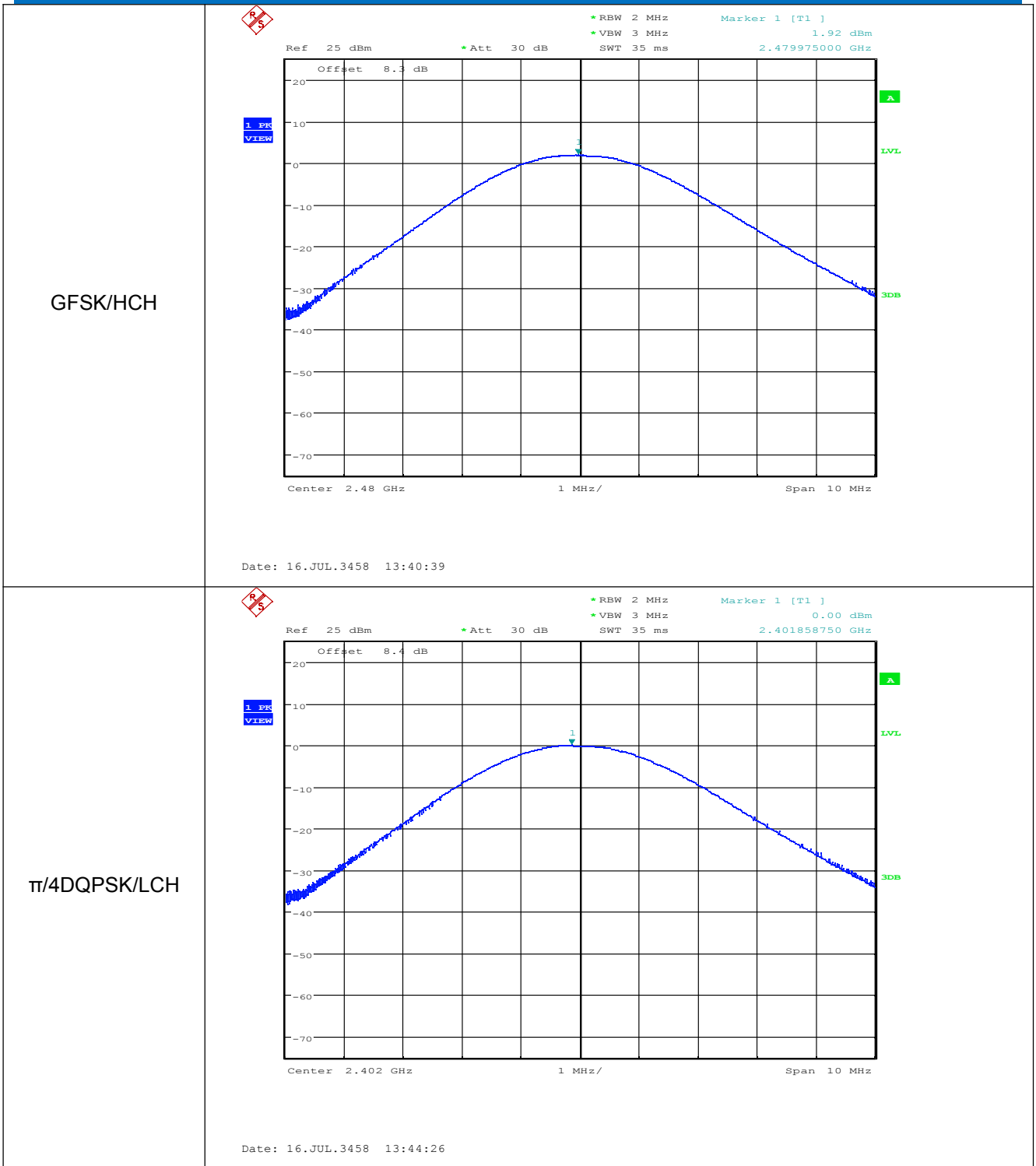

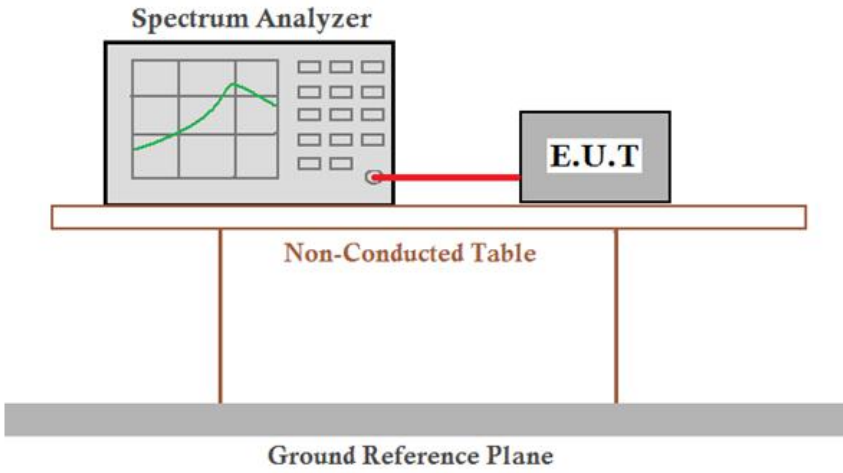

5.4 20dB Occupy Bandwidth

Test Requirement:	47 CFR Part 15C Section 15.247 (a)(1)
Test Method:	ANSI C63.10:2013
Test Setup:	 <p>Remark: Offset=Cable loss+ attenuation factor.</p>
Limit:	NA
Exploratory Test Mode:	Non-hopping transmitting with all kind of modulation and all kind of data type
Final Test Mode:	Through Pre-scan, find the DH5 of data type is the worst case of GFSK modulation type, 2-DH5 of data type is the worst case of $\pi/4$ DQPSK modulation type, 3-DH5 of data type is the worst case of 8DPSK modulation type. Only the worst case is recorded in the report.
Test Results:	Pass

Measurement Data

Test channel	20dB Occupy Bandwidth (MHz)	
	GFSK	$\pi/4$ DQPSK
Lowest	0.950	1.308
Middle	0.952	1.310
Highest	0.950	1.318

Test plot as follows:

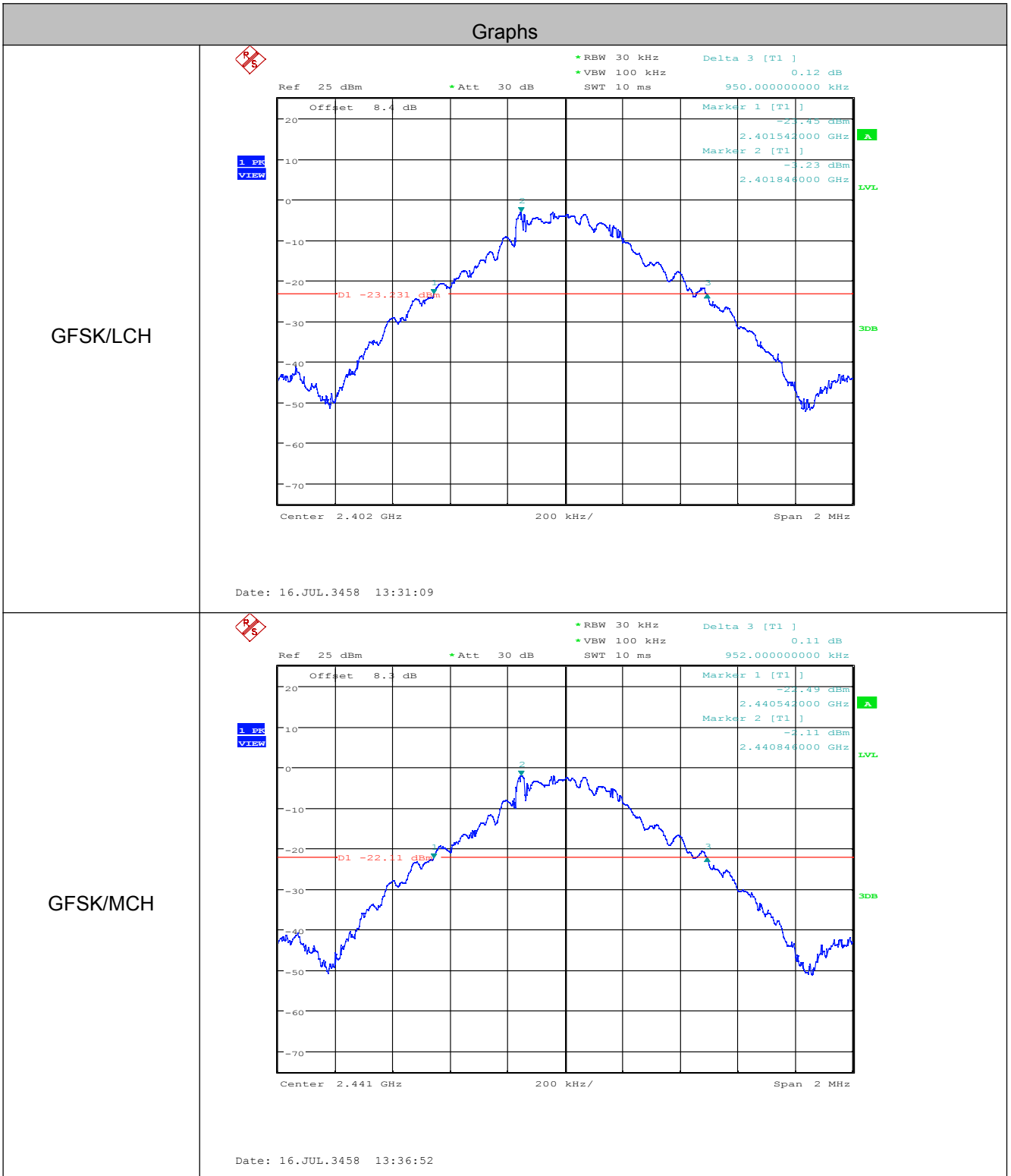

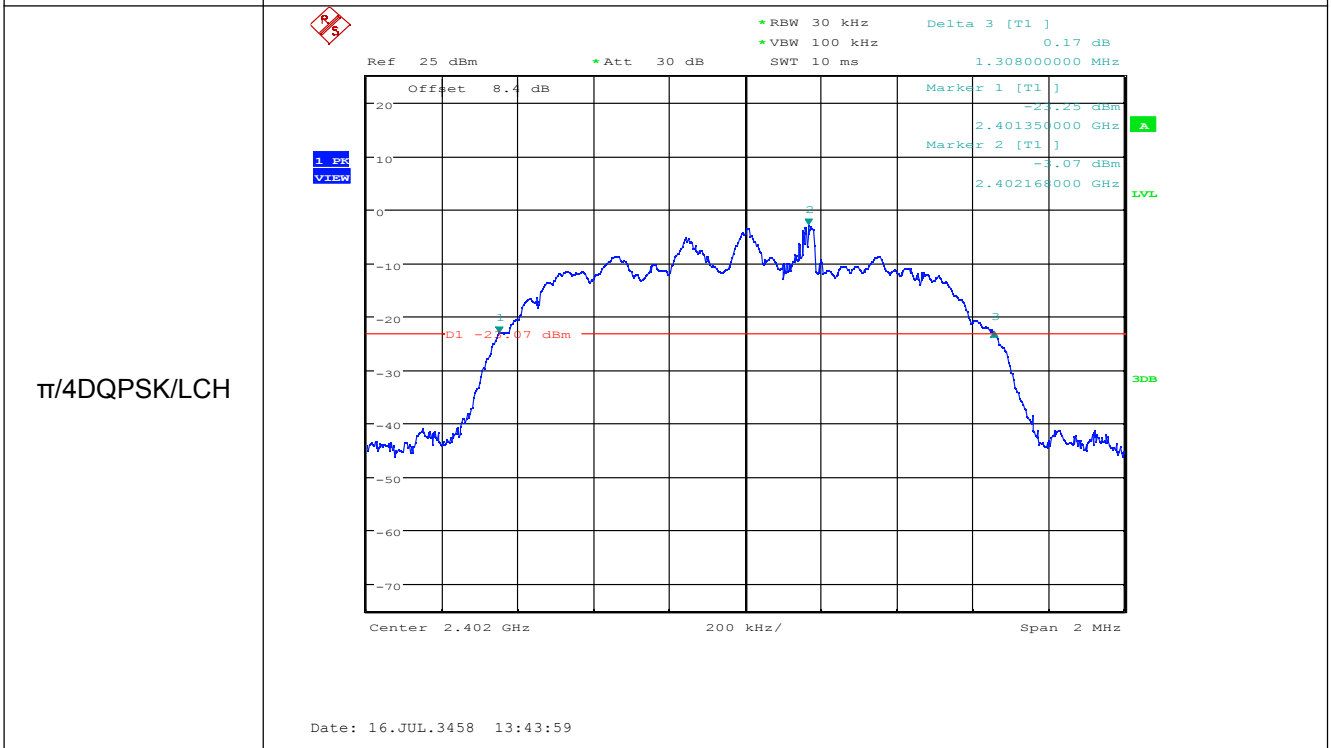
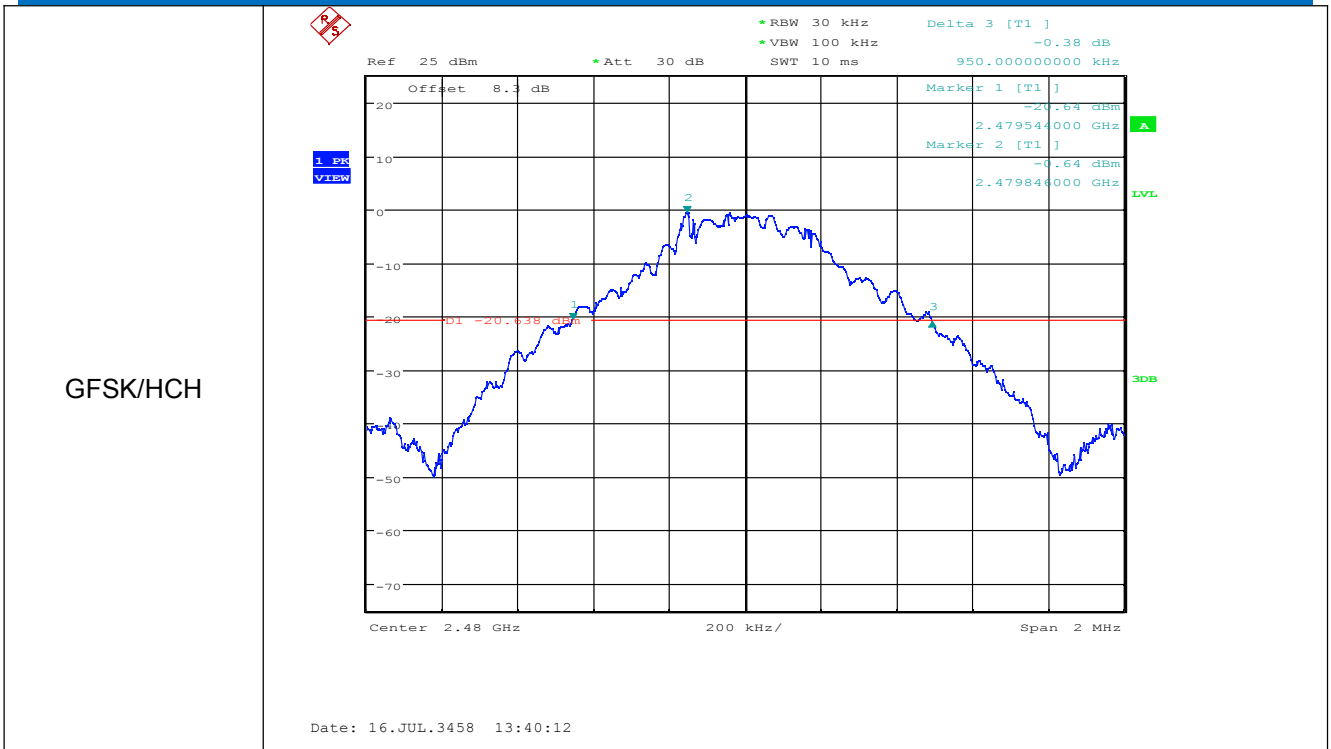

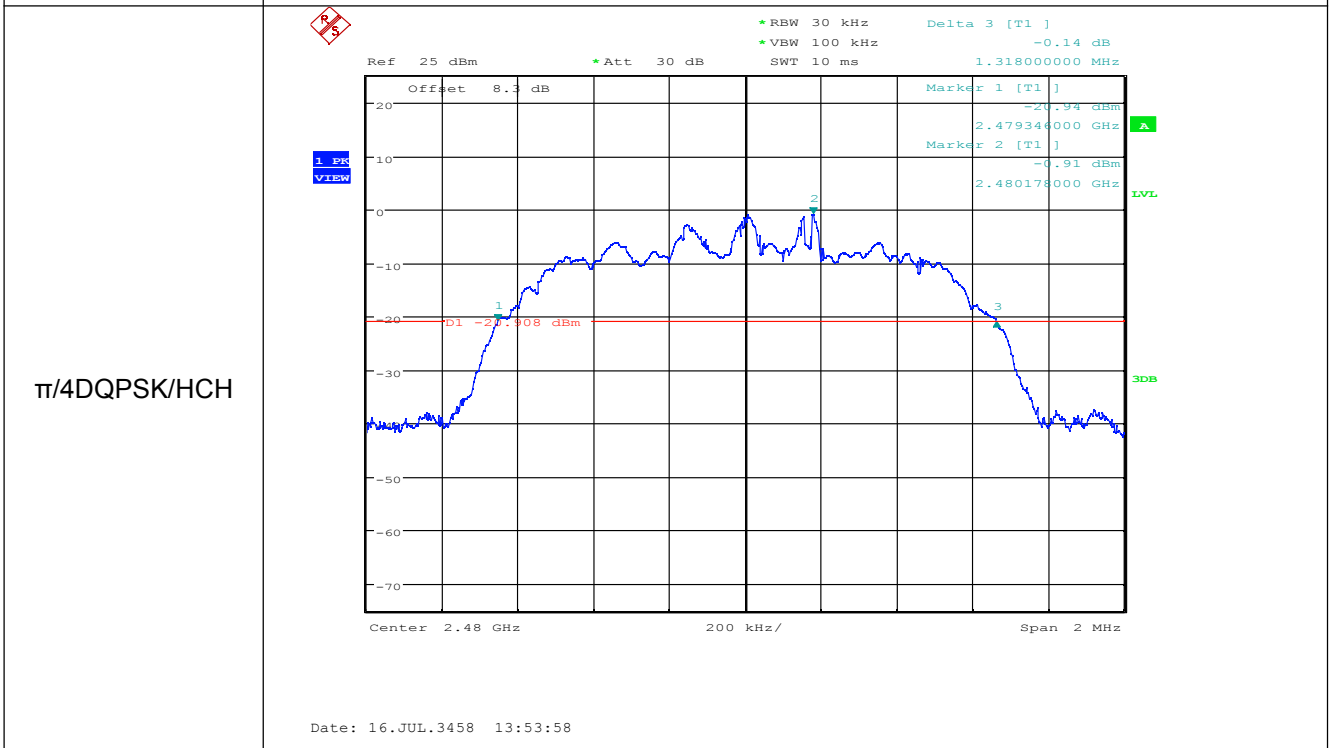
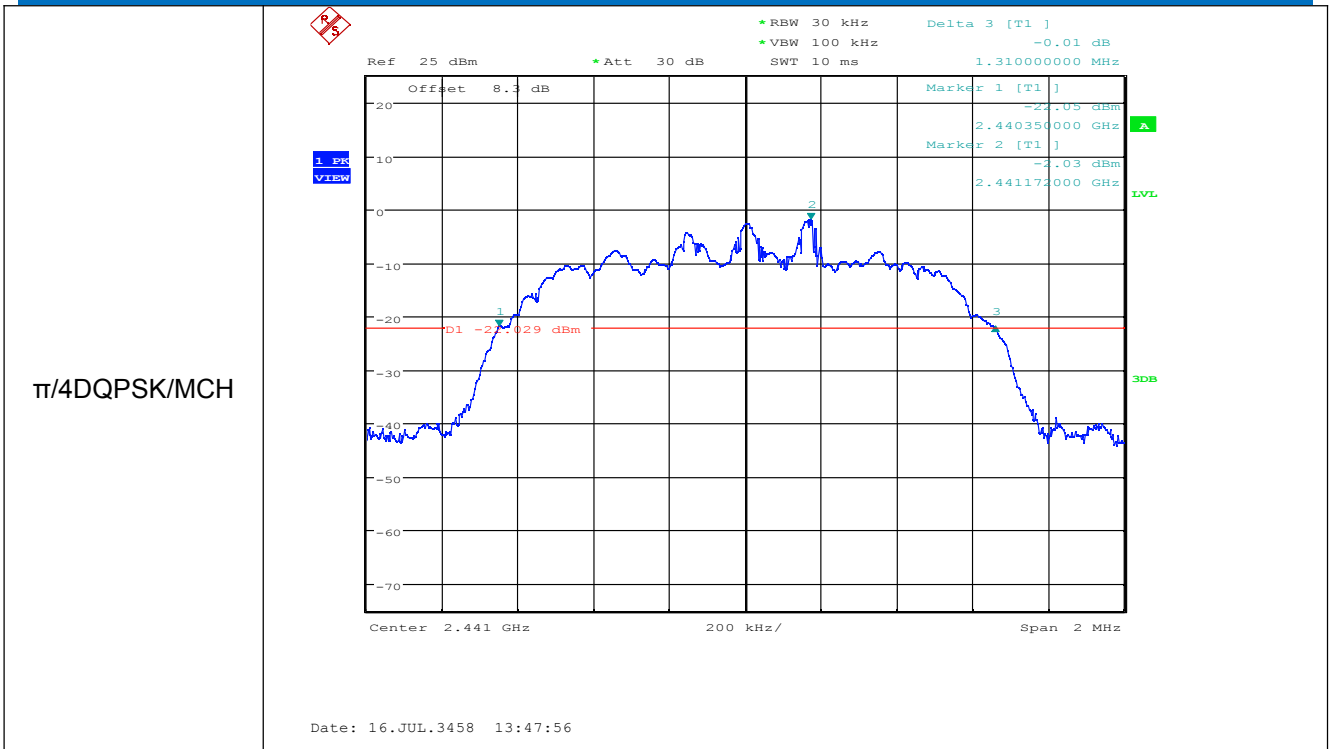

5.5 Carrier Frequencies Separation

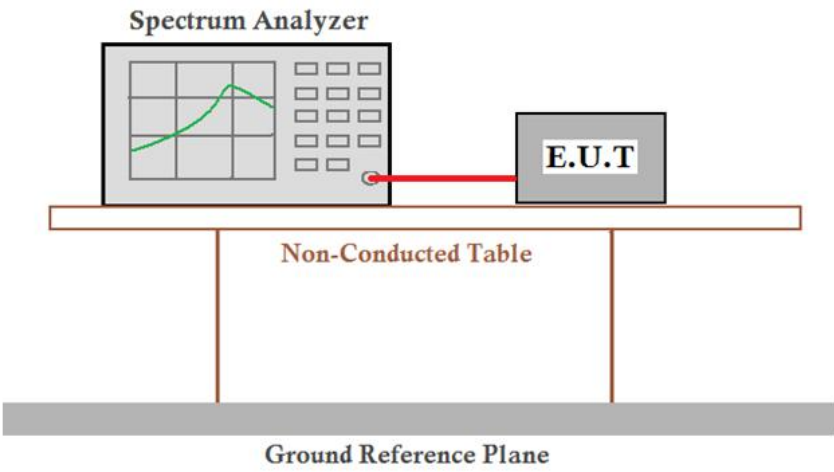
Test Requirement:	47 CFR Part 15C Section 15.247 (a)(1)
Test Method:	ANSI C63.10:2013
Test Setup:	 <p>Remark: Offset=Cable loss+ attenuation factor.</p>
Limit:	2/3 of the 20dB bandwidth
	Remark: the transmission power is less than 0.125W.
Exploratory Test Mode:	Hopping transmitting with all kind of modulation and all kind of data type
Final Test Mode:	Through Pre-scan, find the DH5 of data type is the worst case of GFSK modulation type, 2-DH5 of data type is the worst case of $\pi/4$ DQPSK modulation type, 3-DH5 of data type is the worst case of 8DPSK modulation type. Only the worst case is recorded in the report.
Test Results:	Pass

Measurement Data

GFSK mode			
Test channel	Carrier Frequencies Separation (MHz)	Limit (MHz)	Result
Lowest	1.010	≥0.635	Pass
Middle	0.995	≥0.635	Pass
Highest	1.010	≥0.635	Pass
π/4DQPSK mode			
Test channel	Carrier Frequencies Separation (MHz)	Limit (MHz)	Result
Lowest	0.995	≥0.874	Pass
Middle	1.005	≥0.874	Pass
Highest	1.000	≥0.874	Pass

Mode	20dB bandwidth (MHz) (worse case)	Limit (MHz) (Carrier Frequencies Separation)
GFSK	0.952	0.635
π/4DQPSK	1.310	0.874

Test plot as follows:

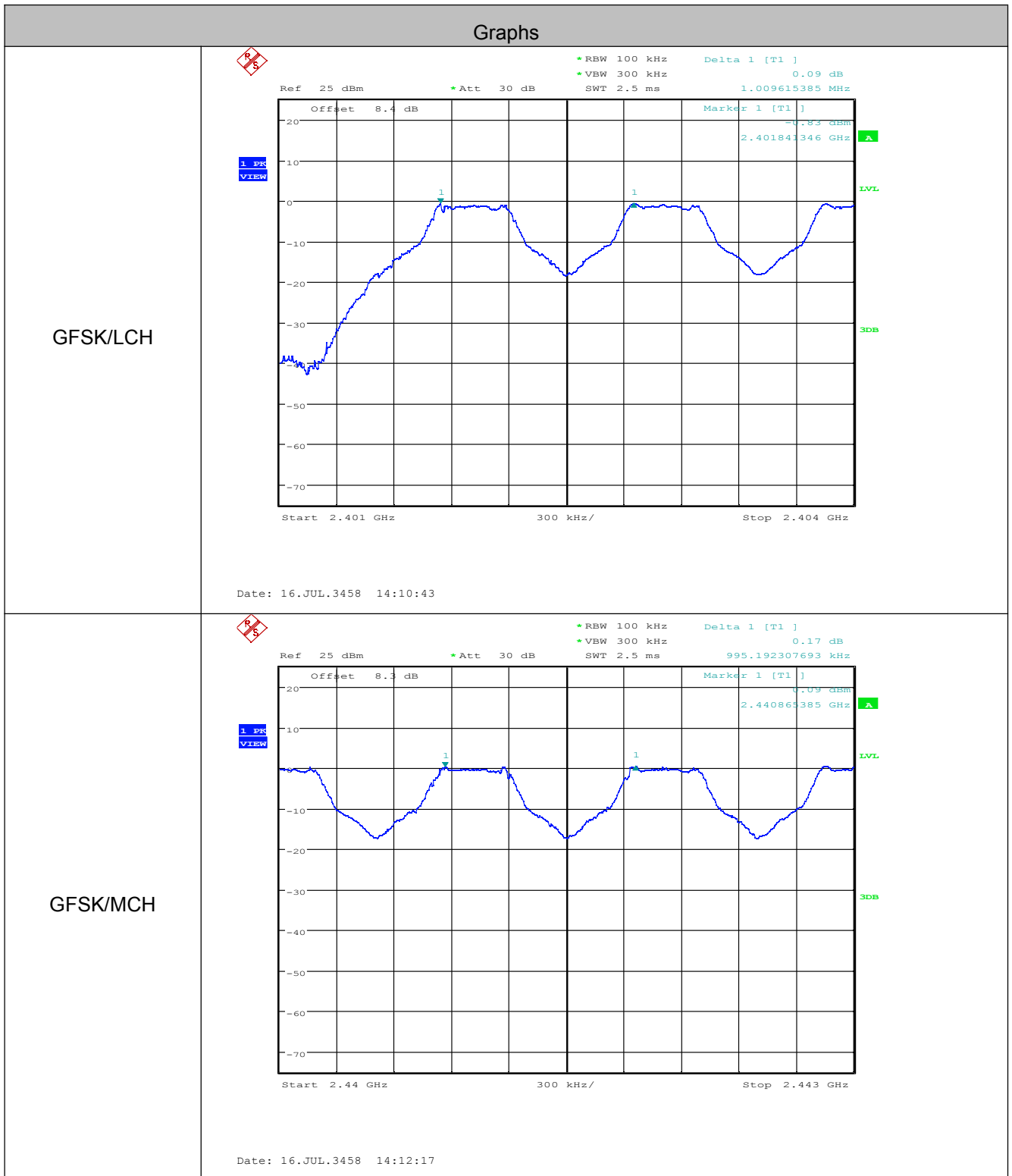

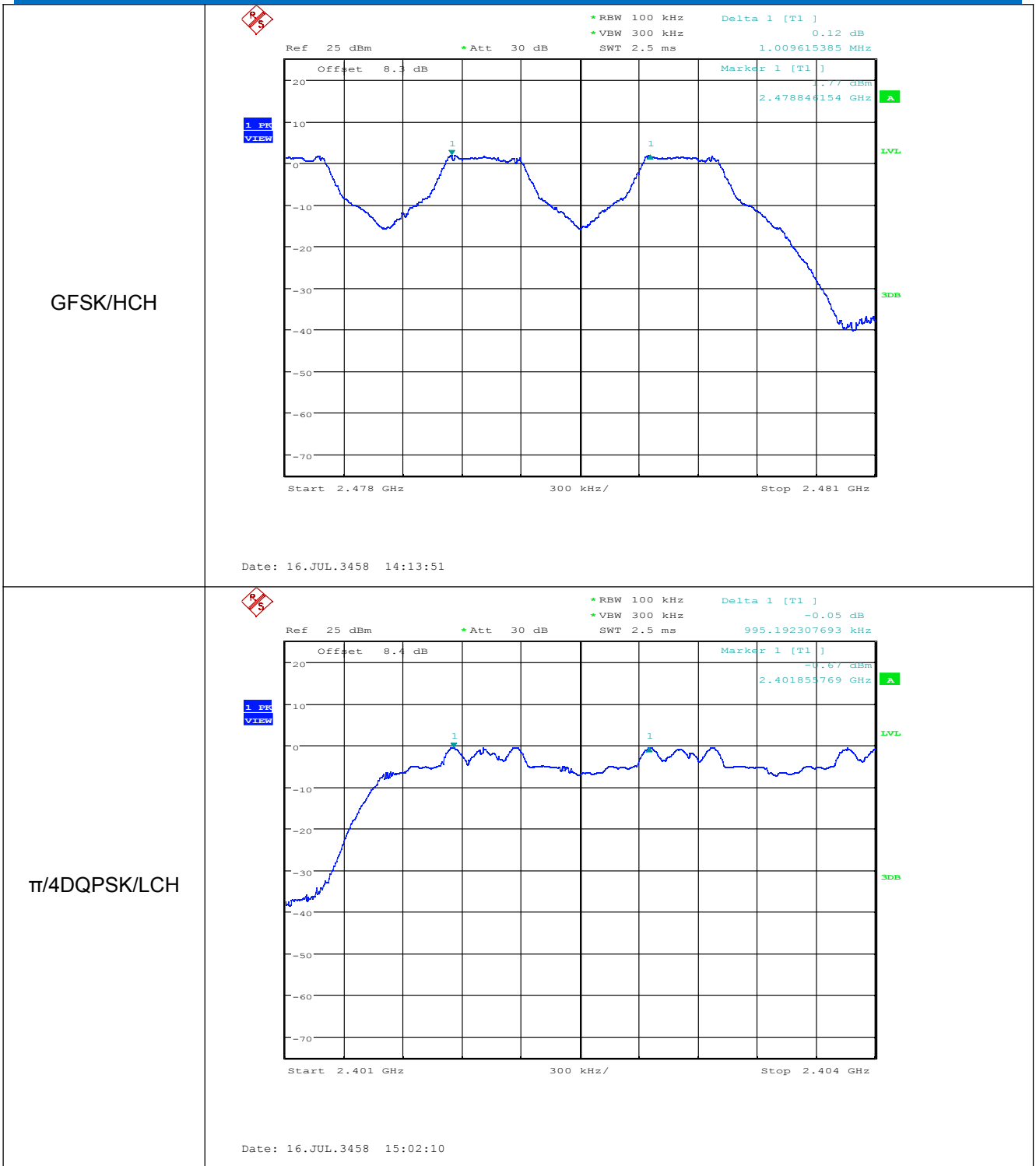

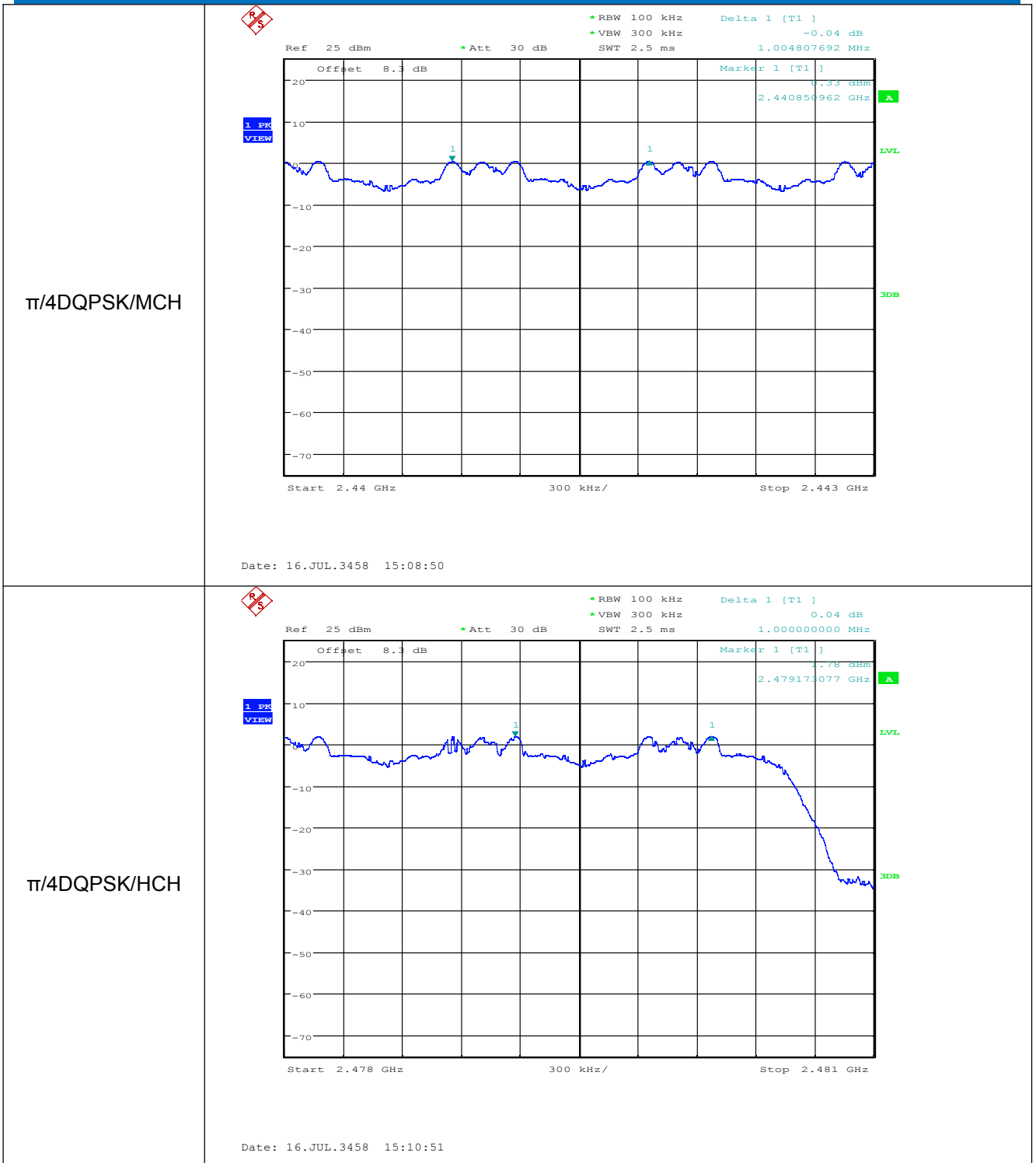

5.6 Hopping Channel Number

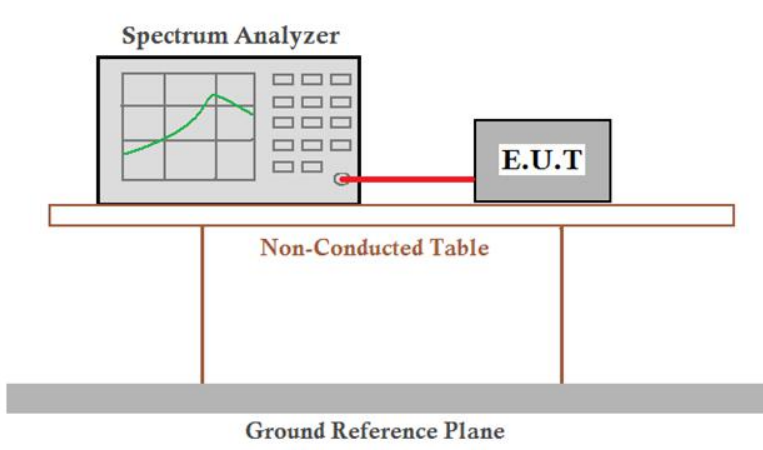
Test Requirement:	47 CFR Part 15C Section 15.247 (a)(1)
Test Method:	ANSI C63.10:2013
Test Setup:	 <p style="text-align: center;"><i>Remark: Offset=Cable loss+ attenuation factor.</i></p>
Limit:	At least 15 channels
Exploratory Test Mode:	hopping transmitting with all kind of modulation and all kind of data type
Final Test Mode:	Through Pre-scan, find the DH5 of data type is the worst case of GFSK modulation type, 2-DH5 of data type is the worst case of $\pi/4$ DQPSK modulation type, 3-DH5 of data type is the worst case of 8DPSK modulation type. Only the worst case is recorded in the report.
Test Results:	Pass

Measurement Data

Mode	Hopping channel numbers	Limit
GFSK	79	≥ 15
$\pi/4$ DQPSK	79	≥ 15
8DPSK	79	≥ 15

Test plot as follows:

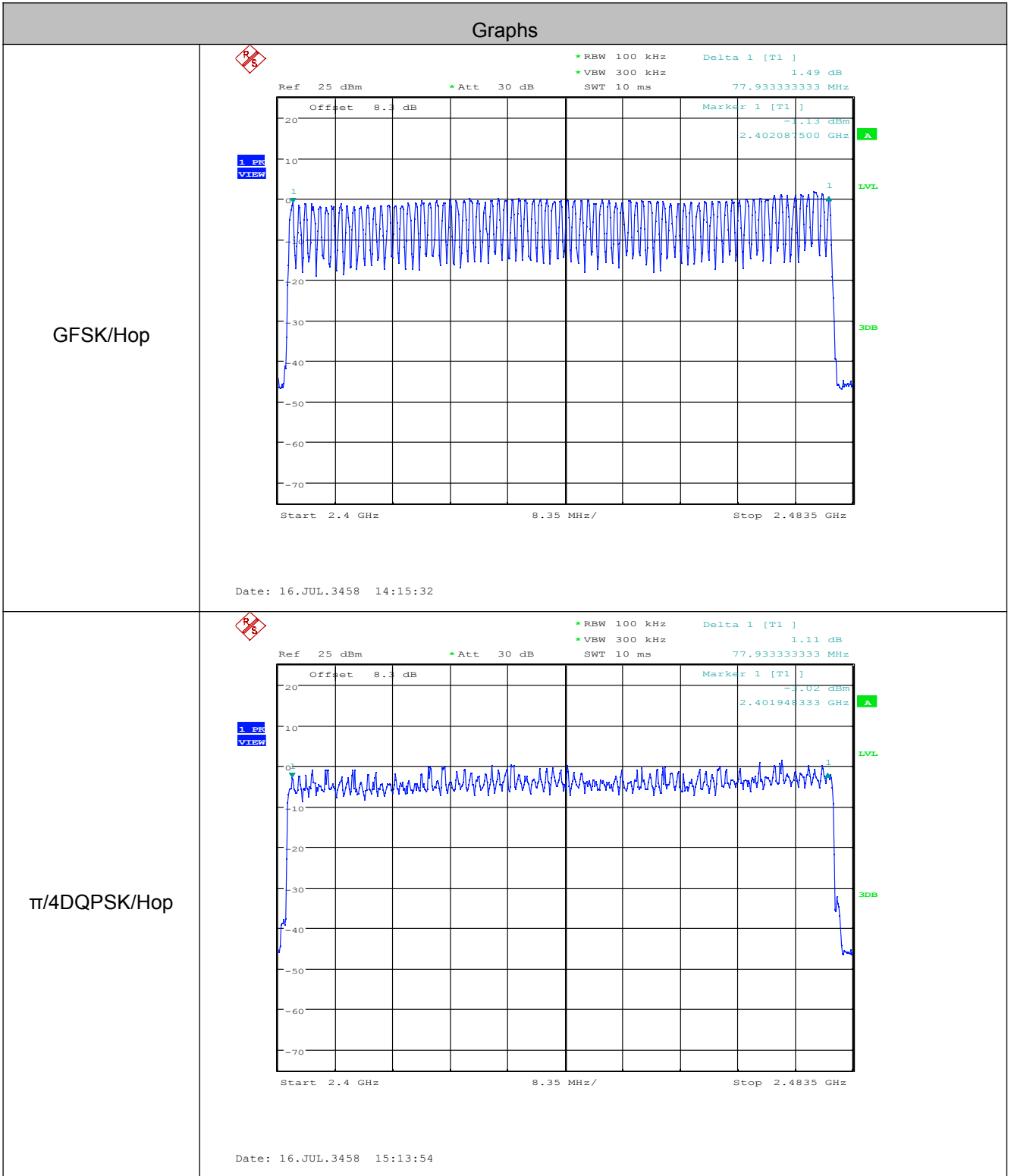

5.7 Dwell Time

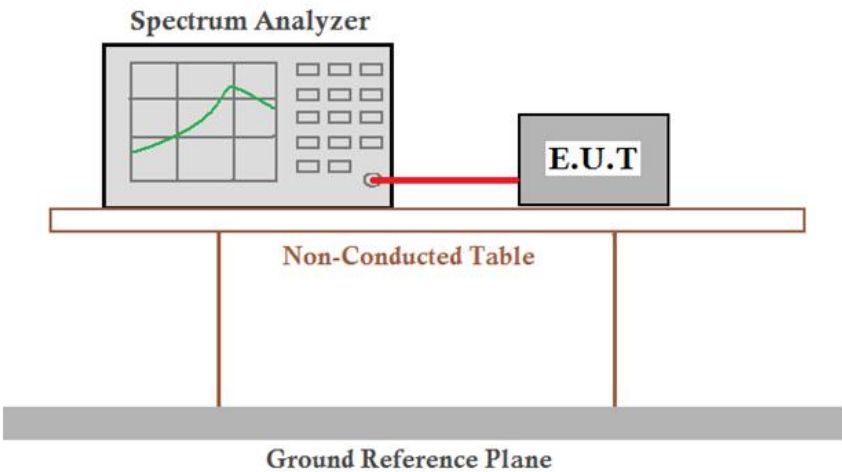
Test Requirement:	47 CFR Part 15C Section 15.247 (a)(1)
Test Method:	ANSI C63.10:2013
Test Setup:	 <p style="text-align: center;"><i>Remark: Offset=Cable loss+ attenuation factor.</i></p>
Test Mode:	Hopping transmitting with all kind of modulation and all kind of data type.
Limit:	0.4 Second
Test Results:	Pass

Measurement Data

Mode	Packet	Channel	Burst Width [ms/hop/ch]	Dwell Time[s]	Limit (second)
GFSK	DH1	LCH	0.38	0.122	≤0.4
GFSK	DH1	MCH	0.38	0.122	≤0.4
GFSK	DH1	HCH	0.38	0.122	≤0.4
π/4DQPSK	2DH1	LCH	0.39	0.125	≤0.4
π/4DQPSK	2DH1	MCH	0.39	0.125	≤0.4
π/4DQPSK	2DH1	HCH	0.39	0.125	≤0.4
GFSK	DH3	LCH	1.63	0.261	≤0.4
GFSK	DH3	MCH	1.63	0.261	≤0.4
GFSK	DH3	HCH	1.63	0.261	≤0.4
π/4DQPSK	2DH3	LCH	1.64	0.262	≤0.4
π/4DQPSK	2DH3	MCH	1.64	0.262	≤0.4
π/4DQPSK	2DH3	HCH	1.64	0.262	≤0.4
GFSK	DH5	LCH	2.88	0.307	≤0.4
GFSK	DH5	MCH	2.88	0.307	≤0.4
GFSK	DH5	HCH	2.88	0.307	≤0.4
π/4DQPSK	2DH5	LCH	2.88	0.307	≤0.4
π/4DQPSK	2DH5	MCH	2.88	0.307	≤0.4
π/4DQPSK	2DH5	HCH	2.88	0.307	≤0.4

Remark:

The test period: $T = 0.4 \text{ Second/Channel} \times 79 \text{ Channel} = 31.6 \text{ s}$

DH1/2DH1/3DH1 Dwell time = Burst Width(ms)*(1600/ (2*79))*31.6

DH3/2DH3/3DH3 Dwell time = Burst Width (ms)*(1600/ (4*79))*31.6

DH5/2DH5/3DH5 Dwell time = Burst Width (ms)*(1600/ (6*79))*31.6

Test plot as follows:

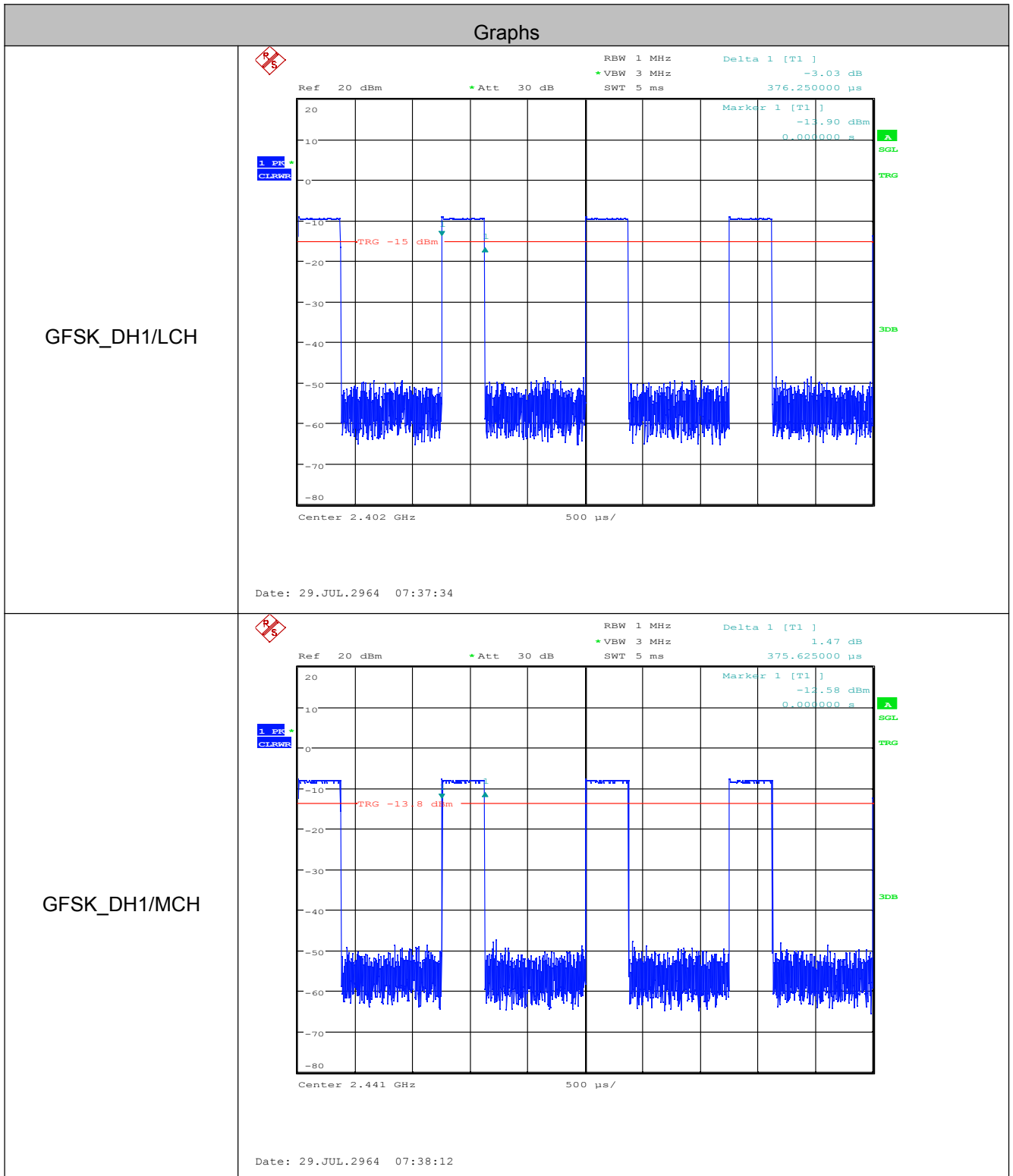

GFSK_DH1/HCH

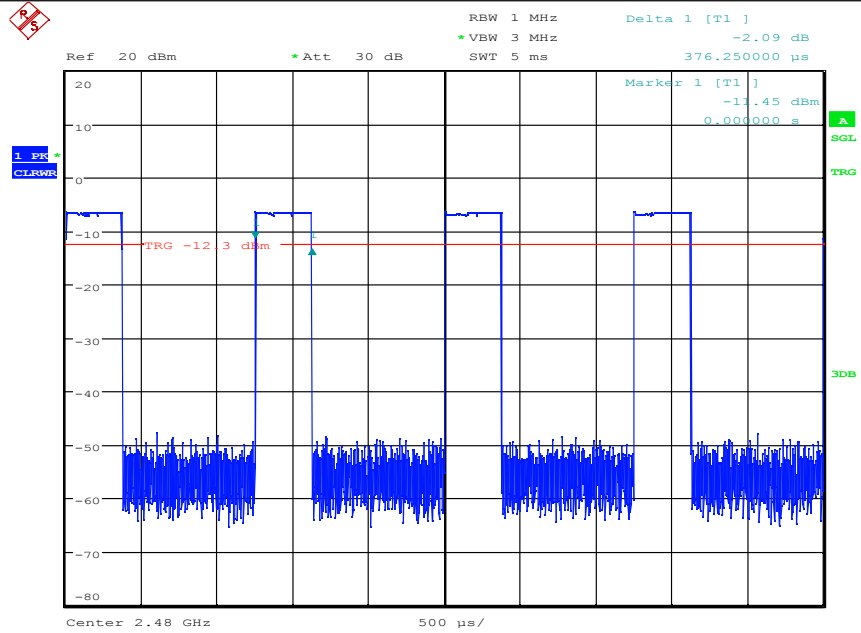

Date: 29.JUL.2964 07:38:45

π /4DQPSK
_2DH1/LCH

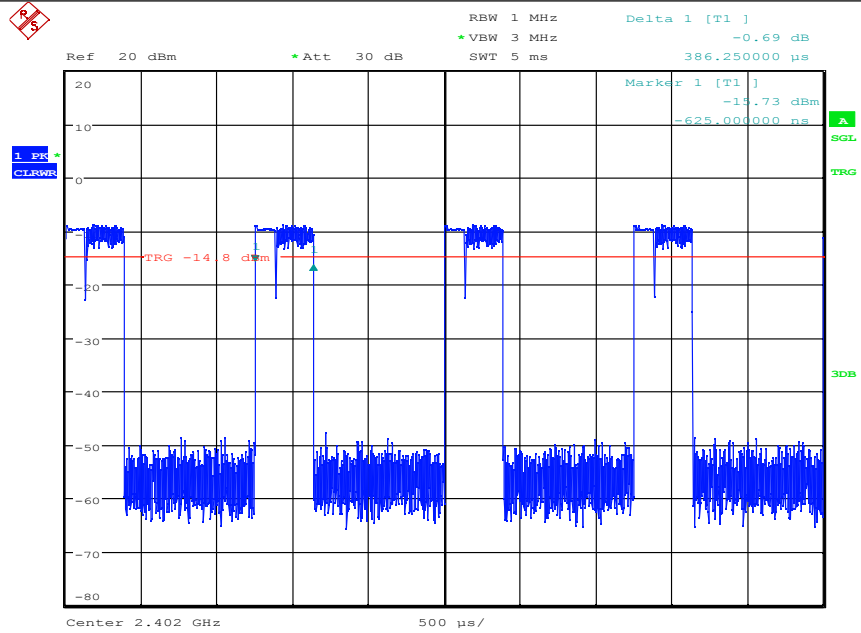

Date: 29.JUL.2964 07:43:33

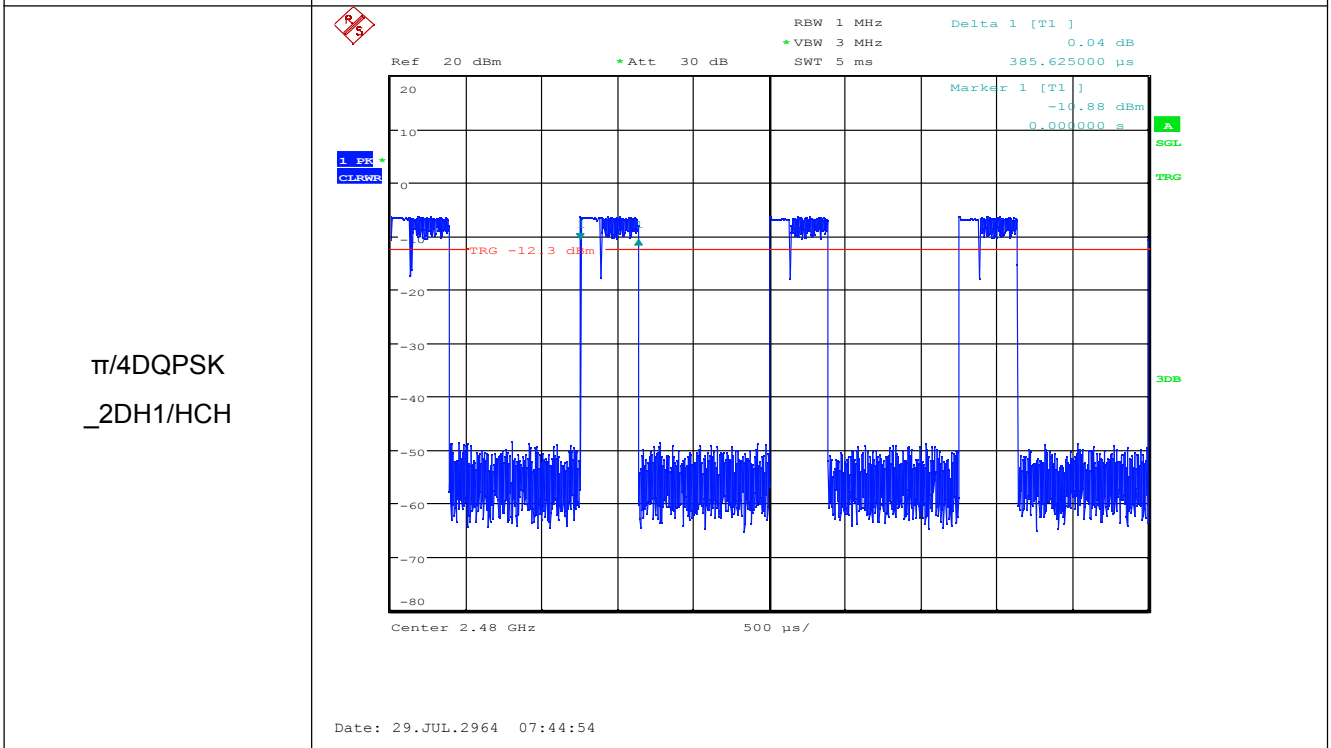
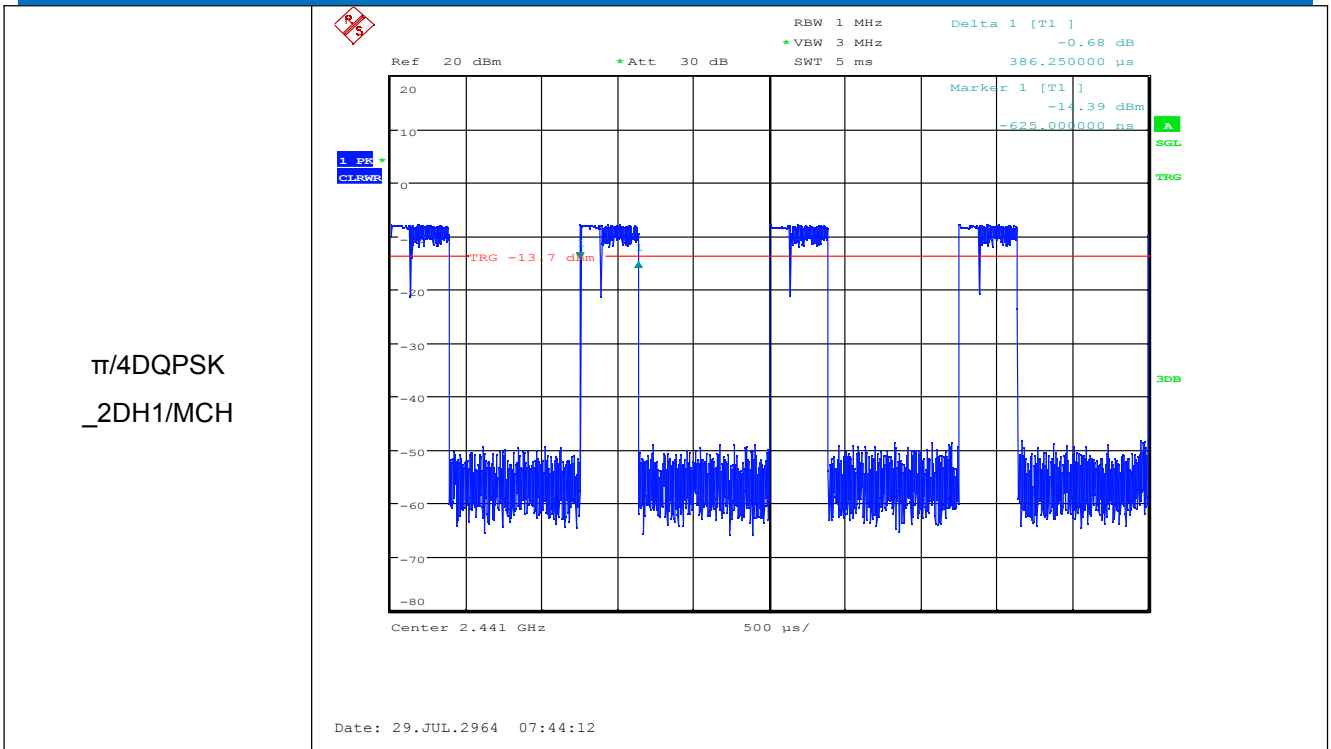

GFSK_DH3/LCH

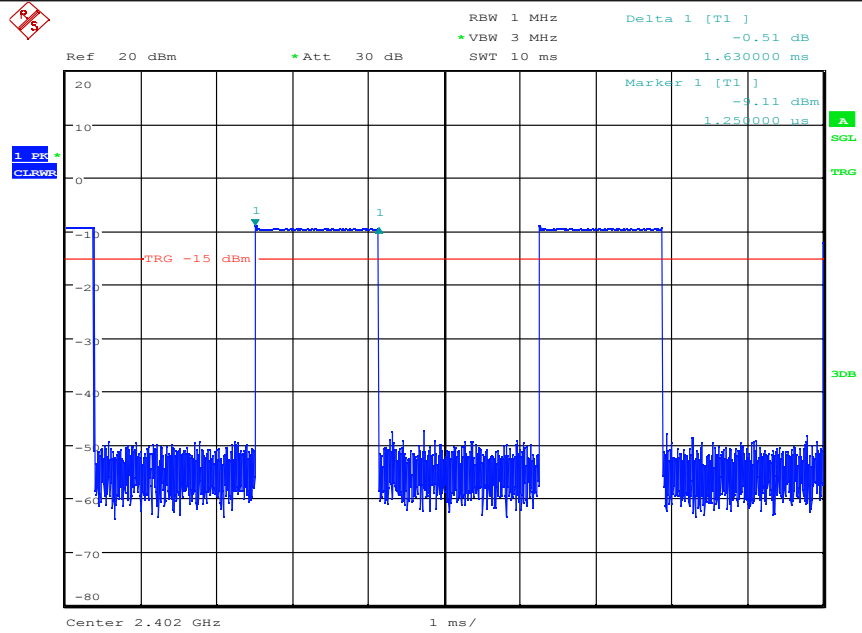

Date: 29.JUL.2964 07:39:21

GFSK_DH3/MCH

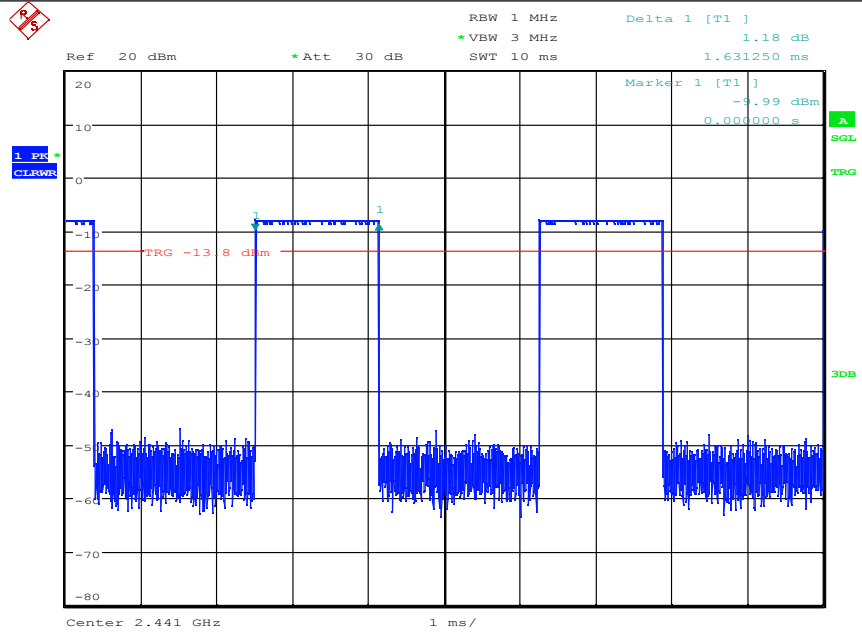

Date: 29.JUL.2964 07:39:55

GFSK_DH3/HCH

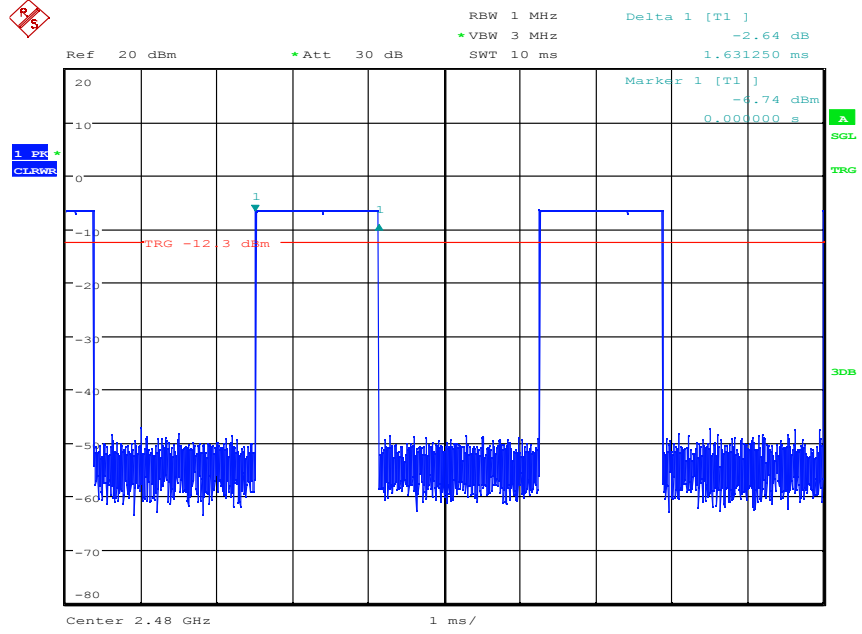

Date: 29.JUL.2964 07:40:30

$\pi/4$ DQPSK
_2DH3/LCH

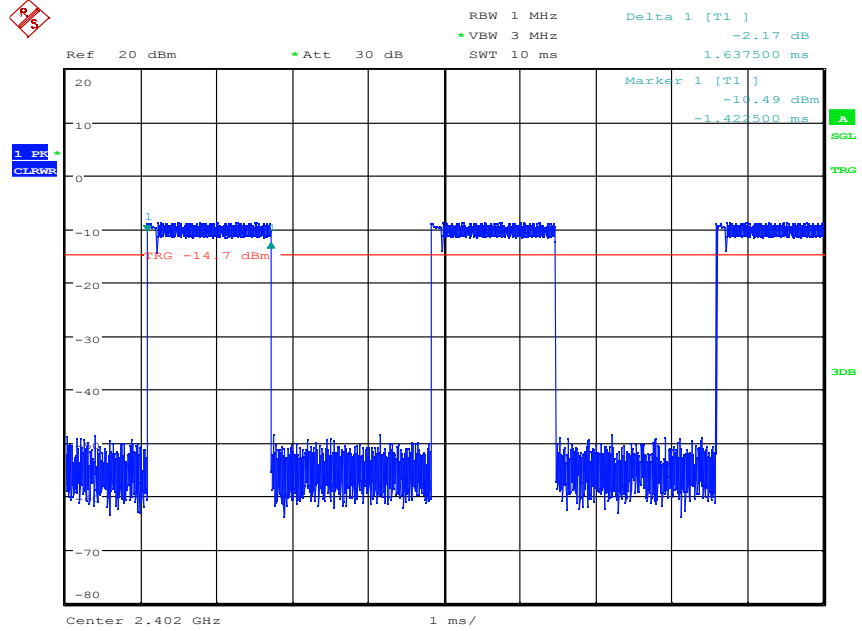

Date: 29.JUL.2964 07:45:53

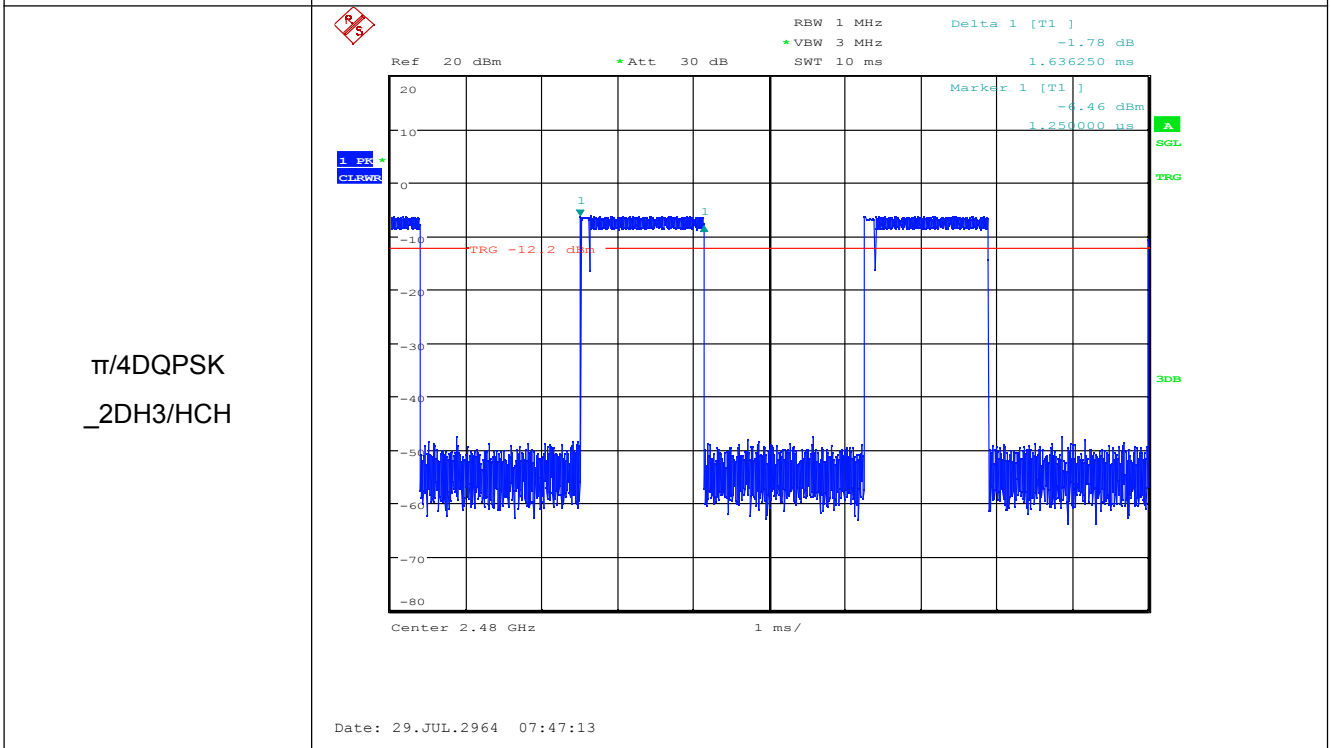
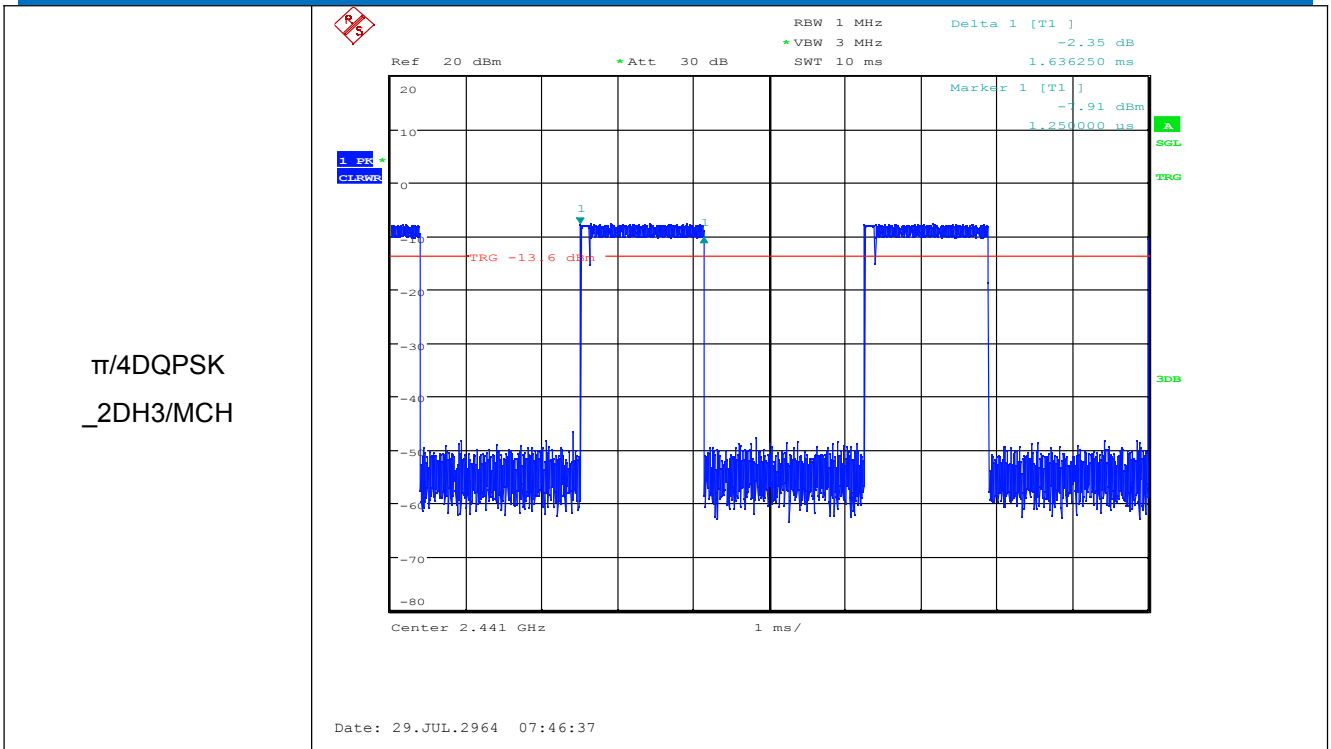

GFSK_DH5/LCH

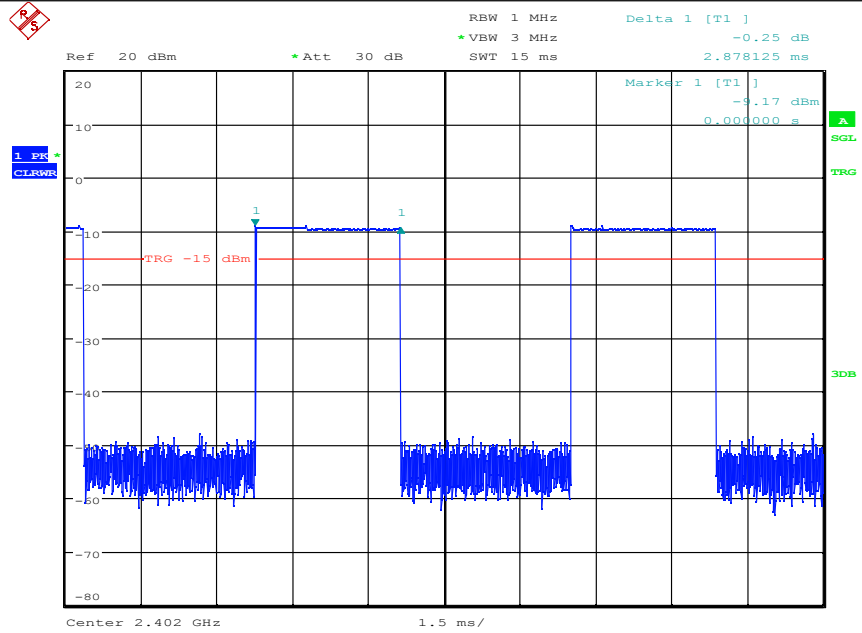

Date: 29.JUL.2964 07:41:21

GFSK_DH5/MCH

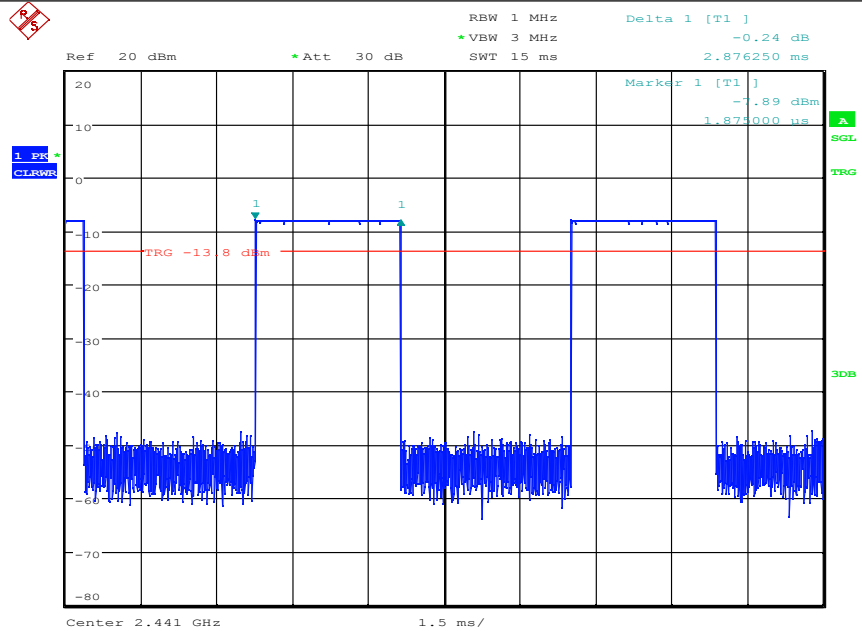

Date: 29.JUL.2964 07:42:00

GFSK_DH5/HCH

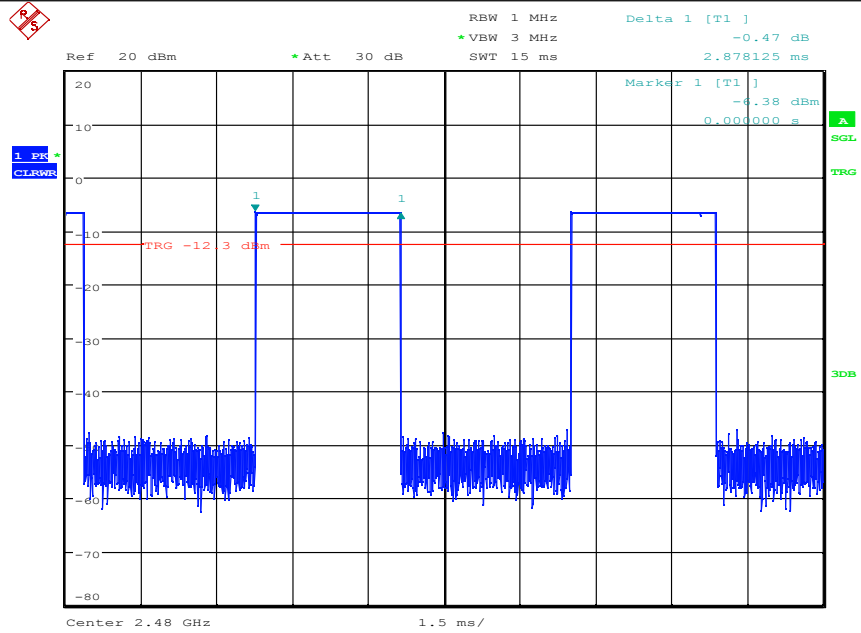

Date: 29.JUL.2964 07:42:46

$\pi/4$ DQPSK
_2DH5/LCH

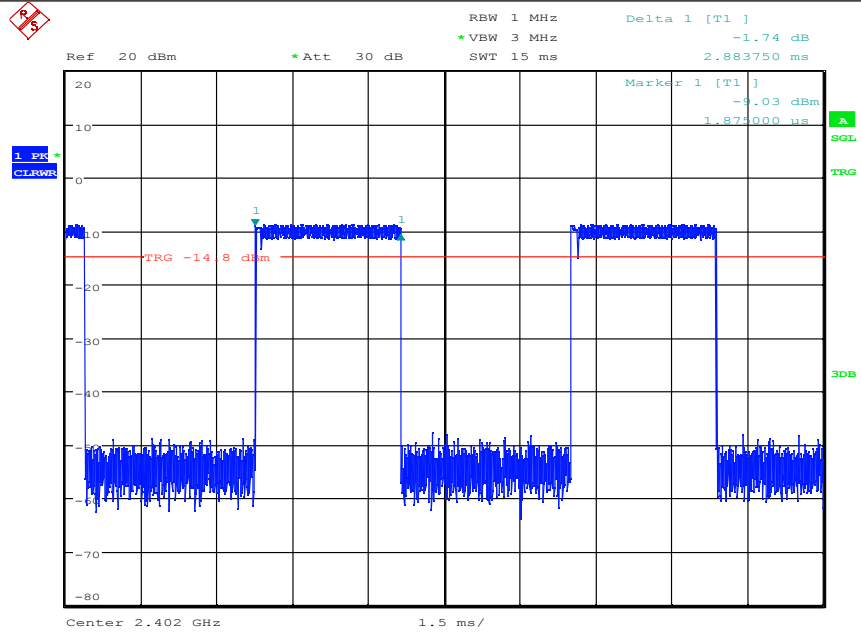

Date: 29.JUL.2964 07:47:55

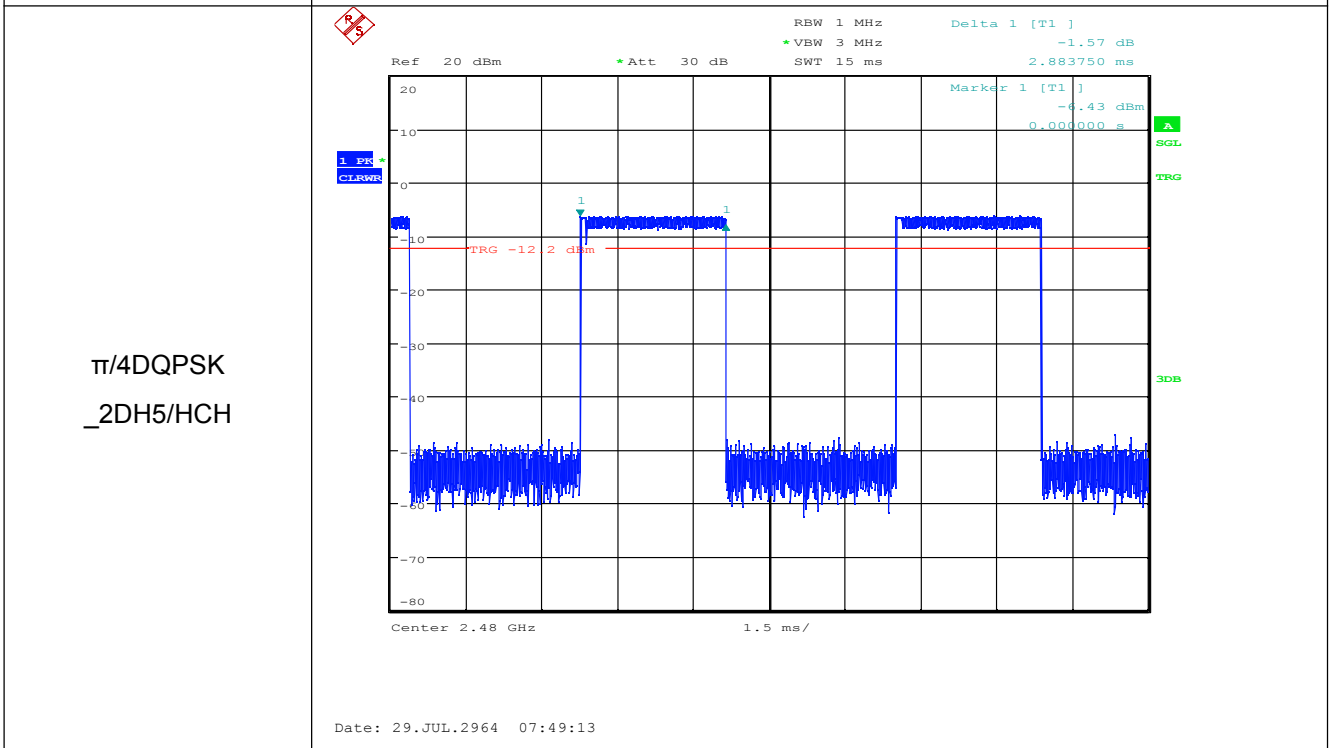
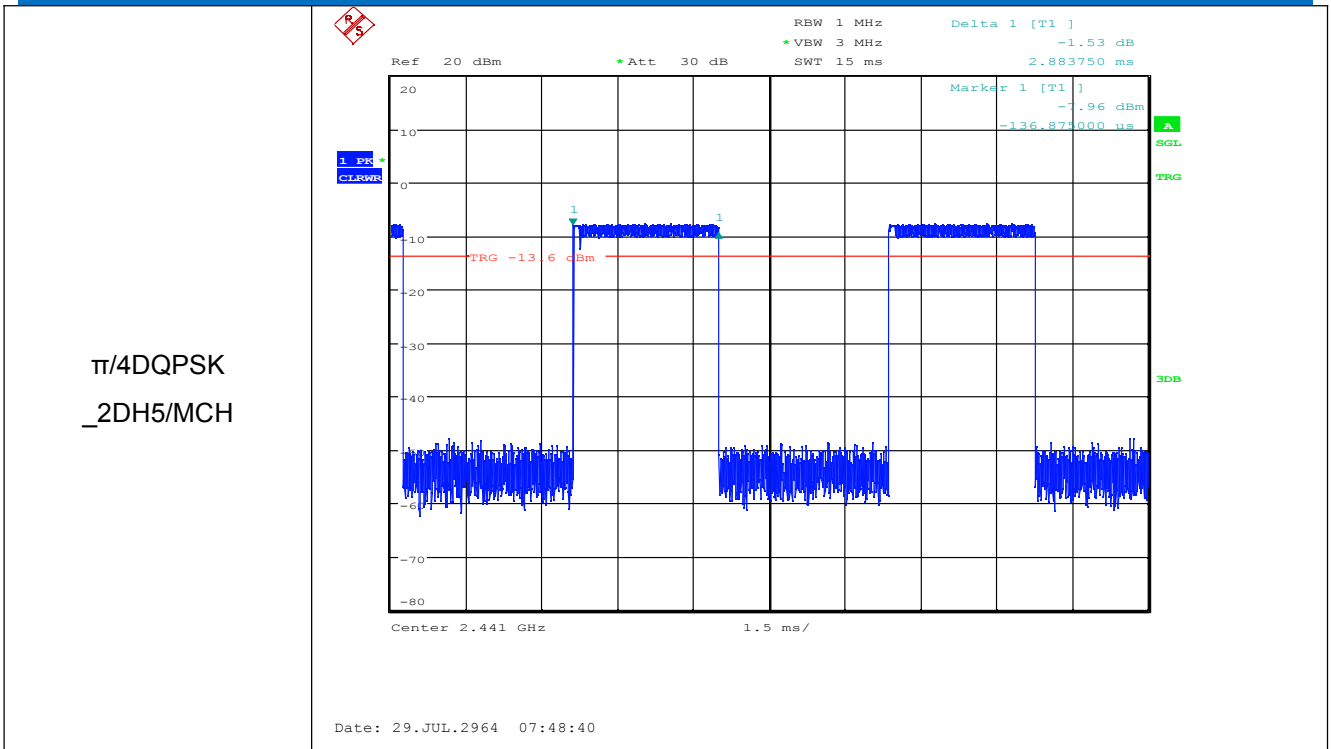

5.8 Band-edge for RF Conducted Emissions

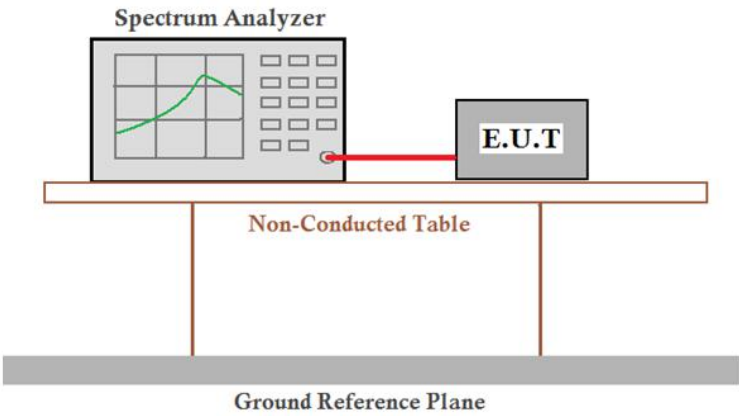
Test Requirement:	47 CFR Part 15C Section 15.247 (d)
Test Method:	ANSI C63.10:2013
Test Setup:	 <p style="text-align: center;"><i>Remark: Offset=cable loss+ attenuation factor.</i></p>
Limit:	In any 100 kHz bandwidth outside the frequency band in which the spread spectrum intentional radiator is operating, the radio frequency power that is produced by the intentional radiator shall be at least 20 dB below that in the 100 kHz bandwidth within the band that contains the highest level of the desired power, based on either an RF conducted or a radiated measurement.
Exploratory Test Mode:	Hopping and Non-hopping transmitting with all kind of modulation and all kind of data type
Final Test Mode:	Through Pre-scan, find the DH5 of data type is the worst case of GFSK modulation type, 2-DH5 of data type is the worst case of $\pi/4$ DQPSK modulation type, 3-DH5 of data type is the worst case of 8DPSK modulation type. Only the worst case is recorded in the report.
Test Results:	Pass

Mode	Test Channel	Frequency [MHz]	Frequency Hopping	Emission Level [dBm]	Limit [dBm]	Result
GFSK	LCH	2400	Off	-45.950	-20.79	PASS
			On	-43.410	-19.66	PASS
GFSK	HCH	2483.5	Off	-50.220	-18.65	PASS
			On	-47.020	-18.68	PASS
$\pi/4$ DQPSK	LCH	2400	Off	-45.030	-20.97	PASS
			On	-45.470	-19.46	PASS
$\pi/4$ DQPSK	HCH	2483.5	Off	-49.510	-18.31	PASS
			On	-45.190	-18.3	PASS

Test plot as follows:

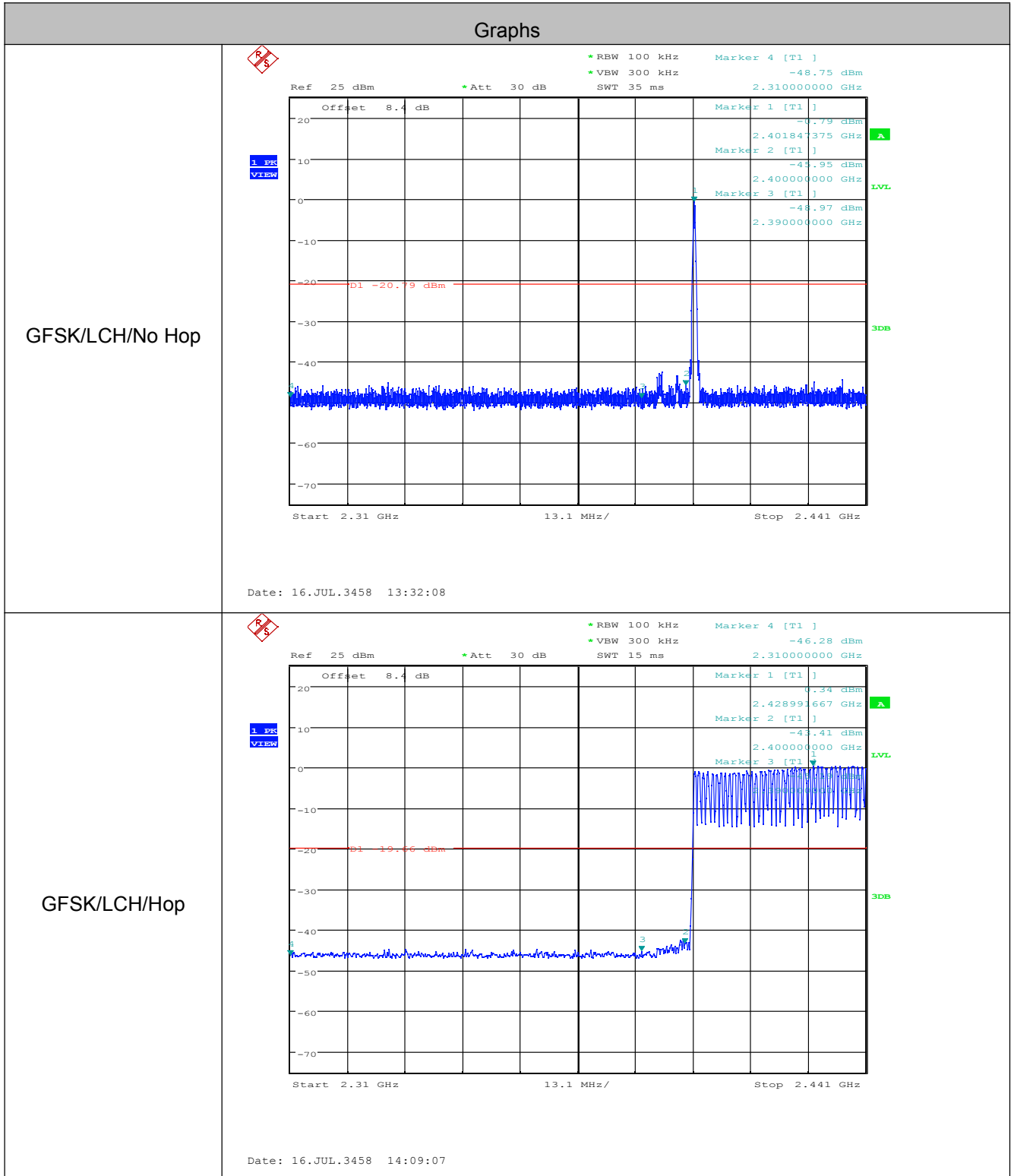

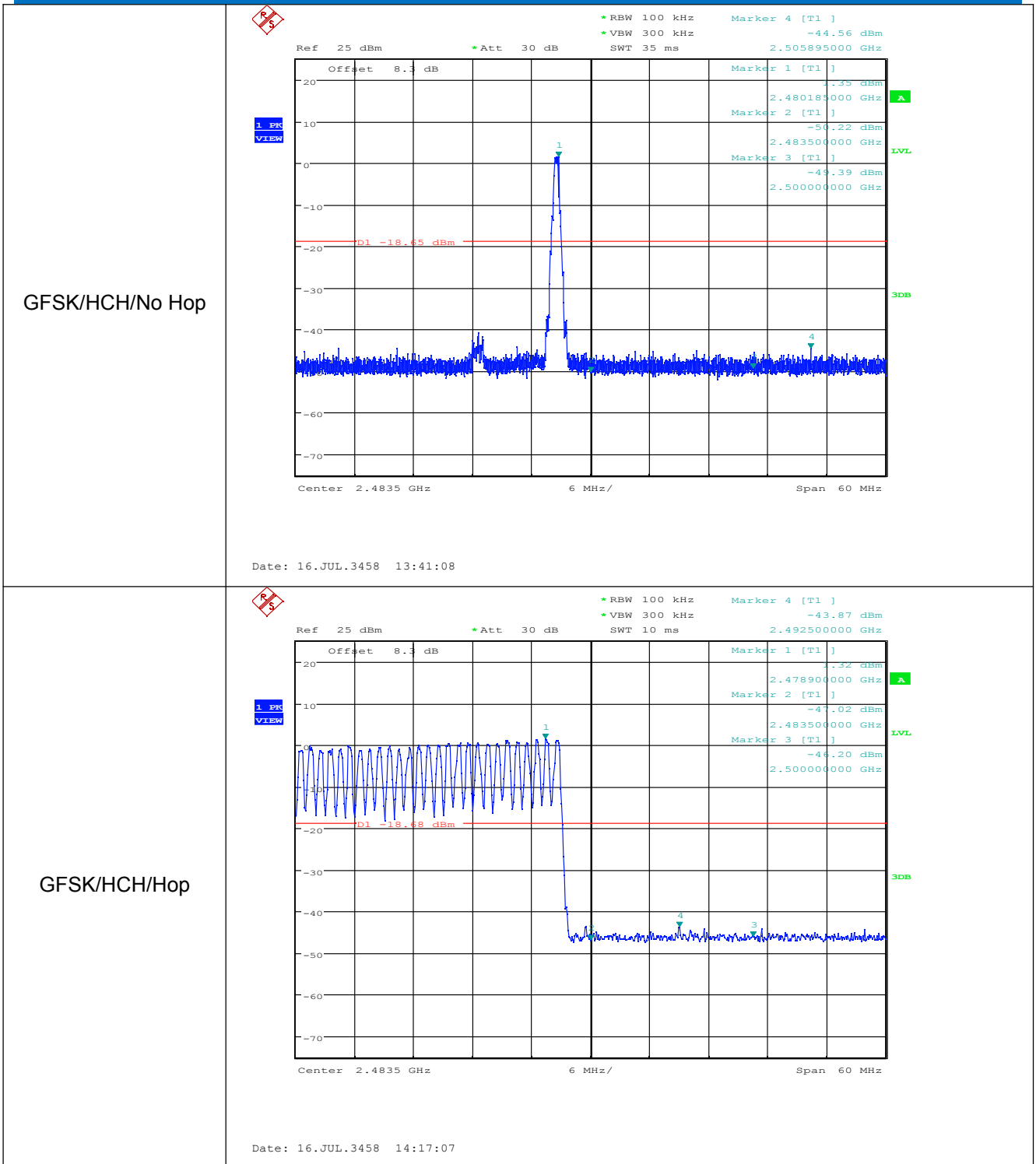

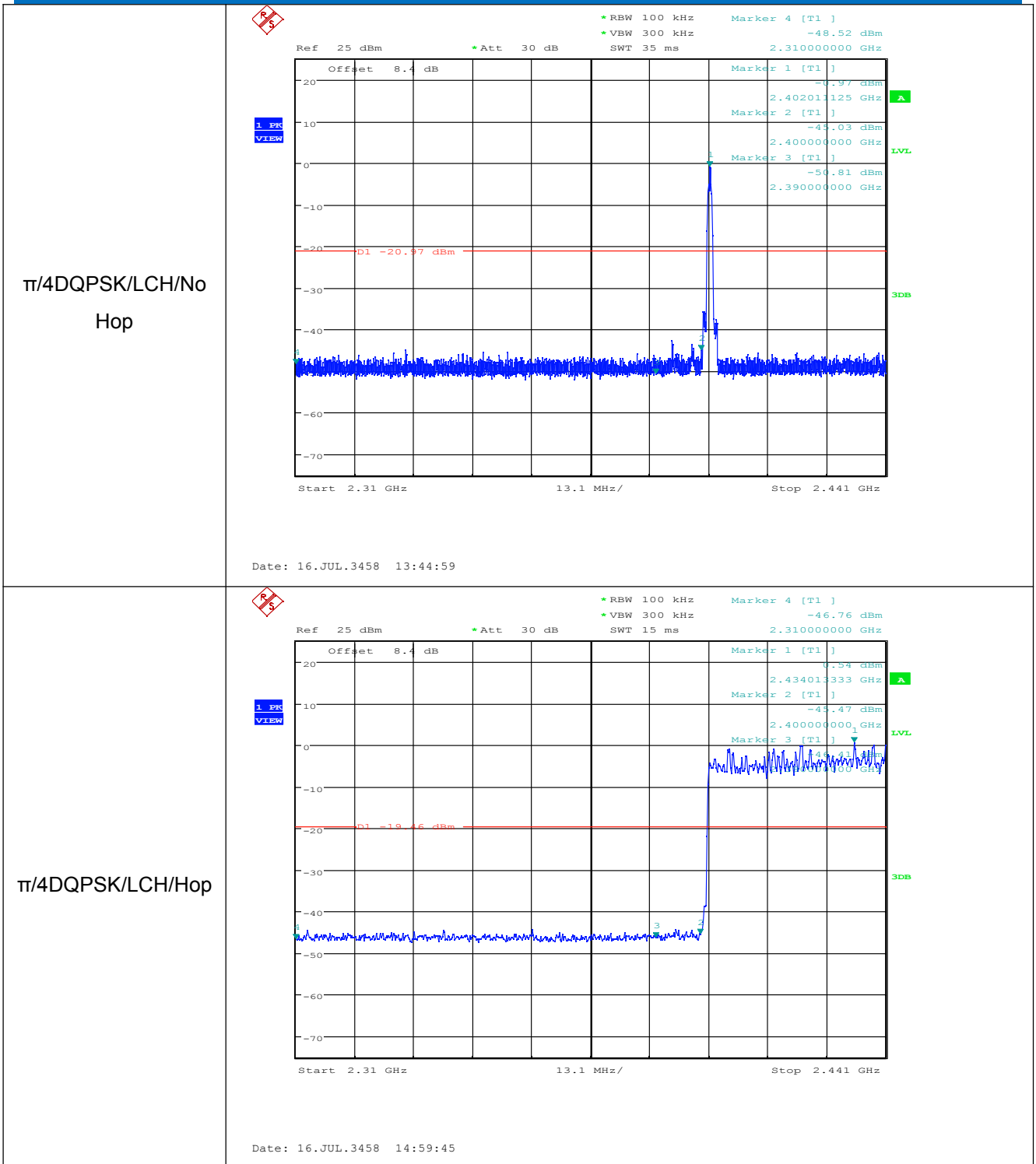

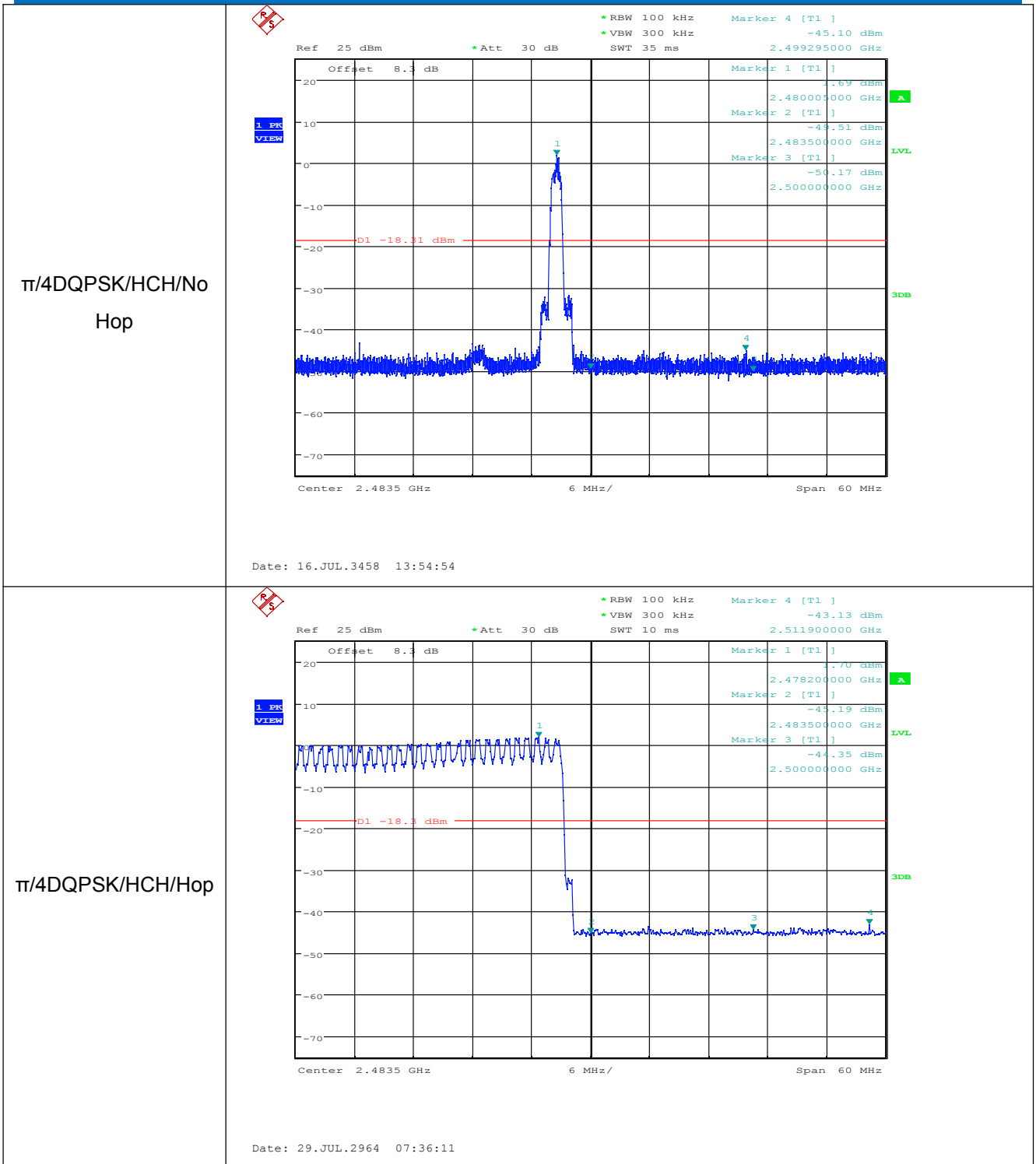

5.9 Spurious RF Conducted Emissions

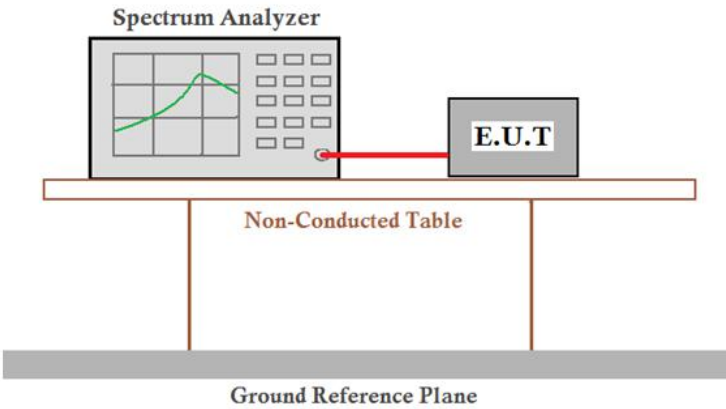
Test Requirement:	47 CFR Part 15C Section 15.247 (d)
Test Method:	ANSI C63.10:2013
Test Setup:	 <p style="text-align: center;"><i>Remark: Offset=cable loss+ attenuation factor.</i></p>
Limit:	In any 100 kHz bandwidth outside the frequency band in which the spread spectrum intentional radiator is operating, the radio frequency power that is produced by the intentional radiator shall be at least 20 dB below that in the 100 kHz bandwidth within the band that contains the highest level of the desired power, based on either an RF conducted or a radiated measurement.
Exploratory Test Mode:	Non-hopping transmitting with all kind of modulation and all kind of data type
Final Test Mode:	Through Pre-scan, find the DH5 of data type is the worst case of GFSK modulation type, 2-DH5 of data type is the worst case of $\pi/4$ DQPSK modulation type, 3-DH5 of data type is the worst case of 8DPSK modulation type.
Test Results:	Pass

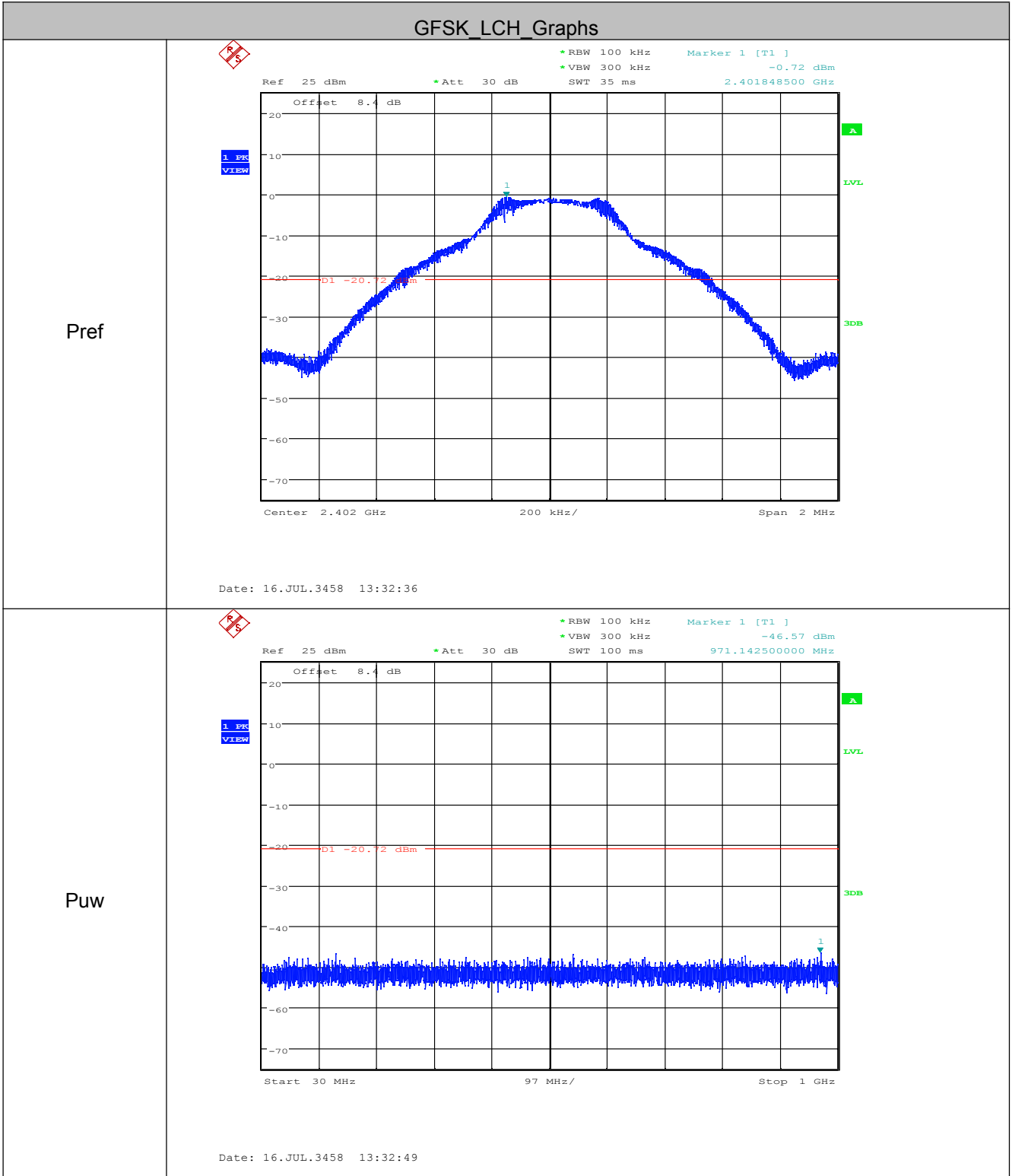

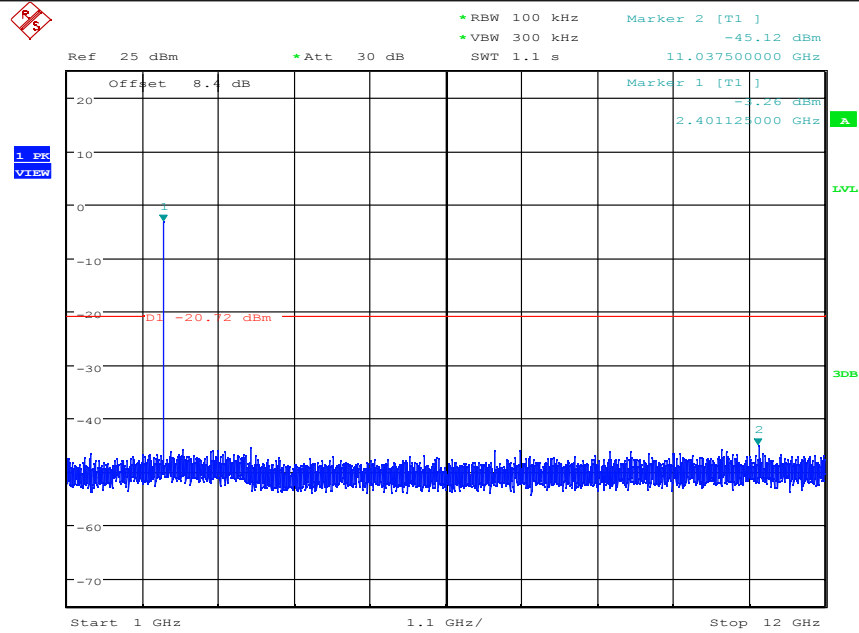

Date: 16.JUL.3458 13:33:00

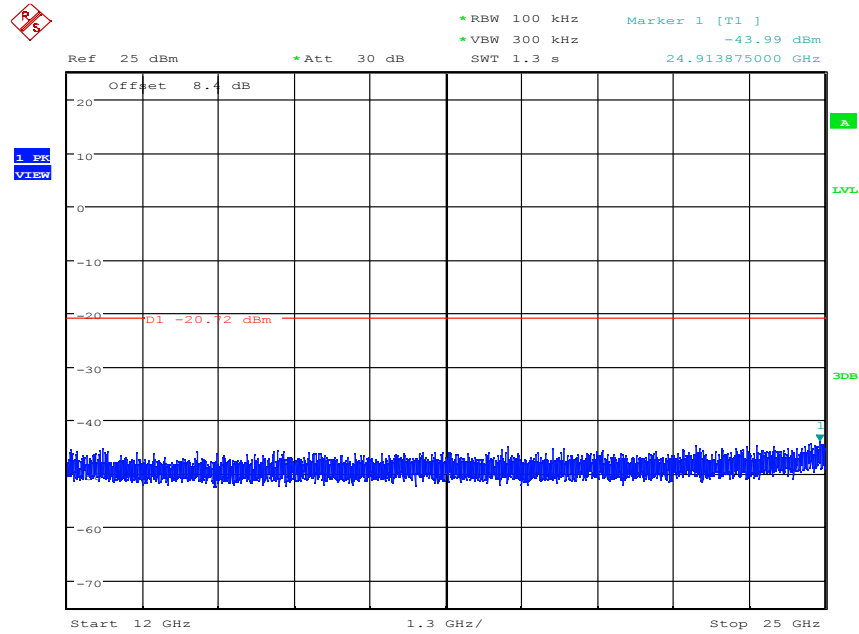

Date: 16.JUL.3458 13:33:13

GFSK_MCH_Graphs

Pref

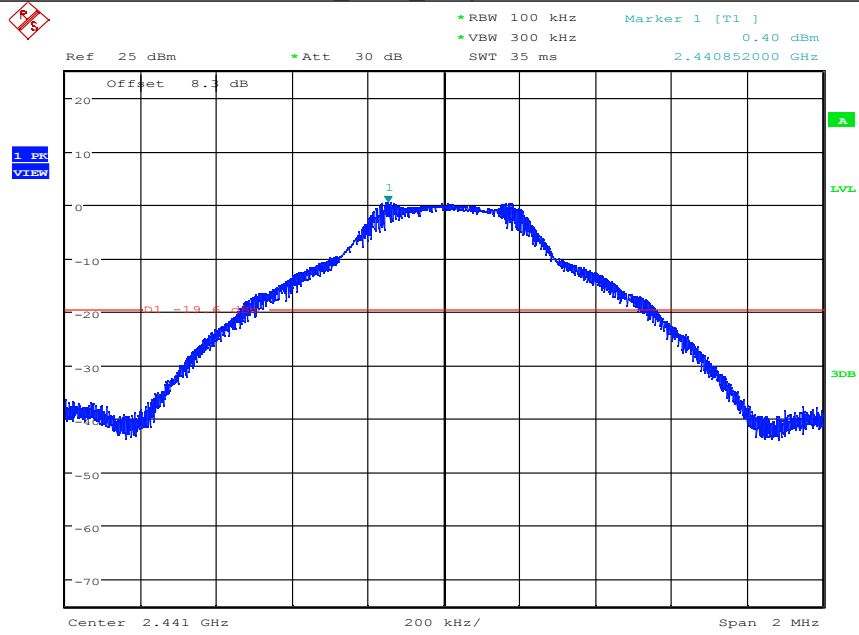

Date: 16.JUL.3458 13:37:46

Puw

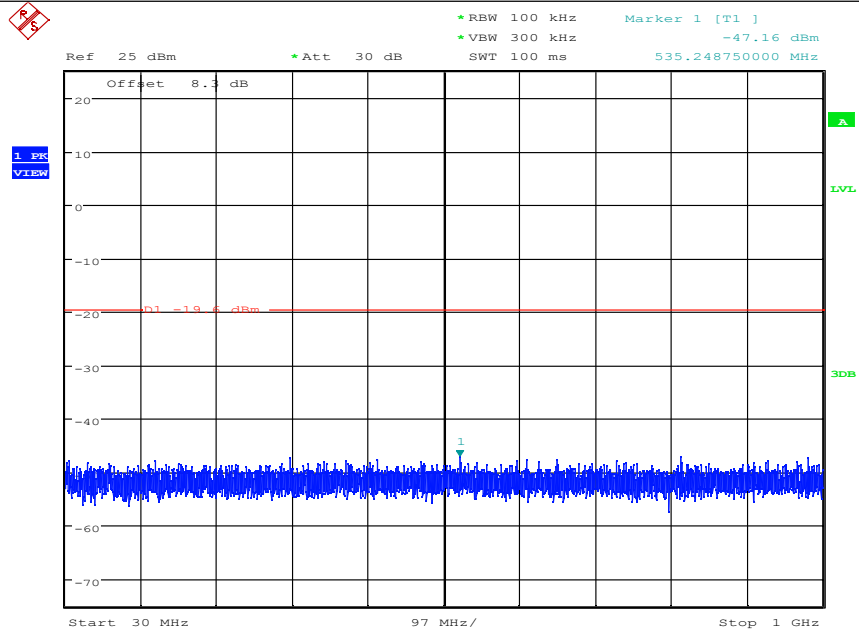

Date: 16.JUL.3458 13:38:00

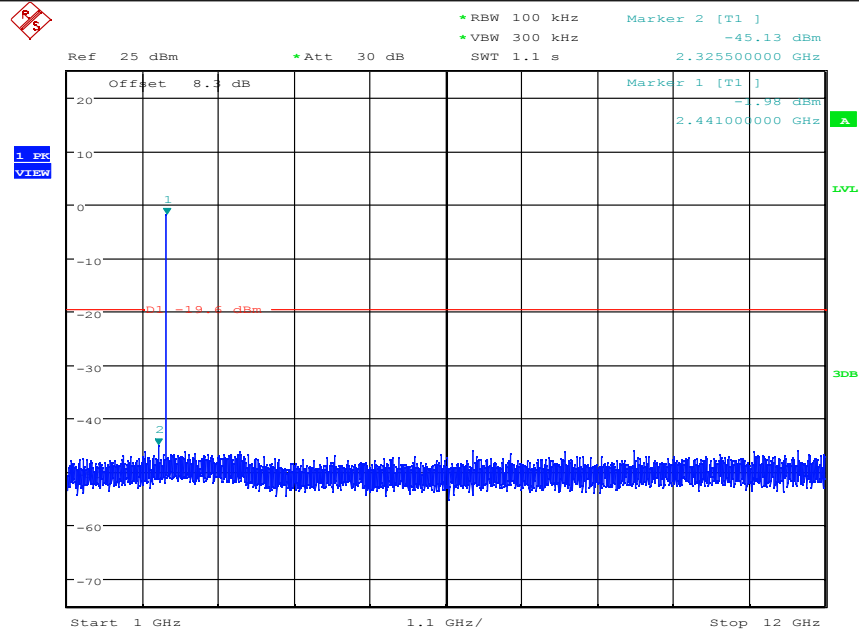

Date: 16.JUL.3458 13:38:11

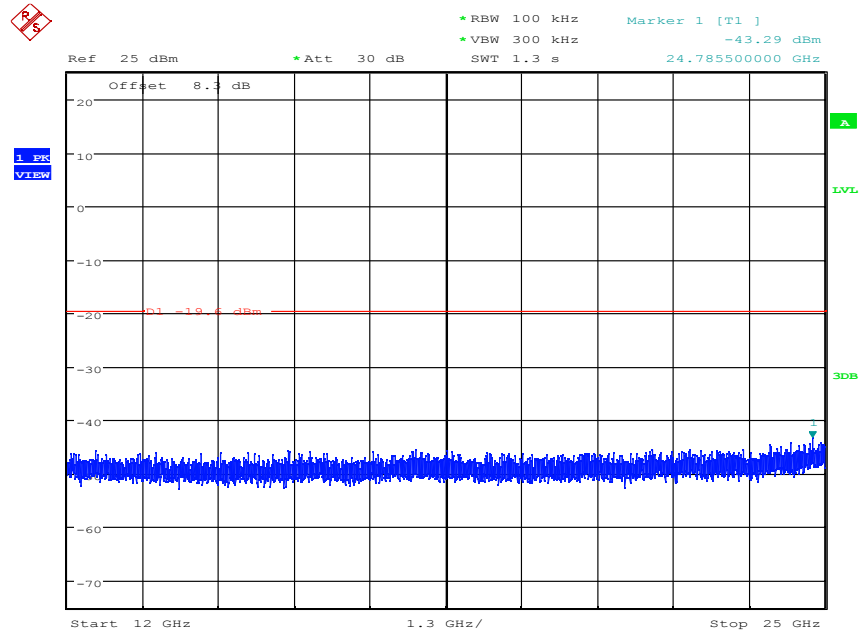

Date: 16.JUL.3458 13:38:23

GFSK_HCH_Graphs

Pref

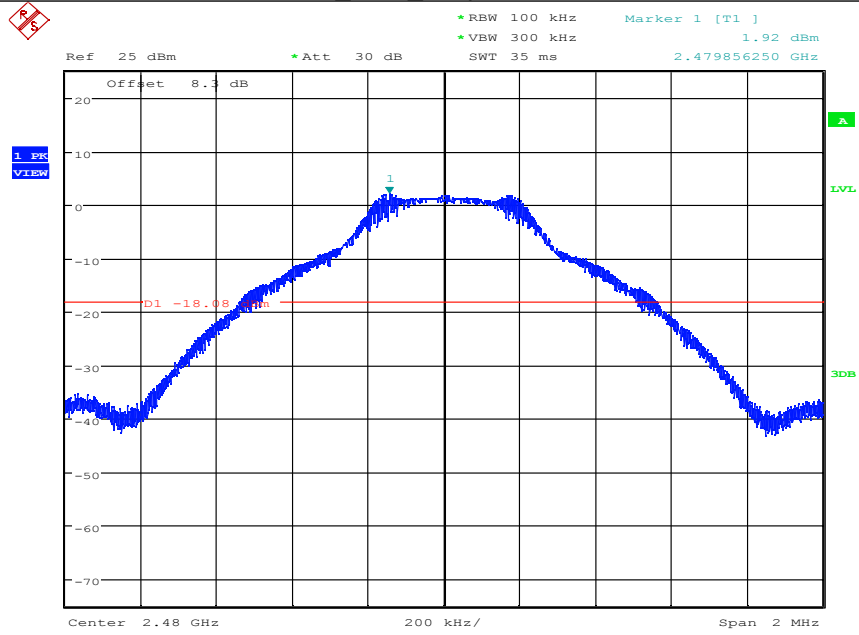

Date: 16.JUL.3458 13:41:36

Puw

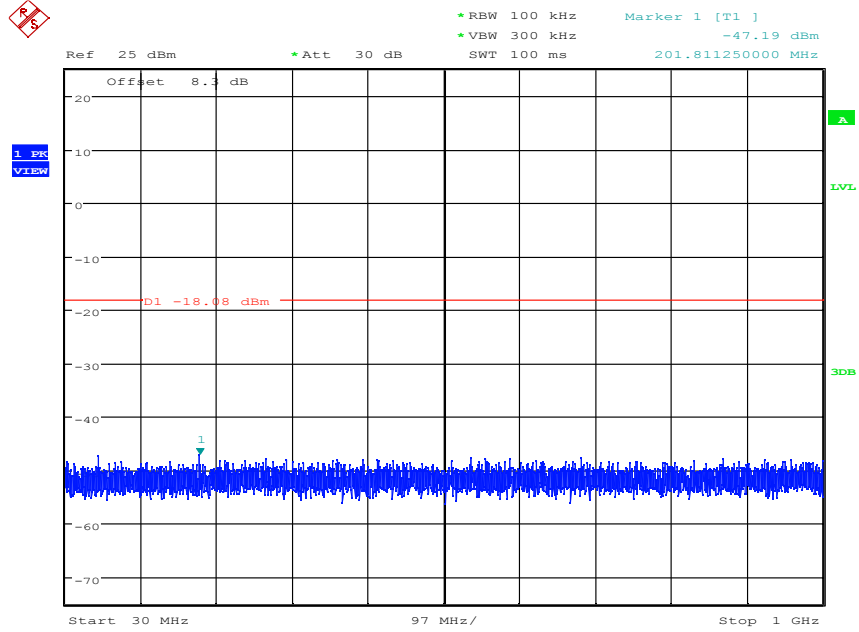

Date: 16.JUL.3458 13:41:49

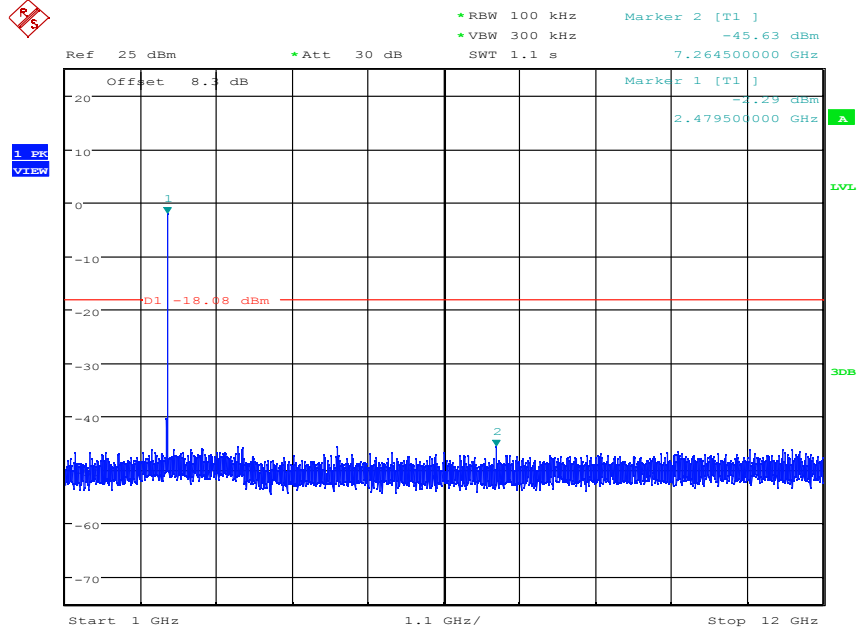

Date: 16.JUL.3458 13:42:00

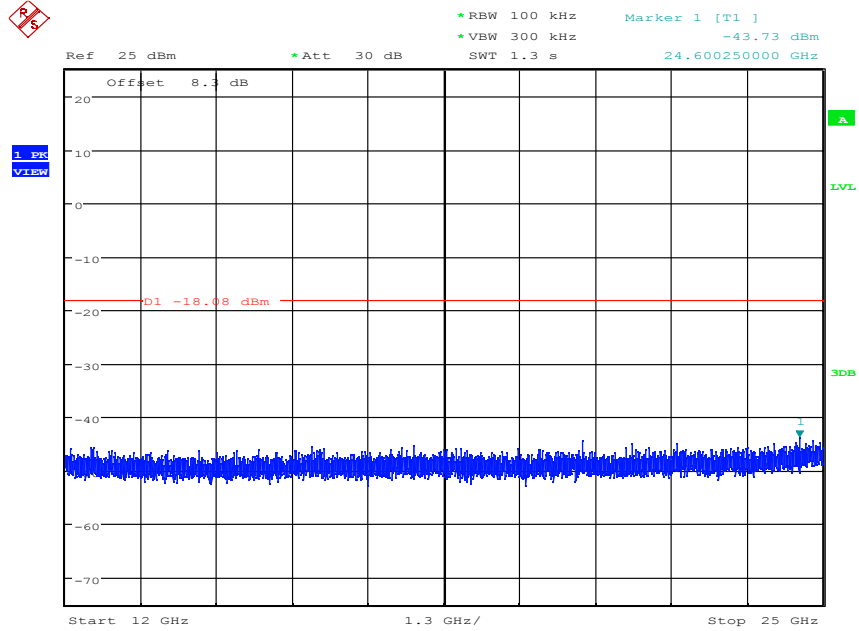

Date: 16.JUL.3458 13:42:13

$\pi/4$ DQPSK LCH_Graphs

Pref

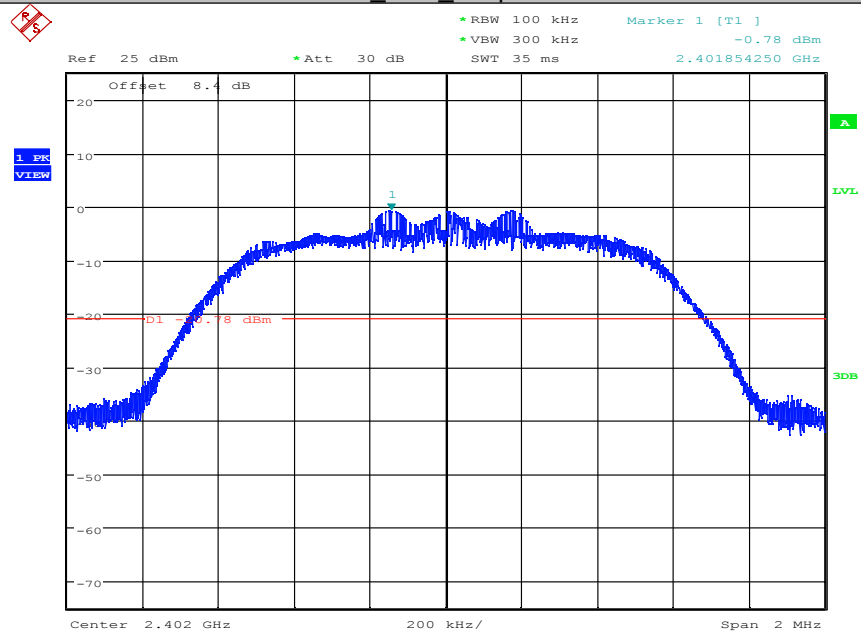

Date: 16.JUL.3458 13:45:27

Puw

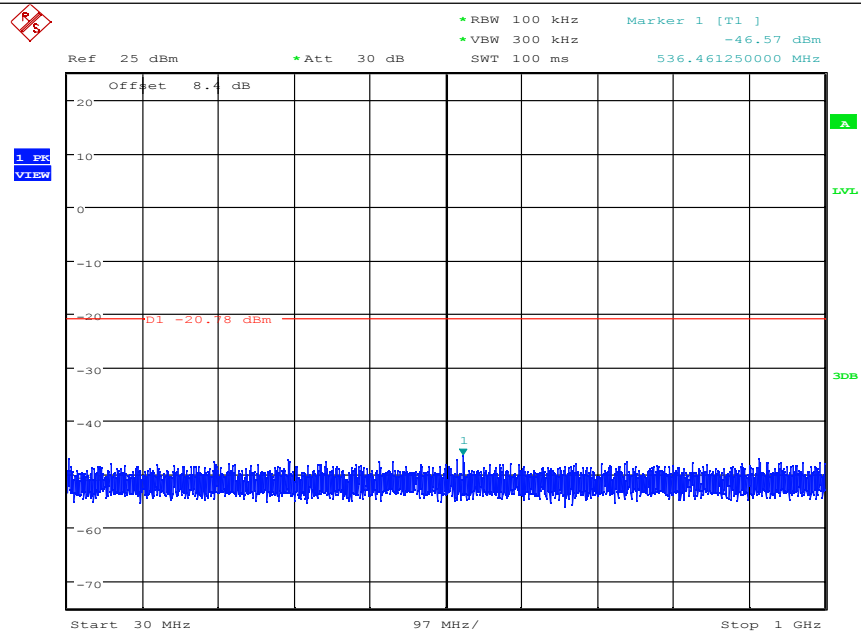

Date: 16.JUL.3458 13:45:40

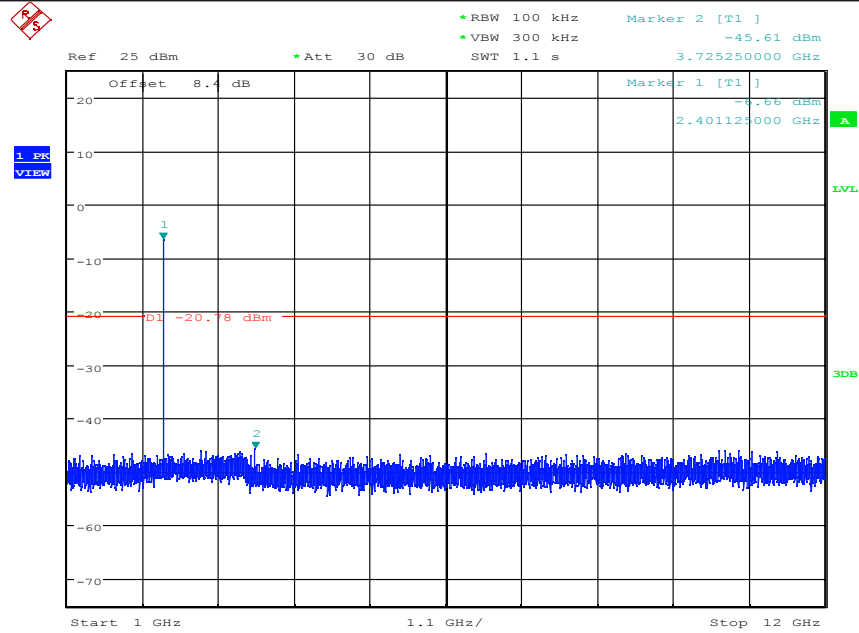

Date: 16.JUL.3458 13:45:52

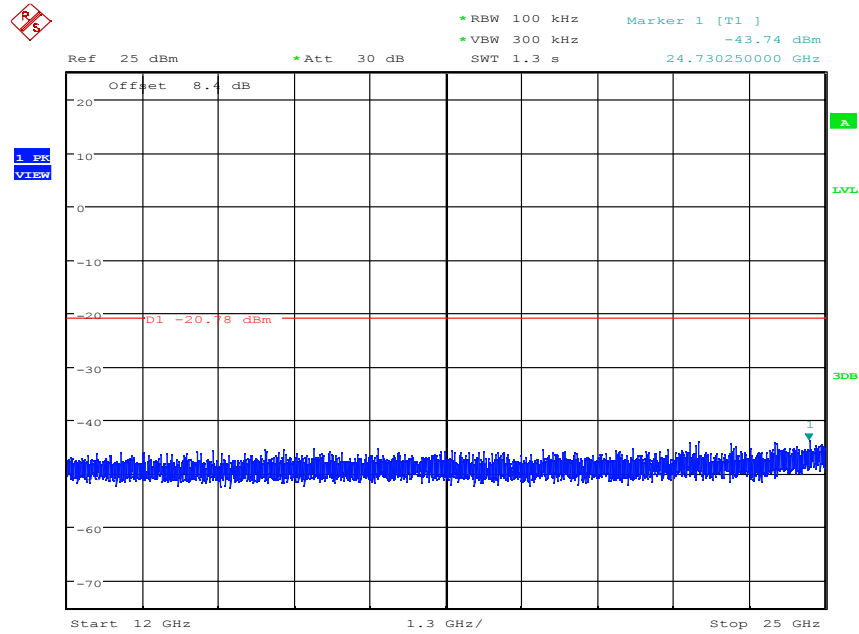

Date: 16.JUL.3458 13:46:05

$\pi/4$ DQPSK_MCH_Graphs

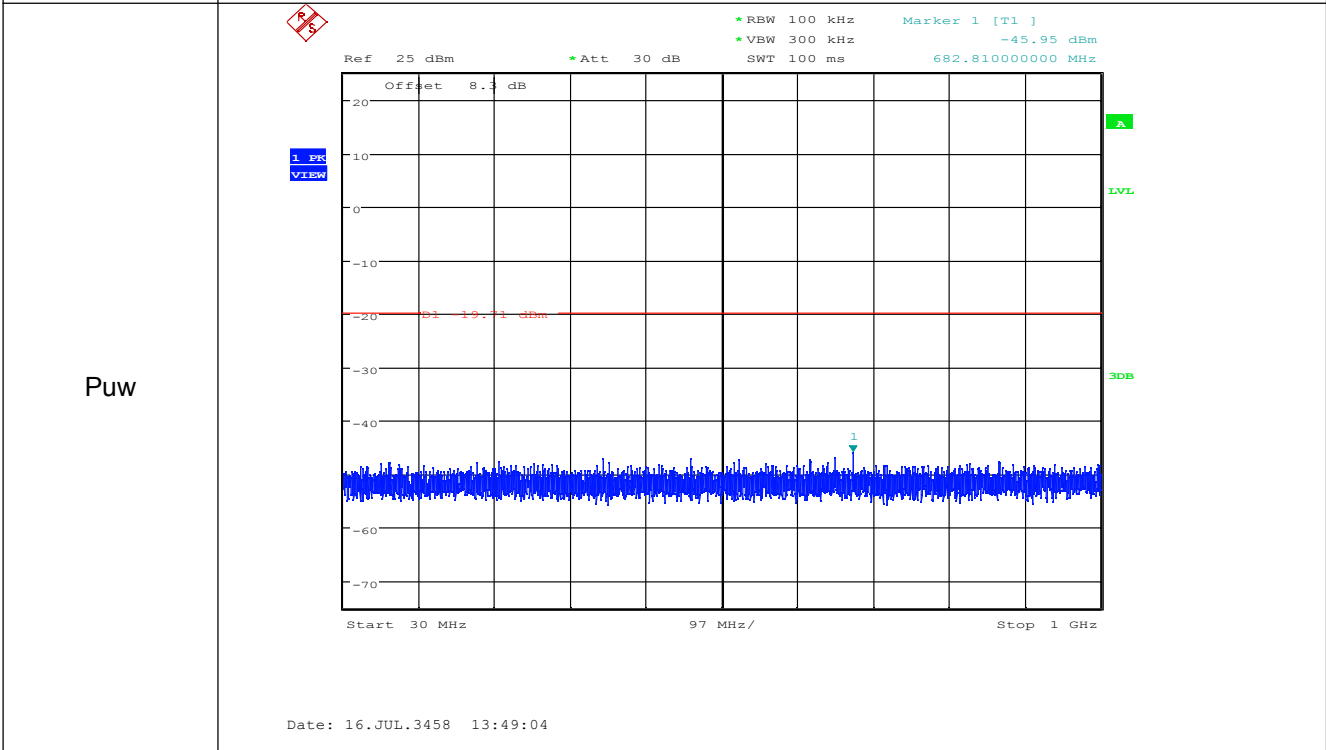
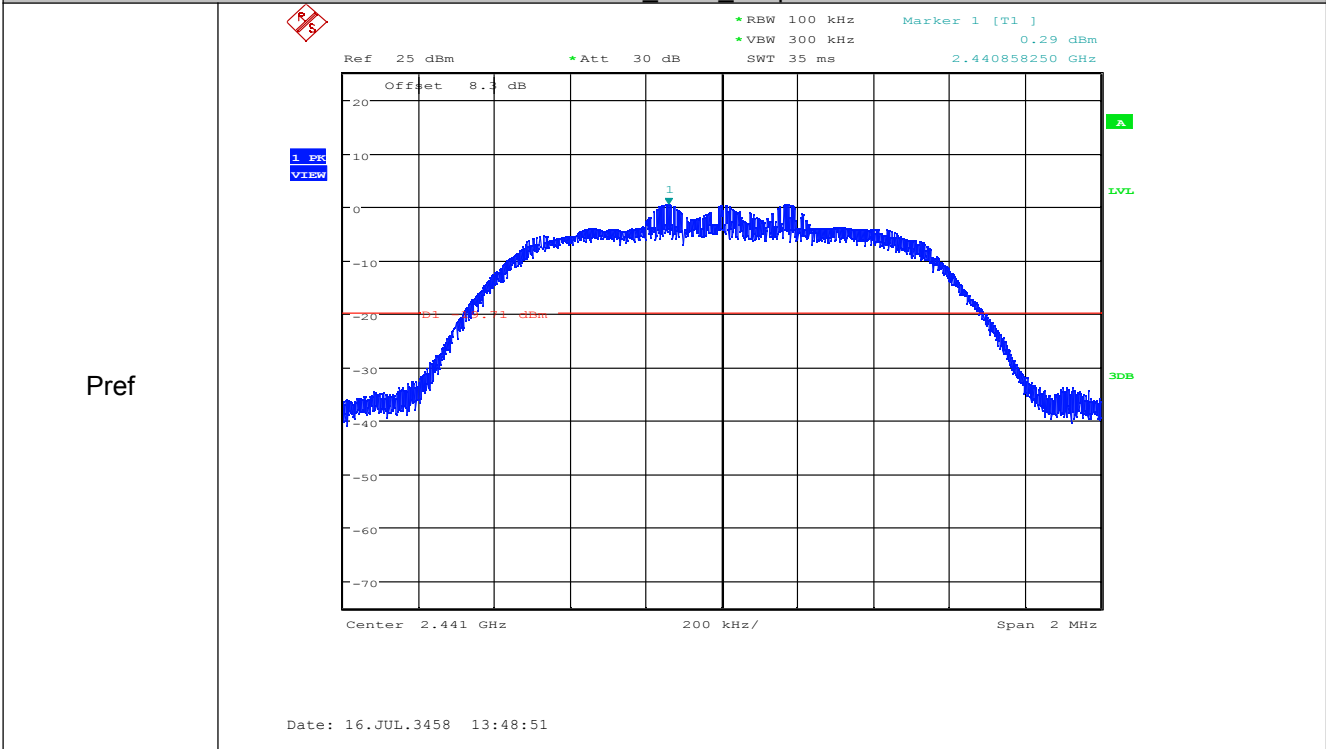



1. FSK
VIEW

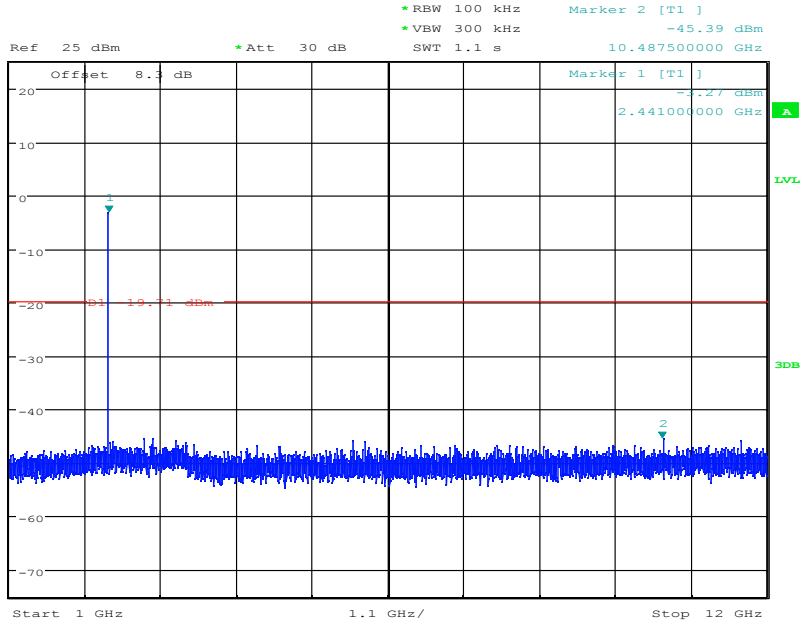

Date: 16.JUL.3458 13:49:15



1. FSK
VIEW

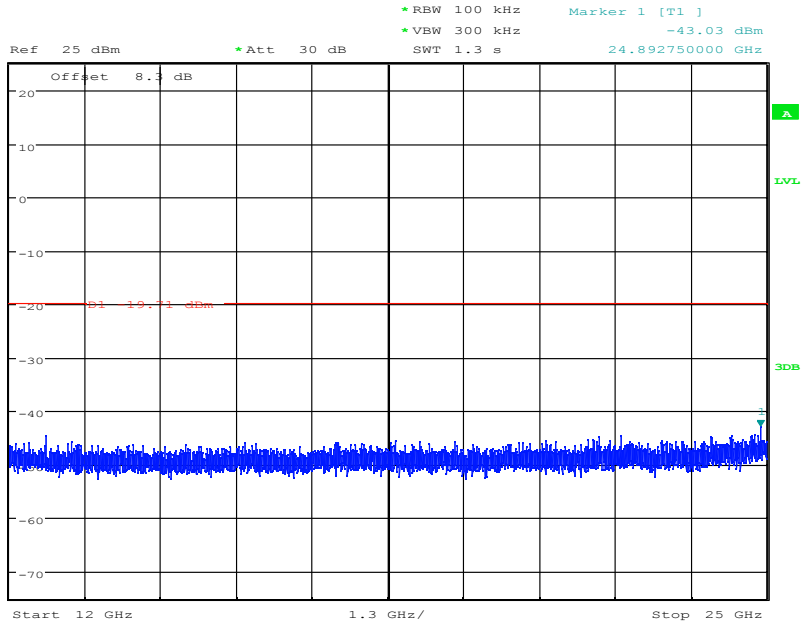

Date: 16.JUL.3458 13:49:28

$\pi/4$ DQPSK_HCH_Graphs

Pref

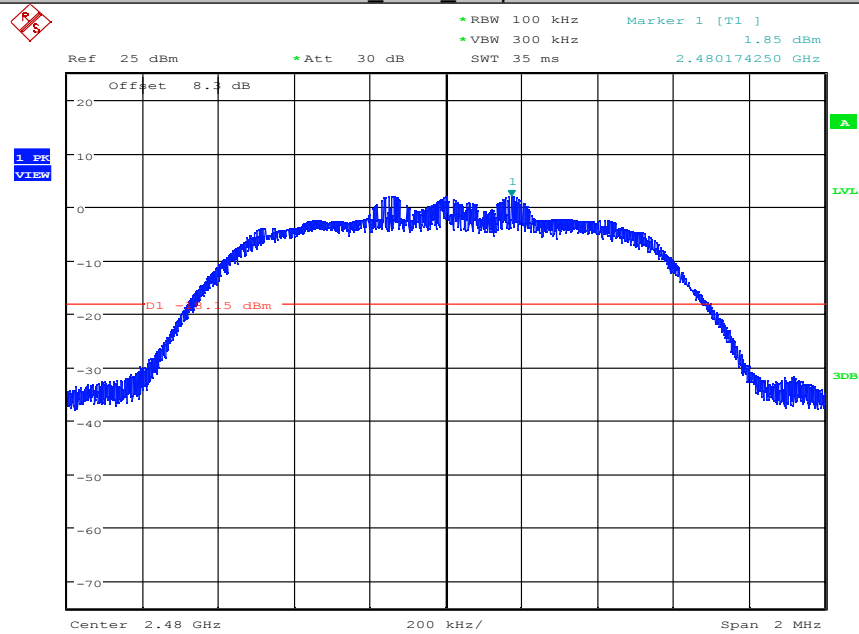

Date: 16.JUL.3458 13:55:22

Puw

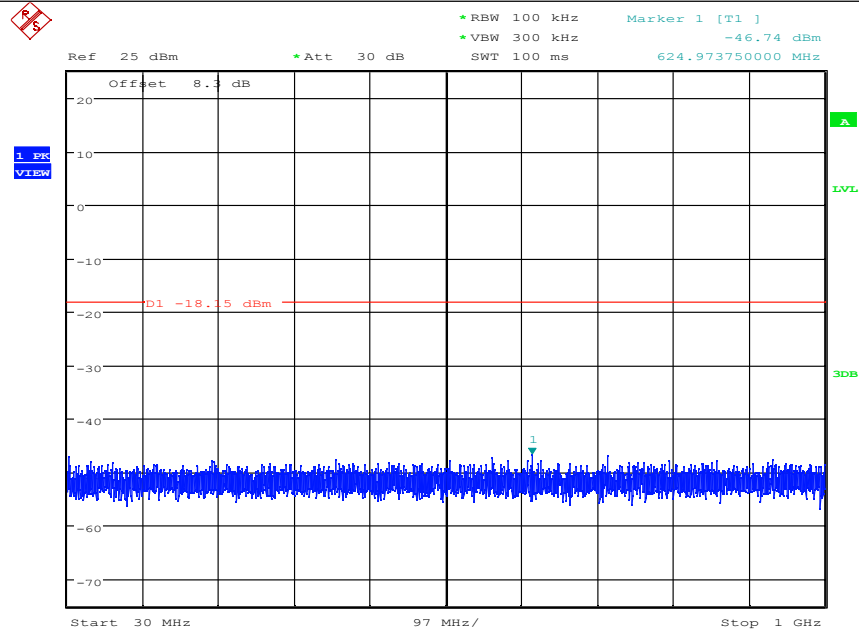

Date: 16.JUL.3458 13:55:35

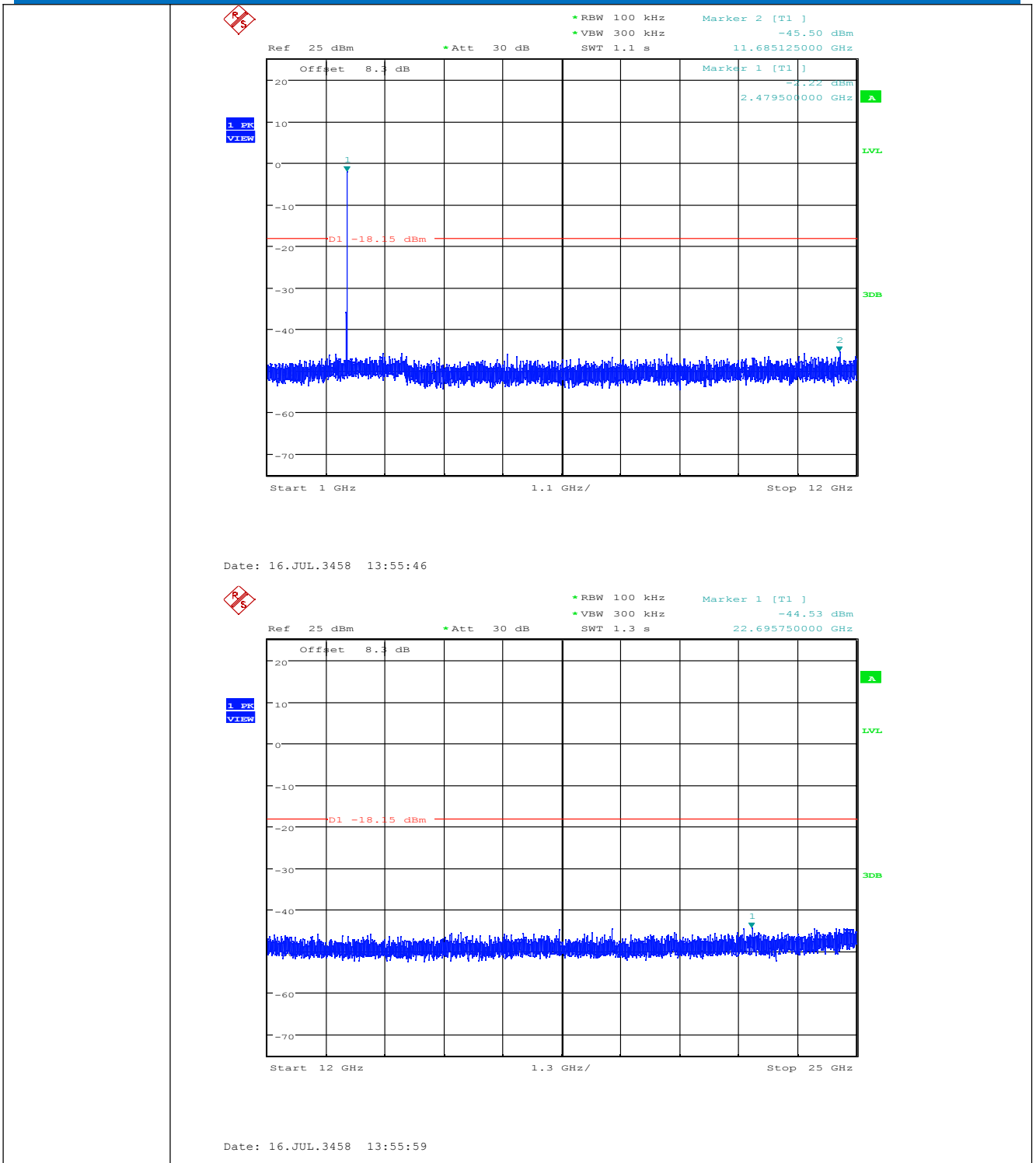

Remark:

Pre test 9kHz to 25GHz, find the highest point when testing, so only the worst data were shown in the test report. Per FCC Part 15.33 (a) and 15.31 (o) ,The amplitude of spurious emissions from intentional radiators which are attenuated more than 20 dB below the permissible value need not be reported unless specifically required elsewhere in this part.

5.10 Other requirements Frequency Hopping Spread Spectrum System

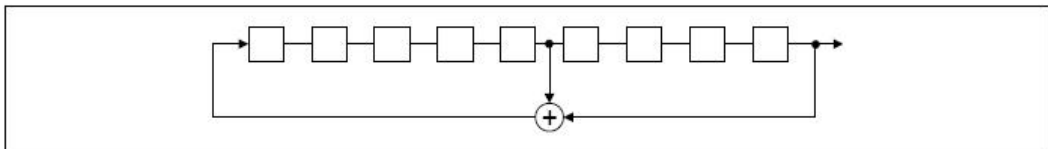
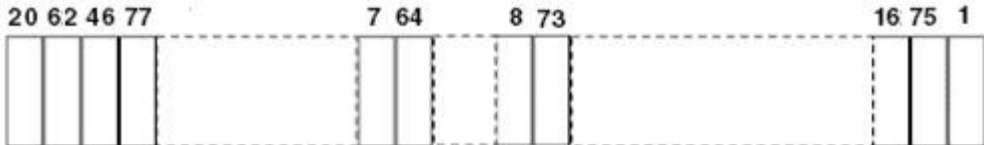
Test Requirement:	47 CFR Part 15C Section 15.247 (a)(1), (h) requirement:
<p>The system shall hop to channel frequencies that are selected at the system hopping rate from a Pseudorandom ordered list of hopping frequencies. Each frequency must be used equally on the average by each transmitter. The system receivers shall have input bandwidths that match the hopping channel bandwidths of their corresponding transmitters and shall shift frequencies in synchronization with the transmitted signals.</p> <p>Frequency hopping spread spectrum systems are not required to employ all available hopping channels during each transmission. However, the system, consisting of both the transmitter and the receiver, must be designed to comply with all of the regulations in this section should the transmitter be presented with a continuous data (or information) stream. In addition, a system employing short transmission bursts must comply with the definition of a frequency hopping system and must distribute its transmissions over the minimum number of hopping channels specified in this section.</p> <p>The incorporation of intelligence within a frequency hopping spread spectrum system that permits the system to recognize other users within the spectrum band so that it individually and independently chooses and adapts its hopsets to avoid hopping on occupied channels is permitted. The coordination of frequency hopping systems in any other manner for the express purpose of avoiding the simultaneous occupancy of individual hopping frequencies by multiple transmitters is not permitted.</p>	
Compliance for section 15.247(a)(1)	
<p>According to Bluetooth Core Specification, the pseudorandom sequence may be generated in a nine-stage shift register whose 5th and 9th stage outputs are added in a modulo-two addition stage. And the result is fed back to the input of the first stage. The sequence begins with the first ONE of 9 consecutive ONES; i.e. the shift register is initialized with nine ones.</p> <ul style="list-style-type: none"> • Number of shift register stages: 9 • Length of pseudo-random sequence: $2^9 - 1 = 511$ bits • Longest sequence of zeros: 8 (non-inverted signal) <div data-bbox="300 1370 1353 1518" style="text-align: center;">  </div> <p style="text-align: center;"><i>Linear Feedback Shift Register for Generation of the PRBS sequence</i></p> <p>An example of Pseudorandom Frequency Hopping Sequence as follow:</p> <div data-bbox="274 1621 1262 1765" style="text-align: center;">  </div> <p>Each frequency used equally on the average by each transmitter.</p> <p>According to Bluetooth Core Specification, Bluetooth receivers are designed to have input and IF bandwidths that match the hopping channel bandwidths of any Bluetooth transmitters and shift frequencies in synchronization with the transmitted signals.</p>	
Compliance for section 15.247(g)	
<p>According to Bluetooth Core Specification, the Bluetooth system transmits the packet with the pseudorandom hopping frequency with a continuous data and the short burst transmission from the Bluetooth system is also transmitted under the frequency hopping system with the pseudorandom hopping frequency system.</p>	

Compliance for section 15.247(h)

According to Bluetooth Core specification, the Bluetooth system incorporates with an adaptive system to detect other user within the spectrum band so that it individually and independently to avoid hopping on the occupied channels.

According to the Bluetooth Core specification, the Bluetooth system is designed not have the ability to coordinated with other FHSS System in an effort to avoid the simultaneous occupancy of individual hopping frequencies by multiple transmitter.

5.11 Radiated Spurious Emission & Restricted bands

Test Requirement:	47 CFR Part 15C Section 15.209 and 15.205				
Test Method:	ANSI C63.10: 2013				
Test Site:	Measurement Distance: 3m (Semi-Anechoic Chamber)				
Receiver Setup:	Frequency	Detector	RBW	VBW	Remark
	0.009MHz-0.090MHz	Peak	10kHz	30kHz	Peak
	0.009MHz-0.090MHz	Average	10kHz	30kHz	Average
	0.090MHz-0.110MHz	Quasi-peak	10kHz	30kHz	Quasi-peak
	0.110MHz-0.490MHz	Peak	10kHz	30kHz	Peak
	0.110MHz-0.490MHz	Average	10kHz	30kHz	Average
	0.490MHz -30MHz	Quasi-peak	10kHz	30kHz	Quasi-peak
	30MHz-1GHz	Peak	100 kHz	300kHz	Peak
	Above 1GHz	Peak	1MHz	3MHz	Peak
Peak		1MHz	10Hz	Average	
Limit:	Frequency	Field strength (microvolt/meter)	Limit (dBuV/m)	Remark	Measurement distance (m)
	0.009MHz-0.490MHz	2400/F(kHz)	-	-	300
	0.490MHz-1.705MHz	24000/F(kHz)	-	-	30
	1.705MHz-30MHz	30	-	-	30
	30MHz-88MHz	100	40.0	Quasi-peak	3
	88MHz-216MHz	150	43.5	Quasi-peak	3
	216MHz-960MHz	200	46.0	Quasi-peak	3
	960MHz-1GHz	500	54.0	Quasi-peak	3
	Above 1GHz	500	54.0	Average	3
<p>Note: 15.35(b), Unless otherwise specified, the limit on peak radio frequency emissions is 20dB above the maximum permitted average emission limit applicable to the equipment under test. This peak limit applies to the total peak emission level radiated by the device.</p>					

Test Setup:

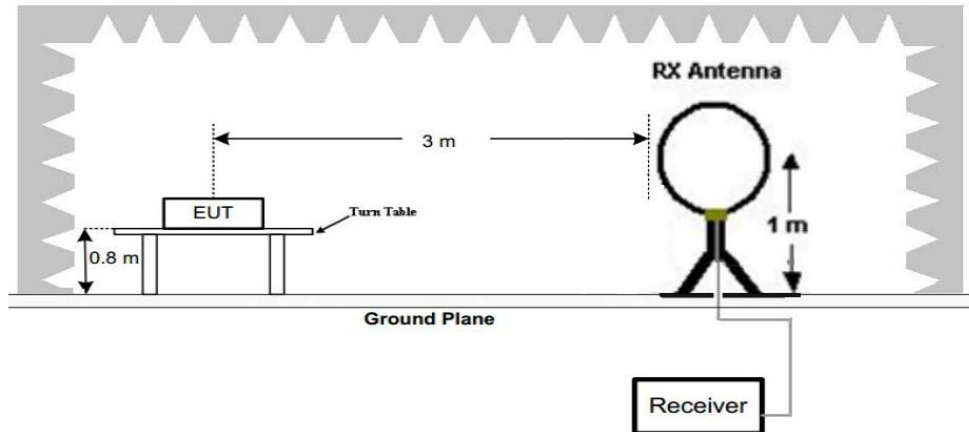

Figure 1. Below 30MHz

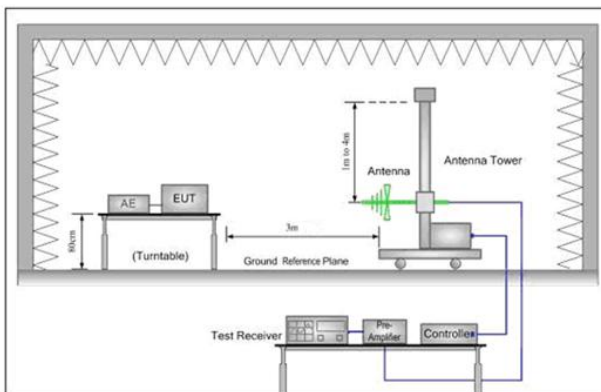

Figure 2. 30MHz to 1GHz

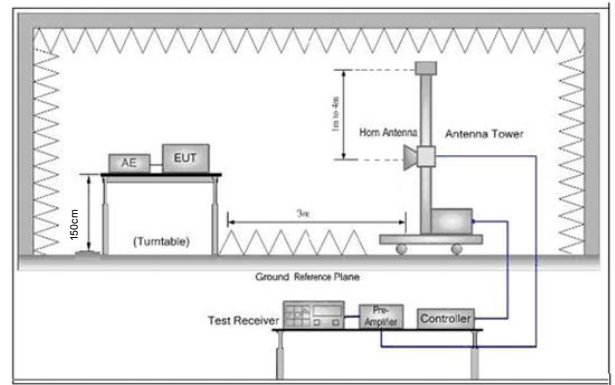

Figure 3. Above 1 GHz

Test Procedure:

- a. 1) Below 1G: The EUT was placed on the top of a rotating table 0.8 meters above the ground at a 3 meter semi-anechoic chamber. The table was rotated 360 degrees to determine the position of the highest radiation.
- 2) Above 1G: The EUT was placed on the top of a rotating table 1.5 meters above the ground at a 3 meter semi-anechoic chamber. The table was rotated 360 degrees to determine the position of the highest radiation.
- Note: For the radiated emission test above 1GHz:
Place the measurement antenna away from each area of the EUT determined to be a source of emissions at the specified measurement distance, while keeping the measurement antenna aimed at the source of emissions at each frequency of significant emissions, with polarization oriented for maximum response. The measurement antenna may have to be higher or lower than the EUT, depending on the radiation pattern of the emission and staying aimed at the emission source for receiving the maximum signal. The final measurement antenna elevation shall be that which maximizes the emissions. The measurement antenna elevation for maximum emissions shall be restricted to a range of heights of from 1 m to 4 m above the ground or reference ground plane.
- b. The EUT was set 3 meters away from the interference-receiving antenna, which was mounted on the top of a variable-height antenna tower.
- c. The antenna height is varied from one meter to four meters above the ground to determine the maximum value of the field strength. Both horizontal and vertical polarizations of the antenna are set to make the measurement.

	<p>d. For each suspected emission, the EUT was arranged to its worst case and then the antenna was tuned to heights from 1 meter to 4 meters (for the test frequency of below 30MHz, the antenna was tuned to heights 1 meter) and the rotatable table was turned from 0 degrees to 360 degrees to find the maximum reading.</p> <p>e. The test-receiver system was set to Peak Detect Function and Specified Bandwidth with Maximum Hold Mode.</p> <p>f. If the emission level of the EUT in peak mode was 10dB lower than the limit specified, then testing could be stopped and the peak values of the EUT would be reported. Otherwise the emissions that did not have 10dB margin would be re-tested one by one using peak, quasi-peak or average method as specified and then reported in a data sheet.</p> <p>g. Test the EUT in the lowest channel (2402MHz),the middle channel (2441MHz),the Highest channel (2480MHz)</p> <p>h. The radiation measurements are performed in X, Y, Z axis positioning for Transmitting mode, and found the X axis positioning which it is the worst case.</p> <p>i. Repeat above procedures until all frequencies measured was complete.</p>
Exploratory Test Mode:	<p>Non-hopping transmitting mode with all kind of modulation and all kind of data type Transmitting mode.</p>
Final Test Mode:	<p>Through Pre-scan, find the DH5 of data type and GFSK modulation is the worst case. Pretest the EUT at Transmitting mode and Transmitting mode, found the Transmitting mode which it is worse case For below 1GHz part, through pre-scan, the worst case is the lowest channel. Only the worst case is recorded in the report.</p>
Test Results:	<p>Pass</p>

5.11.1 Radiated Emission below 1GHz

30MHz~1GHz		
Test mode:	Transmitting	Vertical

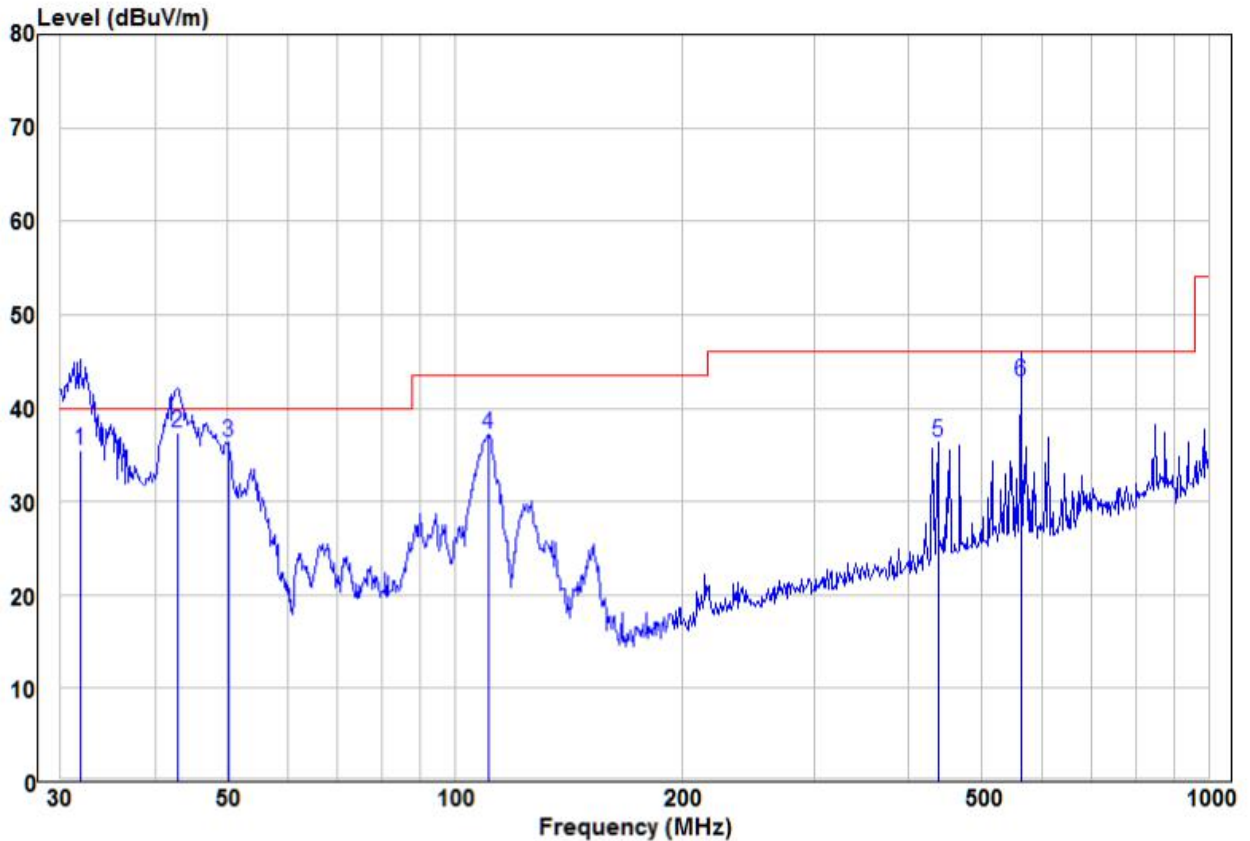

	Read Freq	Read Level	Factor	Level	Limit Line	Over Limit	Remark	Pol/Phase
	MHz	dBuV	dB/m	dBuV/m	dBuV/m	dB		
1	31.84	20.00	15.43	35.43	40.00	-4.57	QP	VERTICAL
2	pp 42.90	25.99	11.44	37.43	40.00	-2.57	QP	VERTICAL
3	pk 50.06	28.25	8.08	36.33	40.00	-3.67	Peak	VERTICAL
4	110.96	27.03	10.23	37.26	43.50	-6.24	Peak	VERTICAL
5	437.12	20.06	16.33	36.39	46.00	-9.61	Peak	VERTICAL
6	562.66	23.91	18.92	42.83	46.00	-3.17	QP	VERTICAL

Remark:

The field strength is calculated by adding the Antenna Factor, Cable Factor & Preamplifier. The basic equation with a sample calculation is as follows:

Factor= Antenna Factor + Cable Factor – Preamplifier Factor,

Level = Read Level + Factor,

Over Limit=Level-Limit Line.

Test mode:	Transmitting	Horizontal
------------	--------------	------------

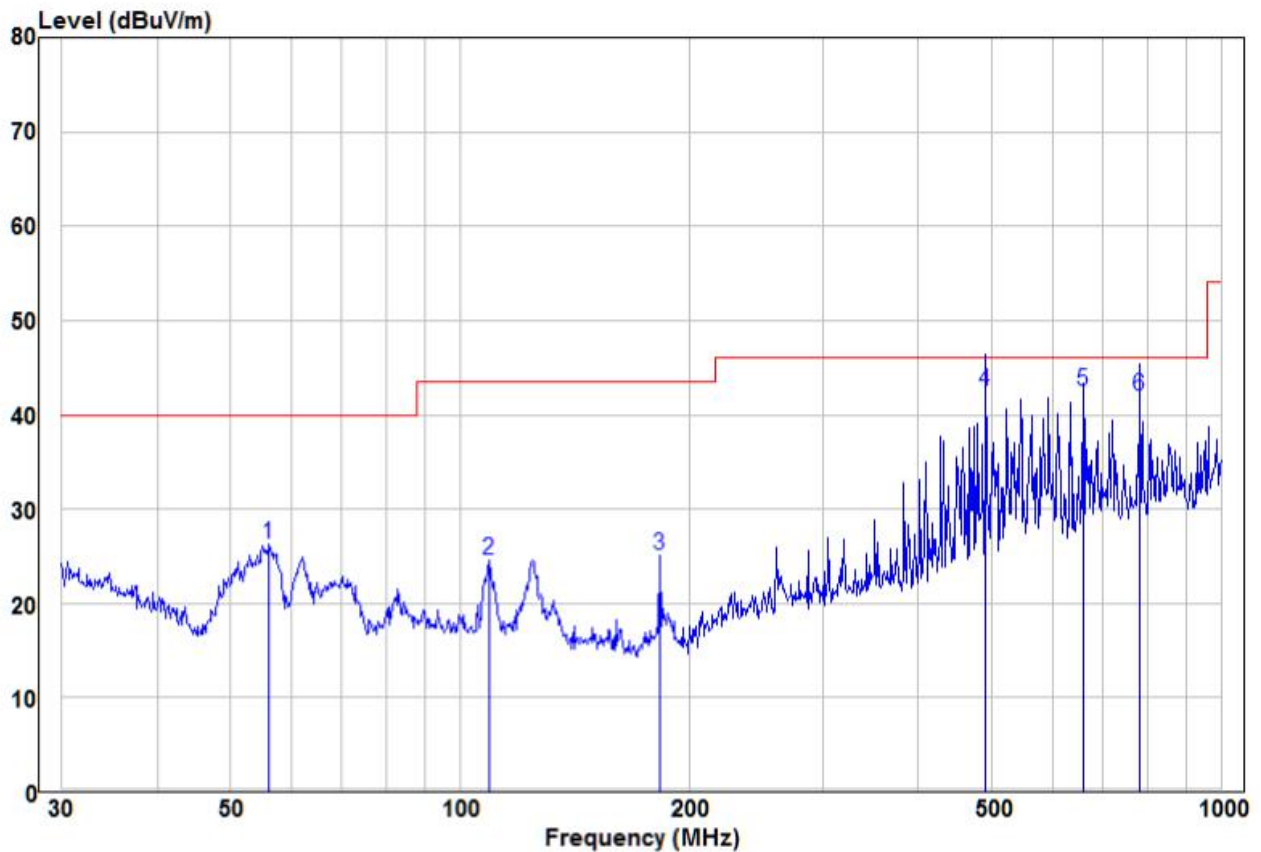

	Read Freq	Read Level	Factor	Level	Limit Line	Over Limit	Remark	Pol/Phase
	MHz	dBuV	dB/m	dBuV/m	dBuV/m	dB		
1 pk	56.20	19.79	6.57	26.36	40.00	-13.64	Peak	HORIZONTAL
2	109.41	14.36	10.20	24.56	43.50	-18.94	Peak	HORIZONTAL
3	183.20	16.82	8.22	25.04	43.50	-18.46	Peak	HORIZONTAL
4	490.74	24.50	17.99	42.49	46.00	-3.51	QP	HORIZONTAL
5 pp	658.84	22.70	19.84	42.54	46.00	-3.46	QP	HORIZONTAL
6	782.35	19.81	22.17	41.98	46.00	-4.02	QP	HORIZONTAL

Remark:

The field strength is calculated by adding the Antenna Factor, Cable Factor & Preamplifier. The basic equation with a sample calculation is as follows:

Factor= Antenna Factor + Cable Factor – Preamplifier Factor,

Level = Read Level + Factor,

Over Limit=Level-Limit Line.

5.11.2 Transmitter Emission above 1GHz

Worse case mode:		GFSK(DH5)		Test channel:		Lowest	
Frequency	Meter Reading	Factor	Emission Level	Limits	Over	Detector Type	Ant. Pol.
(MHz)	(dB μ V)	(dB)	(dB μ V/m)	(dB μ V/m)	(dB)		H/V
2390	53.61	-9.2	44.41	74	-29.59	Peak	H
2400	55.45	-9.39	46.06	74	-27.94	Peak	H
4804	52.17	-4.33	47.84	74	-26.16	Peak	H
7206	51.16	1.01	52.17	74	-21.83	Peak	H
2390	55.33	-9.2	46.13	74	-27.87	Peak	V
2400	55.63	-9.39	46.24	74	-27.76	Peak	V
4804	53.21	-4.33	48.88	74	-25.12	Peak	V
7206	50.94	1.01	51.95	74	-22.05	Peak	V

Worse case mode:		GFSK(DH5)		Test channel:		Middle	
Frequency	Meter Reading	Factor	Emission Level	Limits	Over	Detector Type	Ant. Pol.
(MHz)	(dB μ V)	(dB)	(dB μ V/m)	(dB μ V/m)	(dB)		H/V
4882	52.63	-4.11	48.52	74	-25.48	peak	H
7323	50.19	1.51	51.70	74	-22.30	peak	H
4882	52.47	-4.11	48.36	74	-25.64	peak	V
7323	50.32	1.51	51.83	74	-22.17	peak	V

Worse case mode:		GFSK(DH5)		Test channel:		Highest	
Frequency	Meter Reading	Factor	Emission Level	Limits	Over	Detector Type	Ant. Pol.
(MHz)	(dB μ V)	(dB)	(dB μ V/m)	(dB μ V/m)	(dB)		H/V
2483.5	55.21	-9.29	45.92	74	-28.08	Peak	H
4960	52.55	-4.04	48.51	74	-25.49	Peak	H
7440	49.42	1.57	50.99	74	-23.01	Peak	H
2483.5	54.43	-9.29	45.14	74	-28.86	Peak	V
4960	48.93	-4.04	44.89	74	-29.11	Peak	V
7440	50.80	1.57	52.37	74	-21.63	Peak	V

Remark:

- 1) The field strength is calculated by adding the Antenna Factor, Cable Factor & Preamplifier. The basic equation with a sample calculation is as follows:
Final Test Level = Receiver Reading + Antenna Factor + Cable Factor – Preamplifier Factor
- 2) Scan from 9kHz to 25GHz, the disturbance above 10GHz and below 30MHz was very low. As shown in this section, for frequencies above 1GHz, the field strength limits are based on average limits. However, the peak field strength of any emission shall not exceed the maximum permitted average limits specified above by more than 20 dB under any condition of modulation. So, only the peak measurements were shown in the report.

6 Photographs - EUT Test Setup

6.1 Radiated Emission

9KHz~30MHz:

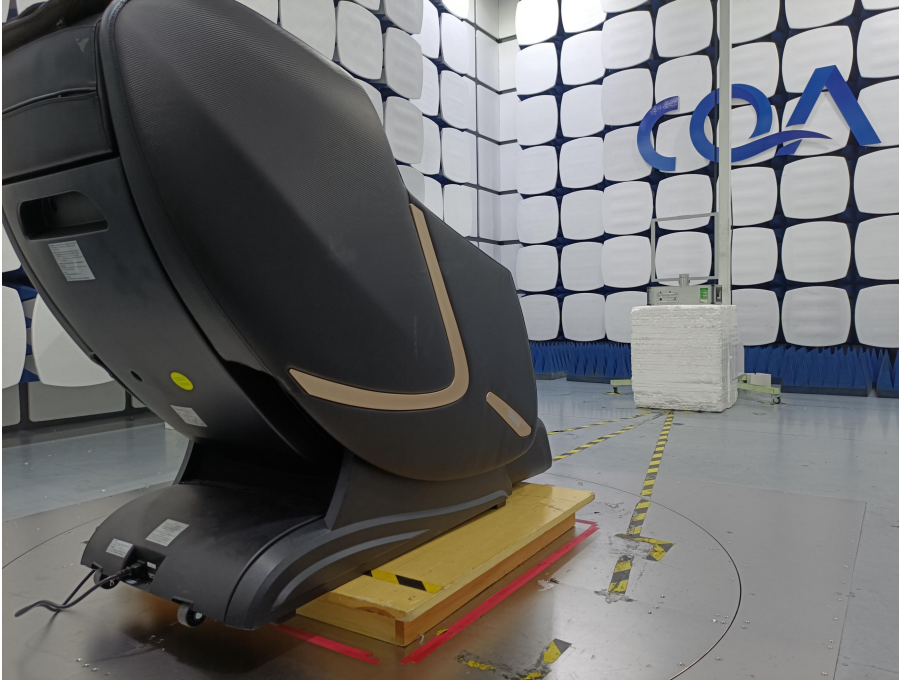

30MHz~1GHz:

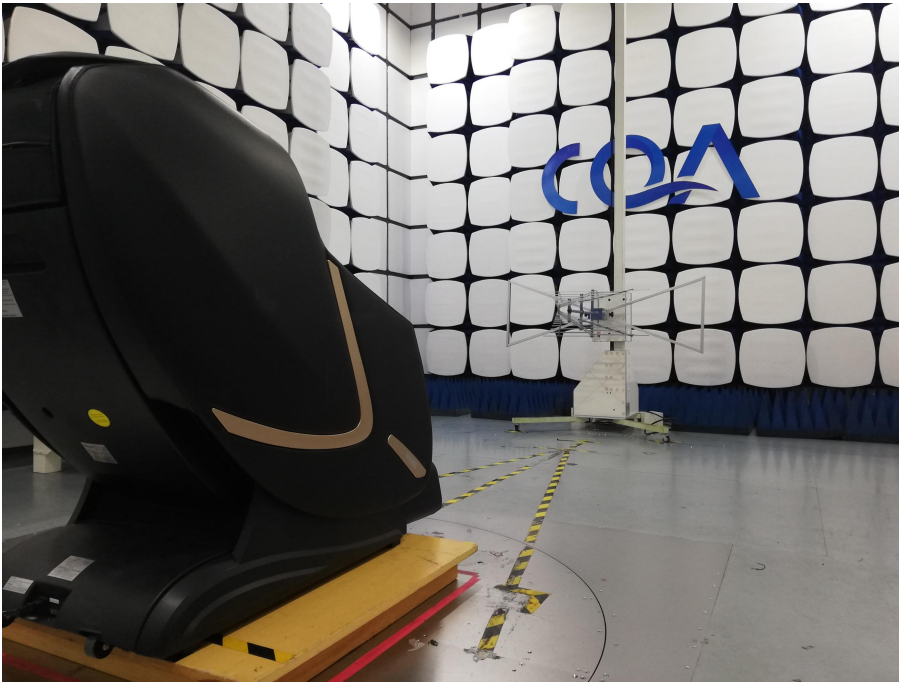

Above 1GHz:



6.2 Conducted Emission



7 Photographs - EUT Constructional Details





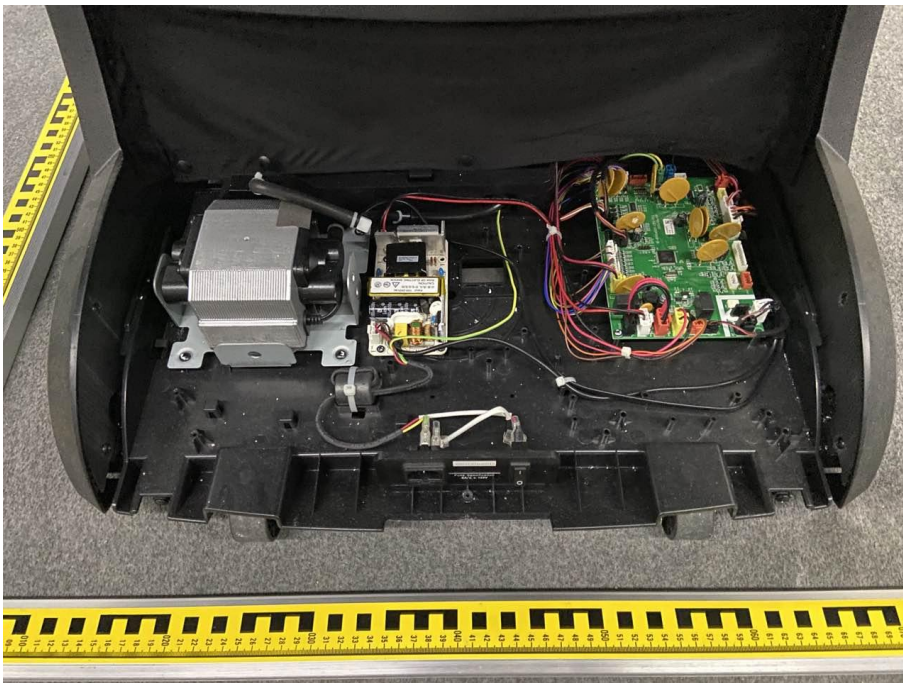

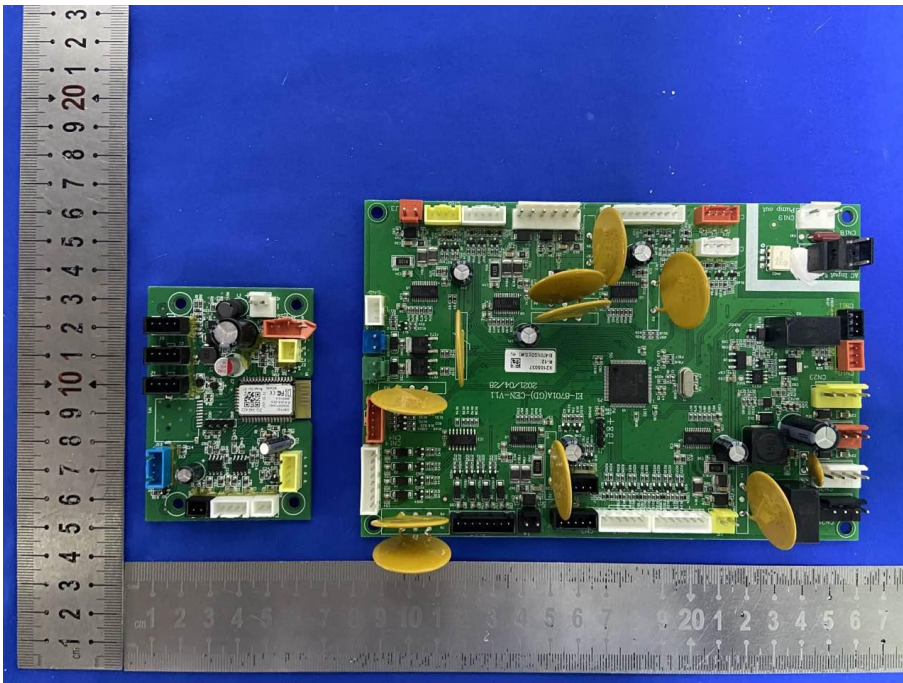

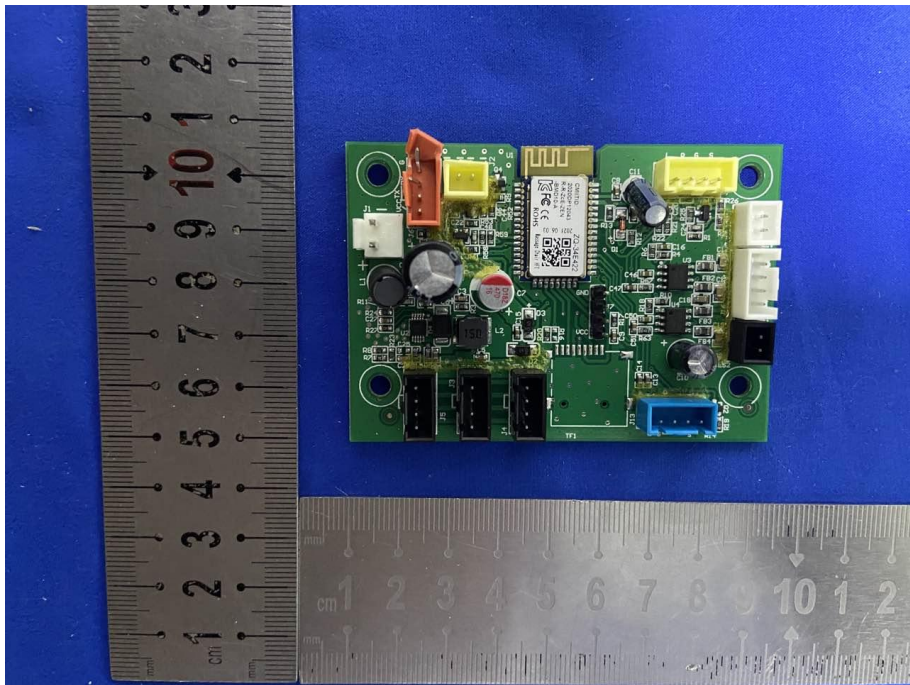
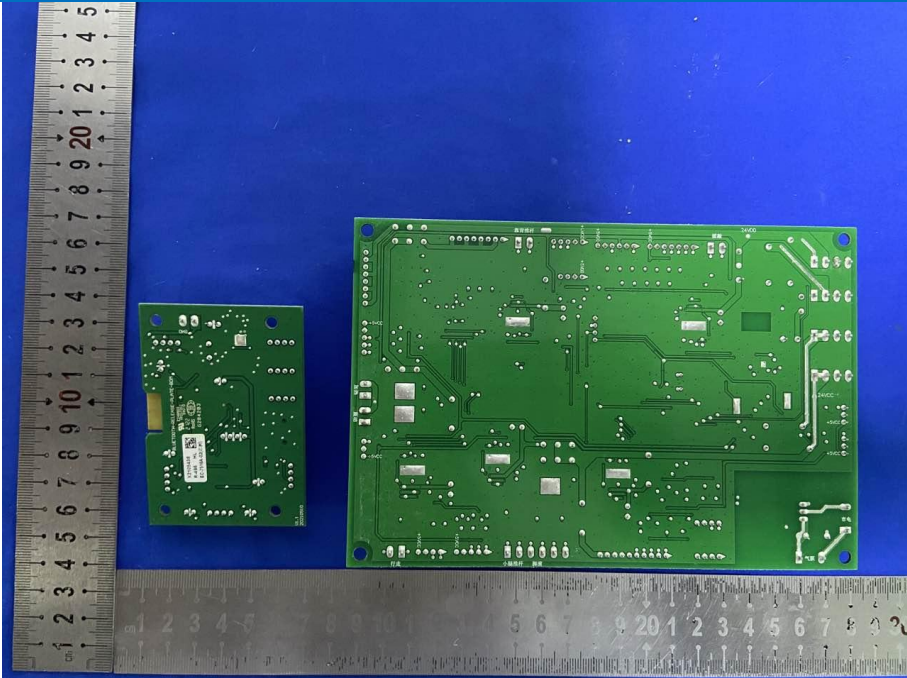

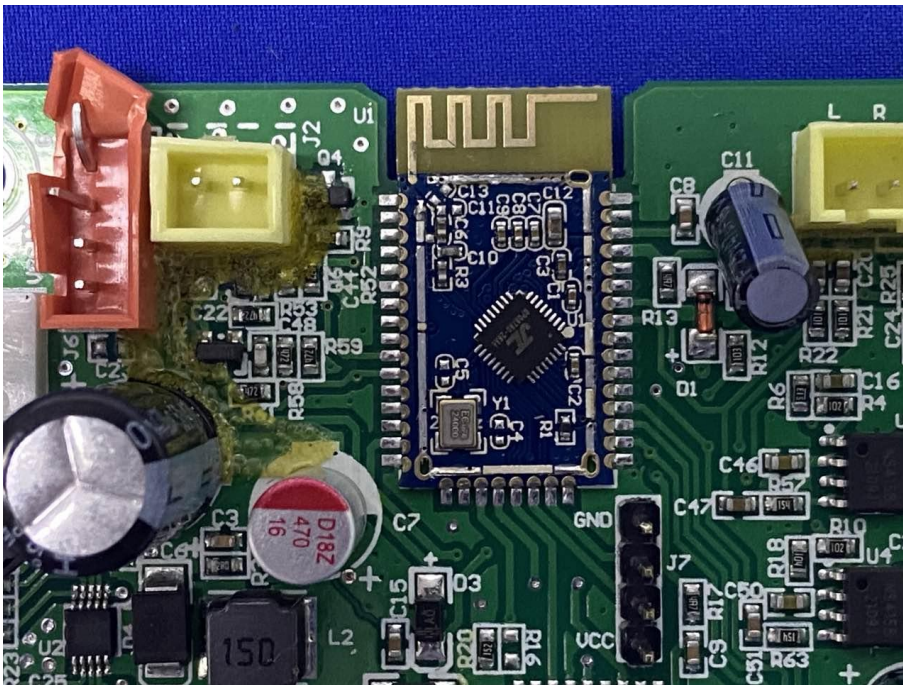
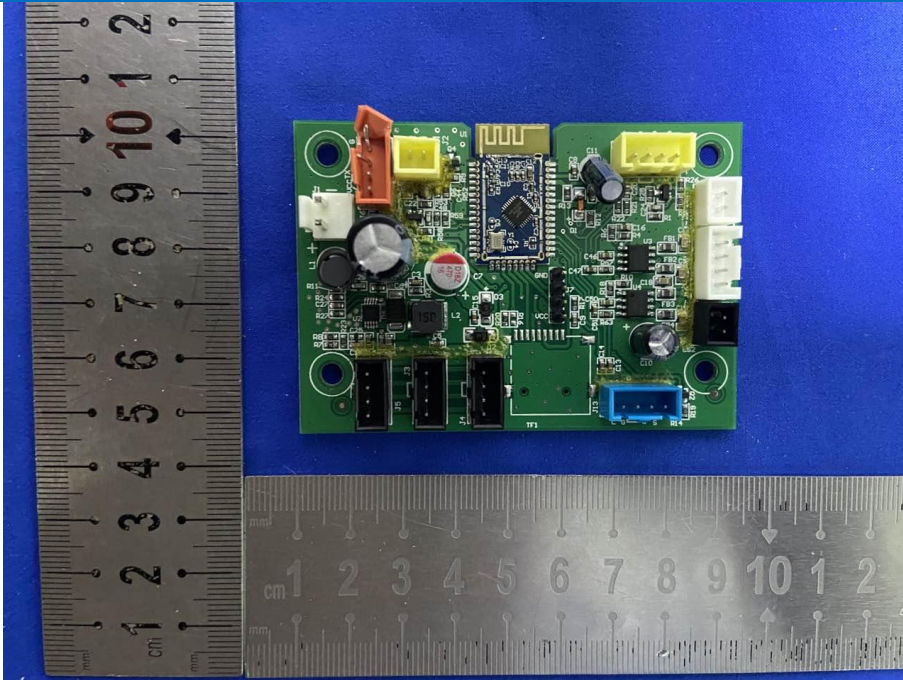

The End