

APPLICATION CERTIFICATION FCC Part 15C
On Behalf of
XIAMEN COMFORT SCIENCE & TECHNOLOGY GROUP CO., LTD

Massage Chair
Model No.: EC-806A

FCC ID: YMX-EC806A

Prepared for : XIAMEN COMFORT SCIENCE & TECHNOLOGY GROUP CO.,
LTD
Address : (5/F) NO.168, QIANPU ROAD, SIMING DISTRICT, XIAMEN,
CHINA

Prepared by : Shenzhen Accurate Technology Co., Ltd.
Address : 1/F., Building A, Changyuan New Material Port, Science & Industry
Park, Nanshan District, Shenzhen, Guangdong, P.R. China

Tel: (0755) 26503290
Fax: (0755) 26503396

Report No. : ATE20181011
Date of Test : Jul. 9-Sep 11, 2018
Date of Report : Sep. 21, 2018

TABLE OF CONTENTS

Description	Page
Test Report Certification	
1. GENERAL INFORMATION	5
1.1. Description of Device (EUT).....	5
1.2. Carrier Frequency of Channels.....	5
1.3. Special Accessory and Auxiliary Equipment	6
1.4. Description of Test Facility	6
1.5. Measurement Uncertainty.....	6
2. MEASURING DEVICE AND TEST EQUIPMENT	7
3. OPERATION OF EUT DURING TESTING	8
3.1. Operating Mode.....	8
3.2. Configuration and peripherals	8
4. TEST PROCEDURES AND RESULTS	9
5. 6DB BANDWIDTH TEST.....	10
5.1. Block Diagram of Test Setup.....	10
5.2. The Requirement For Section 15.247(a)(2).....	10
5.3. EUT Configuration on Measurement	10
5.4. Operating Condition of EUT	10
5.5. Test Procedure	10
5.6. Test Result	11
6. MAXIMUM PEAK OUTPUT POWER TEST	13
6.1. Block Diagram of Test Setup.....	13
6.2. The Requirement For Section 15.247(b)(3).....	13
6.3. EUT Configuration on Measurement	13
6.4. Operating Condition of EUT	13
6.5. Test Procedure	13
6.6. Test Result	14
7. POWER SPECTRAL DENSITY TEST.....	16
7.1. Block Diagram of Test Setup.....	16
7.2. The Requirement For Section 15.247(e).....	16
7.3. EUT Configuration on Measurement	16
7.4. Operating Condition of EUT	16
7.5. Test Procedure	17
7.6. Test Result	17
8. BAND EDGE COMPLIANCE TEST	20
8.1. Block Diagram of Test Setup.....	20
8.2. The Requirement For Section 15.247(d)	20
8.3. EUT Configuration on Measurement	20
8.4. Operating Condition of EUT	20
8.5. Test Procedure	21
8.6. Test Result	21
9. RADIATED SPURIOUS EMISSION TEST	27
9.1. Block Diagram of Test Setup.....	27
9.2. The Limit For Section 15.247(d)	28
9.3. Restricted bands of operation	29
9.4. Configuration of EUT on Measurement	29

9.5.	Operating Condition of EUT	30
9.6.	Test Procedure	30
9.7.	Data Sample.....	31
9.8.	The Field Strength of Radiation Emission Measurement Results	31
10.	AC POWER LINE CONDUCTED EMISSION TEST	44
10.1.	Block Diagram of Test Setup.....	44
10.2.	Test System Setup.....	44
10.3.	Power Line Conducted Emission Measurement Limits.....	45
10.4.	Configuration of EUT on Measurement	45
10.5.	Operating Condition of EUT	45
10.6.	Test Procedure	45
10.7.	Data Sample.....	46
10.8.	Power Line Conducted Emission Measurement Results	46
11.	ANTENNA REQUIREMENT.....	49
11.1.	The Requirement	49
11.2.	Antenna Construction	49

Test Report Certification

Applicant : XIAMEN COMFORT SCIENCE & TECHNOLOGY GROUP CO., LTD
Manufacturer : XIAMEN COMFORT SCIENCE & TECHNOLOGY GROUP CO., LTD
EUT Description : Massage Chair
Model No. : EC-806A

Measurement Procedure Used:

**FCC Rules and Regulations Part 15 Subpart C Section 15.247
ANSI C63.10: 2013**

The EUT was tested according to DTS test procedure of August 24, 2018 KDB558074 D01 DTS Meas Guidance v05 for compliance to FCC 47CFR 15.247 requirements

The device described above is tested by Shenzhen Accurate Technology Co., Ltd. to determine the maximum emission levels emanating from the device. The maximum emission levels are compared to the FCC Part 15 Subpart C Section 15.247 limits. The measurement results are contained in this test report and Shenzhen Accurate Technology Co., Ltd. is assumed full responsibility for the accuracy and completeness of these measurements. Also, this report shows that the Equipment Under Test (EUT) is to be technically compliant with the FCC requirements.

This report applies to above tested sample only. This report shall not be reproduced in part without written approval of Shenzhen Accurate Technology Co., Ltd.

Date of Test : Jul. 9-Sep 11, 2018
Date of Report : Sep. 21, 2018

Prepared by : _____
(Sean Yang, Engineer)

Approved & Authorized Signer : _____
(Sean Liu, Manager)

Sean Yang

Sean Liu

1. GENERAL INFORMATION

1.1. Description of Device (EUT)

Model Number : EC-806A

Bluetooth version : V4.0 BLE

Frequency Range : 2402MHz-2480MHz

Number of Channels : 40

Antenna Gain(Max) : 2dBi

Antenna type : Ceramic Antenna

Modulation mode : GFSK

Power supply : AC 110-120V, 60Hz

Applicant : XIAMEN COMFORT SCIENCE & TECHNOLOGY GROUP CO., LTD

Address : (5/F) NO.168, QIANPU ROAD, SIMING DISTRICT, XIAMEN, CHINA

Manufacturer : XIAMEN COMFORT SCIENCE & TECHNOLOGY GROUP CO., LTD

Address : (5/F) NO.168, QIANPU ROAD, SIMING DISTRICT, XIAMEN, CHINA

1.2. Carrier Frequency of Channels

Channel	Frequency (MHz)	Channel	Frequency (MHz)	Channel	Frequency (MHz)	Channel	Frequency (MHz)
0	2402	10	2422	20	2442	30	2462
1	2404	11	2424	21	2444	31	2464
2	2406	12	2426	22	2446	32	2466
3	2408	13	2428	23	2448	33	2468
4	2410	14	2430	24	2450	34	2470
5	2412	15	2432	25	2452	35	2472
6	2414	16	2434	26	2454	36	2474
7	2416	17	2436	27	2456	37	2476
8	2418	18	2438	28	2458	38	2478
9	2420	19	2440	29	2460	39	2480

1.3.Special Accessory and Auxiliary Equipment

N/A

1.4.Description of Test Facility

EMC Lab	:	Recognition of accreditation by Federal Communications Commission (FCC) The Designation Number is CN1189 The Registration Number is 708358
		Listed by Innovation, Science and Economic Development Canada (ISED) The Registration Number is 5077A-2
		Accredited by China National Accreditation Service for Conformity Assessment (CNAS) The Registration Number is CNAS L3193
		Accredited by American Association for Laboratory Accreditation (A2LA) The Certificate Number is 4297.01
Name of Firm	:	Shenzhen Accurate Technology Co., Ltd.
Site Location	:	1/F., Building A, Changyuan New Material Port, Science & Industry Park, Nanshan District, Shenzhen, Guangdong, P.R. China

1.5.Measurement Uncertainty

Conducted Emission Expanded Uncertainty	=	2.23dB, k=2
Radiated emission expanded uncertainty (9kHz-30MHz)	=	3.08dB, k=2
Radiated emission expanded uncertainty (30MHz-1000MHz)	=	4.42dB, k=2
Radiated emission expanded uncertainty (Above 1GHz)	=	4.06dB, k=2

2. MEASURING DEVICE AND TEST EQUIPMENT

Table 1: List of Test and Measurement Equipment

Kind of equipment	Manufacturer	Type	S/N	Calibrated dates	Cal. Interval
EMI Test Receiver	Rohde&Schwarz	ESCS30	100307	Jan. 06, 2018	One Year
EMI Test Receiver	Rohde&Schwarz	ESR	101817	Jan. 06, 2018	One Year
Spectrum Analyzer	Rohde&Schwarz	FSV-40	101495	Jan. 06, 2018	One Year
Pre-Amplifier	Rohde&Schwarz	CBLU118354 0-01	3791	Jan. 06, 2018	One Year
Loop Antenna	Schwarzbeck	FMZB1516	1516131	Jan. 06, 2018	One Year
Bilog Antenna	Schwarzbeck	VULB9163	9163-323	Jan. 06, 2018	One Year
Horn Antenna	Schwarzbeck	BBHA9120D	9120D-655	Jan. 06, 2018	One Year
Horn Antenna	Schwarzbeck	BBHA9170	9170-359	Jan. 06, 2018	One Year
LISN	Schwarzbeck	NSLK8126	8126431	Jan. 06, 2018	One Year
Highpass Filter	Wainwright Instruments	WHKX3.6/18 G-10SS	N/A	Jan. 06, 2018	One Year
Band Reject Filter	Wainwright Instruments	WRCG2400/2 485-2375/2510 -60/11SS	N/A	Jan. 06, 2018	One Year
Conducted Emission Measurement Software: ES-K1 V1.71					
Radiated Emission Measurement Software: EZ_EMV V1.1.4.2					

3. OPERATION OF EUT DURING TESTING

3.1. Operating Mode

The mode is used: **Transmitting mode**

Low Channel: 2402MHz

Middle Channel: 2440MHz

High Channel: 2480MHz

Its duty cycle setting is greater than 98%.

3.2. Configuration and peripherals

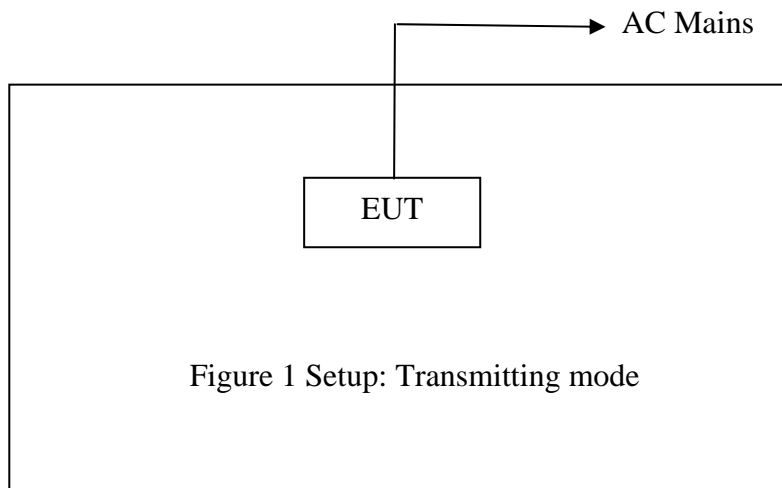

Figure 1 Setup: Transmitting mode

4. TEST PROCEDURES AND RESULTS

FCC Rules	Description of Test	Result
Section 15.247(a)(2)	6dB Bandwidth Test	Compliant
Section 15.247(b)(3)	Maximum Peak Output Power Test	Compliant
Section 15.247(e)	Power Spectral Density Test	Compliant
Section 15.247(d)	Band Edge Compliance Test	Compliant
Section 15.247(d) Section 15.209	Radiated Spurious Emission Test	Compliant
Section 15.207	AC Power Line Conducted Emission Test	Compliant
Section 15.203	Antenna Requirement	Compliant

5. 6DB BANDWIDTH TEST

5.1. Block Diagram of Test Setup

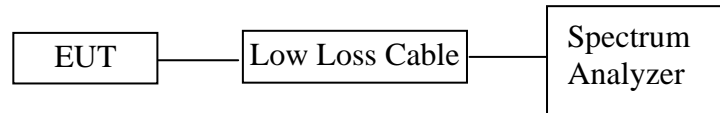

5.2. The Requirement For Section 15.247(a)(2)

Section 15.247(a)(2): Systems using digital modulation techniques may operate in the 902-928MHz, 2400-2483.5MHz, and 5725-5850MHz bands. The minimum 6 dB bandwidth shall be at least 500 kHz.

5.3. EUT Configuration on Measurement

The equipment is installed on the emission measurement to meet the commission requirements and operating regulations in a manner which tends to maximize its emission characteristics in normal application.

5.4. Operating Condition of EUT

5.4.1. Setup the EUT and simulator as shown as Section 5.1.

5.4.2. Turn on the power of all equipment.

5.4.3. Let the EUT work in TX modes measure it. The transmit frequency are 2402-2480MHz. We select 2402MHz, 2440MHz, and 2480MHz TX frequency to transmit.

5.5. Test Procedure

5.5.1. The transmitter output was connected to the spectrum analyzer through a low loss cable.

5.5.2. Set RBW of spectrum analyzer to 100 kHz and VBW to 300 kHz.

5.5.3. The 6dB bandwidth is defined as the total spectrum the power of which is higher than peak power minus 6dB.

5.6. Test Result

Channel	Frequency (MHz)	6 dB Bandwidth (MHz)	Minimum Limit(MHz)	Result
0	2402	0.678	0.5	PASS
19	2440	0.672	0.5	PASS
39	2480	0.672	0.5	PASS

The spectrum analyzer plots are attached as below.

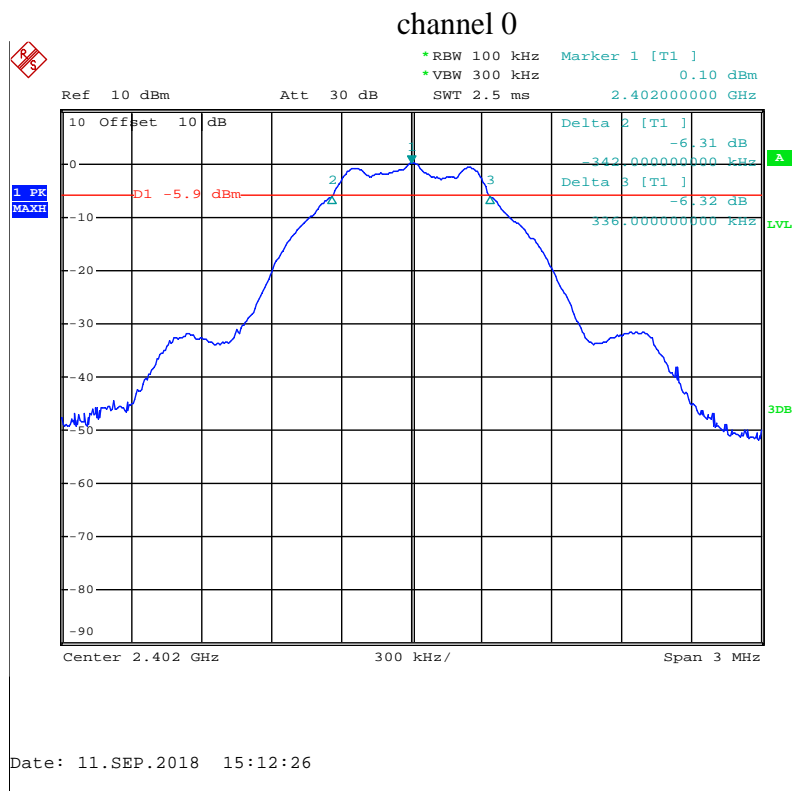

channel 19

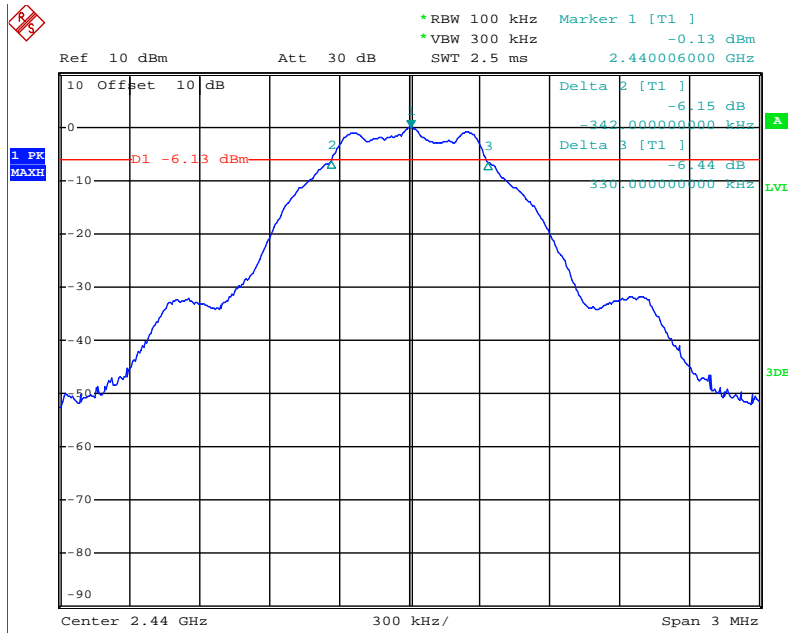

Date: 11.SEP.2018 15:15:31

channel 39

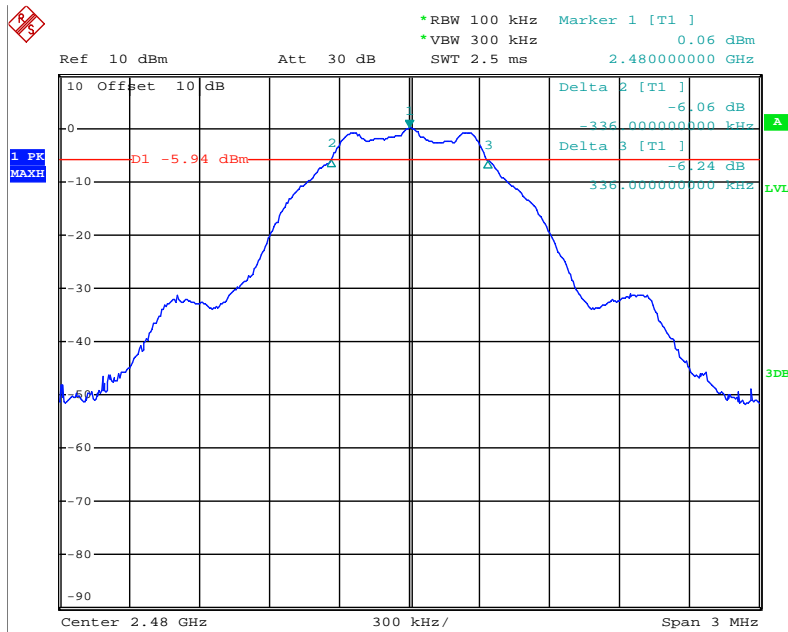

Date: 11.SEP.2018 15:16:55

6. MAXIMUM PEAK OUTPUT POWER TEST

6.1. Block Diagram of Test Setup

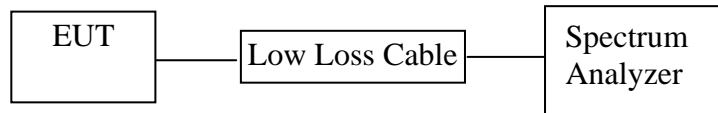

6.2. The Requirement For Section 15.247(b)(3)

Section 15.247(b)(3): For systems using digital modulation in the 902-928MHz, 2400-2483.5MHz, and 5725-5850MHz bands: 1 Watt.

6.3. EUT Configuration on Measurement

The equipment are installed on the emission Measurement to meet the commission requirements and operating regulations in a manner which tends to maximize its emission characteristics in normal application.

6.4. Operating Condition of EUT

6.4.1. Setup the EUT and simulator as shown as Section 6.1.

6.4.2. Turn on the power of all equipment.

6.4.3. Let the EUT work in TX modes measure it. The transmit frequency are 2402-2480MHz. We select 2402MHz, 2440MHz, and 2480MHz TX frequency to transmit.

6.5. Test Procedure

6.5.1. The transmitter output was connected to the spectrum analyzer through a low loss cable.

6.5.2. Set RBW of spectrum analyzer to 1 MHz and VBW to 3MHz.

6.5.3. Measurement the maximum peak output power.

6.6. Test Result

Channel	Frequency (MHz)	Peak Power Output (dBm)	Peak Power Limit (dBm)	Result
0	2402	1.76	30	PASS
19	2440	1.33	30	PASS
39	2480	1.26	30	PASS

The spectrum analyzer plots are attached as below.

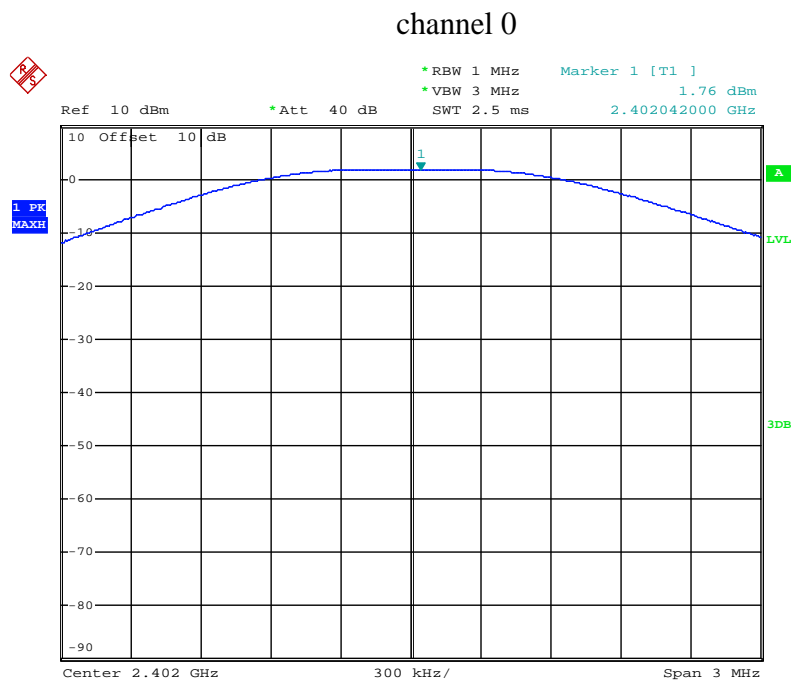

Date: 11.SEP.2018 15:26:00

channel 19

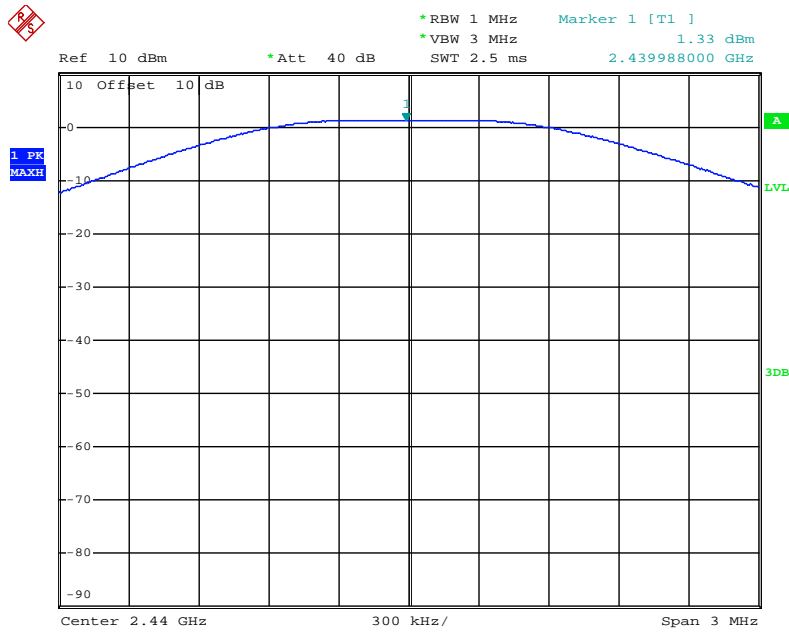

Date: 11.SEP.2018 15:24:54

channel 39

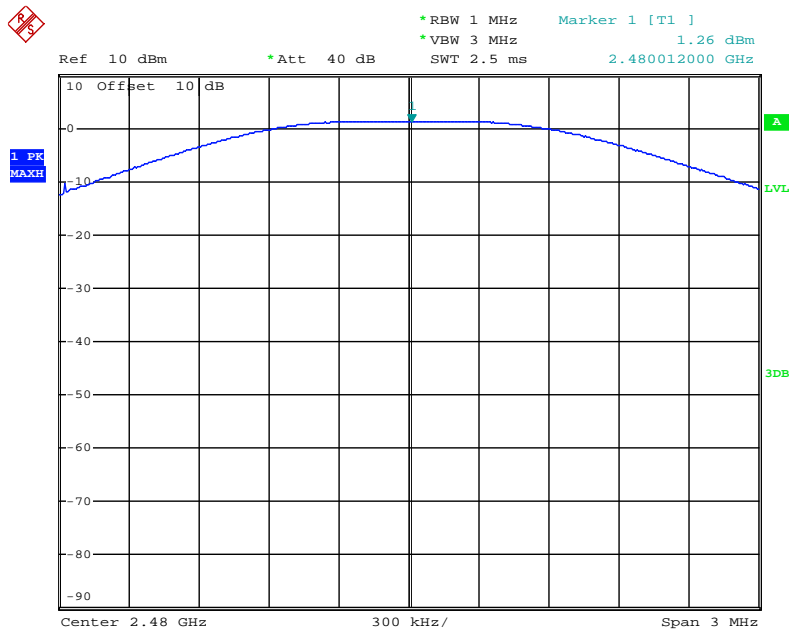

Date: 11.SEP.2018 15:27:59

7. POWER SPECTRAL DENSITY TEST

7.1. Block Diagram of Test Setup

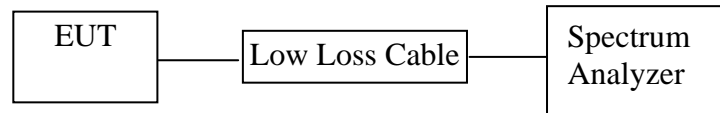

7.2. The Requirement For Section 15.247(e)

Section 15.247(e): For digitally modulated systems, the power spectral density conducted from the intentional radiator to the antenna shall not be greater than 8 dBm in any 3 kHz band during any time interval of continuous transmission.

7.3. EUT Configuration on Measurement

The equipment are installed on the emission Measurement to meet the commission requirements and operating regulations in a manner which tends to maximize its emission characteristics in normal application.

7.4. Operating Condition of EUT

7.4.1. Setup the EUT and simulator as shown as Section 7.1.

7.4.2. Turn on the power of all equipment.

7.4.3. Let the EUT work in TX modes measure it. The transmit frequency are 2402-2480MHz. We select 2402MHz, 2440MHz, and 2480MHz TX frequency to transmit.

7.5. Test Procedure

7.5.1. The transmitter output was connected to the spectrum analyzer through a low loss cable.

7.5.2. Measurement Procedure PKPSD:

7.5.3. This procedure must be used if maximum peak conducted output power was used to demonstrate compliance to the fundamental output power limit, and is optional if the maximum (average) conducted output power was used to demonstrate compliance.

1. Set analyzer center frequency to DTS channel center frequency.
2. Set the span to 1.5 times the DTS channel bandwidth.
3. Set the RBW to: $3 \text{ kHz} \leq \text{RBW} \leq 100 \text{ kHz}$.
4. Set the VBW $\geq 3 \times \text{RBW}$.
5. Detector = peak.
6. Sweep time = auto couple.
7. Trace mode = max hold.
8. Allow trace to fully stabilize.
9. Use the peak marker function to determine the maximum amplitude level.
10. If measured value exceeds limit, reduce RBW (no less than 3kHz) and repeat.

7.5.4. Measurement the maximum power spectral density.

7.6. Test Result

Channel	Frequency (MHz)	PSD (dBm/3KHz)	Limit (dBm/3KHz)	Result
0	2402	-14.59	8	PASS
19	2440	-14.97	8	PASS
39	2480	-14.96	8	PASS

The spectrum analyzer plots are attached as below.

channel 0

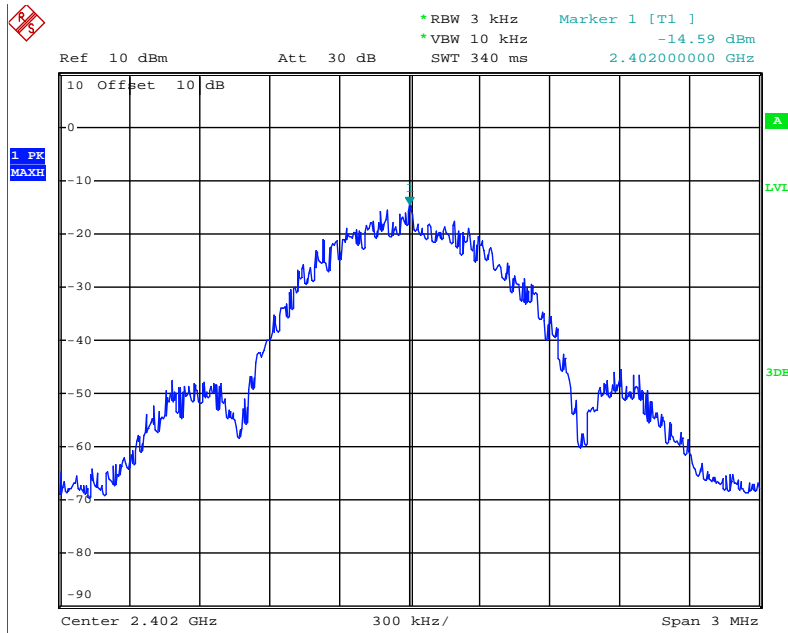

Date: 11.SEP.2018 15:19:38

channel 19

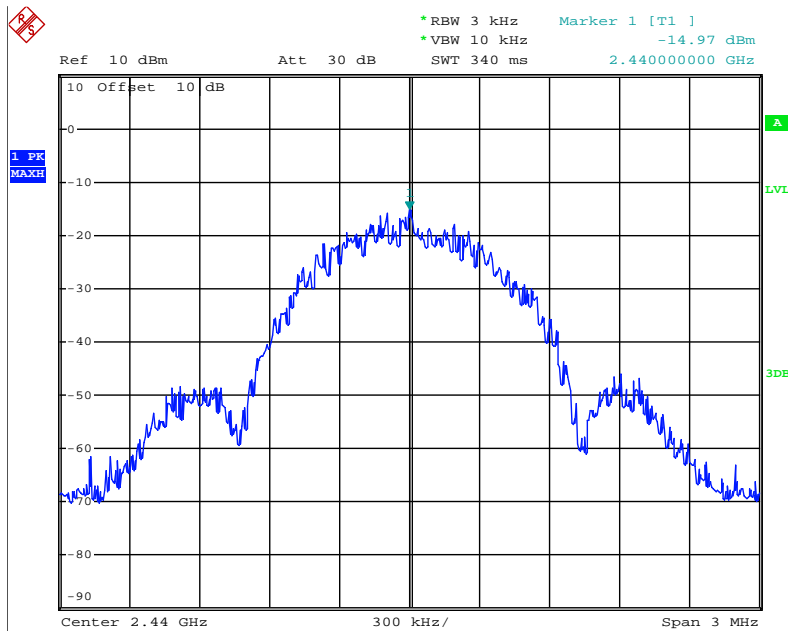

Date: 11.SEP.2018 15:18:58

channel 39

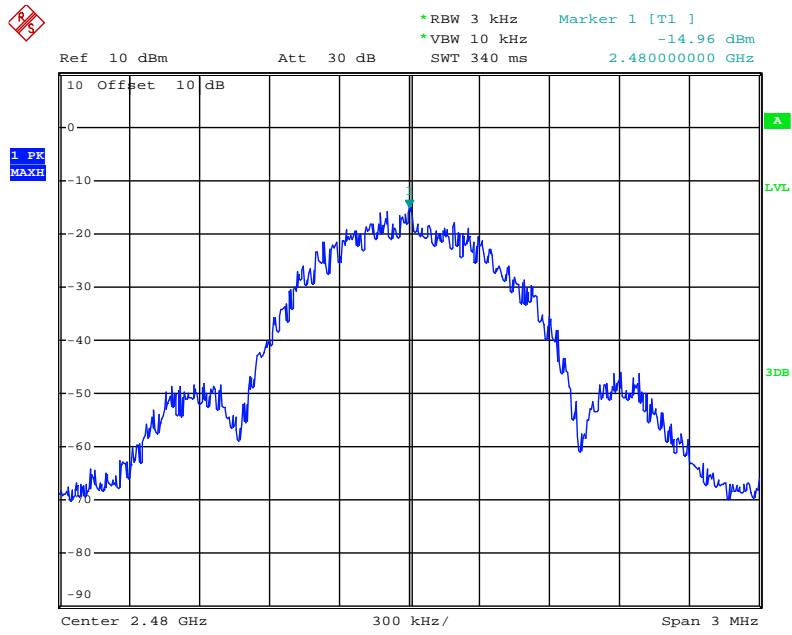

Date: 11.SEP.2018 15:18:15

8. BAND EDGE COMPLIANCE TEST

8.1. Block Diagram of Test Setup

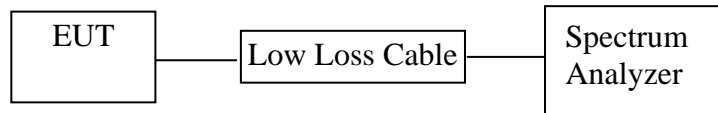

8.2. The Requirement For Section 15.247(d)

Section 15.247(d): In any 100 kHz bandwidth outside the frequency band in which the spread spectrum or digitally modulated intentional radiator is operating, the radio frequency power that is produced by the intentional radiator shall be at least 20 dB below that in the 100 kHz bandwidth within the band that contains the highest level of the desired power, based on either an RF conducted or a radiated measurement, provided the transmitter demonstrates compliance with the peak conducted power limits. If the transmitter complies with the conducted power limits based on the use of RMS averaging over a time interval, as permitted under paragraph (b)(3) of this section, the attenuation required under this paragraph shall be 30 dB instead of 20 dB. Attenuation below the general limits specified in Section 15.209(a) is not required. In addition, radiated emissions which fall in the restricted bands, as defined in Section 15.205(a), must also comply with the radiated emission limits specified in Section 15.209(a).

8.3. EUT Configuration on Measurement

The equipment are installed on the emission Measurement to meet the commission requirements and operating regulations in a manner which tends to maximize its emission characteristics in normal application.

8.4. Operating Condition of EUT

8.4.1. Setup the EUT and simulator as shown as Section 8.1.

8.4.2. Turn on the power of all equipment.

8.4.3. Let the EUT work in TX modes measure it. The transmit frequency are 2402-2480MHz. We select 2402MHz, 2480MHz TX frequency to transmit.

8.5. Test Procedure

Conducted Band Edge:

8.5.1. The transmitter output was connected to the spectrum analyzer via a low loss cable.

8.5.2. Set RBW of spectrum analyzer to 100 kHz and VBW to 300 kHz.

Radiate Band Edge:

8.5.3. The EUT is placed on a turntable, which is 0.1m above the ground plane and worked at highest radiated power.

8.5.4. The turntable was rotated for 360 degrees to determine the position of maximum emission level.

8.5.5. EUT is set 3m away from the receiving antenna, which is varied from 1m to 4m to find out the highest emission.

8.5.6. Set the spectrum analyzer in the following setting in order to capture the lower and upper band-edges of the emission:

8.5.7. RBW=1MHz, VBW=1MHz

8.5.8. The band edges was measured and recorded.

8.6. Test Result

Pass.

Conducted Band Edge Result

Channel	Frequency	Delta peak to band emission	Limit(dBc)
0	2.402GHz	44.95	> 20
39	2.480GHz	45.53	> 20

The spectrum analyzer plots are attached as below.

channel 0

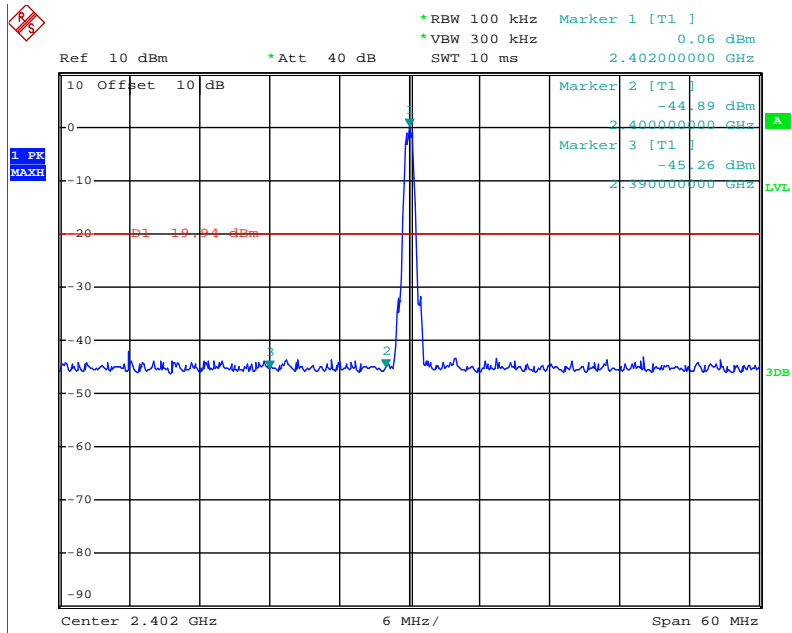

Date: 11.SEP.2018 15:21:22

channel 39

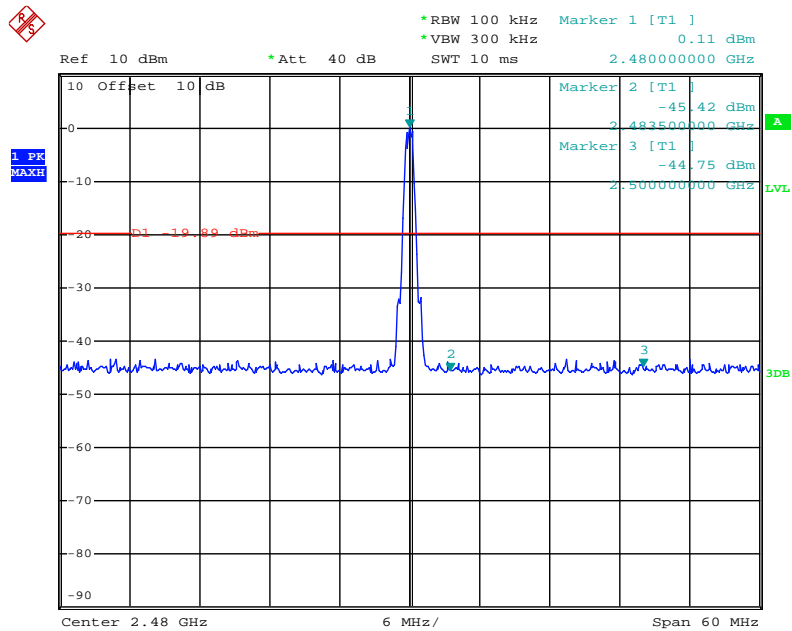

Date: 11.SEP.2018 15:22:46

Radiated Band Edge Result
ACCURATE TECHNOLOGY CO., LTD.

 F1,Bldg,A,Changyuan New Material Port Keyuan Rd,
 Science & Industry Park,Nanshan Shenzhen,P.R.China

Site: 1# Chamber

Tel:+86-0755-26503290

Fax:+86-0755-26503396

Job No.: frank2018 #1467

Standard: FCC PART 15C 3M Radiated

Test item: Radiation Test

Temp.(C)/Hum.(%) 25 C / 55 %

EUT: Msaage Chair

Mode: TX 2402MHz

Model: EC-806A

Manufacturer: XIAMEN COMFORT SCIENCE & TECHNOLOGY GROUP CO., LTD

Polarization: Horizontal

Power Source: AC 120V/60Hz

Date: 18/09/11/

Time: 15/40/39

Engineer Signature:

Distance:

Note: Report NO.:ATE20181011

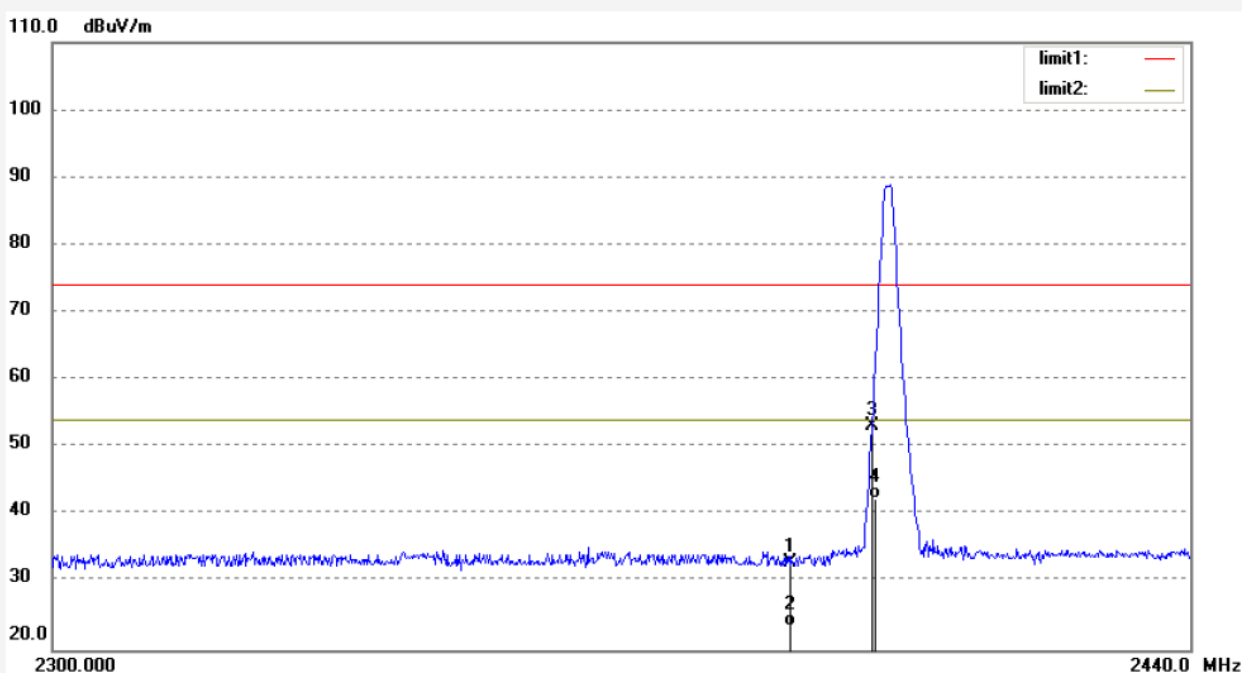

No.	Freq. (MHz)	Reading (dBuV/m)	Factor (dB)	Result (dBuV/m)	Limit (dBuV/m)	Margin (dB)	Detector	Height (cm)	Degree (deg.)	Remark
1	2390.000	40.88	-8.00	32.88	74.00	-41.12	peak	250	102	
2	2390.000	31.45	-8.00	23.45	54.00	-30.55	AVG	200	159	
3	2400.000	61.07	-7.97	53.10	74.00	-20.90	peak	250	45	
4	2400.000	50.42	-7.97	42.45	54.00	-11.55	AVG	200	132	

Job No.: frank2018 #1466

Standard: FCC PART 15C 3M Radiated

Test item: Radiation Test

Temp.(C)/Hum.(%) 25 C / 55 %

EUT: Msaaage Chair

Mode: TX 2402MHz

Model: EC-806A

Manufacturer: XIAMEN COMFORT SCIENCE & TECHNOLOGY GROUP CO., LTD

Polarization: Vertical

Power Source: AC 120V/60Hz

Date: 18/09/11/

Time: 15/39/24

Engineer Signature:

Distance:

Note: Report NO.:ATE20181011

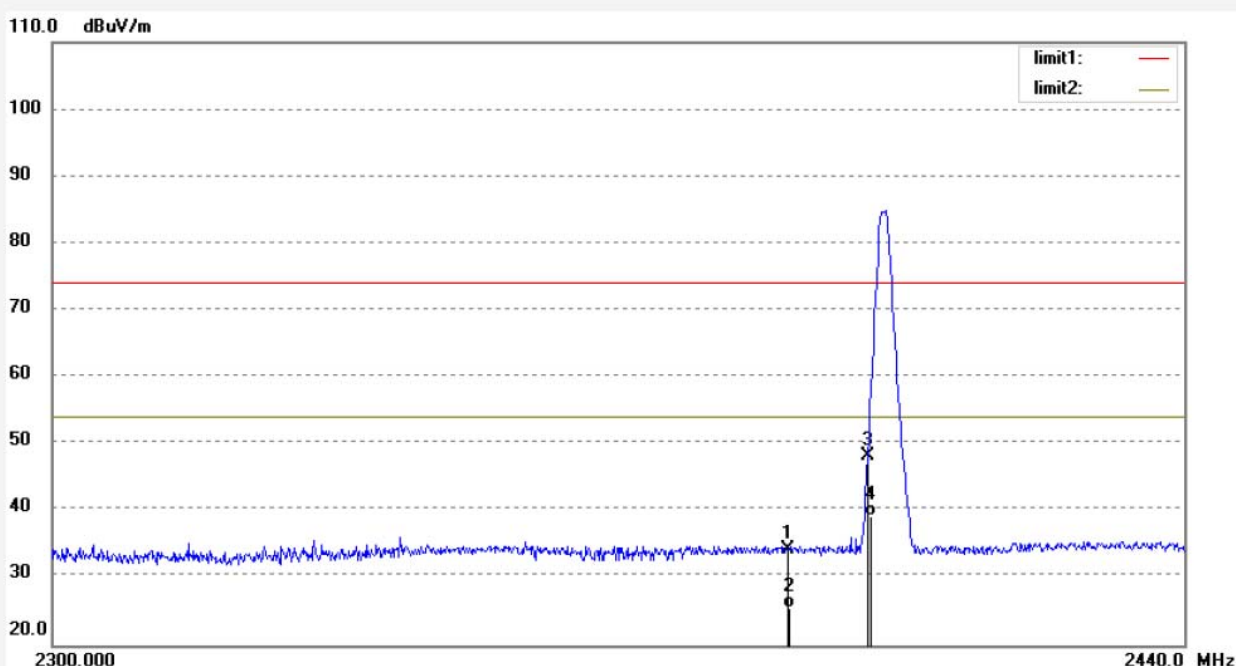

No.	Freq. (MHz)	Reading (dBuV/m)	Factor (dB)	Result (dBuV/m)	Limit (dBuV/m)	Margin (dB)	Detector	Height (cm)	Degree (deg.)	Remark
1	2390.000	42.36	-8.00	34.36	74.00	-39.64	peak	150	233	
2	2390.000	33.45	-8.00	25.45	54.00	-28.55	AVG	150	44	
3	2400.000	56.25	-7.97	48.28	74.00	-25.72	peak	150	154	
4	2400.000	47.12	-7.97	39.15	54.00	-14.85	AVG	150	302	

Job No.: frank2018 #1468

Standard: FCC PART 15C 3M Radiated

Test item: Radiation Test

Temp.(C)/Hum.(%) 25 C / 55 %

EUT: Msaaage Chair

Mode: TX 2480MHz

Model: EC-806A

Manufacturer: XIAMEN COMFORT SCIENCE & TECHNOLOGY GROUP CO., LTD

Polarization: Horizontal

Power Source: AC 120V/60Hz

Date: 18/09/11/

Time: 15/42/35

Engineer Signature:

Distance:

Note: Report NO.:ATE20181011

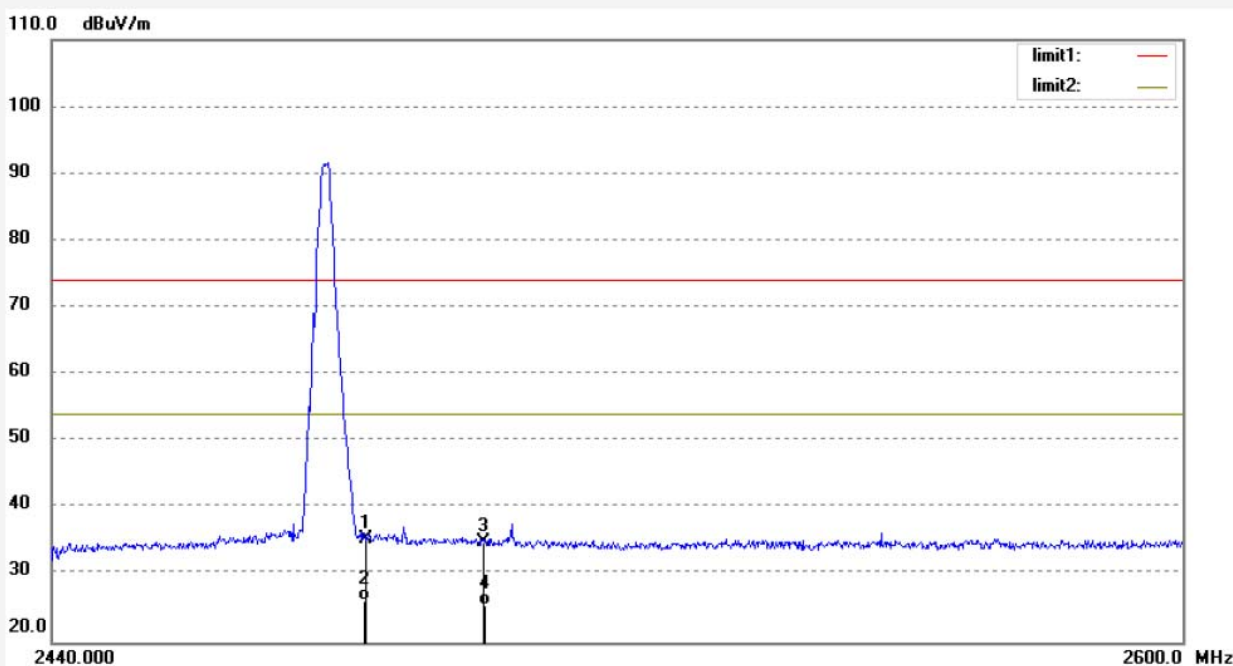

No.	Freq. (MHz)	Reading (dBuV/m)	Factor (dB)	Result (dBuV/m)	Limit (dBuV/m)	Margin (dB)	Detector	Height (cm)	Degree (deg.)	Remark
1	2483.500	43.22	-7.76	35.46	74.00	-38.54	peak	250	55	
2	2483.500	33.89	-7.76	26.13	54.00	-27.87	AVG	200	198	
3	2500.000	42.58	-7.71	34.87	74.00	-39.13	peak	250	151	
4	2500.000	33.16	-7.71	25.45	54.00	-28.55	AVG	250	262	

Job No.: frank2018 #1469

Standard: FCC PART 15C 3M Radiated

Test item: Radiation Test

Temp.(C)/Hum.(%) 25 C / 55 %

EUT: Msaaage Chair

Mode: TX 2480MHz

Model: EC-806A

Manufacturer: XIAMEN COMFORT SCIENCE & TECHNOLOGY GROUP CO., LTD

Polarization: Vertical

Power Source: AC 120V/60Hz

Date: 18/09/11/

Time: 15/44/16

Engineer Signature:

Distance:

Note: Report NO.:ATE20181011

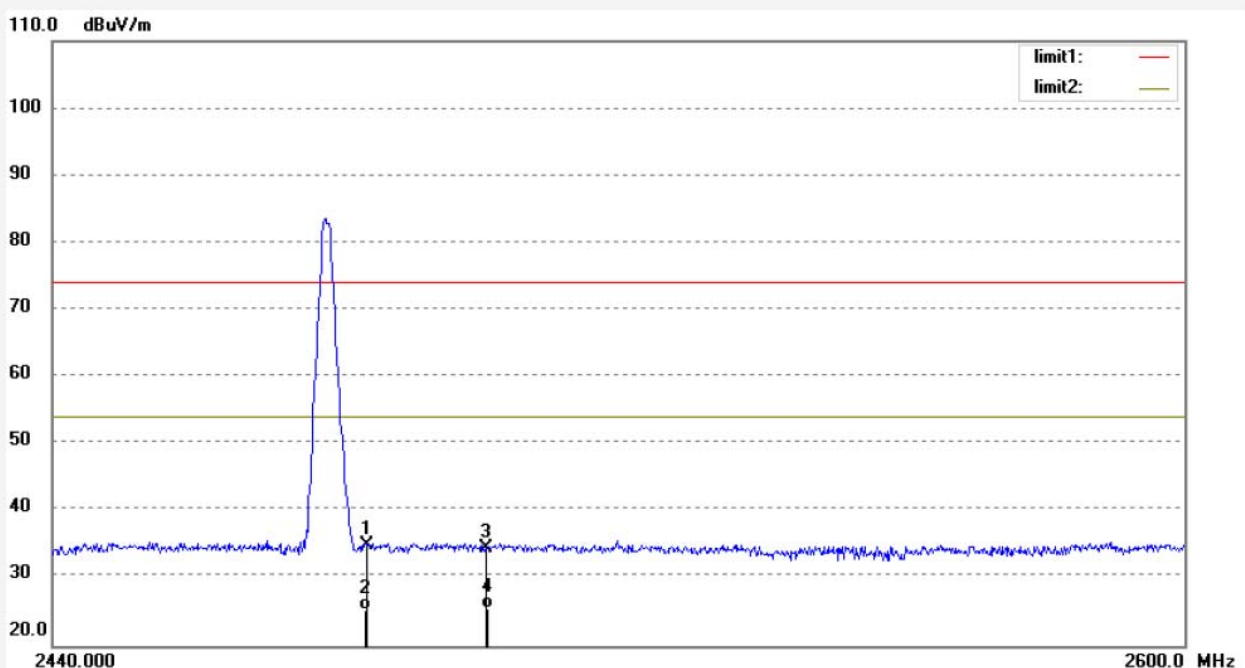

No.	Freq. (MHz)	Reading (dBuV/m)	Factor (dB)	Result (dBuV/m)	Limit (dBuV/m)	Margin (dB)	Detector	Height (cm)	Degree (deg.)	Remark
1	2483.500	42.74	-7.76	34.98	74.00	-39.02	peak	150	42	
2	2483.500	33.15	-7.76	25.39	54.00	-28.61	AVG	150	49	
3	2500.000	42.23	-7.71	34.52	74.00	-39.48	peak	150	125	
4	2500.000	33.12	-7.71	25.41	54.00	-28.59	AVG	150	320	

Note:

1. Emissions attenuated more than 20 dB below the permissible value are not reported.
2. The field strength is calculated by adding the antenna factor, high pass filter loss(if used) and cable loss, and subtracting the amplifier gain(if any)from the measured reading. The basic equation calculation is as follows:

$$\text{Result} = \text{Reading} + \text{Corrected Factor}$$

9. RADIATED SPURIOUS EMISSION TEST

9.1. Block Diagram of Test Setup

9.1.1. Block diagram of connection between the EUT and peripherals

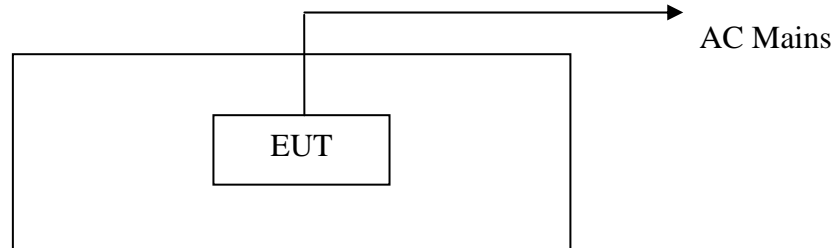

Setup: Transmitting mode

9.1.2. Semi-Anechoic Chamber Test Setup Diagram

(A) Radiated Emission Test Set-Up, Frequency below 30MHz

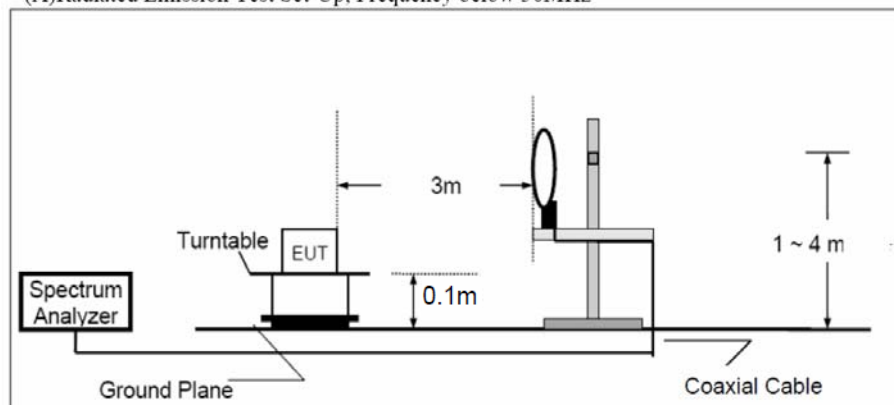

(B) Radiated Emission Test Set-Up, Frequency 30MHz-1GHz

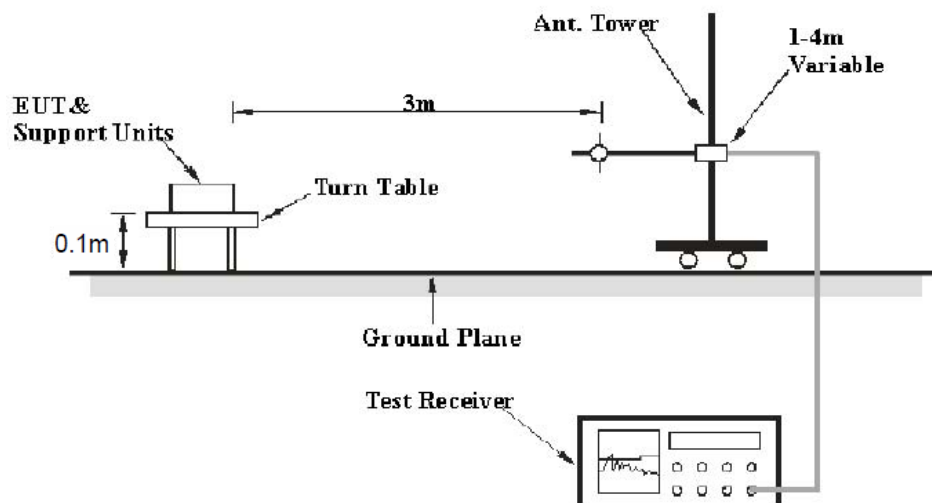

(C) Radiated Emission Test Set-Up, Frequency above 1GHz

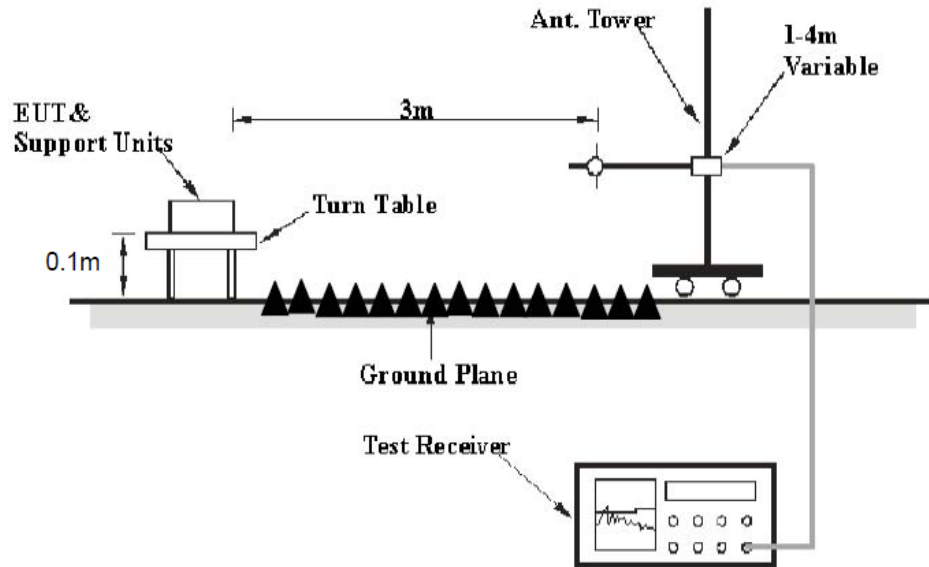

9.2. The Limit For Section 15.247(d)

Section 15.247(d): In any 100 kHz bandwidth outside the frequency band in which the spread spectrum or digitally modulated intentional radiator is operating, the radio frequency power that is produced by the intentional radiator shall be at least 20 dB below that in the 100 kHz bandwidth within the band that contains the highest level of the desired power, based on either an RF conducted or a radiated measurement, provided the transmitter demonstrates compliance with the peak conducted power limits. If the transmitter complies with the conducted power limits based on the use of RMS averaging over a time interval, as permitted under paragraph (b)(3) of this section, the attenuation required under this paragraph shall be 30 dB instead of 20 dB. Attenuation below the general limits specified in Section 15.209(a) is not required. In addition, radiated emissions which fall in the restricted bands, as defined in Section 15.205(a), must also comply with the radiated emission limits specified in Section 15.209(a).

9.3. Restricted bands of operation

9.3.1.FCC Part 15.205 Restricted bands of operation

(a) Except as shown in paragraph (d) of this section, Only spurious emissions are permitted in any of the frequency bands listed below:

MHz	MHz	MHz	GHz
0.090-0.110	16.42-16.423	399.9-410	4.5-5.15
¹ 0.495-0.505	16.69475-16.69525	608-614	5.35-5.46
2.1735-2.1905	16.80425-16.80475	960-1240	7.25-7.75
4.125-4.128	25.5-25.67	1300-1427	8.025-8.5
4.17725-4.17775	37.5-38.25	1435-1626.5	9.0-9.2
4.20725-4.20775	73-74.6	1645.5-1646.5	9.3-9.5
6.215-6.218	74.8-75.2	1660-1710	10.6-12.7
6.26775-6.26825	108-121.94	1718.8-1722.2	13.25-13.4
6.31175-6.31225	123-138	2200-2300	14.47-14.5
8.291-8.294	149.9-150.05	2310-2390	15.35-16.2
8.362-8.366	156.52475-156.52525	2483.5-2500	17.7-21.4
8.37625-8.38675	156.7-156.9	2690-2900	22.01-23.12
8.41425-8.41475	162.0125-167.17	3260-3267	23.6-24.0
12.29-12.293	167.72-173.2	3332-3339	31.2-31.8
12.51975-12.52025	240-285	3345.8-3358	36.43-36.5
12.57675-12.57725	322-335.4	3600-4400	(²)
13.36-13.41			

¹Until February 1, 1999, this restricted band shall be 0.490-0.510

²Above 38.6

(b) Except as provided in paragraphs (d) and (e), the field strength of emission appearing within these frequency bands shall not exceed the limits shown in Section 15.209. At frequencies equal to or less than 1000MHz, Compliance with the limits in Section 15.209 shall be demonstrated using measurement instrumentation employing a CISPR quasi-peak detector. Above 1000MHz, compliance with the emission limits in Section 15.209 shall be demonstrated based on the average value of the measured emissions. The provisions in Section 15.35 apply to these measurements.

9.4.Configuration of EUT on Measurement

The equipment are installed on Radiated Emission Measurement to meet the commission requirements and operating regulations in a manner which tends to maximize its emission characteristics in normal application.

9.5. Operating Condition of EUT

9.5.1. Setup the EUT and simulator as shown as Section 9.1.

9.5.2. Turn on the power of all equipment.

9.5.3. Let the EUT work in TX modes measure it. The transmit frequency are 2402-2480MHz. We select 2402MHz, 2440MHz, and 2480MHz TX frequency to transmit.

9.6. Test Procedure

The EUT and its simulators are placed on a turntable, which is 0.1 meter high above ground. The turntable can rotate 360 degrees to determine the position of the maximum emission level. EUT is set 3.0 meters away from the receiving antenna, which is mounted on an antenna tower. The antenna can be moved up and down between 1.0 meter and 4 meters to find out the maximum emission level. Broadband antenna (calibrated bi-log antenna) is used as receiving antenna. Both horizontal and vertical polarizations of the antenna are set on measurement. In order to find the maximum emission levels, all of the EUT location must be manipulated according to ANSI C63.10:2013 on radiated emission measurement. This EUT was tested in 3 orthogonal positions and the worst case position data was reported.

The bandwidth of test receiver is set at 9 kHz in below 30MHz. and set at 120 kHz in 30-1000MHz, and 1MHz in above 1000MHz.

The final measurement in band 9-90 kHz, 110-490 kHz and above 1000MHz is performed with Average detector. Except those frequency bands mention above, the final measurement for frequencies below 1000MHz is performed with Quasi Peak detector. The field strength is calculated by adding the antenna factor, and cable loss, and subtracting the amplifier gain from the measured reading.

9.7.Data Sample

Frequency (MHz)	Reading (dB μ v)	Factor (dB/m)	Result (dB μ v/m)	Limit (dB μ v/m)	Margin (dB)	Remark
X.XX	43.85	-22.22	21.63	43.5	-21.87	QP

Frequency(MHz) = Emission frequency in MHz

Reading(dB μ v) = Uncorrected Analyzer/Receiver reading

Factor (dB/m) = Antenna factor + Cable Loss – Amplifier gain

Result(dB μ v/m) = Reading(dB μ v) + Factor(dB/m)

Limit (dB μ v/m) = Limit stated in standard

Margin (dB) = Result(dB μ v/m) - Limit (dB μ v/m)

QP = Quasi-peak Reading

Calculation Formula:

Margin(dB) = Result (dB μ V/m)–Limit(dB μ V/m)

Result(dB μ V/m)= Reading(dB μ V)+ Factor(dB/m)

The “Margin” column of the following data tables indicates the degree of compliance with the applicable limit. For example, a margin of -7dB means the emission is 7dB below the limit.

9.8.The Field Strength of Radiation Emission Measurement Results

Pass.

Testing is carried out with frequency rang 9kHz to the tenth harmonics, which above 3th Harmonics are attenuated more than 20dB below the permissible limits or the field strength is too small to be measured.

The measurements greater than 20dB below the limit from 9kHz to 30MHz and 18 to 26.5GHz.

The spectrum analyzer plots are attached as below.

Below 1GHz



ACCURATE TECHNOLOGY CO., LTD.

F1,Bldg,A,Changyuan New Material Port Keyuan Rd,
Science & Industry Park,Nanshan Shenzhen,P.R.China

Site: 1# Chamber

Tel:+86-0755-26503290

Fax:+86-0755-26503396

Job No.: frank2018 #1430	Polarization: Horizontal
Standard: FCC PART 15C 3M Radiated	Power Source: AC 120V/60Hz
Test item: Radiation Test	Date: 18/09/11/
Temp.(C)/Hum.(%) 25 C / 55 %	Time: 10/14/35
EUT: Msaaage Chair	Engineer Signature:
Mode: TX 2402MHz	Distance:
Model: EC-806A	
Manufacturer: XIAMEN COMFORT SCIENCE & TECHNOLOGY GROUP CO., LTD	

Note: Report NO.:ATE20181011

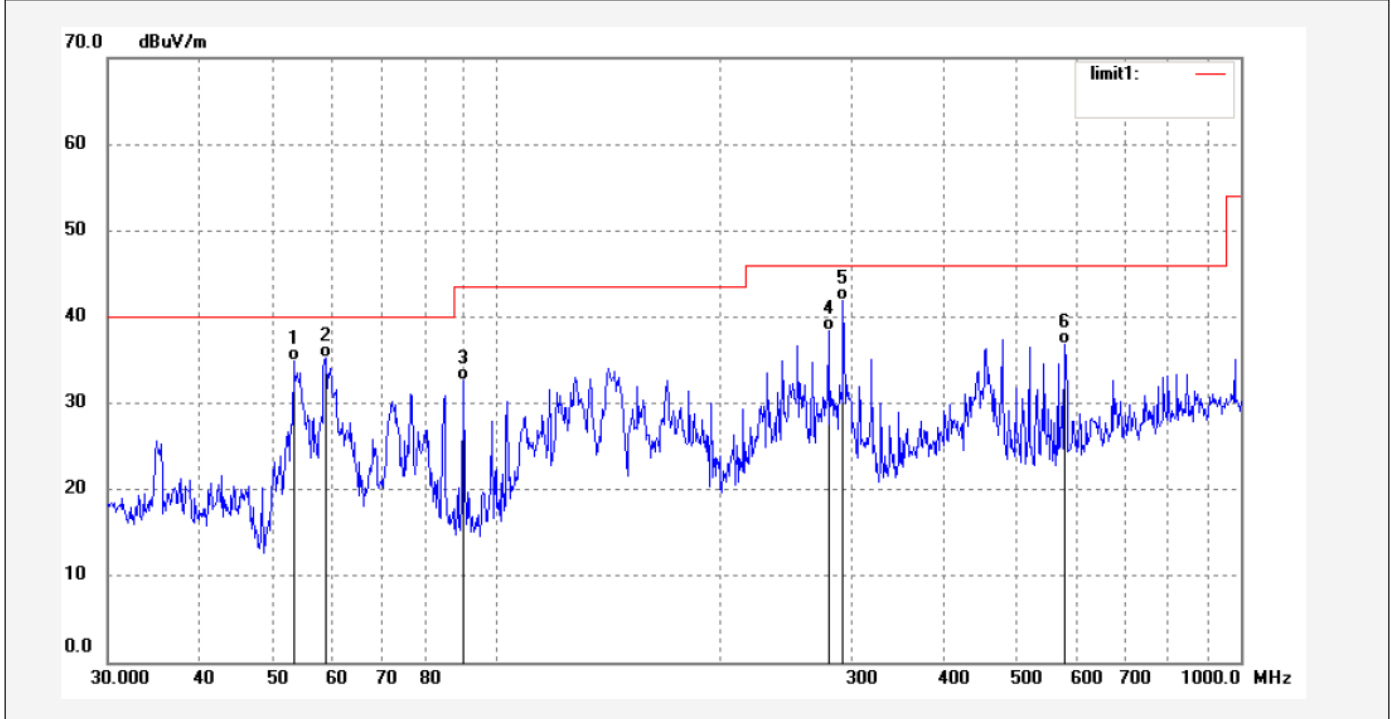

No.	Freq. (MHz)	Reading (dBuV/m)	Factor (dB)	Result (dBuV/m)	Limit (dBuV/m)	Margin (dB)	Detector	Height (cm)	Degree (deg.)	Remark
1	53.3793	55.75	-20.86	34.89	40.00	-5.11	QP	200	141	
2	58.8977	57.80	-22.56	35.24	40.00	-4.76	QP	200	66	
3	90.4196	54.50	-21.91	32.59	43.50	-10.91	QP	200	136	
4	279.3104	55.11	-16.73	38.38	46.00	-7.62	QP	200	46	
5	292.3643	58.43	-16.45	41.98	46.00	-4.02	QP	200	297	
6	580.0705	47.26	-10.37	36.89	46.00	-9.11	QP	200	103	

Job No.: frank2018 #1431

Standard: FCC PART 15C 3M Radiated

Test item: Radiation Test

Temp.(C)/Hum.(%) 25 C / 55 %

EUT: Msaaage Chair

Mode: TX 2402MHz

Model: EC-806A

Manufacturer: XIAMEN COMFORT SCIENCE & TECHNOLOGY GROUP CO., LTD

Polarization: Vertical

Power Source: AC 120V/60Hz

Date: 18/09/11/

Time: 10/15/30

Engineer Signature:

Distance:

Note: Report NO.:ATE20181011

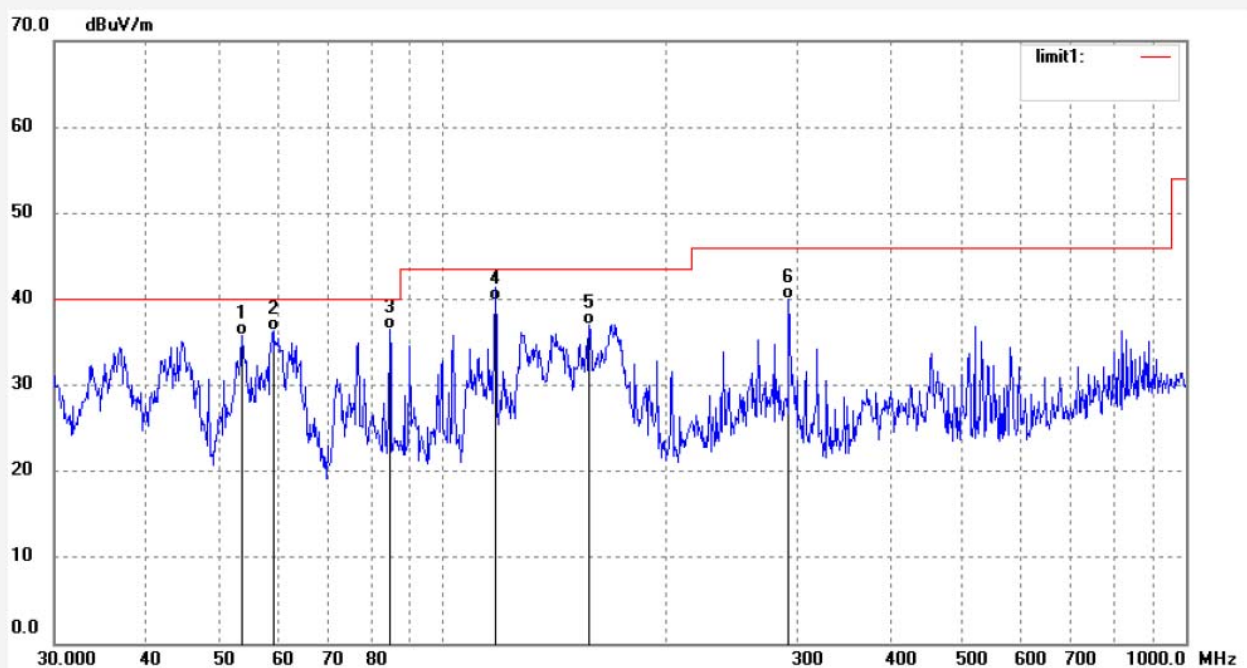

No.	Freq. (MHz)	Reading (dBuV/m)	Factor (dB)	Result (dBuV/m)	Limit (dBuV/m)	Margin (dB)	Detector	Height (cm)	Degree (deg.)	Remark
1	53.7558	56.74	-20.87	35.87	40.00	-4.13	QP	100	302	
2	59.1052	58.91	-22.57	36.34	40.00	-3.66	QP	100	156	
3	84.8782	58.86	-22.44	36.42	40.00	-3.58	QP	100	49	
4	117.6813	61.12	-21.27	39.85	43.50	-3.65	QP	100	116	
5	157.5288	58.66	-21.61	37.05	43.50	-6.45	QP	100	66	
6	292.3643	56.48	-16.45	40.03	46.00	-5.97	QP	100	49	

Job No.: frank2018 #1433

Standard: FCC PART 15C 3M Radiated

Test item: Radiation Test

Temp.(C)/Hum.(%) 25 C / 55 %

EUT: Msaaage Chair

Mode: TX 2440MHz

Model: EC-806A

Manufacturer: XIAMEN COMFORT SCIENCE & TECHNOLOGY GROUP CO., LTD

Polarization: Horizontal

Power Source: AC 120V/60Hz

Date: 18/09/11/

Time: 10/16/25

Engineer Signature:

Distance:

Note: Report NO.:ATE20181011

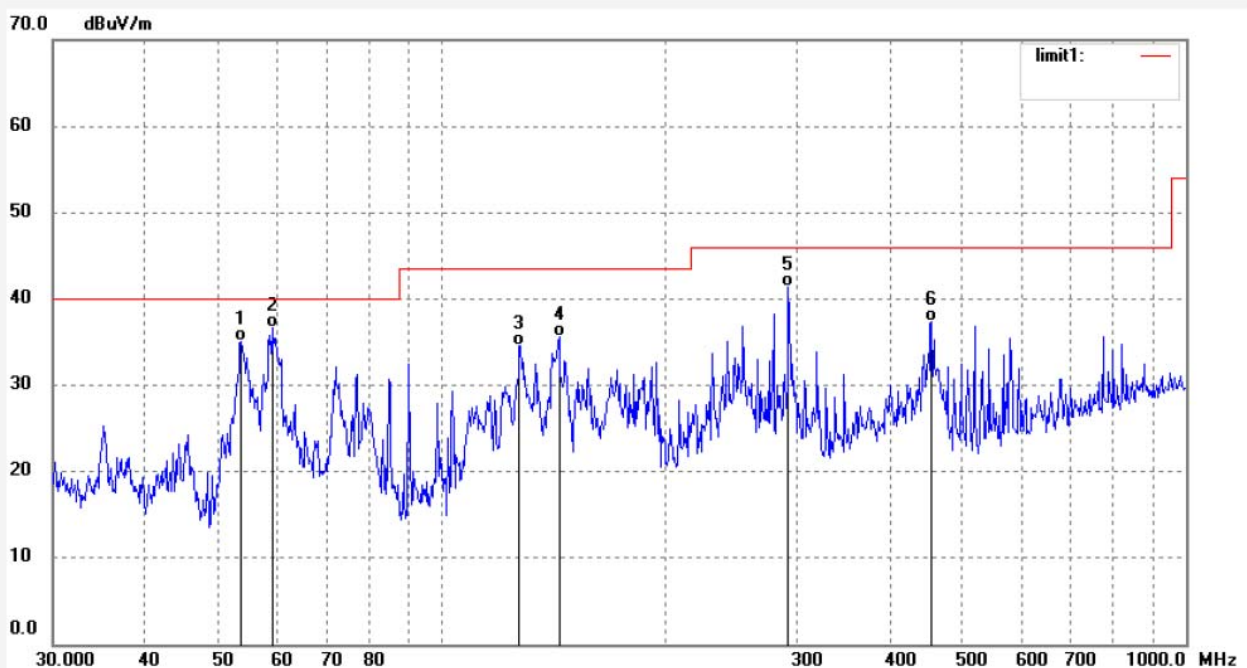

No.	Freq. (MHz)	Reading (dBuV/m)	Factor (dB)	Result (dBuV/m)	Limit (dBuV/m)	Margin (dB)	Detector	Height (cm)	Degree (deg.)	Remark
1	53.7558	55.96	-20.87	35.09	40.00	-4.91	QP	200	126	
2	59.1052	59.17	-22.57	36.60	40.00	-3.40	QP	200	260	
3	127.1389	56.27	-21.63	34.64	43.50	-8.86	QP	200	124	
4	143.7760	57.79	-22.20	35.59	43.50	-7.91	QP	200	69	
5	292.3643	57.81	-16.45	41.36	46.00	-4.64	QP	200	56	
6	455.1888	50.19	-12.87	37.32	46.00	-8.68	QP	200	126	

Job No.: frank2018 #1432

Standard: FCC PART 15C 3M Radiated

Test item: Radiation Test

Temp.(C)/Hum.(%) 25 C / 55 %

EUT: Msaaage Chair

Mode: TX 2440MHz

Model: EC-806A

Manufacturer: XIAMEN COMFORT SCIENCE & TECHNOLOGY GROUP CO., LTD

Polarization: Vertical

Power Source: AC 120V/60Hz

Date: 18/09/11/

Time: 10/15/43

Engineer Signature:

Distance:

Note: Report NO.:ATE20181011

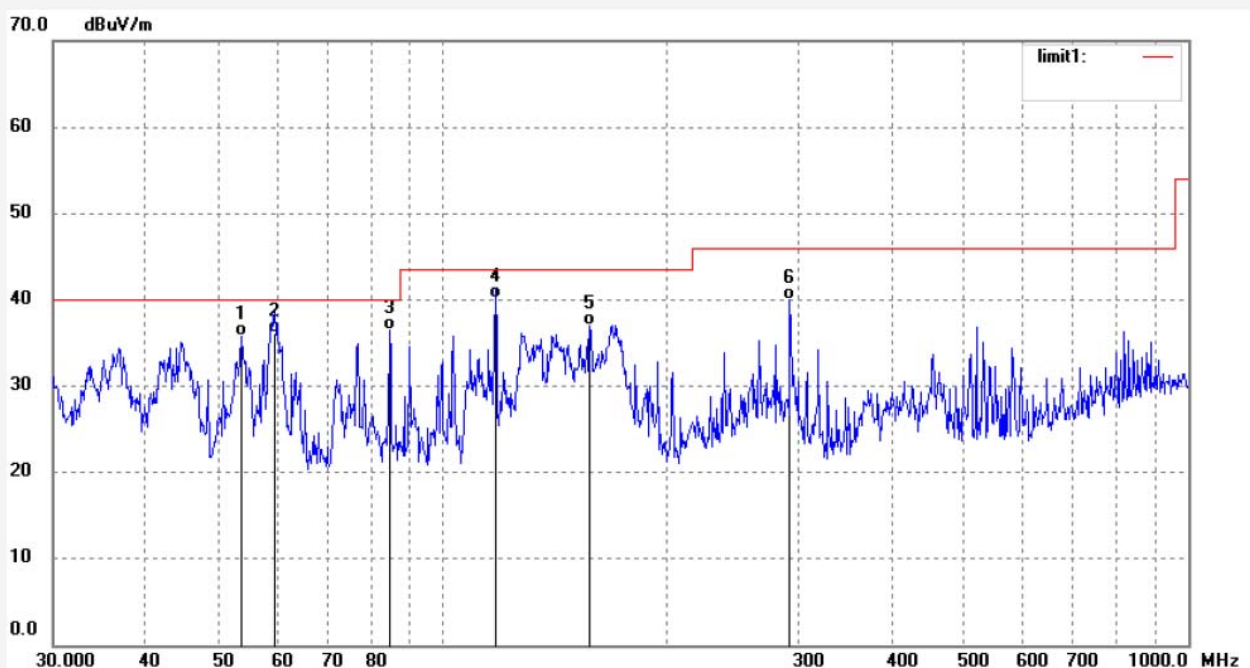

No.	Freq. (MHz)	Reading (dBuV/m)	Factor (dB)	Result (dBuV/m)	Limit (dBuV/m)	Margin (dB)	Detector	Height (cm)	Degree (deg.)	Remark
1	53.7558	56.74	-20.87	35.87	40.00	-4.13	QP	100	302	
2	59.5219	58.65	-22.58	36.07	40.00	-3.93	QP	100	156	
3	84.8782	58.86	-22.44	36.42	40.00	-3.58	QP	100	100	
4	117.6813	61.49	-21.27	40.22	43.50	-3.28	QP	100	91	
5	157.5288	58.66	-21.61	37.05	43.50	-6.45	QP	100	314	
6	292.3643	56.48	-16.45	40.03	46.00	-5.97	QP	100	59	

Job No.: frank2018 #1434

Standard: FCC PART 15C 3M Radiated

Test item: Radiation Test

Temp.(C)/Hum.(%) 25 C / 55 %

EUT: Msaaage Chair

Mode: TX 2480MHz

Model: EC-806A

Manufacturer: XIAMEN COMFORT SCIENCE & TECHNOLOGY GROUP CO., LTD

Polarization: Horizontal

Power Source: AC 120V/60Hz

Date: 18/09/11/

Time: 10/16/37

Engineer Signature:

Distance:

Note: Report NO.:ATE20181011

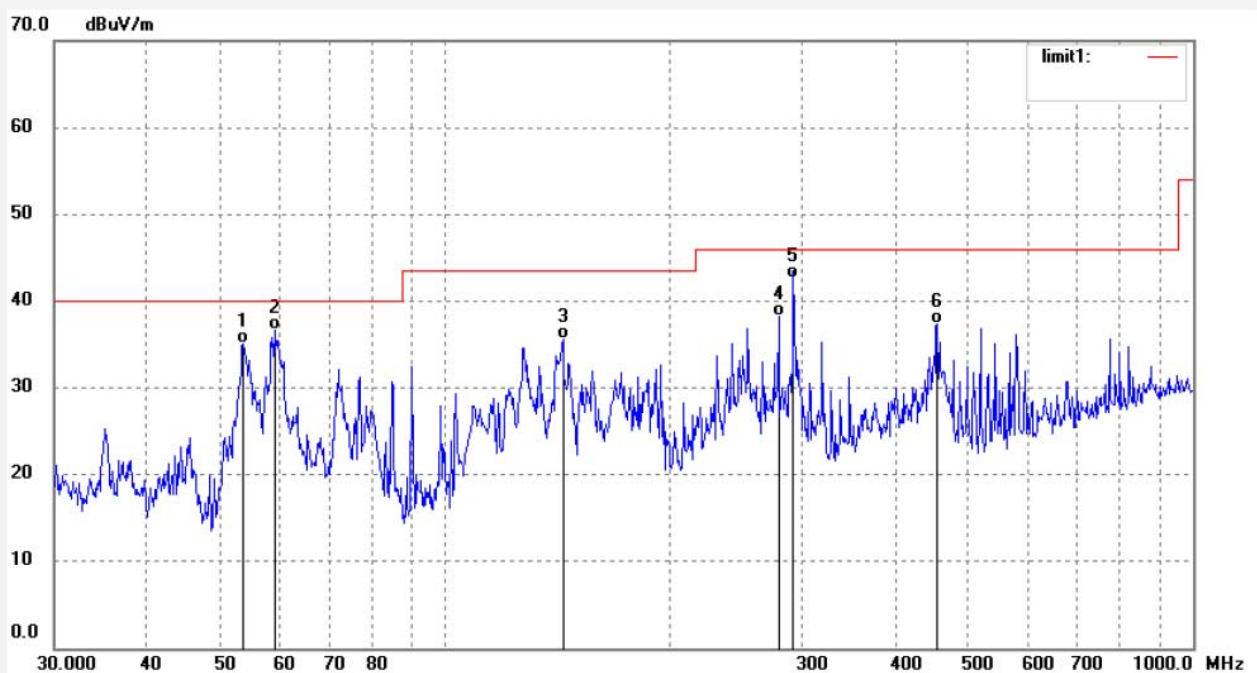

No.	Freq. (MHz)	Reading (dBuV/m)	Factor (dB)	Result (dBuV/m)	Limit (dBuV/m)	Margin (dB)	Detector	Height (cm)	Degree (deg.)	Remark
1	53.7558	55.96	-20.87	35.09	40.00	-4.91	QP	200	130	
2	59.1052	59.17	-22.57	36.60	40.00	-3.40	QP	200	199	
3	143.7760	57.79	-22.20	35.59	43.50	-7.91	QP	200	169	
4	279.3104	54.93	-16.73	38.20	46.00	-7.80	QP	200	62	
5	292.3643	59.12	-16.45	42.67	46.00	-3.33	QP	200	133	
6	455.1888	50.19	-12.87	37.32	46.00	-8.68	QP	200	201	

Job No.: frank2018 #1435

Standard: FCC PART 15C 3M Radiated

Test item: Radiation Test

Temp.(C)/Hum.(%) 25 C / 55 %

EUT: Msaaage Chair

Mode: TX 2480MHz

Model: EC-806A

Manufacturer: XIAMEN COMFORT SCIENCE & TECHNOLOGY GROUP CO., LTD

Polarization: Vertical

Power Source: AC 120V/60Hz

Date: 18/09/11/

Time: 10/17/27

Engineer Signature:

Distance:

Note: Report NO.:ATE20181011

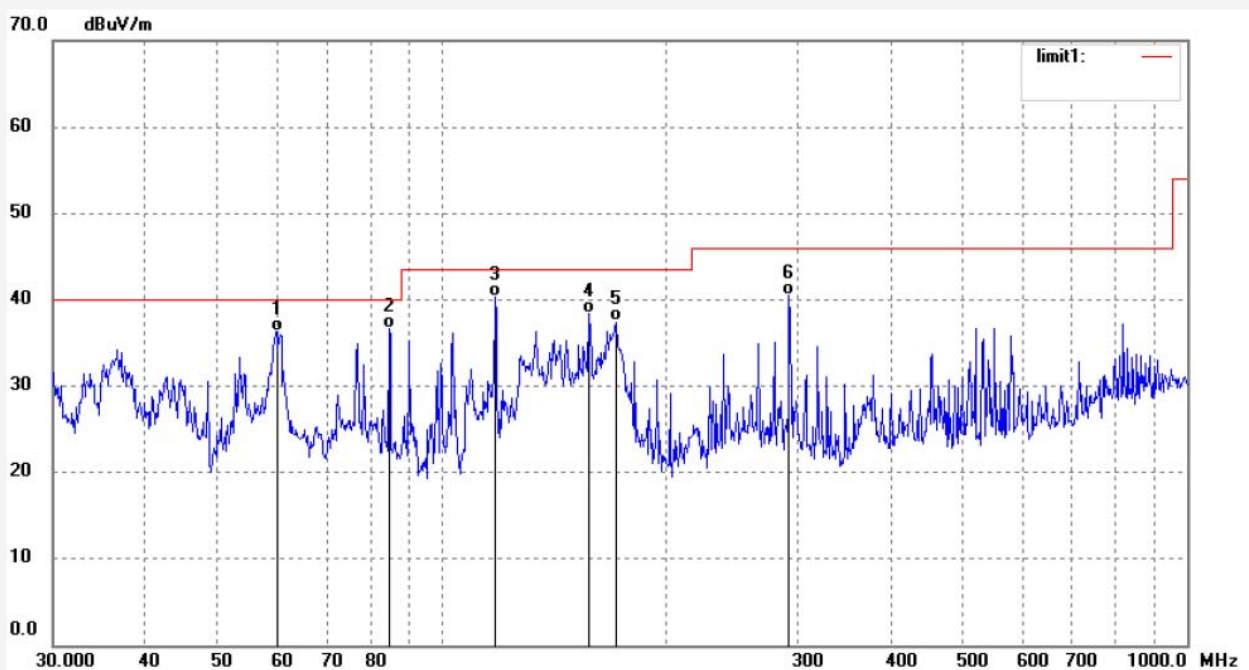

No.	Freq. (MHz)	Reading (dBuV/m)	Factor (dB)	Result (dBuV/m)	Limit (dBuV/m)	Margin (dB)	Detector	Height (cm)	Degree (deg.)	Remark
1	59.9418	58.98	-22.60	36.38	40.00	-3.62	QP	100	302	
2	84.8782	59.05	-22.44	36.61	40.00	-3.39	QP	100	115	
3	117.6813	61.55	-21.27	40.28	43.50	-3.22	QP	100	220	
4	157.5288	59.97	-21.61	38.36	43.50	-5.14	QP	100	194	
5	171.3890	57.88	-20.43	37.45	43.50	-6.05	QP	100	336	
6	292.3643	56.91	-16.45	40.46	46.00	-5.54	QP	100	232	

Above 1GHz

ACCURATE TECHNOLOGY CO., LTD.

 F1,Bldg,A,Changyuan New Material Port Keyuan Rd,
 Science & Industry Park,Nanshan Shenzhen,P.R.China

Site: 1# Chamber

Tel:+86-0755-26503290

Fax:+86-0755-26503396

Job No.: frank2018 #1436

Standard: FCC PART 15C 3M Radiated

Test item: Radiation Test

Temp.(C)/Hum.(%) 25 C / 55 %

EUT: Msaage Chair

Mode: TX 2402MHz

Model: EC-806A

Manufacturer: XIAMEN COMFORT SCIENCE & TECHNOLOGY GROUP CO., LTD

Polarization: Horizontal

Power Source: AC 120V/60Hz

Date: 18/09/11/

Time: 14/33/46

Engineer Signature:

Distance:

Note: Report NO.:ATE20181011

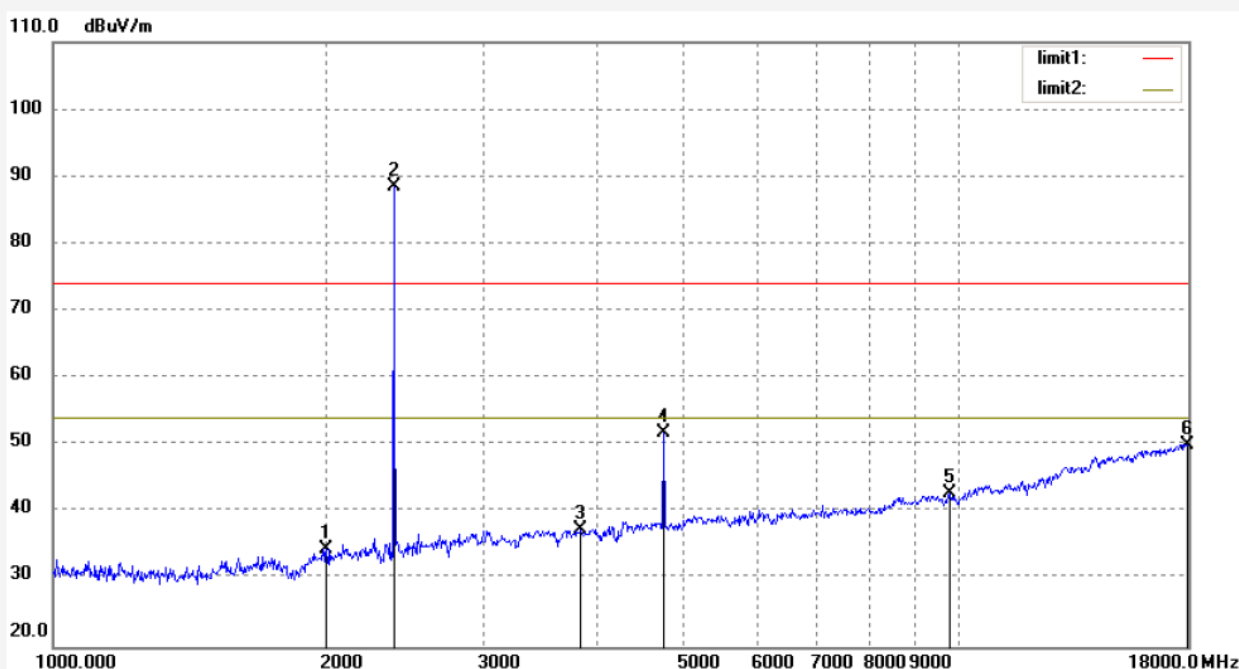

No.	Freq. (MHz)	Reading (dBuV/m)	Factor (dB)	Result (dBuV/m)	Limit (dBuV/m)	Margin (dB)	Detector	Height (cm)	Degree (deg.)	Remark
1	2005.049	43.54	-9.01	34.53	74.00	-39.47	peak	250	169	
2	2402.719	96.51	-8.03	88.48			peak	250	35	
3	3837.285	41.02	-3.69	37.33	74.00	-36.67	peak	250	169	
4	4804.057	54.29	-2.53	51.76			peak	250	49	
5	9796.504	37.29	5.46	42.75	74.00	-31.25	peak	250	122	
6	17947.683	30.79	19.32	50.11	74.00	-23.89	peak	250	302	

Job No.: frank2018 #1437

Standard: FCC PART 15C 3M Radiated

Test item: Radiation Test

Temp.(C)/Hum.(%) 25 C / 55 %

EUT: Msaaage Chair

Mode: TX 2402MHz

Model: EC-806A

Manufacturer: XIAMEN COMFORT SCIENCE & TECHNOLOGY GROUP CO., LTD

Polarization: Vertical

Power Source: AC 120V/60Hz

Date: 18/09/11/

Time: 14/35/11

Engineer Signature:

Distance:

Note: Report NO.:ATE20181011

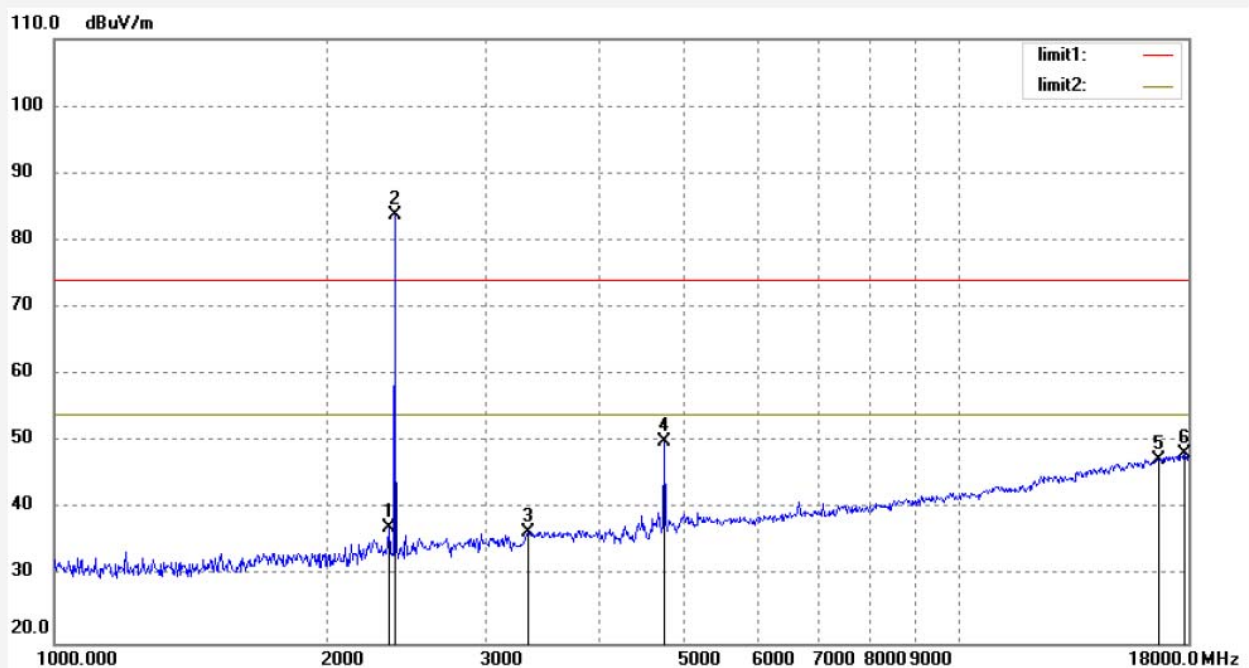

No.	Freq. (MHz)	Reading (dBuV/m)	Factor (dB)	Result (dBuV/m)	Limit (dBuV/m)	Margin (dB)	Detector	Height (cm)	Degree (deg.)	Remark
1	2346.322	45.28	-8.11	37.17	74.00	-36.83	peak	150	69	
2	2402.019	91.87	-8.03	83.84			peak	150	166	
3	3346.651	41.65	-5.02	36.63	74.00	-37.37	peak	150	147	
4	4804.057	52.58	-2.53	50.05			peak	150	49	
5	16688.041	33.43	13.93	47.36	74.00	-26.64	peak	150	156	
6	17843.504	29.41	18.80	48.21	74.00	-25.79	peak	150	302	

Job No.: frank2018 #1439

Standard: FCC PART 15C 3M Radiated

Test item: Radiation Test

Temp.(C)/Hum.(%) 25 C / 55 %

EUT: Msaaage Chair

Mode: TX 2440MHz

Model: EC-806A

Manufacturer: XIAMEN COMFORT SCIENCE & TECHNOLOGY GROUP CO., LTD

Polarization: Horizontal

Power Source: AC 120V/60Hz

Date: 18/09/11/

Time: 14/37/50

Engineer Signature:

Distance:

Note: Report NO.:ATE20181011

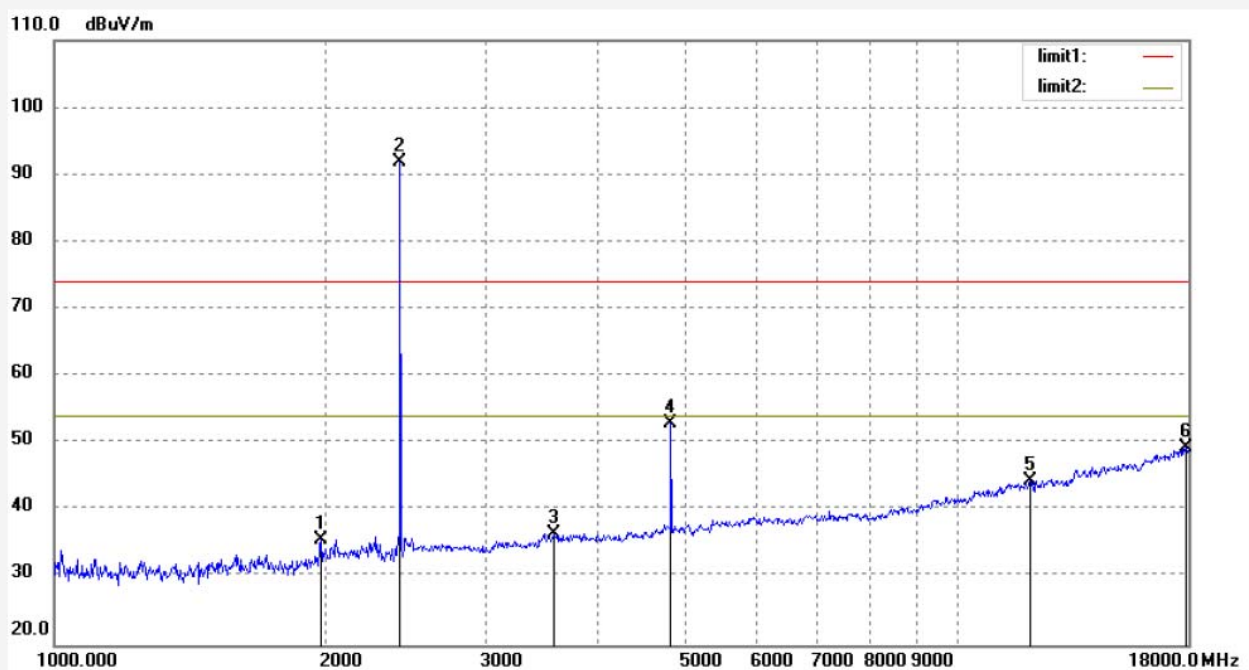

No.	Freq. (MHz)	Reading (dBuV/m)	Factor (dB)	Result (dBuV/m)	Limit (dBuV/m)	Margin (dB)	Detector	Height (cm)	Degree (deg.)	Remark
1	1976.079	44.69	-9.12	35.57	74.00	-38.43	peak	250	333	
2	2440.021	99.79	-7.93	91.86			peak	250	201	
3	3578.369	40.76	-4.31	36.45	74.00	-37.55	peak	250	136	
4	4880.324	55.15	-2.25	52.90			peak	250	41	
5	12010.460	37.29	7.18	44.47	74.00	-29.53	peak	250	236	
6	17895.518	30.31	19.06	49.37	74.00	-24.63	peak	250	198	

Job No.: frank2018 #1438

Standard: FCC PART 15C 3M Radiated

Test item: Radiation Test

Temp.(C)/Hum.(%) 25 C / 55 %

EUT: Msaaage Chair

Mode: TX 2440MHz

Model: EC-806A

Manufacturer: XIAMEN COMFORT SCIENCE & TECHNOLOGY GROUP CO., LTD

Polarization: Vertical

Power Source: AC 120V/60Hz

Date: 18/09/11/

Time: 14/36/41

Engineer Signature:

Distance:

Note: Report NO.:ATE20181011

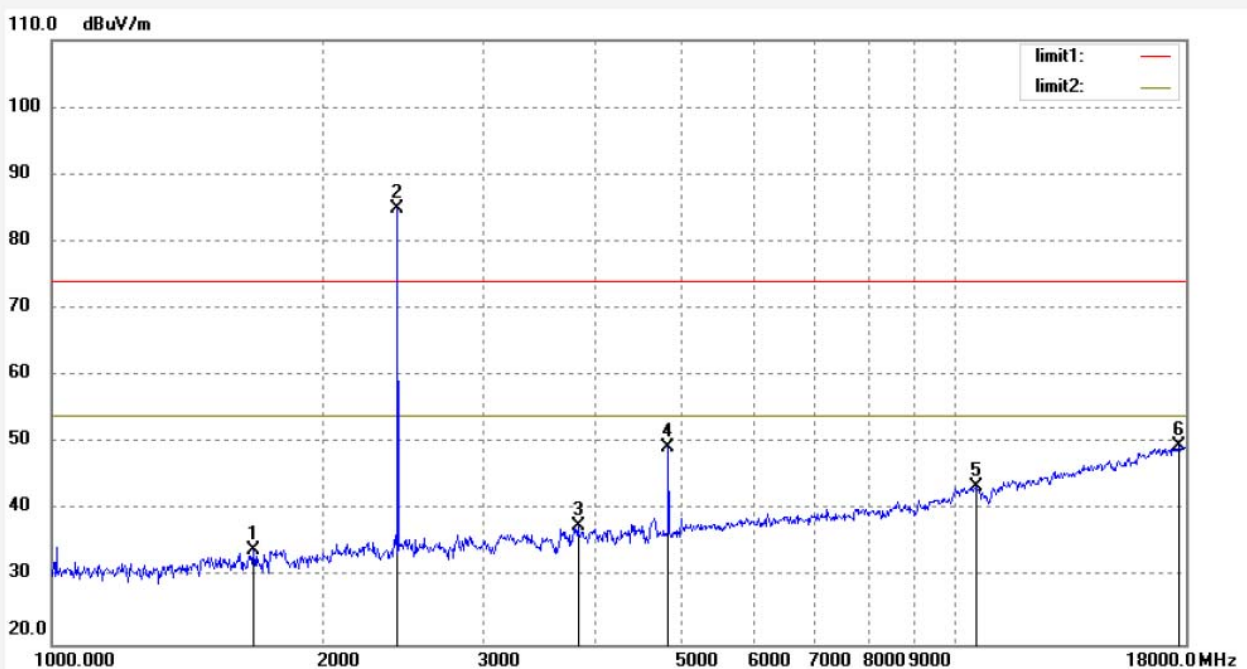

No.	Freq. (MHz)	Reading (dBuV/m)	Factor (dB)	Result (dBuV/m)	Limit (dBuV/m)	Margin (dB)	Detector	Height (cm)	Degree (deg.)	Remark
1	1673.977	44.64	-10.51	34.13	74.00	-39.87	peak	150	52	
2	2440.021	92.79	-7.93	84.86			peak	150	66	
3	3826.132	41.38	-3.71	37.67	74.00	-36.33	peak	150	146	
4	4880.324	51.53	-2.25	49.28			peak	150	195	
5	10535.961	38.05	5.43	43.48	74.00	-30.52	peak	150	56	
6	17688.369	31.65	18.01	49.66	74.00	-24.34	peak	150	101	

Job No.: frank2018 #1440

Polarization: Horizontal

Standard: FCC PART 15C 3M Radiated

Power Source: AC 120V/60Hz

Test item: Radiation Test

Date: 18/09/11/

Temp.(C)/Hum.(%) 25 C / 55 %

Time: 14/39/49

EUT: Msaaage Chair

Engineer Signature:

Mode: TX 2480MHz

Distance:

Model: EC-806A

Manufacturer: XIAMEN COMFORT SCIENCE & TECHNOLOGY GROUP CO., LTD

Note: Report NO.:ATE20181011

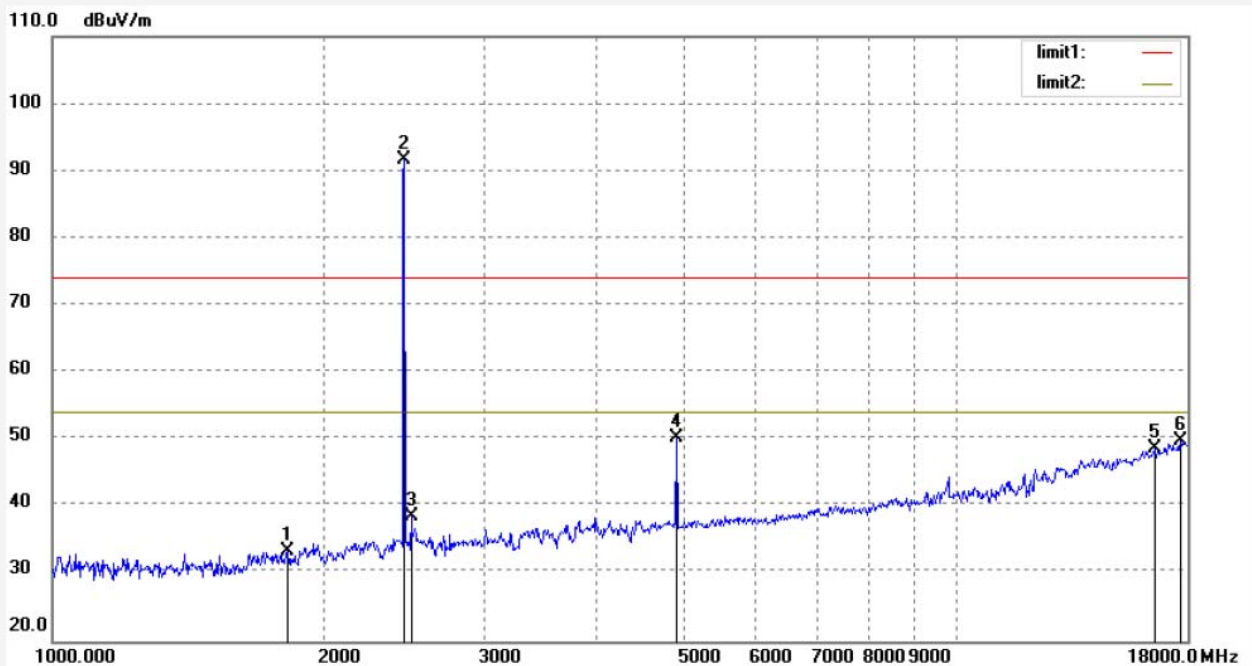

No.	Freq. (MHz)	Reading (dBuV/m)	Factor (dB)	Result (dBuV/m)	Limit (dBuV/m)	Margin (dB)	Detector	Height (cm)	Degree (deg.)	Remark
1	1821.415	43.15	-9.84	33.31	74.00	-40.69	peak	250	301	
2	2480.034	99.47	-7.84	91.63			peak	250	64	
3	2494.216	46.20	-7.73	38.47	74.00	-35.53	peak	250	101	
4	4960.160	52.20	-1.97	50.23			peak	250	49	
5	16542.951	35.21	13.46	48.67	74.00	-25.33	peak	250	156	
6	17688.369	31.71	18.01	49.72	74.00	-24.28	peak	250	302	

Job No.: frank2018 #1441

Standard: FCC PART 15C 3M Radiated

Test item: Radiation Test

Temp.(C)/Hum.(%) 25 C / 55 %

EUT: Msaaage Chair

Mode: TX 2480MHz

Model: EC-806A

Manufacturer: XIAMEN COMFORT SCIENCE & TECHNOLOGY GROUP CO., LTD

Polarization: Vertical

Power Source: AC 120V/60Hz

Date: 18/09/11/

Time: 14/41/52

Engineer Signature:

Distance:

Note: Report NO.:ATE20181011

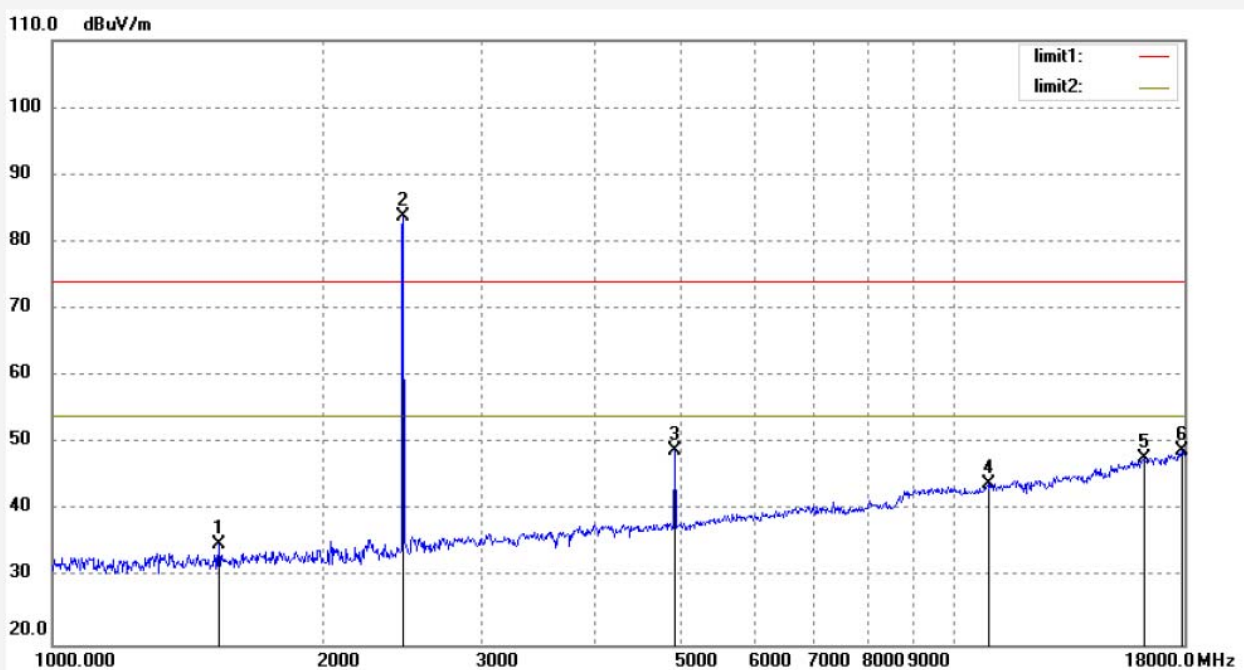

No.	Freq. (MHz)	Reading (dBuV/m)	Factor (dB)	Result (dBuV/m)	Limit (dBuV/m)	Margin (dB)	Detector	Height (cm)	Degree (deg.)	Remark
1	1529.543	46.18	-11.16	35.02	74.00	-38.98	peak	150	320	
2	2480.034	91.59	-7.84	83.75			peak	150	21	
3	4960.160	50.86	-1.97	48.89			peak	150	168	
4	10910.474	38.14	5.76	43.90	74.00	-30.10	peak	150	120	
5	16256.545	34.79	13.06	47.85	74.00	-26.15	peak	150	166	
6	17895.518	29.85	19.06	48.91	74.00	-25.09	peak	150	91	

10.AC POWER LINE CONDUCTED EMISSION TEST

10.1.Block Diagram of Test Setup

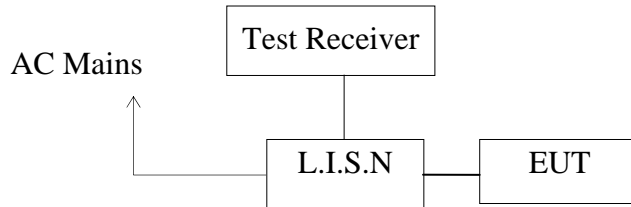

10.2.Test System Setup

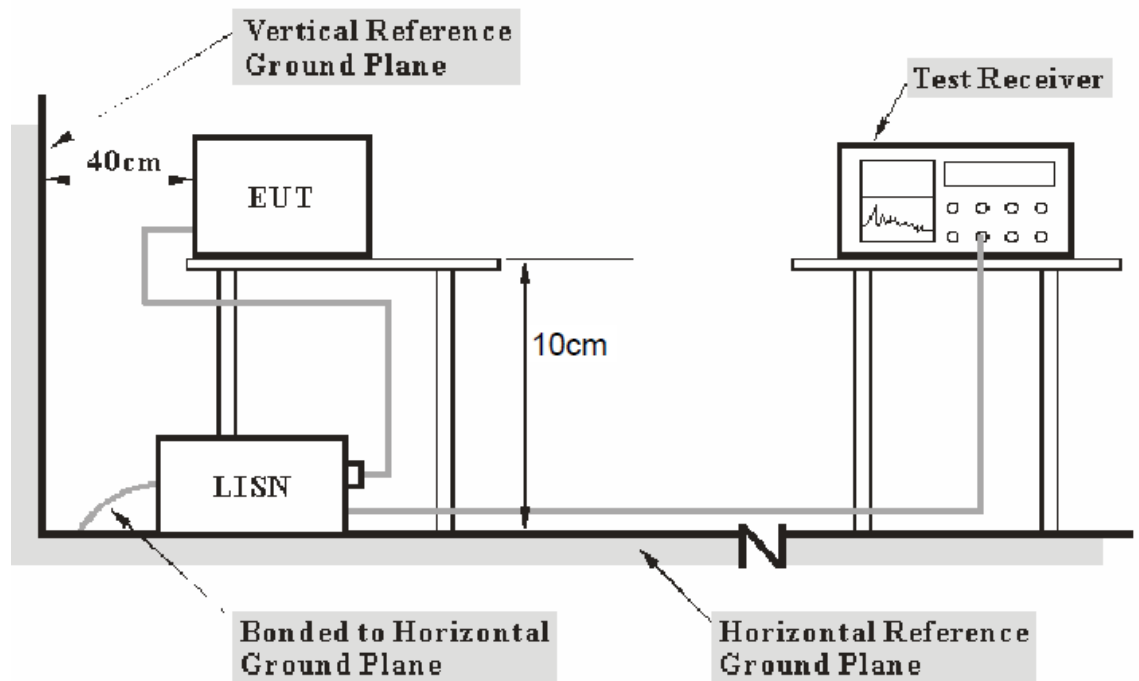

- Note: 1. Support units were connected to second LISN.
2. Both of LISNs (AMN) 80 cm from EUT and at the least 10cm from other units and other metal planes support units.

10.3. Power Line Conducted Emission Measurement Limits

Frequency (MHz)	Conducted Limit dB(μV)	
	Quasi-peak Level	Average Level
0.15 - 0.50	66.0 – 56.0 *	56.0 – 46.0 *
0.50 - 5.00	56.0	46.0
5.00 - 30.00	60.0	50.0

NOTE1: The lower limit shall apply at the transition frequencies.
 NOTE2: The limit decreases linearly with the logarithm of the frequency in the range 0.15MHz to 0.50MHz.

10.4. Configuration of EUT on Measurement

The equipments are installed on Power Line Conducted Emission Measurement to meet the commission requirement and operating regulations in a manner, which tends to maximize its emission characteristics in a normal application.

10.5. Operating Condition of EUT

10.5.1. Setup the EUT and simulator as shown as Section 10.1.

10.5.2. Turn on the power of all equipment.

10.5.3. Let the EUT work in test mode and measure it.

10.6. Test Procedure

The EUT is put on the plane 0.1m high above the ground by insulating support and is connected to the power mains through a line impedance stabilization network (L.I.S.N.). This provides a 50ohm coupling impedance for the EUT system. Please refer the block diagram of the test setup and photographs. Both sides of AC lines are checked to find out the maximum conducted emission. In order to find the maximum emission levels, the relative positions of equipment and all of the interface cables shall be changed according to ANSI C63.10: 2013 on Conducted Emission Measurement.

The bandwidth of test receiver (R & S ESCS30) is set at 9kHz.

The frequency range from 150kHz to 30MHz is checked.

10.7.Data Sample

Frequency (MHz)	Transducer value (dB)	QuasiPeak Level (dB μ V)	Average Level (dB μ V)	QuasiPeak Limit (dB μ V)	Average Limit (dB μ V)	QuasiPeak Margin (dB)	Average Margin (dB)	Remark (Pass/Fail)
X.XX	10.5	51.1	34.2	56.0	46.0	4.9	11.8	Pass

Frequency(MHz) = Emission frequency in MHz

Transducer value(dB) = Insertion loss of LISN + Cable Loss

Level(dB μ V) = Quasi-peak Reading/Average Reading + Transducer value

Limit (dB μ V) = Limit stated in standard

Calculation Formula:

Margin = Limit (dB μ V) - Level (dB μ V)

10.8.Power Line Conducted Emission Measurement Results

PASS.

The frequency range from 150kHz to 30MHz is checked.

Maximizing procedure was performed on the six (6) highest emissions of the EUT. Emissions attenuated more than 20 dB below the permissible value are not reported.

All data was recorded in the Quasi-peak and average detection mode.

The spectral diagrams are attached as below.

ACCURATE TECHNOLOGY CO.,LTD

CONDUCTED EMISSION STANDARD FCC PART 15C

EUT: Msaaage Chair M/N:EC-806A
 Manufacturer: XIAMEN COMFORT SCIENCE&TECHNOLOGY GROUP CO.,LTD
 Operating Condition: BT Communication
 Test Site: 1#Shielding Room
 Operator: Frank
 Test Specification: L 120V/60Hz
 Comment: Report NO.:ATE20181011
 Start of Test: 7/9/2018 / 11:31:37AM

SCAN TABLE: "V 9K-30MHz fin"

Start	Stop	Step	Detector	Meas. Time	IF Bandw.	Transducer
9.0 kHz	150.0 kHz	100.0 Hz	QuasiPeak	1.0 s	200 Hz	NSLK8126 2008
150.0 kHz	30.0 MHz	5.0 kHz	Average			
			QuasiPeak	1.0 s	9 kHz	NSLK8126 2008
			Average			

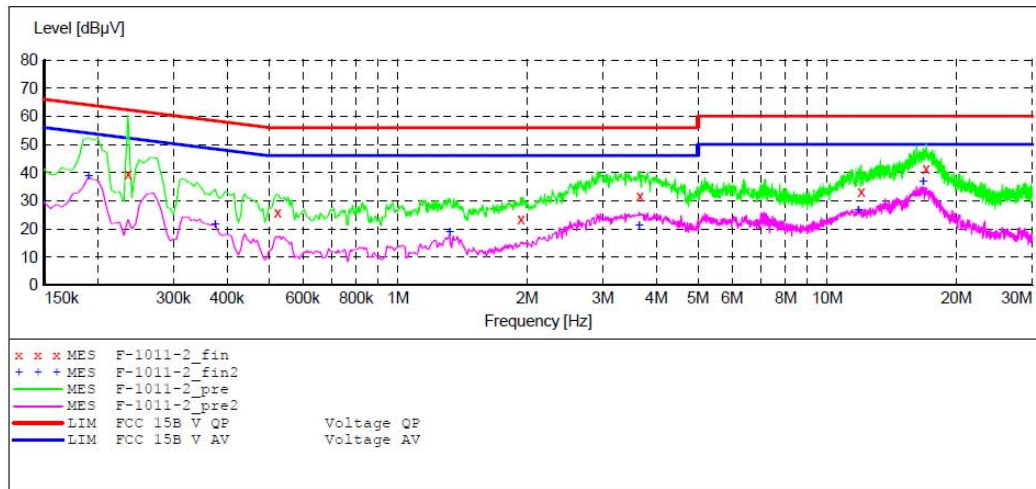

MEASUREMENT RESULT: "F-1011-2_fin"

7/9/2018 11:35AM

Frequency MHz	Level dBµV	Transd dB	Limit dBµV	Margin dB	Detector	Line	PE
0.235000	39.50	10.6	62	22.8	QP	L1	GND
0.525000	25.70	10.7	56	30.3	QP	L1	GND
1.935000	23.30	11.0	56	32.7	QP	L1	GND
3.660000	31.60	11.1	56	24.4	QP	L1	GND
11.995000	33.40	11.3	60	26.6	QP	L1	GND
17.005000	41.40	11.4	60	18.6	QP	L1	GND

MEASUREMENT RESULT: "F-1011-2_fin2"

7/9/2018 11:35AM

Frequency MHz	Level dBµV	Transd dB	Limit dBµV	Margin dB	Detector	Line	PE
0.190000	38.70	10.5	54	15.3	AV	L1	GND
0.375000	21.50	10.7	48	26.9	AV	L1	GND
1.320000	18.60	10.9	46	27.4	AV	L1	GND
3.650000	21.10	11.1	46	24.9	AV	L1	GND
11.800000	26.60	11.3	50	23.4	AV	L1	GND
16.720000	36.60	11.4	50	13.4	AV	L1	GND

ACCURATE TECHNOLOGY CO., LTD

CONDUCTED EMISSION STANDARD FCC PART 15C

EUT: Msaaage Chair M/N:EC-806A
 Manufacturer: XIAMEN COMFORT SCIENCE&TECHNOLOGY GROUP CO.,LTD
 Operating Condition: BT Communication
 Test Site: 1#Shielding Room
 Operator: Frank
 Test Specification: N 120V/60Hz
 Comment: Report NO.:ATE20181011
 Start of Test: 7/9/2018 / 11:27:08AM

SCAN TABLE: "V 9K-30MHz fin"

Start Frequency	Stop Frequency	Step Width	Detector	Meas. Time	IF Bandw.	Transducer
9.0 kHz	150.0 kHz	100.0 Hz	QuasiPeak	1.0 s	200 Hz	NSLK8126 2008
150.0 kHz	30.0 MHz	5.0 kHz	Average			
			QuasiPeak	1.0 s	9 kHz	NSLK8126 2008
			Average			

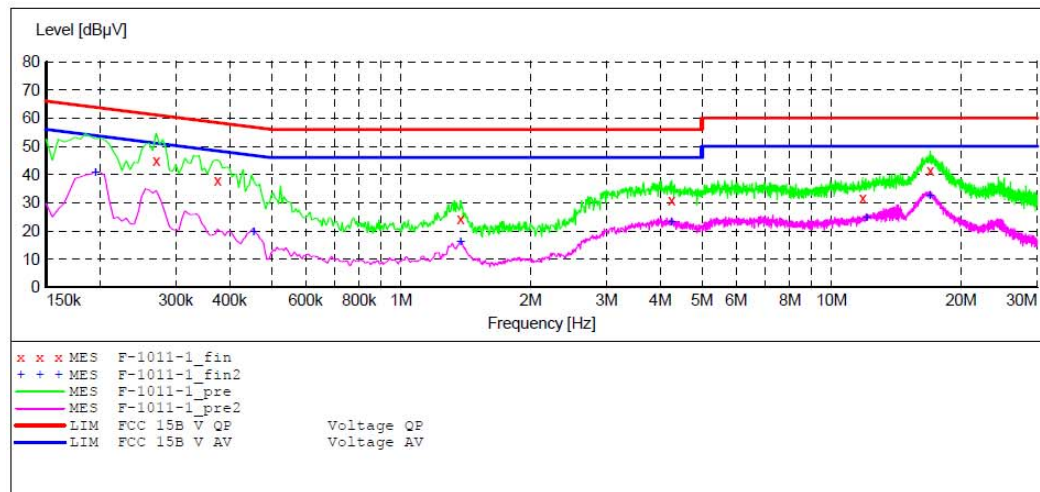

MEASUREMENT RESULT: "F-1011-1_fin"

7/9/2018 11:30AM

Frequency MHz	Level dBµV	Transd dB	Limit dBµV	Margin dB	Detector	Line	PE
0.270000	44.90	10.6	61	16.2	QP	N	GND
0.375000	38.00	10.7	58	20.4	QP	N	GND
1.375000	24.40	10.9	56	31.6	QP	N	GND
4.250000	31.00	11.1	56	25.0	QP	N	GND
11.800000	31.60	11.3	60	28.4	QP	N	GND
16.960000	41.30	11.4	60	18.7	QP	N	GND

MEASUREMENT RESULT: "F-1011-1_fin2"

7/9/2018 11:30AM

Frequency MHz	Level dBµV	Transd dB	Limit dBµV	Margin dB	Detector	Line	PE
0.195000	40.70	10.5	54	13.1	AV	N	GND
0.455000	19.60	10.7	47	27.2	AV	N	GND
1.375000	16.10	10.9	46	29.9	AV	N	GND
4.250000	23.20	11.1	46	22.8	AV	N	GND
12.055000	24.60	11.3	50	25.4	AV	N	GND
16.915000	32.40	11.4	50	17.6	AV	N	GND

11. ANTENNA REQUIREMENT

11.1. The Requirement

According to Section 15.203, an intentional radiator shall be designed to ensure that no antenna other than that furnished by the responsible party shall be used with the device.

11.2. Antenna Construction

Device is equipped with permanent attached antenna, which isn't displaced by other antenna. The Max Antenna gain of EUT is 2dBi. Therefore, the equipment complies with the antenna requirement of Section 15.203.



Antenna

***** End of Test Report *****