

APPLICATION CERTIFICATION FCC Part 15C  
On Behalf of  
XIAMEN COMFORT SCIENCE & TECHNOLOGY GROUP CO., LTD.

Massage Chair

Model No.: EC-802T, OG-7010

FCC ID: YMX-EC802T

Prepared for : XIAMEN COMFORT SCIENCE & TECHNOLOGY  
GROUP CO., LTD.  
Address : (5/F) NO.168, QIANPU ROAD SIMING DISTRICT,  
XIAMEN, CHINA.

Prepared by : Shenzhen Accurate Technology Co., Ltd.  
Address : 1/F., Building A, Changyuan New Material Port, Science  
& Industry Park, Nanshan District, Shenzhen,  
Guangdong, P.R. China.

Tel: (0755) 26503290  
Fax: (0755) 26503396

Report No. : ATE20200296  
Date of Test : April 04, 2020-May 20, 2020  
Date of Report : May 22, 2020

## TABLE OF CONTENTS

Description	Page
Test Report Certification	
<b>1. GENERAL INFORMATION .....</b>	<b>5</b>
1.1. Description of Device (EUT).....	5
1.2. Model difference declaration .....	5
1.3. Accessory and Auxiliary Equipment.....	6
1.4. Description of Test Facility .....	6
1.5. Measurement Uncertainty.....	7
<b>2. MEASURING DEVICE AND TEST EQUIPMENT .....</b>	<b>8</b>
<b>3. OPERATION OF EUT DURING TESTING .....</b>	<b>9</b>
3.1. Operating Mode .....	9
3.2. Configuration and peripherals .....	9
<b>4. TEST PROCEDURES AND RESULTS .....</b>	<b>10</b>
<b>5. 20DB BANDWIDTH TEST.....</b>	<b>11</b>
5.1. Block Diagram of Test Setup.....	11
5.2. The Requirement For Section 15.247(a)(1).....	11
5.3. EUT Configuration on Measurement .....	11
5.4. Operating Condition of EUT .....	11
5.5. Test Procedure .....	11
5.6. Test Result .....	12
<b>6. CARRIER FREQUENCY SEPARATION TEST.....</b>	<b>18</b>
6.1. Block Diagram of Test Setup.....	18
6.2. The Requirement For Section 15.247(a)(1).....	18
6.3. EUT Configuration on Measurement .....	18
6.4. Operating Condition of EUT .....	18
6.5. Test Procedure .....	19
6.6. Test Result .....	19
<b>7. NUMBER OF HOPPING FREQUENCY TEST .....</b>	<b>25</b>
7.1. Block Diagram of Test Setup.....	25
7.2. The Requirement For Section 15.247(a)(1)(iii).....	25
7.3. EUT Configuration on Measurement .....	25
7.4. Operating Condition of EUT .....	25
7.5. Test Procedure .....	25
7.6. Test Result .....	26
<b>8. DWELL TIME TEST .....</b>	<b>28</b>
8.1. Block Diagram of Test Setup.....	28
8.2. The Requirement For Section 15.247(a)(1)(iii).....	28
8.3. EUT Configuration on Measurement .....	28
8.4. Operating Condition of EUT .....	28
8.5. Test Procedure .....	28
8.6. Test Result .....	29
<b>9. MAXIMUM PEAK OUTPUT POWER TEST .....</b>	<b>35</b>
9.1. Block Diagram of Test Setup.....	35

9.2.	The Requirement For Section 15.247(b)(1).....	35
9.3.	EUT Configuration on Measurement .....	35
9.4.	Operating Condition of EUT .....	35
9.5.	Test Procedure .....	35
9.6.	Test Result .....	36
<b>10.</b>	<b>RADIATED EMISSION TEST .....</b>	<b>42</b>
10.1.	Block Diagram of Test Setup.....	42
10.2.	The Limit For Section 15.247(d) .....	44
10.3.	Restricted bands of operation .....	44
10.4.	Configuration of EUT on Measurement .....	45
10.5.	Test Procedure .....	45
10.6.	Data Sample.....	46
10.7.	The Field Strength of Radiation Emission Measurement Results .....	46
<b>11.</b>	<b>BAND EDGE COMPLIANCE TEST .....</b>	<b>59</b>
11.1.	Block Diagram of Test Setup.....	59
11.2.	The Requirement For Section 15.247(d) .....	59
11.3.	EUT Configuration on Measurement .....	59
11.4.	Operating Condition of EUT .....	59
11.5.	Test Procedure .....	60
11.6.	Test Result .....	60
<b>12.</b>	<b>AC POWER LINE CONDUCTED EMISSION FOR FCC PART 15 SECTION 15.207(A) ..</b>	<b>79</b>
12.1.	Block Diagram of Test Setup.....	79
12.2.	Test System Setup.....	79
12.3.	Power Line Conducted Emission Measurement Limits.....	80
12.4.	Configuration of EUT on Measurement .....	80
12.5.	Operating Condition of EUT .....	80
12.6.	Test Procedure .....	80
12.7.	Data Sample.....	81
12.8.	Power Line Conducted Emission Measurement Results .....	81
<b>13.</b>	<b>ANTENNA REQUIREMENT.....</b>	<b>85</b>
13.1.	The Requirement .....	85
13.2.	Antenna Construction .....	85

## Test Report Certification

Applicant : XIAMEN COMFORT SCIENCE & TECHNOLOGY GROUP CO.,LTD.  
Address : (5/F) NO.168, QIANPU ROAD SIMING DISTRICT, XIAMEN, CHINA  
Manufacturer : XIAMEN HEALTHCARE ELECTRONIC CO.,LTD.  
Address : 65-66#, 62-63# BUILDING, SIMING ZONE, TONGAN INDUSTRIAL DISTRICT, XIAMEN CITY, FUJIAN PROVINCE, P.R.CHINA  
Product : Massage Chair  
Model No. : EC-802T, OG-7010  
Trade name : N/A

Measurement Procedure Used:

### **FCC Rules and Regulations Part 15 Subpart C Section 15.247 ANSI C63.10: 2013**

The device described above is tested by SHENZHEN ACCURATE TECHNOLOGY CO., LTD. to determine the maximum emission levels emanating from the device. The maximum emission levels are compared to the FCC Part 15 Subpart C Section 15.247 limits. The measurement results are contained in this test report and SHENZHEN ACCURATE TECHNOLOGY CO., LTD. is assumed full responsibility for the accuracy and completeness of these measurements. Also, this report shows that the Equipment Under Test (EUT) is to be technically compliant with the FCC requirements.

This report applies to above tested sample only. This report shall not be reproduced in part without written approval of SHENZHEN ACCURATE TECHNOLOGY CO., LTD.

Date of Test : April 04, 2020--May 20, 2020  
Date of Report : May 22, 2020

Prepared by :

  
\_\_\_\_\_  
(Tina Zhang, Engineer)

Approve & Authorized Signer :

  
\_\_\_\_\_  
(Martin Lü, Manager)

## 1. GENERAL INFORMATION

### 1.1. Description of Device (EUT)

EUT	:	Massage Chair
Model Number	:	EC-802T, OG-7010
Bluetooth version	:	BT V4.0
Frequency Range	:	2402MHz-2480MHz
Number of Channels	:	79
Antenna Gain(Max)	:	2dBi
Antenna type	:	Integral Antenna
Trade Name	:	N/A
Rating	:	AC 110-120V/60Hz
Modulation mode	:	GFSK, $\pi/4$ DQPSK, 8DPSK
Applicant	:	XIAMEN COMFORT SCIENCE & TECHNOLOGY GROUP CO.,LTD.
Address	:	(5/F) NO.168, QIANPU ROAD SIMING DISTRICT, XIAMEN, CHINA
Manufacturer	:	XIAMEN HEALTHCARE ELECTRONIC CO.,LTD.
Address	:	65-66#, 62-63# BUILDING, SIMING ZONE, TONGAN INDUSTRIAL DISTRICT, XIAMEN CITY, FUJIAN PROVINCE, P.R.CHINA
Date of sample received	:	April 03, 2020
Date of Test	:	April 04, 2020-May 20, 2020
Sample number	:	2000270

### 1.2. Model difference declaration

EC-802T, OG-7010 are identical in interior structure, electrical circuits and components, and just model number is different for the marketing requirement.

### 1.3. Accessory and Auxiliary Equipment

PC  
Manufacturer: LENOVO  
M/N: 4290-RT8  
S/N: R9-FW93G 11/08

### 1.4. Description of Test Facility

EMC Lab : Recognition of accreditation by Federal Communications Commission (FCC)  
The Designation Number is CN1189  
The Registration Number is 708358

Listed by Innovation, Science and Economic Development Canada (ISED)  
The Registration Number is 5077A-2

Accredited by China National Accreditation Service for Conformity Assessment (CNAS)  
The Registration Number is CNAS L3193

Accredited by American Association for Laboratory Accreditation (A2LA)  
The Certificate Number is 4297.01

Name of Firm : Shenzhen Accurate Technology Co., Ltd.  
Site Location : 1/F., Building A, Changyuan New Material Port, Science & Industry Park, Nanshan District, Shenzhen, Guangdong, P.R. China

## 1.5.Measurement Uncertainty

Conducted Emission Expanded Uncertainty = 2.72dB, k=2  
(Mains ports, 9kHz-30MHz)

Radiated emission expanded uncertainty = 2.66dB, k=2  
(9kHz-30MHz)

Radiated emission expanded uncertainty = 4.28dB, k=2  
(30MHz-1000MHz)

Radiated emission expanded uncertainty = 4.98dB, k=2  
(1G-18GHz)

Radiated emission expanded uncertainty = 5.06dB, k=2  
(18G-26.5GHz)

## 2. MEASURING DEVICE AND TEST EQUIPMENT

**Table 1: List of Test and Measurement Equipment**

Kind of equipment	Manufacturer	Type	S/N	Calibrated dates	Calibrated until
EMI Test Receiver	Rohde&Schwarz	ESCS30	100307	Jan. 04, 2020	1 Year
EMI Test Receiver	Rohde&Schwarz	ESPI3	101526/003	Jan. 04, 2020	1 Year
Spectrum Analyzer	Rohde&Schwarz	FSV-40	101495	Jan. 04, 2020	1 Year
Spectrum Analyzer	Agilent	E7405A	MY45115511	Jan. 04, 2020	1 Year
Pre-Amplifier	Rohde&Schwarz	CBLU118354 0-01	3791	Jan. 04, 2020	1 Year
Loop Antenna	Schwarzbeck	FMZB1516	1516131	Jan. 04, 2020	1 Year
Bilog Antenna	Schwarzbeck	VULB9163	9163-323	Jan. 04, 2020	1 Year
Horn Antenna	Schwarzbeck	BBHA9120D	9120D-655	Jan. 04, 2020	1 Year
Horn Antenna	Schwarzbeck	BBHA9170	9170-359	Jan. 04, 2020	1 Year
Open Switch and Control Unit	Rohde&Schwarz	OSP120 + OSP-B157	101244 + 100866	Jan. 04, 2020	1 Year
LISN	Rohde&Schwarz	ESH3-Z5	100305	Jan. 04, 2020	1 Year
LISN	Schwarzbeck	NSLK8126	8126431	Jan. 04, 2020	1 Year
Highpass Filter	Wainwright Instruments	WHKX3.6/18 G-10SS	N/A	Jan. 04, 2020	1 Year
Band Reject Filter	Wainwright Instruments	WRCG2400/2 485-2375/2510 -60/11SS	N/A	Jan. 04, 2020	1 Year
RF Coaxial Cable (Conducted Emission)	SUHNER	N-2m	No.2	Jan. 04, 2020	1 Year
RF Coaxial Cable (Radiated Emission)	SUHNER	N-5m	NO.3	Jan. 04, 2020	1 Year
RF Coaxial Cable (Radiated Emission)	SUHNER	N-5m	NO.4	Jan. 04, 2020	1 Year
RF Coaxial Cable (Radiated Emission)	SUHNER	N-1m	NO.5	Jan. 04, 2020	1 Year
RF Coaxial Cable (Radiated Emission)	SUHNER	N-1m	NO.6	Jan. 04, 2020	1 Year
Conducted Emission Measurement Software: ES-K1 V1.71					
Radiated Emission Measurement Software: EZ_EMCC V1.1.4.2					



### 3. OPERATION OF EUT DURING TESTING

#### 3.1. Operating Mode

The mode is used: Transmitting mode

Low Channel: 2402MHz

Middle Channel: 2441MHz

High Channel: 2480MHz

Hopping

#### 3.2. Configuration and peripherals

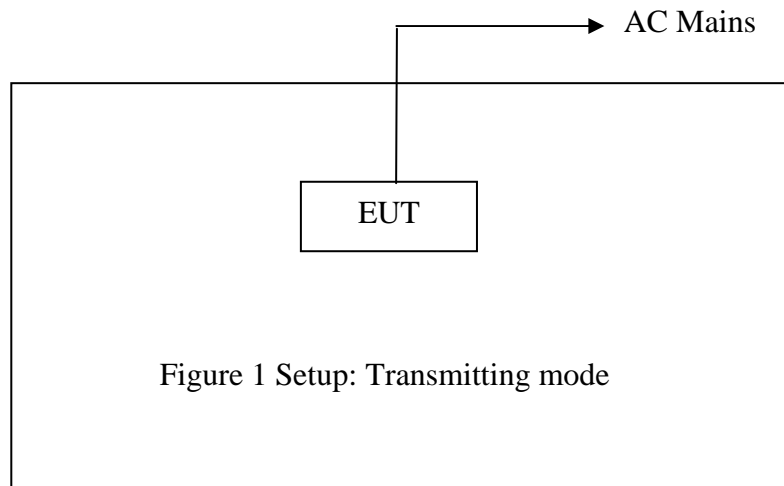

(EUT: Massage Chair)

Note: The power was switched from 85% to 115%, and the worse case data was recorded.

## 4. TEST PROCEDURES AND RESULTS

FCC Rules	Description of Test	Result
Section 15.207	Conducted Emission Test	Compliant
Section 15.247(a)(1)	20dB Bandwidth Test	Compliant
Section 15.247(a)(1)	Carrier Frequency Separation Test	Compliant
Section 15.247(a)(1)(iii)	Number Of Hopping Frequency Test	Compliant
Section 15.247(a)(1)(iii)	Dwell Time Test	Compliant
Section 15.247(b)(1)	Maximum Peak Output Power Test	Compliant
Section 15.247(d) Section 15.209	Radiated Emission Test	Compliant
Section 15.247(d)	Band Edge Compliance Test	Compliant
Section 15.203	Antenna Requirement	Compliant

## 5. 20DB BANDWIDTH TEST

### 5.1. Block Diagram of Test Setup

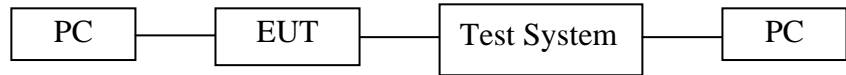

(EUT: Massage Chair)

### 5.2. The Requirement For Section 15.247(a)(1)

Section 15.247(a)(1): Frequency hopping systems shall have hopping channel carrier frequencies separated by a minimum of 25 kHz or the 20 dB bandwidth of the hopping channel, whichever is greater.

### 5.3. EUT Configuration on Measurement

The equipment are installed on the emission measurement to meet the commission requirements and operating regulations in a manner which tends to maximize its emission characteristics in normal application.

### 5.4. Operating Condition of EUT

5.4.1. Setup the EUT and simulator as shown as Section 5.1.

5.4.2. Turn on the power of all equipment.

5.4.3. Let the EUT work in TX (Hopping off) modes measure it. The transmit frequency are 2402-2480MHz. We select 2402MHz, 2441MHz, and 2480MHz TX frequency to transmit.

### 5.5. Test Procedure

5.5.1. The transmitter output was connected to the spectrum analyzer through a low loss cable.

5.5.2. Set RBW of spectrum analyzer to 30 kHz and VBW to 100 kHz.

5.5.3. The 20dB bandwidth is defined as the total spectrum the power of which is higher than peak power minus 20dB.

## 5.6. Test Result

Channel	Frequency (MHz)	GFSK mode 20dB Bandwidth (MHz)	$\pi/4$ DQPSK mode 20dB Bandwidth (MHz)	8DPSK mode 20dB Bandwidth (MHz)	Result
Low	2402	0.882	1.212	1.212	Pass
Middle	2441	0.804	1.230	1.218	Pass
High	2480	0.798	1.254	1.224	Pass

The spectrum analyzer plots are attached as below.

GFSK Mode

Low channel

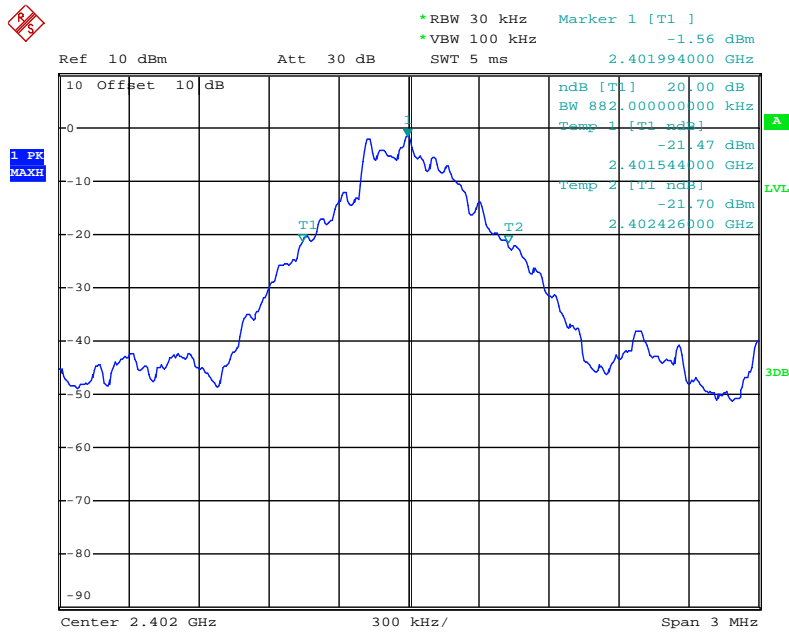

Date: 15.MAY.2020 10:45:18

Middle channel

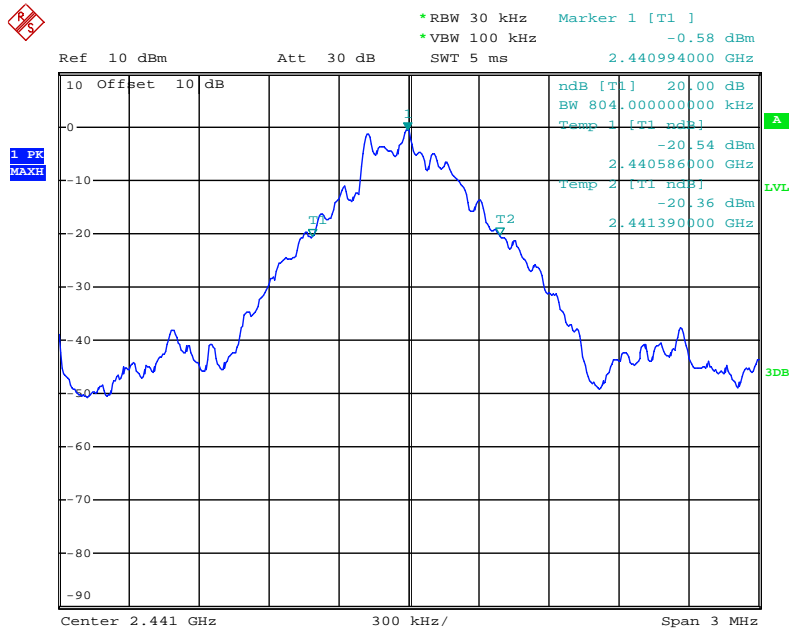

Date: 15.MAY.2020 10:45:52

### High channel

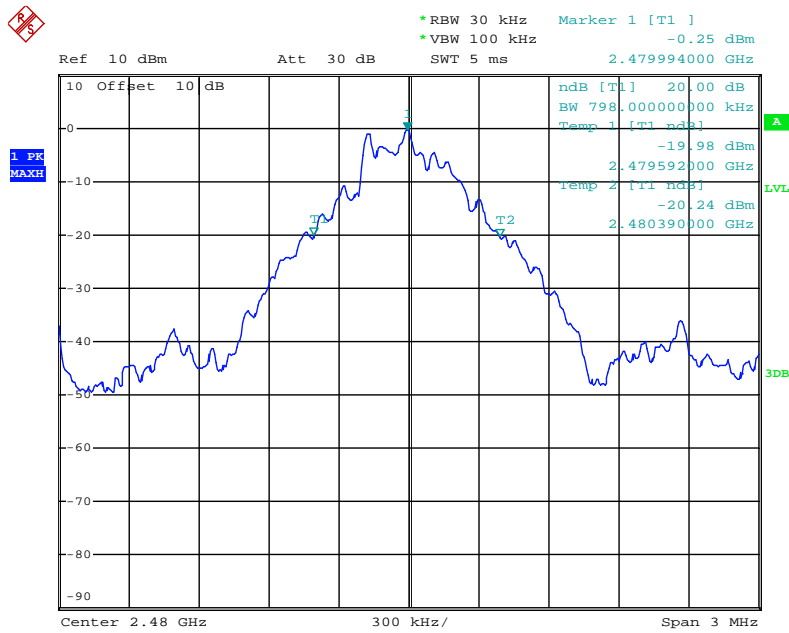

Date: 15.MAY.2020 10:46:29

### $\pi/4$ DQPSK Mode

### Low channel

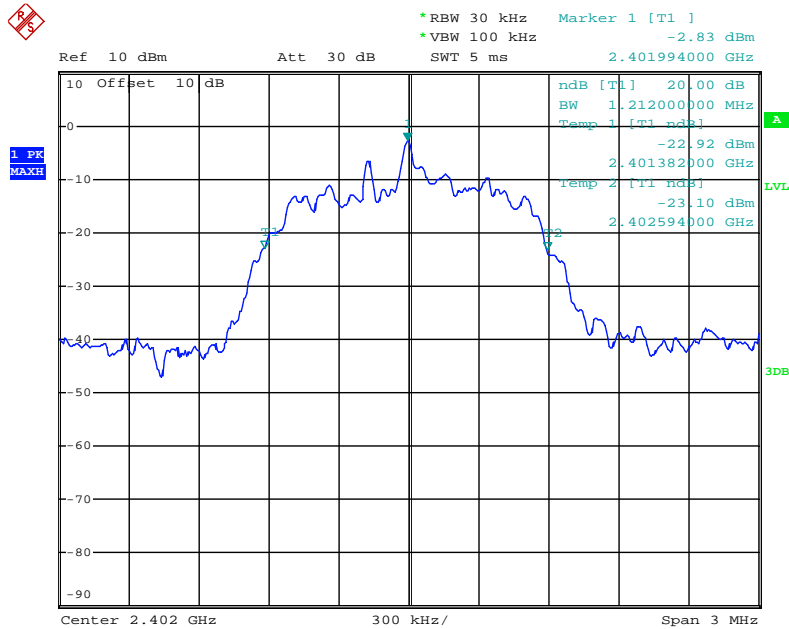

Date: 15.MAY.2020 10:48:09

### Middle channel

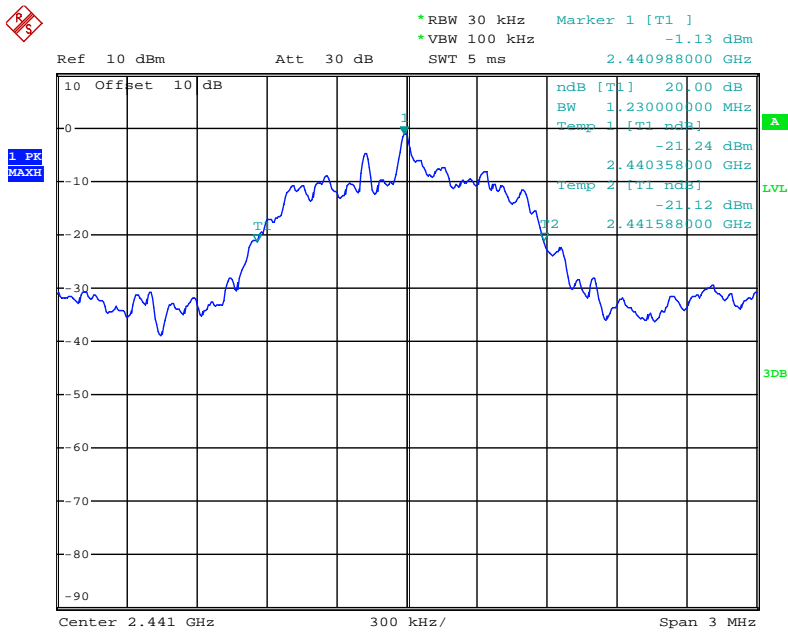

Date: 15.MAY.2020 10:47:41

### High channel

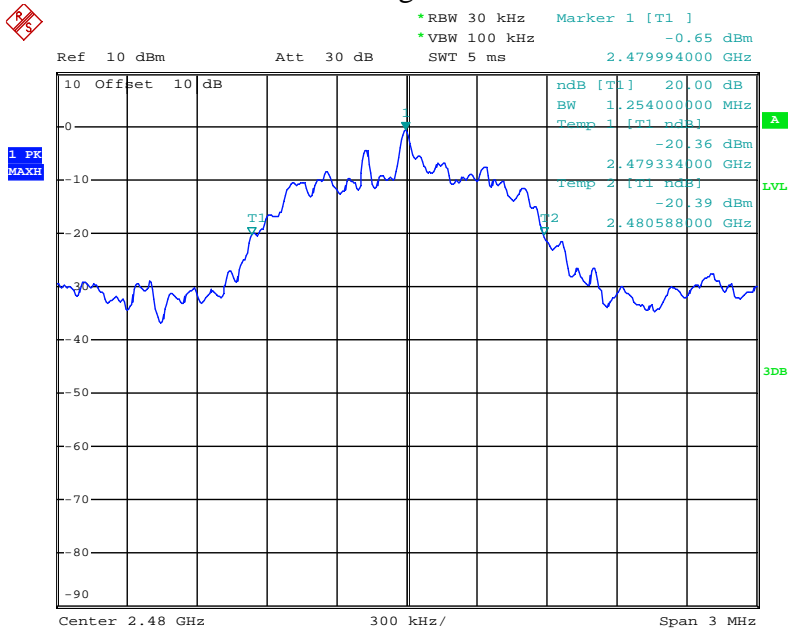

Date: 15.MAY.2020 10:47:03

8DPSK Mode

### Low channel

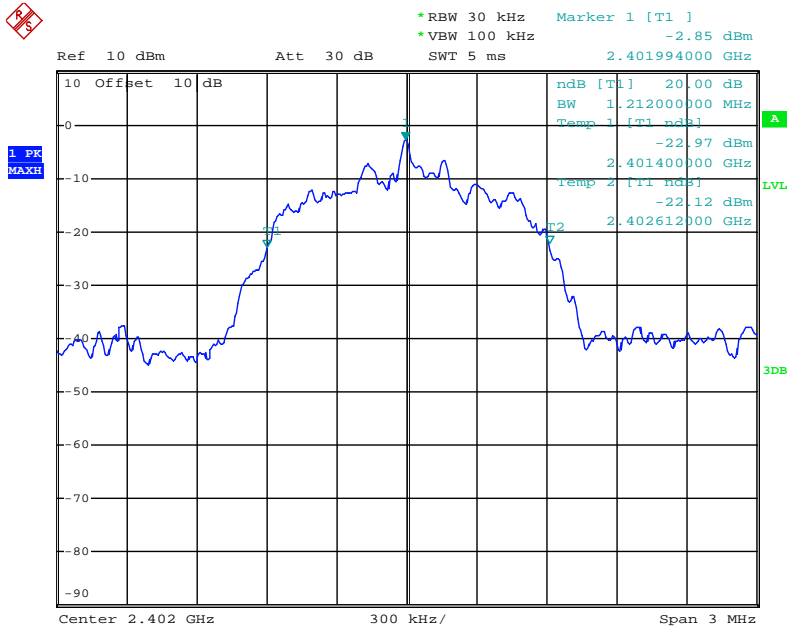

Date: 15.MAY.2020 10:48:49

### Middle channel

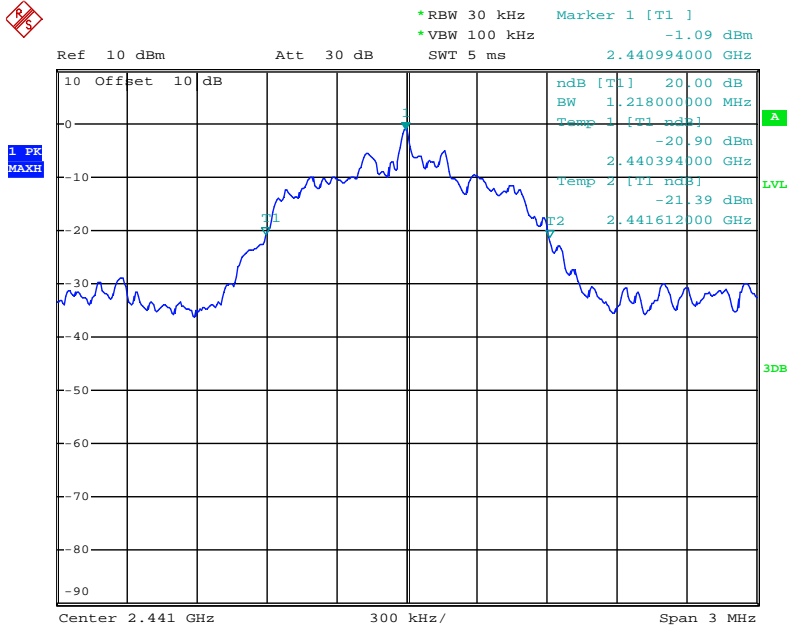

Date: 15.MAY.2020 10:49:15



### High channel

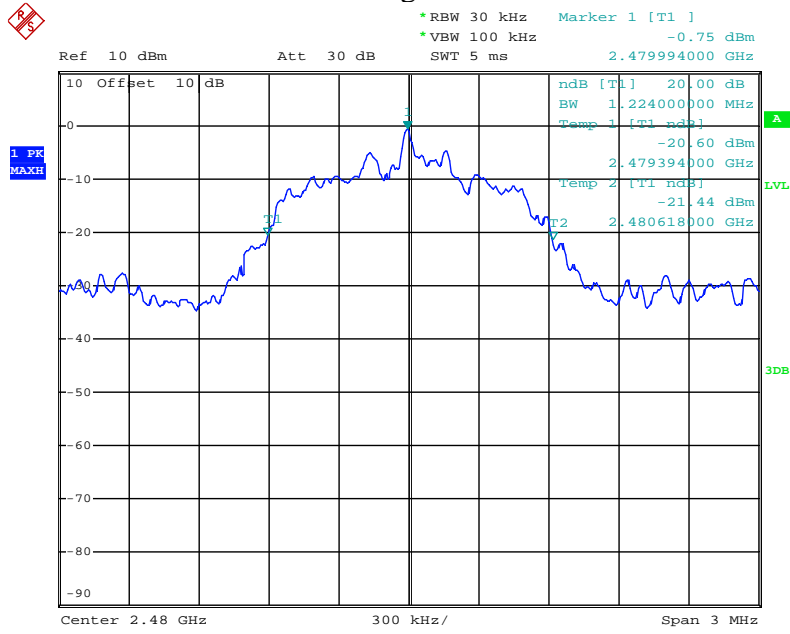

Date: 15.MAY.2020 10:49:39

## 6. CARRIER FREQUENCY SEPARATION TEST

### 6.1. Block Diagram of Test Setup

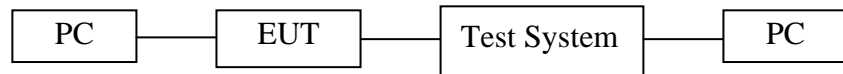

(EUT: Massage Chair)

### 6.2. The Requirement For Section 15.247(a)(1)

Section 15.247(a)(1): Frequency hopping systems shall have hopping channel carrier frequencies separated by a minimum of 25 kHz or the 20 dB bandwidth of the hopping channel, whichever is greater. Alternatively, frequency hopping systems operating in the 2400-2483.5 MHz band may have hopping channel carrier frequencies that are separated by 25 kHz or two-thirds of the 20 dB bandwidth of the hopping channel, whichever is greater, provided the systems operate with an output power no greater than 125 mW. The system shall hop to channel frequencies that are selected at the system hopping rate from a pseudorandomly ordered list of hopping frequencies. Each frequency must be used equally on the average by each transmitter. The system receivers shall have input bandwidths that match the hopping channel bandwidths of their corresponding transmitters and shall shift frequencies in synchronization with the transmitted signals.

### 6.3. EUT Configuration on Measurement

The equipment are installed on the emission measurement to meet the commission requirements and operating regulations in a manner which tends to maximize its emission characteristics in normal application.

### 6.4. Operating Condition of EUT

6.4.1. Setup the EUT and simulator as shown as Section 6.1.

6.4.2. Turn on the power of all equipment.

6.4.3. Let the EUT work in TX (Hopping on) modes measure it. The transmit frequency are 2402-2480MHz. We select 2402MHz, 2441MHz, and 2480MHz TX frequency to transmit.

## 6.5. Test Procedure

6.5.1. The transmitter output was connected to the spectrum analyzer through a low loss cable.

6.5.2. Set RBW of spectrum analyzer to 30 kHz and VBW to 100 kHz. Adjust Span to 2MHz.

6.5.3. Set the adjacent channel of the EUT Maxhold another trace.

6.5.4. Measurement the channel separation

## 6.6. Test Result

### GFSK

Channel	Frequency (MHz)	Channel Separation(MHz)	Limit (MHz)	Result
Low	2402	1.002	25KHz or 0.588MHz	PASS
	2403			
Middle	2440	0.996	25KHz or 0.536MHz	PASS
	2441			
High	2479	0.996	25KHz or 0.532MHz	PASS
	2480			

### Π/4 DQPSK

Channel	Frequency (MHz)	Channel Separation(MHz)	Limit (MHz)	Result
Low	2402	1.002	25KHz or 0.808MHz	PASS
	2403			
Middle	2440	0.996	25KHz or 0.820MHz	PASS
	2441			
High	2479	1.002	25KHz or 0.836MHz	PASS
	2480			

### 8 DPSK

Channel	Frequency (MHz)	Channel Separation(MHz)	Limit (MHz)	Result
Low	2402	1.002	25KHz or 0.808MHz	PASS
	2403			
Middle	2440	1.008	25KHz or 0.812MHz	PASS
	2441			
High	2479	1.002	25KHz or 0.816MHz	PASS
	2480			

The spectrum analyzer plots are attached as below.

## GFSK Mode

### Low channel

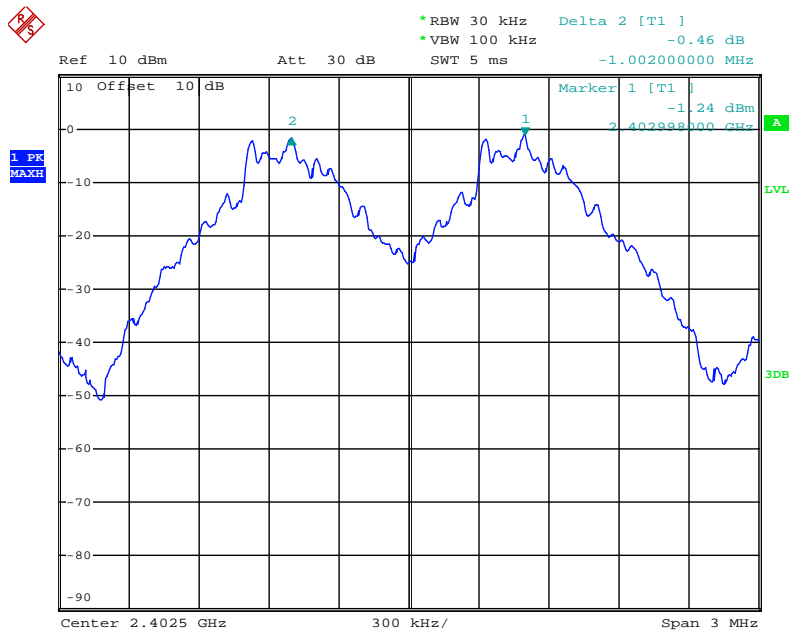

Date: 15.MAY.2020 11:03:03

### Middle channel

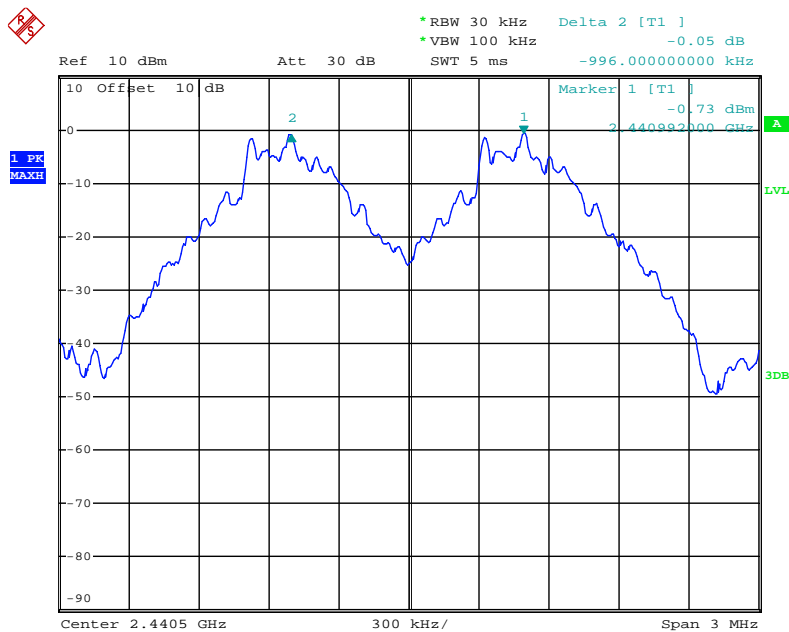

Date: 15.MAY.2020 11:02:08

## High channel

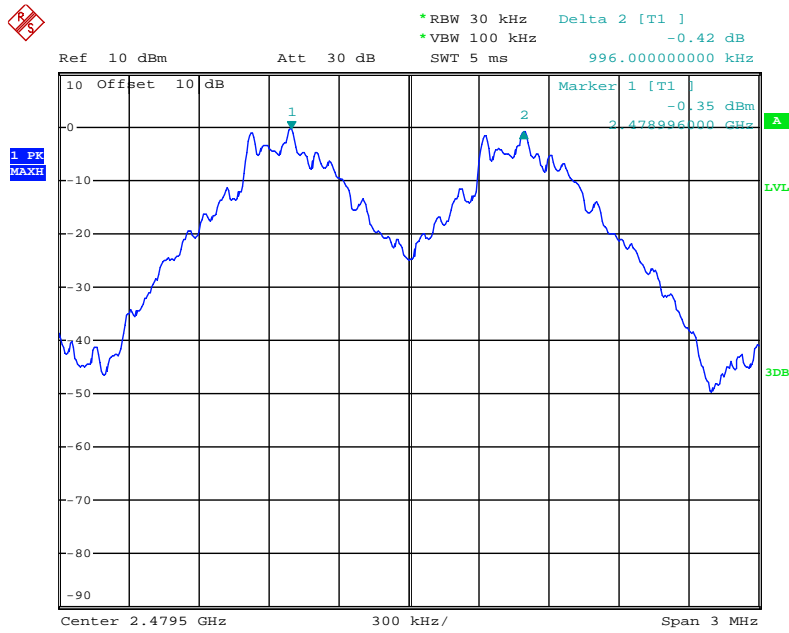

Date: 15.MAY.2020 11:01:35

## $\pi/4$ DQPSK Mode

## Low channel

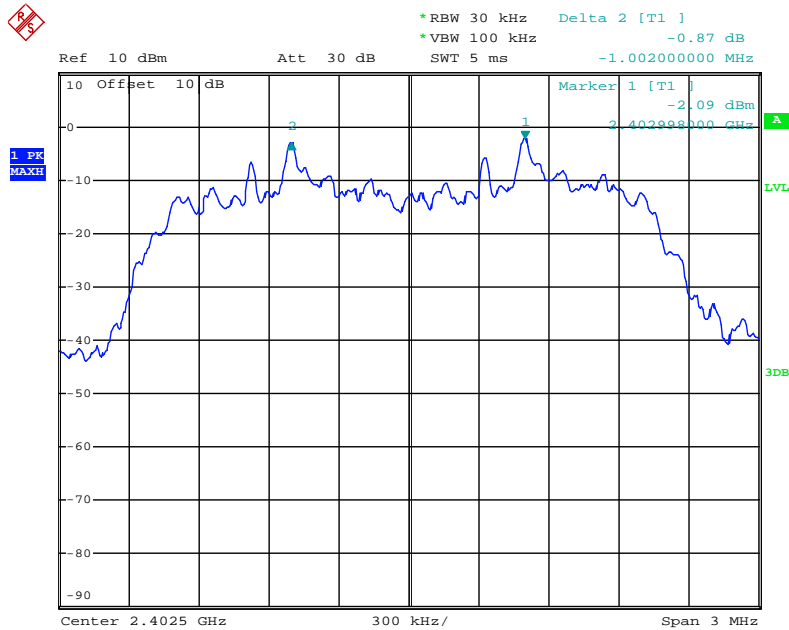

Date: 15.MAY.2020 11:03:53

### Middle channel

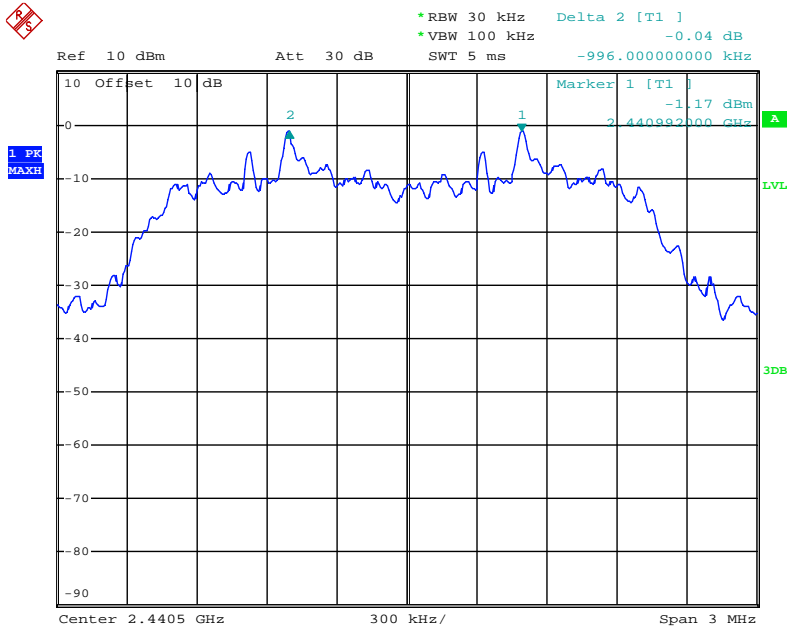

Date: 15.MAY.2020 11:04:33

### High channel

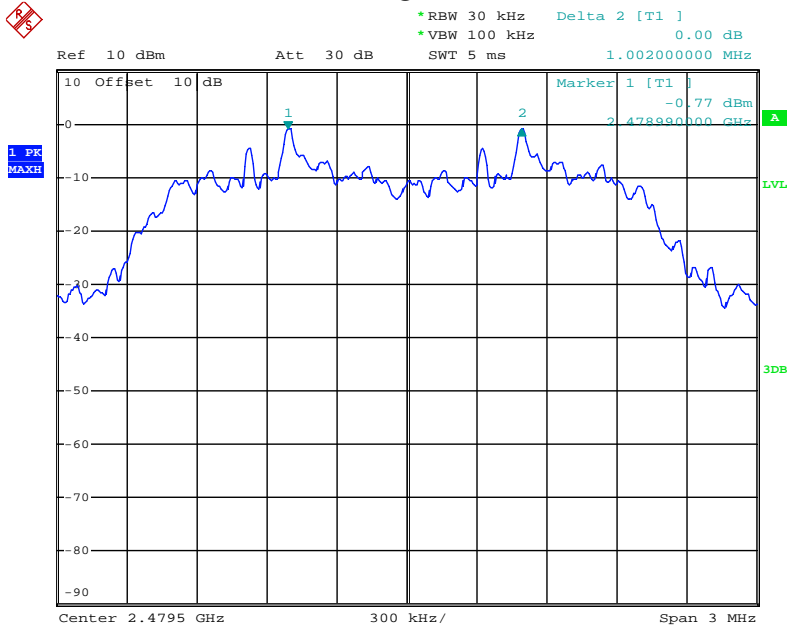

Date: 15.MAY.2020 11:05:08

## 8DPSK Mode

### Low channel

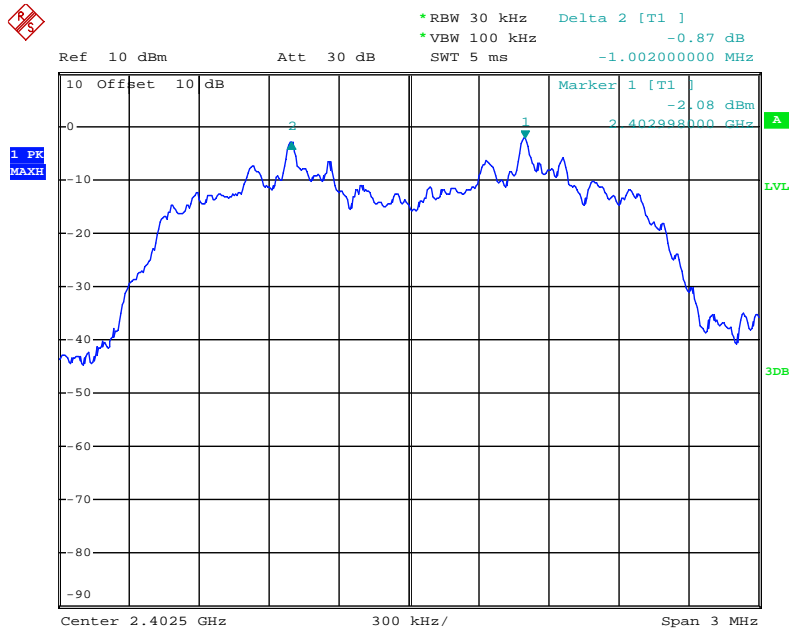

Date: 15.MAY.2020 11:07:12

### Middle channel

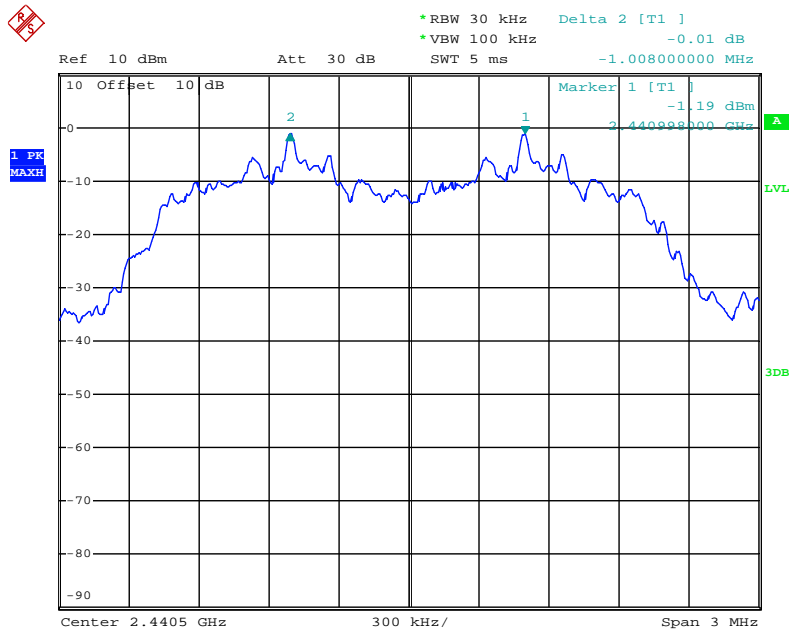

Date: 15.MAY.2020 11:06:34

### High channel

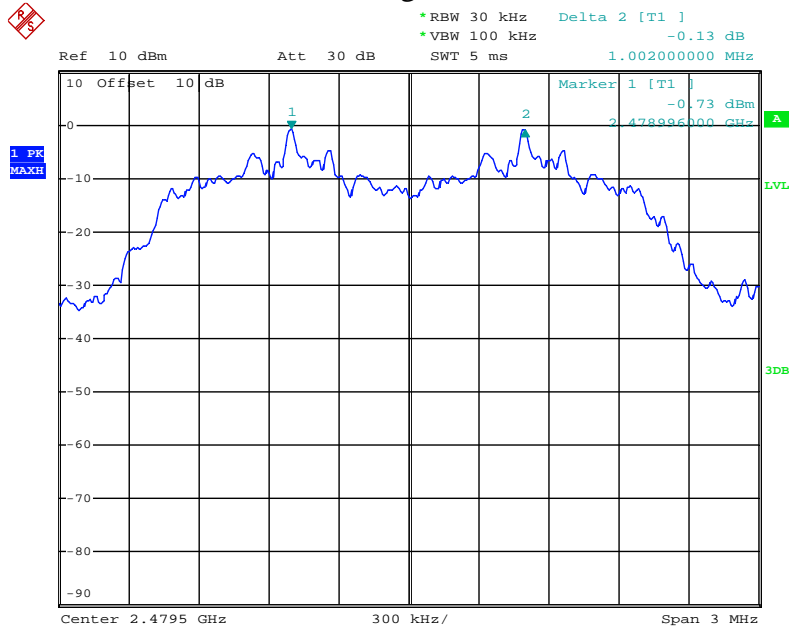

Date: 15.MAY.2020 11:06:03



## 7. NUMBER OF HOPPING FREQUENCY TEST

### 7.1. Block Diagram of Test Setup

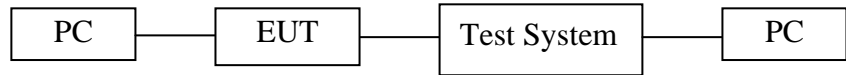

(EUT: Massage Chair)

### 7.2. The Requirement For Section 15.247(a)(1)(iii)

Section 15.247(a)(1)(iii): Frequency hopping systems in the 2400-2483.5 MHz band shall use at least 15 channels.

### 7.3. EUT Configuration on Measurement

The equipment are installed on the emission measurement to meet the commission requirements and operating regulations in a manner which tends to maximize its emission characteristics in normal application.

### 7.4. Operating Condition of EUT

7.4.1. Setup the EUT and simulator as shown as Section 7.1.

7.4.2. Turn on the power of all equipment.

7.4.3. Let the EUT work in TX (Hopping on) modes measure it.

### 7.5. Test Procedure

7.5.1. The transmitter output was connected to the spectrum analyzer through a low loss cable.

7.5.2. Set the spectrum analyzer as Span=83.5MHz, RBW=100 kHz, VBW=300 kHz.

7.5.3. Max hold, view and count how many channel in the band.

### 7.6. Test Result

Total number of hopping channel	Measurement result(CH)	Limit(CH)
		79

The spectrum analyzer plots are attached as below.

Number of hopping channels(GFSK)

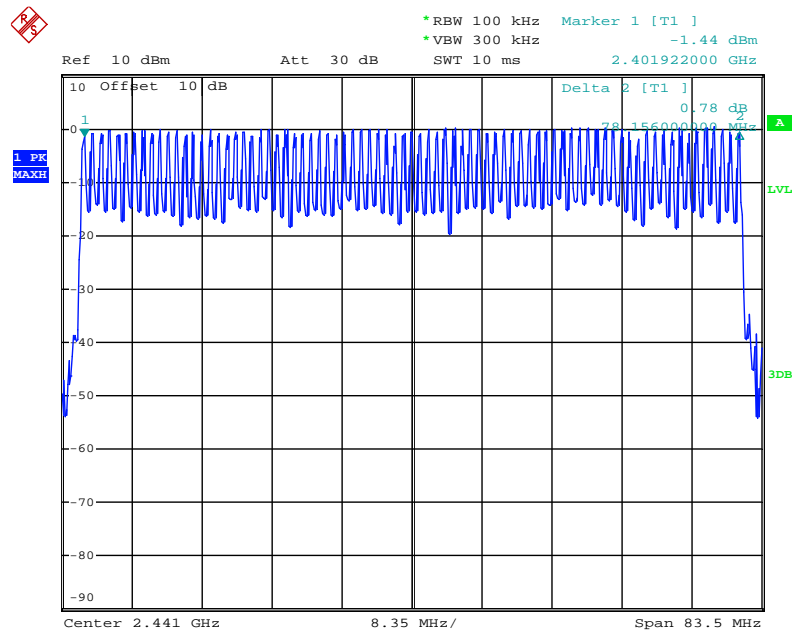

Date: 15.MAY.2020 11:12:22

### Number of hopping channels( $\pi/4$ DQPSK)

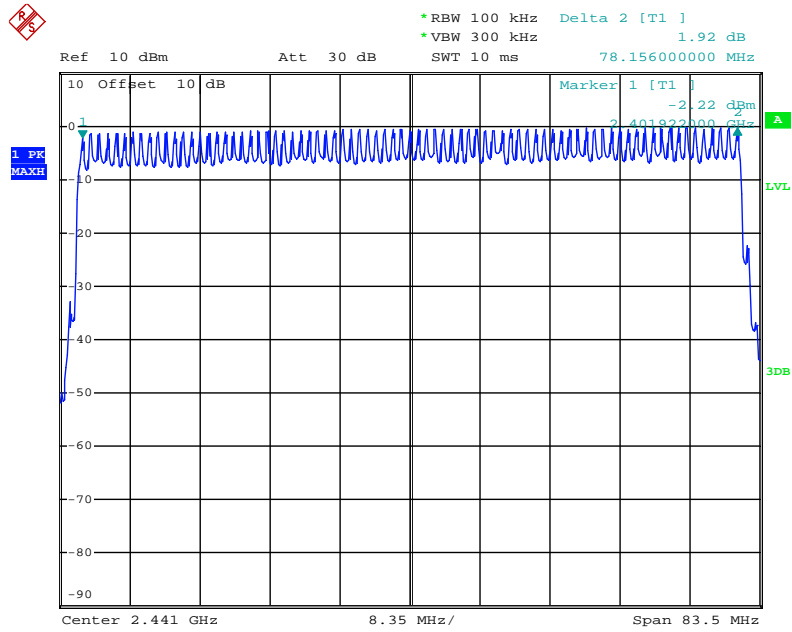

Date: 15.MAY.2020 11:22:03

### Number of hopping channels(8DPSK)

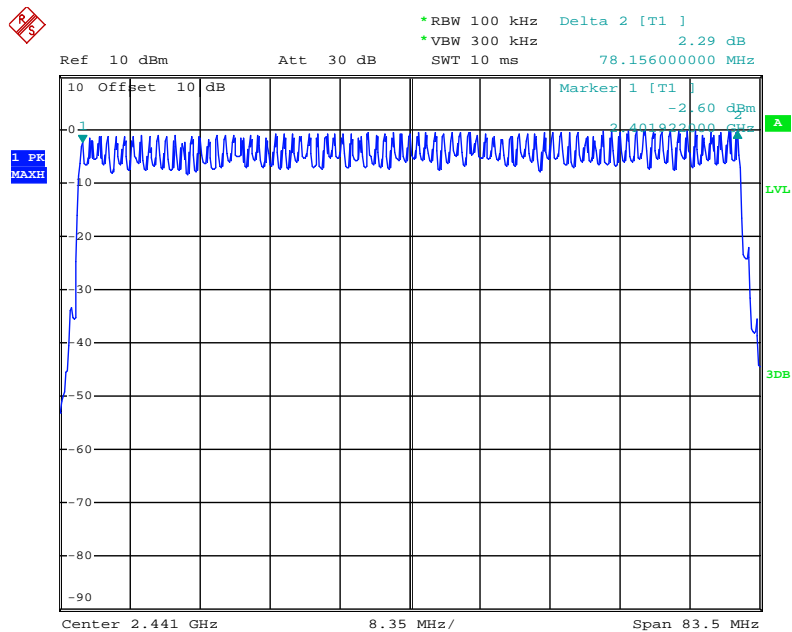

Date: 15.MAY.2020 11:27:45

## 8. DWELL TIME TEST

### 8.1. Block Diagram of Test Setup

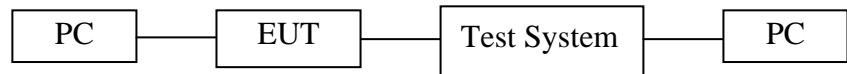

(EUT: Massage Chair)

### 8.2. The Requirement For Section 15.247(a)(1)(iii)

Section 15.247(a)(1)(iii): Frequency hopping systems in the 2400-2483.5 MHz band shall use at least 15 channels. The average time of occupancy on any channel shall not be greater than 0.4 seconds within a period of 0.4 seconds multiplied by the number of hopping channels employed. Frequency hopping systems may avoid or suppress transmissions on a particular hopping frequency provided that a minimum of 15 channels are used.

### 8.3. EUT Configuration on Measurement

The equipment are installed on the emission measurement to meet the commission requirements and operating regulations in a manner which tends to maximize its emission characteristics in normal application.

### 8.4. Operating Condition of EUT

8.4.1. Setup the EUT and simulator as shown as Section 8.1.

8.4.2. Turn on the power of all equipment.

8.4.3. Let the EUT work in TX (Hopping on) modes measure it. The transmit frequency are 2402-2480MHz. We select 2402MHz, 2441MHz, and 2480MHz TX frequency to transmit.

### 8.5. Test Procedure

8.5.1. The transmitter output was connected to the spectrum analyzer through a low loss cable.

8.5.2. Set center frequency of spectrum analyzer = operating frequency.

8.5.3. Set the spectrum analyzer as RBW=1MHz, VBW=3MHz, Span=0Hz, Adjust Sweep=5ms, 10ms, 15ms. Get the pulse time.

8.5.4.Repeat above procedures until all frequency measured were complete.

## 8.6.Test Result

### GFSK Mode

Mode	Channel Frequency (MHz)	Pulse Time (ms)	Dwell Time (ms)	Limit (ms)
DH1	2441	0.430	137.600	400
A period transmit time = $0.4 \times 79 = 31.6$ Dwell time = pulse time $\times (1600/(2*79)) \times 31.6$				
DH3	2441	1.700	272.000	400
A period transmit time = $0.4 \times 79 = 31.6$ Dwell time = pulse time $\times (1600/(4*79)) \times 31.6$				
DH5	2441	2.990	318.933	400
A period transmit time = $0.4 \times 79 = 31.6$ Dwell time = pulse time $\times (1600/(6*79)) \times 31.6$				

### $\pi/4$ DQPSK mode

Mode	Channel Frequency (MHz)	Pulse Time (ms)	Dwell Time (ms)	Limit (ms)
2DH1	2441	0.440	140.800	400
A period transmit time = $0.4 \times 79 = 31.6$ Dwell time = pulse time $\times (1600/(2*79)) \times 31.6$				
2DH3	2441	1.730	276.800	400
A period transmit time = $0.4 \times 79 = 31.6$ Dwell time = pulse time $\times (1600/(4*79)) \times 31.6$				
2DH5	2441	2.970	316.800	400
A period transmit time = $0.4 \times 79 = 31.6$ Dwell time = pulse time $\times (1600/(6*79)) \times 31.6$				

### 8DPSK mode

Mode	Channel Frequency (MHz)	Pulse Time (ms)	Dwell Time (ms)	Limit (ms)
3DH1	2441	0.450	144.000	400
A period transmit time = $0.4 \times 79 = 31.6$ Dwell time = pulse time $\times (1600/(2*79)) \times 31.6$				
3DH3	2441	1.720	275.200	400
A period transmit time = $0.4 \times 79 = 31.6$ Dwell time = pulse time $\times (1600/(4*79)) \times 31.6$				
3DH5	2441	2.980	317.867	400
A period transmit time = $0.4 \times 79 = 31.6$ Dwell time = pulse time $\times (1600/(6*79)) \times 31.6$				

Note: We tested GFSK mode,  $\pi/4$  DQPSK mode, 8DPSK mode and recorded the worst case data for all test mode.

The spectrum analyzer plots are attached as below.



### DH5 Middle channel

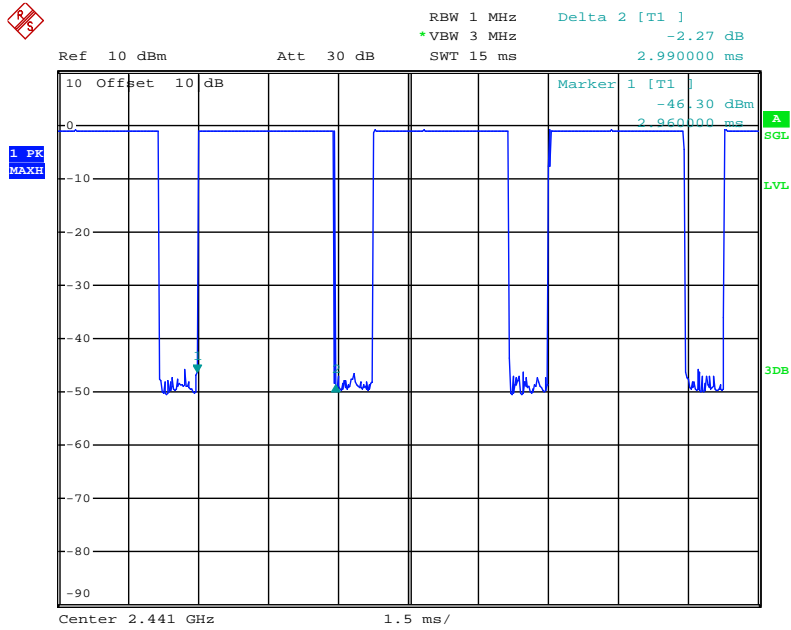

Date: 15.MAY.2020 17:09:08

### $\pi/4$ DQPSK Mode

### 2DH1 Middle channel

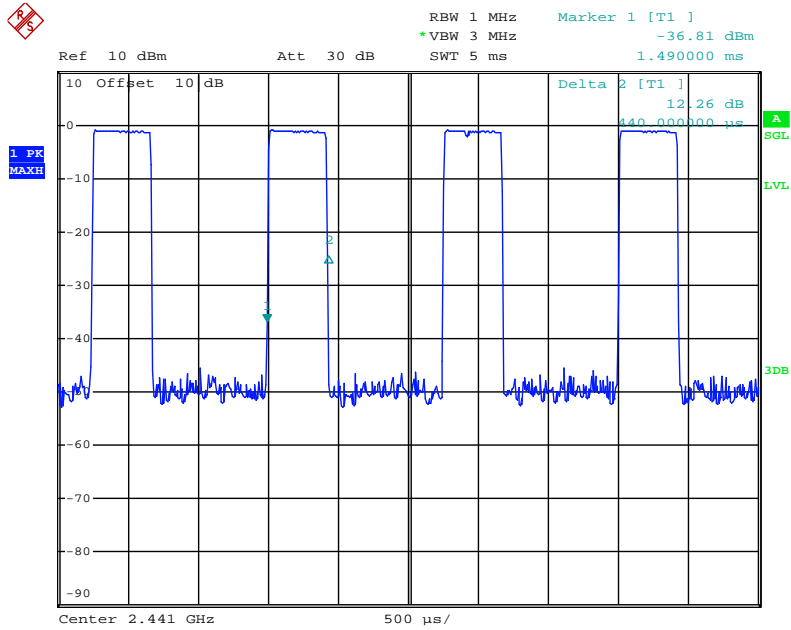

Date: 15.MAY.2020 17:08:39

### 2DH3 Middle channel

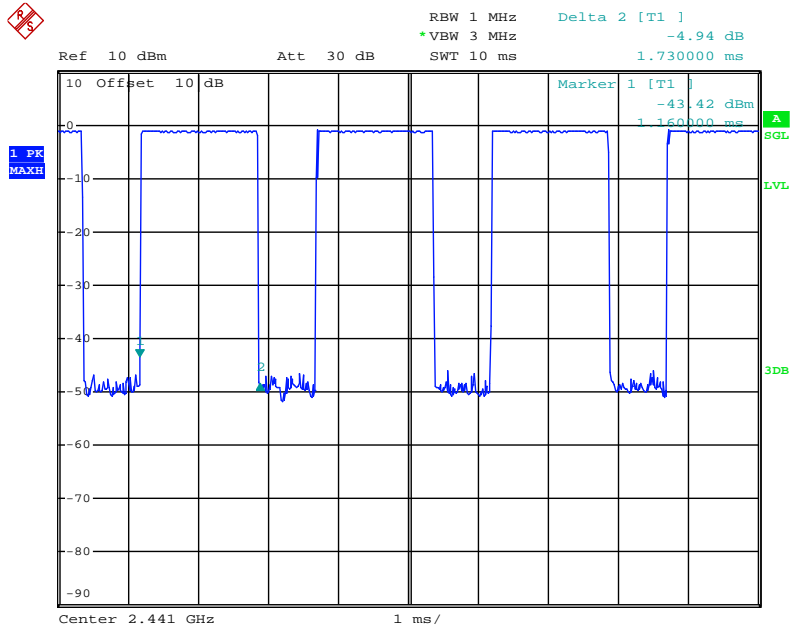

Date: 15.MAY.2020 17:08:08

### 2DH5 Middle channel

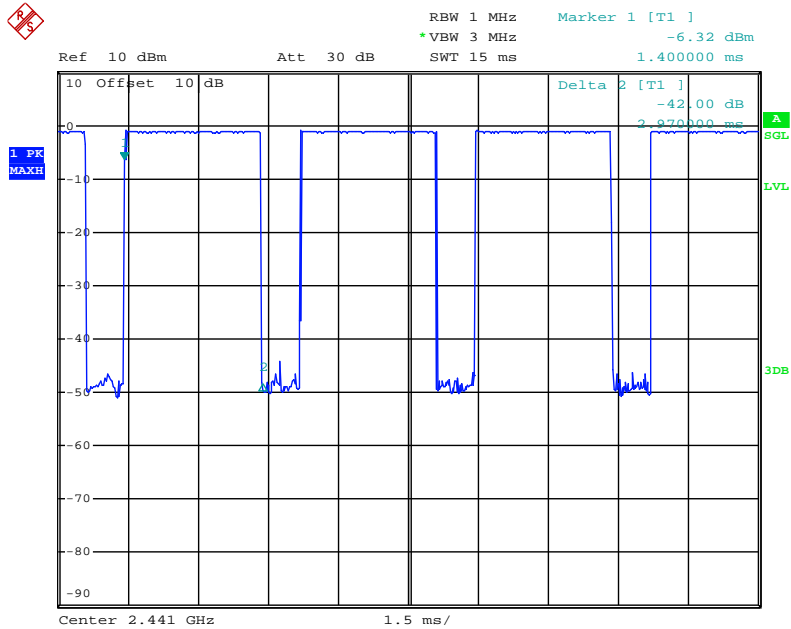

Date: 15.MAY.2020 17:07:34



## 8DPSK Mode

### 3DH1 Middle channel

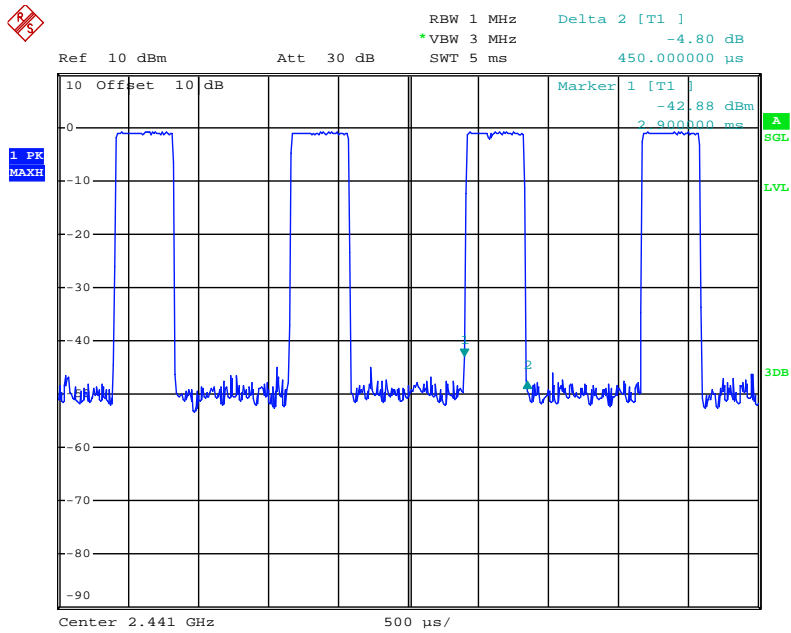

Date: 15.MAY.2020 17:06:36

### 3DH3 Middle channel

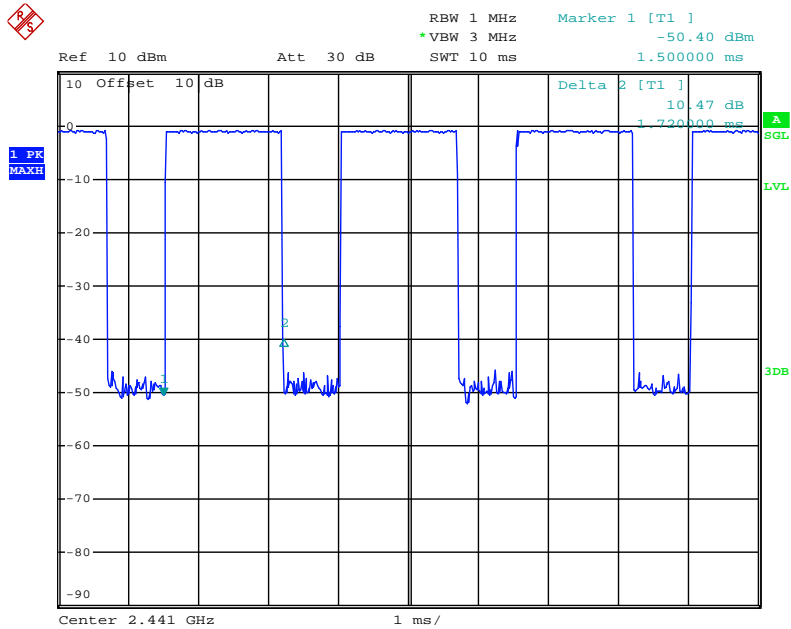

Date: 15.MAY.2020 17:05:57

### 3DH5 Middle channel

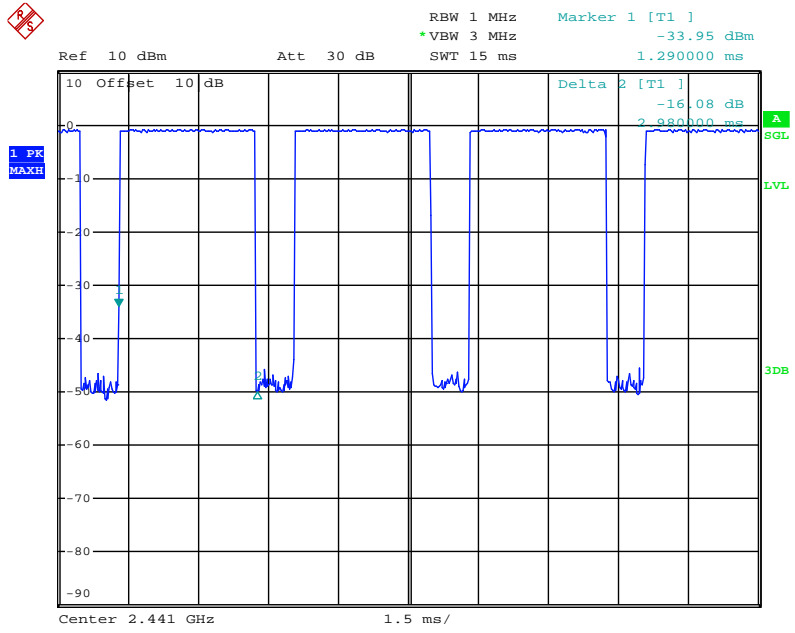

Date: 15.MAY.2020 17:05:13

## 9. MAXIMUM PEAK OUTPUT POWER TEST

### 9.1. Block Diagram of Test Setup

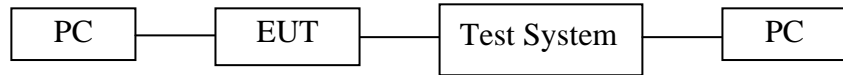

(EUT: Massage Chair)

### 9.2. The Requirement For Section 15.247(b)(1)

Section 15.247(b)(1): For frequency hopping systems operating in the 2400-2483.5 MHz band employing at least 75 non-overlapping hopping channels, and all frequency hopping systems in the 5725-5850 MHz band: 1 watt. For all other frequency hopping systems in the 2400-2483.5 MHz band: 0.125 watts.

### 9.3. EUT Configuration on Measurement

The equipment are installed on the emission Measurement to meet the commission requirements and operating regulations in a manner which tends to maximize its emission characteristics in normal application.

### 9.4. Operating Condition of EUT

9.4.1. Setup the EUT and simulator as shown as Section 9.1.

9.4.2. Turn on the power of all equipment.

9.4.3. Let the EUT work in TX (Hopping off) modes measure it. The transmit frequency are 2402-2480MHz. We select 2402MHz, 2441MHz, and 2480MHz TX frequency to transmit.

### 9.5. Test Procedure

9.5.1. The transmitter output was connected to the spectrum analyzer through a low loss cable.

9.5.2. Set RBW of spectrum analyzer to 3MHz and VBW to 10MHz for GFSK mode

9.5.3. Set RBW of spectrum analyzer to 3MHz and VBW to 10MHz for  $\pi/4$  DQPSK mode and 8DPSK mode

9.5.4. Measurement the maximum peak output power.

## 9.6. Test Result

### GFSK Mode

Channel	Frequency (MHz)	Peak Output Power (dBm/W)	Limits dBm / W
Low	2402	-0.99/0.000796	21 / 0.125
Middle	2441	-0.32/0.000929	21 / 0.125
High	2480	-0.07/0.000984	21 / 0.125

### $\pi/4$ DQPSK Mode

Channel	Frequency (MHz)	Peak Output Power (dBm/W)	Limits dBm / W
Low	2402	-1.78/0.000664	21 / 0.125
Middle	2441	-0.77/0.000838	21 / 0.125
High	2480	-0.44/0.000904	21 / 0.125

### 8DPSK Mode

Channel	Frequency (MHz)	Peak Output Power (dBm/W)	Limits dBm / W
Low	2402	-1.66/0.000682	21 / 0.125
Middle	2441	-0.68/0.000855	21 / 0.125
High	2480	-0.38/0.000916	21 / 0.125

The spectrum analyzer plots are attached as below.

## GFSK Mode

### Low channel

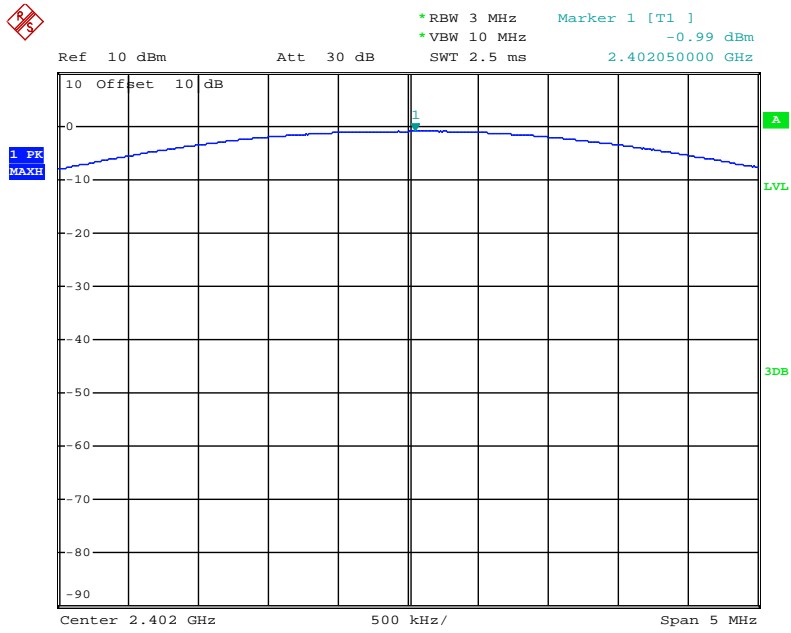

Date: 15.MAY.2020 11:38:30

### Middle channel

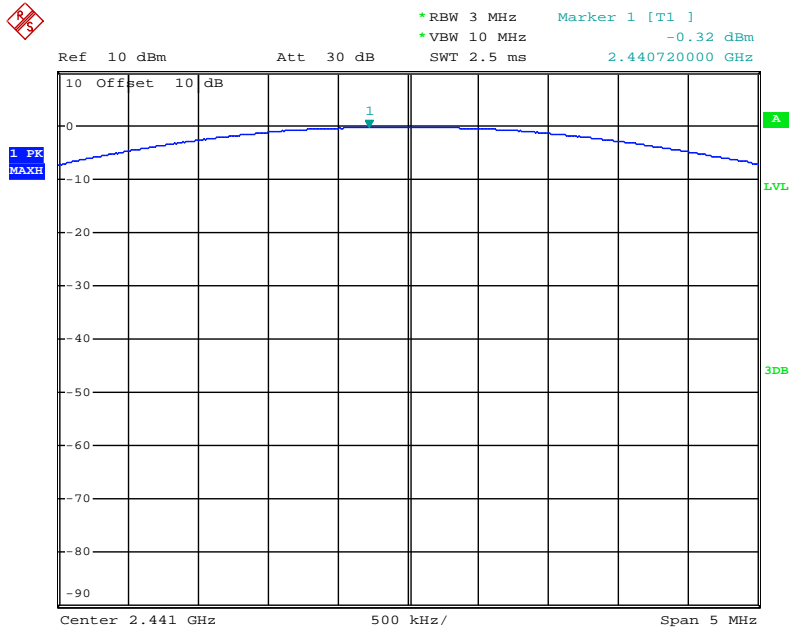

Date: 15.MAY.2020 11:38:48

### High channel

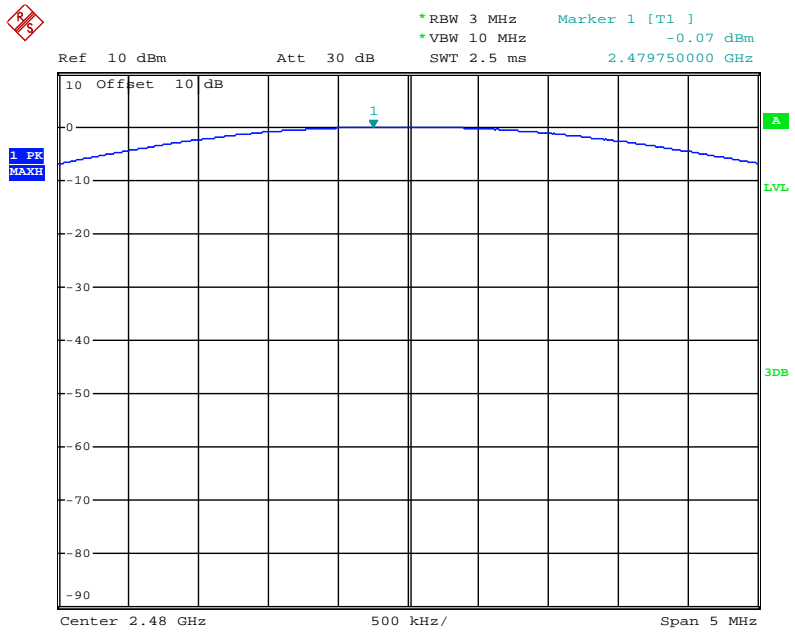

Date: 15.MAY.2020 11:39:04

### $\pi/4$ DQPSK Mode

### Low channel

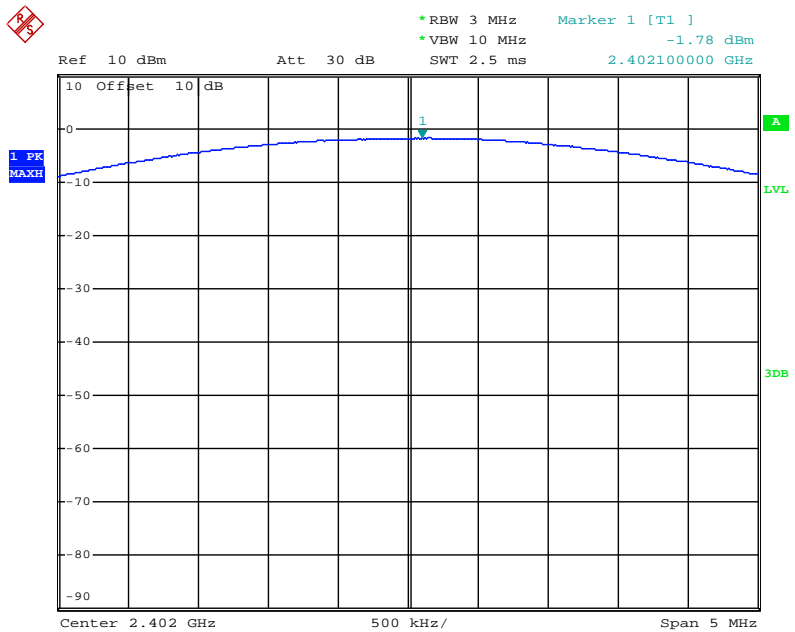

Date: 15.MAY.2020 11:35:56

### Middle channel

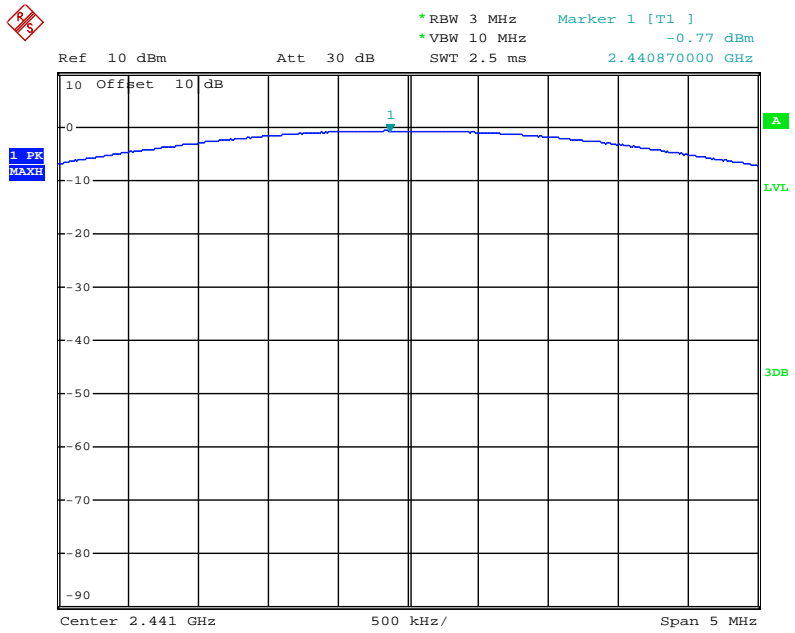

Date: 15.MAY.2020 11:36:16

### High channel

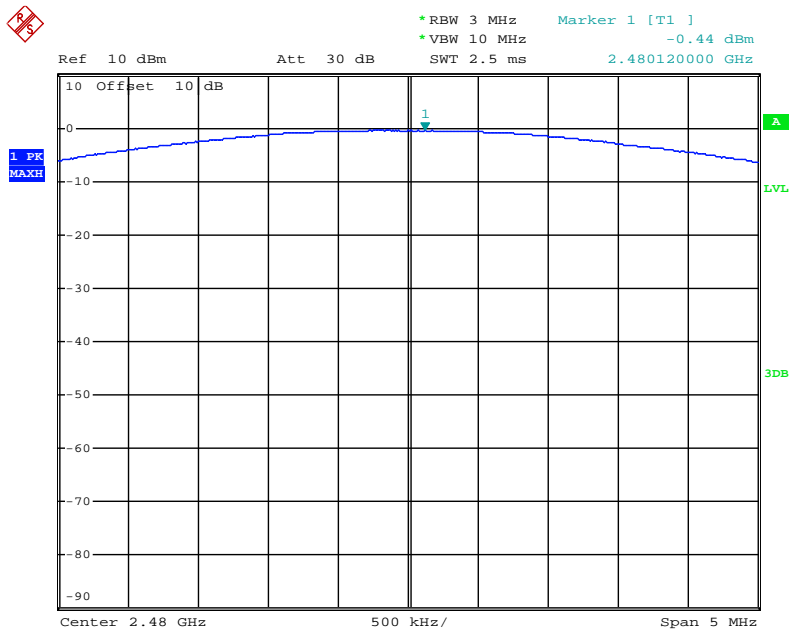

Date: 15.MAY.2020 11:36:34

### 8DPSK Mode

#### Low channel

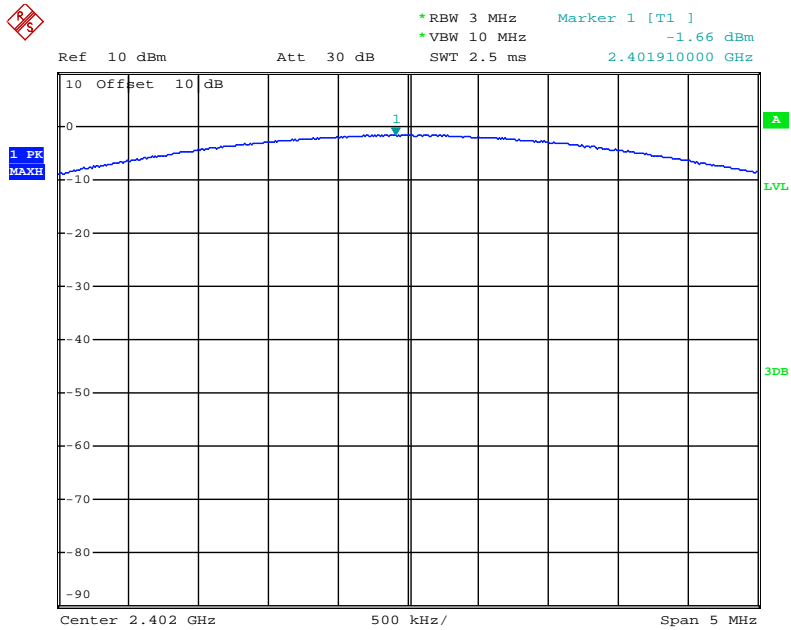

Date: 15.MAY.2020 11:37:31

#### Middle channel

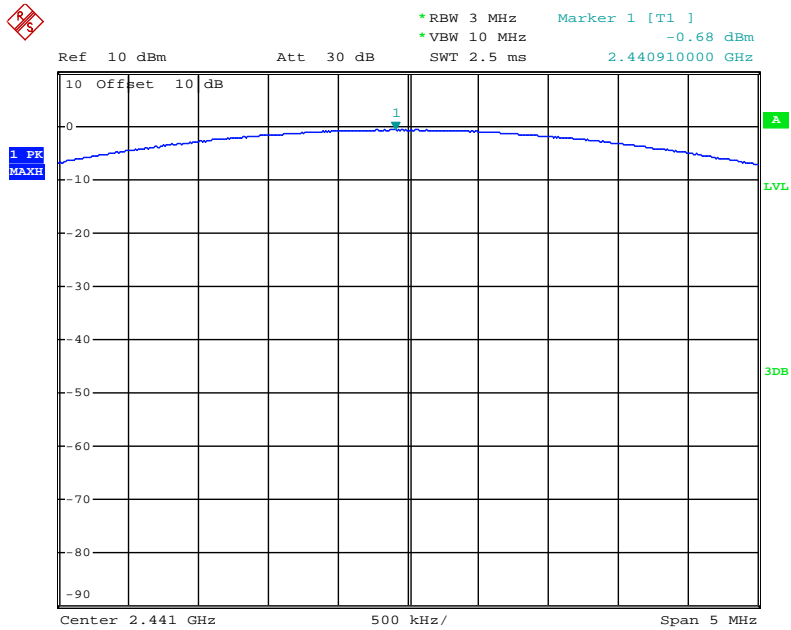

Date: 15.MAY.2020 11:37:15



### High channel

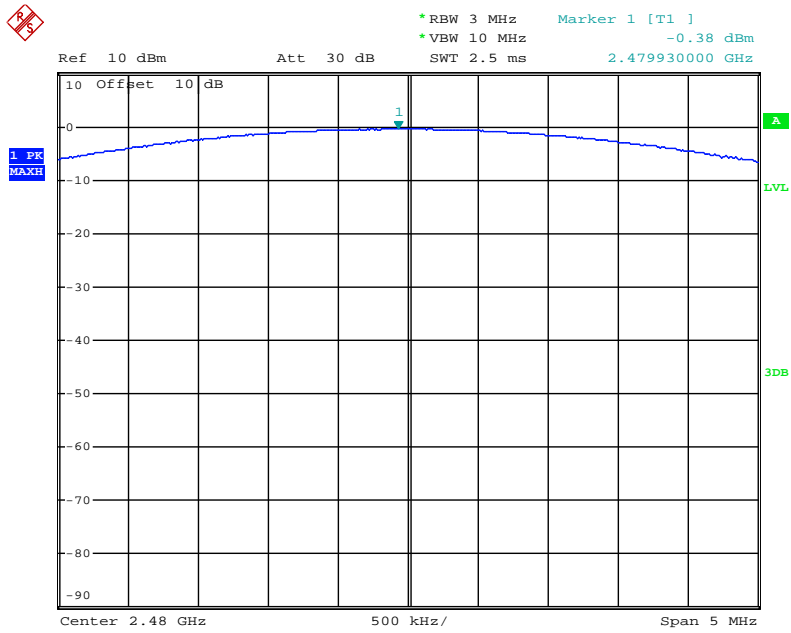

Date: 15.MAY.2020 11:36:56

## 10. RADIATED EMISSION TEST

### 10.1. Block Diagram of Test Setup

#### 10.1.1. Block diagram of connection between the EUT and peripherals

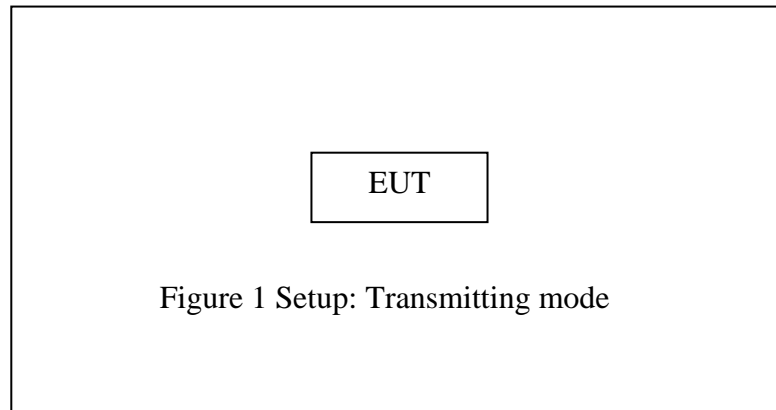

(EUT: Massage Chair)

#### 10.1.2. Semi-Anechoic Chamber Test Setup Diagram

##### (A) Radiated Emission Test Set-Up, Frequency below 30MHz

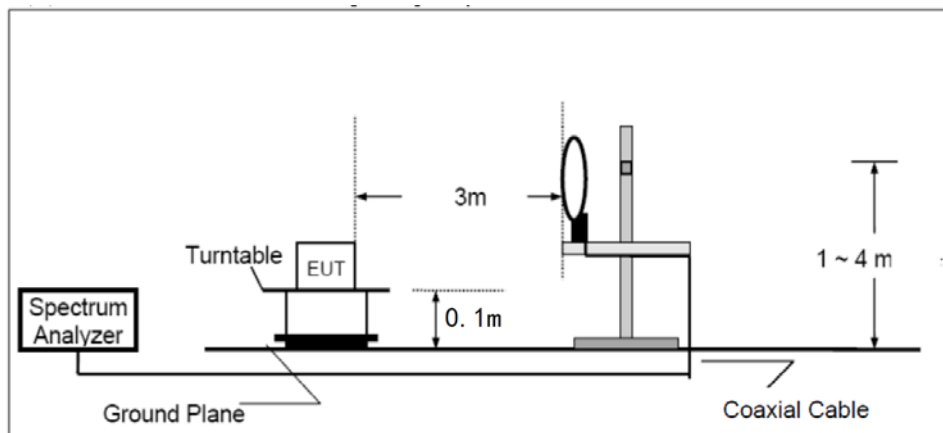

(B) Radiated Emission Test Set-Up, Frequency below 1GHz

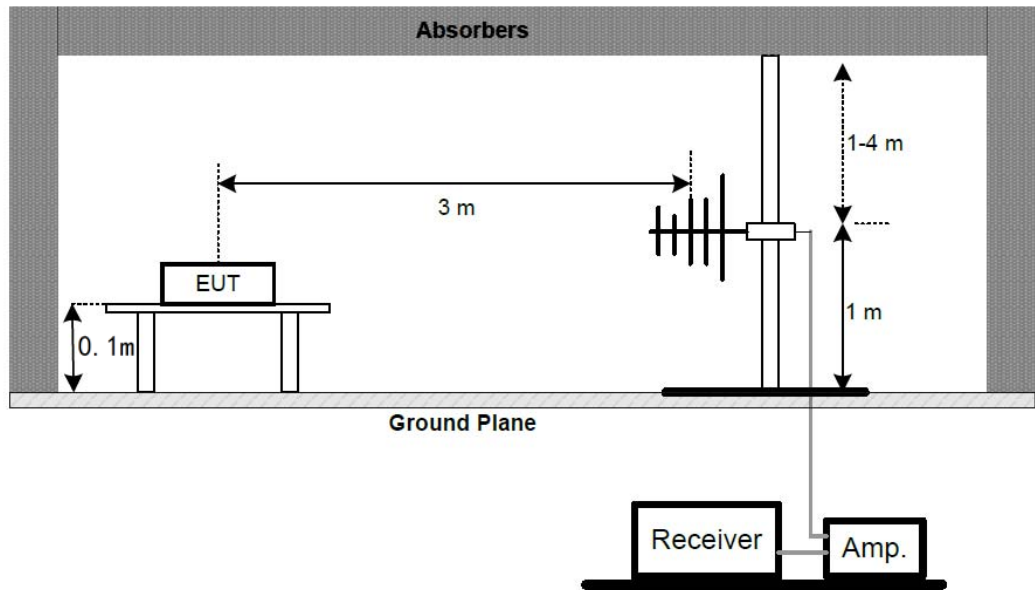

Above 1GHz:

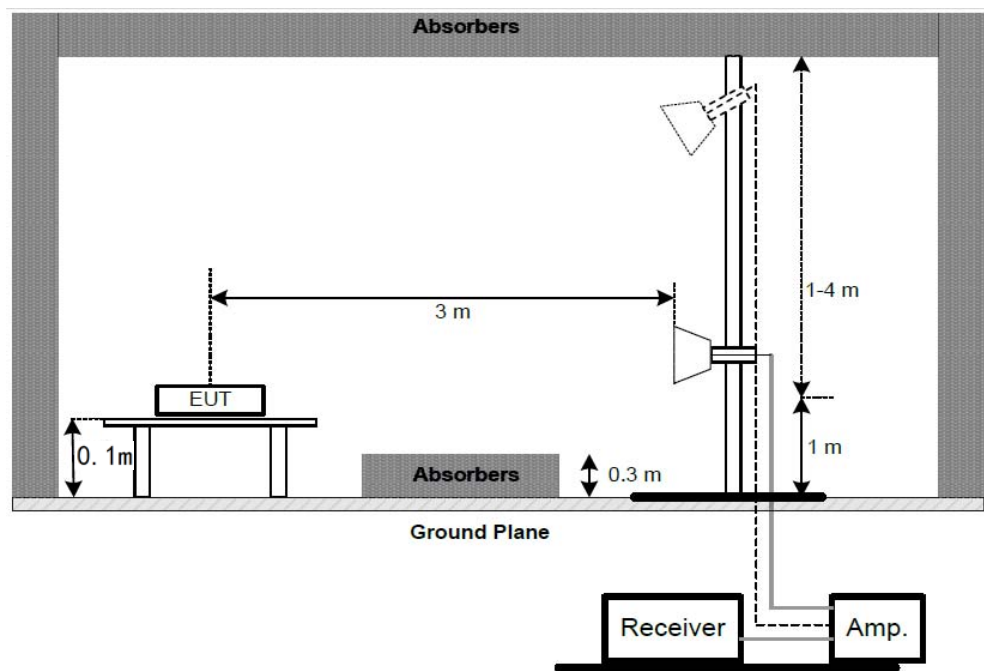

## 10.2.The Limit For Section 15.247(d)

Section 15.247(d): In any 100 kHz bandwidth outside the frequency band in which the spread spectrum or digitally modulated intentional radiator is operating, the radio frequency power that is produced by the intentional radiator shall be at least 20 dB below that in the 100 kHz bandwidth within the band that contains the highest level of the desired power, based on either an RF conducted or a radiated measurement, provided the transmitter demonstrates compliance with the peak conducted power limits. If the transmitter complies with the conducted power limits based on the use of RMS averaging over a time interval, as permitted under paragraph (b)(3) of this section, the attenuation required under this paragraph shall be 30 dB instead of 20 dB. Attenuation below the general limits specified in Section 15.209(a) is not required. In addition, radiated emissions which fall in the restricted bands, as defined in Section 15.205(a), must also comply with the radiated emission limits specified in Section 15.209(a).

## 10.3.Restricted bands of operation

### 10.3.1.FCC Part 15.205 Restricted bands of operation

(a) Except as shown in paragraph (d) of this section, Only spurious emissions are permitted in any of the frequency bands listed below:

MHz	MHz	MHz	GHz
0.090-0.110	16.42-16.423	399.9-410	4.5-5.15
<sup>1</sup> 0.495-0.505	16.69475-16.69525	608-614	5.35-5.46
2.1735-2.1905	16.80425-16.80475	960-1240	7.25-7.75
4.125-4.128	25.5-25.67	1300-1427	8.025-8.5
4.17725-4.17775	37.5-38.25	1435-1626.5	9.0-9.2
4.20725-4.20775	73-74.6	1645.5-1646.5	9.3-9.5
6.215-6.218	74.8-75.2	1660-1710	10.6-12.7
6.26775-6.26825	108-121.94	1718.8-1722.2	13.25-13.4
6.31175-6.31225	123-138	2200-2300	14.47-14.5
8.291-8.294	149.9-150.05	2310-2390	15.35-16.2
8.362-8.366	156.52475-156.52525	2483.5-2500	17.7-21.4
8.37625-8.38675	156.7-156.9	2690-2900	22.01-23.12
8.41425-8.41475	162.0125-167.17	3260-3267	23.6-24.0
12.29-12.293	167.72-173.2	3332-3339	31.2-31.8
12.51975-12.52025	240-285	3345.8-3358	36.43-36.5
12.57675-12.57725	322-335.4	3600-4400	( <sup>2</sup> )
13.36-13.41			

<sup>1</sup>Until February 1, 1999, this restricted band shall be 0.490-0.510

<sup>2</sup>Above 38.6

(b) Except as provided in paragraphs (d) and (e), the field strength of emission appearing within these frequency bands shall not exceed the limits shown in Section 15.209. At frequencies equal to or less than 1000MHz, Compliance with the limits in Section 15.209 shall be demonstrated using measurement instrumentation employing a CISPR quasi-peak detector. Above 1000MHz, compliance with the emission limits in Section 15.209 shall be demonstrated based on the average value of the measured emissions. The provisions in Section 15.35 apply to these measurements.

#### 10.4. Configuration of EUT on Measurement

The equipment is installed on Radiated Emission Measurement to meet the commission requirements and operating regulations in a manner which tends to maximize its emission characteristics in normal application.

#### 10.5. Test Procedure

The EUT and its simulators are placed on a turntable, which is 0.1 meter high above ground (Below 1GHz). The EUT and its simulators are placed on a turntable, which is 0.1 meter high above ground (Above 1GHz). The turntable can rotate 360 degrees to determine the position of the maximum emission level. EUT is set 3.0 meters away from the receiving antenna, which is mounted on an antenna tower. The antenna can be moved up and down between 1.0 meter and 4 meters to find out the maximum emission level. Broadband antenna (calibrated bi-log antenna) is used as receiving antenna. Both horizontal and vertical polarizations of the antenna are set on measurement. In order to find the maximum emission levels, all of the EUT location must be manipulated according to ANSI C63.10:2013 on radiated emission measurement. The EUT was tested in 3 orthogonal planes.

During the radiated emission test, the spectrum analyzer was set with the following configurations:

1. The resolution bandwidth and video bandwidth of test receiver/spectrum analyzer is 120kHz for Quasi-peak at frequency below 1GHz.
2. The resolution bandwidth of test receiver/spectrum analyzer is 1MHz and video bandwidth is 3MHz for peak measurement with peak detector at frequency above 1GHz.
3. The resolution bandwidth of test receiver/spectrum analyzer is 1MHz and video bandwidth is 10Hz for Average measurement with peak detection at frequency above 1GHz.
4. All modes of operation were investigated and the worst-case emissions are reported.

### 10.6.Data Sample

Frequency (MHz)	Reading (dB $\mu$ v)	Factor (dB/m)	Result (dB $\mu$ v/m)	Limit (dB $\mu$ v/m)	Margin (dB)	Remark
X.XX	28.66	-15.19	13.47	40.0	-26.53	QP

Frequency(MHz) = Emission frequency in MHz

Reading(dB $\mu$ v) = Uncorrected Analyzer/Receiver reading

Factor (dB/m) = Antenna factor + Cable Loss – Amplifier gain

Result(dB $\mu$ v/m) = Reading(dB $\mu$ v) + Factor(dB/m)

Limit (dB $\mu$ v/m) = Limit stated in standard

Margin (dB) = Result(dB $\mu$ v/m) - Limit (dB $\mu$ v/m)

QP = Quasi-peak Reading

Calculation Formula:

Margin(dB) = Result (dB $\mu$ V/m)–Limit(dB $\mu$ V/m)

Result(dB $\mu$ V/m)= Reading(dB $\mu$ V)+ Factor(dB/m)

The “Margin” column of the following data tables indicates the degree of compliance with the applicable limit. For example, a margin of -7dB means the emission is 7dB below the limit.

### 10.7.The Field Strength of Radiation Emission Measurement Results

**Note: 1.We tested GFSK mode,  $\pi$ /4 DQPSK Mode, 8DPSK Mode and recorded the worst case data (GFSK mode) from 30MHz-1GHz.**

**2.We tested GFSK mode,  $\pi$ /4 DQPSK Mode, 8DPSK Mode and recorded the worst case data(GFSK mode) from 1GHz-25GHz.**

**3. The test frequency is from 9KHz to 25GHz, The radiation emission from 9KHz-30MHz and 18-25GHz are not reported, because the levels are too low against the limit.**

## Below 1GHz

**ACCURATE TECHNOLOGY CO., LTD.**

 F1,Bldg,A,Changyuan New Material Port Keyuan Rd,  
 Science & Industry Park,Nanshan Shenzhen,P.R.China

Site: 1# Chamber

Tel:+86-0755-26503290

Fax:+86-0755-26503396

Job No.: mfl #7

Standard: FCC Class B 3M Radiated

Test item: Radiation Test

Temp.( C)/Hum.(%) 25 C / 55 %

EUT: Massage Chair

Mode: TX 2402MHz

Model: EC-802T

Manufacturer: XIAMEN HEALTHCARE ELECHRONIC CO., LTD.

Polarization: Horizontal

Power Source: AC 120V/60Hz

Date: 2020/04/28/

Time: 9/54/58

Engineer Signature:

Distance: 3m

Note: Report NO.:ATE20200296

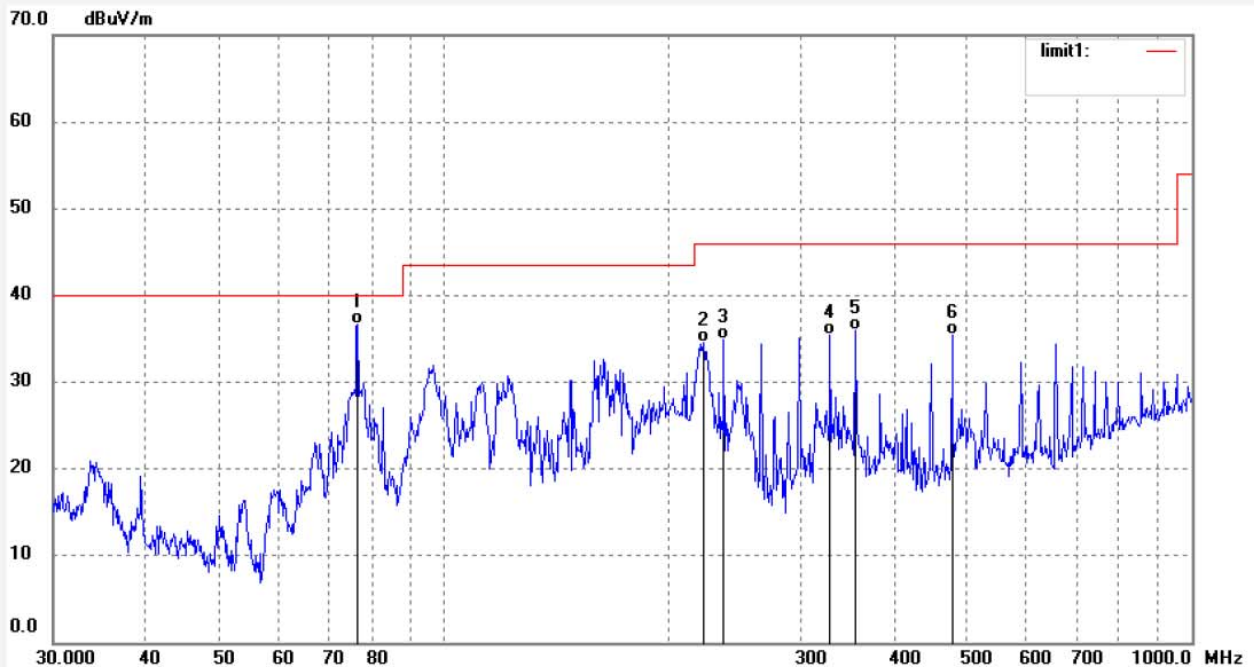

No.	Freq. (MHz)	Reading (dBuV/m)	Factor (dB)	Result (dBuV/m)	Limit (dBuV/m)	Margin (dB)	Detector	Height (cm)	Degree (deg.)	Remark
1	76.6556	64.33	-27.60	36.73	40.00	-3.27	QP	200	140	
2	222.2803	58.47	-23.98	34.49	46.00	-11.51	QP	200	69	
3	236.7924	58.61	-23.78	34.83	46.00	-11.17	QP	200	321	
4	328.3068	55.68	-20.25	35.43	46.00	-10.57	QP	200	205	
5	354.6911	55.07	-19.14	35.93	46.00	-10.07	QP	200	63	
6	478.1394	52.16	-16.65	35.51	46.00	-10.49	QP	200	115	

Job No.: mfl #8

Standard: FCC Class B 3M Radiated

Test item: Radiation Test

Temp.( C)/Hum.(%) 25 C / 55 %

EUT: Massage Chair

Mode: TX 2402MHz

Model: EC-802T

Manufacturer: XIAMEN HEALTHCARE ELECHRONIC CO., LTD.

Polarization: Vertical

Power Source: AC 120V/60Hz

Date: 2020/04/28/

Time: 10/02/15

Engineer Signature:

Distance: 3m

Note: Report NO.:ATE20200296

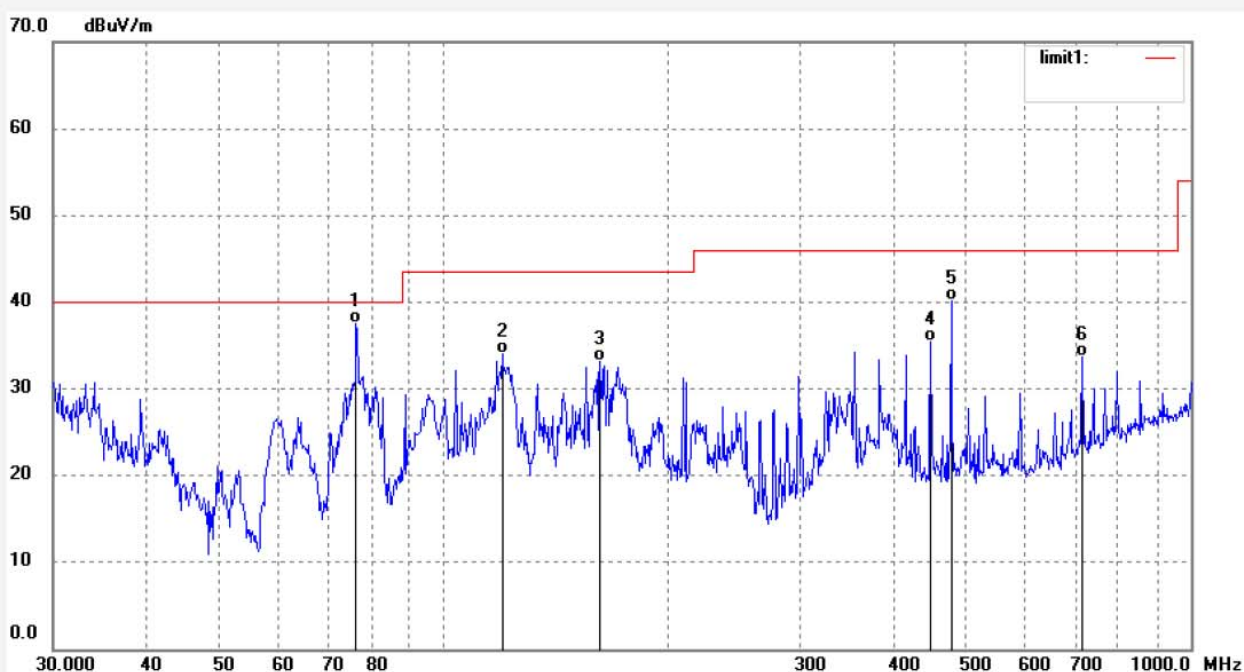

No.	Freq. (MHz)	Reading (dBuV/m)	Factor (dB)	Result (dBuV/m)	Limit (dBuV/m)	Margin (dB)	Detector	Height (cm)	Degree (deg.)	Remark
1	76.3867	65.16	-27.61	37.55	40.00	-2.45	QP	100	103	
2	119.7672	61.54	-27.43	34.11	43.50	-9.39	QP	100	62	
3	162.0197	60.06	-26.86	33.20	43.50	-10.30	QP	100	117	
4	448.8360	52.80	-17.28	35.52	46.00	-10.48	QP	100	82	
5	478.1394	56.87	-16.65	40.22	46.00	-5.78	QP	100	326	
6	716.2038	44.80	-11.09	33.71	46.00	-12.29	QP	100	91	



Job No.: mfl #10

Standard: FCC Class B 3M Radiated

Test item: Radiation Test

Temp.( C)/Hum.(%) 25 C / 55 %

EUT: Massage Chair

Mode: TX 2441MHz

Model: EC-802T

Manufacturer: XIAMEN HEALTHCARE ELECHRONIC CO., LTD.

Polarization: Horizontal

Power Source: AC 120V/60Hz

Date: 2020/04/28/

Time: 10/12/12

Engineer Signature:

Distance: 3m

Note: Report NO.:ATE20200296

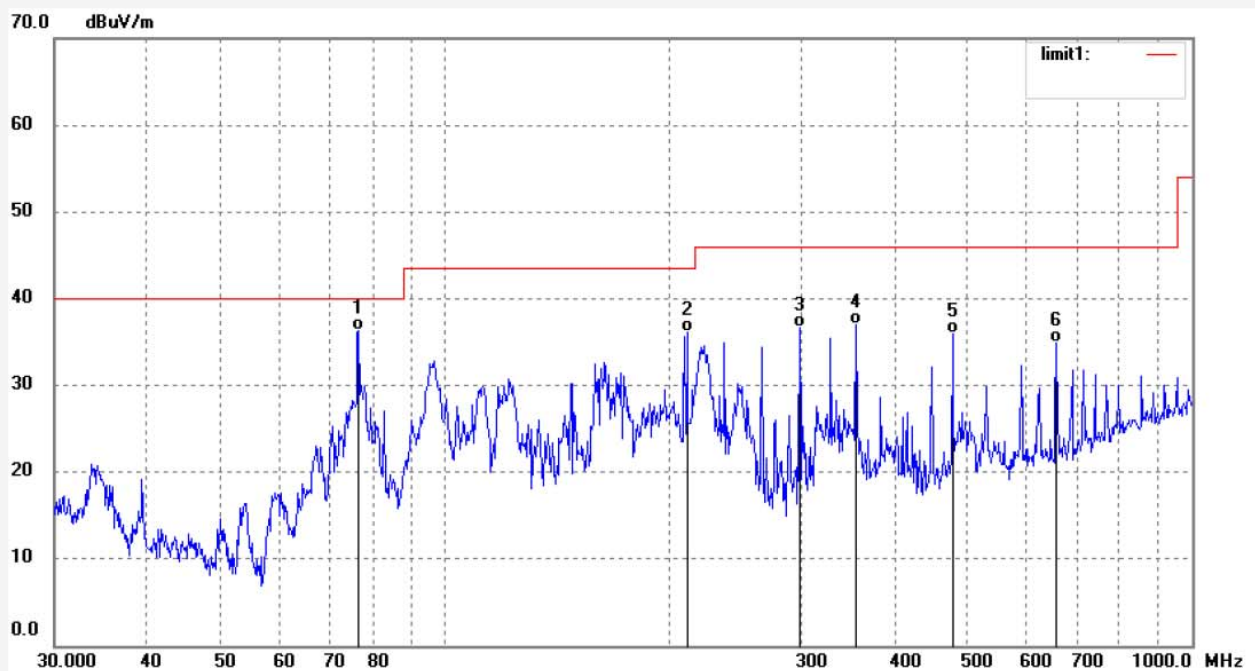

No.	Freq. (MHz)	Reading (dBuV/m)	Factor (dB)	Result (dBuV/m)	Limit (dBuV/m)	Margin (dB)	Detector	Height (cm)	Degree (deg.)	Remark
1	76.6556	63.83	-27.60	36.23	40.00	-3.77	QP	200	109	
2	210.8685	60.22	-24.10	36.12	43.50	-7.38	QP	200	63	
3	298.5932	57.95	-21.28	36.67	46.00	-9.33	QP	200	146	
4	354.6911	56.07	-19.14	36.93	46.00	-9.07	QP	200	321	
5	478.1394	52.66	-16.65	36.01	46.00	-9.99	QP	200	204	
6	658.2853	47.38	-12.44	34.94	46.00	-11.06	QP	200	52	

Job No.: mfl #9

Standard: FCC Class B 3M Radiated

Test item: Radiation Test

Temp.( C)/Hum.(%) 25 C / 55 %

EUT: Massage Chair

Mode: TX 2441MHz

Model: EC-802T

Manufacturer: XIAMEN HEALTHCARE ELECHRONIC CO., LTD.

Polarization: Vertical

Power Source: AC 120V/60Hz

Date: 2020/04/28/

Time: 10/06/12

Engineer Signature:

Distance: 3m

Note: Report NO.:ATE20200296

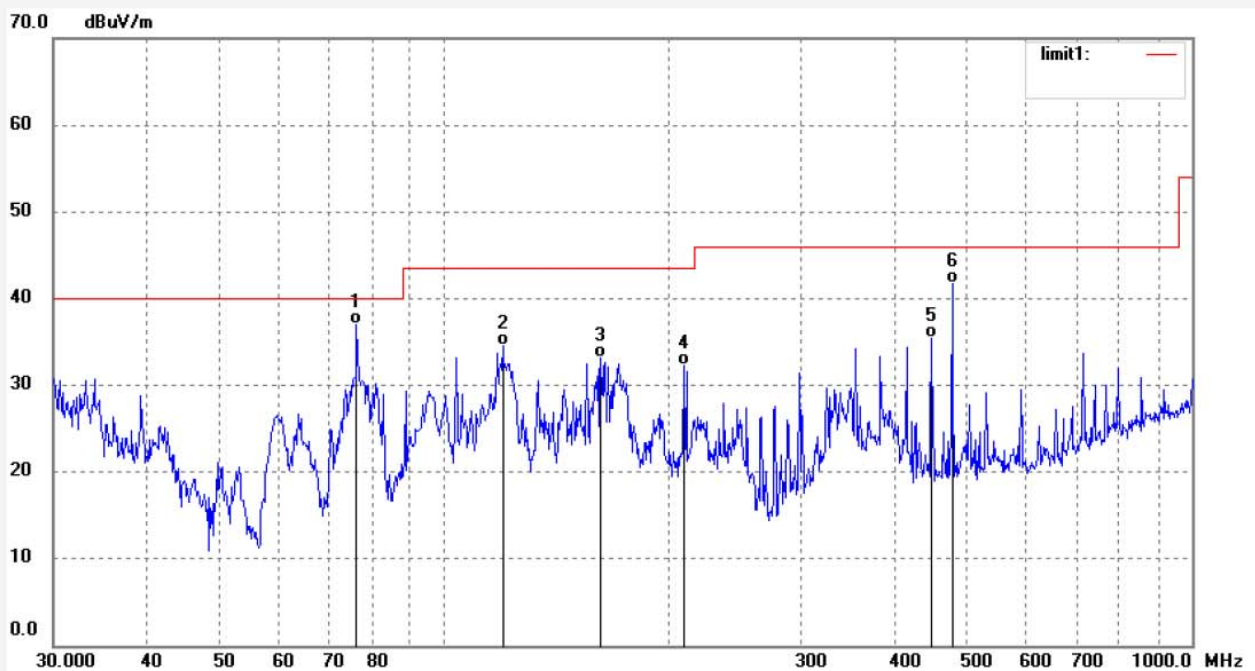

No.	Freq. (MHz)	Reading (dBuV/m)	Factor (dB)	Result (dBuV/m)	Limit (dBuV/m)	Margin (dB)	Detector	Height (cm)	Degree (deg.)	Remark
1	76.3867	64.66	-27.61	37.05	40.00	-2.95	QP	100	103	
2	119.7672	62.04	-27.43	34.61	43.50	-8.89	QP	100	62	
3	162.0197	60.06	-26.86	33.20	43.50	-10.30	QP	100	115	
4	209.3924	56.34	-24.12	32.22	43.50	-11.28	QP	100	92	
5	448.8360	52.80	-17.28	35.52	46.00	-10.48	QP	100	128	
6	478.1394	58.37	-16.65	41.72	46.00	-4.28	QP	100	164	

Job No.: mfl #11

Standard: FCC Class B 3M Radiated

Test item: Radiation Test

Temp.( C)/Hum.(%) 25 C / 55 %

EUT: Massage Chair

Mode: TX 2480MHz

Model: EC-802T

Manufacturer: XIAMEN HEALTHCARE ELECHRONIC CO., LTD.

Polarization: Horizontal

Power Source: AC 120V/60Hz

Date: 2020/04/28/

Time: 10/16/42

Engineer Signature:

Distance: 3m

Note: Report NO.:ATE20200296

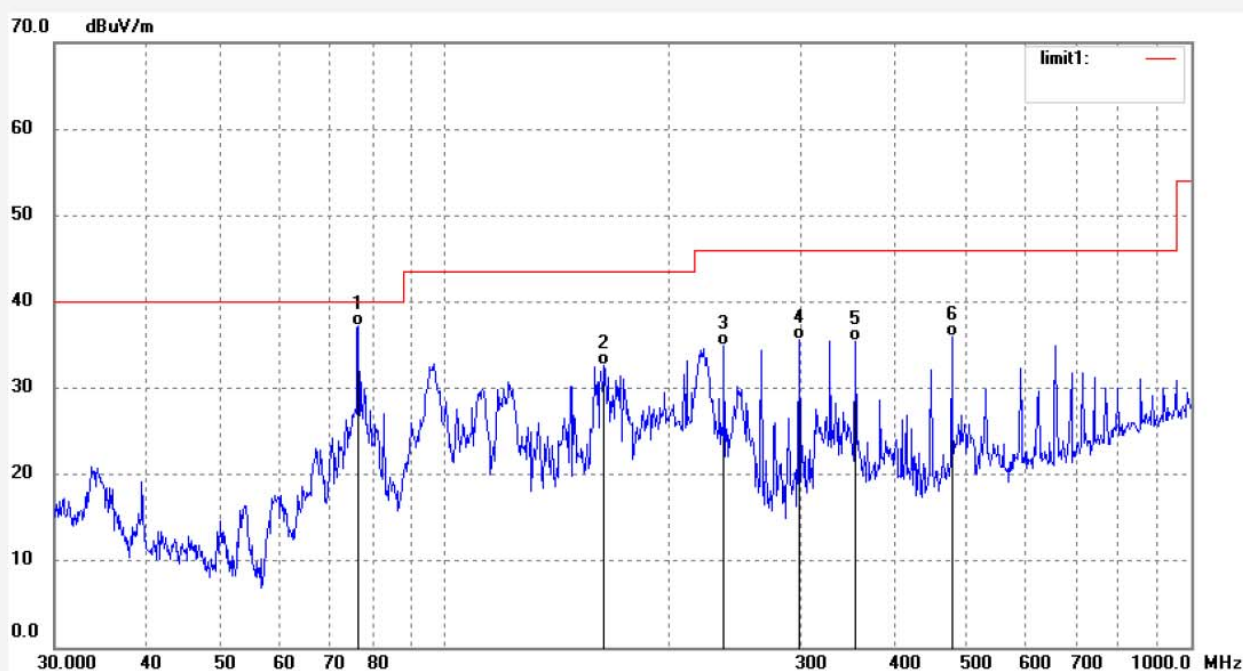

No.	Freq. (MHz)	Reading (dBuV/m)	Factor (dB)	Result (dBuV/m)	Limit (dBuV/m)	Margin (dB)	Detector	Height (cm)	Degree (deg.)	Remark
1	76.6556	64.83	-27.60	37.23	40.00	-2.77	QP	200	331	
2	163.7366	59.31	-26.68	32.63	43.50	-10.87	QP	200	66	
3	236.7923	58.61	-23.78	34.83	46.00	-11.17	QP	200	115	
4	298.5932	56.95	-21.28	35.67	46.00	-10.33	QP	200	201	
5	354.6911	54.57	-19.14	35.43	46.00	-10.57	QP	200	32	
6	478.1394	52.66	-16.65	36.01	46.00	-9.99	QP	200	164	

Job No.: mfl #12

Standard: FCC Class B 3M Radiated

Test item: Radiation Test

Temp.( C)/Hum.(%) 25 C / 55 %

EUT: Massage Chair

Mode: TX 2480MHz

Model: EC-802T

Manufacturer: XIAMEN HEALTHCARE ELECHRONIC CO., LTD.

Polarization: Vertical

Power Source: AC 120V/60Hz

Date: 2020/04/28/

Time: 10/17/10

Engineer Signature:

Distance: 3m

Note: Report NO.:ATE20200296

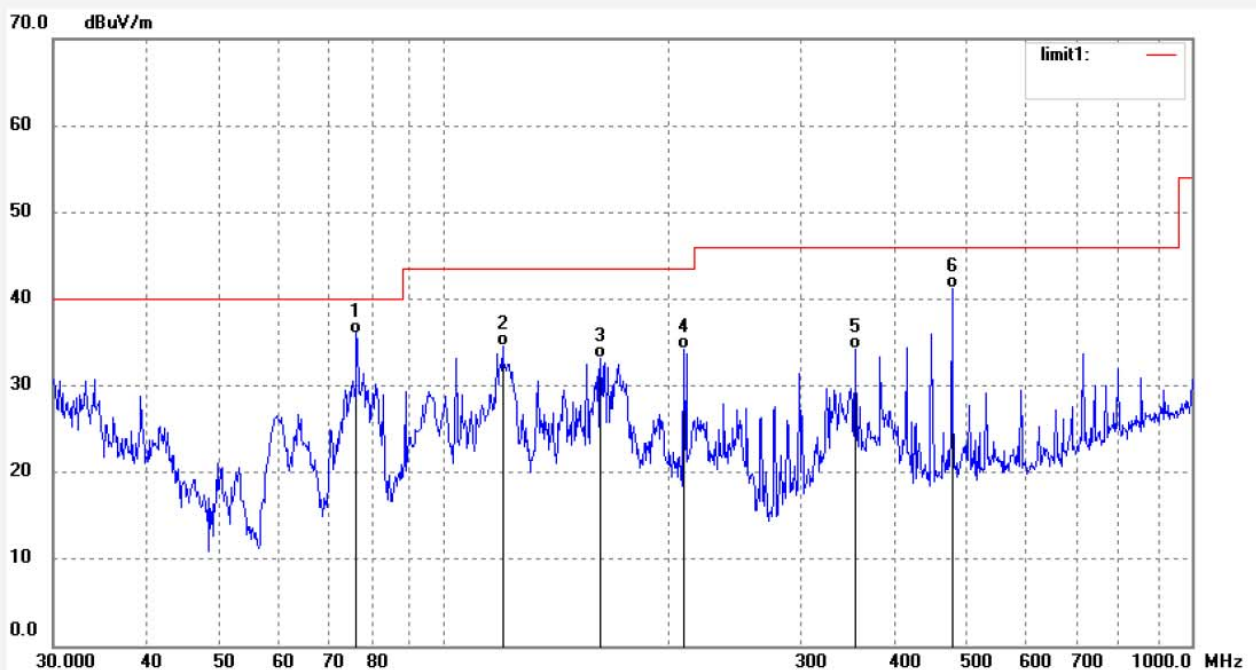

No.	Freq. (MHz)	Reading (dBuV/m)	Factor (dB)	Result (dBuV/m)	Limit (dBuV/m)	Margin (dB)	Detector	Height (cm)	Degree (deg.)	Remark
1	76.3867	63.66	-27.61	36.05	40.00	-3.95	QP	100	166	
2	119.7672	62.04	-27.43	34.61	43.50	-8.89	QP	100	112	
3	162.0197	60.06	-26.86	33.20	43.50	-10.30	QP	100	96	
4	209.3924	58.34	-24.12	34.22	43.50	-9.28	QP	100	21	
5	354.6911	53.43	-19.14	34.29	46.00	-11.71	QP	100	33	
6	478.1394	57.87	-16.65	41.22	46.00	-4.78	QP	100	1069	

## Above 1GHz

**ACCURATE TECHNOLOGY CO., LTD.**

 F1,Bldg,A,Changyuan New Material Port Keyuan Rd,  
 Science & Industry Park,Nanshan Shenzhen,P.R.China

Site: 2# Chamber

Tel:+86-0755-26503290

Fax:+86-0755-26503396

Job No.: jp2020 #62

Standard: FCC PK

Test item: Radiation Test

Temp.( C)/Hum.(%) 23 C / 48 %

EUT: Massage Chair

Mode: TX 2402MHz

Model: EC-802T

Manufacturer: XIAMEN HEALTHCARE ELECHRONIC CO., LTD.

Polarization: Horizontal

Power Source: AC 120V/60Hz

Date: 2020/04/28/

Time: 8/36/00

Engineer Signature: Ben

Distance: 3m

Note: Report NO.:ATE20200296

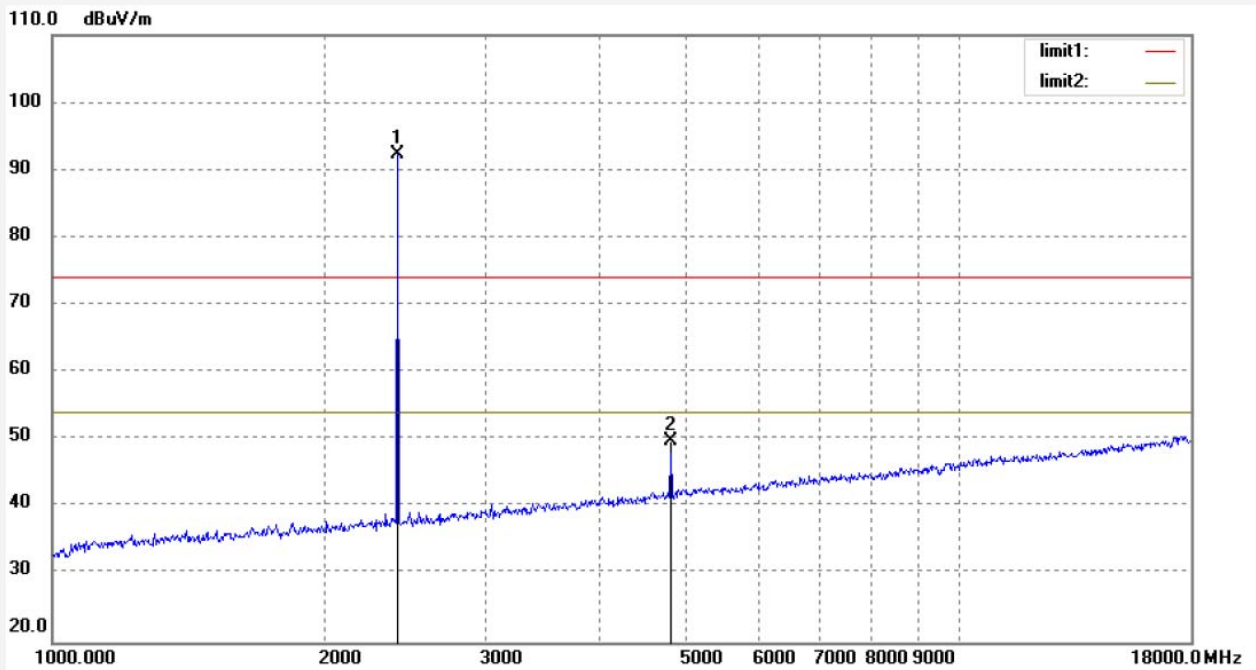

No.	Freq. (MHz)	Reading (dBuV/m)	Factor (dB)	Result (dBuV/m)	Limit (dBuV/m)	Margin (dB)	Detector	Height (cm)	Degree (deg.)	Remark
1	2402.000	91.39	0.88	92.27			peak	250	136	
2	4804.000	42.52	7.40	49.92	74.00	-24.08	peak	250	136	

Job No.: jp2020 #63

Standard: FCC PK

Test item: Radiation Test

Temp.( C)/Hum.(%) 23 C / 48 %

EUT: Massage Chair

Mode: TX 2402MHz

Model: EC-802T

Manufacturer: XIAMEN HEALTHCARE ELECHRONIC CO., LTD.

Polarization: Vertical

Power Source: AC 120V/60Hz

Date: 2020/04/28/

Time: 8/37/03

Engineer Signature: Ben

Distance: 3m

Note: Report NO.:ATE20200296

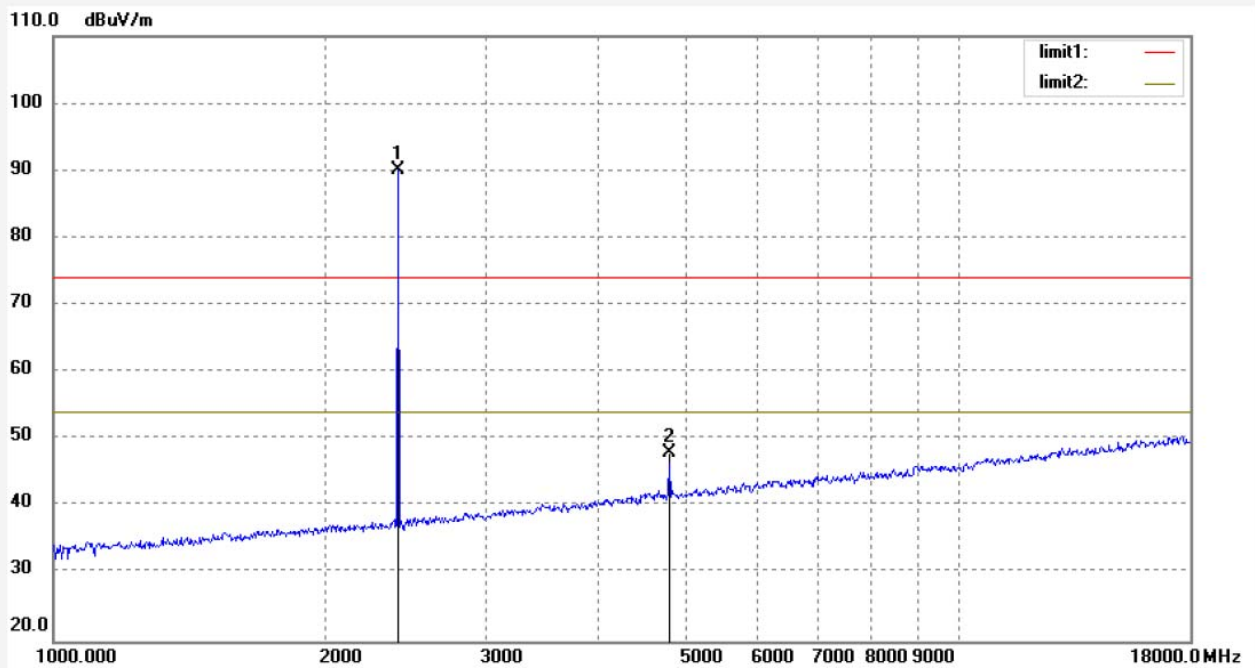

No.	Freq. (MHz)	Reading (dBuV/m)	Factor (dB)	Result (dBuV/m)	Limit (dBuV/m)	Margin (dB)	Detector	Height (cm)	Degree (deg.)	Remark
1	2402.000	89.17	0.88	90.05			peak	150	186	
2	4804.000	40.74	7.30	48.04	74.00	-25.96	peak	150	186	



**ACCURATE TECHNOLOGY CO., LTD.**

F1,Bldg,A,Changyuan New Material Port Keyuan Rd,  
Science & Industry Park,Nanshan Shenzhen,P.R.China

Site: 2# Chamber

Tel:+86-0755-26503290

Fax:+86-0755-26503396

Job No.: jp2020 #65

Standard: FCC PK

Test item: Radiation Test

Temp.( C)/Hum.(%) 23 C / 48 %

EUT: Massage Chair

Mode: TX 2441MHz

Model: EC-802T

Manufacturer: XIAMEN HEALTHCARE ELECHRONIC CO., LTD.

Polarization: Horizontal

Power Source: AC 120V/60Hz

Date: 2020/04/28/

Time: 8/39/48

Engineer Signature: Ben

Distance: 3m

Note: Report NO.:ATE20200296

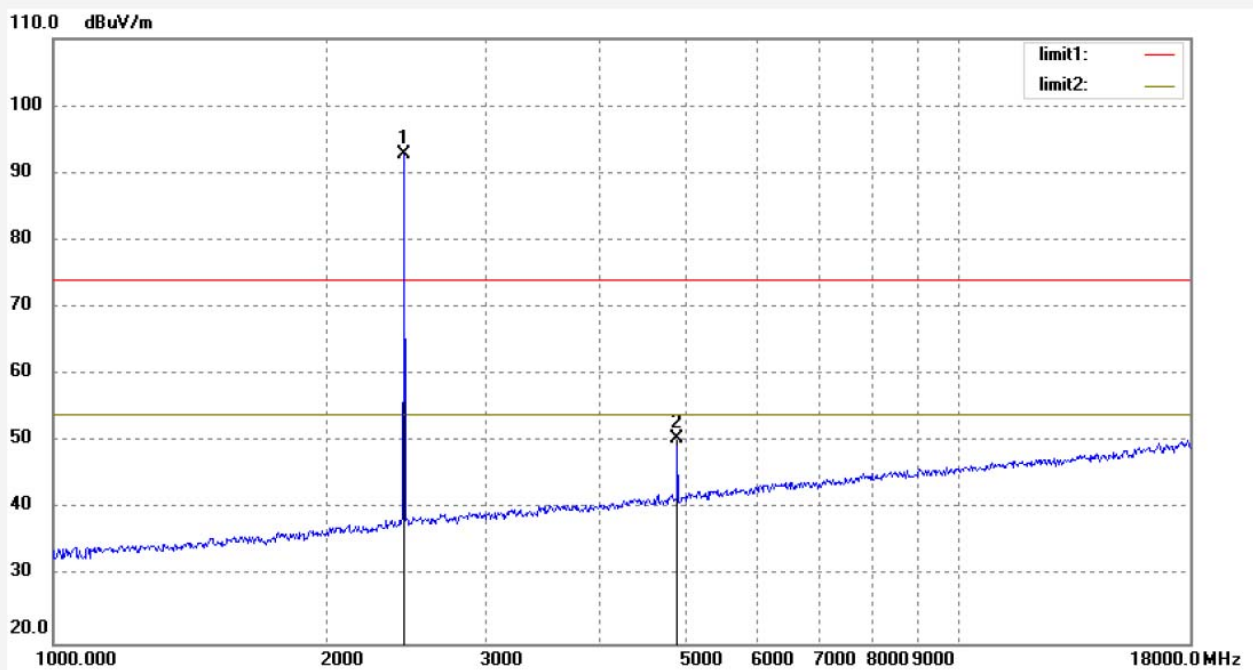

No.	Freq. (MHz)	Reading (dBuV/m)	Factor (dB)	Result (dBuV/m)	Limit (dBuV/m)	Margin (dB)	Detector	Height (cm)	Degree (deg.)	Remark
1	2441.000	91.62	1.06	92.68			peak	250	189	
2	4882.000	42.32	8.11	50.43	74.00	-23.57	peak	250	189	

Job No.: jp2020 #64

Standard: FCC PK

Test item: Radiation Test

Temp.( C)/Hum.(%) 23 C / 48 %

EUT: Massage Chair

Mode: TX 2441MHz

Model: EC-802T

Manufacturer: XIAMEN HEALTHCARE ELECHRONIC CO., LTD.

Polarization: Vertical

Power Source: AC 120V/60Hz

Date: 2020/04/28/

Time: 8/38/49

Engineer Signature: Ben

Distance: 3m

Note: Report NO.:ATE20200296

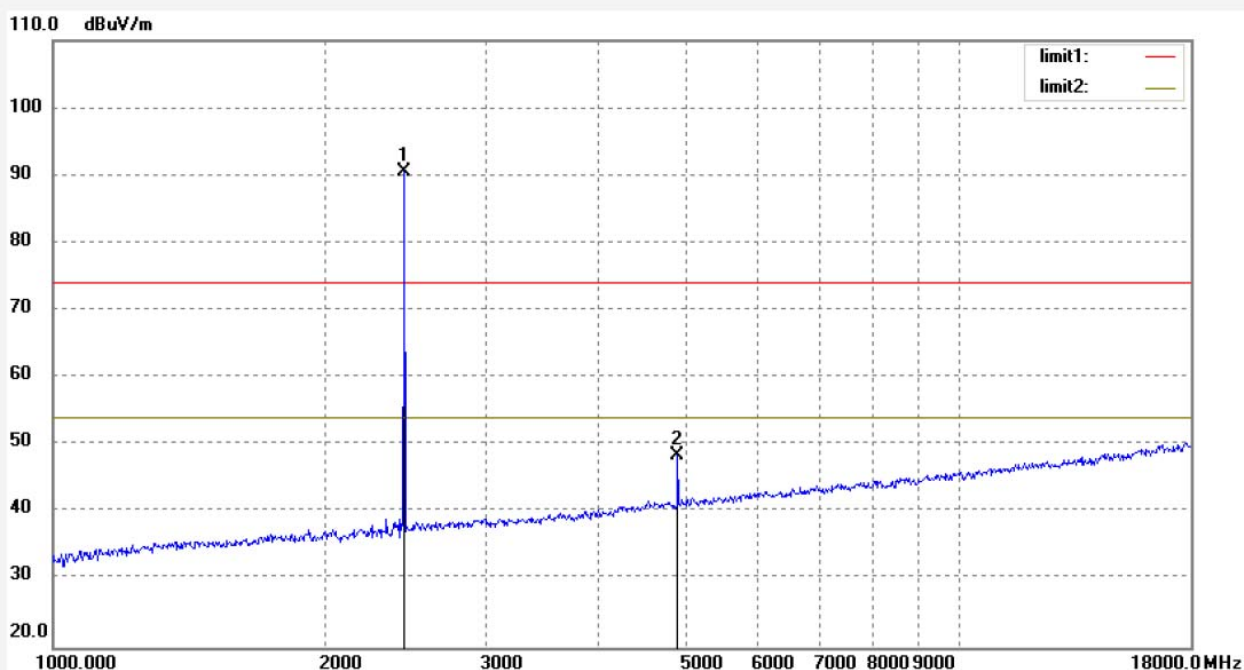

No.	Freq. (MHz)	Reading (dBuV/m)	Factor (dB)	Result (dBuV/m)	Limit (dBuV/m)	Margin (dB)	Detector	Height (cm)	Degree (deg.)	Remark
1	2441.000	89.50	1.06	90.56			peak	150	163	
2	4882.000	40.44	8.11	48.55	74.00	-25.45	peak	150	163	



Job No.: jp2020 #66

Standard: FCC PK

Test item: Radiation Test

Temp.( C)/Hum.(%) 23 C / 48 %

EUT: Massage Chair

Mode: TX 2480MHz

Model: EC-802T

Manufacturer: XIAMEN HEALTHCARE ELECHRONIC CO., LTD.

Polarization: Horizontal

Power Source: AC 120V/60Hz

Date: 2020/04/28/

Time: 8/41/32

Engineer Signature: Ben

Distance: 3m

Note: Report NO.:ATE20200296

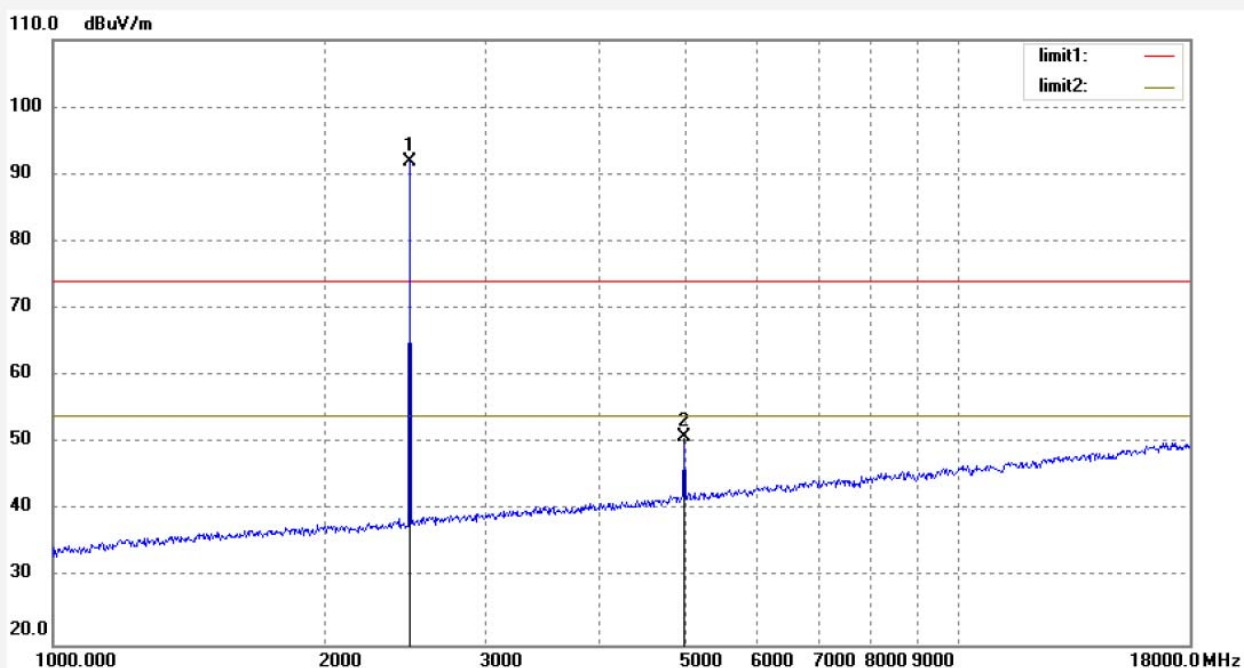

No.	Freq. (MHz)	Reading (dBuV/m)	Factor (dB)	Result (dBuV/m)	Limit (dBuV/m)	Margin (dB)	Detector	Height (cm)	Degree (deg.)	Remark
1	2480.000	90.86	1.09	91.95			peak	250	175	
2	4960.000	42.28	8.60	50.88	74.00	-23.12	peak	250	175	

Job No.: jp2020 #67

Standard: FCC PK

Test item: Radiation Test

Temp.( C)/Hum.(%) 23 C / 48 %

EUT: Massage Chair

Mode: TX 2480MHz

Model: EC-802T

Manufacturer: XIAMEN HEALTHCARE ELECHRONIC CO., LTD.

Polarization: Vertical

Power Source: AC 120V/60Hz

Date: 2020/04/28/

Time: 8/42/28

Engineer Signature: Ben

Distance: 3m

Note: Report NO.:ATE20200296

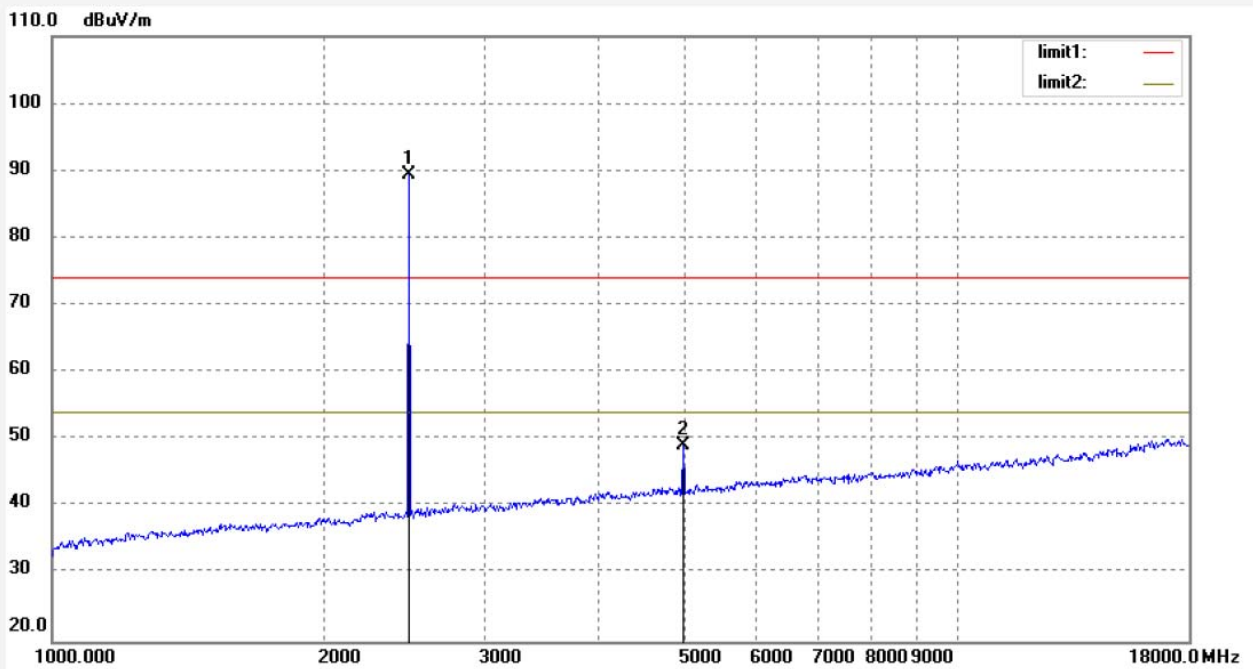

No.	Freq. (MHz)	Reading (dBuV/m)	Factor (dB)	Result (dBuV/m)	Limit (dBuV/m)	Margin (dB)	Detector	Height (cm)	Degree (deg.)	Remark
1	2480.000	88.37	1.09	89.46			peak	150	196	
2	4960.000	40.63	8.60	49.23	74.00	-24.77	peak	150	196	

## 11. BAND EDGE COMPLIANCE TEST

### 11.1. Block Diagram of Test Setup



(EUT: Massage Chair)

### 11.2. The Requirement For Section 15.247(d)

Section 15.247(d): In any 100 kHz bandwidth outside the frequency band in which the spread spectrum or digitally modulated intentional radiator is operating, the radio frequency power that is produced by the intentional radiator shall be at least 20 dB below that in the 100 kHz bandwidth within the band that contains the highest level of the desired power, based on either an RF conducted or a radiated measurement, provided the transmitter demonstrates compliance with the peak conducted power limits. If the transmitter complies with the conducted power limits based on the use of RMS averaging over a time interval, as permitted under paragraph (b)(3) of this section, the attenuation required under this paragraph shall be 30 dB instead of 20 dB. Attenuation below the general limits specified in Section 15.209(a) is not required. In addition, radiated emissions which fall in the restricted bands, as defined in Section 15.205(a), must also comply with the radiated emission limits specified in Section 15.209(a).

### 11.3. EUT Configuration on Measurement

The equipment are installed on the emission Measurement to meet the commission requirements and operating regulations in a manner which tends to maximize its emission characteristics in normal application.

### 11.4. Operating Condition of EUT

11.4.1. Setup the EUT and simulator as shown as Section 11.1.

11.4.2. Turn on the power of all equipment.

11.4.3. Let the EUT work in TX (Hopping off, Hopping on) modes measure it. The transmit frequency are 2402-2480MHz. We select 2402MHz, 2480MHz TX frequency to transmit.

### 11.5. Test Procedure

11.5.1. The transmitter output was connected to the spectrum analyzer via a low loss cable.

11.5.2. Set RBW of spectrum analyzer to 100 kHz and VBW to 300 kHz with convenient frequency span including 100 kHz bandwidth from band edge.

11.5.3. The band edges was measured and recorded.

### 11.6. Test Result

Frequency (MHz)	Result of Band Edge (dBc)	Limit of Band Edge (dBc)
GFSK		
2400.00	39.12	> 20dBc
2483.50	55.38	> 20dBc
$\pi/4$ DQPSK Mode		
2400.00	42.15	> 20dBc
2483.50	47.00	> 20dBc
8DPSK Mode		
2400.00	41.54	> 20dBc
2483.50	46.75	> 20dBc

Note: Both hopping-on mode and hopping-off mode had been pre-tested, and only the worst case was recorded in the test report.

The spectrum analyzer plots are attached as below.

### GFSK Mode

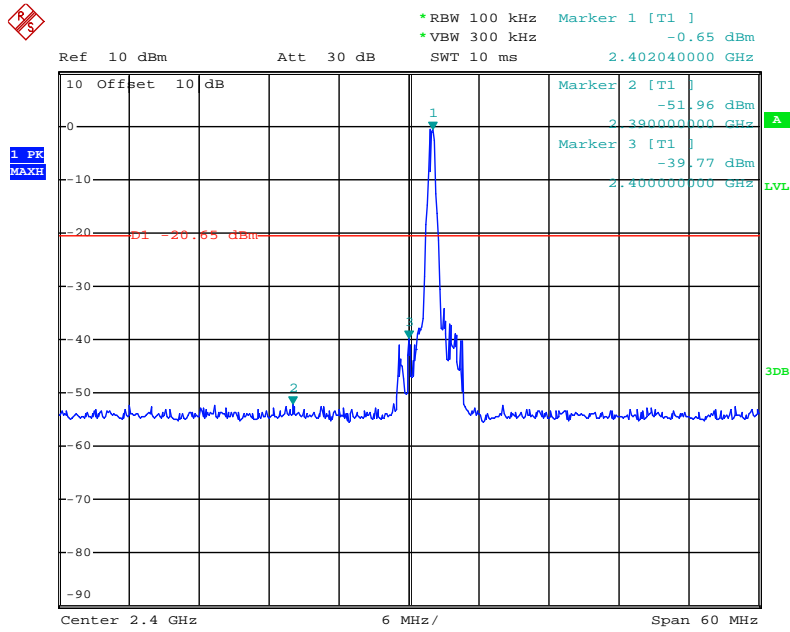

Date: 15.MAY.2020 10:56:39

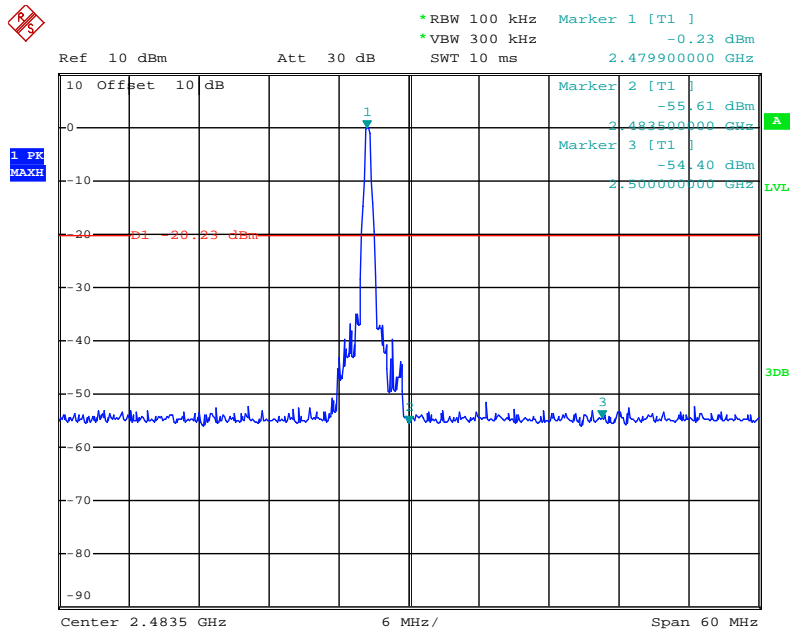

Date: 15.MAY.2020 11:00:23

### $\pi/4$ DQPSK Mode

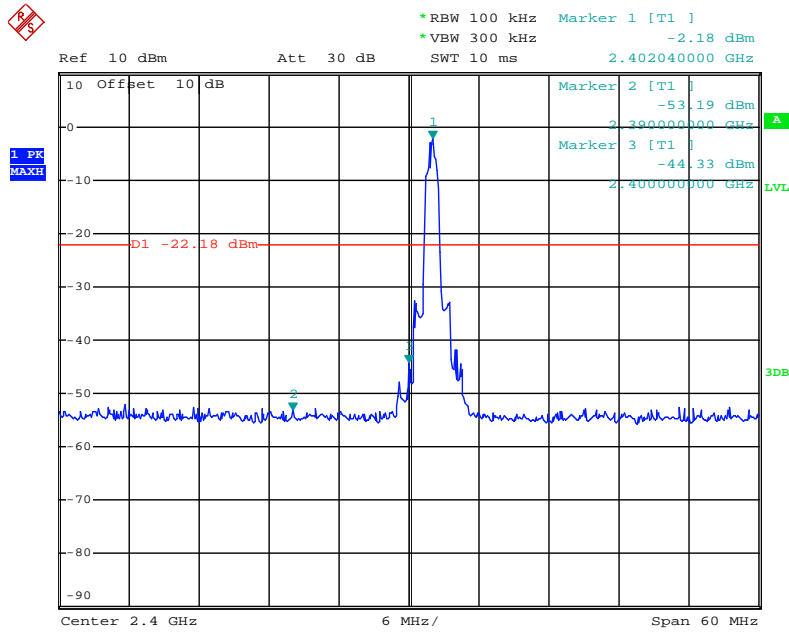

Date: 15.MAY.2020 10:57:28

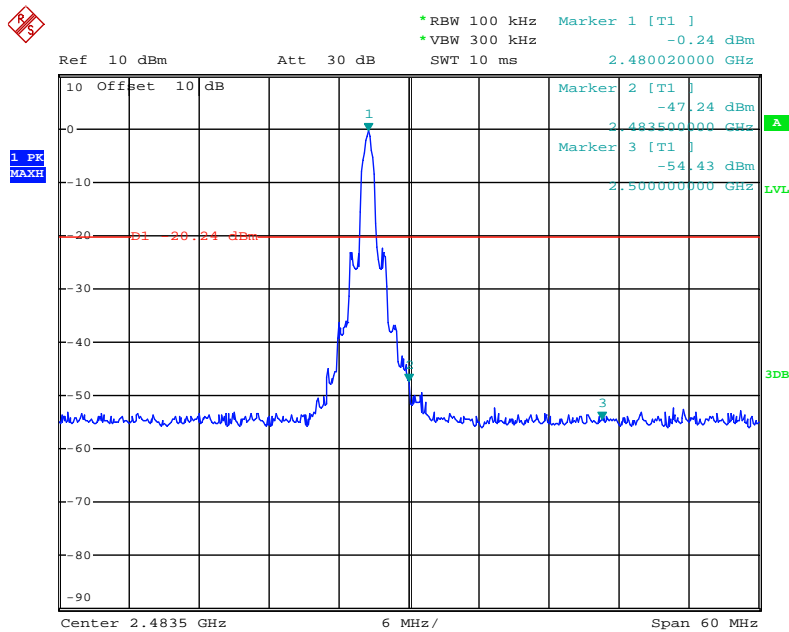

Date: 15.MAY.2020 10:59:45

### 8DPSK Mode

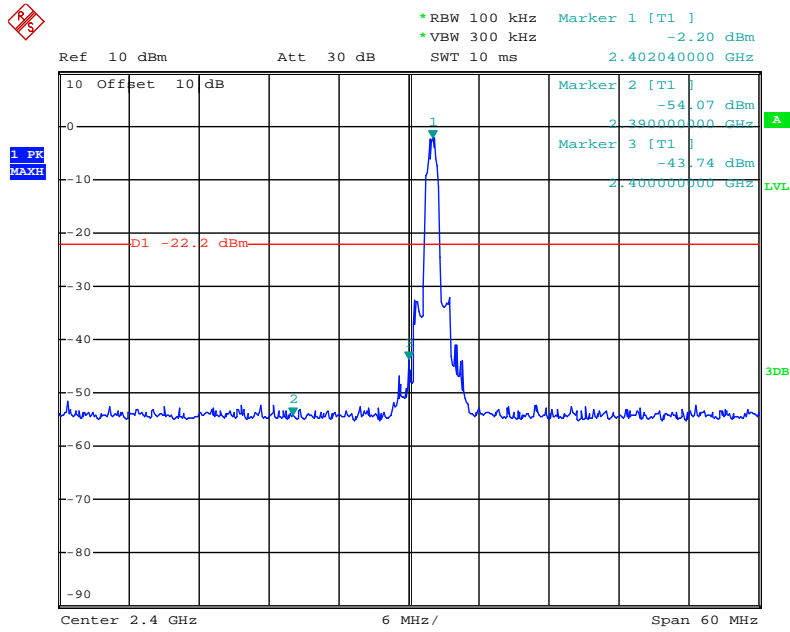

Date: 15.MAY.2020 10:58:20

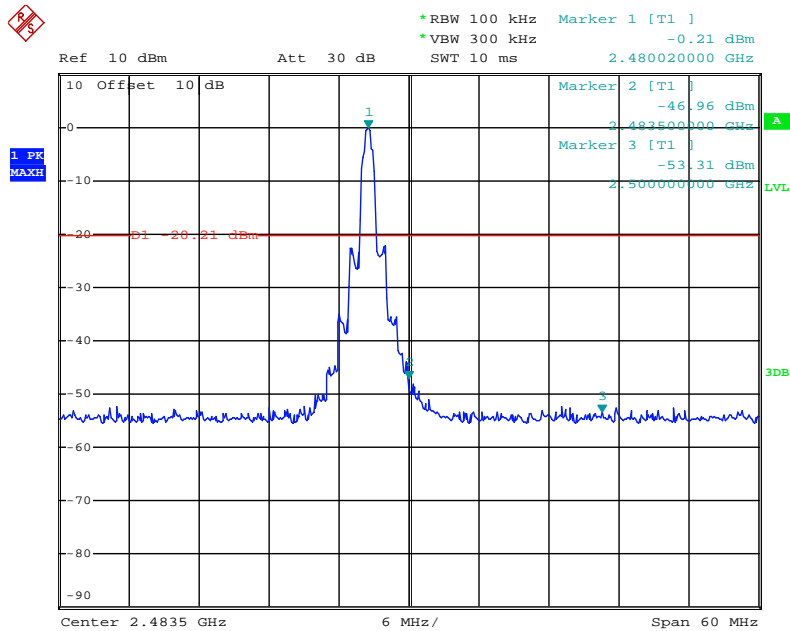

Date: 15.MAY.2020 10:59:18

## Radiated Band Edge Result

Note:

1. Emissions attenuated more than 20 dB below the permissible value are not reported.
2. The field strength is calculated by adding the antenna factor, high pass filter loss(if used) and cable loss, and subtracting the amplifier gain(if any)from the measured reading. The basic equation calculation is as follows:

$$\text{Result} = \text{Reading} + \text{Corrected Factor}$$

3. Display the measurement of peak values.

Test Procedure:

The EUT and its simulators are placed on a turntable, which is 0.1 meter high above ground(Above 1GHz). The turntable can rotate 360 degrees to determine the position of the maximum emission level. EUT is set 3.0 meters away from the receiving antenna, which is mounted on an antenna tower. The antenna can be moved up and down between 1.0 meter and 4 meters to find out the maximum emission level. Broadband antenna (calibrated bi-log antenna) is used as receiving antenna. Both horizontal and vertical polarizations of the antenna are set on measurement. In order to find the maximum emission levels, all of the EUT location must be manipulated according to ANSI C63.10:2013 on radiated emission measurement. The EUT was tested in 3 orthogonal planes.

Let the EUT work in TX (Hopping off, Hopping on) modes measure it.  
We select 2402MHz, 2480MHz TX frequency to transmit(Hopping off mode).  
We select 2402-2480MHz TX frequency to transmit(Hopping on mode).

During the radiated emission test, the spectrum analyzer was set with the following configurations:

- 1.The resolution bandwidth of test receiver/spectrum analyzer is 1MHz and video bandwidth is 3MHz for peak measurement with peak detector at frequency above 1GHz.
- 2.The resolution bandwidth of test receiver/spectrum analyzer is 1MHz and video bandwidth is 10Hz for Average measurement with peak detection at frequency above 1GHz.
- 3.All modes of operation were investigated and the worst-case emissions are reported.

**Note:**

- 1.We tested GFSK mode,  $\pi/4$  DQPSK Mode, 8DPSK Mode and recorded the worst case data ( $\pi/4$  DQPSK mode) for hopping mode.**



**Non-hopping mode**

**ACCURATE TECHNOLOGY CO., LTD.**

 F1,Bldg,A,Changyuan New Material Port Keyuan Rd,  
 Science & Industry Park,Nanshan Shenzhen,P.R.China

Site: 2# Chamber

Tel:+86-0755-26503290

Fax:+86-0755-26503396

Job No.: jp2020 #70

Standard: FCC PK

Test item: Radiation Test

Temp.( C)/Hum.(%) 23 C / 48 %

EUT: Massage Chair

Mode: DH1 TX 2402MHz

Model: EC-802T

Manufacturer: XIAMEN HEALTHCARE ELECHRONIC CO., LTD.

Polarization: Horizontal

Power Source: AC 120V/60Hz

Date: 2020/04/28/

Time: 8/47/57

Engineer Signature: Ben

Distance: 3m

Note: Report NO.:ATE20200296

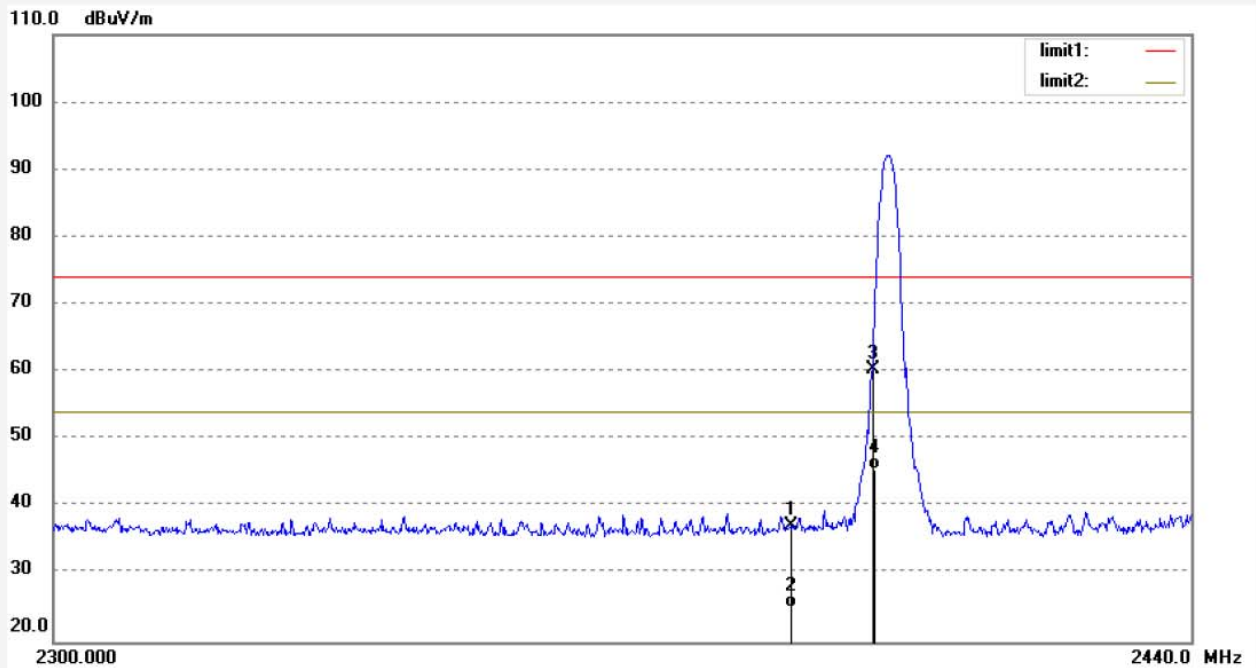

No.	Freq. (MHz)	Reading (dBuV/m)	Factor (dB)	Result (dBuV/m)	Limit (dBuV/m)	Margin (dB)	Detector	Height (cm)	Degree (deg.)	Remark
1	2390.000	36.32	0.79	37.11	74.00	-36.89	peak	250	158	
2	2390.000	24.32	0.79	25.11	54.00	-28.89	AVG	250	158	
3	2400.000	59.53	0.88	60.41	74.00	-13.59	peak	250	236	
4	2400.000	44.62	0.88	45.50	54.00	-8.50	AVG	250	236	

Job No.: jp2020 #71

Standard: FCC PK

Test item: Radiation Test

Temp.( C)/Hum.(%) 23 C / 48 %

EUT: Massage Chair

Mode: DH1 TX 2402MHz

Model: EC-802T

Manufacturer: XIAMEN HEALTHCARE ELECHRONIC CO., LTD.

Polarization: Vertical

Power Source: AC 120V/60Hz

Date: 2020/04/28/

Time: 8/48/57

Engineer Signature: Ben

Distance: 3m

Note: Report NO.:ATE20200296

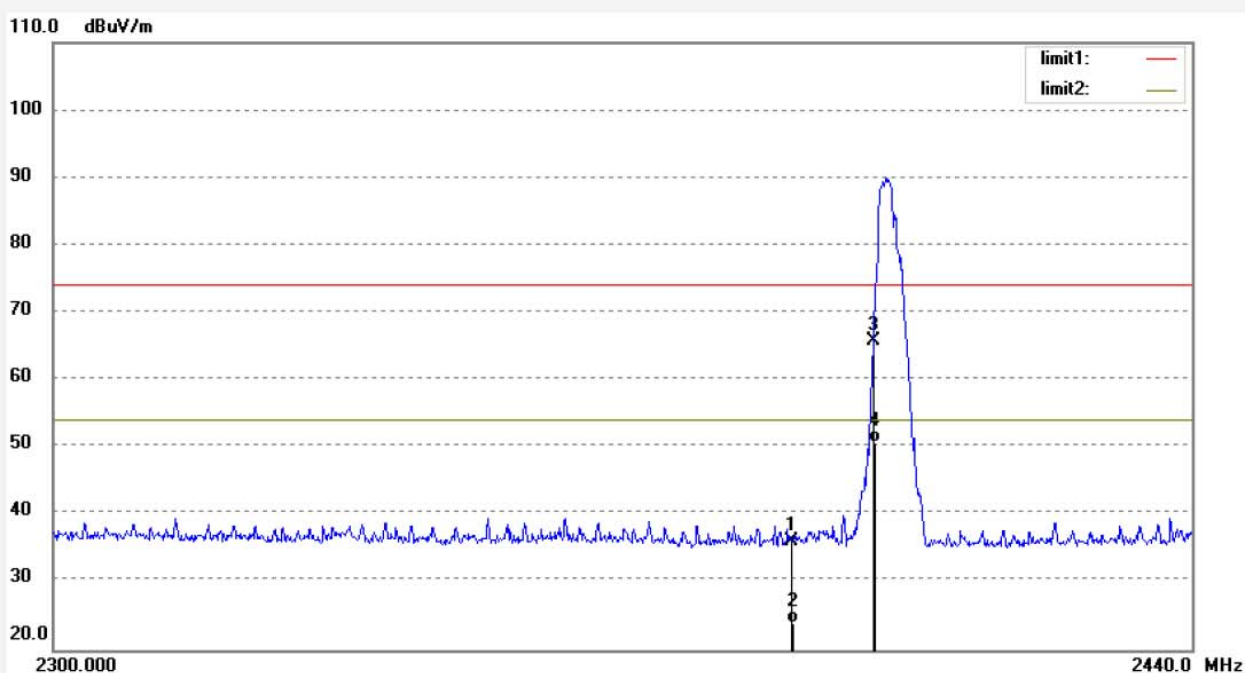

No.	Freq. (MHz)	Reading (dBuV/m)	Factor (dB)	Result (dBuV/m)	Limit (dBuV/m)	Margin (dB)	Detector	Height (cm)	Degree (deg.)	Remark
1	2390.000	35.21	0.79	36.00	74.00	-38.00	peak	150	149	
2	2390.000	23.21	0.79	24.00	54.00	-30.00	AVG	150	149	
3	2400.000	64.83	0.88	65.71	74.00	-8.29	peak	150	219	
4	2400.000	49.82	0.88	50.70	54.00	-3.30	AVG	150	219	

Job No.: jp2020 #69

Standard: FCC PK

Test item: Radiation Test

Temp.( C)/Hum.(%) 23 C / 48 %

EUT: Massage Chair

Mode: DH1 TX 2480MHz

Model: EC-802T

Manufacturer: XIAMEN HEALTHCARE ELECHRONIC CO., LTD.

Polarization: Horizontal

Power Source: AC 120V/60Hz

Date: 2020/04/28/

Time: 8/44/45

Engineer Signature: Ben

Distance: 3m

Note: Report NO.:ATE20200296

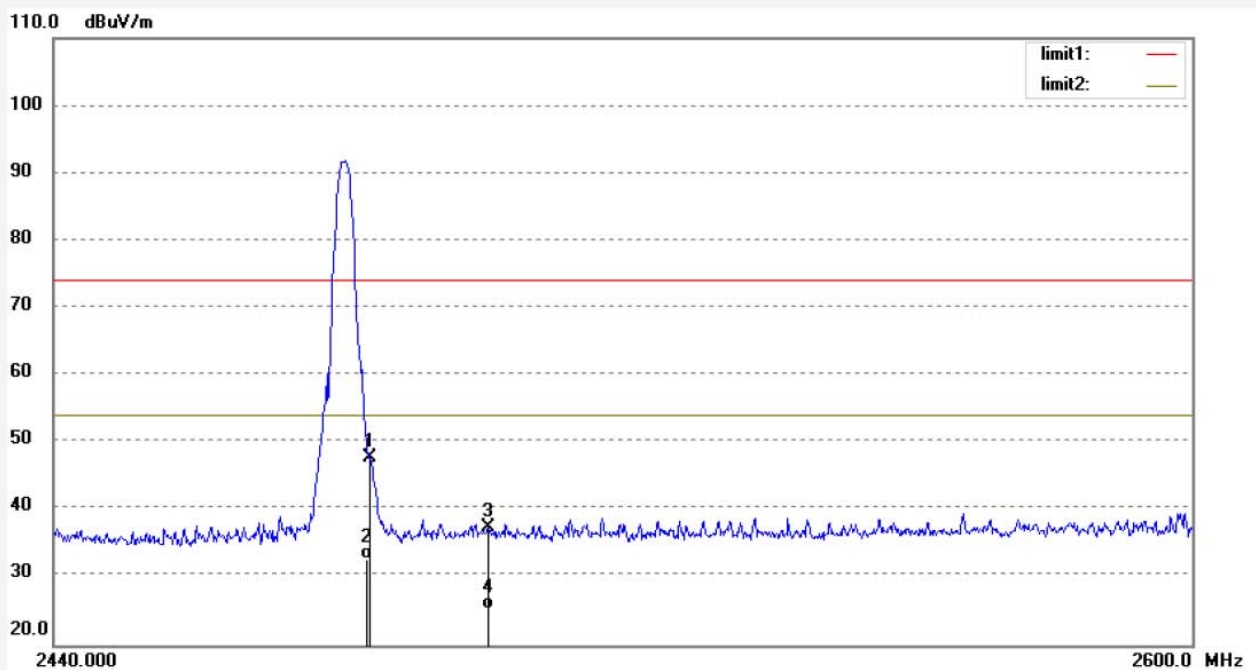

No.	Freq. (MHz)	Reading (dBuV/m)	Factor (dB)	Result (dBuV/m)	Limit (dBuV/m)	Margin (dB)	Detector	Height (cm)	Degree (deg.)	Remark
1	2483.500	46.67	1.10	47.77	74.00	-26.23	peak	250	156	
2	2483.500	31.60	1.10	32.70	54.00	-21.30	AVG	250	156	
3	2500.000	36.30	1.10	37.40	74.00	-36.60	peak	250	205	
4	2500.000	24.30	1.10	25.40	54.00	-28.60	AVG	250	205	

Job No.: jp2020 #68

Standard: FCC PK

Test item: Radiation Test

Temp.( C)/Hum.(%) 23 C / 48 %

EUT: Massage Chair

Mode: DH1 TX 2480MHz

Model: EC-802T

Manufacturer: XIAMEN HEALTHCARE ELECHRONIC CO., LTD.

Polarization: Vertical

Power Source: AC 120V/60Hz

Date: 2020/04/28/

Time: 8/43/45

Engineer Signature: Ben

Distance: 3m

Note: Report NO.:ATE20200296

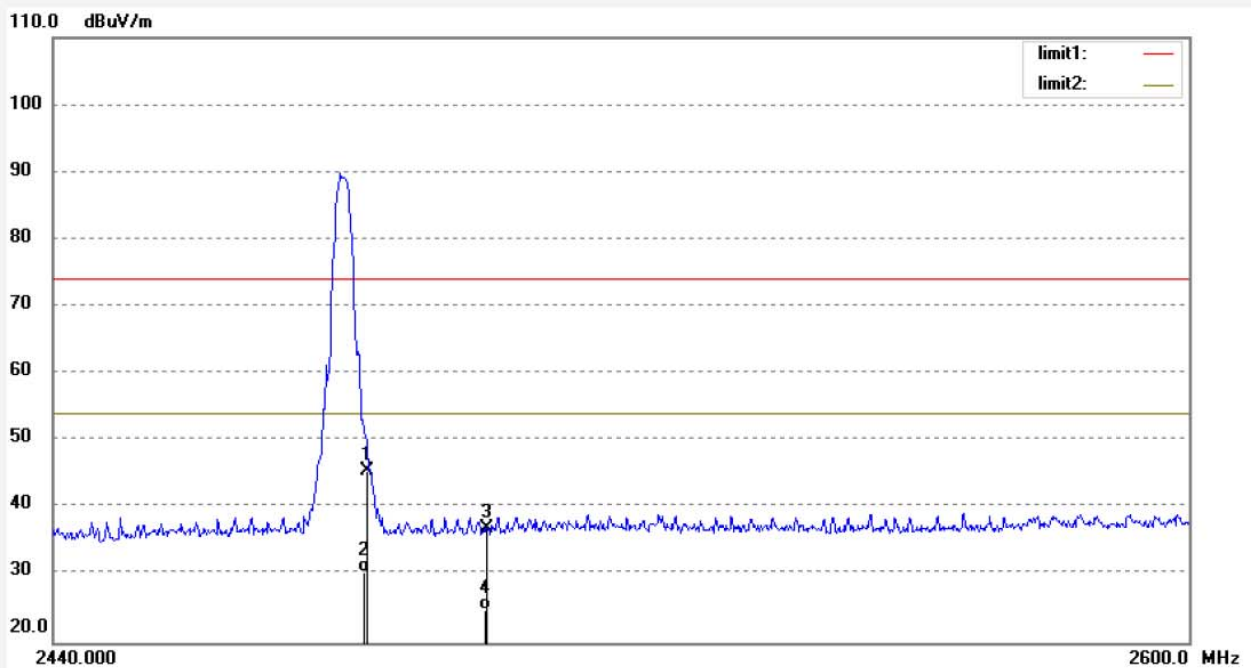

No.	Freq. (MHz)	Reading (dBuV/m)	Factor (dB)	Result (dBuV/m)	Limit (dBuV/m)	Margin (dB)	Detector	Height (cm)	Degree (deg.)	Remark
1	2483.500	44.36	1.10	45.46	74.00	-28.54	peak	150	129	
2	2483.500	29.30	1.10	30.40	54.00	-23.60	AVG	150	129	
3	2500.000	35.84	1.10	36.94	74.00	-37.06	peak	150	198	
4	2500.000	23.80	1.10	24.90	54.00	-29.10	AVG	150	198	

Job No.: jp2020 #73

Standard: FCC PK

Test item: Radiation Test

Temp.( C)/Hum.(%) 23 C / 48 %

EUT: Massage Chair

Mode: 2DH1 TX 2402MHz

Model: EC-802T

Manufacturer: XIAMEN HEALTHCARE ELECHRONIC CO., LTD.

Polarization: Horizontal

Power Source: AC 120V/60Hz

Date: 2020/04/28/

Time: 8/51/35

Engineer Signature: Ben

Distance: 3m

Note: Report NO.:ATE20200296

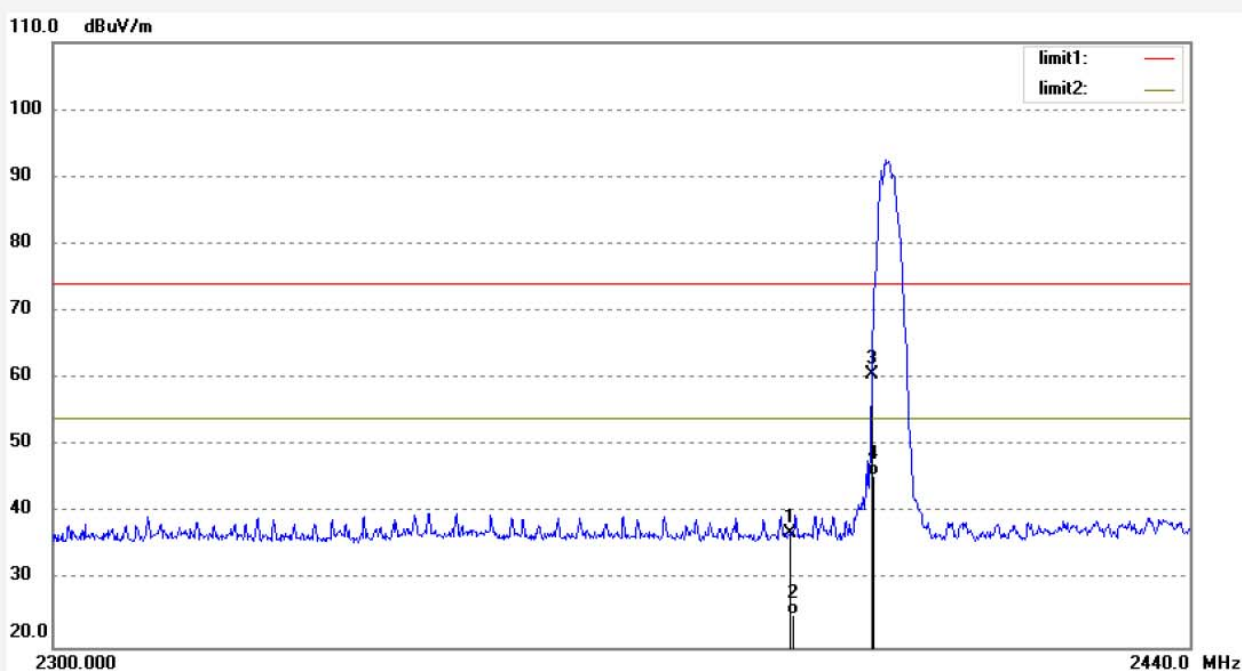

No.	Freq. (MHz)	Reading (dBuV/m)	Factor (dB)	Result (dBuV/m)	Limit (dBuV/m)	Margin (dB)	Detector	Height (cm)	Degree (deg.)	Remark
1	2390.000	36.13	0.79	36.92	74.00	-37.08	peak	250	138	
2	2390.000	24.11	0.79	24.90	54.00	-29.10	AVG	250	138	
3	2400.000	59.70	0.88	60.58	74.00	-13.42	peak	250	196	
4	2400.000	44.72	0.88	45.60	54.00	-8.40	AVG	250	196	

Job No.: jp2020 #72

Standard: FCC PK

Test item: Radiation Test

Temp.( C)/Hum.(%) 23 C / 48 %

EUT: Massage Chair

Mode: 2DH1 TX 2402MHz

Model: EC-802T

Manufacturer: XIAMEN HEALTHCARE ELECHRONIC CO., LTD.

Polarization: Vertical

Power Source: AC 120V/60Hz

Date: 2020/04/28/

Time: 8/50/36

Engineer Signature: Ben

Distance: 3m

Note: Report NO.:ATE20200296

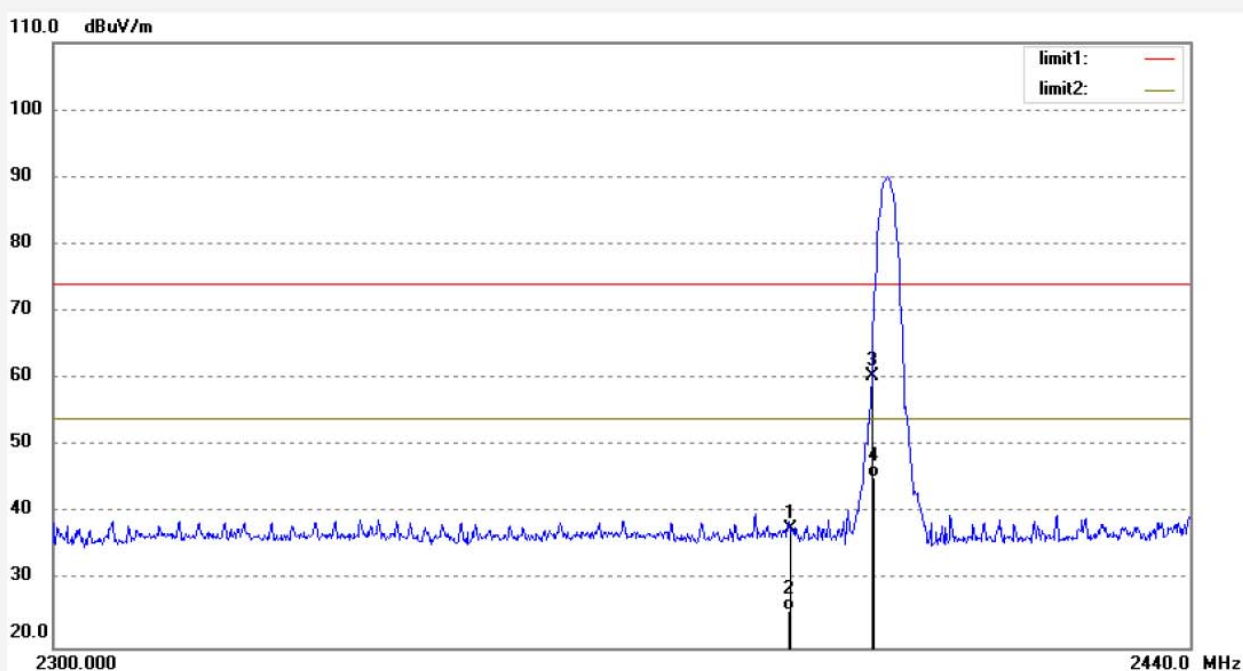

No.	Freq. (MHz)	Reading (dBuV/m)	Factor (dB)	Result (dBuV/m)	Limit (dBuV/m)	Margin (dB)	Detector	Height (cm)	Degree (deg.)	Remark
1	2390.000	36.78	0.79	37.57	74.00	-36.43	peak	150	167	
2	2390.000	24.71	0.79	25.50	54.00	-28.50	AVG	150	167	
3	2400.000	59.55	0.88	60.43	74.00	-13.57	peak	150	202	
4	2400.000	44.52	0.88	45.40	54.00	-8.60	AVG	150	202	

Job No.: jp2020 #74	Polarization: Horizontal
Standard: FCC PK	Power Source: AC 120V/60Hz
Test item: Radiation Test	Date: 2020/04/28/
Temp.( C)/Hum.(%) 23 C / 48 %	Time: 8/53/15
EUT: Massage Chair	Engineer Signature: Ben
Mode: 2DH1 TX 2480MHz	Distance: 3m
Model: EC-802T	
Manufacturer: XIAMEN HEALTHCARE ELECHRONIC CO., LTD.	

Note: Report NO.:ATE20200296

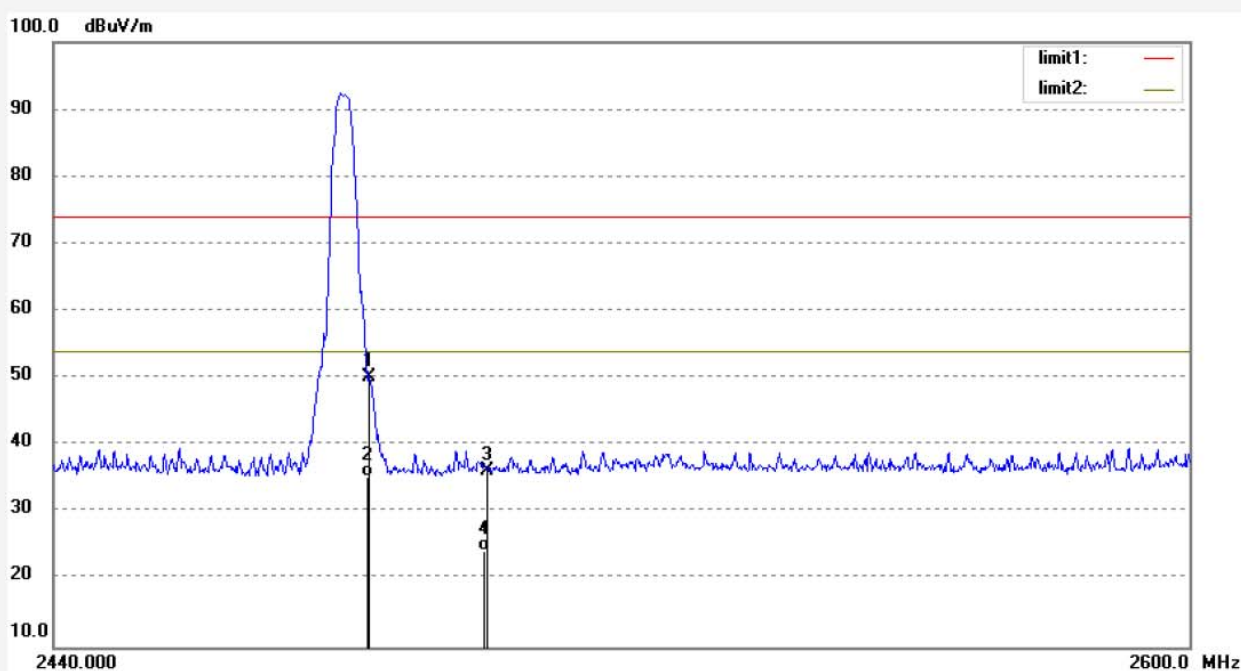

No.	Freq. (MHz)	Reading (dBuV/m)	Factor (dB)	Result (dBuV/m)	Limit (dBuV/m)	Margin (dB)	Detector	Height (cm)	Degree (deg.)	Remark
1	2483.500	49.12	1.10	50.22	74.00	-23.78	peak	250	186	
2	2483.500	34.10	1.10	35.20	54.00	-18.80	AVG	250	186	
3	2500.000	35.20	1.10	36.30	74.00	-37.70	peak	250	215	
4	2500.000	23.20	1.10	24.30	54.00	-29.70	AVG	250	215	

Job No.: jp2020 #75

Standard: FCC PK

Test item: Radiation Test

Temp.( C)/Hum.(%) 23 C / 48 %

EUT: Massage Chair

Mode: 2DH1 TX 2480MHz

Model: EC-802T

Manufacturer: XIAMEN HEALTHCARE ELECHRONIC CO., LTD.

Polarization: Vertical

Power Source: AC 120V/60Hz

Date: 2020/04/28/

Time: 8/54/17

Engineer Signature: Ben

Distance: 3m

Note: Report NO.:ATE20200296

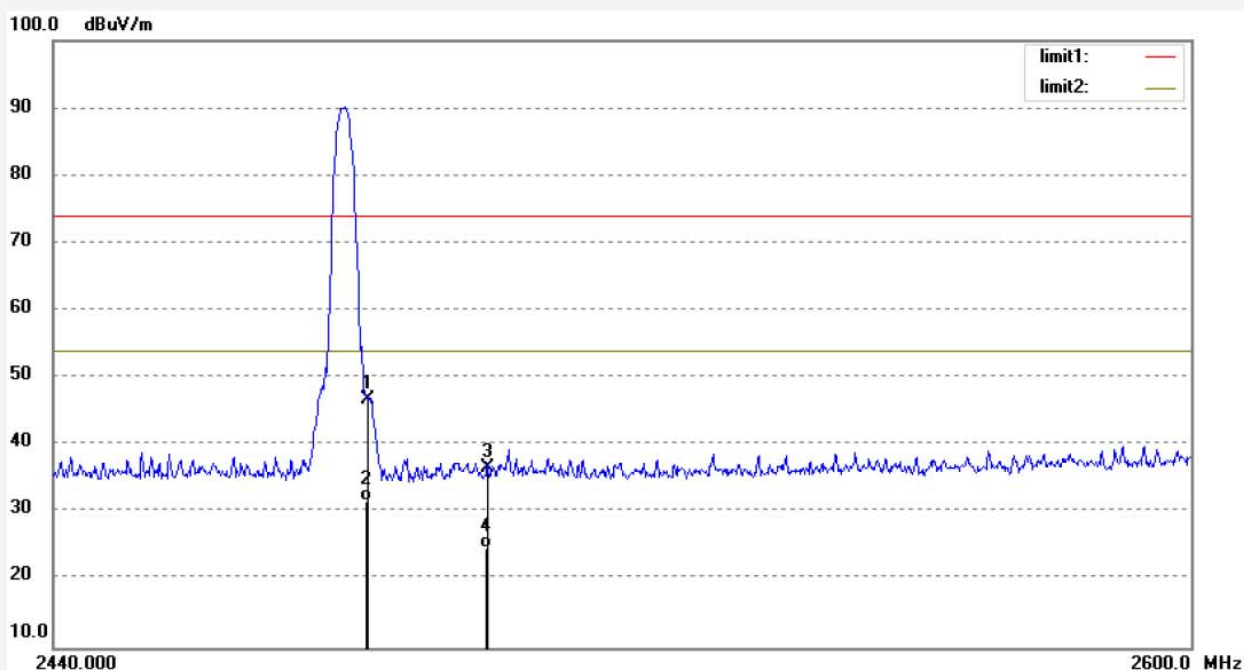

No.	Freq. (MHz)	Reading (dBuV/m)	Factor (dB)	Result (dBuV/m)	Limit (dBuV/m)	Margin (dB)	Detector	Height (cm)	Degree (deg.)	Remark
1	2483.500	45.71	1.10	46.81	74.00	-27.19	peak	150	129	
2	2483.500	30.70	1.10	31.80	54.00	-22.20	AVG	150	129	
3	2500.000	35.60	1.10	36.70	74.00	-37.30	peak	150	186	
4	2500.000	23.60	1.10	24.70	54.00	-29.30	AVG	150	186	



Job No.: mfl #23

Standard: FCC PK

Test item: Radiation Test

Temp.( C)/Hum.(%) 25 C / 55 %

EUT: Massage Chair

Mode: 3DH1 TX 2402MHz

Model: EC-802T

Manufacturer: XIAMEN HEALTHCARE ELECHRONIC CO.,LTD

Polarization: Horizontal

Power Source: AC 120V/60Hz

Date: 2020/04/28/

Time: 10/38/06

Engineer Signature:

Distance: 3m

Note: Report NO.:ATE20200296

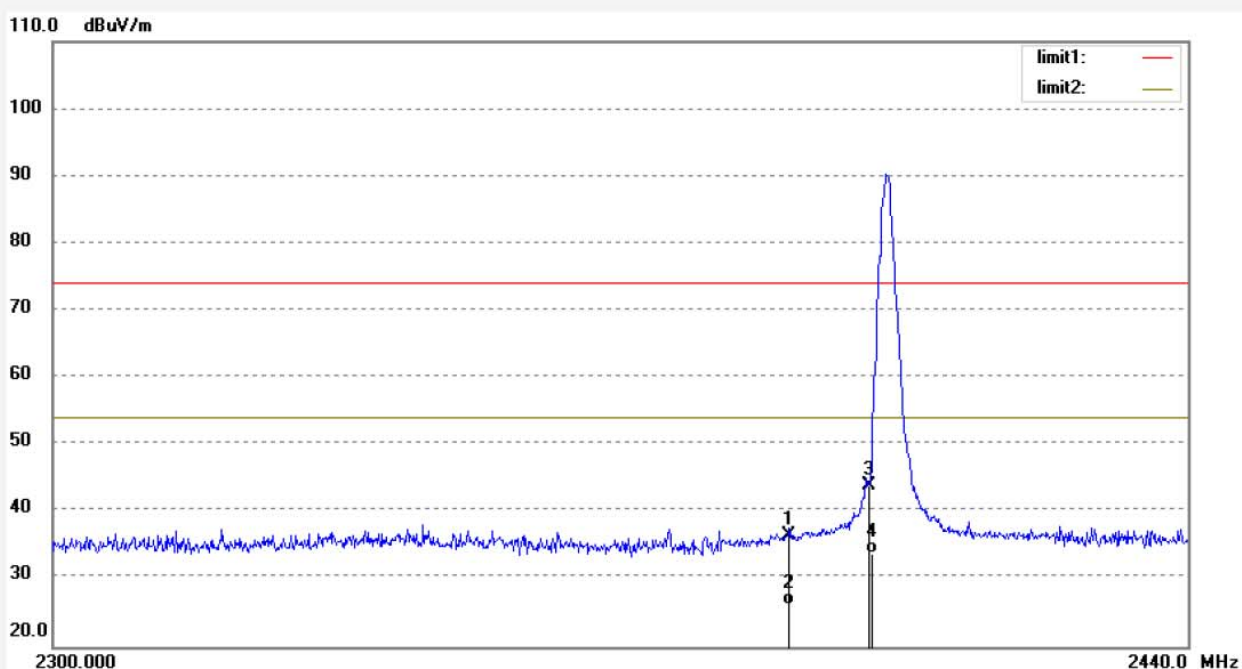

No.	Freq. (MHz)	Reading (dBuV/m)	Factor (dB)	Result (dBuV/m)	Limit (dBuV/m)	Margin (dB)	Detector	Height (cm)	Degree (deg.)	Remark
1	2390.000	40.89	-4.32	36.57	74.00	-37.43	peak	250	134	
2	2390.000	30.55	-4.32	26.23	54.00	-27.77	AVG	200	102	
3	2400.000	48.16	-4.27	43.89	74.00	-30.11	peak	250	75	
4	2400.000	38.16	-4.27	33.89	54.00	-20.11	AVG	250	309	

Job No.: mfl #24

Standard: FCC PK

Test item: Radiation Test

Temp.( C)/Hum.(%) 25 C / 55 %

EUT: Massage Chair

Mode: 3DH1 TX 2402MHz

Model: EC-802T

Manufacturer: XIAMEN HEALTHCARE ELECHRONIC CO., LTD.

Polarization: Vertical

Power Source: AC 120V/60Hz

Date: 2020/04/28/

Time: 10/38/56

Engineer Signature:

Distance: 3m

Note: Report NO.:ATE20200296

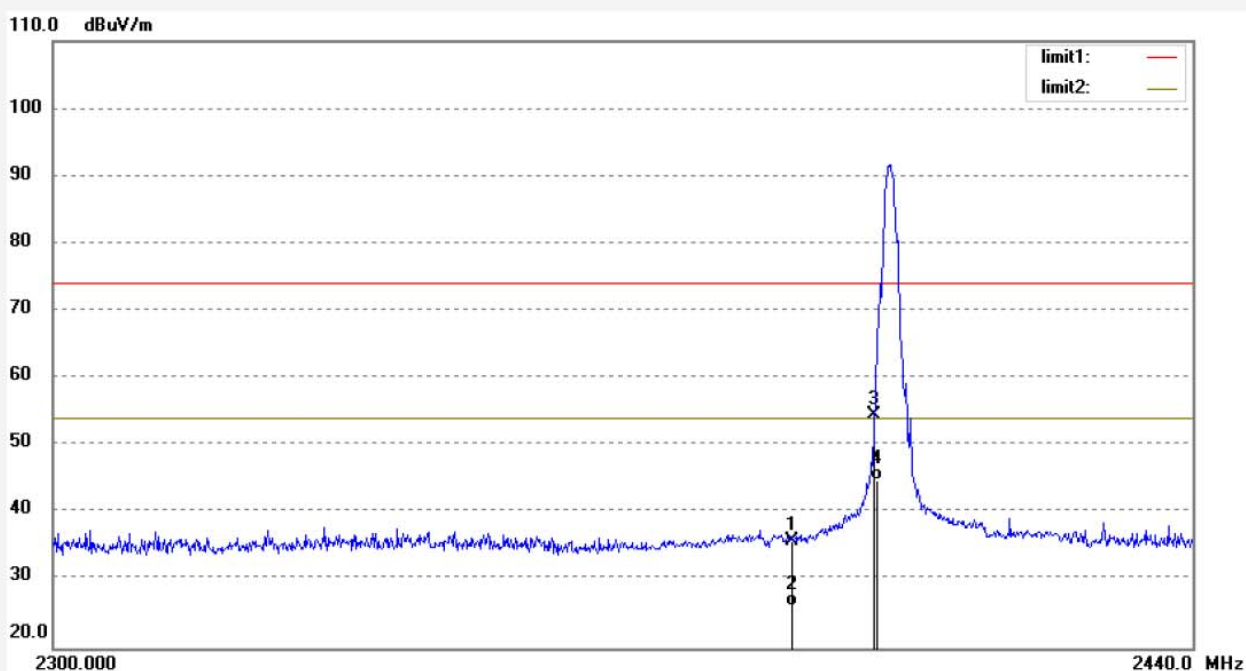

No.	Freq. (MHz)	Reading (dBuV/m)	Factor (dB)	Result (dBuV/m)	Limit (dBuV/m)	Margin (dB)	Detector	Height (cm)	Degree (deg.)	Remark
1	2390.000	40.29	-4.32	35.97	74.00	-38.03	peak	200	348	
2	2390.000	30.45	-4.32	26.13	54.00	-27.87	AVG	150	158	
3	2400.000	58.77	-4.27	54.50	74.00	-19.50	peak	150	54	
4	2400.000	49.18	-4.27	44.91	54.00	-9.09	AVG	150	312	

Job No.: mfl #26

Standard: FCC PK

Test item: Radiation Test

Temp.( C)/Hum.(%) 25 C / 55 %

EUT: Massage Chair

Mode: 3DH1 TX 2480MHz

Model: EC-802T

Manufacturer: XIAMEN HEALTHCARE ELECHRONIC CO., LTD.

Polarization: Horizontal

Power Source: AC 120V/60Hz

Date: 2020/04/28/

Time: 10/41/30

Engineer Signature:

Distance: 3m

Note: Report NO.:ATE20200296

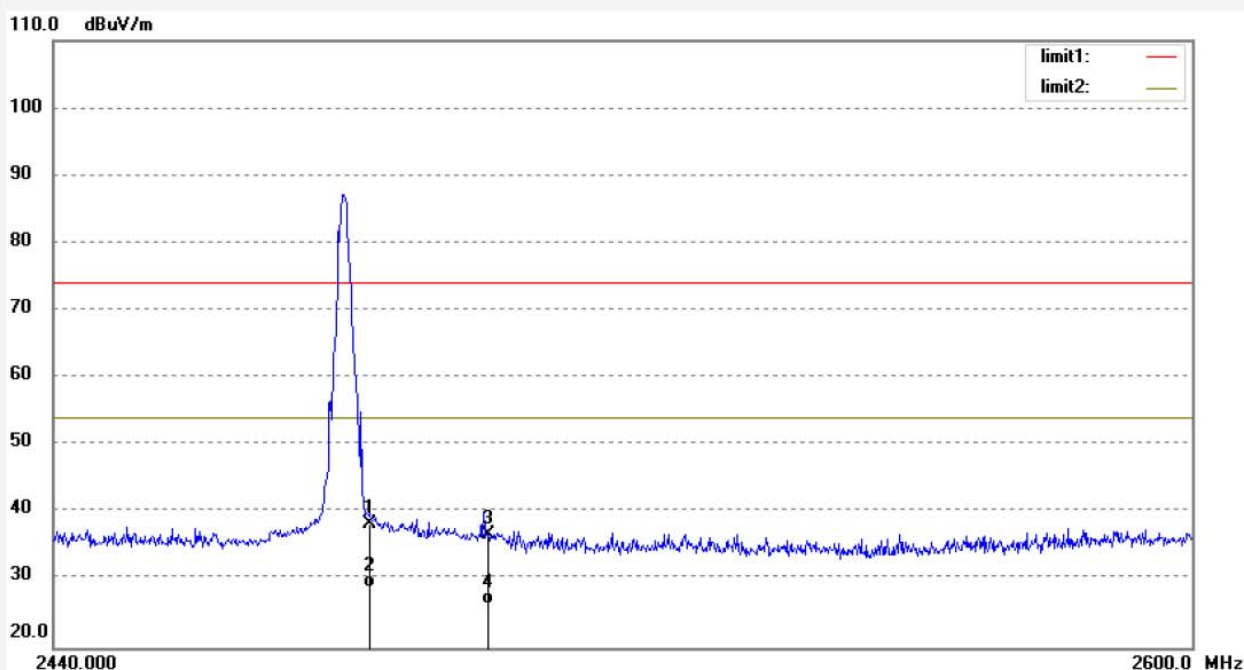

No.	Freq. (MHz)	Reading (dBuV/m)	Factor (dB)	Result (dBuV/m)	Limit (dBuV/m)	Margin (dB)	Detector	Height (cm)	Degree (deg.)	Remark
1	2483.500	42.12	-3.89	38.23	74.00	-35.77	peak	250	222	
2	2483.500	32.85	-3.89	28.96	54.00	-25.04	AVG	200	90	
3	2500.000	40.66	-3.81	36.85	74.00	-37.15	peak	250	189	
4	2500.000	30.19	-3.81	26.38	54.00	-27.62	AVG	200	127	

Job No.: mfl #25

Standard: FCC PK

Test item: Radiation Test

Temp.( C)/Hum.(%) 25 C / 55 %

EUT: Massage Chair

Mode: 3DH1 TX 2480MHz

Model: EC-802T

Manufacturer: XIAMEN HEALTHCARE ELECHRONIC CO., LTD.

Polarization: Vertical

Power Source: AC 120V/60Hz

Date: 2020/04/28/

Time: 10/40/33

Engineer Signature:

Distance: 3m

Note: Report NO.:ATE20200296

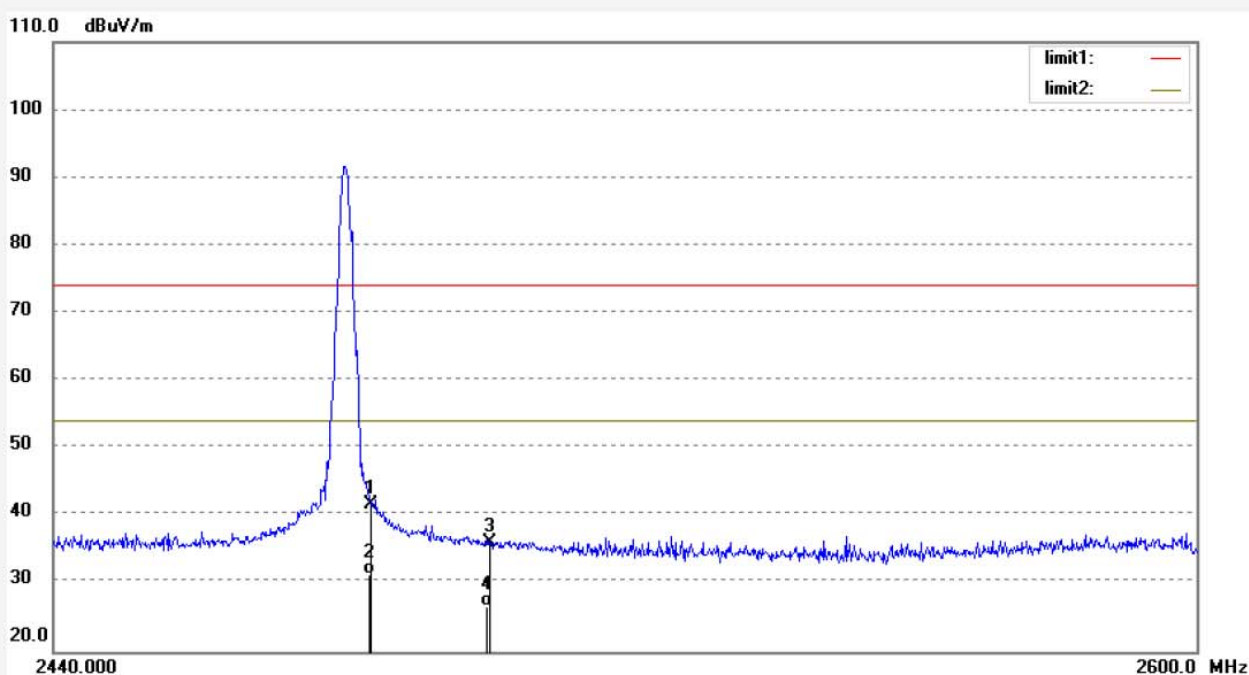

No.	Freq. (MHz)	Reading (dBuV/m)	Factor (dB)	Result (dBuV/m)	Limit (dBuV/m)	Margin (dB)	Detector	Height (cm)	Degree (deg.)	Remark
1	2483.500	45.62	-3.89	41.73	74.00	-32.27	peak	200	351	
2	2483.500	35.15	-3.89	31.26	54.00	-22.74	AVG	150	158	
3	2500.000	39.91	-3.81	36.10	74.00	-37.90	peak	250	345	
4	2500.000	30.47	-3.81	26.66	54.00	-27.34	AVG	200	240	

**Hopping mode(Worse case:  $\pi/4$  DQPSK Mode)**

**ACCURATE TECHNOLOGY CO., LTD.**

 F1,Bldg,A,Changyuan New Material Port Keyuan Rd,  
 Science & Industry Park,Nanshan Shenzhen,P.R.China

Site: 2# Chamber

Tel:+86-0755-26503290

Fax:+86-0755-26503396

Job No.: jp2020 #77

Standard: FCC PK

Test item: Radiation Test

Temp.( C)/Hum.(%) 23 C / 48 %

EUT: Massage Chair

Mode: HOPPING

Model: EC-802T

Manufacturer: XIAMEN HEALTHCARE ELECHRONIC CO., LTD.

Polarization: Horizontal

Power Source: AC 120V/60Hz

Date: 2020/04/28/

Time: 8/58/42

Engineer Signature: Ben

Distance: 3m

Note: Report NO.:ATE20200296

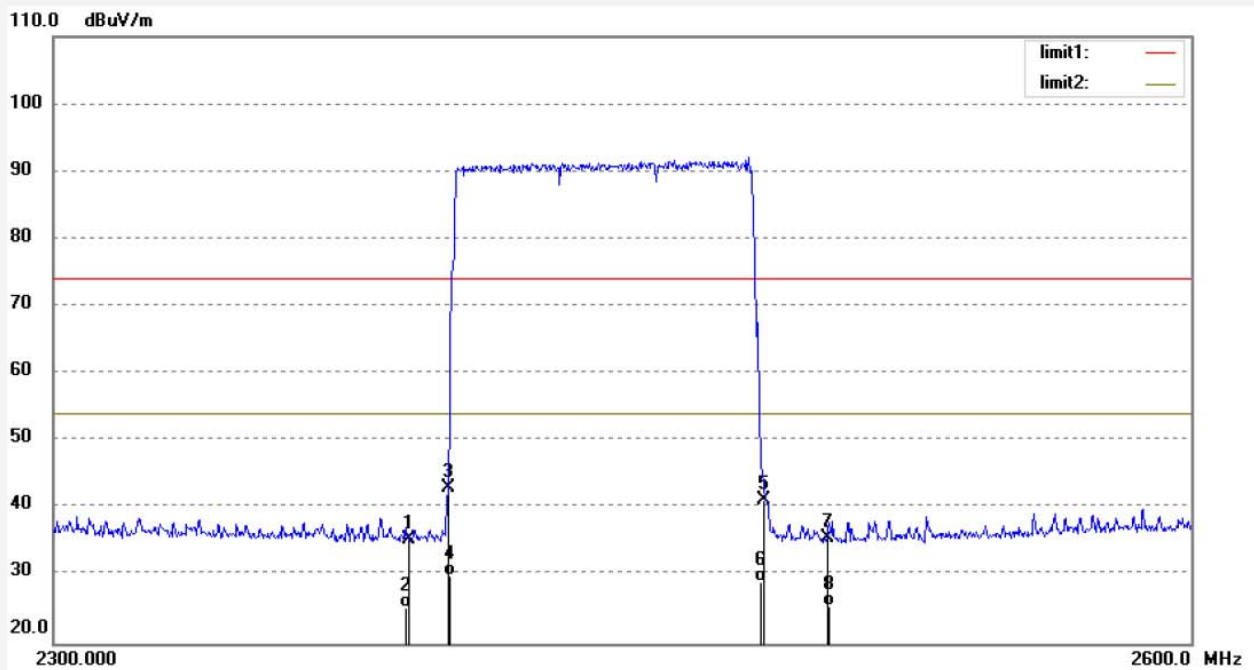

No.	Freq. (MHz)	Reading (dBuV/m)	Factor (dB)	Result (dBuV/m)	Limit (dBuV/m)	Margin (dB)	Detector	Height (cm)	Degree (deg.)	Remark
1	2390.000	34.56	0.79	35.35	74.00	-38.65	peak	250	102	
2	2390.000	24.41	0.79	25.20	54.00	-28.80	AVG	250	102	
3	2400.000	42.22	0.88	43.10	74.00	-30.90	peak	250	163	
4	2400.000	29.22	0.88	30.10	54.00	-23.90	AVG	250	163	
5	2483.500	40.11	1.10	41.21	74.00	-32.79	peak	250	185	
6	2483.500	28.10	1.10	29.20	54.00	-24.80	AVG	250	185	
7	2500.000	34.54	1.10	35.64	74.00	-38.36	peak	250	215	
8	2500.000	24.40	1.10	25.50	54.00	-28.50	AVG	250	215	

Job No.: jp2020 #76

Standard: FCC PK

Test item: Radiation Test

Temp.( C)/Hum.(%) 23 C / 48 %

EUT: Massage Chair

Mode: HOPPING

Model: EC-802T

Manufacturer: XIAMEN HEALTHCARE ELECHRONIC CO., LTD.

Polarization: Vertical

Power Source: AC 120V/60Hz

Date: 2020/04/28/

Time: 8/56/22

Engineer Signature: Ben

Distance: 3m

Note: Report NO.:ATE20200296

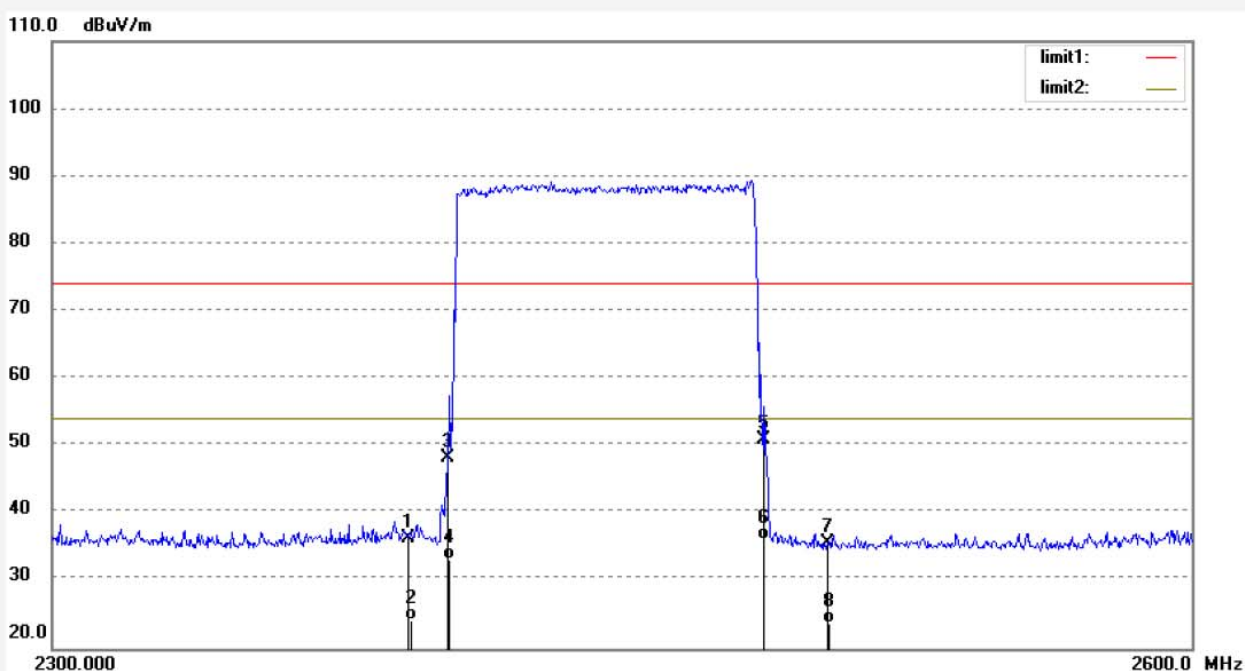

No.	Freq. (MHz)	Reading (dBuV/m)	Factor (dB)	Result (dBuV/m)	Limit (dBuV/m)	Margin (dB)	Detector	Height (cm)	Degree (deg.)	Remark
1	2390.000	35.43	0.79	36.22	74.00	-37.78	peak	150	126	
2	2390.000	23.41	0.79	24.20	54.00	-29.80	AVG	150	126	
3	2400.000	47.25	0.88	48.13	74.00	-25.87	peak	150	156	
4	2400.000	32.22	0.88	33.10	54.00	-20.90	AVG	150	156	
5	2483.500	49.91	1.10	51.01	74.00	-22.99	peak	150	196	
6	2483.500	34.90	1.10	36.00	54.00	-18.00	AVG	150	196	
7	2500.000	34.61	1.10	35.71	74.00	-38.29	peak	150	263	
8	2500.000	22.50	1.10	23.60	54.00	-30.40	AVG	150	263	

## 12.AC POWER LINE CONDUCTED EMISSION FOR FCC PART

### 15 SECTION 15.207(A)

#### 12.1.Block Diagram of Test Setup

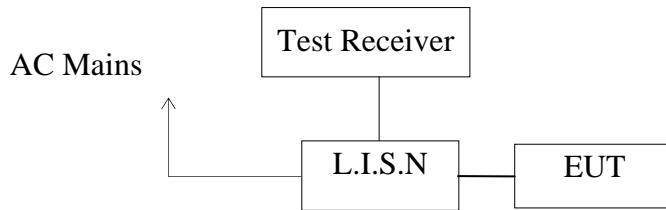

(EUT: Massage Chair)

#### 12.2.Test System Setup

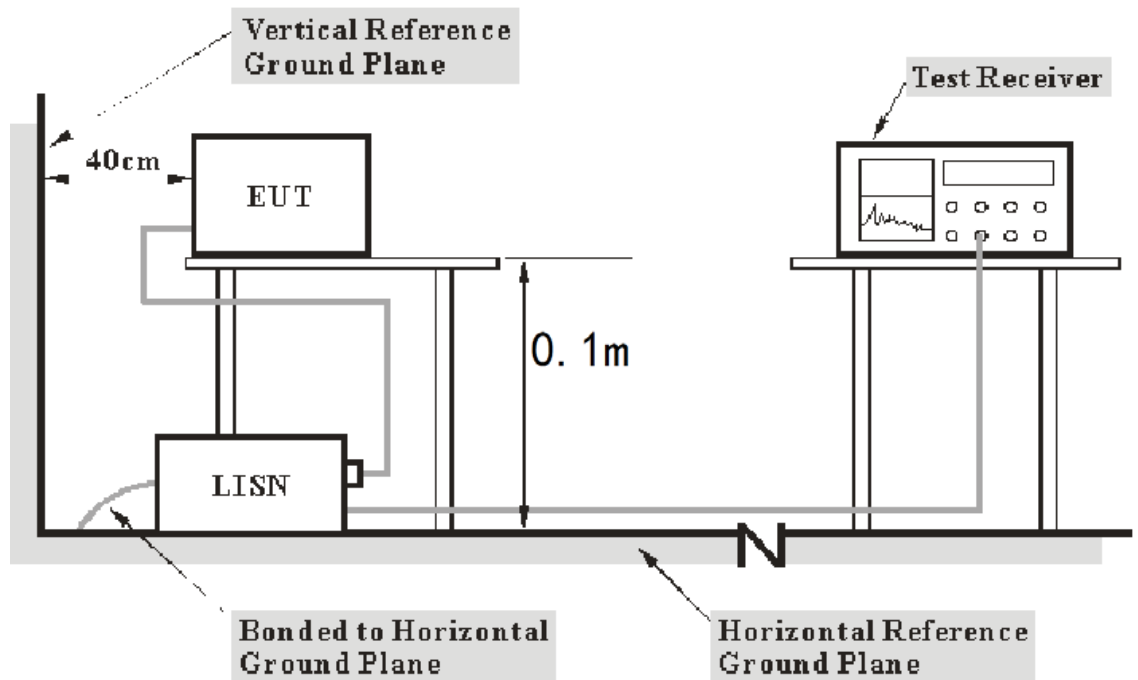

- Note: 1. Support units were connected to second LISN.  
 2. Both of LISNs (AMN) 80 cm from EUT and at the least 80 cm from other units and other metal planes support units.

### 12.3. Power Line Conducted Emission Measurement Limits

Frequency (MHz)	Limit dB(μV)	
	Quasi-peak Level	Average Level
0.15 - 0.50	66.0 – 56.0 *	56.0 – 46.0 *
0.50 - 5.00	56.0	46.0
5.00 - 30.00	60.0	50.0

NOTE1: The lower limit shall apply at the transition frequencies.  
 NOTE2: The limit decreases linearly with the logarithm of the frequency in the range 0.15MHz to 0.50MHz.

### 12.4. Configuration of EUT on Measurement

The equipments are installed on Power Line Conducted Emission Measurement to meet the commission requirement and operating regulations in a manner, which tends to maximize its emission characteristics in a normal application.

### 12.5. Operating Condition of EUT

12.5.1. Setup the EUT and simulator as shown as Section 12.1.

12.5.2. Turn on the power of all equipment.

12.5.3. Let the EUT work in test mode and measure it.

### 12.6. Test Procedure

The EUT is put on the plane 0.1m high above the ground by insulating support and is connected to the power mains through a line impedance stabilization network (L.I.S.N.). This provides a 50ohm coupling impedance for the EUT system. Please refer the block diagram of the test setup and photographs. Both sides of AC lines are checked to find out the maximum conducted emission. In order to find the maximum emission levels, the relative positions of equipment and all of the interface cables shall be changed according to ANSI C63.4: 2014 on Conducted Emission Measurement.

The bandwidth of test receiver (R & S ESCS30) is set at 9kHz.

The frequency range from 150kHz to 30MHz is checked.



### 12.7.Data Sample

Frequency (MHz)	Transducer value (dB)	QuasiPeak Level (dB $\mu$ V)	Average Level (dB $\mu$ V)	QuasiPeak Limit (dB $\mu$ V)	Average Limit (dB $\mu$ V)	QuasiPeak Margin (dB)	Average Margin (dB)	Remark (Pass/Fail)
X.XX	10.5	51.1	34.2	56.0	46.0	4.9	11.8	Pass

Frequency(MHz) = Emission frequency in MHz

Transducer value(dB) = Insertion loss of LISN + Cable Loss

Level(dB $\mu$ V) = Quasi-peak Reading/Average Reading + Transducer value

Limit (dB $\mu$ V) = Limit stated in standard

Margin = Limit (dB $\mu$ V) - Level (dB $\mu$ V)

Calculation Formula:

Margin = Limit (dB $\mu$ V) - Level (dB $\mu$ V)

### 12.8.Power Line Conducted Emission Measurement Results

#### PASS.

The frequency range from 150kHz to 30MHz is checked.

Maximizing procedure was performed on the six (6) highest emissions of the EUT.

Emissions attenuated more than 20 dB below the permissible value are not reported.

We tested the conducted emission of high and low voltage mode and recorded the worst mode data. All data was recorded in the Quasi-peak and average detection mode.

Test mode : BT OPERATION (AC 120V/60Hz)								
<b>MEASUREMENT RESULT: "F-0295-A3_fin"</b>								
2020-4-28 9:10								
Frequency MHz	Level dBuV	Transd dB	Limit dBuV	Margin dB	Detector	Line	PE	
0.186000	51.30	10.8	64	12.9	QP	N	GND	
0.384000	31.00	10.9	58	27.2	QP	N	GND	
1.380000	31.40	11.2	56	24.6	QP	N	GND	
4.645000	27.70	11.4	56	28.3	QP	N	GND	
8.730000	31.90	11.5	60	28.1	QP	N	GND	
16.650000	42.70	11.7	60	17.3	QP	N	GND	
<b>MEASUREMENT RESULT: "F-0295-A3_fin2"</b>								
2020-4-28 9:10								
Frequency MHz	Level dBuV	Transd dB	Limit dBuV	Margin dB	Detector	Line	PE	
0.202000	35.10	10.8	54	18.4	AV	N	GND	
0.600000	22.70	11.0	46	23.3	AV	N	GND	
0.920000	20.60	11.1	46	25.4	AV	N	GND	
4.855000	19.20	11.4	46	26.8	AV	N	GND	
8.145000	22.40	11.5	50	27.6	AV	N	GND	
16.510000	32.70	11.7	50	17.3	AV	N	GND	

<b>MEASUREMENT RESULT: "F-0295-A4_fin"</b>								
2020-4-28 9:12								
Frequency MHz	Level dBuV	Transd dB	Limit dBuV	Margin dB	Detector	Line	PE	
0.188000	52.40	10.8	64	11.7	QP	L1	GND	
0.376000	40.70	10.9	58	17.7	QP	L1	GND	
1.380000	38.10	11.2	56	17.9	QP	L1	GND	
4.955000	27.90	11.4	56	28.1	QP	L1	GND	
12.340000	30.30	11.6	60	29.7	QP	L1	GND	
16.070000	35.10	11.7	60	24.9	QP	L1	GND	
<b>MEASUREMENT RESULT: "F-0295-A4_fin2"</b>								
2020-4-28 9:12								
Frequency MHz	Level dBuV	Transd dB	Limit dBuV	Margin dB	Detector	Line	PE	
0.188000	43.40	10.8	54	10.7	AV	L1	GND	
0.660000	38.30	11.1	46	7.7	AV	L1	GND	
1.860000	38.90	11.2	46	7.1	AV	L1	GND	
2.140000	28.90	11.3	46	17.1	AV	L1	GND	
7.380000	23.00	11.5	50	27.0	AV	L1	GND	
15.930000	26.10	11.7	50	23.9	AV	L1	GND	

Emissions attenuated more than 20 dB below the permissible value are not reported.

The spectral diagrams are attached as below.

**ACCURATE TECHNOLOGY CO.,LTD**

**CONDUCTED EMISSION STANDARD FCC PART 15B**

EUT: Message Chair M/N:EC-802T  
 Manufacturer: XIAMEN HEALTHCARE ELECHRONIC CO.,LTD  
 Operating Condition: BT OPERATION  
 Test Site: 1#Shielding Room  
 Operator: Frank  
 Test Specification: L 120V/60Hz  
 Comment: Report NO.:ATE20200296  
 Start of Test: 2020-4-28 / 9:11:07

**SCAN TABLE: "V 150K-30MHz fin"**

Short Description: SUB STD VTERM2 1.70  
 Start Stop Step Detector Meas. IF Transducer  
 Frequency Frequency Width Time Bandw.  
 150.0 kHz 30.0 MHz 4.5 kHz QuasiPeak 1.0 s 9 kHz NSLK8126 2008  
 Average

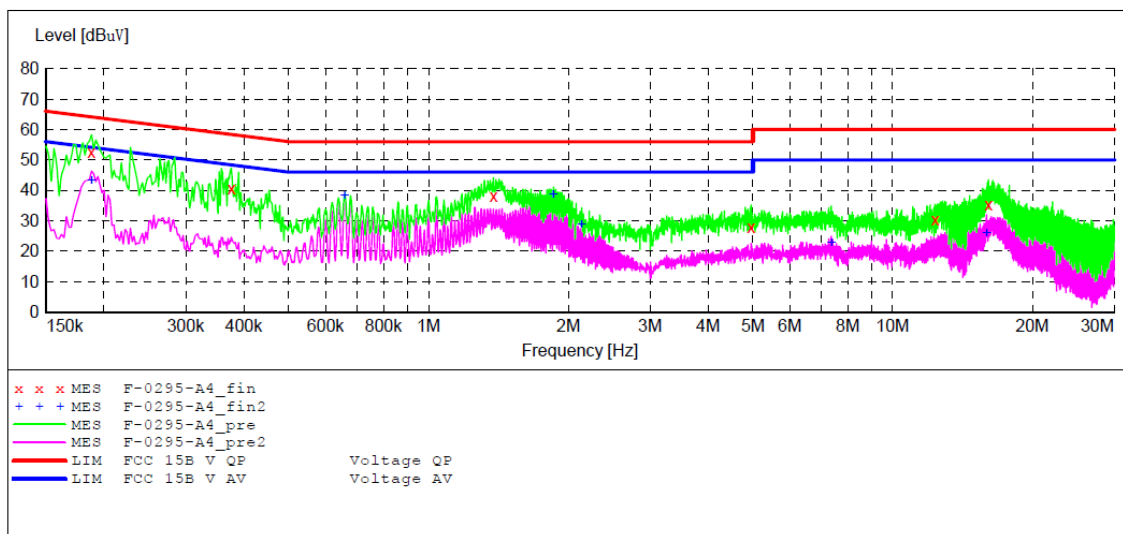

**MEASUREMENT RESULT: "F-0295-A4\_fin"**

2020-4-28 9:12

Frequency MHz	Level dBuV	Transd dB	Limit dBuV	Margin dB	Detector	Line	PE
0.188000	52.40	10.8	64	11.7	QP	L1	GND
0.376000	40.70	10.9	58	17.7	QP	L1	GND
1.380000	38.10	11.2	56	17.9	QP	L1	GND
4.955000	27.90	11.4	56	28.1	QP	L1	GND
12.340000	30.30	11.6	60	29.7	QP	L1	GND
16.070000	35.10	11.7	60	24.9	QP	L1	GND

**MEASUREMENT RESULT: "F-0295-A4\_fin2"**

2020-4-28 9:12

Frequency MHz	Level dBuV	Transd dB	Limit dBuV	Margin dB	Detector	Line	PE
0.188000	43.40	10.8	54	10.7	AV	L1	GND
0.660000	38.30	11.1	46	7.7	AV	L1	GND
1.860000	38.90	11.2	46	7.1	AV	L1	GND
2.140000	28.90	11.3	46	17.1	AV	L1	GND
7.380000	23.00	11.5	50	27.0	AV	L1	GND
15.930000	26.10	11.7	50	23.9	AV	L1	GND

**ACCURATE TECHNOLOGY CO.,LTD**

**CONDUCTED EMISSION STANDARD FCC PART 15B**

EUT: Massage Chair M/N:EC-802T  
 Manufacturer: XIAMEN HEALTHCARE ELECHRONIC CO.,LTD  
 Operating Condition: BT OPERATION  
 Test Site: 1#Shielding Room  
 Operator: Frank  
 Test Specification: N 120V/60Hz  
 Comment: Report NO.:ATE20200296  
 Start of Test: 2020-4-28 / 9:08:50

**SCAN TABLE: "V 150K-30MHz fin"**

Short Description: SUB STD VTERM2 1.70  
 Start Stop Step Detector Meas. IF Transducer  
 Frequency Frequency Width Time Bandw.  
 150.0 kHz 30.0 MHz 4.5 kHz QuasiPeak 1.0 s 9 kHz NSLK8126 2008  
 Average

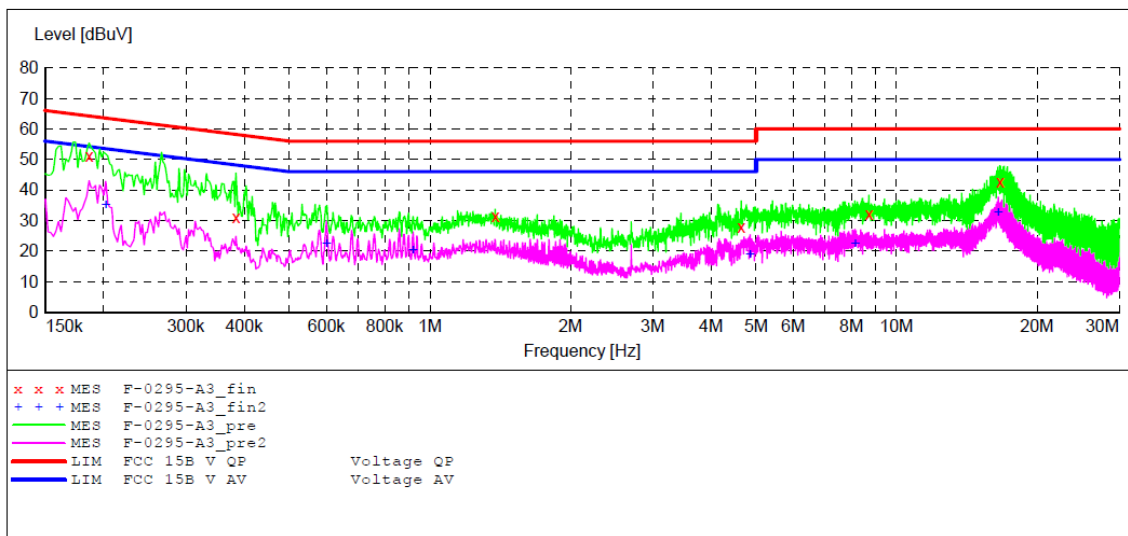

**MEASUREMENT RESULT: "F-0295-A3\_fin"**

2020-4-28 9:10

Frequency MHz	Level dBuV	Transd dB	Limit dBuV	Margin dB	Detector	Line	PE
0.186000	51.30	10.8	64	12.9	QP	N	GND
0.384000	31.00	10.9	58	27.2	QP	N	GND
1.380000	31.40	11.2	56	24.6	QP	N	GND
4.645000	27.70	11.4	56	28.3	QP	N	GND
8.730000	31.90	11.5	60	28.1	QP	N	GND
16.650000	42.70	11.7	60	17.3	QP	N	GND

**MEASUREMENT RESULT: "F-0295-A3\_fin2"**

2020-4-28 9:10

Frequency MHz	Level dBuV	Transd dB	Limit dBuV	Margin dB	Detector	Line	PE
0.202000	35.10	10.8	54	18.4	AV	N	GND
0.600000	22.70	11.0	46	23.3	AV	N	GND
0.920000	20.60	11.1	46	25.4	AV	N	GND
4.855000	19.20	11.4	46	26.8	AV	N	GND
8.145000	22.40	11.5	50	27.6	AV	N	GND
16.510000	32.70	11.7	50	17.3	AV	N	GND

## **13.ANTENNA REQUIREMENT**

### **13.1.The Requirement**

According to Section 15.203, an intentional radiator shall be designed to ensure that no antenna other than that furnished by the responsible party shall be used with the device.

### **13.2.Antenna Construction**

Device is equipped with permanent attached antenna, which isn't displaced by other antenna. The Antenna gain of EUT is 2dBi. Therefore, the equipment complies with the antenna requirement of Section 15.203.