

**Brookstone®**

**BK-650/EC-7505B**

User Manual



# Hello.

Congratulations on purchasing your new Brookstone BK-650.

At Brookstone we understand that every body is different and have carefully designed your massage chair with that in mind. But enough about us, this is about you. Learning how to use your new chair is simple (we designed it that way).

So let's get started.

## We Can Help.

Our team will respond quickly to help you solve any issues

**1.877.977.0656**

Need a deeper massage?  
Remove Softening Pad

- 1** Unzip
- 2** Fold Down
- 3** Remove Pad

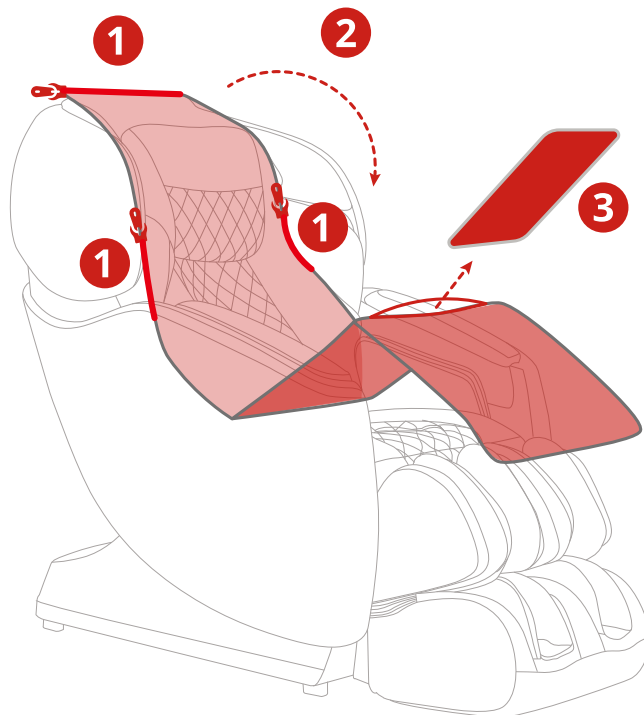

**Scan QR Code for Support**  
Open camera app & scan for instant support



For replacement parts and tech support, please call our service and warranty hotline, or visit [www.cozziausa.com](http://www.cozziausa.com)

# TABLE OF CONTENTS

 INTRO	Safety .....	3-4
	Dimensions .....	5
	Contents .....	6
 CHAIR	Move & Clearance .....	7
	Components .....	8
	Massage Points .....	9
	Specifications .....	10
 MESSAGE	Interface .....	11-14
	Pre-Programed Massage .....	15-20
	Demo .....	21-22
	Custom Massage .....	23-27
	Spot Massage .....	28-30
	Settings .....	31-36
Voice Control .....	37-44	
 CARE	Grounding Instructions .....	45
	Troubleshooting .....	45
	Care and Storage .....	45
	Warranty .....	46

# SAFETY PRECAUTIONS

We're looking out for you.

## IMPORTANT SAFETY INSTRUCTIONS

When using an electrical appliance, basic precautions should always be followed, including the following: Read all instructions before using (this appliance).

### DANGER -To reduce the risk of electric shock:

- Always unplug this appliance from the electrical outlet immediately after using and before cleaning.
- Never use pins or other metallic fasteners with this appliance.
- Carefully examine the covering before each use. Discard the appliance if the covering shows any sign of deterioration, such as checking, blistering, or cracking.
- Keep Dry-Do not operate in a wet or moist condition.

### WARNING -To reduce the risks of burns, fire, electric shock or injury to persons:

- An appliance should never be left unattended when plugged in. Unplug from outlet when not in use, and before putting on or taking off parts.
- Close supervision is necessary when this appliance is used by, on, or near children, invalids, or disabled persons.
- Use this appliance only for its intended use as described in this manual. Do not use attachments not recommended by the manufacturer.
- Never operate this appliance if it has a damaged cord or plug, if it is not working properly, if it has been dropped or damaged, or dropped into water. Return the appliance to a service center for examination and repair.
- Do not carry this appliance by supply cord or use cord as a handle.
- Keep the cord away from heated surfaces.
- Never operate the appliance with the air openings blocked. Keep the air openings free of lint, hair, and the like.
- Never drop or insert any object into any opening.
- Do not use outdoors.
- Do not operate where aerosol (spray) products are being used or where oxygen is being administered.
- To disconnect, turn all controls to the off position, then remove plug from outlet.
- Keep children away from extended foot support.
- Connect this appliance to a properly grounded outlet only. See Grounding Instructions.
- Use heated surfaces carefully. May cause serious burns. Do not use over insensitive skin areas or in the presence of poor circulation. The unattended use of heat by children or incapacitated persons may be dangerous.
- Do not operate under blanket or pillow. Excessive heating can occur and cause fire, electric shock, or injury to persons.

## SAVE THESE INSTRUCTIONS

This massage chair is intended for household use only.

### 1. Usage Environment

- Do not use the massage chair in an excessively humid or dusty environment as this may result in malfunction or electric shock.
- Do not use the massage chair in a room with a temperature of 104°F or higher.
- Do not expose the massage chair to heaters, stoves or direct sunlight.
- Place and use the massage chair on an even, non-slip floor.
- The massage chair is designed for home use and not for commercial purposes.



Caution

- This massage chair is to be used indoors only.
- If you use the massage chair in a cold room, do not increase the room temperature abruptly. It is recommended that you increase the temperature gradually to a normal level.
- If the massage chair is stored in a cold place and is being brought into a warm environment, it is advisable to wait for one hour before use. This is because its performance may not be at optimum level, as there may be water droplets on the mechanical parts due to consideration. Using the massage chair under such conditions may result in malfunction.

### 2. Safety Precautions

- It is not recommended to use the massage chair for more than 30 minutes.
- Do not perform continuous massage on the same spot of your body for more than 5 minutes at a time as this may result in excessive stimulation and may have adverse effects.
- Do not insert your hand or foot along the paths of the massage rollers during use as this may cause injury.
- Stop operation immediately if you feel any discomfort.
- This product is not intended for self-treatment of conditions that should be managed by a qualified health care provider.
- People on medication or with medical conditions, please consult your doctor before use. Please do not use the product if you are not feeling well.
- It is not recommended to use the massage chair for more than 30 minutes.
- Do not perform continuous massage on the same spot of your body for more than 5 minutes at a time as this may result in excessive stimulation and may have adverse effects.
- Do not insert your hand or foot along the paths of the massage rollers during use as this may cause injury.
- Stop operation immediately if you feel any discomfort.
- This product is not intended for self-treatment of conditions that should be managed by a qualified health care provider.
- People on medication or with medical conditions, please consult your doctor before use. Please do not use the product if you are not feeling well.

### 3. People with Medical Conditions

Consult your doctor before use if you:

- Are under medical rest as ordered by a doctor.
- Have spinal disorders, an abnormal spinal condition or have suffered a spinal injury.
- Have back problems.
- Have diabetes, osteoporosis or sensory impairment.
- Have joint dysfunction such as rheumatism, hammertoe or gout.
- Have a pacemaker or other electronic medical devices.
- May be pregnant.
- Have phlebitis or thrombosis.
- Have an increased risk for blood clots.
- Had recent surgery.
- Have surgical pins, screws, or anything mechanical in the legs, ankles or feet.



Caution

- This massage chair is not intended for use by children or persons with reduced physical, sensory or mental capabilities, or lack of experience and knowledge, unless they have been given supervision or instruction or instruction concerning use of the massage chair by a person responsible for their safety.
- Children should be supervised to ensure that they do not play with the massage chair.
- Avoid using the massage chair under the influence of alcohol.
- Do not apply massage rollers directly on the head, elbow or knee joints, torso or abdomen.
- If your legs or feet slip off the leg rest during massage, do not force them back in as this may result in injury.
- Remove the power plug from the electrical outlet immediately should liquid be accidentally spilled onto the massage chair. Do not use wet hands to connect or disconnect the power plug from the electrical outlet.
- Do not tamper with the power cord or use the massage with a damaged cord as this may result in malfunction and electric shock.

### 4. Instances When the Massage Chair Should Not Be Used

In the following events, please switch off the main power switch immediately and disconnect the power cord from the electrical outlet:

- If liquid is accidentally spilled onto the massage chair. This may result in electric shock or malfunction.
- If the fabric of the backrest is torn and the internal components are exposed.
- If pain or discomfort is felt during massage, stop operation immediately and consult your doctor.
- If you detect any malfunction or any other abnormal condition during operation.
- If there is power failure. Injury may occur when power is restored unexpectedly.
- If there is lightning.

### 5. Assembly and Repair of the Massage Chair

- Do not disassemble the backrest cover of the massage chair. Touching the internal components may result in malfunction or electrical shock.
- This massage chair must only be professionally serviced or repaired. Do not attempt to disassemble or repair the massage chair by yourself.

### 6. Things to Be Noted About the Power Plug and Cord

- Check that the Alternating Current (AC) voltage corresponds with the specifications indicated for the massage chair.
- Do not connect or disconnect the power plug from the electrical outlet with wet hands. This may result in malfunction or electric shock.
- When disconnecting the power plug, pull it by holding the plug, not the cord.
- Although operation will be stopped automatically by the Auto-Timer function, always remember to switch off the main power after use.
- Do not place the power cord under the massage chair or any other heavy objects.
- Do not wind the power cord around the massage chair as this may damage the cord and result in a fire or electric shock.
- Do not operate the massage with a damaged cord or extension cord.
- Do not use the massage if the electrical outlet is loose.
- If the power cord is damaged, it should be replaced by a qualified technician.

## FCC STATEMENT

1. This device complies with Part 15 of the FCC Rules. Operation is subject to the following two conditions:

- (1) This device may not cause harmful interference, and
- (2) This device must accept any interference received, including interference that may cause undesired operation.

2. Changes or modifications not expressly approved by the party responsible for compliance could void the user's authority to operate the equipment.

This equipment has been tested and found to comply with the limits for a Class B digital device, pursuant to part 15 of the FCC Rules. These limits are designed to provide reasonable protection against harmful interference in a residential installation. This equipment generates, uses and can radiate radio frequency energy and, if not installed and used in accordance with the instructions, may cause harmful interference to radio communications. However, there is no guarantee that interference will not occur in a particular installation. If this equipment does cause harmful interference to radio or television reception, which can be determined by turning the equipment off and on, the user is encouraged to try to correct the interference by one or more of the following measures:

- Reorient or relocate the receiving antenna.
- Increase the separation between the equipment and receiver.
- Connect the equipment into an outlet on a circuit different from that to which the receiver is connected.
- Consult the dealer or an experienced radio/ TV technician for help.

This device contains licence-exempt transmitter(s)/receiver(s) that comply with Innovation, Science and Economic Development Canada's licence-exempt RSS(s). Operation is subject to the following two conditions:

- (1) This device may not cause interference.
- (2) This device must accept any interference, including interference that may cause undesired operation of the device.

L'émetteur/récepteur exempt de licence contenu dans le présent appareil est conforme aux CNR d'Innovation, Sciences et Développement économique Canada applicables aux appareils radio exempts de licence. L'exploitation est autorisée aux deux conditions suivantes : 1) L'appareil ne doit pas produire de brouillage; 2) L'appareil doit accepter tout brouillage radioélectrique subi, même si le brouillage est susceptible d'en compromettre le fonctionnement.

## FCC Radiation Exposure Statement:

This equipment complies with FCC radiation exposure requirement. The device can be used in portable exposure condition without RF restriction.

# DIMENSIONS

First, let's get your chair inside.

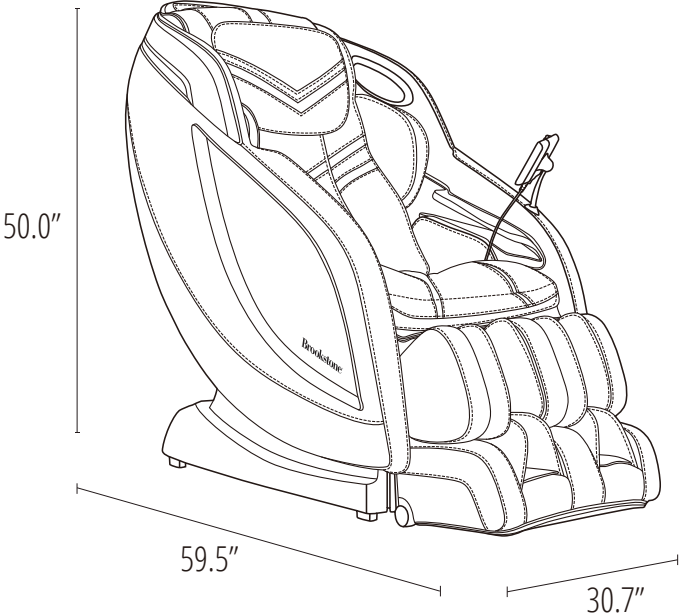

Box 1

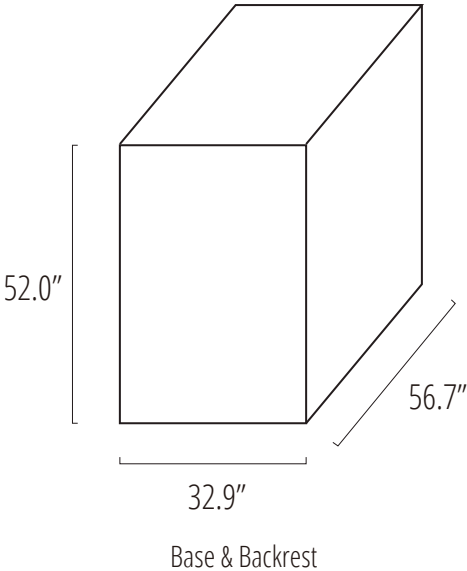

Base & Backrest

Box 2

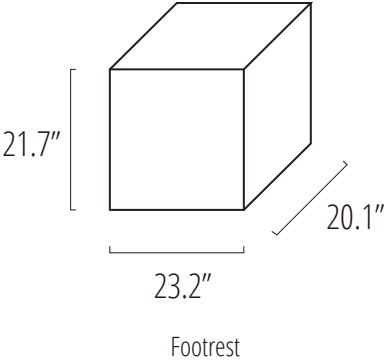

Footrest

# CONTENTS

Everything you need for a relaxing experience.

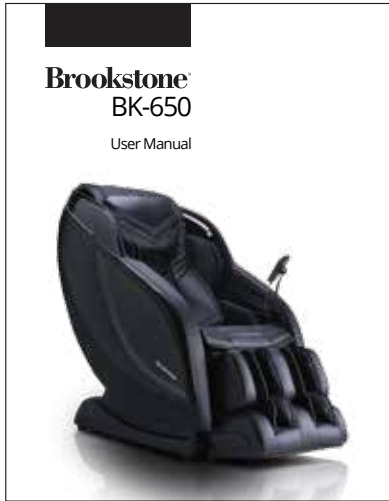

User Manual



Installation Manual



Warranty Postcard

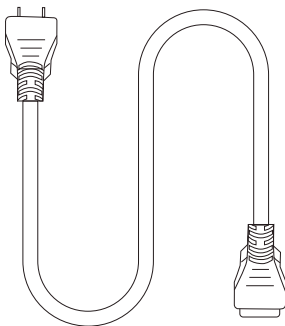

Power Cord

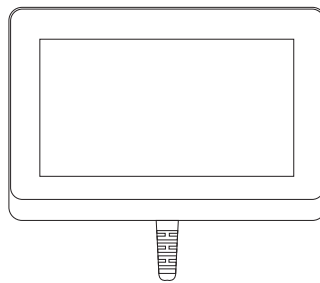

Wired Touch-Pad



BK-650 Massage Chair

# Move & Clearance

A few simple steps to find the best place for your new chair.

## HOW TO MOVE

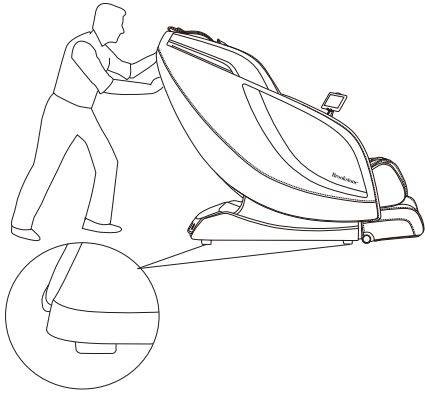

Move with a slight pull or push

Caution: If you roll the chair on wood floor, marks may be left

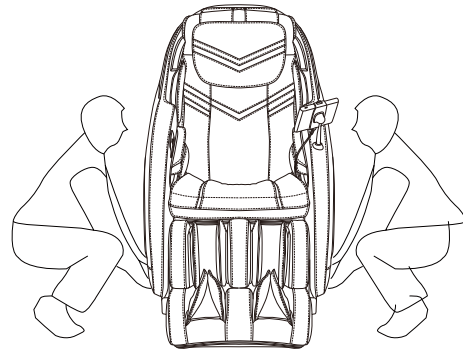

Two people are needed to lift the chair

## CLEARANCE

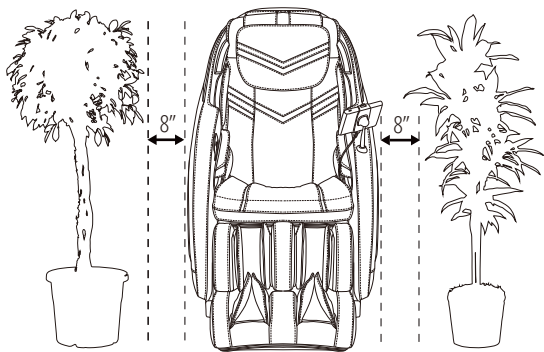

Reserve space on left and right

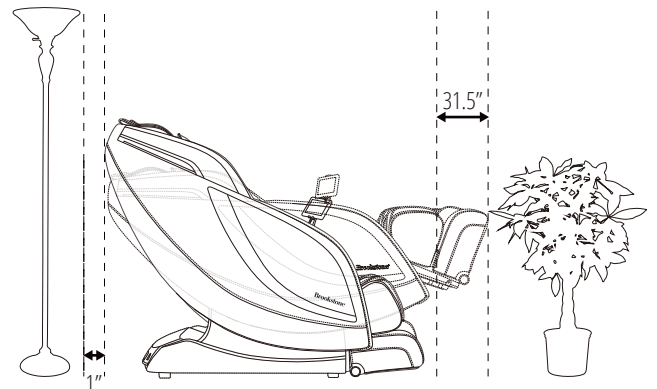

Reserve space on the front and back



# CHAIR COMPONENTS

Some of your chair's most important features.

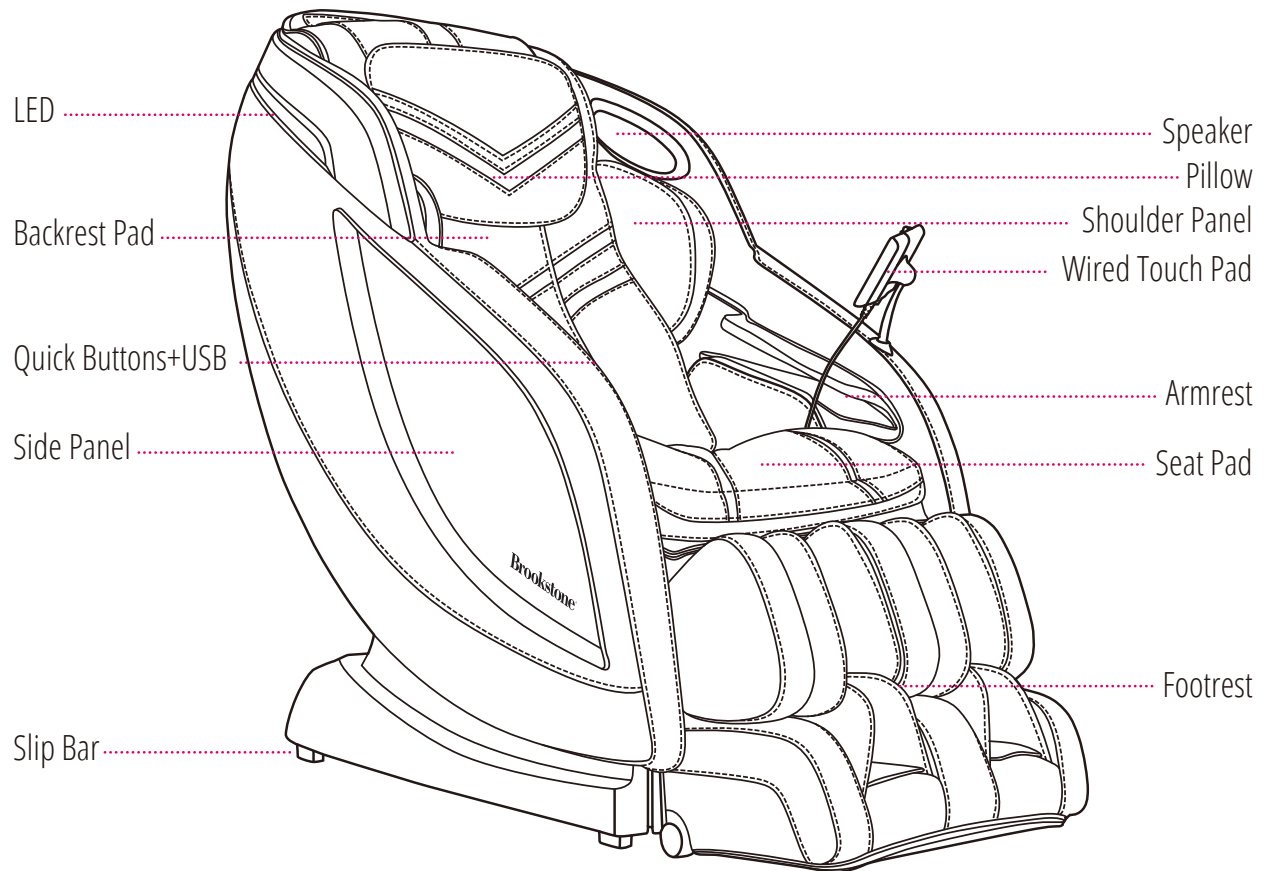

Note: The speaker will only operate when the massage chair is in operation



To play music using your massage chair's speakers please connect your smartphone, tablet, or other electronic device to your chair using bluetooth.

Note that the code to connect the bluetooth is located on the tablet holder.

# MASSAGE POINTS

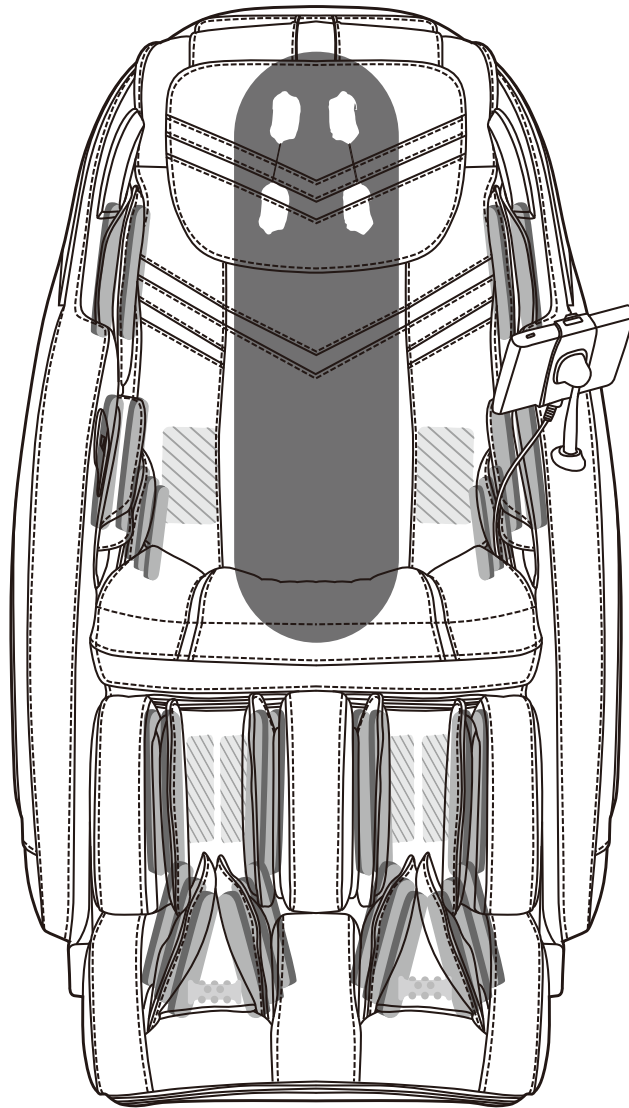

14 Air Bags  
2 Heating Pads

12 Air Bags  
4 Heating Pads

20 Air Bags  
2 Rollers

 Back Massage Mode

 Air Bag

 Roller

 Heating Pads

# CHAIR SPECIFICATIONS

A few important facts about your massage chair.



## Model No.

BK-650

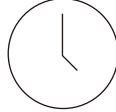

## Massage Time

5 to 30 minutes

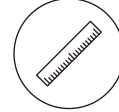

## Dimensions (L x W x H)

Chair Dimensions: 59.5" x 30.7" x 50.0"  
Reclined Dimensions: 68.9" x 30.7" x 42.1"



## Shipping Weight

Gross weight: 288.8lbs  
Net weight: 243.6lbs



## Usage Condition

Environment temperature: 10°C-40°C  
Contrasting humidity: 30-85RH

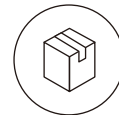

## Storage Condition

Storage temperature: -20°C-60°C  
Storage humidity level: 30-85RH



## Power Consumption

135W



## Rated Voltage

110 - 120V



## Rated Frequency

60Hz



## Power of Speakers

14W (2 sides)



## Length of Wiring

Controller wiring 27.6"  
Power supply wiring 70.9"



## Safety Feature

Equipped with overheating and power surge detectors safety feature

# WIRED TOUCH-PAD INTERFACE

We have designed your massage chair's tablet controller with a user-friendly interface to make using your chair even easier.

## Home Screen

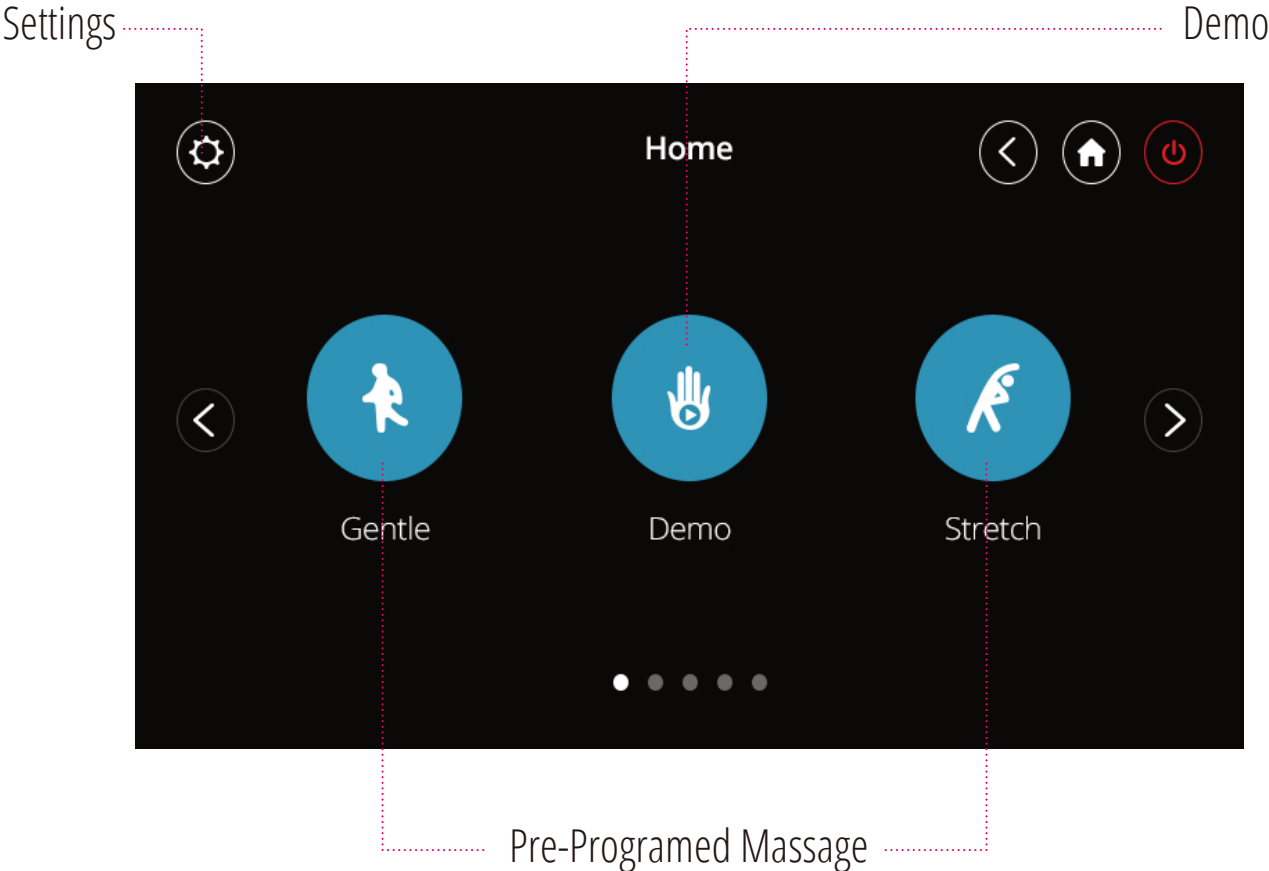

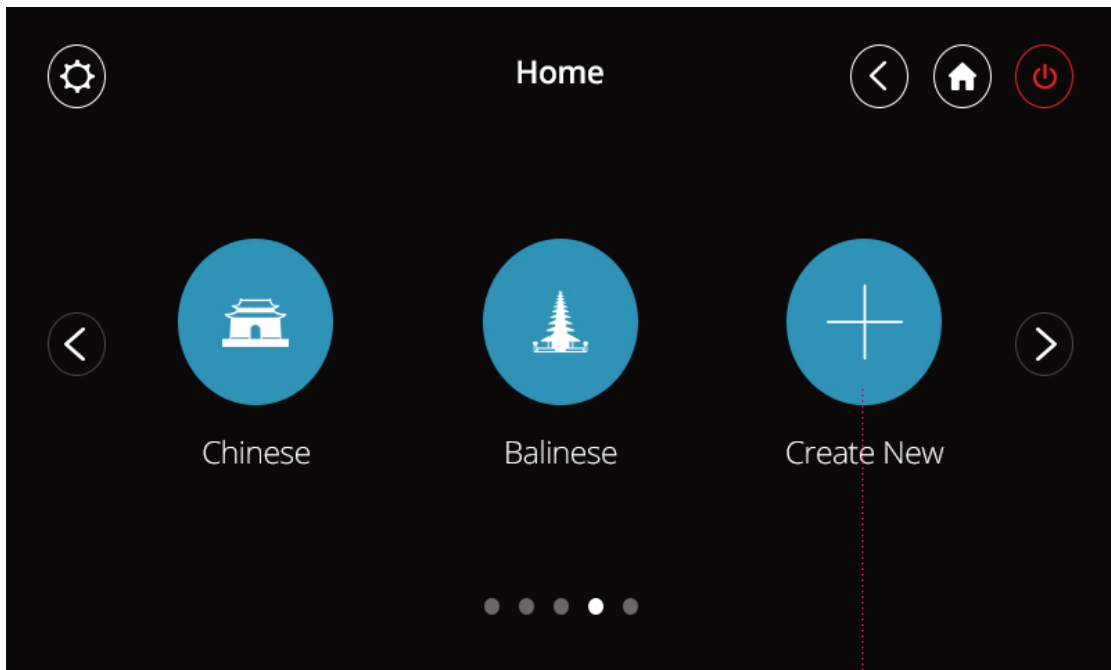

Create New Program

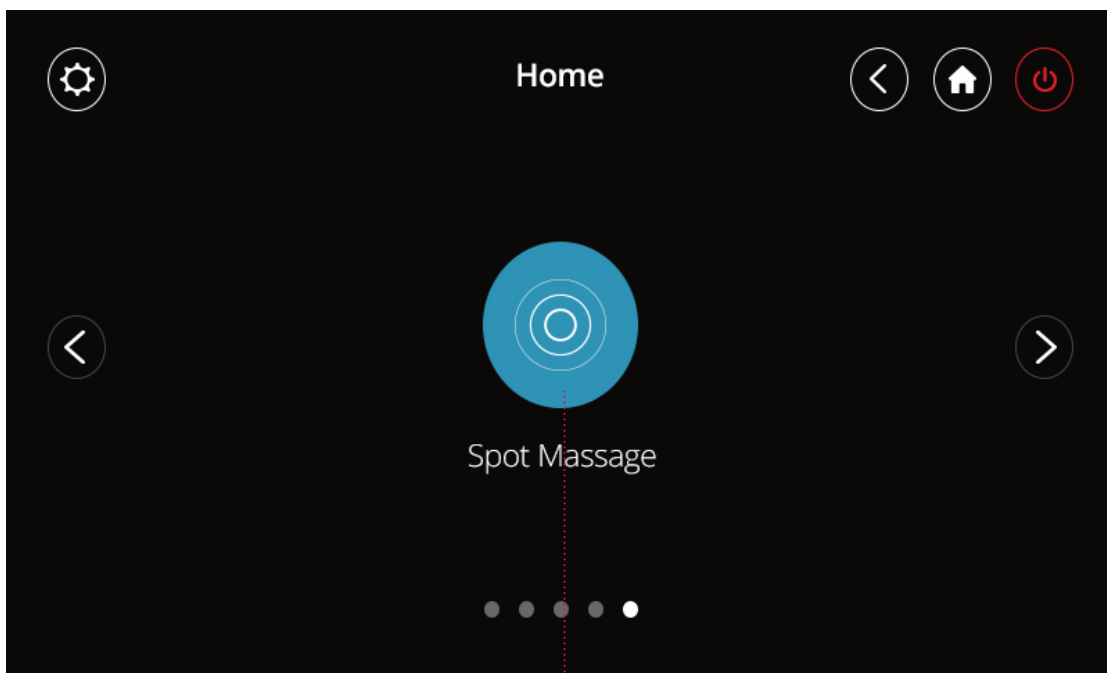

Spot Message

## Massage Controls

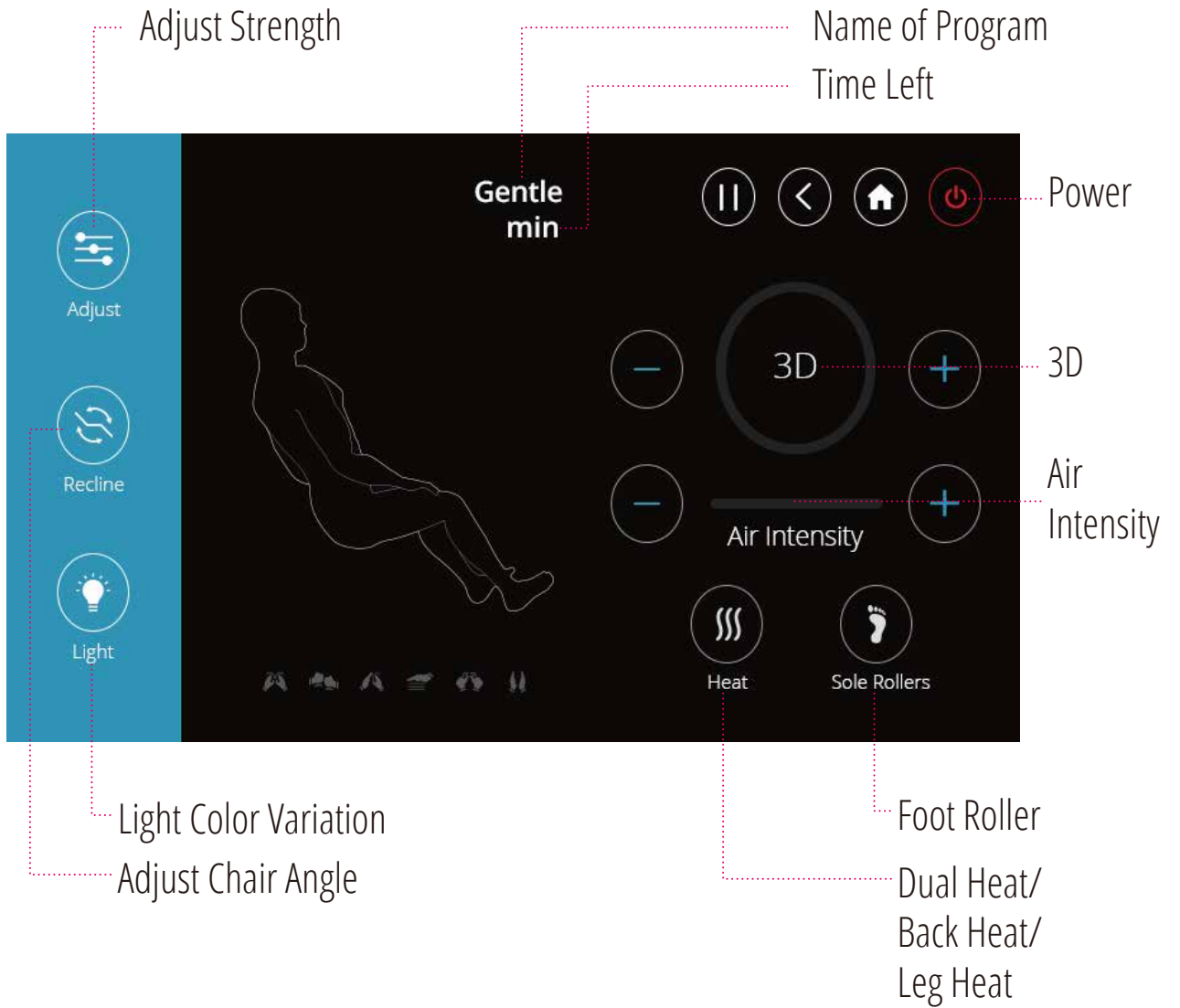

# PRE-PROGRAMMED MESSAGE

We have designed your chair with multiple massage options for your changing needs. Follow these simple instructions to begin a new pre-programmed massage.

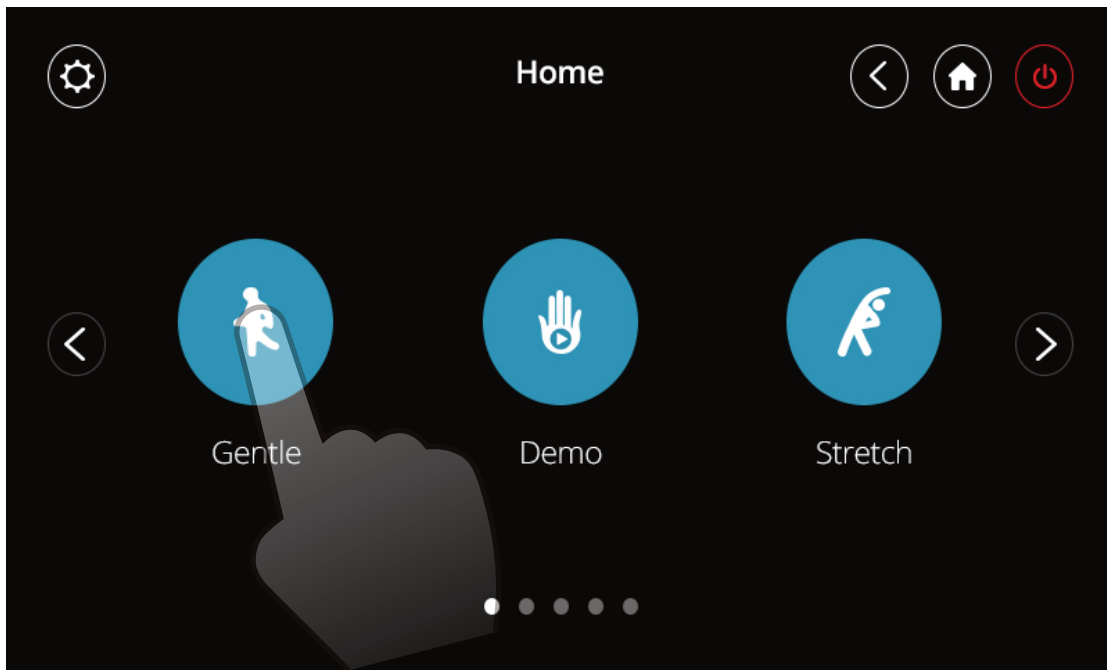

Choose 1 of our 11 pre-programmed massages  
(Gentle, Demo, Stretch, Spine Care, Relax, Vigourous, Swedish, Thai, Japanese, Chinese, Balinese)



## Pre-Programmed Massage Interface



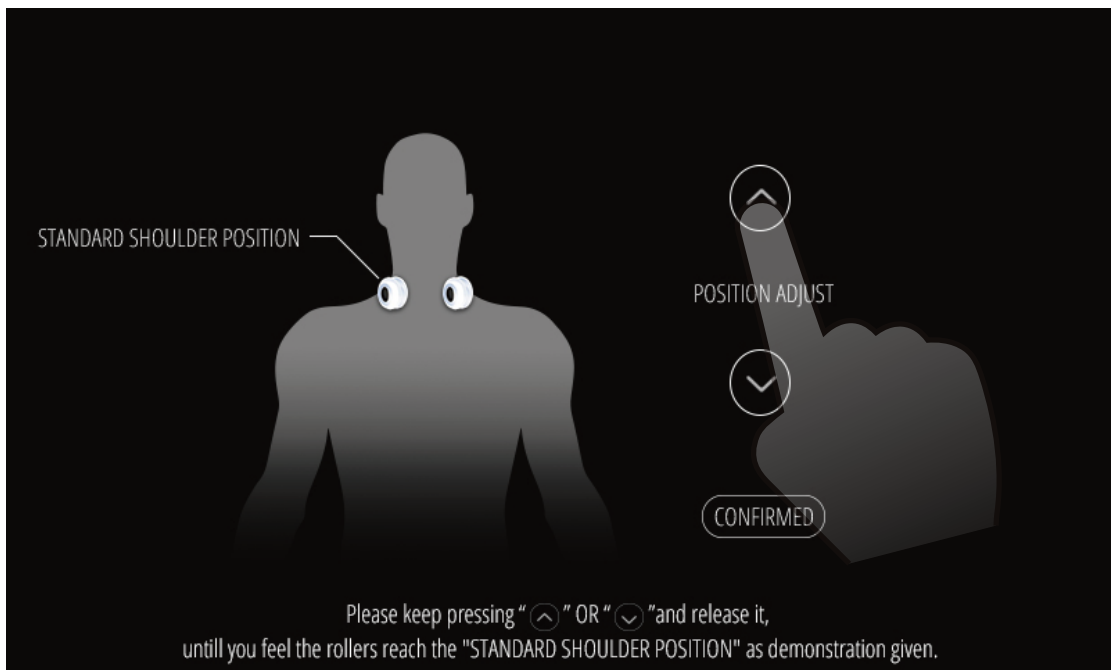

Using the arrows, you can adjust the standard shoulder position

## Adjust Massage Strength Interface

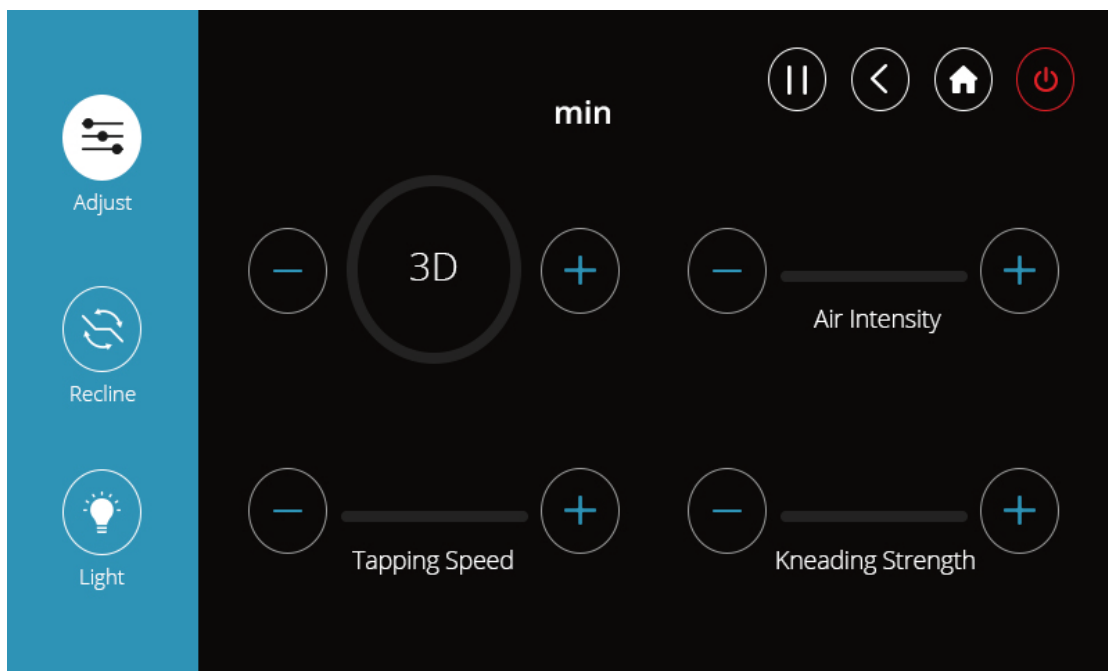

In this interface, you can adjust massage 3D strength, tapping speed, kneading strength and air intensity

## Adjust Chair Angle Interface

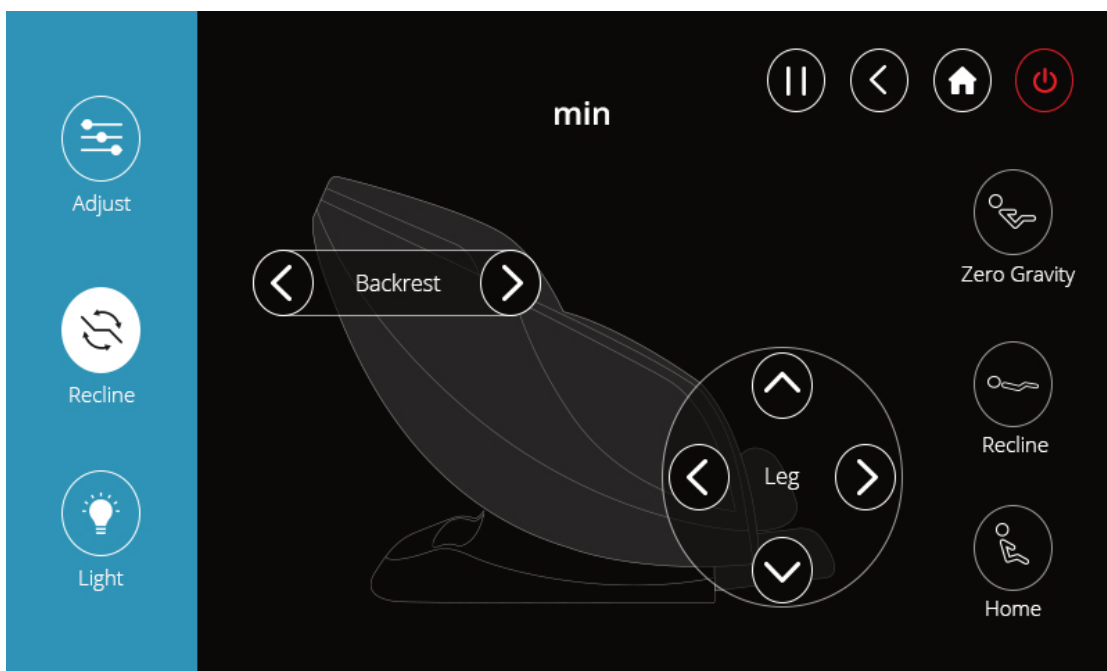

Adjust your chair quickly by choosing one of the three preset seating positions. You can also press and hold the arrows to adjust parts of the chair independently

# Chromotherapy Interface

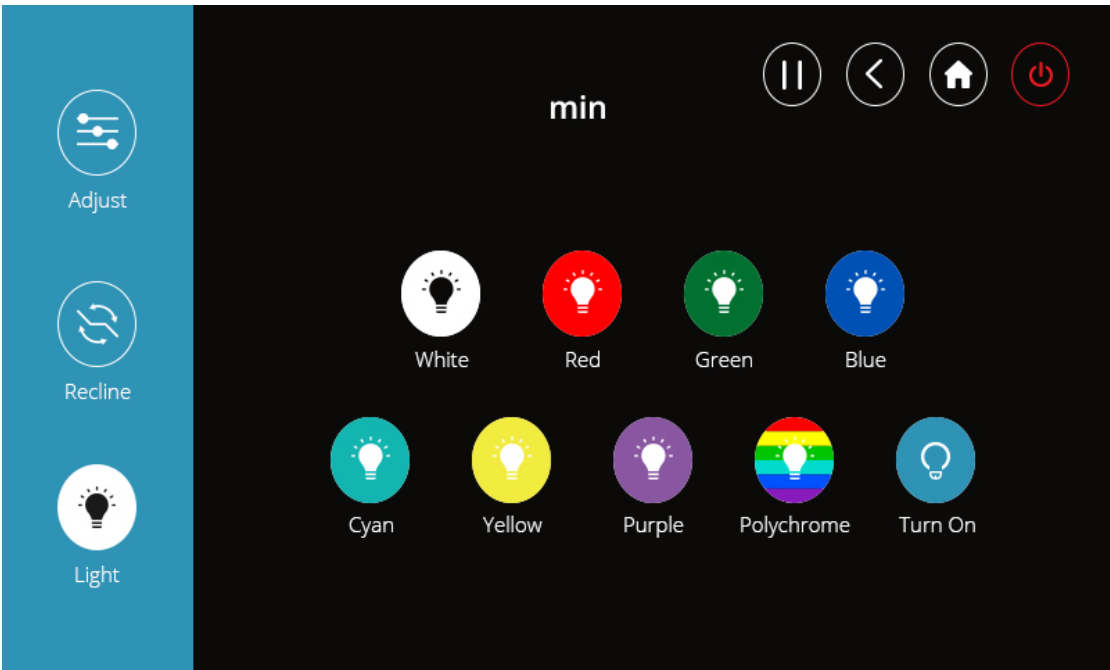

Choose 1 of the 8 types of LED light patterns

# DEMO

In order to allow you to quickly understand how to use the chair, we created a demo module for you.

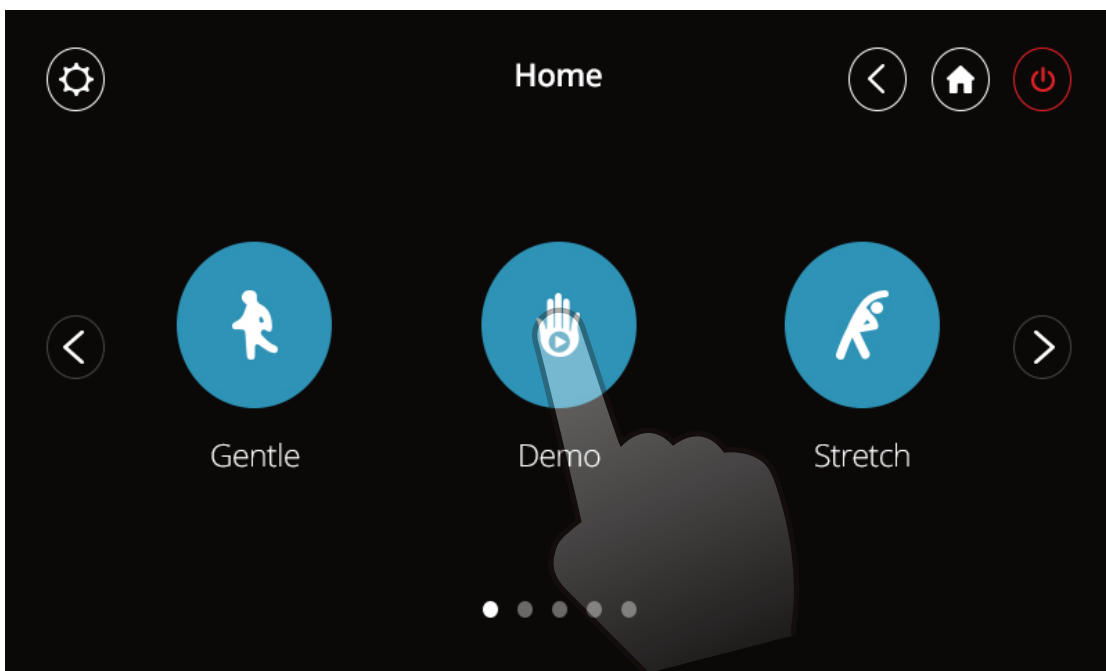

Choose the "Demo" icon to begin demo program

## Demo Interface



## CUSTOM MESSAGE

Every body is different. That's why we've given you the option to customize your own message to meet your specific needs. Follow these simple instructions to create a new custom message. You can create up to 3 custom programs. To delete a custom message, press and hold the custom icon and press "delete".

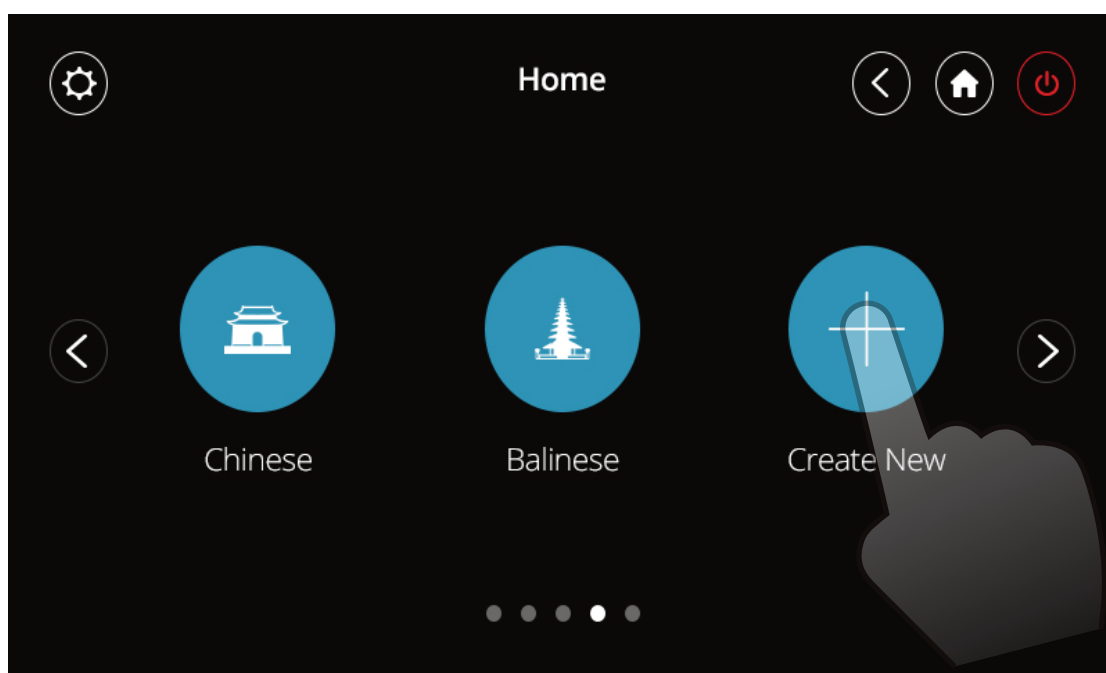

Choose the "Create New" icon to begin creating your massage program



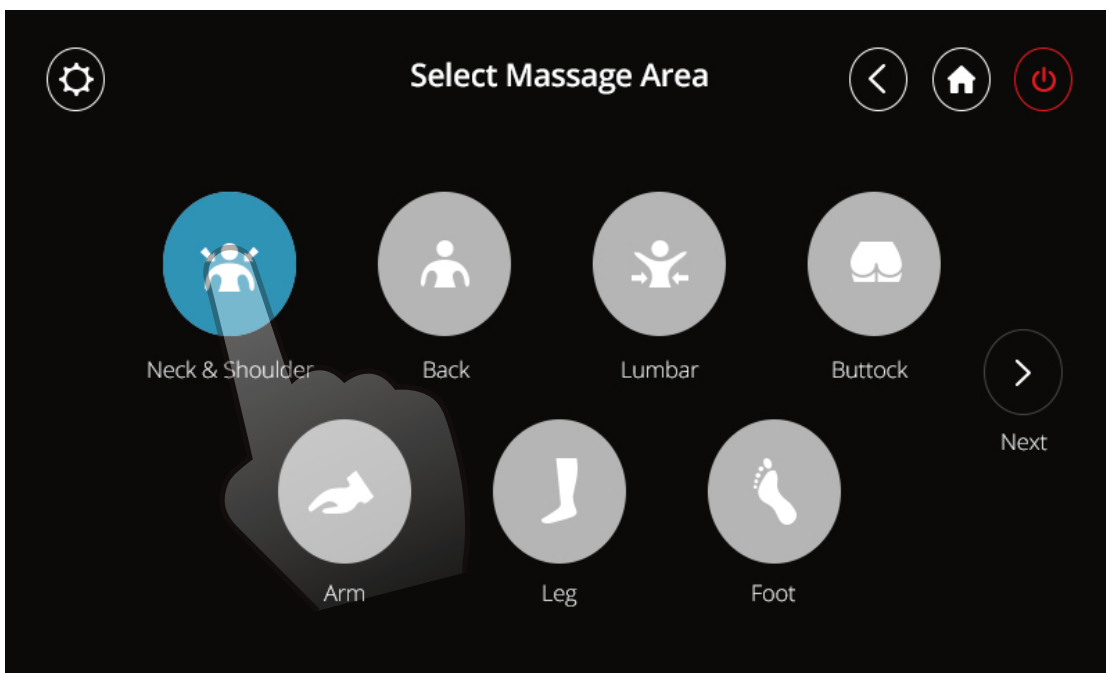

Select your massage area

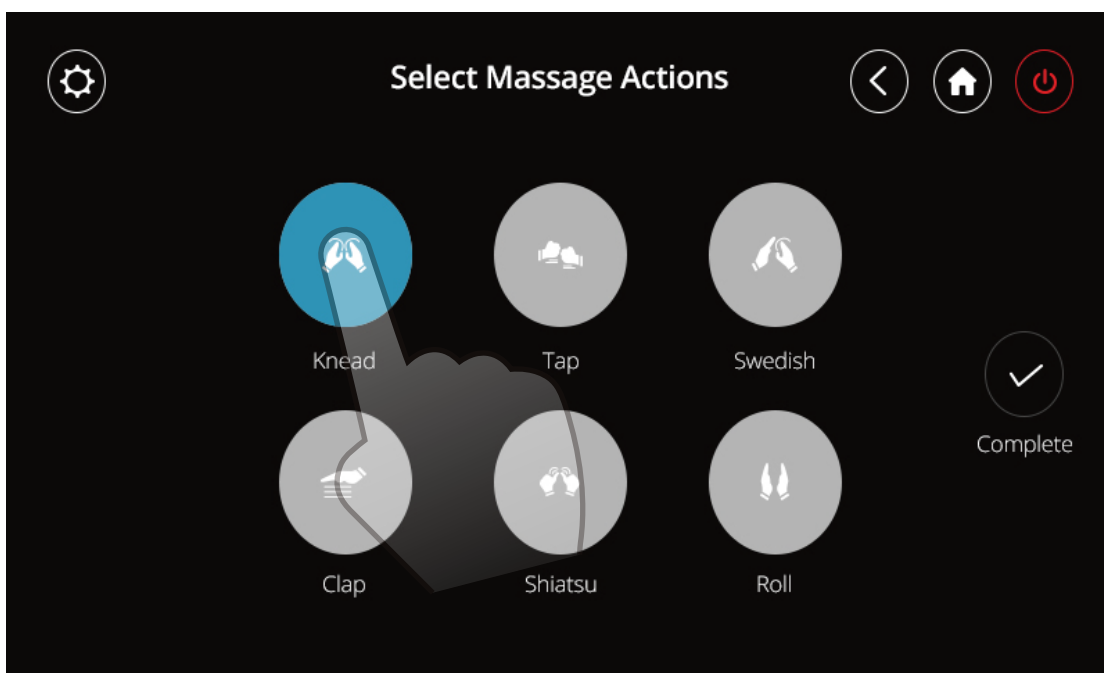

Select your favorite massage actions. The knead, tap, clap, and shiatsu massages can be combined with swedish or roll

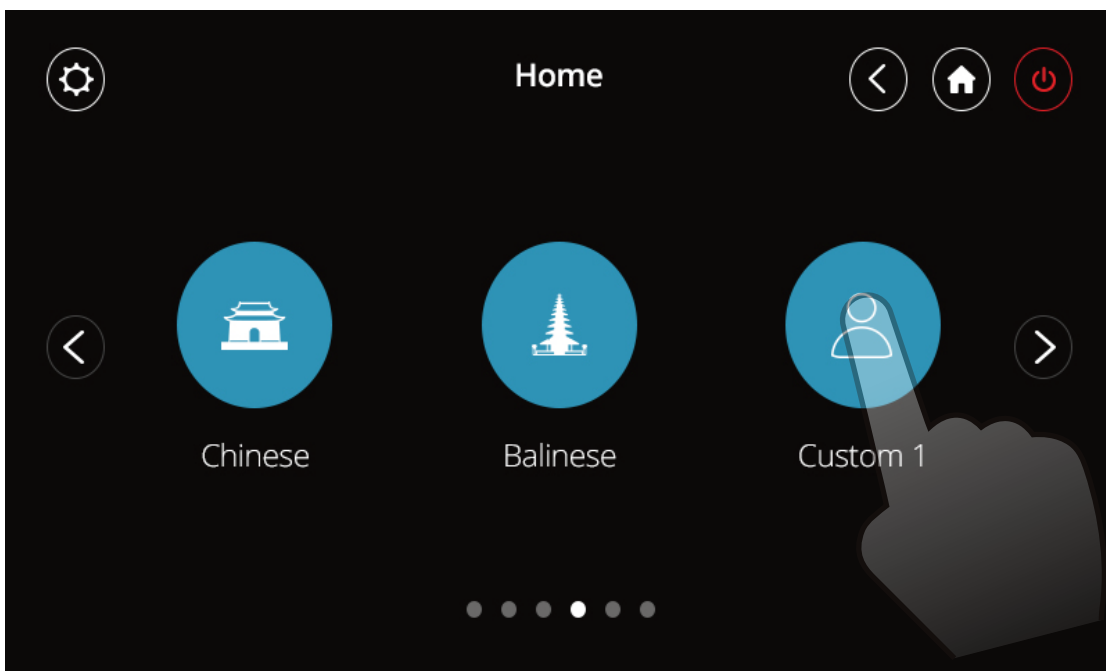

Choose the "Custom 1" icon to start your program

## Custom Interface



# SPOT MESSAGE

This is a fixed message area and actions program

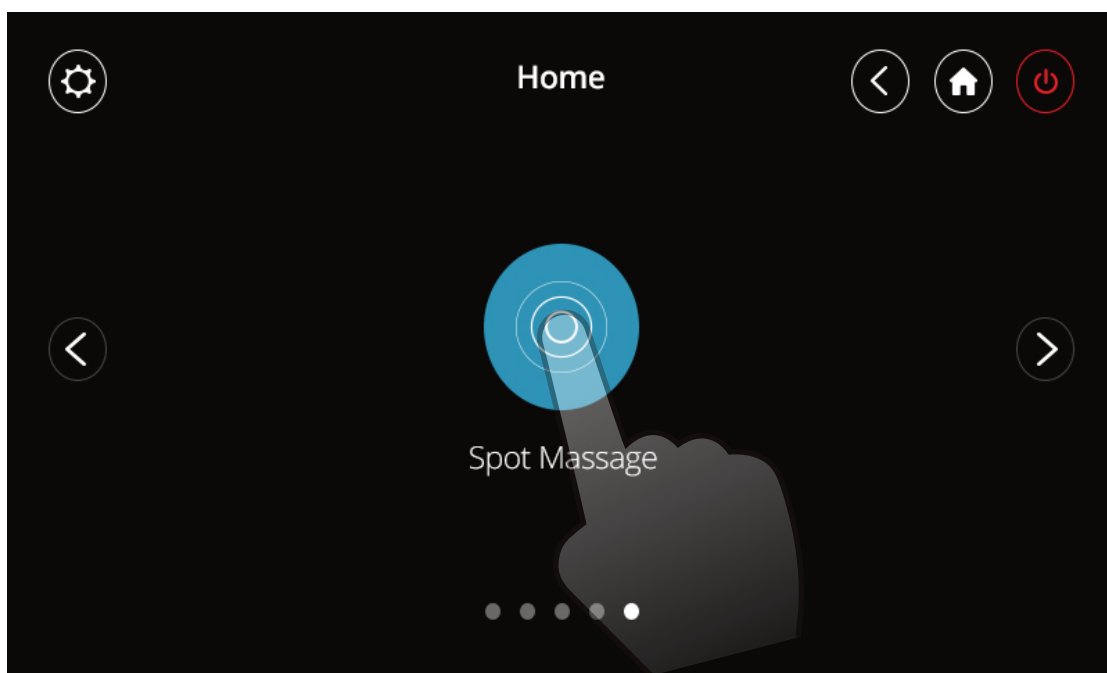

Choose the "Spot Message" button to take you to the Spot Message page

## Spot Massage Interface 1

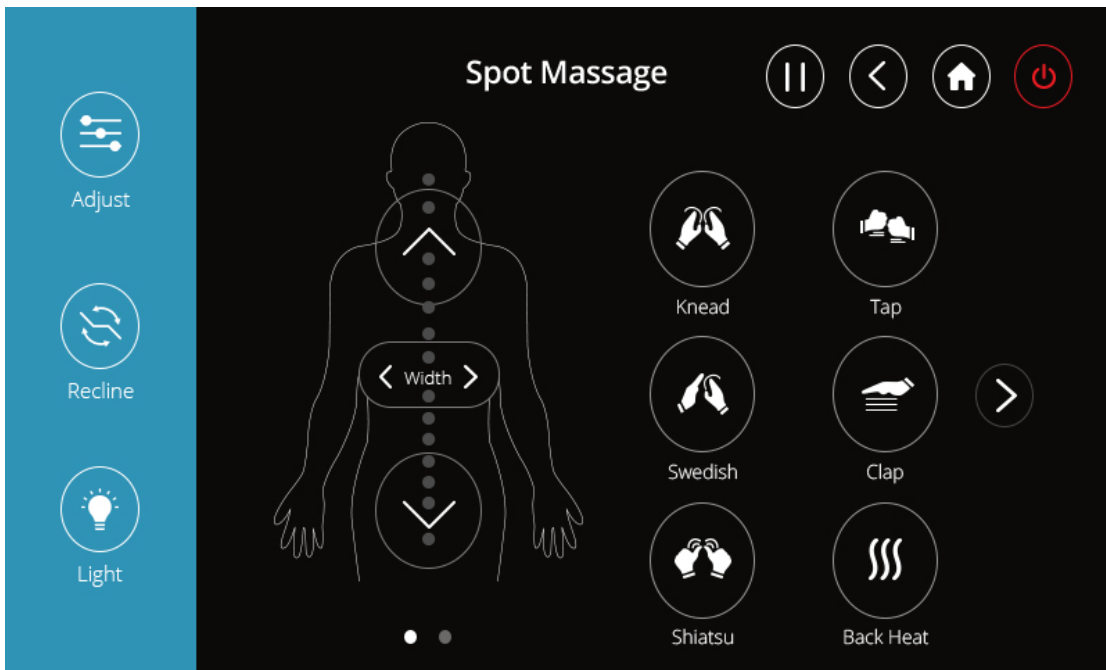

## Spot Massage Interface 2

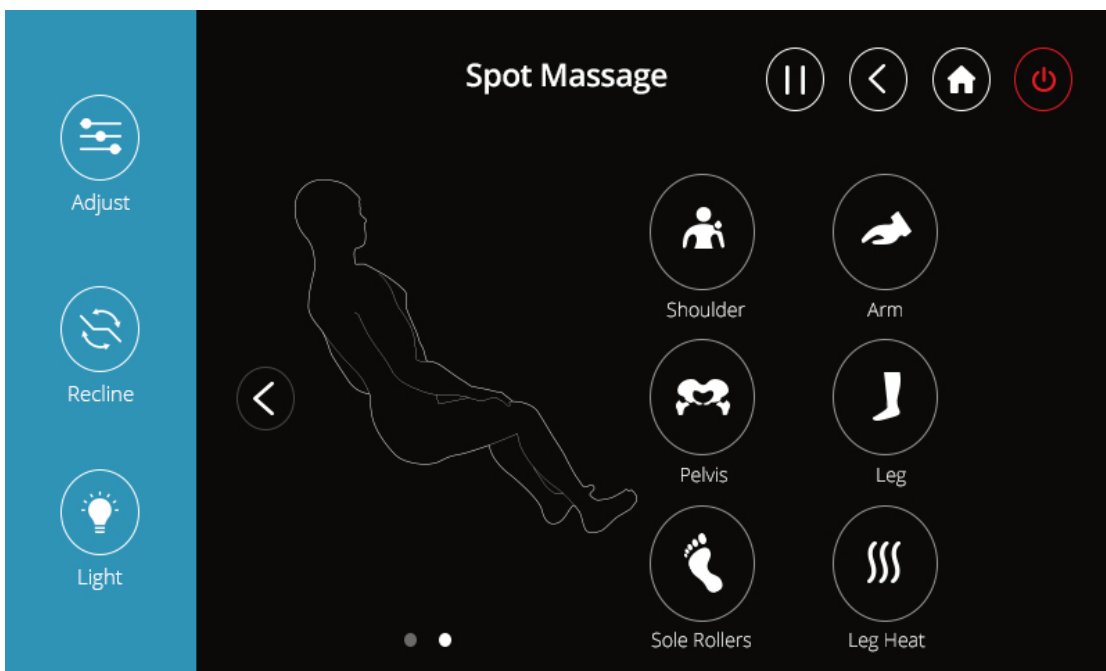

# SETTINGS

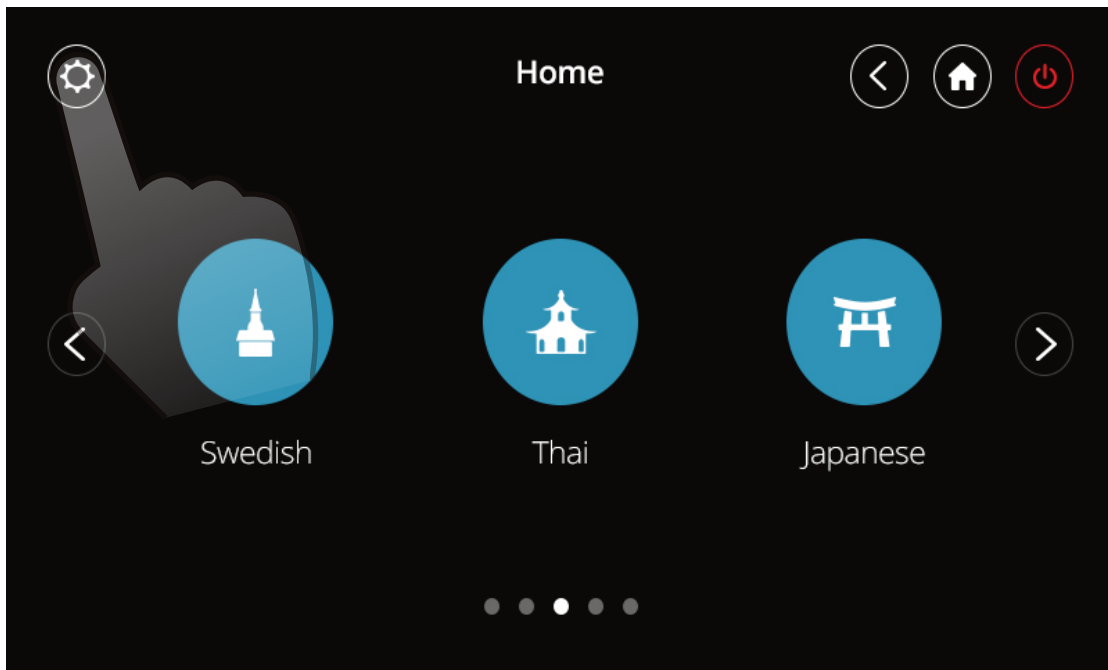

Choose the "Settings" button to take you to the Settings page



## Settings Interface

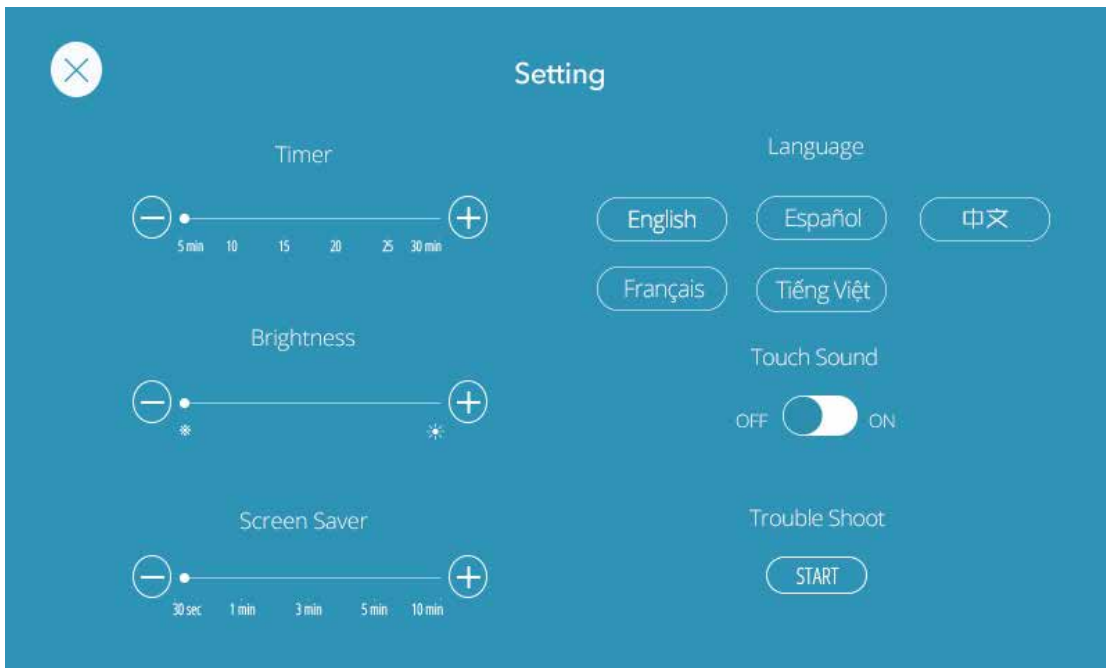

## Trouble Shooting

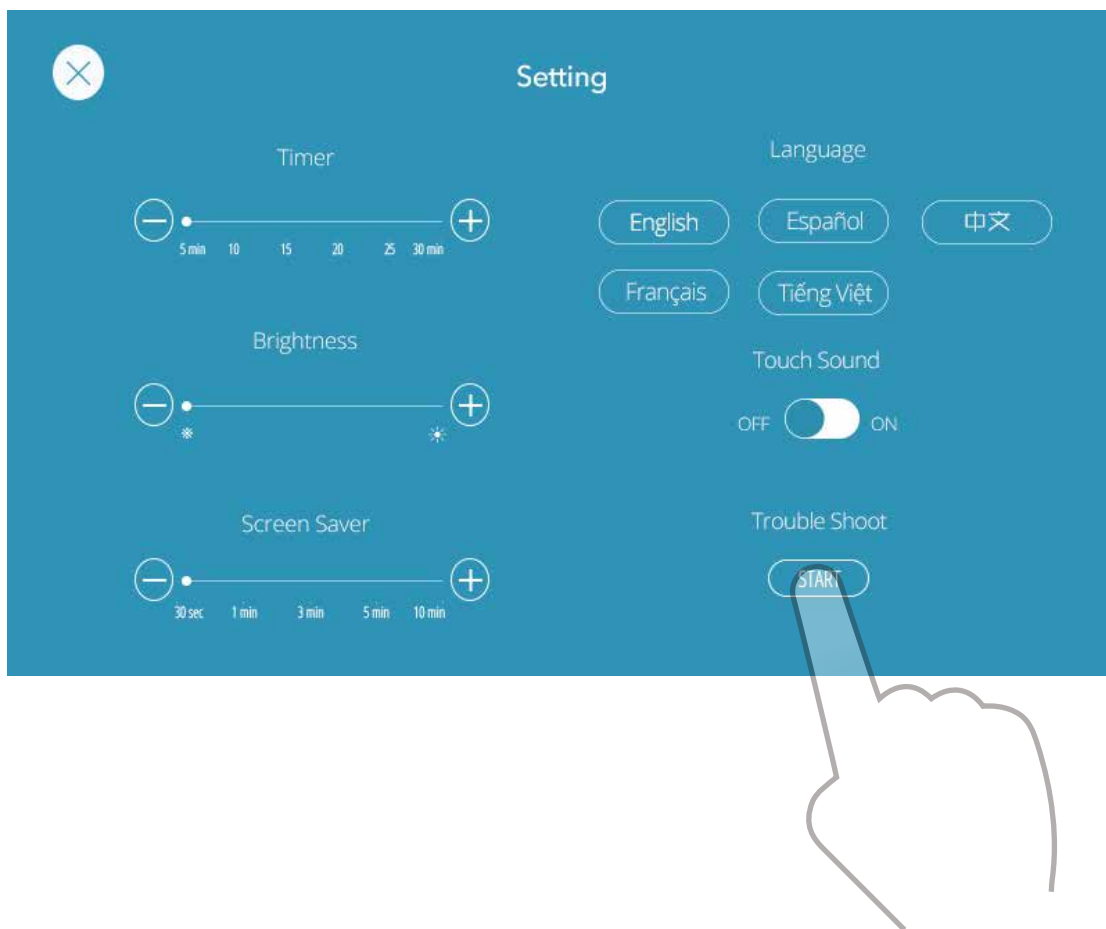

If your chair has any trouble, press the Trouble Shoot "Start" button for the chair to automatically detect problem areas. Use this information when you contact our customer service team

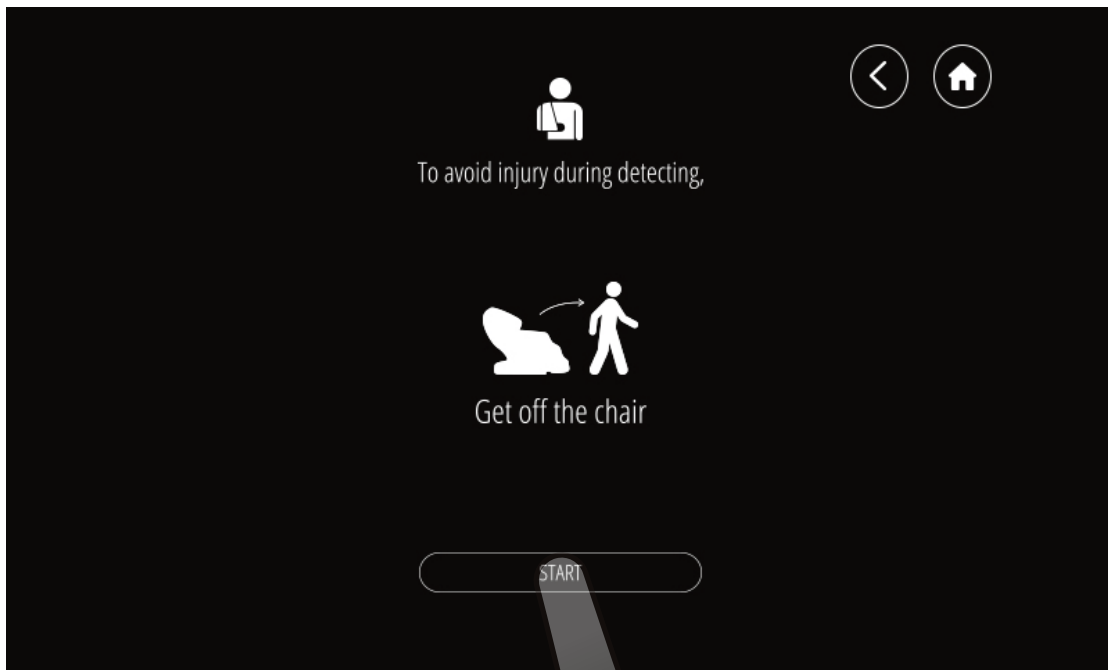

Choose "Start" button and make sure the chair is not occupied during chair detection

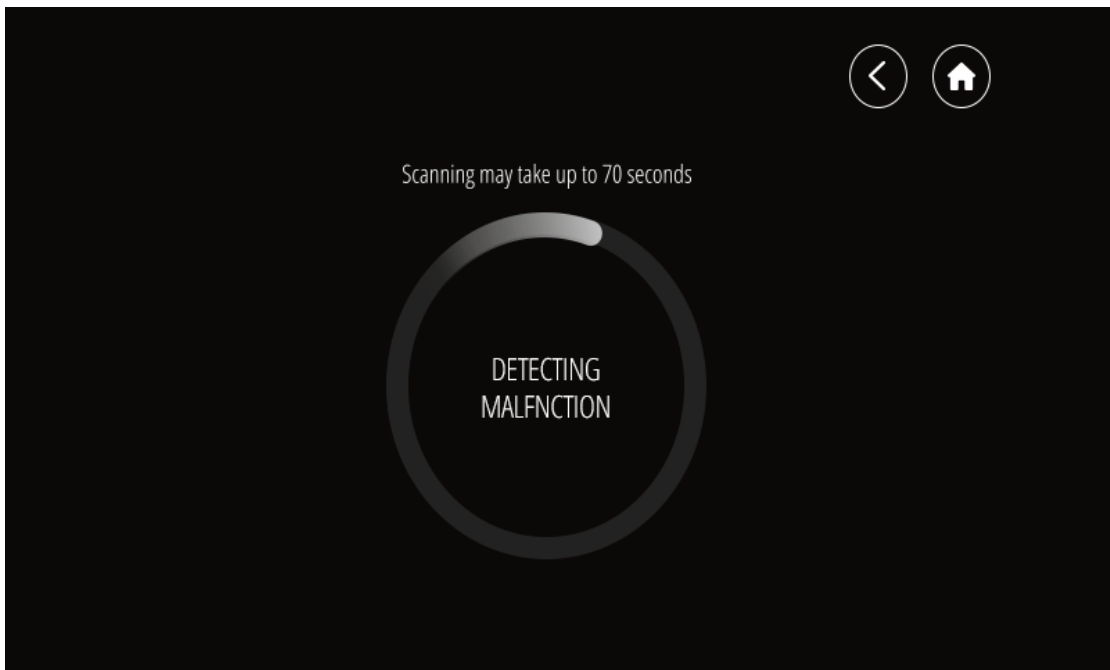

Your chair is detecting possible malfunctions, please wait for the detection result

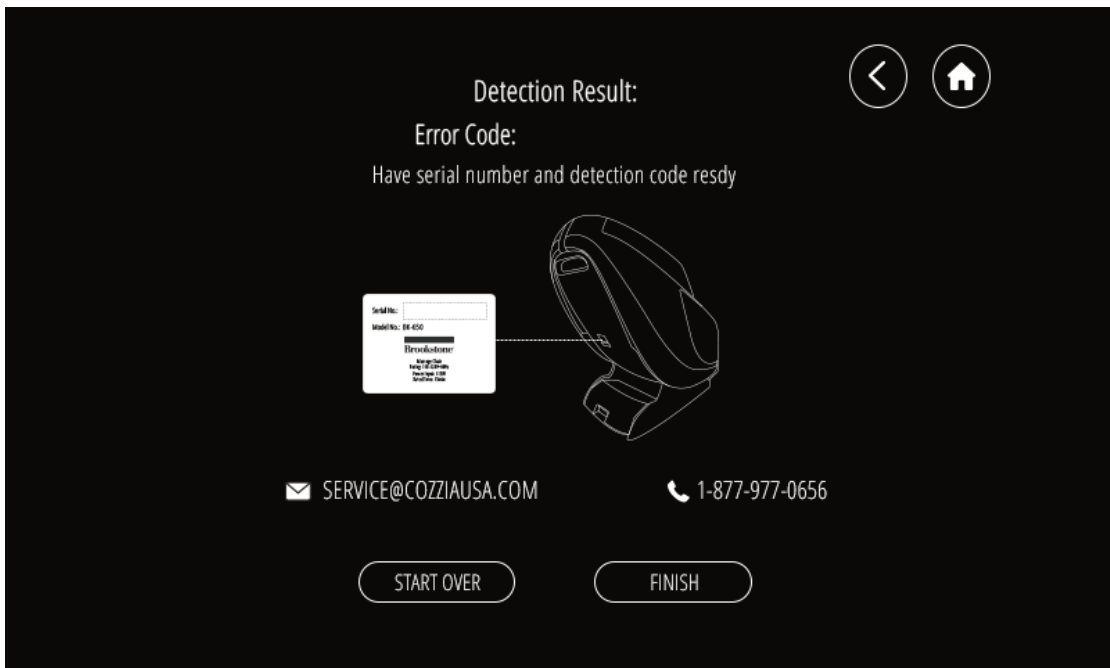

You can use your detection code when contacting the Cozzia customer team about your chair's problems

# VOICE CONTROL

This chair supports Google and Alexa speakers (please purchase speakers from Amazon or Google). Before using the voice control function, please go to Google Play or the Apple Store to download our app. You can search for "Cozzia Voice Commands" to find it.

## Model Selection Interface

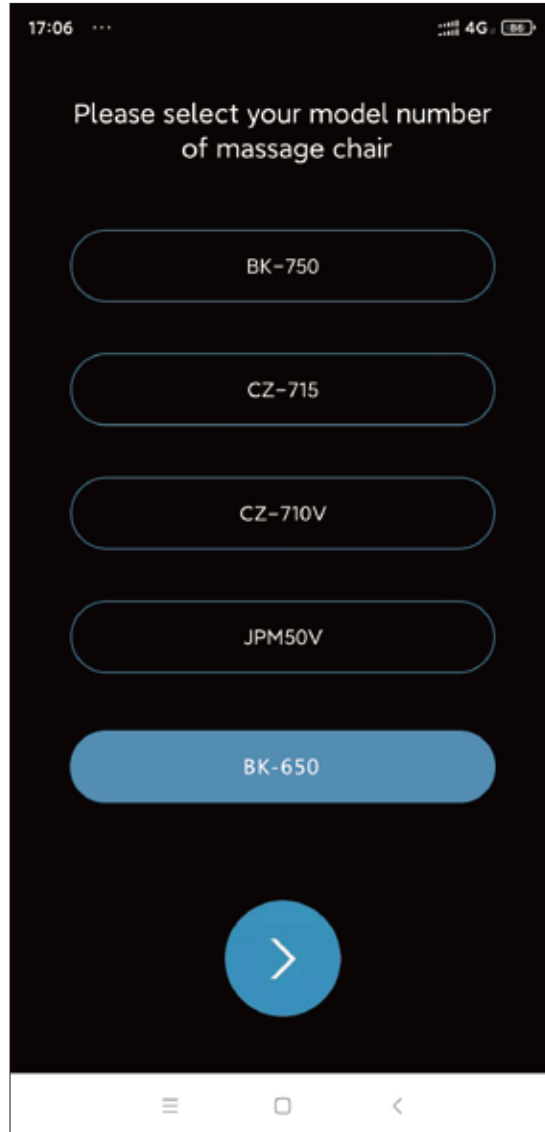

Select the model number of your massage chair  
Note: The model numbers on the page above are for reference only

## Sign In Interface

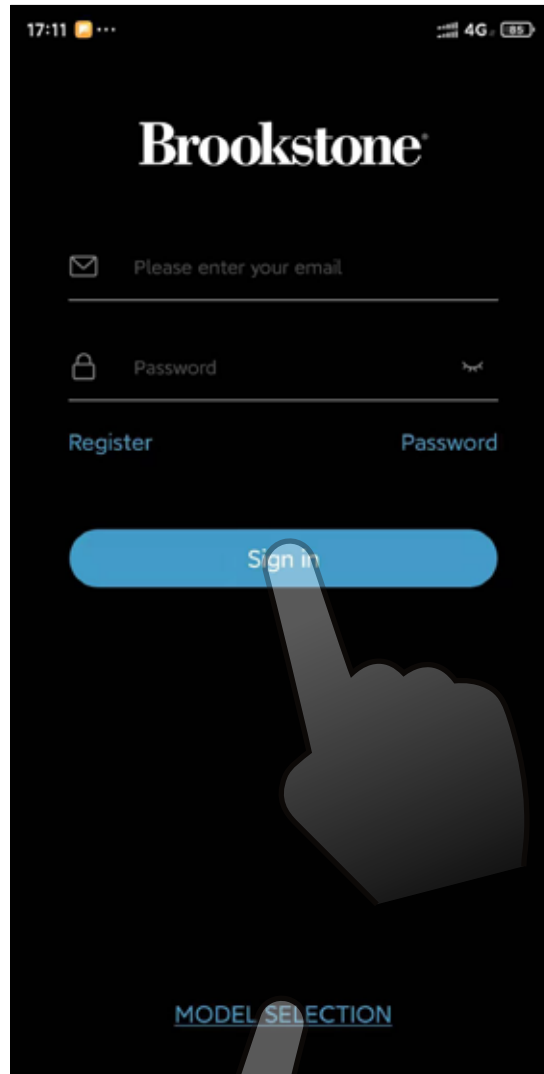

Here you can sign in to a registered account. If you do not have an account, please register first.  
Note: If you chose the wrong model number, click "MODEL SELECTION" to reselect

## Instruction Interface

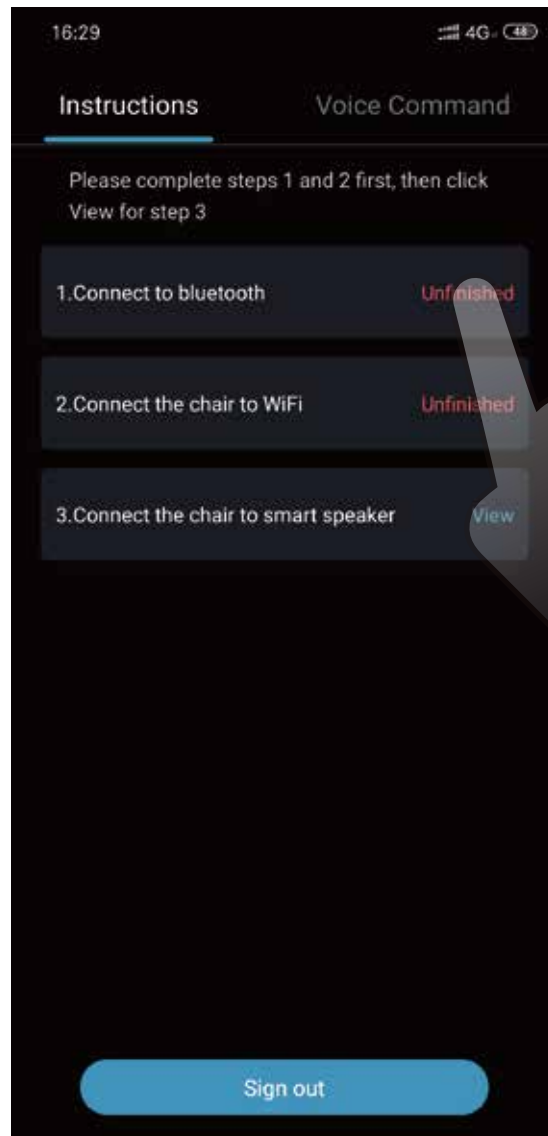

After logging in, please click “unfinished” to complete the first two steps



## Bluetooth Interface



Choose your chair's bluetooth code and then click "Confirm"

## Wireless Network Interface

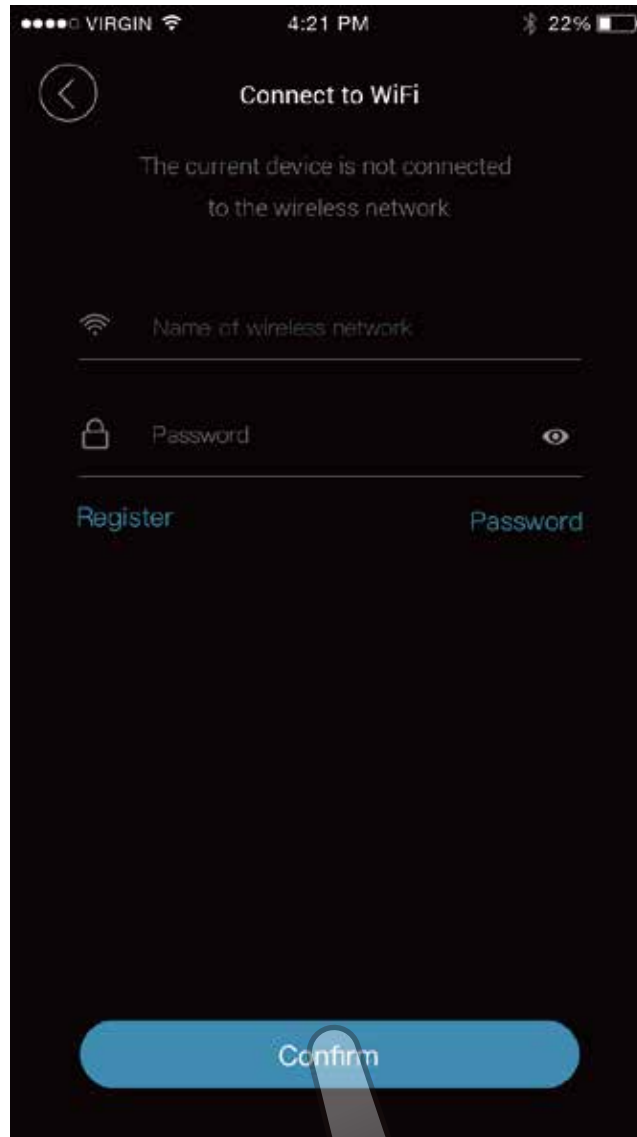

Enter your wireless network name and password to connect to network

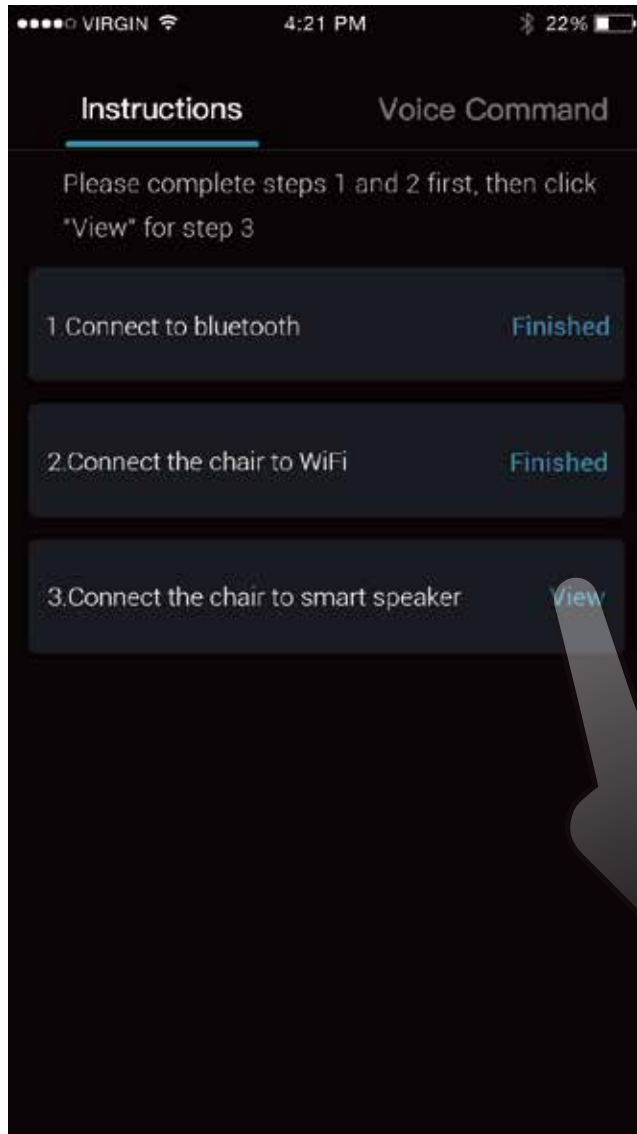

If part 1 and 2 have been completed, they will display "Finished".  
Click "View" in part 3 to complete your speaker settings

## View Interface

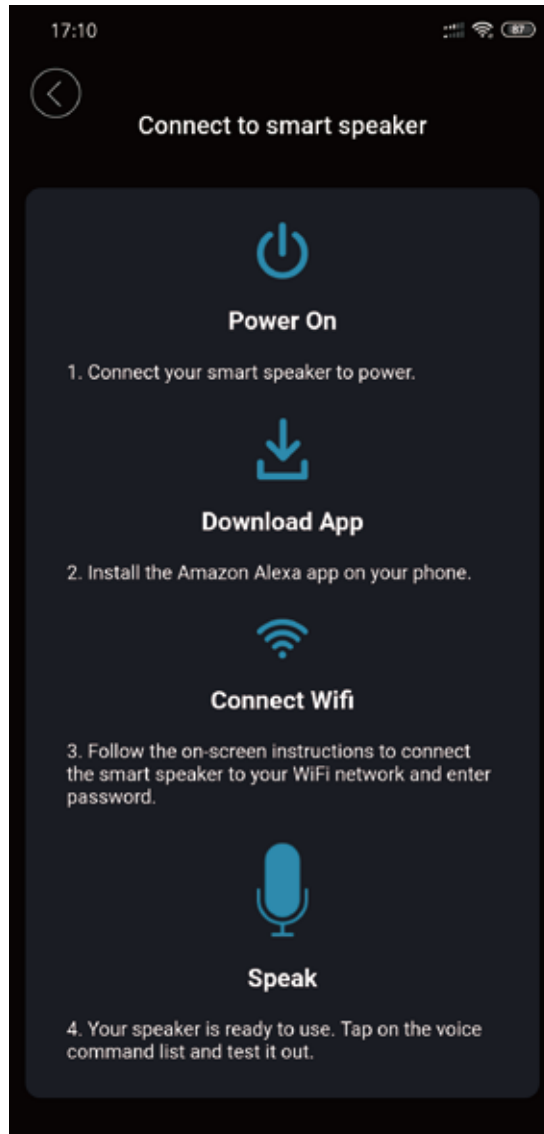

Please follow the instructions to connect your speaker to your chair

## Voice Command Interface

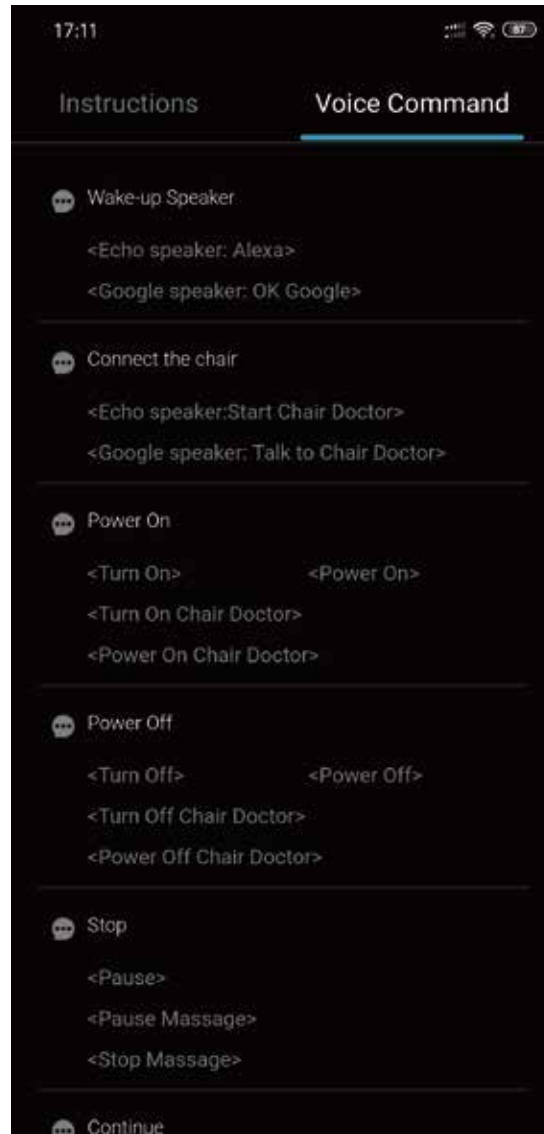

Voice commands may be periodically upgraded, the commands on the user manual are for reference only

# GROUNDING INSTRUCTIONS

This product must be grounded. If it should malfunction or break down, grounding provides a path of least resistance for the electric current to reduce the risk of electric shock. This product is equipped with a cord with an equipment-grounding conductor and a grounding plug. The plug must be plugged into an appropriate outlet that is properly installed and grounded in accordance with all local codes and ordinances.

Danger - Improper connection of the equipment grounding conductor can result in a risk of electric shock. If it will not fit your outlet, have a proper outlet installed by a qualified electrician.

This product is for use on a nominal 120V circuit and has grounding plug that looks like that plug illustrated below. Make sure that the product is connected to an outlet having the same configuration as the plug. No adapter should be used with this product.

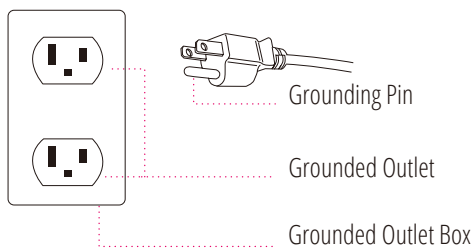

# TROUBLESHOOTING

This massage chair is controlled by a microcomputer and is thus susceptible to power surges of +10 to -15%. The following situations may arise in the event of a power surge:

Situation	Solution
The massage chair is connected to the power supply but is not functioning	<ol style="list-style-type: none"> <li>1. Check to see that the plug is properly connected and working</li> <li>2. Ensure the massage chair switch is in the 'I' position</li> </ol>
The remote control works but the massage chair is not functioning.	Possible overheating due to prolonged use. Turn off the power for at least 30 to 50 minutes
Both the remote control and the massage chair are not functioning	<ol style="list-style-type: none"> <li>1. Ensure the chair is plugged into a working outlet</li> <li>2. Turn the power OFF and ON again</li> </ol>

If you continue to have problems, please read the warranty card and contact the Cozzia service department.

# PRODUCT CARE AND STORAGE

## 1. Storing the Massage Chair

- Wipe off dust and dirt from the massage chair with a dry, soft, clean cloth after use.
- Keep the massage chair clean and away from places of high humidity.
- If the massage is not to be used for a long period of time, cover the massage chair with a dust cover and unplug its power plug from the electrical outlet.

### ⚠ Caution

- Do not store the massage chair in direct sunlight or in places of high temperature. This may cause the color of the upholstery to fade.
- Do not allow the massage chair to remain in contact with vinyl or wallpaper for extended periods of time as this could lead to discoloration.

## 2. Cleaning the Massage Chair

- Before cleaning, ensure that the main power switch is off and the power plug is disconnected from the electrical outlet.
- Wipe off dust and dirt from the massage with a dry, soft, clean cloth after each use.
- This product can be cleaned thoroughly with a slightly damp cloth.
- Do not iron the upholstery.
- Do not wash the upholstery using a home washing machine as this may result in deterioration of the upholstery's quality.

### ⚠ Caution

- Do not use abrasive cleaning agents like benzene or thinner to clean the massage chair. This may cause the upholstery to fade.

## 3. Cleaning the Controller

Use only a clean, dry cloth to clean the controller.

### ⚠ Caution

- Do not use a wet cloth to clean the controller. This may result in malfunction.

# Brookstone®

## TWO YEARS LIMITED WARRANTY

Cozzia USA, LLC sells Brookstone Massage Chair Model No. BK-650 (the "Brookstone Massage Chairs") with the intent that they are free of defects in manufacture and workmanship for a period of two years from the date of original purchase, except as noted below. Cozzia USA, LLC warrants that the Brookstone Massage Chairs will be free of defects in material and workmanship under normal use and service. This warranty extends only to consumers and does not extend to retailers.

Brookstone Massage Chairs have the following warranty:

The Brookstone Massage Chair BK-650 has a one-year labour and two-years parts warranty. Cozzia's customer service will not issue Return Material Authorizations (RMAs) for products. Brookstone Massage Chairs will be either repaired by the consumer or by an in-home technician. Cozzia will not issue Return Material Authorizations (RMAs) for buyer's remorse.

### Service And Technical Support

Consumers may contact Cozzia's customer service department at 1-877-977-0656 between 9:00 am and 5:00 pm PST, Monday through Friday or get help at [www.cozziausa.com/support](http://www.cozziausa.com/support).

Consumers are required to provide the unit serial number and dated proof of purchase (sales receipt) when they contact the Cozzia service department regarding a repair.

A Cozzia customer service representative will attend to most consumer inquiries, but in some cases a technical service specialist will provide advanced support.

Non-warranty repair is provided on a "per incident" basis. Cozzia customer service will verify that the unit has failed and provide instructions for repairing a unit. All applicable repairs, parts, shipping, handling, local tax and a "per incident" fee will be charged for non-warranty repairs and support calls.

Proof of purchase (original receipt) is required for all warranty repairs or service.

---

### FOR SUPPORT IN THE USA:

Get Help at [www.cozziausa.com/support](http://www.cozziausa.com/support)

Monday-Friday 9:00am-5:00pm PST

1.877.977.0656

# Brookstone®