

APPLICATION CERTIFICATION FCC Part 15C
On Behalf of
XIAMEN COMFORT SCIENCE & TECHNOLOGY GROUP CO., LTD

Massage Chair
Model No.: EC-7502A, ET-300

FCC ID: YMX-EC7502A

Prepared for : XIAMEN COMFORT SCIENCE & TECHNOLOGY GROUP CO.,
LTD
Address : (5/F) NO.168, QIANPU ROAD, SIMING DISTRICT, XIAMEN,
CHINA

Prepared by : Shenzhen Accurate Technology Co., Ltd.
Address : 1/F., Building A, Changyuan New Material Port, Science & Industry
Park, Nanshan District, Shenzhen, Guangdong, P.R. China

Tel: (0755) 26503290

Fax: (0755) 26503396

Report No. : ATE20191491
Date of Test : October 12-22, 2019
Date of Report : October 23, 2019

TABLE OF CONTENTS

Description	Page
Test Report Certification	
TABLE OF CONTENTS	2
1. GENERAL INFORMATION	5
1.1. Description of Device (EUT)	5
1.2. Accessory and Auxiliary Equipment	5
1.3. Description of Test Facility	6
1.4. Measurement Uncertainty	6
2. MEASURING DEVICE AND TEST EQUIPMENT	7
3. OPERATION OF EUT DURING TESTING	8
3.1. Operating Mode	8
3.2. Configuration and peripherals	8
4. TEST PROCEDURES AND RESULTS	9
5. 20DB BANDWIDTH TEST	10
5.1. Block Diagram of Test Setup	10
5.2. The Requirement For Section 15.247(a)(1)	10
5.3. EUT Configuration on Test	10
5.4. Operating Condition of EUT	10
5.5. Test Procedure	10
5.6. Test Result	11
6. CARRIER FREQUENCY SEPARATION TEST	16
6.1. Block Diagram of Test Setup	16
6.2. The Requirement For Section 15.247(a)(1)	16
6.3. EUT Configuration on Test	16
6.4. Operating Condition of EUT	16
6.5. Test Procedure	17
6.6. Test Result	17
7. NUMBER OF HOPPING FREQUENCY TEST	23
7.1. Block Diagram of Test Setup	23
7.2. The Requirement For Section 15.247(a)(1)(iii)	23
7.3. EUT Configuration on Test	23
7.4. Operating Condition of EUT	23
7.5. Test Procedure	23
7.6. Test Result	24
8. DWELL TIME TEST	26
8.1. Block Diagram of Test Setup	26
8.2. The Requirement For Section 15.247(a)(1)(iii)	26
8.3. EUT Configuration on Test	26
8.4. Operating Condition of EUT	26
8.5. Test Procedure	26
8.6. Test Result	27
9. MAXIMUM PEAK OUTPUT POWER TEST	33
9.1. Block Diagram of Test Setup	33

9.2.	The Requirement For Section 15.247(b)(1)	33
9.3.	EUT Configuration on Test	33
9.4.	Operating Condition of EUT	33
9.5.	Test Procedure	33
9.6.	Test Result	34
10.	RADIATED EMISSION TEST	40
10.1.	Block Diagram of Test Setup	40
10.2.	The Limit For Section 15.247(d)	41
10.3.	Restricted bands of operation	42
10.4.	EUT Configuration on Test	42
10.5.	Operating Condition of EUT	43
10.6.	Test Procedure	43
10.7.	Data Sample.....	44
10.8.	Test Results	44
11.	BAND EDGE COMPLIANCE TEST	57
11.1.	Block Diagram of Test Setup	57
11.2.	The Requirement For Section 15.247(d)	57
11.3.	EUT Configuration on Test	57
11.4.	Operating Condition of EUT	57
11.5.	Test Procedure	58
11.6.	Test Result	58
12.	AC POWER LINE CONDUCTED EMISSION TEST	69
12.1.	Block Diagram of Test Setup	69
12.2.	Power Line Conducted Emission Test Limits	70
12.3.	EUT Configuration on Test	70
12.4.	Operating Condition of EUT	70
12.5.	Test Procedure	70
12.6.	Data Sample.....	71
12.7.	Test Results	71
13.	ANTENNA REQUIREMENT	74
13.1.	The Requirement	74
13.2.	Antenna Construction.....	74

Test Report Certification

Applicant : XIAMEN COMFORT SCIENCE & TECHNOLOGY GROUP CO., LTD
Manufacturer : XIAMEN HEALTHCARE ELECTRONIC CO.,LTD.
Product : Massage Chair
Model No. : EC-7502A, ET-300

Measurement Procedure Used:

**FCC Rules and Regulations Part 15 Subpart C Section 15.247
ANSI C63.10: 2013**

The device described above is tested by Shenzhen Accurate Technology Co., Ltd. to determine the maximum emission levels emanating from the device. The maximum emission levels are compared to the FCC Part 15 Subpart C Section 15.247 limits. The measurement results are contained in this test report and Shenzhen Accurate Technology Co., Ltd. is assumed full responsibility for the accuracy and completeness of these measurements. Also, this report shows that the Equipment Under Test (EUT) is to be technically compliant with the FCC requirements.

This report applies to above tested sample only. This report shall not be reproduced in part without written approval of Shenzhen Accurate Technology Co., Ltd.

Date of Test : October 12-22, 2019
Date of Report : October 23, 2019

Prepared by : _____
(Bob Wang, Engineer)

Approved & Authorized Signer : _____
(Sean Liu, Manager)



1. GENERAL INFORMATION

1.1. Description of Device (EUT)

Model Number	:	EC-7502A, ET-300 (Note: We hereby state that these models are identical in interior structure, electrical circuits and components, just model name is different. Therefore only model EC-7502A is for tests.)
Bluetooth version	:	V4.0 classic mode for single mode
Frequency Range	:	2402MHz-2480MHz
Number of Channels	:	79
Antenna Gain(Max)	:	2.0dBi
Antenna type	:	PCB Antenna
Modulation mode	:	GFSK, $\pi/4$ DQPSK, 8DPSK
Trade Mark	:	N/A
Power supply	:	AC 110-120V~ 60Hz
Applicant	:	XIAMEN COMFORT SCIENCE & TECHNOLOGY GROUP CO., LTD
Address	:	(5/F) NO.168, QIANPU ROAD, SIMING DISTRICT, XIAMEN, CHINA
Manufacturer	:	XIAMEN HEALTHCARE ELECTRONIC CO.,LTD.
Address	:	65-66#, 62-63#Building, Siming Zone, Tongan Industrial District, Xiamen City, Fujian Province, P.R.China

1.2. Accessory and Auxiliary Equipment

N/A

1.3. Description of Test Facility

EMC Lab	:	Recognition of accreditation by Federal Communications Commission (FCC) The Designation Number is CN1189 The Registration Number is 708358 Listed by Innovation, Science and Economic Development Canada (ISED) The Registration Number is 5077A-2 Accredited by China National Accreditation Service for Conformity Assessment (CNAS) The Registration Number is CNAS L3193 Accredited by American Association for Laboratory Accreditation (A2LA) The Certificate Number is 4297.01
Name of Firm	:	Shenzhen Accurate Technology Co., Ltd.
Site Location	:	1/F., Building A, Changyuan New Material Port, Science & Industry Park, Nanshan District, Shenzhen, Guangdong, P.R. China

1.4. Measurement Uncertainty

Radiated Emission Expanded Uncertainty (9kHz-30MHz)	:	U=2.66dB, k=2
Radiated Emission Expanded Uncertainty (30MHz-1000MHz)	:	U=4.28dB, k=2
Radiated Emission Expanded Uncertainty (1G-18GHz)	:	U=4.98dB, k=2
Radiated Emission Expanded Uncertainty (18G-26.5GHz)	:	U=5.06dB, k=2
Conduction Emission Expanded Uncertainty (Mains ports, 9kHz-30MHz)	:	U=2.72dB, k=2

2. MEASURING DEVICE AND TEST EQUIPMENT

Table 1: List of Test and Measurement Equipment

Kind of equipment	Manufacturer	Type	S/N	Calibrated dates	Cal. Interval
EMI Test Receiver	Rohde&Schwarz	ESCS30	100307	Jan. 05, 2019	One Year
EMI Test Receiver	Rohde&Schwarz	ESR	101817	Jan. 05, 2019	One Year
Spectrum Analyzer	Rohde&Schwarz	FSV-40	101495	Jan. 05, 2019	One Year
Pre-Amplifier (Radiated Emission)	Compliance Direction	RSU-M2	38322	Jan. 05, 2019	One Year
Pre-Amplifier (Radiated Emission)	Agilent	8447D	294A10619	Jan. 05, 2019	One Year
Loop Antenna	Schwarzbeck	FMZB1516	1516131	Jan. 05, 2019	One Year
Bilog Antenna	Schwarzbeck	VULB9163	9163-323	Jan. 05, 2019	One Year
Horn Antenna	Schwarzbeck	BBHA9120D	9120D-655	Jan. 05, 2019	One Year
Horn Antenna	Schwarzbeck	BBHA9170	9170-359	Jan. 05, 2019	One Year
LISN	Schwarzbeck	NSLK8126	8126431	Jan. 05, 2019	One Year
Highpass Filter	Wainwright Instruments	WHKX3.6/18 G-10SS	N/A	Jan. 05, 2019	One Year
Band Reject Filter	Wainwright Instruments	WRCG2400/2 485-2375/2510 -60/11SS	N/A	Jan. 05, 2019	One Year
RF Coaxial Cable (Conducted Emission)	SUHNER	N-2m	No.2	Jan. 05, 2019	One Year
RF Coaxial Cable (Radiated Emission)	SUHNER	N-5m	NO.3	Jan. 05, 2019	One Year
RF Coaxial Cable (Radiated Emission)	SUHNER	N-5m	NO.4	Jan. 05, 2019	One Year
RF Coaxial Cable (Radiated Emission)	SUHNER	N-1m	NO.5	Jan. 05, 2019	One Year
RF Coaxial Cable (Radiated Emission)	SUHNER	N-1m	NO.6	Jan. 05, 2019	One Year
Conducted Emission Measurement Software: ES-K1 V1.71					
Radiated Emission Measurement Software: EZ_EMV V1.1.4.2					

3. OPERATION OF EUT DURING TESTING

3.1. Operating Mode

The mode is used: Transmitting mode
Low Channel: 2402MHz
Middle Channel: 2441MHz
High Channel: 2480MHz
Hopping

3.2. Configuration and peripherals

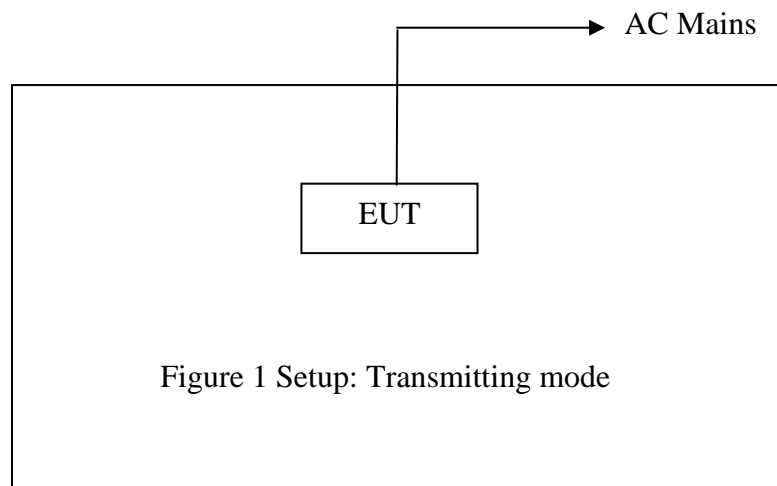

4. TEST PROCEDURES AND RESULTS

FCC Rules	Description of Test	Result
Section 15.247(a)(1)	20dB Bandwidth Test	Compliant
Section 15.247(a)(1)	Carrier Frequency Separation Test	Compliant
Section 15.247(a)(1)(iii)	Number Of Hopping Frequency Test	Compliant
Section 15.247(a)(1)(iii)	Dwell Time Test	Compliant
Section 15.247(b)(1)	Maximum Peak Output Power Test	Compliant
Section 15.247(d) Section 15.209	Radiated Emission Test	Compliant
Section 15.247(d)	Band Edge Compliance Test	Compliant
Section 15.207	AC Power Line Conducted Emissions Limits Test	Compliant
Section 15.203	Antenna Requirement	Compliant

5. 20DB BANDWIDTH TEST

5.1. Block Diagram of Test Setup



5.2. The Requirement For Section 15.247(a)(1)

Frequency hopping systems shall have hopping channel carrier frequencies separated by a minimum of 25 kHz or the 20 dB bandwidth of the hopping channel, whichever is greater.

5.3. EUT Configuration on Test

The equipment are installed on the emission measurement to meet the commission requirements and operating regulations in a manner which tends to maximize its emission characteristics in normal application.

5.4. Operating Condition of EUT

5.4.1. Setup the EUT and simulator as shown as Section 5.1.

5.4.2. Turn on the power of all equipment.

5.4.3. Let the EUT work in TX (Hopping off) modes measure it. The transmit frequency are 2402-2480MHz. We select 2402MHz, 2441MHz, and 2480MHz TX frequency to transmit.

5.5. Test Procedure

5.5.1. The transmitter output was connected to the spectrum analyzer through a low loss cable.

5.5.2. The nominal IF filter bandwidth (3 dB RBW) shall be in the range of 1% to 5% of the OBW, and VBW shall be approximately three times the RBW.

5.5.3. The 20dB bandwidth is defined as the total spectrum the power of which is higher than peak power minus 20dB.

5.6. Test Result

Channel	Frequency (MHz)	GFSK 20dB Bandwidth (MHz)	Π/4-DQPSK 20dB Bandwidth (MHz)	8DPSK 20dB Bandwidth (MHz)	Result
Low	2402	0.978	1.356	1.356	Pass
Middle	2441	0.984	1.356	1.356	Pass
High	2480	0.978	1.356	1.356	Pass

The spectrum analyzer plots are attached as below.

GFSK Mode

Low channel

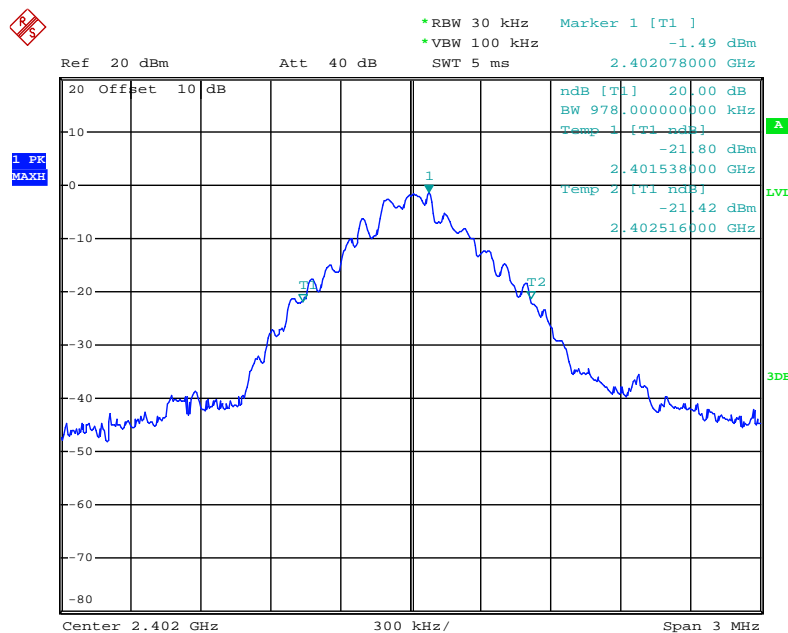

Middle channel

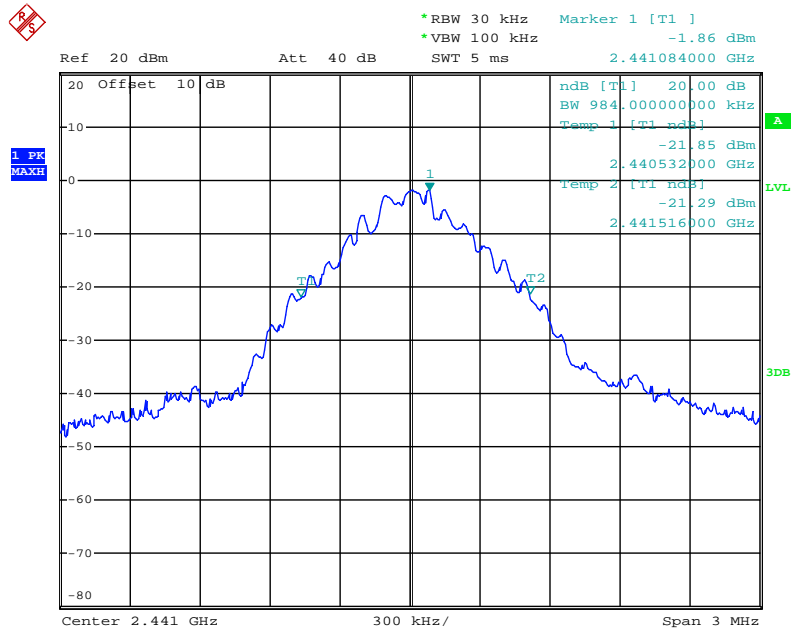

High channel

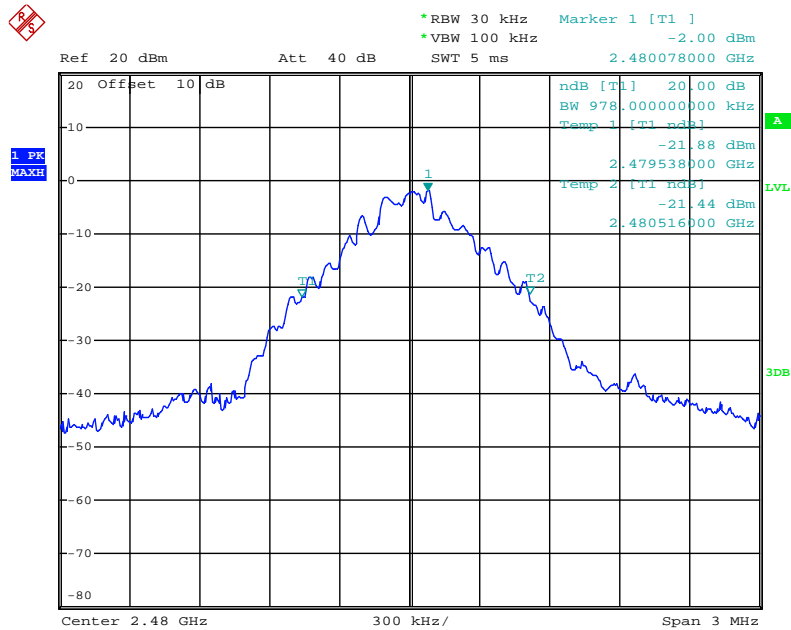

Π/4-DQPSK Mode

Low channel

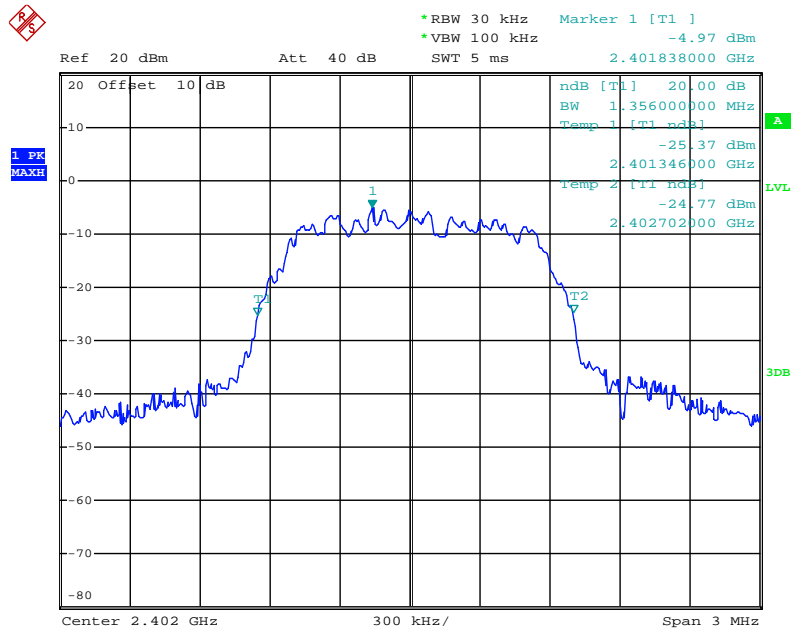

Middle channel

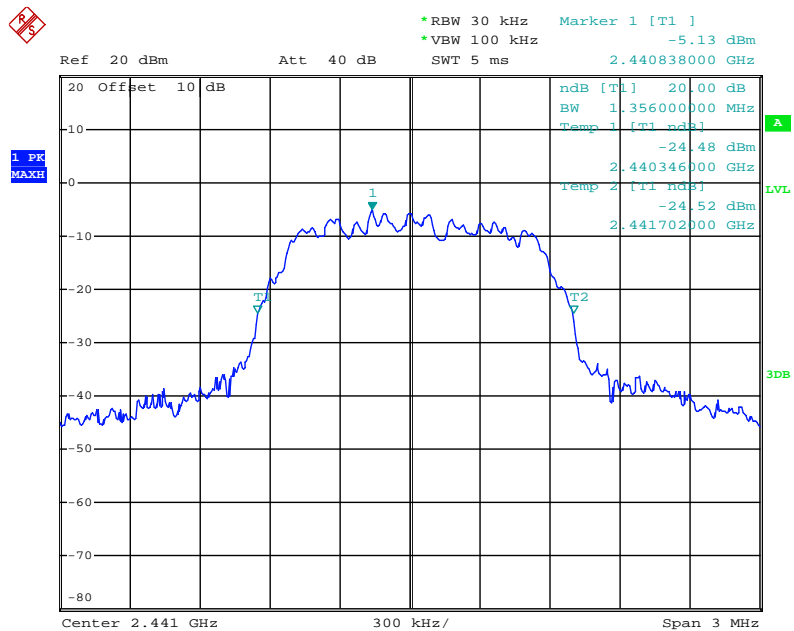

High channel

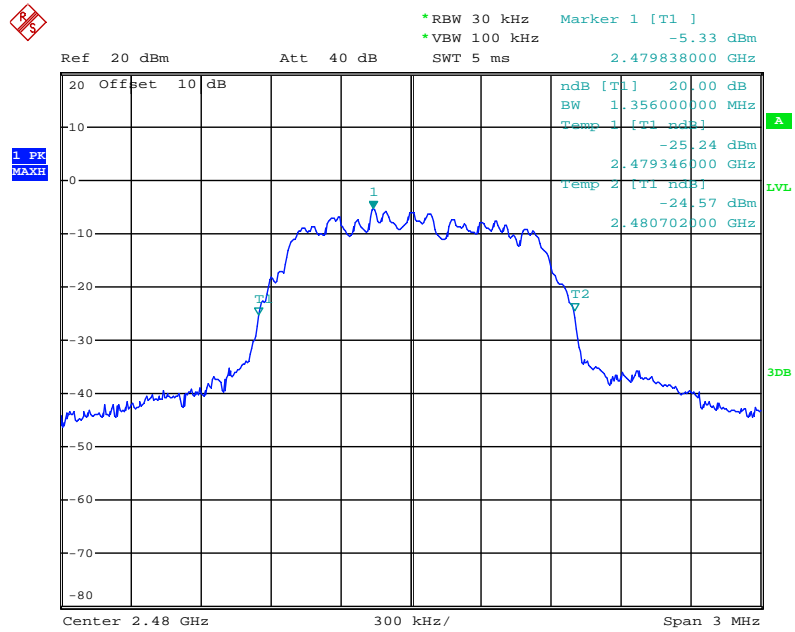

8DPSK Mode

Low channel

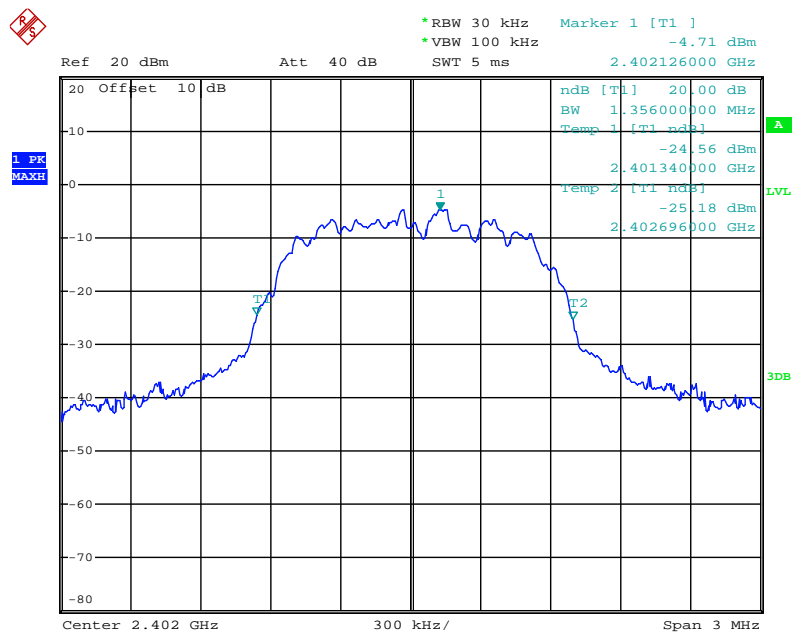

Middle channel

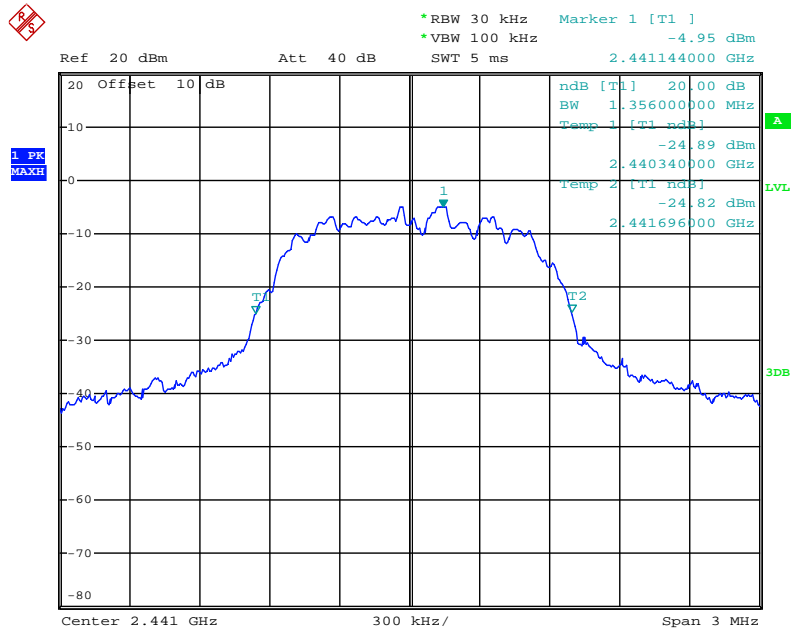

High channel

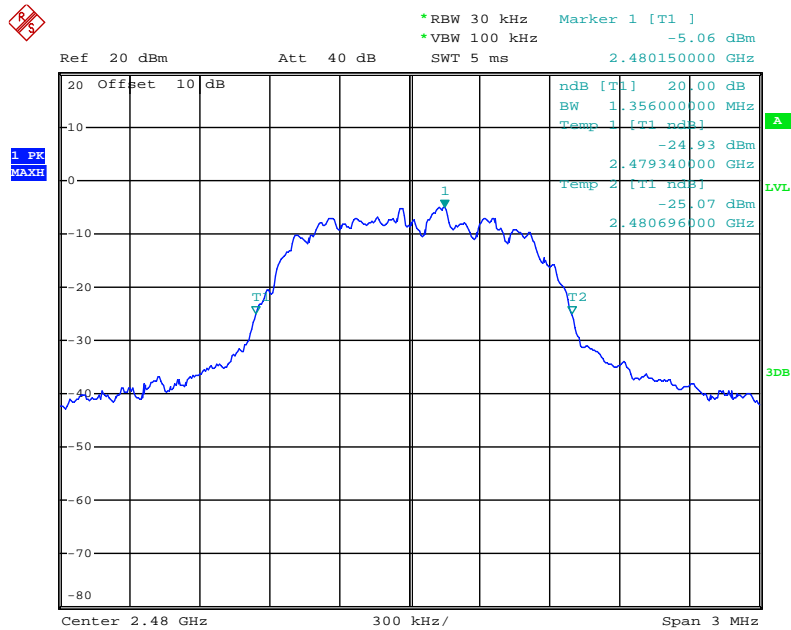

6. CARRIER FREQUENCY SEPARATION TEST

6.1. Block Diagram of Test Setup

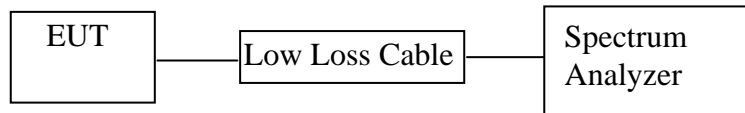

6.2. The Requirement For Section 15.247(a)(1)

Frequency hopping systems shall have hopping channel carrier frequencies separated by a minimum of 25 kHz or the 20 dB bandwidth of the hopping channel, whichever is greater. Alternatively, frequency hopping systems operating in the 2400-2483.5 MHz band may have hopping channel carrier frequencies that are separated by 25 kHz or two-thirds of the 20 dB bandwidth of the hopping channel, whichever is greater, provided the systems operate with an output power no greater than 125 mW. The system shall hop to channel frequencies that are selected at the system hopping rate from a pseudo randomly ordered list of hopping frequencies. Each frequency must be used equally on the average by each transmitter. The system receivers shall have input bandwidths that match the hopping channel bandwidths of their corresponding transmitters and shall shift frequencies in synchronization with the transmitted signals.

6.3. EUT Configuration on Test

The equipment are installed on the emission measurement to meet the commission requirements and operating regulations in a manner which tends to maximize its emission characteristics in normal application.

6.4. Operating Condition of EUT

6.4.1. Setup the EUT and simulator as shown as Section 6.1.

6.4.2. Turn on the power of all equipment.

6.4.3. Let the EUT work in TX (Hopping on) modes measure it. The transmit frequency are 2402-2480MHz. We select 2402MHz, 2441MHz, and 2480MHz TX frequency to transmit.

6.5. Test Procedure

6.5.1. The transmitter output was connected to the spectrum analyzer through a low loss cable.

6.5.2. Set RBW of spectrum analyzer to 30 kHz and VBW to 100 kHz. Adjust Span to 3MHz.

6.5.3. Set the adjacent channel of the EUT Maxhold another trace.

6.5.4. Measurement the channel separation

6.6. Test Result

GFSK

Channel	Frequency (MHz)	Channel Separation(MHz)	Limit (MHz)	Result
Low	2402	1.002	25KHz or 2/3*20dB bandwidth	Pass
	2403			
Middle	2440	1.002	25KHz or 2/3*20dB bandwidth	Pass
	2441			
High	2479	1.002	25KHz or 2/3*20dB bandwidth	Pass
	2480			

Π/4-DQPSK

Channel	Frequency (MHz)	Channel Separation(MHz)	Limit (MHz)	Result
Low	2402	1.002	25KHz or 2/3*20dB bandwidth	Pass
	2403			
Middle	2440	1.008	25KHz or 2/3*20dB bandwidth	Pass
	2441			
High	2479	1.008	25KHz or 2/3*20dB bandwidth	Pass
	2480			

8DPSK

Channel	Frequency (MHz)	Channel Separation(MHz)	Limit (MHz)	Result
Low	2402	0.996	25KHz or 2/3*20dB bandwidth	Pass
	2403			
Middle	2440	1.002	25KHz or 2/3*20dB bandwidth	Pass
	2441			
High	2479	1.002	25KHz or 2/3*20dB bandwidth	Pass
	2480			

GFSK Mode

Low channel

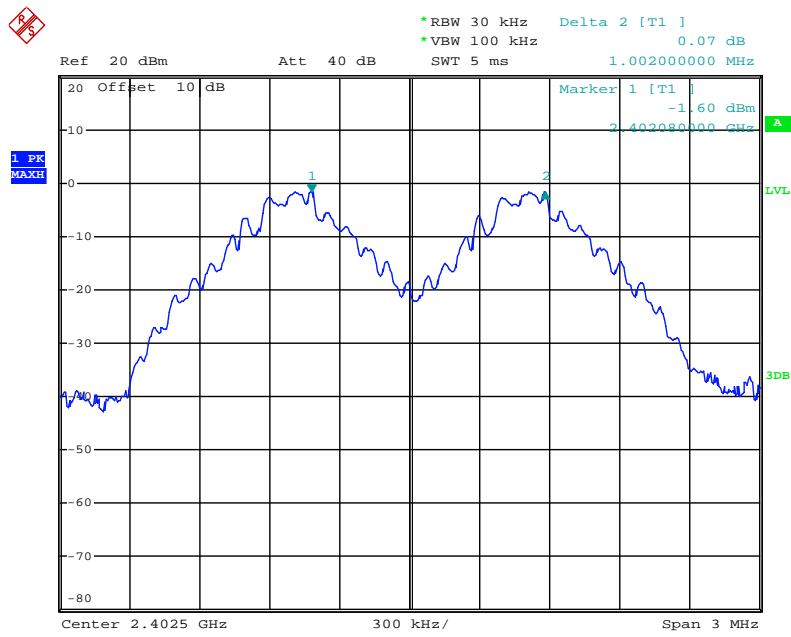

Middle channel

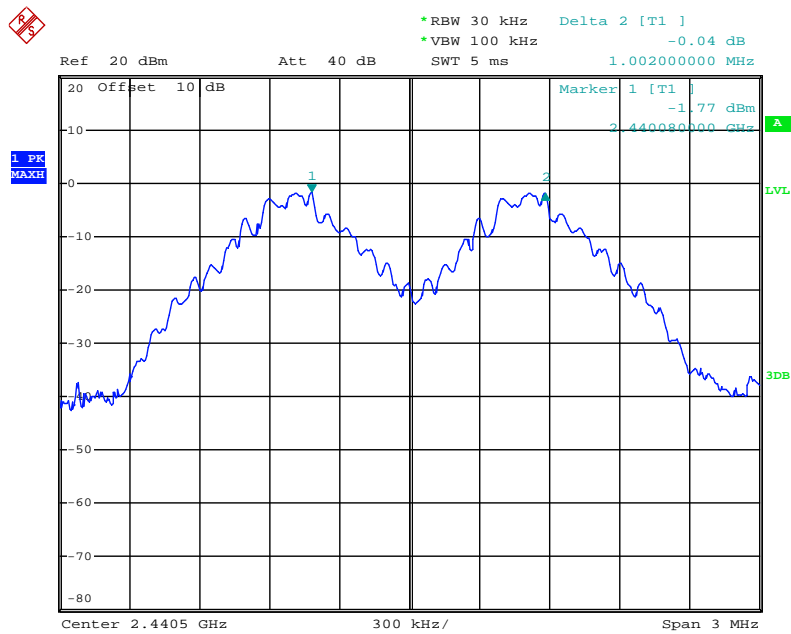

High channel

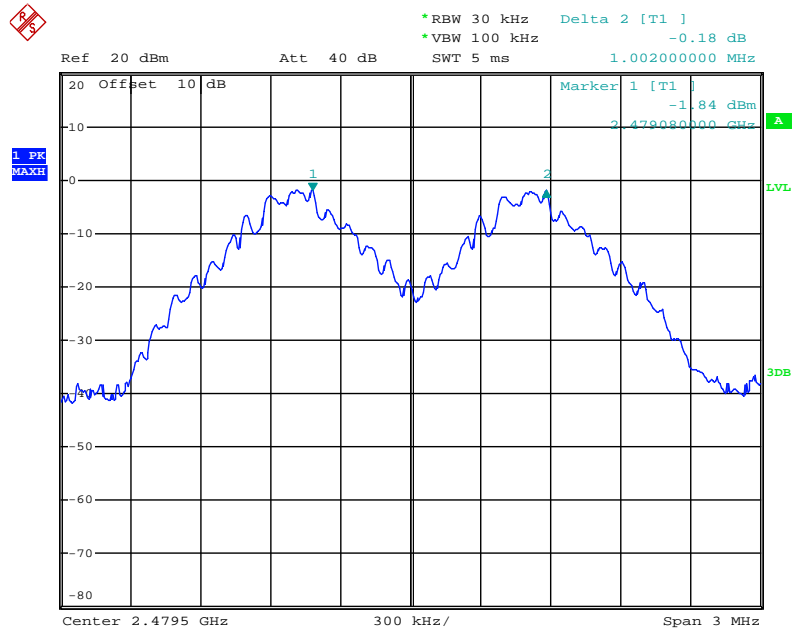

Π/4-DQPSK Mode

Low channel

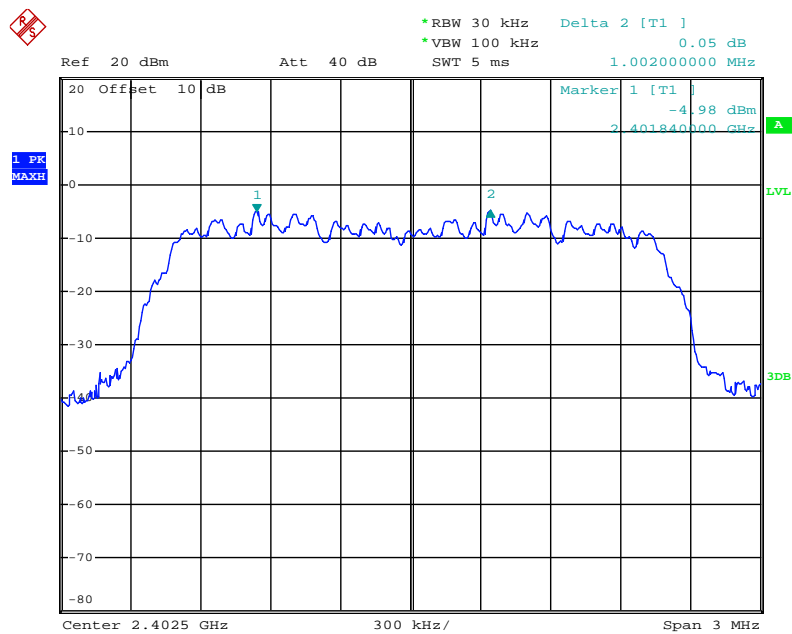

Middle channel

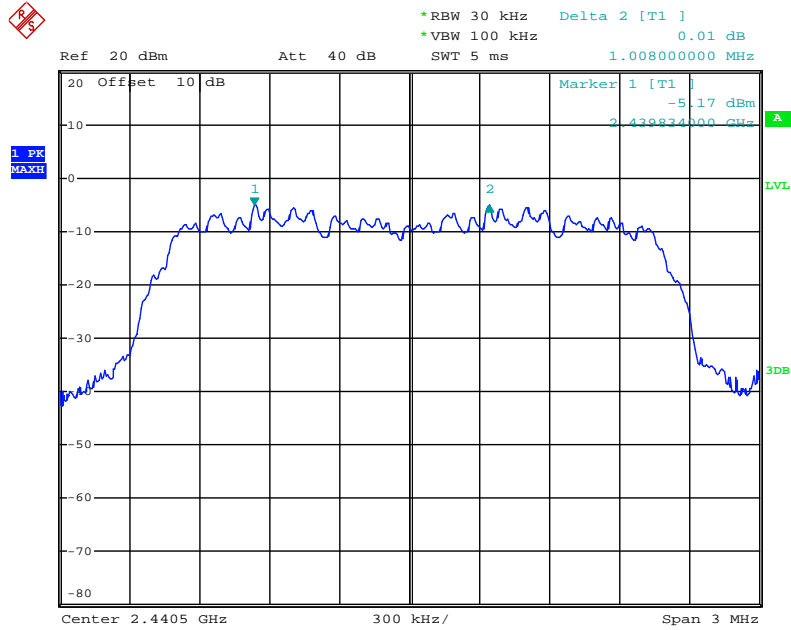

High channel

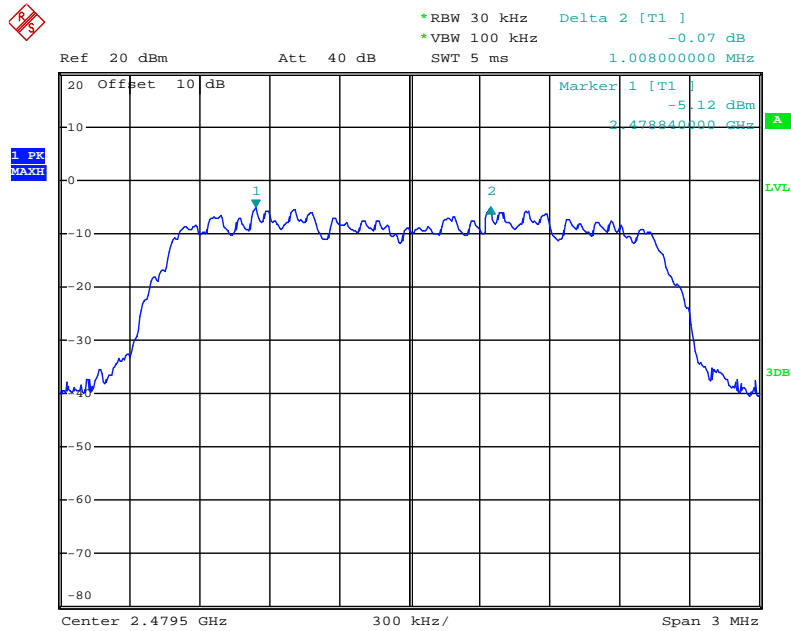

8DPSK Mode

Low channel

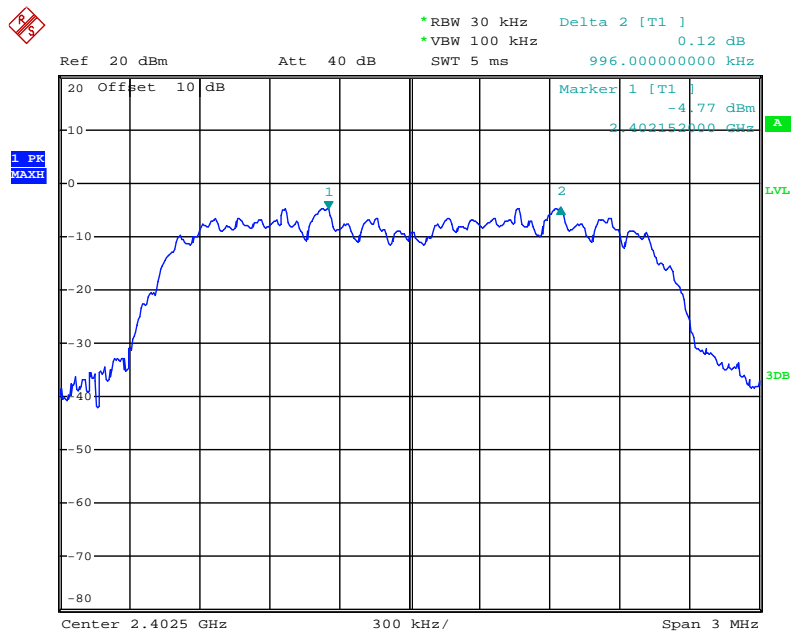

Middle channel

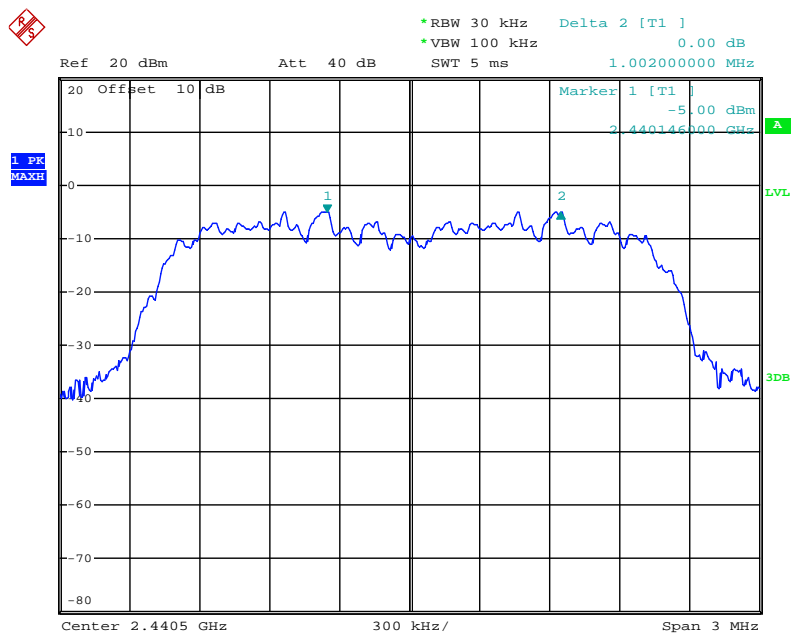

High channel

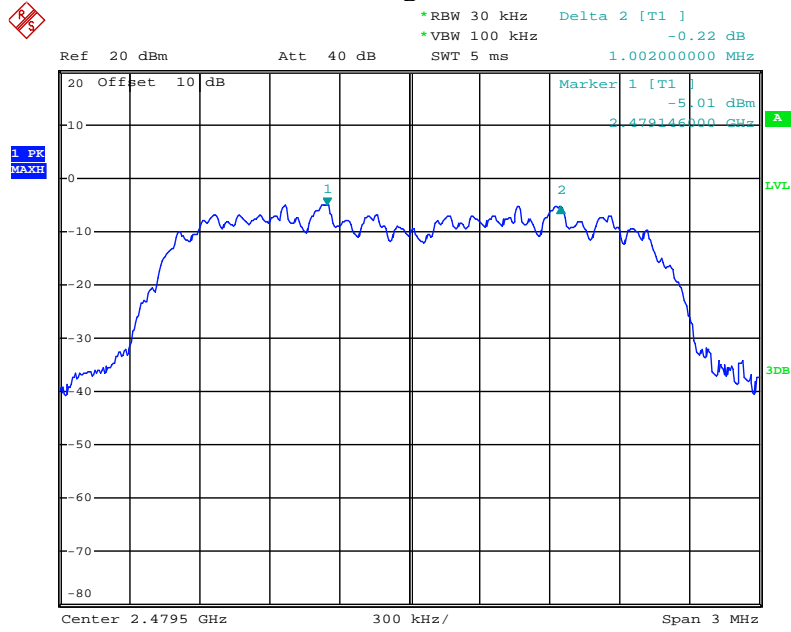

7. NUMBER OF HOPPING FREQUENCY TEST

7.1. Block Diagram of Test Setup

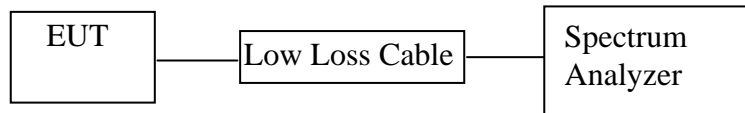

7.2. The Requirement For Section 15.247(a)(1)(iii)

Frequency hopping systems in the 2400-2483.5 MHz band shall use at least 15 channels.

7.3. EUT Configuration on Test

The equipment are installed on the emission measurement to meet the commission requirements and operating regulations in a manner which tends to maximize its emission characteristics in normal application.

7.4. Operating Condition of EUT

7.4.1. Setup the EUT and simulator as shown as Section 7.1.

7.4.2. Turn on the power of all equipment.

7.4.3. Let the EUT work in TX (Hopping on) modes measure it.

7.5. Test Procedure

7.5.1. The transmitter output was connected to the spectrum analyzer through a low loss cable.

7.5.2. Set the spectrum analyzer as RBW=100 kHz, VBW=300 kHz.

7.5.3. Max hold, view and count how many channel in the band.

7.6. Test Result

Total number of hopping channel	Measurement result(CH)	Limit(CH)	Result
	79	≥ 15	Pass

The spectrum analyzer plots are attached as below.

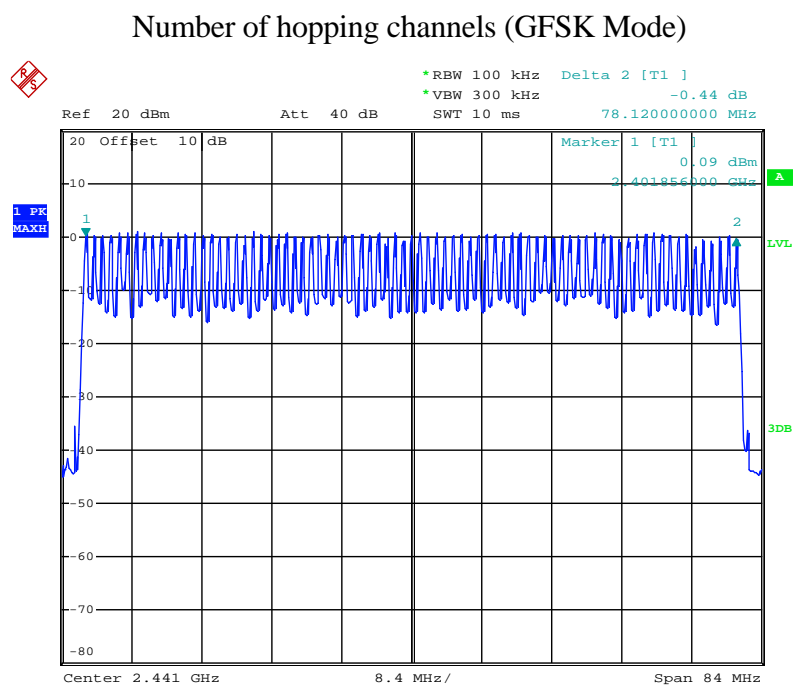

Number of hopping channels ($\Pi/4$ -DQPSK Mode)

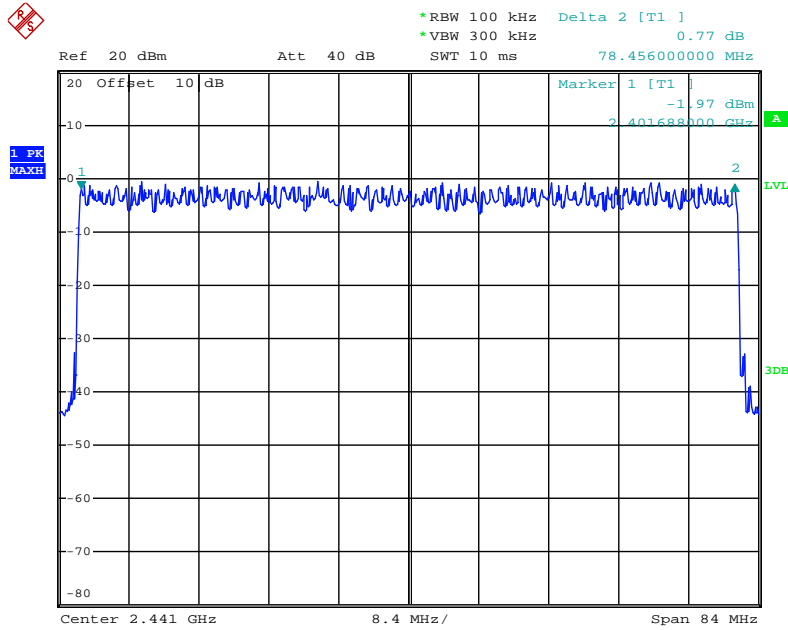

Number of hopping channels (8DPSK Mode)

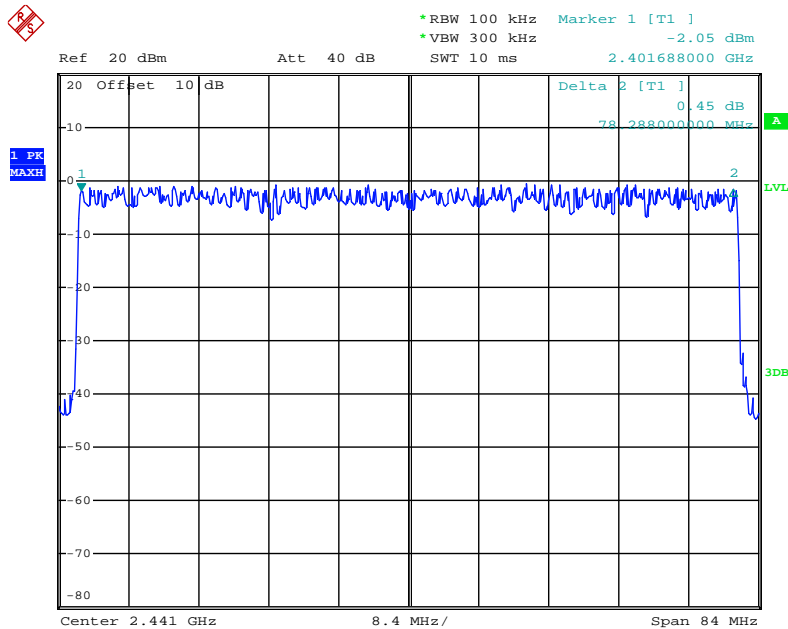

8. DWELL TIME TEST

8.1. Block Diagram of Test Setup



8.2. The Requirement For Section 15.247(a)(1)(iii)

Frequency hopping systems in the 2400-2483.5 MHz band shall use at least 15 channels. The average time of occupancy on any channel shall not be greater than 0.4 seconds within a period of 0.4 seconds multiplied by the number of hopping channels employed. Frequency hopping systems may avoid or suppress transmissions on a particular hopping frequency provided that a minimum of 15 channels are used.

8.3. EUT Configuration on Test

The equipment are installed on the emission measurement to meet the commission requirements and operating regulations in a manner which tends to maximize its emission characteristics in normal application.

8.4. Operating Condition of EUT

8.4.1. Setup the EUT and simulator as shown as Section 8.1.

8.4.2. Turn on the power of all equipment.

8.4.3. Let the EUT work in TX (Hopping on) modes measure it. The transmit frequency are 2402-2480MHz. We select 2402MHz, 2441MHz, and 2480MHz TX frequency to transmit.

8.5. Test Procedure

8.5.1. The transmitter output was connected to the spectrum analyzer through a low loss cable.

8.5.2. Set center frequency of spectrum analyzer = operating frequency.

8.5.3. Set the spectrum analyzer as RBW=1MHz, VBW=3MHz, Span=0Hz, Adjust Sweep=5ms, 10ms, 15ms. Get the pulse time.

8.5.4. Repeat above procedures until all frequency measured were complete.

8.6. Test Result

Pass.

GFSK Mode (Worse case)

Mode	Channel Frequency (MHz)	Pulse Time (ms)	Dwell Time (ms)	Limit (ms)
DH1	2441	0.40	128.0	400
A period transmit time = $0.4 \times 79 = 31.6$ Dwell time = pulse time $\times (1600/(2*79)) \times 31.6$				
DH3	2441	1.70	272.0	400
A period transmit time = $0.4 \times 79 = 31.6$ Dwell time = pulse time $\times (1600/(4*79)) \times 31.6$				
DH5	2441	2.99	319.0	400
A period transmit time = $0.4 \times 79 = 31.6$ Dwell time = pulse time $\times (1600/(6*79)) \times 31.6$				

$\Pi/4$ -DQPSK (Worse case)

Mode	Channel Frequency (MHz)	Pulse Time (ms)	Dwell Time (ms)	Limit (ms)
DH1	2441	0.42	134.4	400
A period transmit time = $0.4 \times 79 = 31.6$ Dwell time = pulse time $\times (1600/(2*79)) \times 31.6$				
DH3	2441	1.72	275.2	400
A period transmit time = $0.4 \times 79 = 31.6$ Dwell time = pulse time $\times (1600/(4*79)) \times 31.6$				
DH5	2441	3.01	321.1	400
A period transmit time = $0.4 \times 79 = 31.6$ Dwell time = pulse time $\times (1600/(6*79)) \times 31.6$				

8DPSK Mode (Worse case)

Mode	Channel Frequency (MHz)	Pulse Time (ms)	Dwell Time (ms)	Limit (ms)
DH1	2441	0.42	134.4	400
A period transmit time = $0.4 \times 79 = 31.6$ Dwell time = pulse time $\times (1600/(2*79)) \times 31.6$				
DH3	2441	1.70	272.0	400
A period transmit time = $0.4 \times 79 = 31.6$ Dwell time = pulse time $\times (1600/(4*79)) \times 31.6$				
DH5	2441	2.99	319.0	400
A period transmit time = $0.4 \times 79 = 31.6$ Dwell time = pulse time $\times (1600/(6*79)) \times 31.6$				

Note: We tested GFSK mode and $\Pi/4$ -DQPSK & 8DPSK mode the low, middle and high channel and recorded the Worse case data for all test mode.

The spectrum analyzer plots are attached as below.

GFSK Mode

DH1 Middle channel

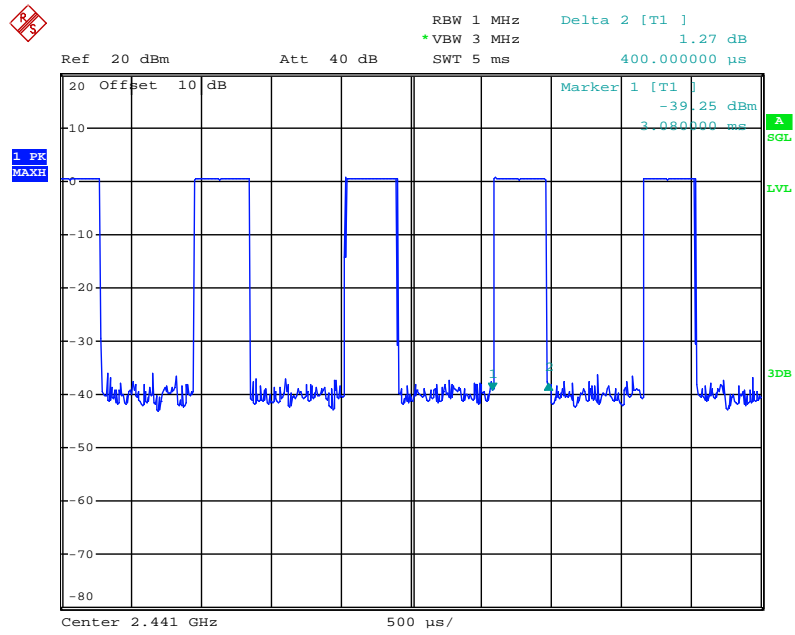

DH3 Middle channel

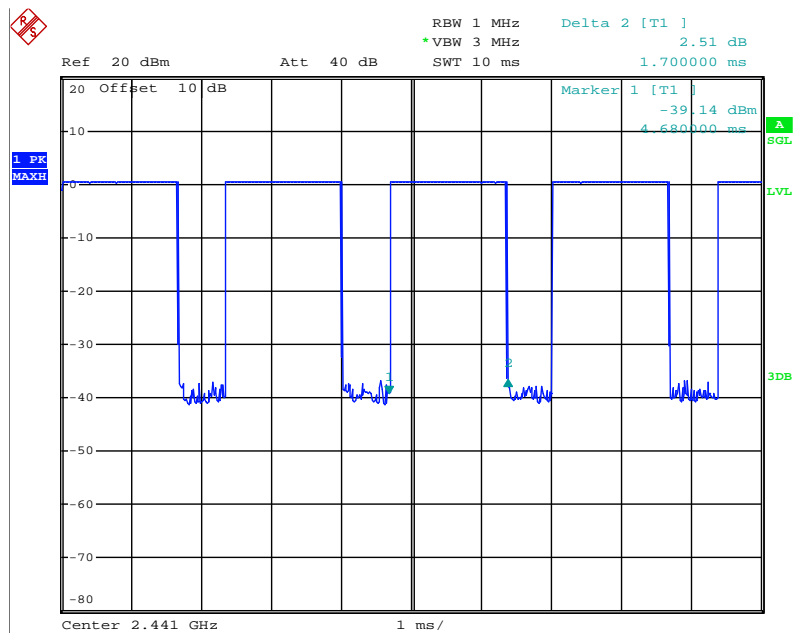

DH5 Middle channel

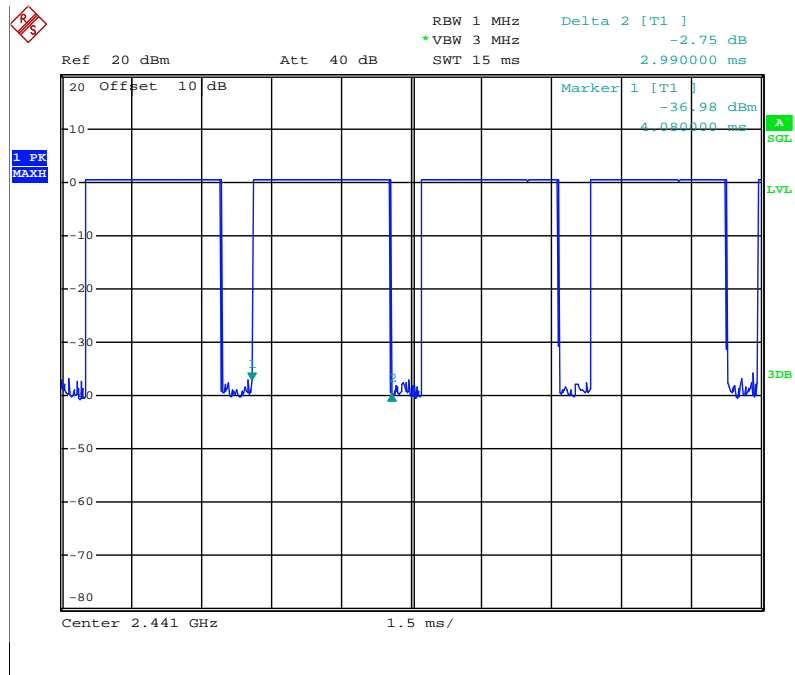

Π/4-DQPSK Mode

2DH1 Middle channel

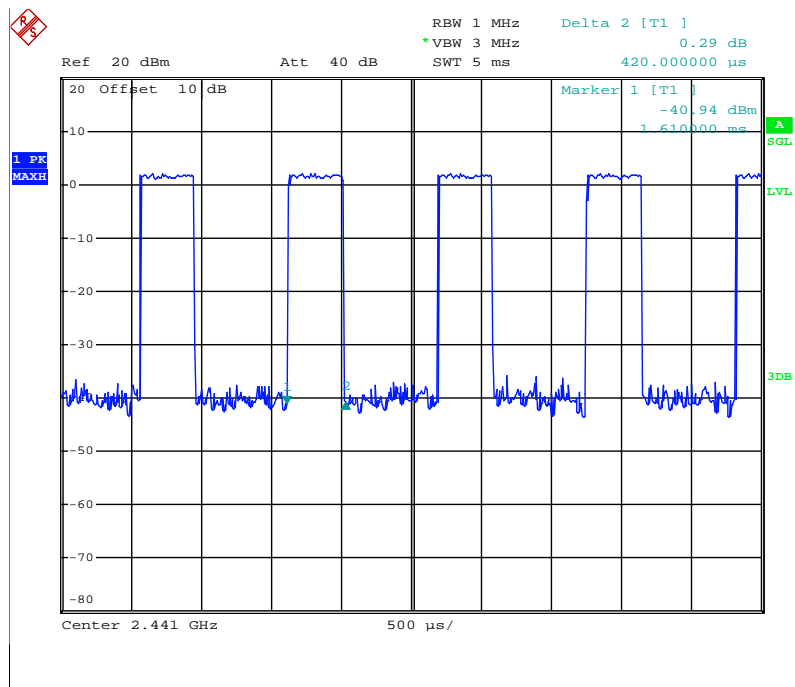

2DH3 Middle channel

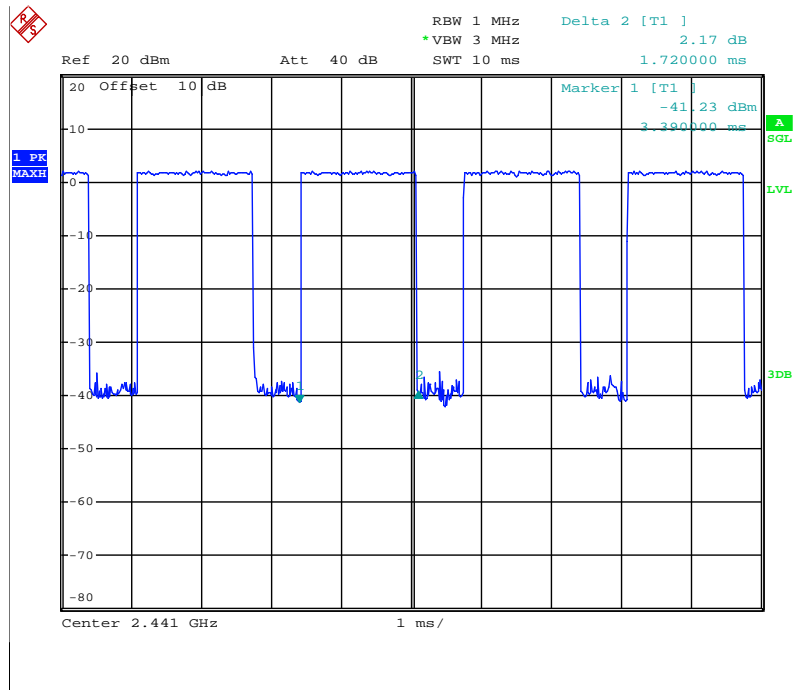

2DH5 Middle channel

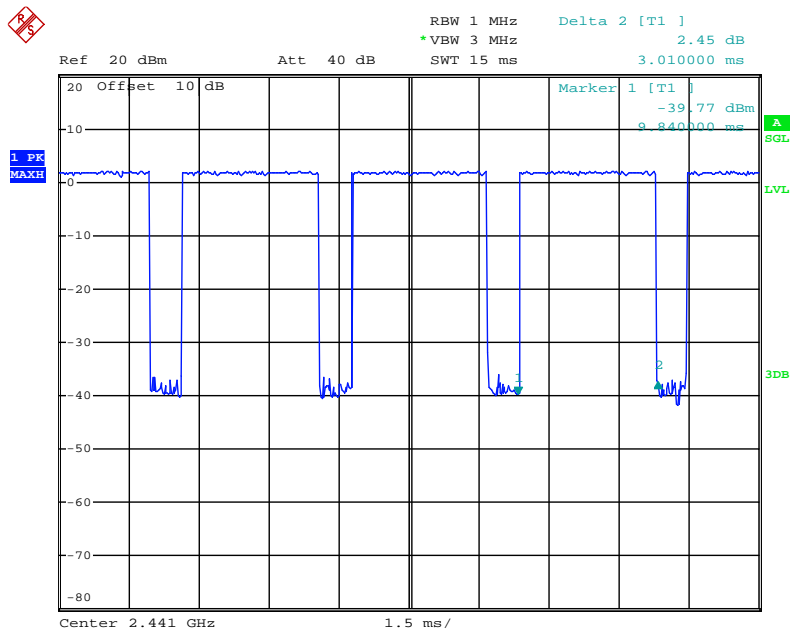

8DPSK Mode

3DH1 Middle channel

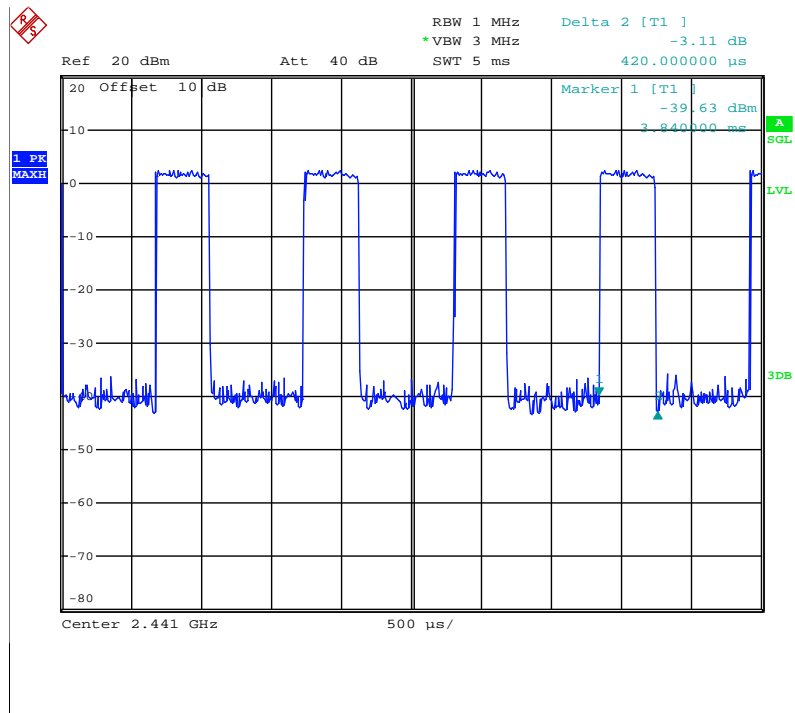

3DH3 Middle channel

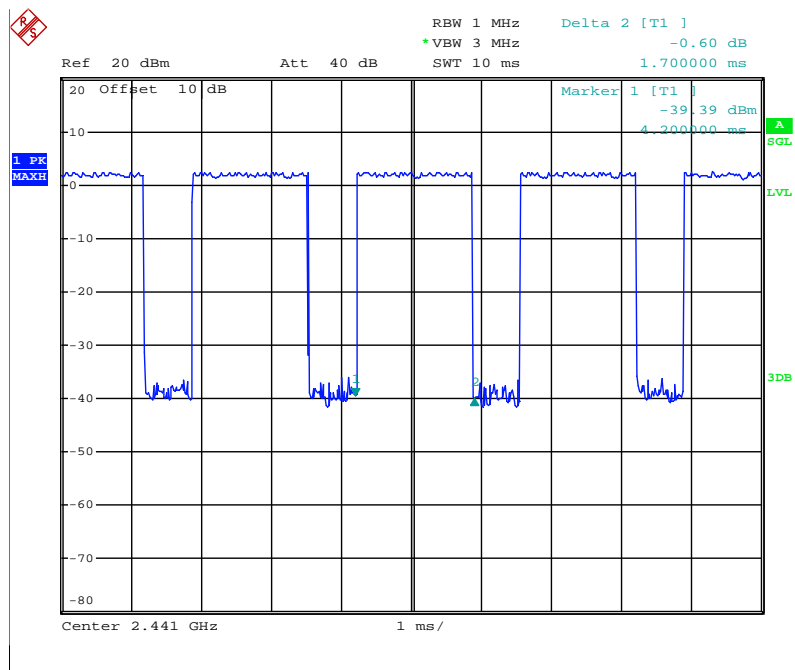

3DH5 Middle channel

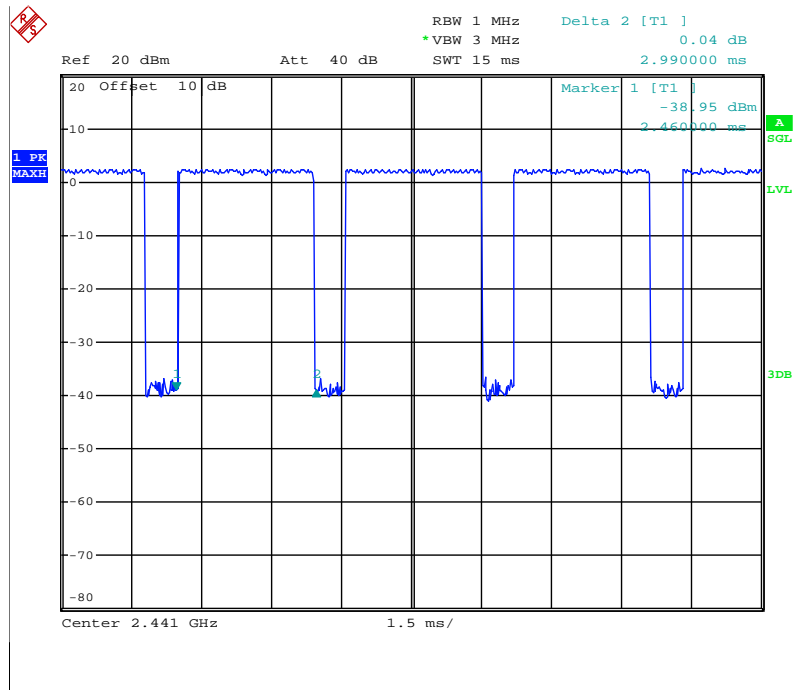

9. MAXIMUM PEAK OUTPUT POWER TEST

9.1. Block Diagram of Test Setup

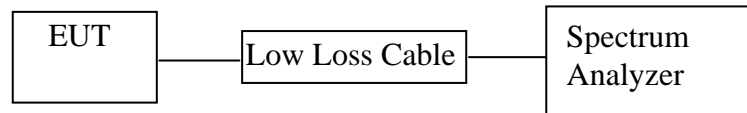

9.2. The Requirement For Section 15.247(b)(1)

For frequency hopping systems operating in the 2400-2483.5 MHz band employing at least 75 non-overlapping hopping channels, and all frequency hopping systems in the 5725-5850 MHz band: 1 watt. For all other frequency hopping systems in the 2400-2483.5 MHz band: 0.125 watts.

9.3. EUT Configuration on Test

The equipment are installed on the emission Measurement to meet the commission requirements and operating regulations in a manner which tends to maximize its emission characteristics in normal application.

9.4. Operating Condition of EUT

9.4.1. Setup the EUT and simulator as shown as Section 9.1.

9.4.2. Turn on the power of all equipment.

9.4.3. Let the EUT work in TX (Hopping off) modes measure it. The transmit frequency are 2402-2480MHz. We select 2402MHz, 2441MHz, and 2480MHz TX frequency to transmit.

9.5. Test Procedure

9.5.1. The transmitter output was connected to the spectrum analyzer through a low loss cable.

9.5.2. Set RBW of spectrum analyzer to 3MHz and VBW to 10MHz.

9.5.3. Measurement the maximum peak output power.

9.6. Test Result

GFSK Mode

Channel	Frequency (MHz)	Peak Output Power (dBm/W)	Limits dBm / W
Low	2402	0.91/0.0012	21 / 0.125
Middle	2441	0.66/0.0012	21 / 0.125
High	2480	0.46/0.0011	21 / 0.125

Π/4-DQPSK Mode

Channel	Frequency (MHz)	Peak Output Power (dBm/W)	Limits dBm / W
Low	2402	3.12/0.0021	21 / 0.125
Middle	2441	2.93/0.0020	21 / 0.125
High	2480	2.75/0.0019	21 / 0.125

8DPSK Mode

Channel	Frequency (MHz)	Peak Output Power (dBm/W)	Limits dBm / W
Low	2402	3.45/0.0022	21 / 0.125
Middle	2441	3.42/0.0022	21 / 0.125
High	2480	2.97/0.0020	21 / 0.125

The spectrum analyzer plots are attached as below.

GFSK Mode

Low channel

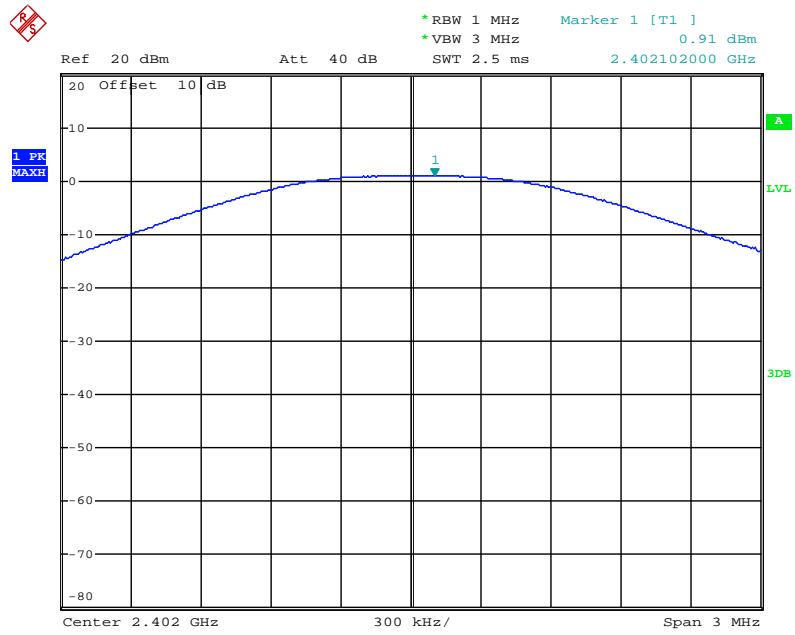

Middle channel

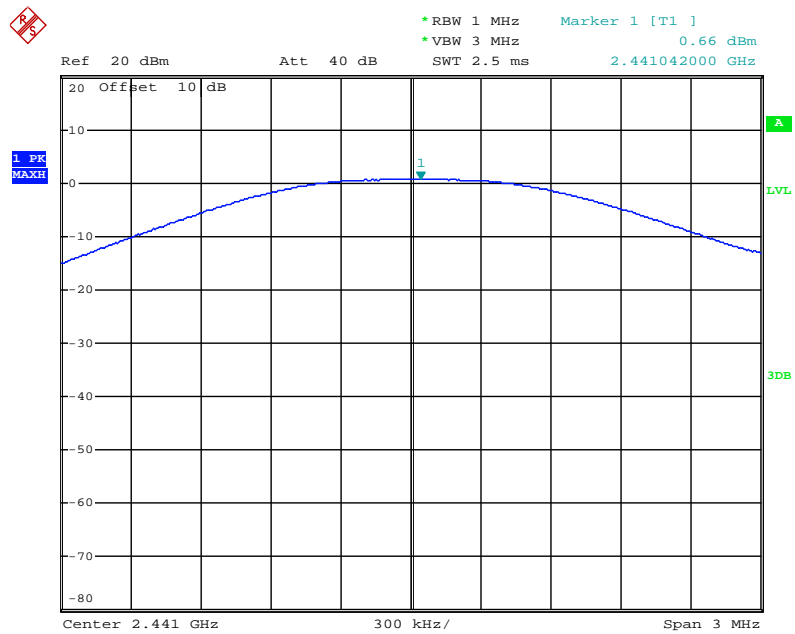

High channel

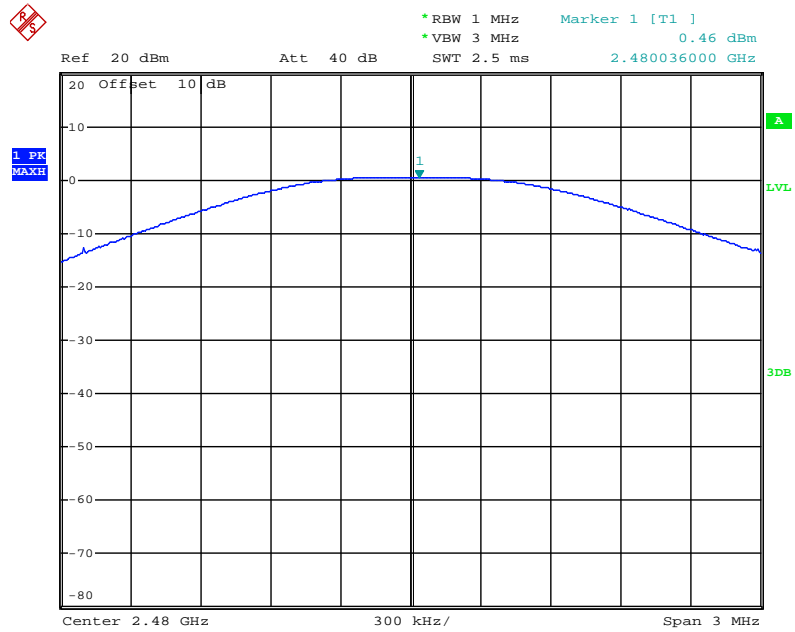

Π/4-DQPSK Mode

Low channel

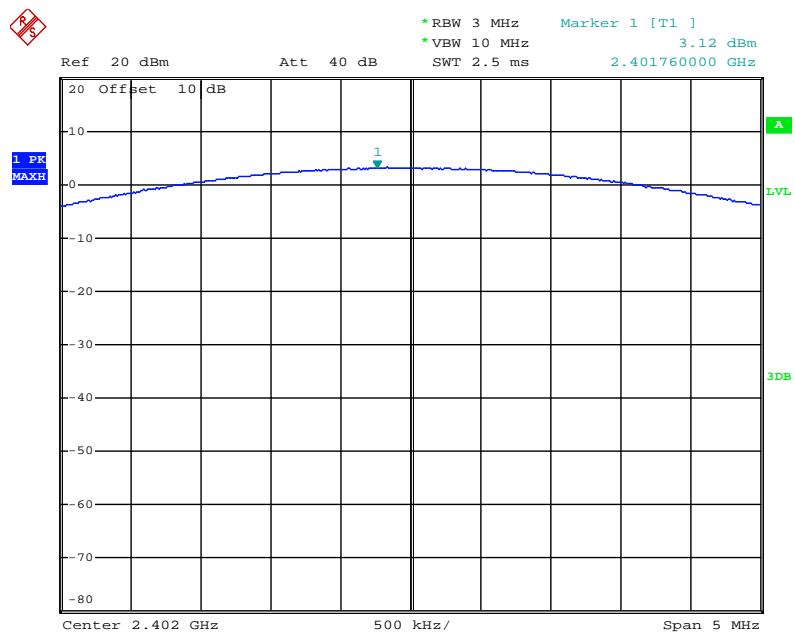

Middle channel

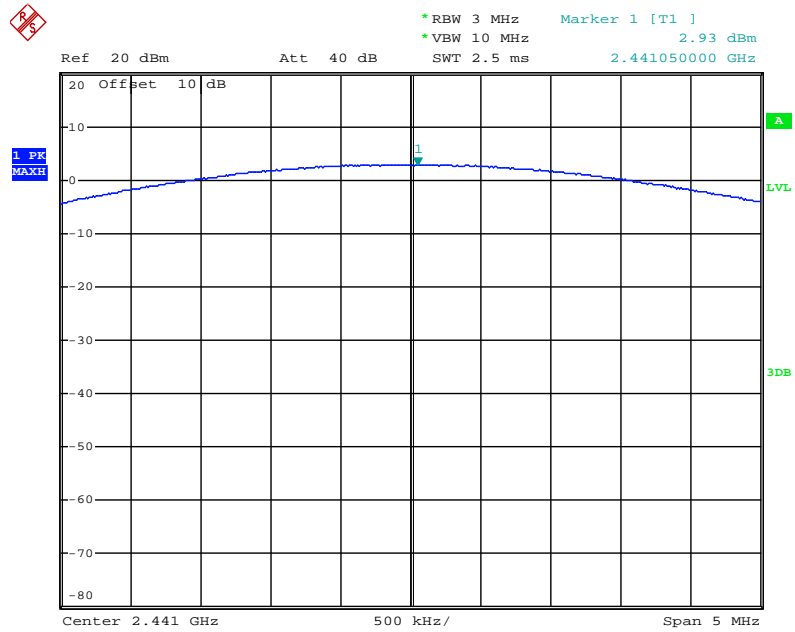

High channel

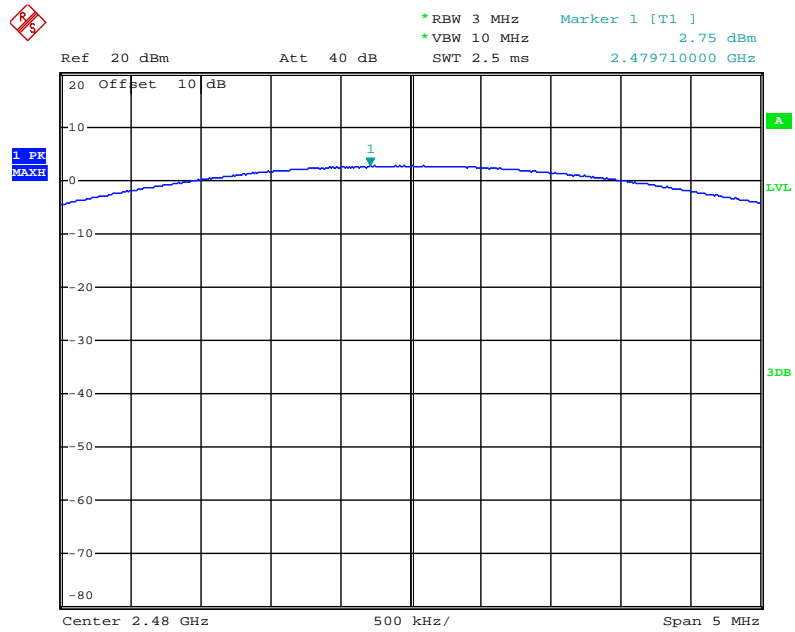

8DPSK Mode

Low channel

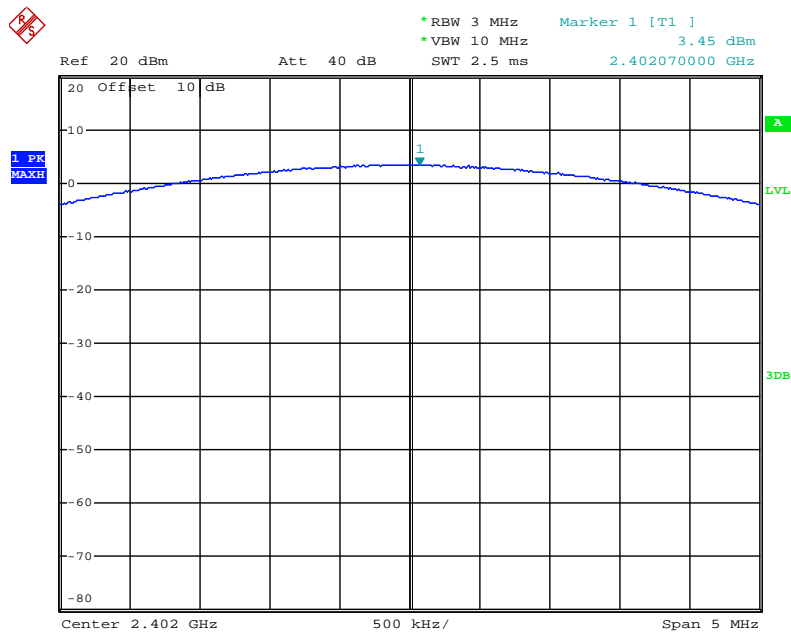

Middle channel

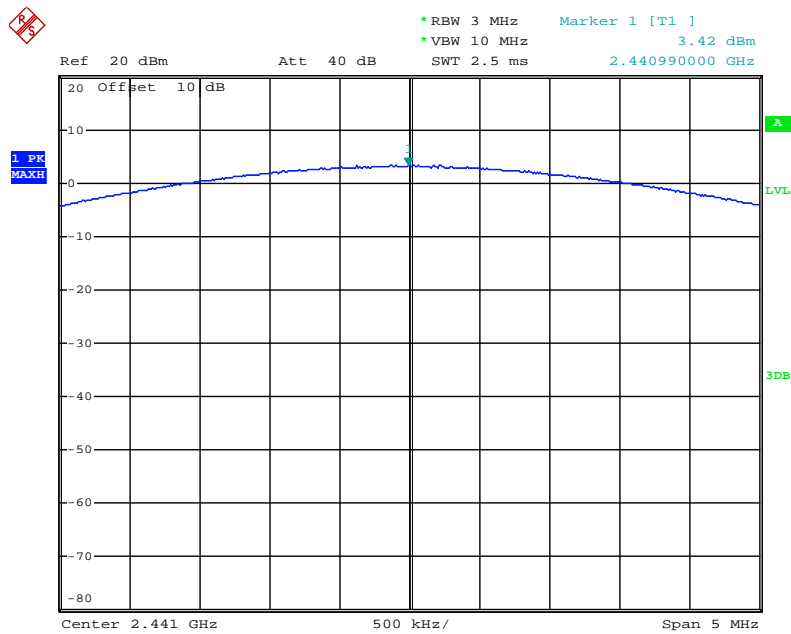

High channel

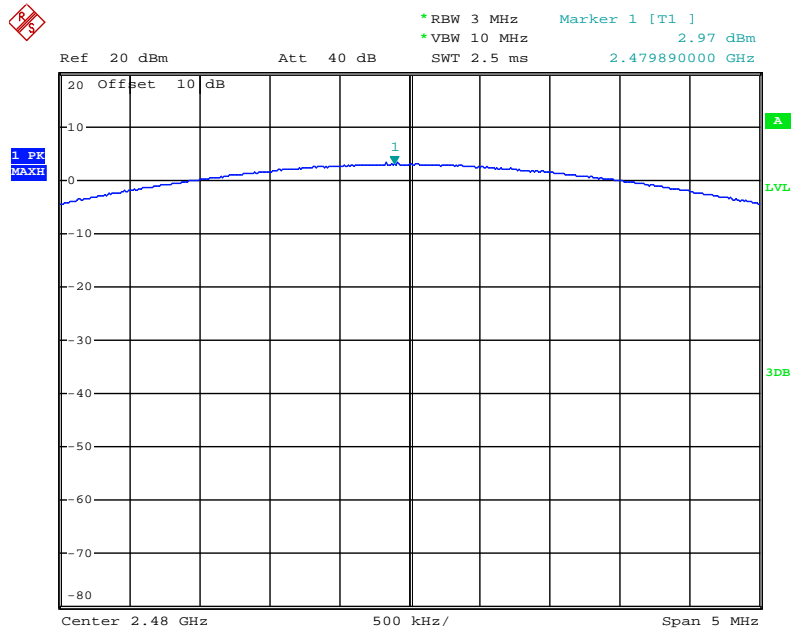

10. RADIATED EMISSION TEST

10.1. Block Diagram of Test Setup

10.1.1. Block diagram of connection between the EUT and peripherals

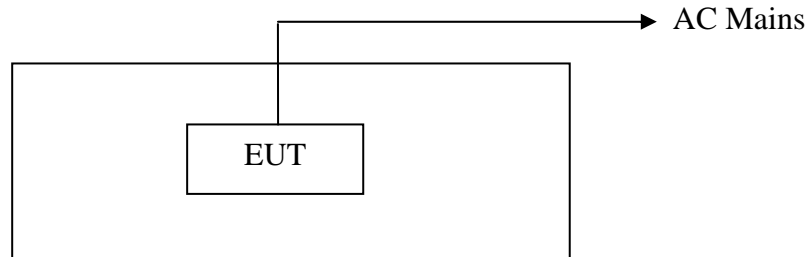

10.1.2. Semi-Anechoic Chamber Test Setup Diagram

(A) Radiated Emission Test Set-Up, Frequency below 30MHz

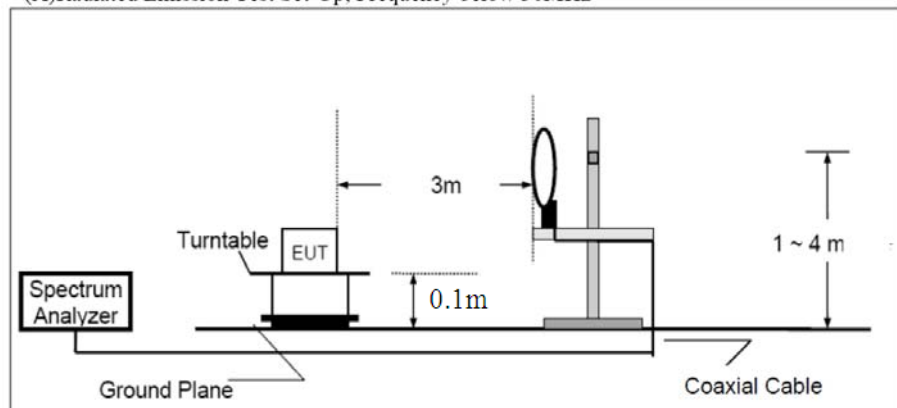

(B) Radiated Emission Test Set-Up, Frequency 30MHz-1GHz

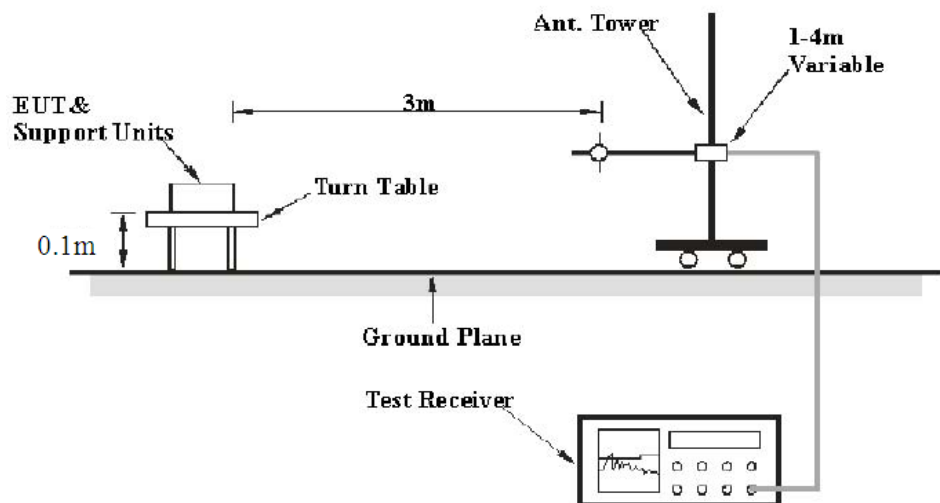

(C) Radiated Emission Test Set-Up, Frequency above 1GHz

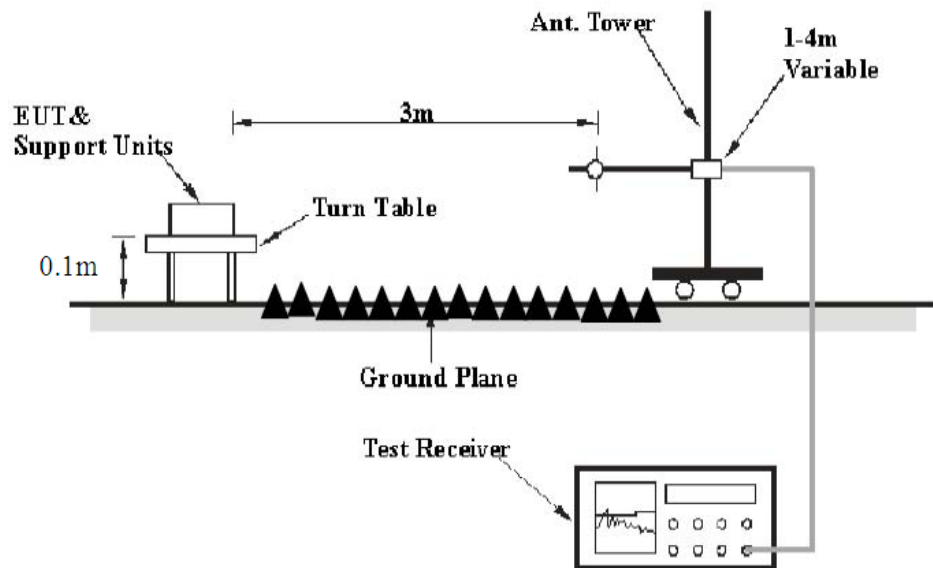

10.2. The Limit For Section 15.247(d)

Section 15.247(d): In any 100 kHz bandwidth outside the frequency band in which the spread spectrum or digitally modulated intentional radiator is operating, the radio frequency power that is produced by the intentional radiator shall be at least 20 dB below that in the 100 kHz bandwidth within the band that contains the highest level of the desired power, based on either an RF conducted or a radiated measurement, provided the transmitter demonstrates compliance with the peak conducted power limits. If the transmitter complies with the conducted power limits based on the use of RMS averaging over a time interval, as permitted under paragraph (b)(3) of this section, the attenuation required under this paragraph shall be 30 dB instead of 20 dB. Attenuation below the general limits specified in Section 15.209(a) is not required. In addition, radiated emissions which fall in the restricted bands, as defined in Section 15.205(a), must also comply with the radiated emission limits specified in Section 15.209(a).

10.3.Restricted bands of operation

10.3.1.FCC Part 15.205 Restricted bands of operation

(a) Except as shown in paragraph (d) of this section, Only spurious emissions are permitted in any of the frequency bands listed below:

MHz	MHz	MHz	GHz
0.090-0.110	16.42-16.423	399.9-410	4.5-5.15
¹ 0.495-0.505	16.69475-16.69525	608-614	5.35-5.46
2.1735-2.1905	16.80425-16.80475	960-1240	7.25-7.75
4.125-4.128	25.5-25.67	1300-1427	8.025-8.5
4.17725-4.17775	37.5-38.25	1435-1626.5	9.0-9.2
4.20725-4.20775	73-74.6	1645.5-1646.5	9.3-9.5
6.215-6.218	74.8-75.2	1660-1710	10.6-12.7
6.26775-6.26825	108-121.94	1718.8-1722.2	13.25-13.4
6.31175-6.31225	123-138	2200-2300	14.47-14.5
8.291-8.294	149.9-150.05	2310-2390	15.35-16.2
8.362-8.366	156.52475-156.52525	2483.5-2500	17.7-21.4
8.37625-8.38675	156.7-156.9	2690-2900	22.01-23.12
8.41425-8.41475	162.0125-167.17	3260-3267	23.6-24.0
12.29-12.293	167.72-173.2	3332-3339	31.2-31.8
12.51975-12.52025	240-285	3345.8-3358	36.43-36.5
12.57675-12.57725	322-335.4	3600-4400	(²)
13.36-13.41			

¹Until February 1, 1999, this restricted band shall be 0.490-0.510

²Above 38.6

(b) Except as provided in paragraphs (d) and (e), the field strength of emission appearing within these frequency bands shall not exceed the limits shown in Section 15.209. At frequencies equal to or less than 1000MHz, Compliance with the limits in Section 15.209 shall be demonstrated using measurement instrumentation employing a CISPR quasi-peak detector. Above 1000MHz, compliance with the emission limits in Section 15.209 shall be demonstrated based on the average value of the measured emissions. The provisions in Section 15.35 apply to these measurements.

10.4.EUT Configuration on Test

The equipment is installed on Radiated Emission Measurement to meet the commission requirements and operating regulations in a manner which tends to maximize its emission characteristics in normal application.

10.5. Operating Condition of EUT

10.5.1. Setup the EUT and simulator as shown as Section 10.1.

10.5.2. Turn on the power of all equipment.

10.5.3. Let the EUT work in TX modes measure it. The transmit frequency are 2402-2480MHz. We select 2402MHz, 2441MHz, and 2480MHz TX frequency to transmit.

10.6. Test Procedure

The EUT and its simulators are placed on a turntable, which is 0.1 meter high above ground. The turntable can rotate 360 degrees to determine the position of the maximum emission level. EUT is set 3.0 meters away from the receiving antenna, which is mounted on an antenna tower. The antenna can be moved up and down between 1.0 meter and 4 meters to find out the maximum emission level. Broadband antenna (calibrated bi-log antenna) is used as receiving antenna. Both horizontal and vertical polarizations of the antenna are set on measurement. In order to find the maximum emission levels, all of the EUT location must be manipulated according to ANSI C63.10:2013 on radiated emission measurement. This EUT was tested in 3 orthogonal positions and the Worse case position data was reported.

During the radiated emission test, the spectrum analyzer was set with the following configurations:

1. The resolution bandwidth and video bandwidth of test receiver/spectrum analyzer is 120kHz for Quasi-peak at frequency below 1GHz.
2. The resolution bandwidth of test receiver/spectrum analyzer is 1MHz and video bandwidth is 3MHz for peak measurement with peak detector at frequency above 1GHz.
3. The resolution bandwidth of test receiver/spectrum analyzer is 1MHz and video bandwidth is 10Hz for Average measurement with peak detection at frequency above 1GHz.
4. All modes of operation were investigated and the worse case emissions are reported.

10.7.Data Sample

Frequency (MHz)	Reading (dB μ v)	Factor (dB/m)	Result (dB μ v/m)	Limit (dB μ v/m)	Margin (dB)	Remark
X.XX	48.69	-13.35	35.34	46	-10.66	QP

Frequency(MHz) = Emission frequency in MHz

Reading(dB μ v) = Uncorrected Analyzer/Receiver reading

Factor (dB/m) = Antenna factor + Cable Loss – Amplifier gain

Result(dB μ v/m) = Reading(dB μ v) + Factor(dB/m)

Limit (dB μ v/m) = Limit stated in standard

Margin (dB) = Result(dB μ v/m) - Limit (dB μ v/m)

QP = Quasi-peak Reading

Calculation Formula:

Margin(dB) = Result (dB μ V/m)–Limit(dB μ V/m)

Result(dB μ V/m)= Reading(dB μ V)+ Factor(dB/m)

The “Margin” column of the following data tables indicates the degree of compliance with the applicable limit. For example, a margin of -7dB means the emission is 7dB below the limit.

10.8.Test Results

Pass.

Note: 1.We tested GFSK mode, $\Pi/4$ -DQPSK & 8DPSK Mode and recorded the Worse case data (GFSK mode) for all test mode.

2. Testing is carried out with frequency rang 9kHz to the tenth harmonics, which above 3th Harmonics are attenuated more than 20dB below the permissible limits or the field strength is too small to be measured.

The measurements greater than 20dB below the limit from 9kHz to 30MHz and 18 to 26.5GHz.

The spectrum analyzer plots are attached as below.

Below 1GHz



ACCURATE TECHNOLOGY CO., LTD.

F1,Bldg,A,Changyuan New Material Port Keyuan Rd,
Science & Industry Park,Nanshan Shenzhen,P.R.China

Site: 1# Chamber
Tel:+86-0755-26503290
Fax:+86-0755-26503396

Job No.: MFL #11	Polarization: Vertical
Standard: FCC Class B 3M Radiated	Power Source: AC 120V/60Hz
Test item: Radiation Test	Date: 19/10/23/
Temp.(C)/Hum.(%) 25 C / 55 %	Time: 9/33/11
EUT: Massage Chair	Engineer Signature:
Mode: TX2402MHz	Distance: 3m
Model: EC-7502A	
Manufacturer: XIAMEN HEALTHCARE ELECTRONIC CO.,LTD	

Note: Report NO.:ATE20191491

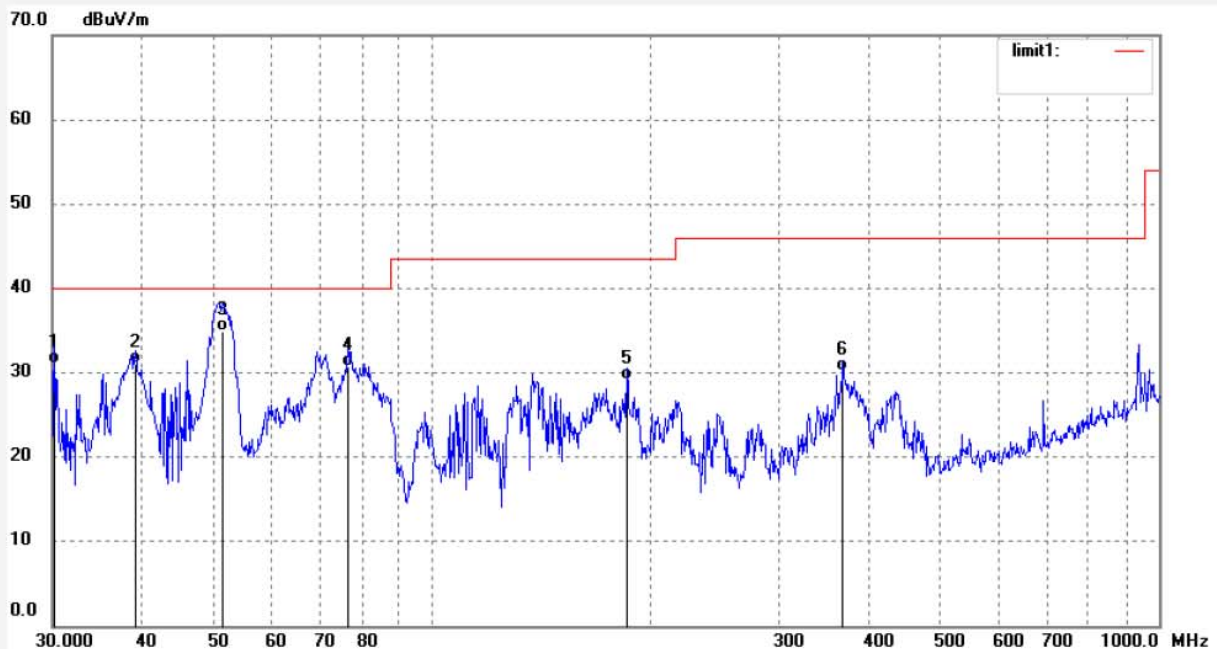

No.	Freq. (MHz)	Reading (dBuV/m)	Factor (dB)	Result (dBuV/m)	Limit (dBuV/m)	Margin (dB)	Detector	Height (cm)	Degree (deg.)	Remark
1	30.2116	51.38	-20.25	31.13	40.00	-8.87	QP	100	189	
2	39.0449	54.32	-23.19	31.13	40.00	-8.87	QP	100	315	
3	51.5363	61.38	-26.44	34.94	40.00	-5.06	QP	100	99	
4	76.6556	58.35	-27.60	30.75	40.00	-9.25	QP	100	208	
5	185.1625	54.69	-25.53	29.16	43.50	-14.34	QP	100	349	
6	367.3752	48.92	-18.81	30.11	46.00	-15.89	QP	100	255	



ACCURATE TECHNOLOGY CO., LTD.

F1,Bldg,A,Changyuan New Material Port Keyuan Rd,
Science & Industry Park,Nanshan Shenzhen,P.R.China

Site: 1# Chamber
Tel:+86-0755-26503290
Fax:+86-0755-26503396

Job No.: MFL #12
Standard: FCC Class B 3M Radiated
Test item: Radiation Test
Temp.(C)/Hum.(%) 25 C / 55 %
EUT: Massage Chair
Mode: TX2402MHz
Model: EC-7502A
Manufacturer: XIAMEN HEALTHCARE ELECTRONIC CO.,LTD

Polarization: Horizontal
Power Source: AC 120V/60Hz
Date: 19/10/23/
Time: 9/35/02
Engineer Signature:
Distance: 3m

Note: Report NO.:ATE20191491

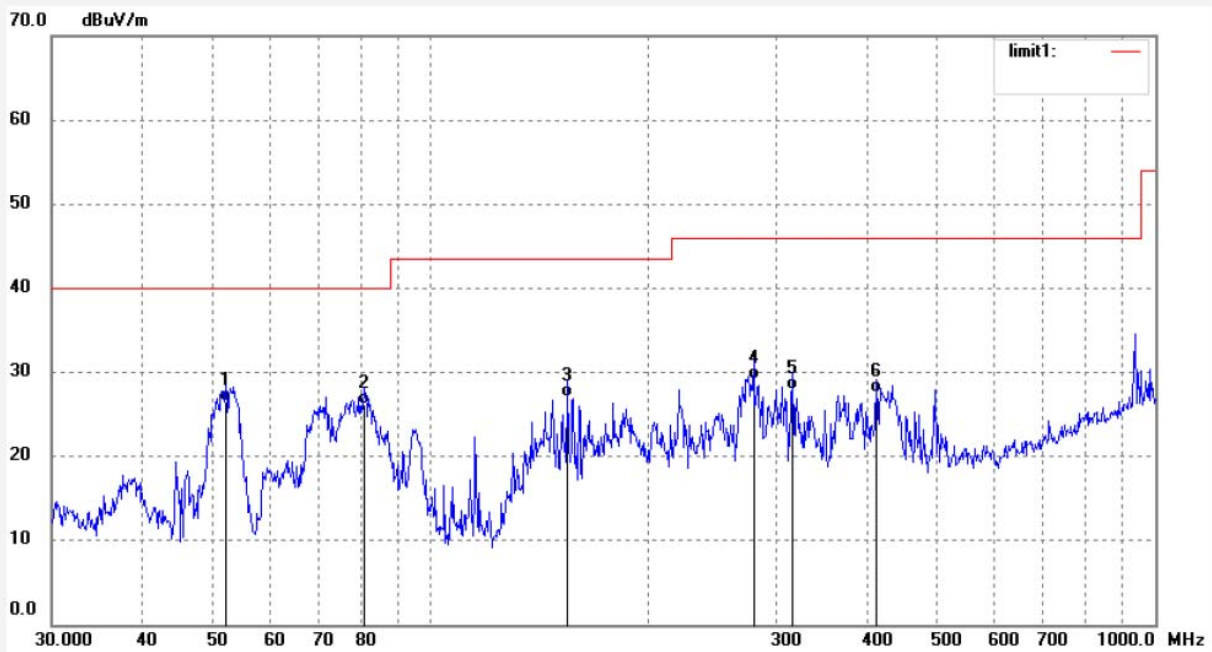

No.	Freq. (MHz)	Reading (dBuV/m)	Factor (dB)	Result (dBuV/m)	Limit (dBuV/m)	Margin (dB)	Detector	Height (cm)	Degree (deg.)	Remark
1	52.2659	53.01	-26.57	26.44	40.00	-13.56	QP	200	104	
2	81.0884	53.64	-27.42	26.22	40.00	-13.78	QP	200	193	
3	154.7855	54.68	-27.64	27.04	43.50	-16.46	QP	200	331	
4	279.3104	51.35	-22.14	29.21	46.00	-16.79	QP	200	201	
5	315.8599	48.60	-20.76	27.84	46.00	-18.16	QP	200	81	
6	412.5394	45.65	-18.09	27.56	46.00	-18.44	QP	200	216	



ACCURATE TECHNOLOGY CO., LTD.

F1,Bldg,A,Changyuan New Material Port Keyuan Rd,
Science & Industry Park,Nanshan Shenzhen,P.R.China

Site: 1# Chamber
Tel:+86-0755-26503290
Fax:+86-0755-26503396

Job No.: MFL #13	Polarization: Horizontal
Standard: FCC Class B 3M Radiated	Power Source: AC 120V/60Hz
Test item: Radiation Test	Date: 19/10/23/
Temp.(C)/Hum.(%) 25 C / 55 %	Time: 9/37/10
EUT: Massage Chair	Engineer Signature:
Mode: TX2441MHz	Distance: 3m
Model: EC-7502A	
Manufacturer: XIAMEN HEALTHCARE ELECTRONIC CO.,LTD	

Note: Report NO.:ATE20191491

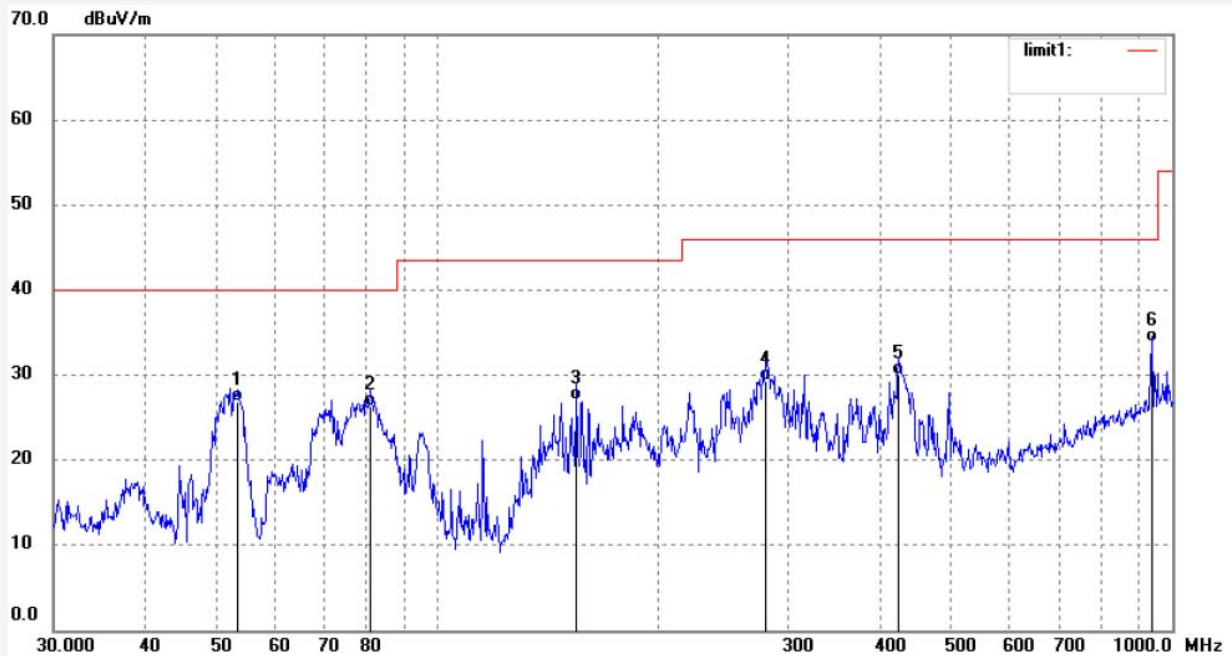

No.	Freq. (MHz)	Reading (dBuV/m)	Factor (dB)	Result (dBuV/m)	Limit (dBuV/m)	Margin (dB)	Detector	Height (cm)	Degree (deg.)	Remark
1	53.5673	53.64	-26.78	26.86	40.00	-13.14	QP	200	103	
2	81.0885	53.68	-27.42	26.26	40.00	-13.74	QP	200	93	
3	154.7856	54.68	-27.64	27.04	43.50	-16.46	QP	200	211	
4	280.2936	51.36	-22.09	29.27	46.00	-16.73	QP	200	85	
5	424.2998	47.98	-17.94	30.04	46.00	-15.96	QP	200	51	
6	938.7138	40.32	-6.53	33.79	46.00	-12.21	QP	200	145	



ACCURATE TECHNOLOGY CO., LTD.

F1,Bldg,A,Changyuan New Material Port Keyuan Rd,
Science & Industry Park,Nanshan Shenzhen,P.R.China

Site: 1# Chamber
Tel:+86-0755-26503290
Fax:+86-0755-26503396

Job No.: MFL #14	Polarization: Vertical
Standard: FCC Class B 3M Radiated	Power Source: AC 120V/60Hz
Test item: Radiation Test	Date: 19/10/23/
Temp.(C)/Hum.(%) 25 C / 55 %	Time: 9/39/48
EUT: Massage Chair	Engineer Signature:
Mode: TX2441MHz	Distance: 3m
Model: EC-7502A	
Manufacturer: XIAMEN HEALTHCARE ELECTRONIC CO.,LTD	

Note: Report NO.:ATE20191491

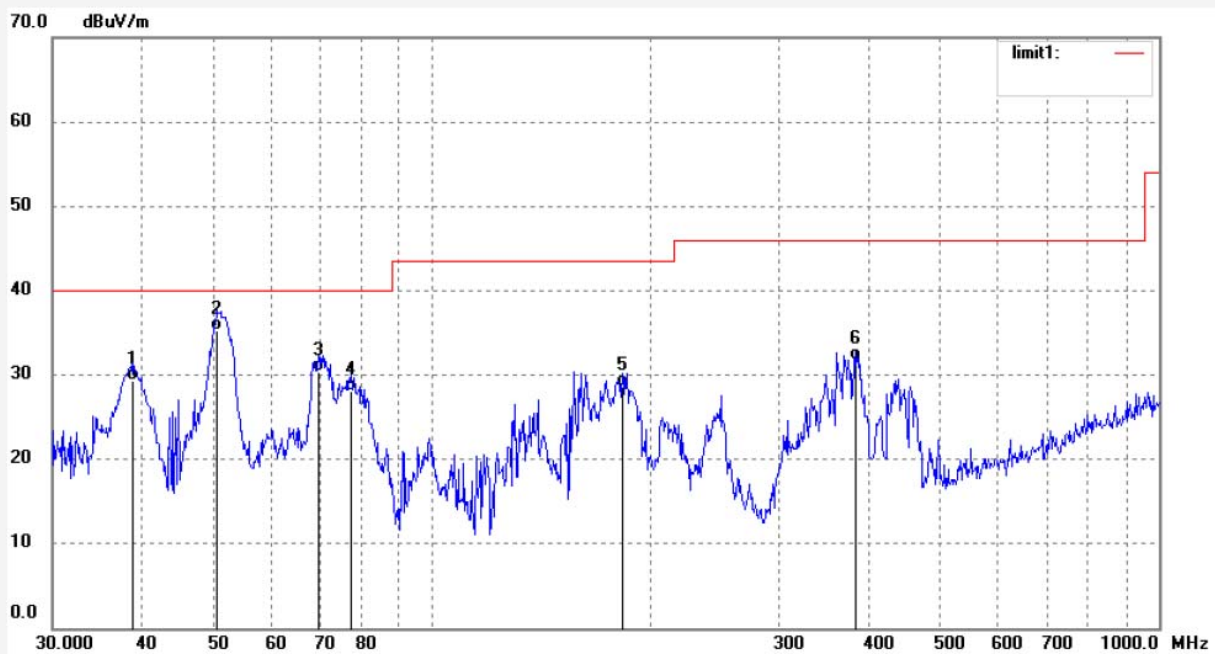

No.	Freq. (MHz)	Reading (dBuV/m)	Factor (dB)	Result (dBuV/m)	Limit (dBuV/m)	Margin (dB)	Detector	Height (cm)	Degree (deg.)	Remark
1	38.7714	52.35	-23.07	29.28	40.00	-10.72	QP	100	108	
2	50.6389	61.65	-26.30	35.35	40.00	-4.65	QP	100	63	
3	69.7179	57.92	-27.47	30.45	40.00	-9.55	QP	100	215	
4	77.4680	55.68	-27.55	28.13	40.00	-11.87	QP	100	96	
5	182.5784	54.32	-25.78	28.54	43.50	-14.96	QP	100	154	
6	381.8519	50.31	-18.60	31.71	46.00	-14.29	QP	100	312	



ACCURATE TECHNOLOGY CO., LTD.

F1,Bldg,A,Changyuan New Material Port Keyuan Rd,
Science & Industry Park,Nanshan Shenzhen,P.R.China

Site: 1# Chamber
Tel:+86-0755-26503290
Fax:+86-0755-26503396

Job No.: MFL #15	Polarization: Vertical
Standard: FCC Class B 3M Radiated	Power Source: AC 120V/60Hz
Test item: Radiation Test	Date: 19/10/23/
Temp.(C)/Hum.(%) 25 C / 55 %	Time: 9/41/57
EUT: Massage Chair	Engineer Signature:
Mode: TX2480MHz	Distance: 3m
Model: EC-7502A	
Manufacturer: XIAMEN HEALTHCARE ELECTRONIC CO.,LTD	

Note: Report NO.:ATE20191491

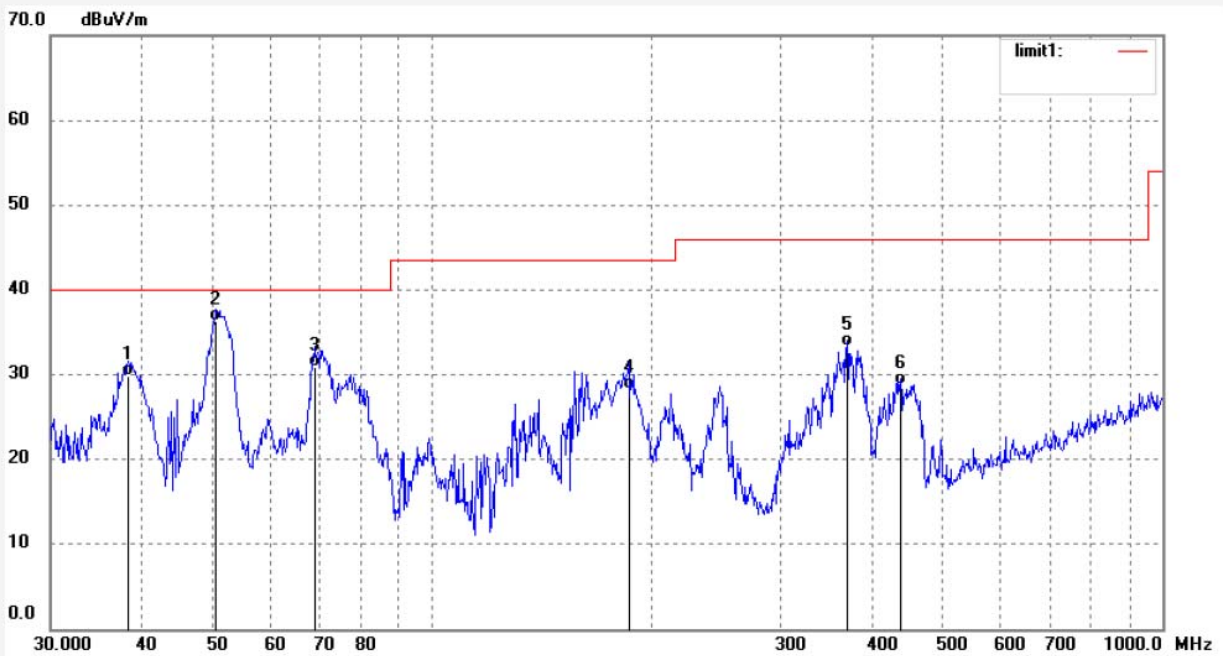

No.	Freq. (MHz)	Reading (dBuV/m)	Factor (dB)	Result (dBuV/m)	Limit (dBuV/m)	Margin (dB)	Detector	Height (cm)	Degree (deg.)	Remark
1	38.3650	52.69	-22.89	29.80	40.00	-10.20	QP	100	193	
2	50.6389	62.64	-26.30	36.34	40.00	-3.66	QP	100	218	
3	68.9869	58.35	-27.44	30.91	40.00	-9.09	QP	100	92	
4	185.8143	53.68	-25.48	28.20	43.50	-15.30	QP	100	212	
5	369.9658	52.05	-18.77	33.28	46.00	-12.72	QP	100	301	
6	437.9316	46.33	-17.58	28.75	46.00	-17.25	QP	100	164	



ACCURATE TECHNOLOGY CO., LTD.

F1,Bldg,A,Changyuan New Material Port Keyuan Rd,
Science & Industry Park,Nanshan Shenzhen,P.R.China

Site: 1# Chamber
Tel:+86-0755-26503290
Fax:+86-0755-26503396

Job No.: MFL #16	Polarization: Horizontal
Standard: FCC Class B 3M Radiated	Power Source: AC 120V/60Hz
Test item: Radiation Test	Date: 19/10/23/
Temp.(C)/Hum.(%) 25 C / 55 %	Time: 9/43/46
EUT: Massage Chair	Engineer Signature:
Mode: TX2480MHz	Distance: 3m
Model: EC-7502A	
Manufacturer: XIAMEN HEALTHCARE ELECTRONIC CO.,LTD	

Note: Report NO.:ATE20191491

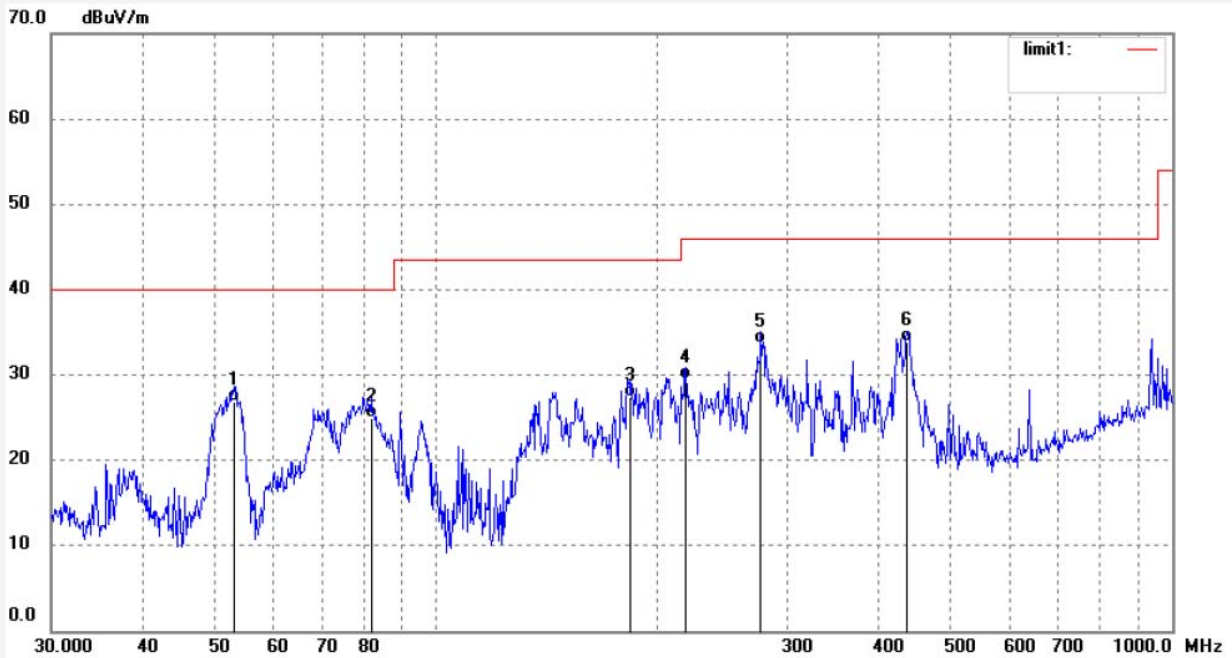

No.	Freq. (MHz)	Reading (dBuV/m)	Factor (dB)	Result (dBuV/m)	Limit (dBuV/m)	Margin (dB)	Detector	Height (cm)	Degree (deg.)	Remark
1	53.1921	53.67	-26.72	26.95	40.00	-13.05	QP	200	109	
2	81.6603	52.38	-27.42	24.96	40.00	-15.04	QP	200	331	
3	183.2211	53.15	-25.71	27.44	43.50	-16.06	QP	200	21	
4	218.4096	53.45	-24.03	29.42	46.00	-16.58	QP	200	92	
5	276.3817	55.97	-22.33	33.64	46.00	-12.36	QP	200	215	
6	436.3956	51.46	-17.60	33.86	46.00	-12.14	QP	200	63	

Above 1GHz



ACCURATE TECHNOLOGY CO., LTD.

F1,Bldg,A,Changyuan New Material Port Keyuan Rd,
Science & Industry Park,Nanshan Shenzhen,P.R.China

Site: 1# Chamber
Tel:+86-0755-26503290
Fax:+86-0755-26503396

Job No.: MFL #19	Polarization: Horizontal
Standard: FCC PK	Power Source: AC 120V/60Hz
Test item: Radiation Test	Date: 19/10/23/
Temp.(C)/Hum.(%) 25 C / 55 %	Time: 9/25/43
EUT: Massage Chair	Engineer Signature:
Mode: TX2402MHz	Distance: 3m
Model: EC-7502A	
Manufacturer: XIAMEN HEALTHCARE ELECTRONIC CO.,LTD	

Note: Report NO.:ATE20191491

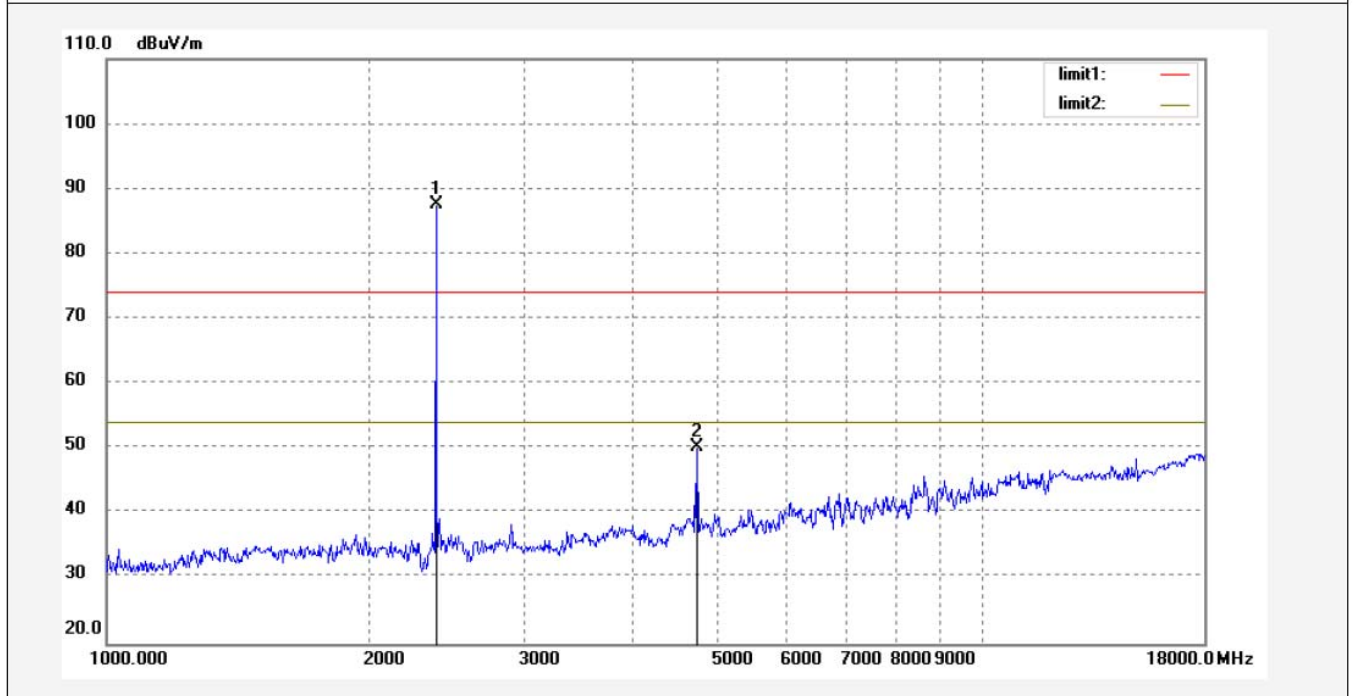

No.	Freq. (MHz)	Reading (dBuV/m)	Factor (dB)	Result (dBuV/m)	Limit (dBuV/m)	Margin (dB)	Detector	Height (cm)	Degree (deg.)	Remark
1	2402.000	94.02	-6.37	87.65			peak	200	136	
2	4804.000	49.61	0.70	50.31	74.00	-23.69	peak	200	204	



ACCURATE TECHNOLOGY CO., LTD.

F1,Bldg,A,Changyuan New Material Port Keyuan Rd,
Science & Industry Park,Nanshan Shenzhen,P.R.China

Site: 1# Chamber
Tel:+86-0755-26503290
Fax:+86-0755-26503396

Job No.: MFL #20	Polarization: Vertical
Standard: FCC PK	Power Source: AC 120V/60Hz
Test item: Radiation Test	Date: 19/10/23/
Temp.(C)/Hum.(%) 25 C / 55 %	Time: 9/27/43
EUT: Massage Chair	Engineer Signature:
Mode: TX2402MHz	Distance: 3m
Model: EC-7502A	
Manufacturer: XIAMEN HEALTHCARE ELECTRONIC CO.,LTD	

Note: Report NO.:ATE20191491

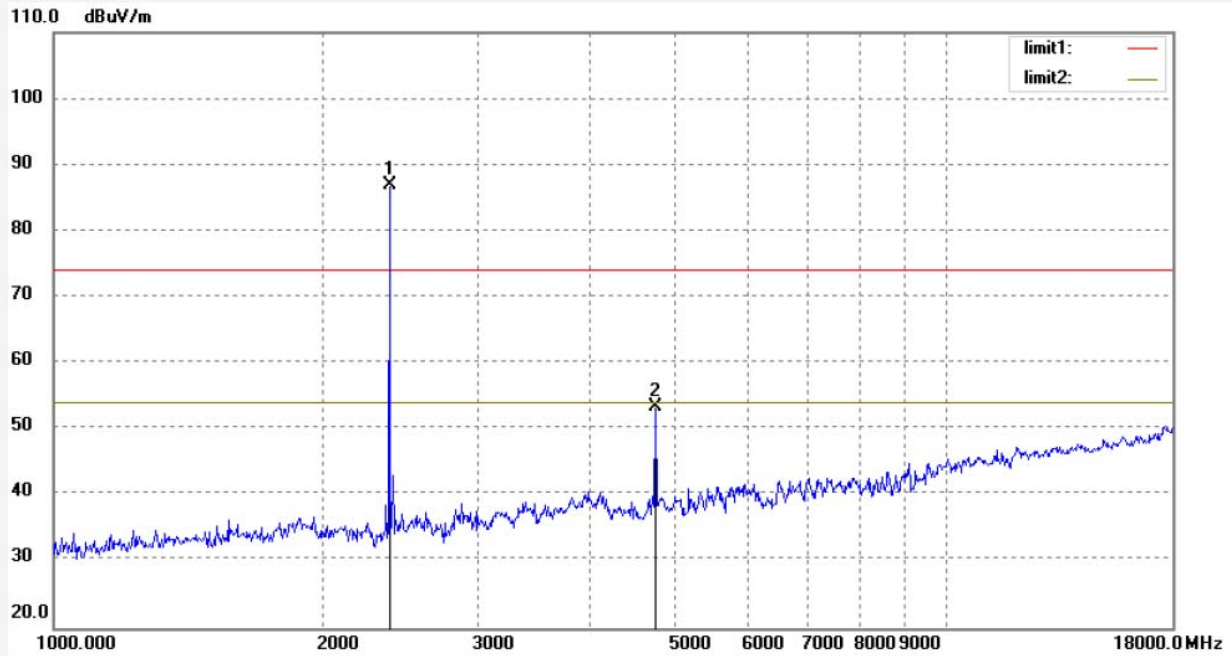

No.	Freq. (MHz)	Reading (dBuV/m)	Factor (dB)	Result (dBuV/m)	Limit (dBuV/m)	Margin (dB)	Detector	Height (cm)	Degree (deg.)	Remark
1	2402.000	93.38	-6.37	87.01			peak	150	153	
2	4804.000	52.62	0.70	53.32	74.00	-20.68	peak	150	320	



ACCURATE TECHNOLOGY CO., LTD.

F1,Bldg,A,Changyuan New Material Port Keyuan Rd,
Science & Industry Park,Nanshan Shenzhen,P.R.China

Site: 1# Chamber

Tel:+86-0755-26503290

Fax:+86-0755-26503396

Job No.: MFL #21

Standard: FCC PK

Test item: Radiation Test

Temp.(C)/Hum.(%) 25 C / 55 %

EUT: Massage Chair

Mode: TX2441MHz

Model: EC-7502A

Manufacturer: XIAMEN HEALTHCARE ELECTRONIC CO.,LTD

Polarization: Vertical

Power Source: AC 120V/60Hz

Date: 19/10/23/

Time: 9/29/03

Engineer Signature:

Distance: 3m

Note: Report NO.:ATE20191491

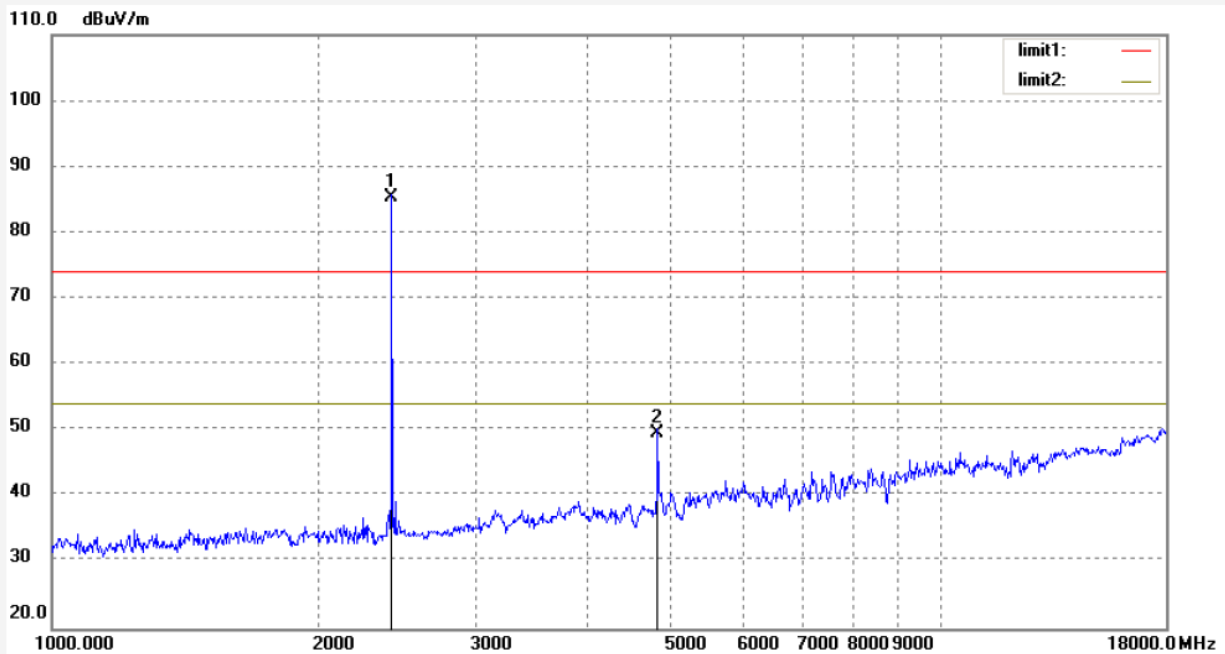

No.	Freq. (MHz)	Reading (dBuV/m)	Factor (dB)	Result (dBuV/m)	Limit (dBuV/m)	Margin (dB)	Detector	Height (cm)	Degree (deg.)	Remark
1	2441.000	91.55	-6.20	85.35			peak	150	120	
2	4882.000	48.61	1.07	49.68	74.00	-24.32	peak	150	48	



ACCURATE TECHNOLOGY CO., LTD.

F1,Bldg,A,Changyuan New Material Port Keyuan Rd,
Science & Industry Park,Nanshan Shenzhen,P.R.China

Site: 1# Chamber

Tel:+86-0755-26503290

Fax:+86-0755-26503396

Job No.: MFL #22

Standard: FCC PK

Test item: Radiation Test

Temp.(C)/Hum.(%) 25 C / 55 %

EUT: Massage Chair

Mode: TX2441MHz

Model: EC-7502A

Manufacturer: XIAMEN HEALTHCARE ELECTRONIC CO.,LTD

Polarization: Horizontal

Power Source: AC 120V/60Hz

Date: 19/10/23/

Time: 9/33/04

Engineer Signature:

Distance: 3m

Note: Report NO.:ATE20191491

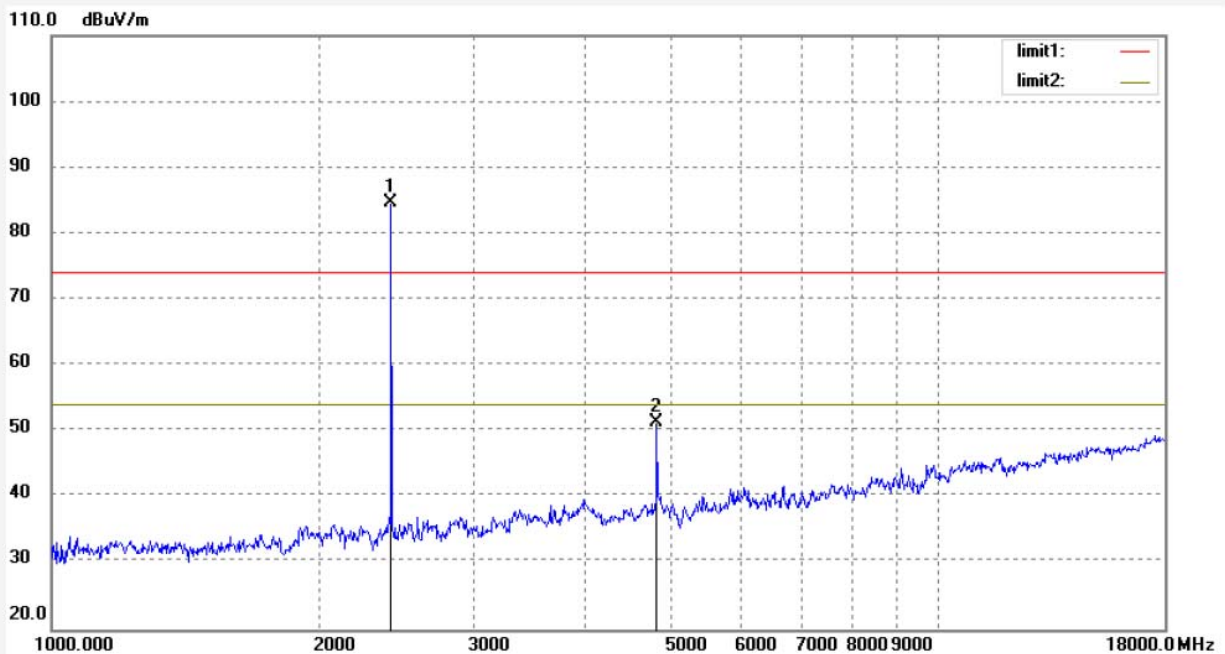

No.	Freq. (MHz)	Reading (dBuV/m)	Factor (dB)	Result (dBuV/m)	Limit (dBuV/m)	Margin (dB)	Detector	Height (cm)	Degree (deg.)	Remark
1	2441.000	90.87	-6.20	84.67			peak	200	136	
2	4882.000	50.31	1.07	51.38	74.00	-22.62	peak	200	153	



ACCURATE TECHNOLOGY CO., LTD.

F1,Bldg,A,Changyuan New Material Port Keyuan Rd,
Science & Industry Park,Nanshan Shenzhen,P.R.China

Site: 1# Chamber
Tel:+86-0755-26503290
Fax:+86-0755-26503396

Job No.: MFL #23	Polarization: Horizontal
Standard: FCC PK	Power Source: AC 120V/60Hz
Test item: Radiation Test	Date: 19/10/23/
Temp.(C)/Hum.(%) 25 C / 55 %	Time: 9/35/25
EUT: Massage Chair	Engineer Signature:
Mode: TX2480MHz	Distance: 3m
Model: EC-7502A	
Manufacturer: XIAMEN HEALTHCARE ELECTRONIC CO.,LTD	

Note: Report NO.:ATE20191491

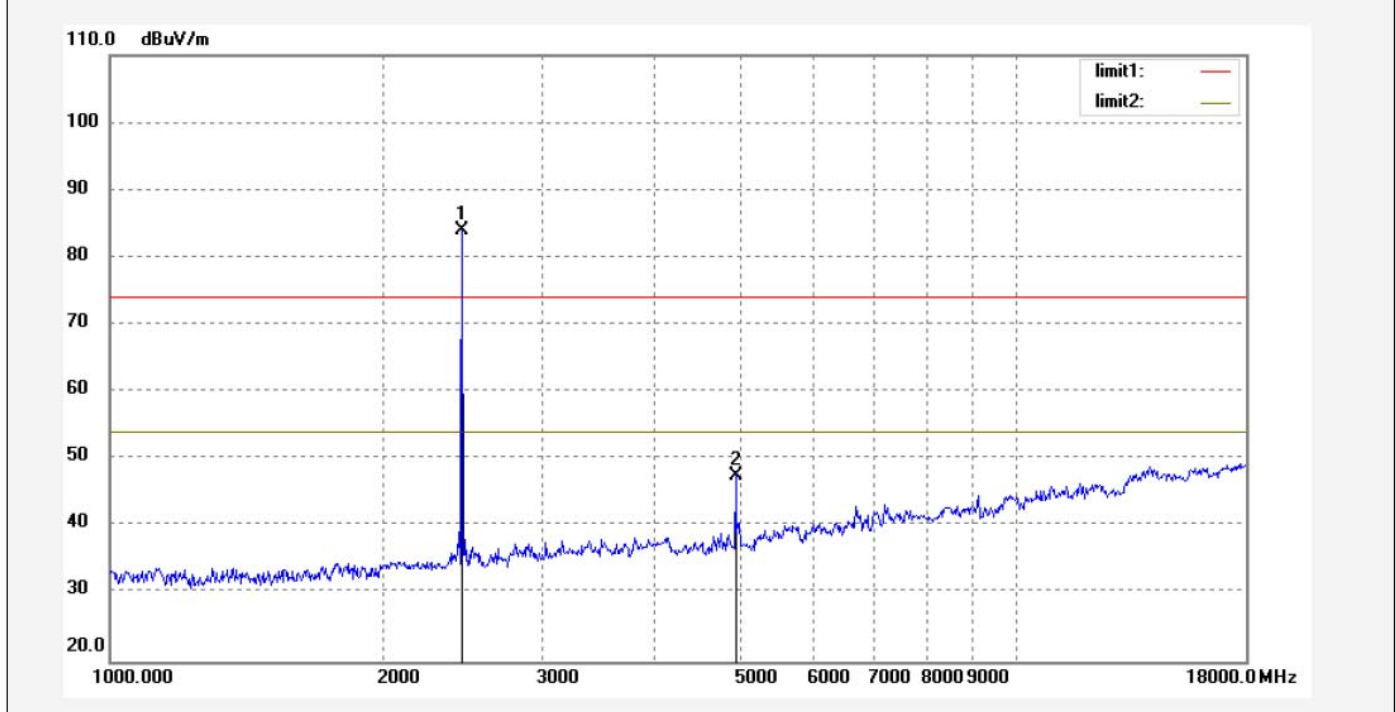

No.	Freq. (MHz)	Reading (dBuV/m)	Factor (dB)	Result (dBuV/m)	Limit (dBuV/m)	Margin (dB)	Detector	Height (cm)	Degree (deg.)	Remark
1	2480.000	90.06	-6.04	84.02			peak	200	54	
2	4960.000	46.12	1.50	47.62	74.00	-26.38	peak	200	120	



ACCURATE TECHNOLOGY CO., LTD.

F1,Bldg,A,Changyuan New Material Port Keyuan Rd,
Science & Industry Park,Nanshan Shenzhen,P.R.China

Site: 1# Chamber
Tel:+86-0755-26503290
Fax:+86-0755-26503396

Job No.: MFL #24	Polarization: Vertical
Standard: FCC PK	Power Source: AC 120V/60Hz
Test item: Radiation Test	Date: 19/10/23/
Temp.(C)/Hum.(%) 25 C / 55 %	Time: 9/37/39
EUT: Massage Chair	Engineer Signature:
Mode: TX2480MHz	Distance: 3m
Model: EC-7502A	
Manufacturer: XIAMEN HEALTHCARE ELECTRONIC CO.,LTD	

Note: Report NO.:ATE20191491

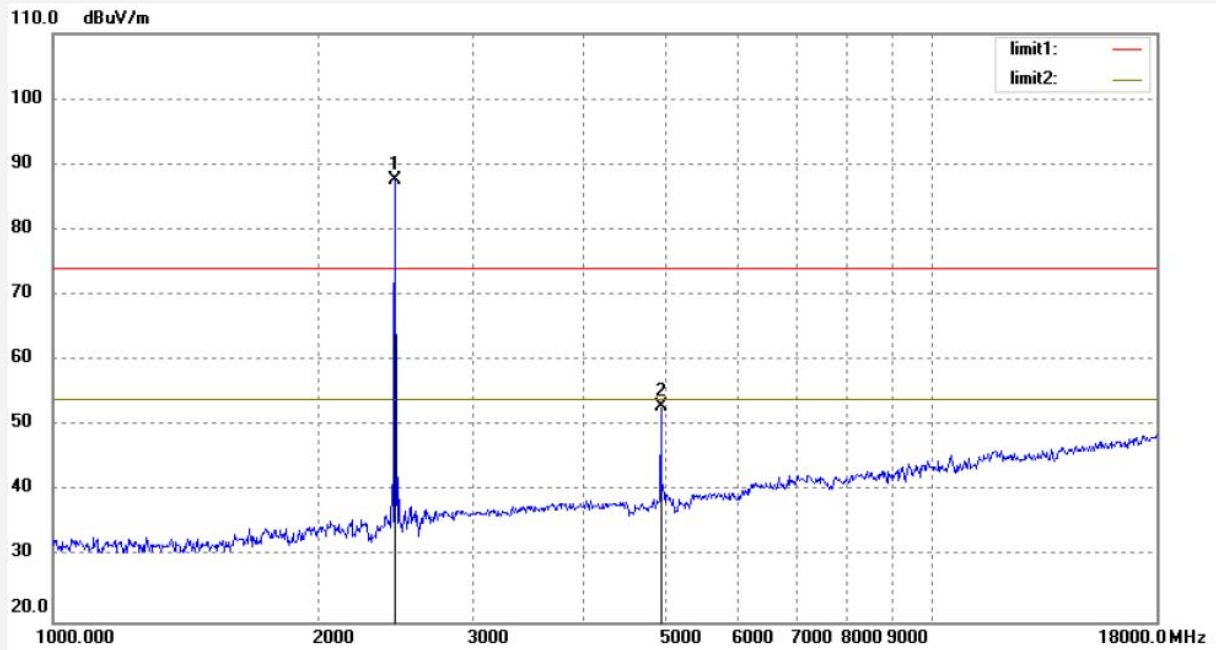

No.	Freq. (MHz)	Reading (dBuV/m)	Factor (dB)	Result (dBuV/m)	Limit (dBuV/m)	Margin (dB)	Detector	Height (cm)	Degree (deg.)	Remark
1	2480.000	93.72	-6.04	87.68			peak	150	320	
2	4960.000	51.48	1.50	52.98	74.00	-21.02	peak	150	157	

11.BAND EDGE COMPLIANCE TEST

11.1.Block Diagram of Test Setup



11.2.The Requirement For Section 15.247(d)

In any 100 kHz bandwidth outside the frequency band in which the spread spectrum or digitally modulated intentional radiator is operating, the radio frequency power that is produced by the intentional radiator shall be at least 20 dB below that in the 100 kHz bandwidth within the band that contains the highest level of the desired power, based on either an RF conducted or a radiated measurement, provided the transmitter demonstrates compliance with the peak conducted power limits. If the transmitter complies with the conducted power limits based on the use of RMS averaging over a time interval, as permitted under paragraph (b)(3) of this section, the attenuation required under this paragraph shall be 30 dB instead of 20 dB. Attenuation below the general limits specified in Section 15.209(a) is not required. In addition, radiated emissions which fall in the restricted bands, as defined in Section 15.205(a), must also comply with the radiated emission limits specified in Section 15.209(a).

11.3.EUT Configuration on Test

The equipment are installed on the emission Measurement to meet the commission requirements and operating regulations in a manner which tends to maximize its emission characteristics in normal application.

11.4.Operating Condition of EUT

11.4.1.Setup the EUT and simulator as shown as Section 11.1.

11.4.2.Turn on the power of all equipment.

11.4.3.Let the EUT work in TX (Hopping off, Hopping on) modes measure it. The transmit frequency are 2402-2480MHz. We select 2402MHz, 2480MHz TX frequency to transmit.

11.5. Test Procedure

11.5.1. The transmitter output was connected to the spectrum analyzer via a low loss cable.

11.5.2. Set RBW of spectrum analyzer to 100 kHz and VBW to 300 kHz with convenient frequency span including 100 kHz bandwidth from band edge.

11.5.3. The band edges was measured and recorded.

11.6. Test Result

Note: Both hopping-on mode and hopping-off mode had been pre-tested, and only the Worse case was recorded in the test report.

Conducted Band Edge Result

Non-hopping mode

Frequency (MHz)	Result of Band Edge (dBc)	Limit of Band Edge (dBc)	Result
GFSK Mode			
2400.00	39.07	> 20dBc	Pass
2483.50	43.39	> 20dBc	Pass
Π/4-DQPSK Mode			
2400.00	38.35	> 20dBc	Pass
2483.50	43.71	> 20dBc	Pass
8DPSK Mode			
2400.00	38.57	> 20dBc	Pass
2483.50	42.72	> 20dBc	Pass

The spectrum analyzer plots are attached as below.

GFSK Mode

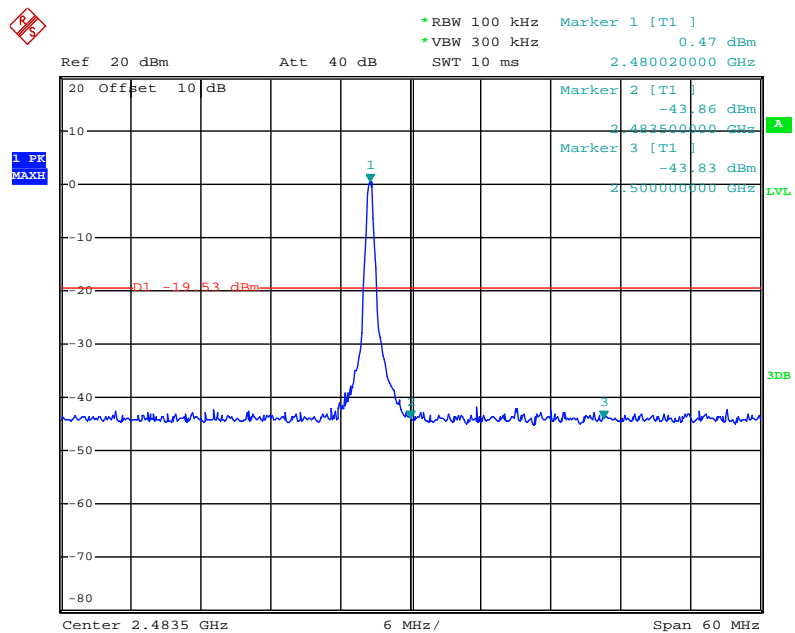
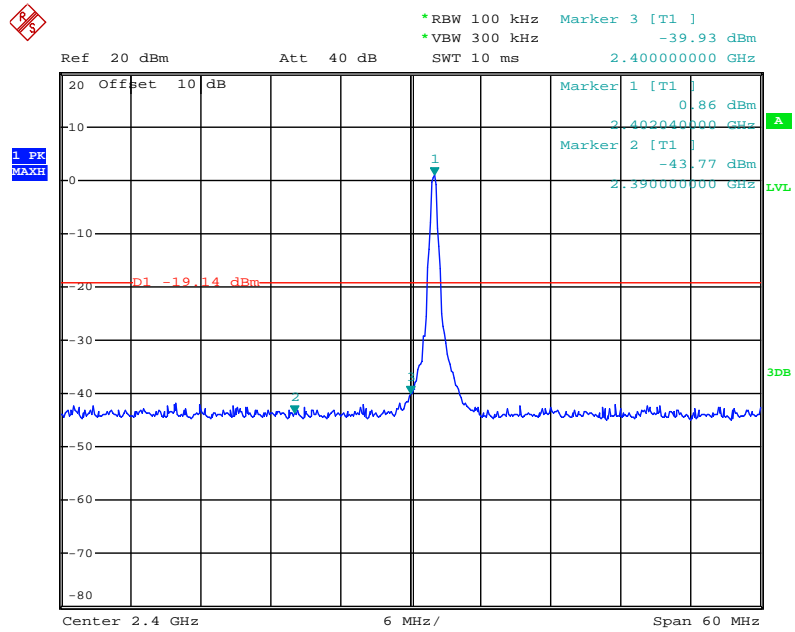

Π/4-DQPSK Mode

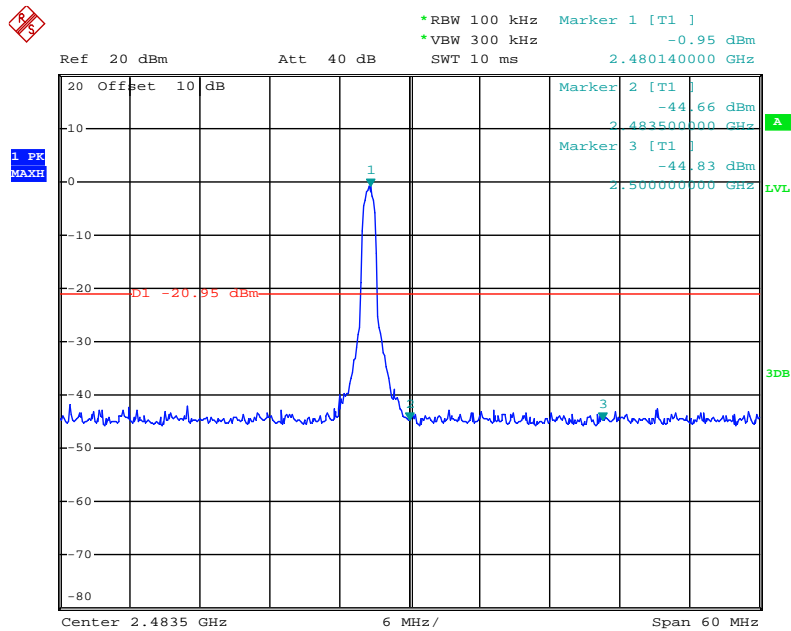
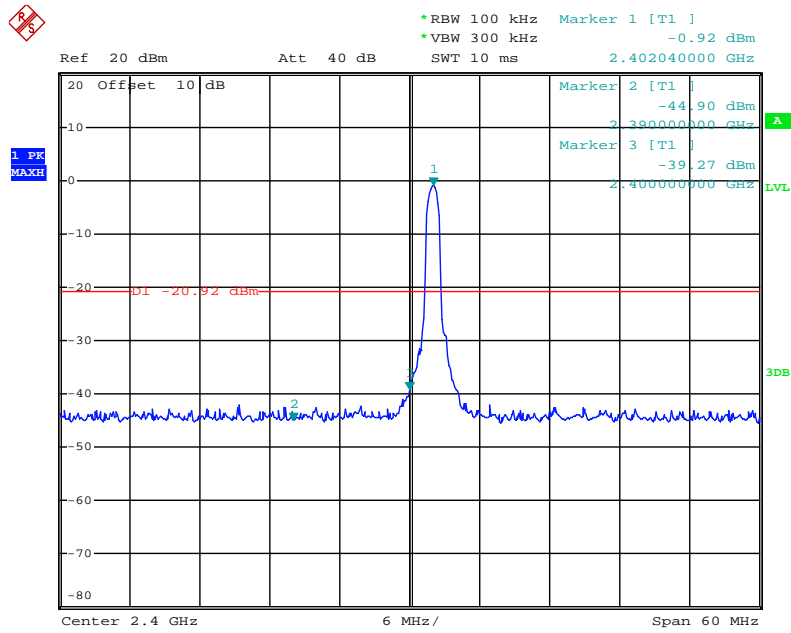

8DPSK Mode

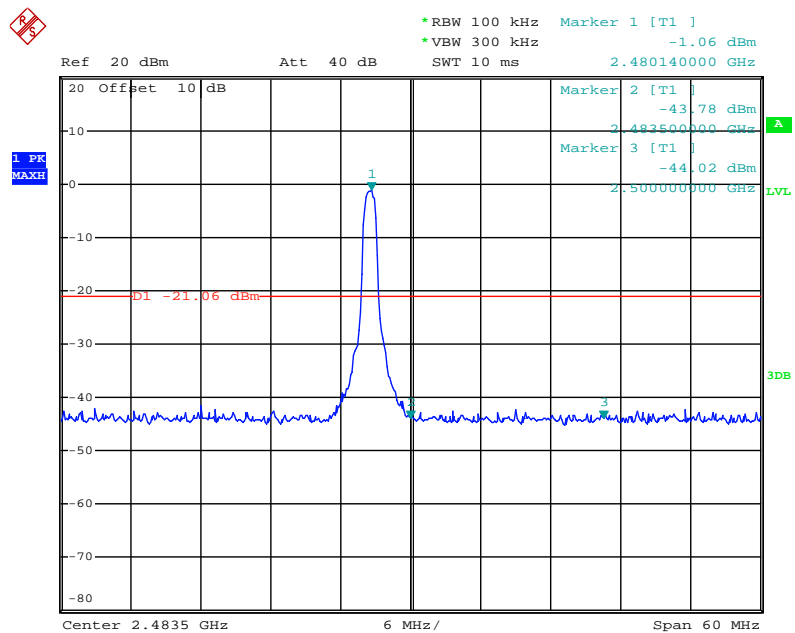
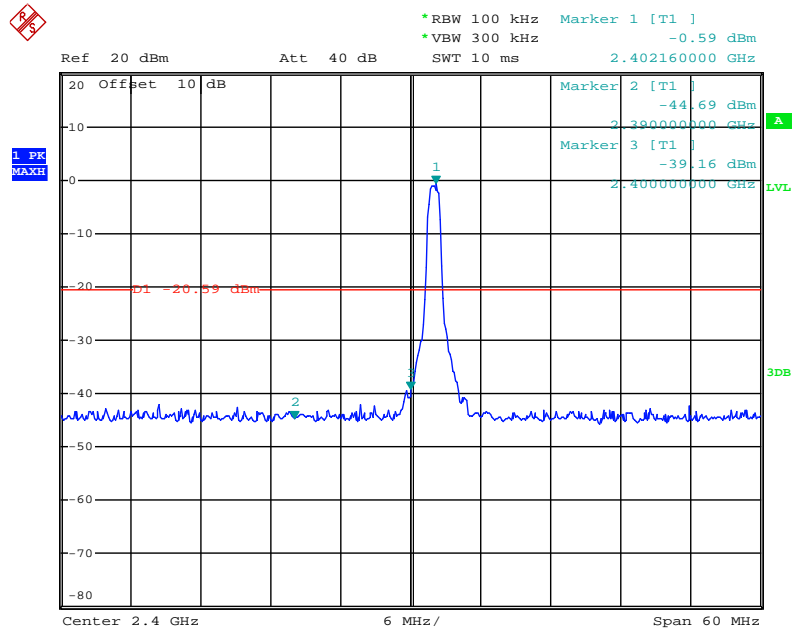

Radiated Band Edge Result

Note:

1. Emissions attenuated more than 20 dB below the permissible value are not reported.
2. The field strength is calculated by adding the antenna factor, high pass filter loss(if used) and cable loss, and subtracting the amplifier gain(if any)from the measured reading. The basic equation calculation is as follows:

Result = Reading + Corrected Factor

3. Display the measurement of peak values.

Test Procedure:

The EUT and its simulators are placed on a turntable, which is 0.1 meter high above ground. The turntable can rotate 360 degrees to determine the position of the maximum emission level. EUT is set 3.0 meters away from the receiving antenna, which is mounted on an antenna tower. The antenna can be moved up and down between 1.0 meter and 4 meters to find out the maximum emission level. Broadband antenna (calibrated bi-log antenna) is used as receiving antenna. Both horizontal and vertical polarizations of the antenna are set on measurement. In order to find the maximum emission levels, all of the EUT location must be manipulated according to ANSI C63.10:2013 on radiated emission measurement. This EUT was tested in 3 orthogonal positions and the Worse case position data was reported.

Let the EUT work in TX (Hopping off, Hopping on) modes measure it.
We select 2402MHz, 2480MHz TX frequency to transmit(Hopping off mode).
We select 2402-2480MHz TX frequency to transmit(Hopping on mode).

During the radiated emission test, the spectrum analyzer was set with the following configurations:

- 1.The resolution bandwidth of test receiver/spectrum analyzer is 1MHz and video bandwidth is 3MHz for peak measurement with peak detector at frequency above 1GHz.
- 2.The resolution bandwidth of test receiver/spectrum analyzer is 1MHz and video bandwidth is 10Hz for Average measurement with peak detection at frequency above 1GHz.
- 3.All modes of operation were investigated and the Worse case (GFSK mode) emissions are reported.

The spectrum analyzer plots are attached as below.

Non-hopping mode



ACCURATE TECHNOLOGY CO., LTD.

F1,Bldg,A,Changyuan New Material Port Keyuan Rd,
Science & Industry Park,Nanshan Shenzhen,P.R.China

Site: 1# Chamber
Tel:+86-0755-26503290
Fax:+86-0755-26503396

Job No.: MFL #36	Polarization: Vertical
Standard: FCC PK	Power Source: AC 120V/60Hz
Test item: Radiation Test	Date: 19/10/23/
Temp.(C)/Hum.(%) 25 C / 55 %	Time: 9/54/59
EUT: Massage Chair	Engineer Signature:
Mode: TX2402MHz(GFSK)	Distance: 3m
Model: EC-7502A	
Manufacturer: XIAMEN HEALTHCARE ELECTRONIC CO.,LTD	

Note: Report NO.:ATE20191491

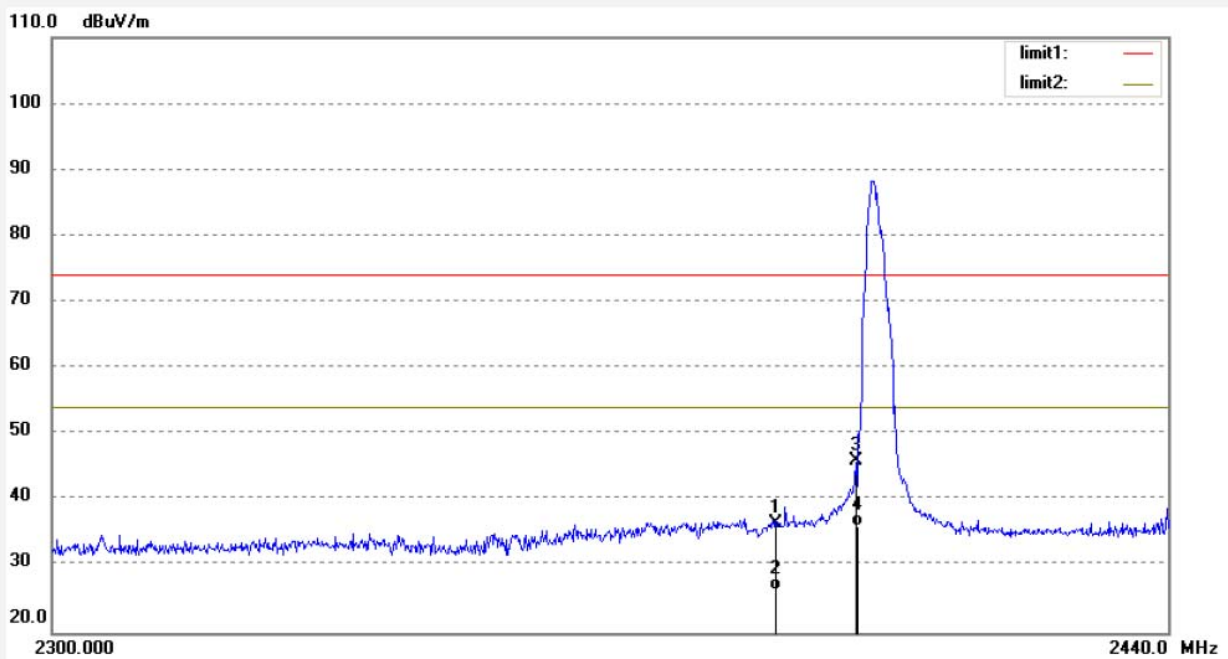

No.	Freq. (MHz)	Reading (dBuV/m)	Factor (dB)	Result (dBuV/m)	Limit (dBuV/m)	Margin (dB)	Detector	Height (cm)	Degree (deg.)	Remark
1	2390.000	42.78	-6.32	36.46	74.00	-37.54	peak	150	151	
2	2390.000	32.67	-6.32	26.35	54.00	-27.65	AVG	150	321	
3	2400.000	52.25	-6.27	45.98	74.00	-28.02	peak	150	45	
4	2400.000	42.42	-6.27	36.15	54.00	-17.85	AVG	150	103	

Note: Average measurement with peak detection at No.2&4



ACCURATE TECHNOLOGY CO., LTD.

F1,Bldg,A,Changyuan New Material Port Keyuan Rd,
Science & Industry Park,Nanshan Shenzhen,P.R.China

Site: 1# Chamber
Tel:+86-0755-26503290
Fax:+86-0755-26503396

Job No.: MFL #35	Polarization: Horizontal
Standard: FCC PK	Power Source: AC 120V/60Hz
Test item: Radiation Test	Date: 19/10/23/
Temp.(C)/Hum.(%) 25 C / 55 %	Time: 9/53/24
EUT: Massage Chair	Engineer Signature:
Mode: TX2402MHz(GFSK)	Distance: 3m
Model: EC-7502A	
Manufacturer: XIAMEN HEALTHCARE ELECTRONIC CO.,LTD	

Note: Report NO.:ATE20191491

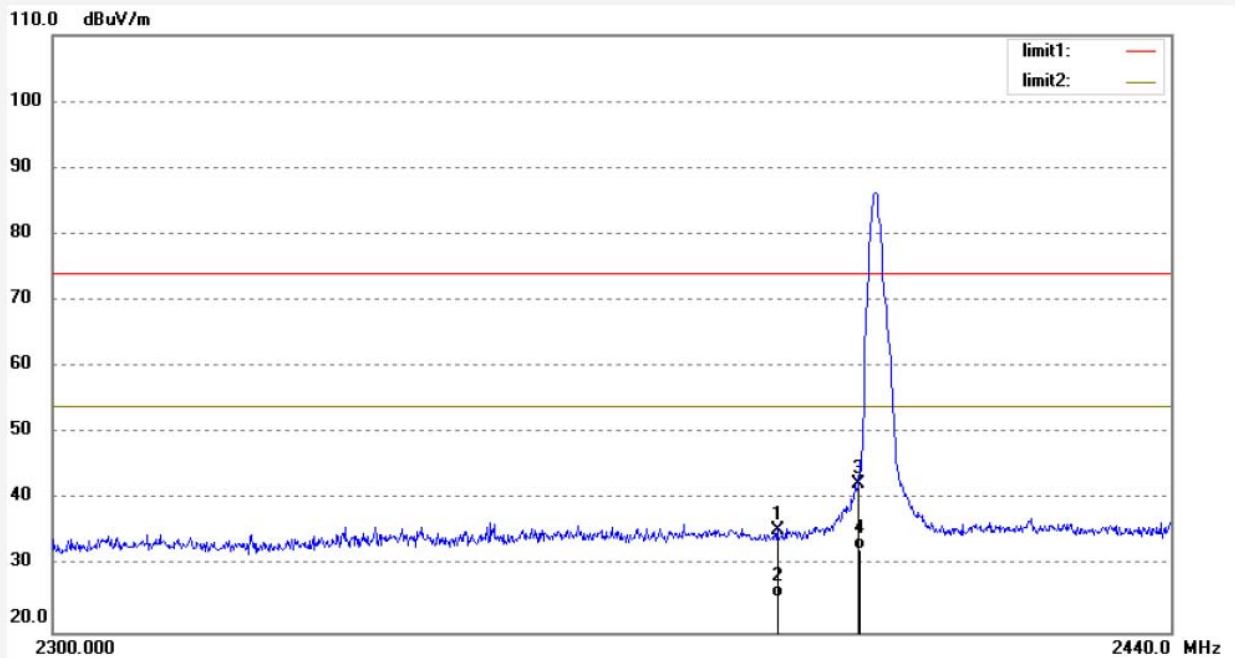

No.	Freq. (MHz)	Reading (dBuV/m)	Factor (dB)	Result (dBuV/m)	Limit (dBuV/m)	Margin (dB)	Detector	Height (cm)	Degree (deg.)	Remark
1	2390.000	41.73	-6.32	35.41	74.00	-38.59	peak	200	105	
2	2390.000	31.68	-6.32	25.36	54.00	-28.64	AVG	200	321	
3	2400.000	48.57	-6.27	42.30	74.00	-31.70	peak	200	208	
4	2400.000	38.82	-6.27	32.55	54.00	-21.45	AVG	200	37	

Note: Average measurement with peak detection at No.2&4



ACCURATE TECHNOLOGY CO., LTD.

F1,Bldg,A,Changyuan New Material Port Keyuan Rd,
Science & Industry Park,Nanshan Shenzhen,P.R.China

Site: 1# Chamber
Tel:+86-0755-26503290
Fax:+86-0755-26503396

Job No.: MFL #25	Polarization: Vertical
Standard: FCC PK	Power Source: AC 120V/60Hz
Test item: Radiation Test	Date: 19/10/23/
Temp.(C)/Hum.(%) 25 C / 55 %	Time: 9/36/59
EUT: Massage Chair	Engineer Signature:
Mode: TX2480MHz(GSKF)	Distance: 3m
Model: EC-7502A	
Manufacturer: XIAMEN HEALTHCARE ELECTRONIC CO.,LTD	

Note: Report NO.:ATE20191491

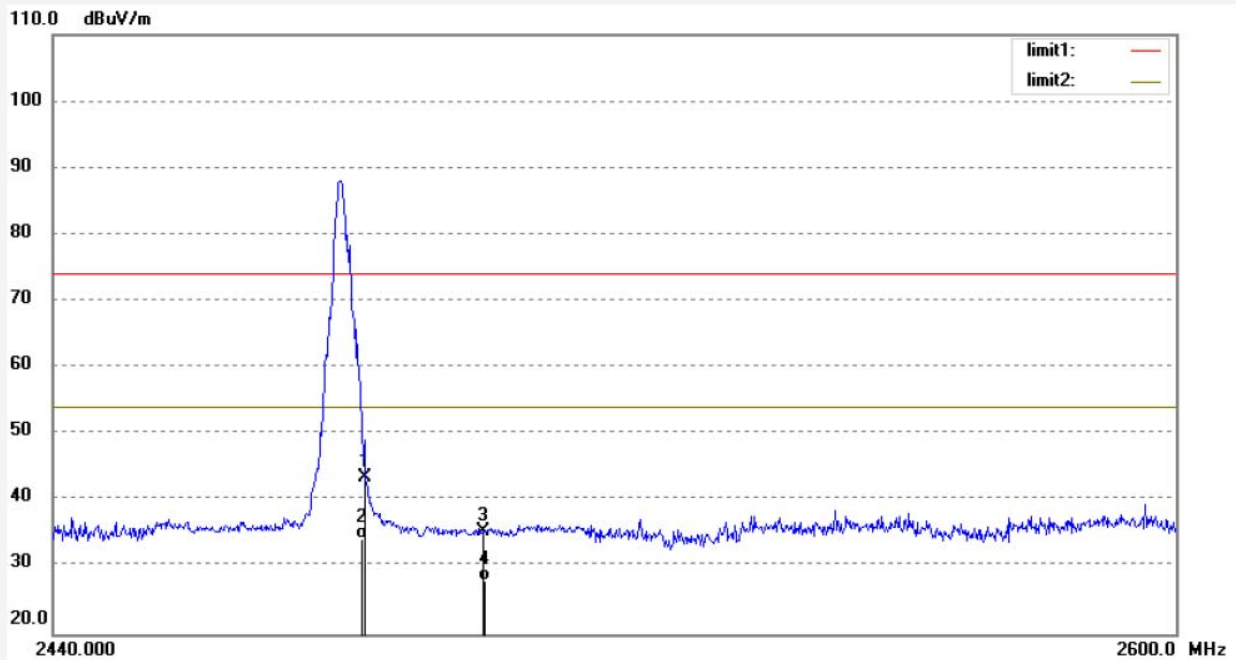

No.	Freq. (MHz)	Reading (dBuV/m)	Factor (dB)	Result (dBuV/m)	Limit (dBuV/m)	Margin (dB)	Detector	Height (cm)	Degree (deg.)	Remark
1	2483.500	49.51	-5.89	43.62	74.00	-30.38	peak	150	103	
2	2483.500	40.21	-5.89	34.32	54.00	-19.68	AVG	150	93	
3	2500.000	41.12	-5.81	35.31	74.00	-38.69	peak	150	125	
4	2500.000	33.84	-5.81	28.03	54.00	-25.97	AVG	150	41	

Note: Average measurement with peak detection at No.2&4



ACCURATE TECHNOLOGY CO., LTD.

F1,Bldg,A,Changyuan New Material Port Keyuan Rd,
Science & Industry Park,Nanshan Shenzhen,P.R.China

Site: 1# Chamber
Tel:+86-0755-26503290
Fax:+86-0755-26503396

Job No.: MFL #26
Standard: FCC PK
Test item: Radiation Test
Temp.(C)/Hum.(%) 25 C / 55 %
EUT: Massage Chair
Mode: TX2480MHz(GSKF)
Model: EC-7502A
Manufacturer: XIAMEN HEALTHCARE ELECTRONIC CO.,LTD

Polarization: Horizontal
Power Source: AC 120V/60Hz
Date: 19/10/23/
Time: 9/38/30
Engineer Signature:
Distance: 3m

Note: Report NO.:ATE20191491

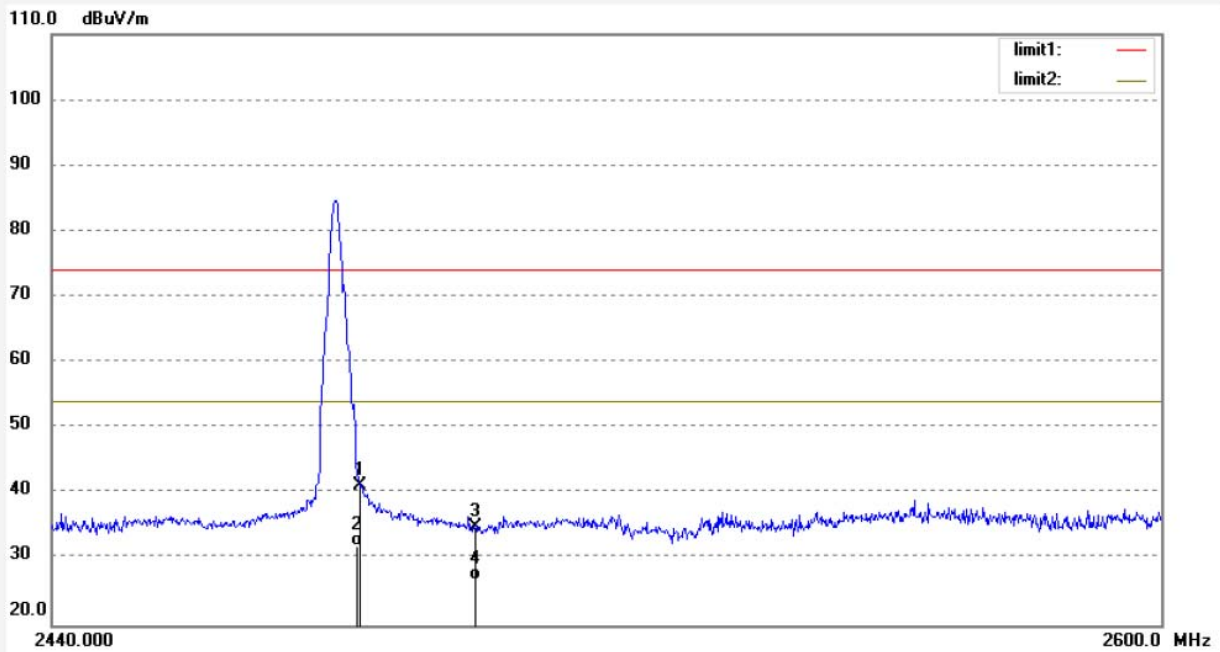

No.	Freq. (MHz)	Reading (dBuV/m)	Factor (dB)	Result (dBuV/m)	Limit (dBuV/m)	Margin (dB)	Detector	Height (cm)	Degree (deg.)	Remark
1	2483.500	47.19	-5.89	41.30	74.00	-32.70	peak	200	295	
2	2483.500	37.94	-5.89	32.05	54.00	-21.95	AVG	200	320	
3	2500.000	40.84	-5.81	35.03	74.00	-38.97	peak	200	109	
4	2500.000	32.75	-5.81	26.94	54.00	-27.06	AVG	200	124	

Note: Average measurement with peak detection at No.2&4

Hopping mode



ACCURATE TECHNOLOGY CO., LTD.

F1,Bldg.A,Changyuan New Material Port Keyuan Rd,
Science & Industry Park,Nanshan Shenzhen,P.R.China

Site: 1# Chamber
Tel:+86-0755-26503290
Fax:+86-0755-26503396

Job No.: MFL #37	Polarization: Vertical
Standard: FCC PK	Power Source: AC 120V/60Hz
Test item: Radiation Test	Date: 19/10/23/
Temp.(C)/Hum.(%) 25 C / 55 %	Time: 9/59/13
EUT: Massage Chair	Engineer Signature:
Mode: HOPPING(GFSK)	Distance: 3m
Model: EC-7502A	
Manufacturer: XIAMEN HEALTHCARE ELECTRONIC CO.,LTD	

Note: Report NO.:ATE20191491

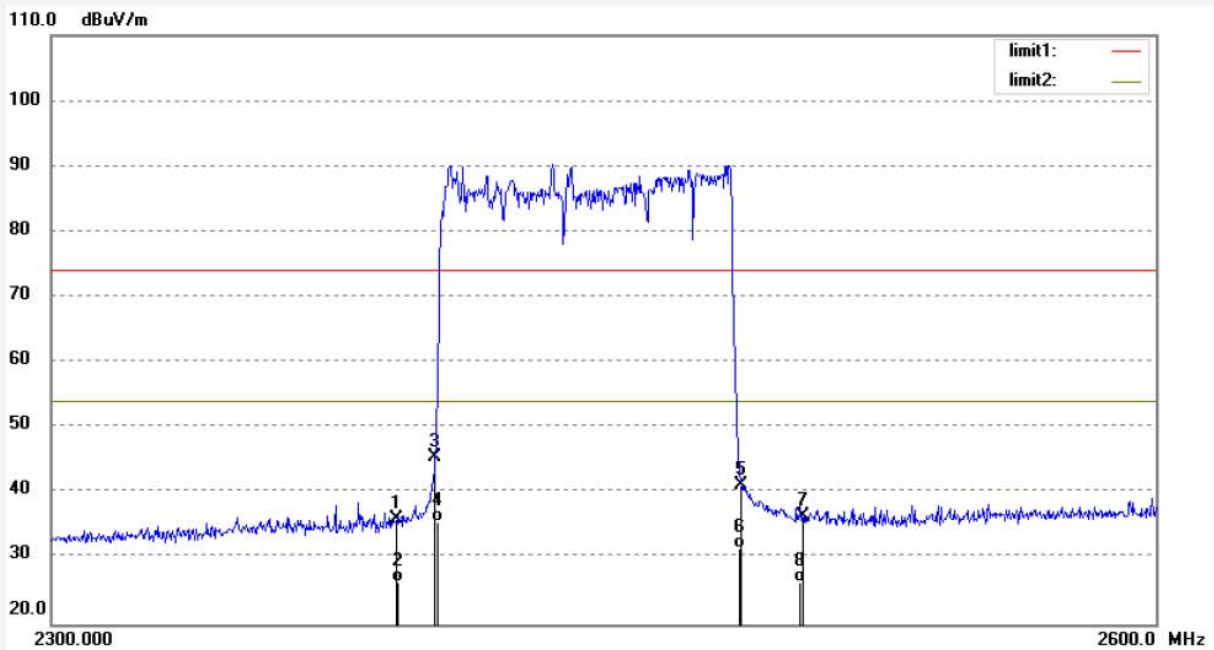

No.	Freq. (MHz)	Reading (dBuV/m)	Factor (dB)	Result (dBuV/m)	Limit (dBuV/m)	Margin (dB)	Detector	Height (cm)	Degree (deg.)	Remark
1	2390.000	42.44	-6.32	36.12	74.00	-37.88	peak	150	193	
2	2390.000	32.63	-6.32	26.31	54.00	-27.69	AVG	150	221	
3	2400.000	51.91	-6.27	45.64	74.00	-28.36	peak	150	82	
4	2400.000	41.96	-6.27	35.69	54.00	-18.31	AVG	150	211	
5	2483.500	47.21	-5.89	41.32	74.00	-32.68	peak	150	301	
6	2483.500	37.47	-5.89	31.58	54.00	-22.42	AVG	150	109	
7	2500.000	42.26	-5.81	36.45	74.00	-37.55	peak	150	63	
8	2500.000	32.15	-5.81	26.34	54.00	-27.66	AVG	150	118	

Note: Average measurement with peak detection at No.2&4&6&8



ACCURATE TECHNOLOGY CO., LTD.

F1,Bldg,A,Changyuan New Material Port Keyuan Rd,
Science & Industry Park,Nanshan Shenzhen,P.R.China

Site: 1# Chamber
Tel:+86-0755-26503290
Fax:+86-0755-26503396

Job No.: MFL #38	Polarization: Horizontal
Standard: FCC PK	Power Source: AC 120V/60Hz
Test item: Radiation Test	Date: 19/10/23/
Temp.(C)/Hum.(%) 25 C / 55 %	Time: 10/01/54
EUT: Massage Chair	Engineer Signature:
Mode: HOPPING(GFSK)	Distance: 3m
Model: EC-7502A	
Manufacturer: XIAMEN HEALTHCARE ELECTRONIC CO.,LTD	

Note: Report NO.:ATE20191491

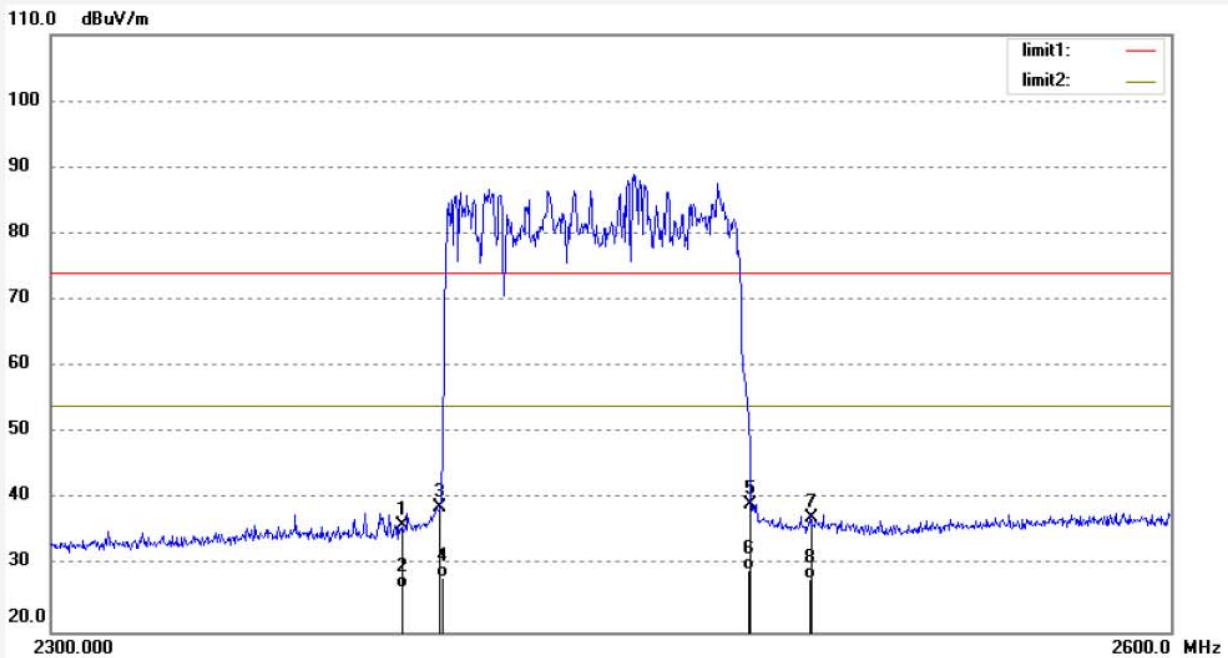

No.	Freq. (MHz)	Reading (dBuV/m)	Factor (dB)	Result (dBuV/m)	Limit (dBuV/m)	Margin (dB)	Detector	Height (cm)	Degree (deg.)	Remark
1	2390.000	42.47	-6.32	36.15	74.00	-37.85	peak	200	341	
2	2390.000	32.96	-6.32	26.64	54.00	-27.36	AVG	200	254	
3	2400.000	44.96	-6.27	38.69	74.00	-35.31	peak	200	214	
4	2400.000	34.59	-6.27	28.32	54.00	-25.68	AVG	200	320	
5	2483.500	45.10	-5.89	39.21	74.00	-34.79	peak	200	102	
6	2483.500	35.29	-5.89	29.40	54.00	-24.60	AVG	200	38	
7	2500.000	43.06	-5.81	37.25	74.00	-36.75	peak	200	221	
8	2500.000	33.73	-5.81	27.92	54.00	-26.08	AVG	200	128	

Note: Average measurement with peak detection at No.2&4&6&8

12.AC POWER LINE CONDUCTED EMISSION TEST

12.1.Block Diagram of Test Setup

12.1.1.Block diagram of connection between the EUT and simulators

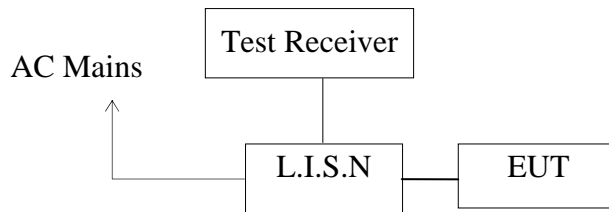

12.1.2.Test System Setup

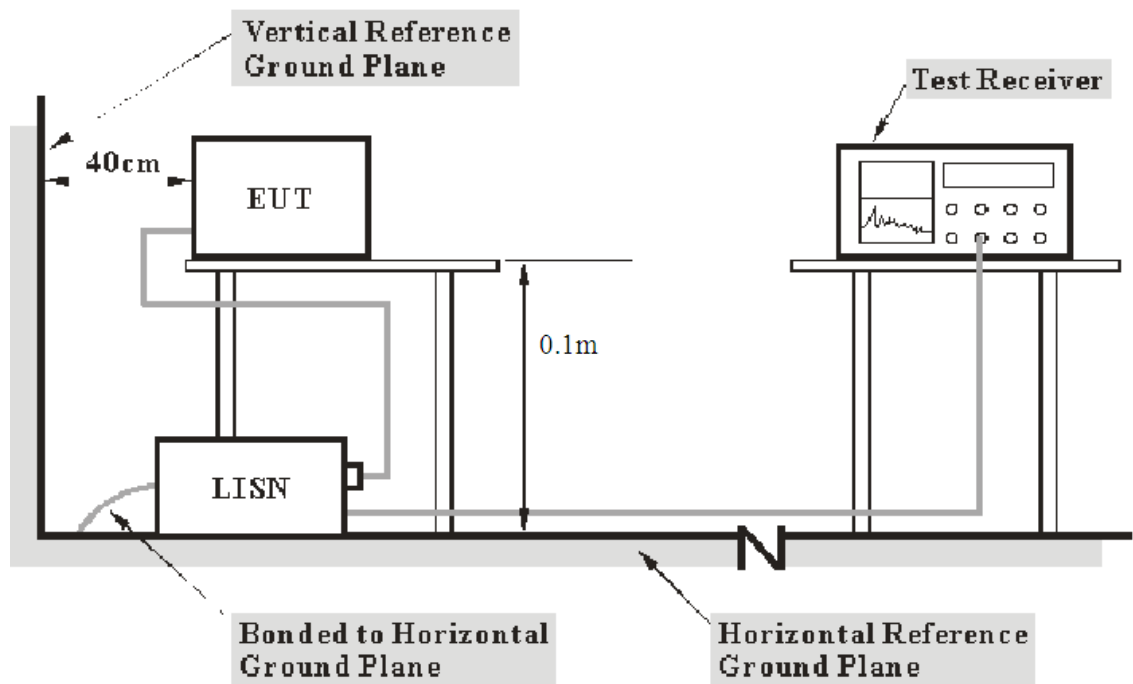

- Note: 1. Support units were connected to second LISN.
2. Both of LISNs (AMN) 80 cm from EUT and at the least 0.1m from other units and other metal planes support units.

12.2.Power Line Conducted Emission Test Limits

Frequency (MHz)	Conducted Limit dB(μV)	
	Quasi-peak Level	Average Level
0.15 - 0.50	66.0 – 56.0 *	56.0 – 46.0 *
0.50 - 5.00	56.0	46.0
5.00 - 30.00	60.0	50.0

NOTE1: The lower limit shall apply at the transition frequencies.
 NOTE2: The limit decreases linearly with the logarithm of the frequency in the range 0.15MHz to 0.50MHz.

12.3.EUT Configuration on Test

The equipments are installed on Power Line Conducted Emission Measurement to meet the commission requirement and operating regulations in a manner, which tends to maximize its emission characteristics in a normal application.

12.4.Operating Condition of EUT

12.4.1.Setup the EUT and simulator as shown as Section 12.1.

12.4.2.Turn on the power of all equipment.

12.4.3.Let the EUT work in test mode and measure it.

12.5.Test Procedure

The EUT is put on the plane 0.1m high above the ground by insulating support and is connected to the power mains through a line impedance stabilization network (L.I.S.N.). This provides a 50ohm coupling impedance for the EUT system. Please refer the block diagram of the test setup and photographs. Both sides of AC lines are checked to find out the maximum conducted emission. In order to find the maximum emission levels, the relative positions of equipment and all of the interface cables shall be changed according to ANSI C63.10: 2013 on Conducted Emission Measurement. The bandwidth of test receiver (R & S ESCS30) is set at 9kHz.

The frequency range from 150kHz to 30MHz is checked.

12.6.Data Sample

Frequency (MHz)	Transducer value (dB)	QuasiPeak Level (dBμV)	Average Level (dBμV)	QuasiPeak Limit (dBμV)	Average Limit (dBμV)	QuasiPeak Margin (dB)	Average Margin (dB)	Remark (Pass/Fail)
X.XX	10.5	51.1	34.2	56.0	46.0	4.9	11.8	Pass

Frequency(MHz) = Emission frequency in MHz

Transducer value(dB) = Insertion loss of LISN + Cable Loss

Level(dBμV) = Quasi-peak Reading/Average Reading + Transducer value

Limit (dBμV) = Limit stated in standard

Margin = Limit (dBμV) - Level (dBμV)

Calculation Formula:

Margin = Limit (dBμV) - Level (dBμV)

12.7.Test Results

Pass.

The frequency range from 150kHz to 30MHz is checked.

Maximizing procedure was performed on the six (6) highest emissions of the EUT. Emissions attenuated more than 20 dB below the permissible value are not reported.

All data was recorded in the Quasi-peak and average detection mode.

The spectral diagrams are attached as below.

ACCURATE TECHNOLOGY CO., LTD

CONDUCTED EMISSION STANDARD FCC PART 15B

EUT: Massage Chair M/N:EC-7502A
 Manufacturer: XIAMEN HEALTHCARE ELECTRONIC CO.,LTD
 Operating Condition: BT Communication
 Test Site: 2#Shielding Room
 Operator: Frank
 Test Specification: N 120V 60Hz
 Comment: Report NO.:ATE20191491
 Start of Test: 2019-10-12 / 17:24:12

SCAN TABLE: "V 150K-30MHz fin"

Short Description: _SUB_STD_VTERM2 1.70
 Start Stop Step Detector Meas. IF Transducer
 Frequency Frequency Width Time Bandw.
 150.0 kHz 30.0 MHz 4.5 kHz QuasiPeak 1.0 s 9 kHz NSLK8126 2008
 Average

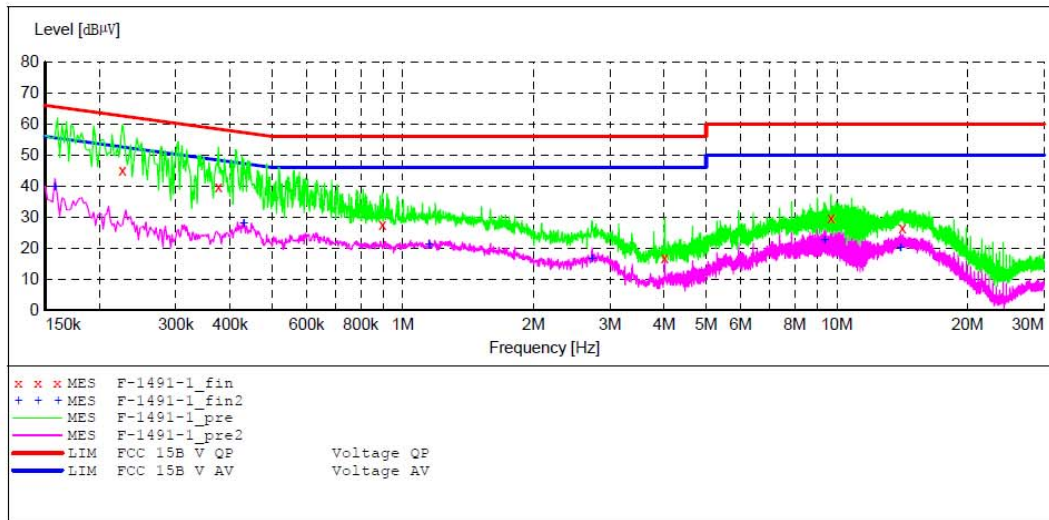

MEASUREMENT RESULT: "F-1491-1_fin"

2019-10-12 17:25

Frequency MHz	Level dBµV	Transd dB	Limit dBµV	Margin dB	Detector	Line	PE
0.226000	45.30	10.8	63	17.3	QP	N	GND
0.376000	39.90	10.9	58	18.5	QP	N	GND
0.898000	27.60	11.1	56	28.4	QP	N	GND
4.010000	16.80	11.4	56	39.2	QP	N	GND
9.695000	29.90	11.6	60	30.1	QP	N	GND
14.155000	26.70	11.6	60	33.3	QP	N	GND

MEASUREMENT RESULT: "F-1491-1_fin2"

2019-10-12 17:25

Frequency MHz	Level dBµV	Transd dB	Limit dBµV	Margin dB	Detector	Line	PE
0.158000	39.70	10.8	56	15.9	AV	N	GND
0.430000	28.00	11.0	47	19.3	AV	N	GND
1.150000	21.40	11.2	46	24.6	AV	N	GND
2.730000	16.70	11.3	46	29.3	AV	N	GND
9.360000	22.70	11.6	50	27.3	AV	N	GND
14.010000	20.30	11.6	50	29.7	AV	N	GND

ACCURATE TECHNOLOGY CO., LTD

CONDUCTED EMISSION STANDARD FCC PART 15B

EUT: Message Chair M/N:EC-7502A
 Manufacturer: XIAMEN HEALTHCARE ELECTRONIC CO.,LTD
 Operating Condition: BT Communication
 Test Site: 2#Shielding Room
 Operator: Frank
 Test Specification: L 120V 60Hz
 Comment: Report NO.:ATE20191491
 Start of Test: 2019-10-12 / 17:26:31

SCAN TABLE: "V 150K-30MHz fin"

Short Description: _SUB_STD_VTERM2 1.70
 Start Stop Step Detector Meas. IF Transducer
 Frequency Frequency Width Time Bandw.
 150.0 kHz 30.0 MHz 4.5 kHz QuasiPeak 1.0 s 9 kHz NSLK8126 2008
 Average

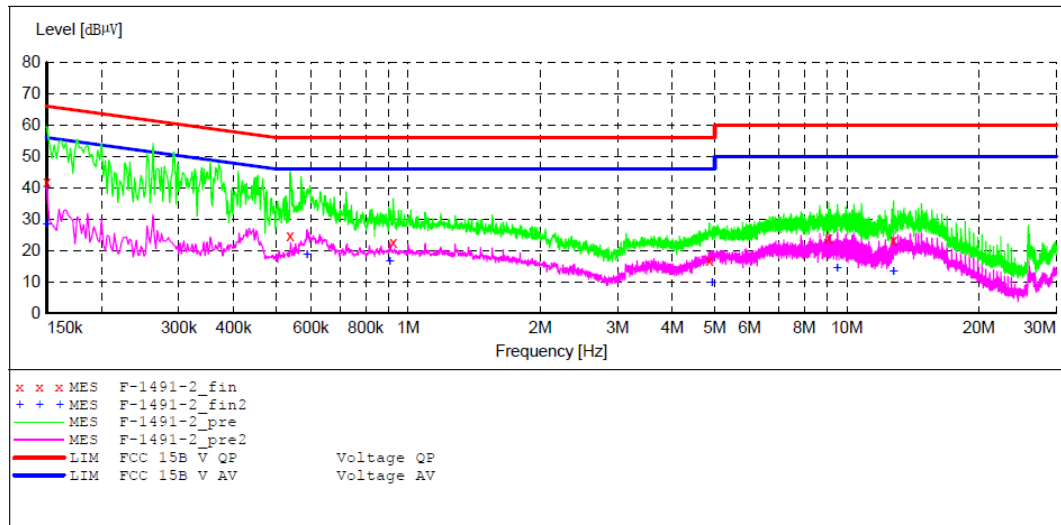

MEASUREMENT RESULT: "F-1491-2_fin"

2019-10-12 17:29

Frequency MHz	Level dBµV	Transd dB	Limit dBµV	Margin dB	Detector	Line	PE
0.150000	41.80	10.8	66	24.2	QP	L1	GND
0.538000	24.80	11.0	56	31.2	QP	L1	GND
0.924000	22.60	11.1	56	33.4	QP	L1	GND
4.865000	17.10	11.4	56	38.9	QP	L1	GND
9.095000	24.00	11.6	60	36.0	QP	L1	GND
12.785000	23.40	11.6	60	36.6	QP	L1	GND

MEASUREMENT RESULT: "F-1491-2_fin2"

2019-10-12 17:29

Frequency MHz	Level dBµV	Transd dB	Limit dBµV	Margin dB	Detector	Line	PE
0.150000	28.40	10.8	56	27.6	AV	L1	GND
0.588000	18.80	11.0	46	27.2	AV	L1	GND
0.908000	16.60	11.1	46	29.4	AV	L1	GND
4.930000	9.70	11.4	46	36.3	AV	L1	GND
9.520000	14.60	11.6	50	35.4	AV	L1	GND
12.780000	13.50	11.6	50	36.5	AV	L1	GND

13.ANTENNA REQUIREMENT

13.1.The Requirement

According to Section 15.203, an intentional radiator shall be designed to ensure that no antenna other than that furnished by the responsible party shall be used with the device.

13.2.Antenna Construction

Device is equipped with permanent attached antenna, which isn't displaced by other antenna. The Max Antenna gain of EUT is 2.0dBi. Therefore, the equipment complies with the antenna requirement of Section 15.203.

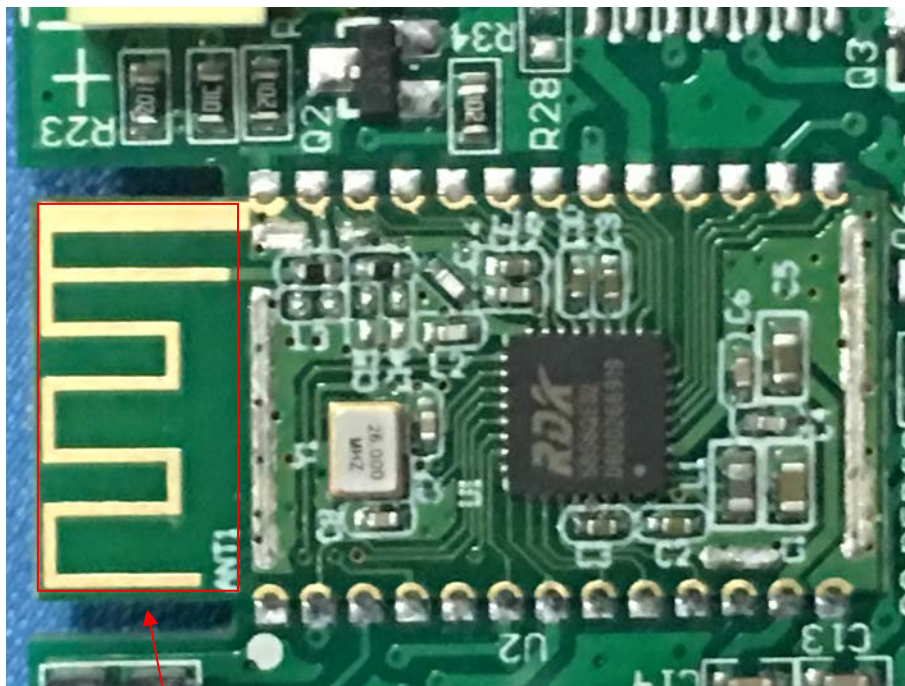

Antenna

***** End of Test Report *****