







Hello.

Congratulations on purchasing your new Cozzia CZ-640.

At Cozzia we understand that every body is different and have carefully designed your massage chair with that in mind. But enough about us, this is about you. Learning how to use your new chair is simple (we designed it that way).

So let's get started.

TABLE OF CONTENTS

 INTRO	Safety	2-3
	Grounding Instruction	4
	Dimensions	5
	Contents	6
 CHAIR	Move & Clearance	7
	Components	8
	Massage Points	9
	Specification	10
 MASSAGE	Interface	11-14
	Pre-Programmed Massage	15-19
	Demo	20-21
	Custom Massage	22-26
	Spot Massage	27-29
	Settings	30-31
	Trouble Shooting	32-35
Pre-Programmed Description	36-38	
 CARE	Care and Storage	39
	Warranty	39-40

SAFETY PRECAUTIONS

We're looking out for you.

IMPORTANT SAFETY INSTRUCTIONS

When using the massage chair, basic precautions should always be followed, including the following:
Read all instructions before using this massage chair.

DANGER—To reduce the risk of electric shock:

- Always unplug this massage chair from the electrical outlet immediately after using and before cleaning.
- Never use pins or other metallic fasteners with this appliance.
- Carefully examine the covering before each use. Call for service if the covering shows any sign of deterioration, such as blistering, peeling or cracking.
- Keep dry—Do not operate in a wet or moist condition.

WARNING—To reduce the risks of burns, fire, electric shock or injury to persons:

- Read all instructions before using.
- A massage chair should never be left unattended when plugged in. Unplug from the outlet when it is not in use and before putting on or taking off parts.
- Close supervision is necessary when this massage chair is used by or near children or disabled persons. Keep children away from reclining backrest and extended leg rest.
- Use this massage chair only for its intent use as described in this manual.
- Never operate this massage chair if it has a damaged cord or plug, if it is not working properly, if it has been dropped or damaged, or dropped into water. Contact Customer Service Department.
- Keep the cord away from heated surfaces.
- Never operate the massage chair with the air openings blocked. Keep the air openings free of lint, hair and the like.
- Never drop or insert any object into any opening.
- Do not use outdoor.
- Do not operate where aerosol (spray) products are being used or where oxygen is being administered.
- To disconnect, turn all controls to the off position, then remove the plug from the outlet.
- Do not stand on or in the massage chair. Use only while seated.
- The product is not intended for use by children or persons with reduced physical, sensory or mental capabilities, or lack of experience and knowledge, unless they have been given supervision or instruction concerning use of the product by a person responsible for their safety.
- Children should be supervised to ensure that they do not play with the product.
- Temperatures sufficiently high to cause burns may occur regardless of the control setting. Do not use on an infant or invalid or on a sleeping or unconscious person. Check the skin in contact with the heated area of the appliance frequently to reduce the risk of blistering.
- Burns may result from improper use.
- Do not crush in order to avoid sharp folds.
- Keep children away from extended foot support (or other similar parts).
- DO NOT WET.
- DO NOT USE PINS.

- NEVER REMOVE COVER.
- Connect this appliance to a properly grounded outlet only. See Grounding Instructions.

SAVE THESE INSTRUCTIONS

This massage chair is intended for household use only.

1. Usage Environment

- Do not use the massage chair in an excessively humid or dusty environment as this may result in malfunction or electric shock.
- Do not use the massage chair in a room with a temperature of 104°F or higher.
- Do not expose the massage chair to heaters, stoves or direct sunlight.
- Place and use the massage chair on an even, non-slip floor.
- The massage chair is designed for home use and not for commercial purposes.



Caution

- This massage chair is to be used indoors only.
- If you use the massage chair in a cold room, do not increase the room temperature abruptly. It is recommended that you increase the temperature gradually to a normal level.
- If the massage chair is stored in a cold place and is being brought into a warm environment, it is advisable to wait for one hour before use. This is because its performance may not be at optimum level, as there may be water droplets on the mechanical parts due to condensation. Using the massage chair under such conditions may result in malfunction.

2. Safety Precautions

- To ensure safe and correct use of the massage chair, do not operate it without reading this operation manual carefully.
- Do not use the massage chair when the upholstery or seat is removed. This may cause injury or malfunction.
- Do not use the massage chair in combination with other therapeutic equipment or electric blanket etc., as this may result in ineffectiveness or injury.
- Do not use the massage chair an hour before or after eating as this may have adverse effects on the user.
- Do not allow children or pets to play around the massage chair, e.g. behind the backrest, under the seat base or legrest of the massage chair. This may result in injury.
- Do not use the massage chair when your body is wet.
- Do not operate the massage chair with wet hands.
- It is not recommended to use the massage chair for more than 30 minutes.
- Do not perform continuous massage on the same spot of your body for more than 5 minutes at a time as this may result in excessive stimulation and may have adverse effects.
- Do not insert your hand or foot along the paths of the massage rollers during use as this may cause injury.

- Stop operation immediately if you feel any discomfort.
- This product is not intended for self-treatment of conditions that should be managed by a qualified health care provider.
- People on medication or with medical conditions, please consult your doctor before use. Please do not use the product if you are not feeling well.

3. People with Medical Conditions

Consult your doctor before use if you:

- are under medical rest as ordered by a doctor.
- have spinal disorders, an abnormal spinal condition or have suffered a spinal injury.
- have back problems.
- have diabetes, osteoporosis or sensory impairment.
- have joint dysfunction such as rheumatism, hammertoe or gout.
- have a pacemaker or other electronic medical devices.
- may be pregnant.
- have phlebitis or thrombosis.
- have an increased risk for blood clots.
- had recent surgery.
- Have surgical pins, screws, or anything mechanical in the legs, ankles or feet.



Caution

- This massage chair is not intended for use by children or persons with reduced physical, sensory or mental capabilities, or lack of experience and knowledge, unless they have been given supervision or instruction or instruction concerning use of the massage chair by a person responsible for their safety.
- Children should be supervised to ensure that they do not play with the massage chair.
- Avoid using the massage chair under the influence of alcohol.
- Do not apply massage rollers directly on the head, elbow or knee joints, torso or abdomen.
- If your legs or feet slip off the leg rest during massage, do not force them back in as this may result in injury.
- Remove the power plug from the electrical outlet immediately should liquid be accidentally spilled onto the massage chair. Do not use wet hands to connect or disconnect the power plug from the electrical outlet.
- Do not tamper with the power cord or use the massage with a damaged cord as this may result in malfunction and electric shock.

4. Instances When the Massage Chair Should Not Be Used

In the following events, please switch off the main power switch immediately and disconnect the power cord from the electrical outlet:

- If liquid is accidentally spilled onto the massage chair. This may result in electric shock or malfunction.
- If the fabric of the backrest is torn and the internal components are exposed.
- If pain or discomfort is felt during massage, stop operation immediately and consult your doctor.
- If you detect any malfunction or any other abnormal condition during operation.
- If there is power failure. Injury may occur when power is restored unexpectedly.
- If there is lightning.

5. Assembly and Repair of the Massage Chair

- Do not disassemble the backrest cover of the massage chair. Touching the internal components may result in malfunction or electrical shock.
- This massage chair must only be professionally serviced or repaired. Do not attempt to disassemble or repair the massage chair by yourself.

6. Things to Be Noted About the Power Plug and Cord

- Check that the Alternating Current (AC) voltage corresponds with the specifications indicated for the massage chair.
- Do not connect or disconnect the power plug from the electrical outlet with wet hands. This may result in malfunction or electric shock.
- When disconnecting the power plug, pull it by holding the plug, not the cord.
- Although operation will be stopped automatically by the Auto-Timer function, always remember to switch off the main power after use.
- Do not place the power cord under the massage chair or any other heavy objects.
- Do not wind the power cord around the massage chair as this may damage the cord and result in a fire or electric shock.
- Do not operate the massage with a damaged cord or extension cord.
- Do not use the massage if the electrical outlet is loose.
- If the power cord is damaged, it should be replaced by a qualified technician.

FCC STATEMENT

1. This device complies with Part 15 of the FCC Rules. Operation is subject to the following two conditions:

(1) This device may not cause harmful interference, and

(2) This device must accept any interference received, including interference that may cause undesired operation.

2. Changes or modifications not expressly approved by the party responsible for compliance could void the user's authority to operate the equipment.

This equipment has been tested and found to comply with the limits for a Class B digital device, pursuant to part 15 of the FCC Rules. These limits are designed to provide reasonable protection against harmful interference in a residential installation. This equipment generates, uses and can radiate radio frequency energy and, if not installed and used in accordance with the instructions, may cause harmful interference to radio communications. However, there is no guarantee that interference will not occur in a particular installation. If this equipment does cause harmful interference to radio or television reception, which can be determined by turning the equipment off and on, the user is encouraged to try to correct the interference by one or more of the following measures:

—Reorient or relocate the receiving antenna.

—Increase the separation between the equipment and receiver.

—Connect the equipment into an outlet on a circuit different from that to which the receiver is connected.

FCC Radiation Exposure Statement: (mobile device)

This equipment complies with FCC radiation exposure limits set forth for an uncontrolled environment. In order to avoid the possibility of exceeding the FCC radio frequency exposure limits, Human proximity to the antenna shall not be less than 20cm (8 inches) during normal operation.

GROUNDING INSTRUCTIONS

This product must be grounded. If it should malfunction or break down, grounding provides a path of least resistance for the electric current to reduce the risk of electric shock. This product is equipped with a cord with an equipment-grounding conductor and a grounding plug. The plug must be plugged into an appropriate outlet that is properly installed and grounded in accordance with all local codes and ordinances.

Danger-Improper connection of the equipment-grounding conductor can result in a risk of electric shock. Check with a qualified electrician or service technician if you provided with the product-if it will not fit the outlet, have a proper outlet installed by a qualified electrician.

This product is for use on a nominal 120V circuit and has grounding plug that looks like that plug illustrated below. Make sure that the product is connected to an outlet having the same configuration as the plug. No adapter should be used with this product.

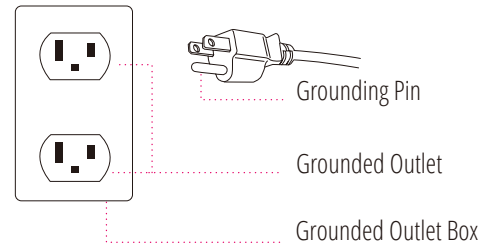

DIMENSIONS

First, let's get your chair inside.

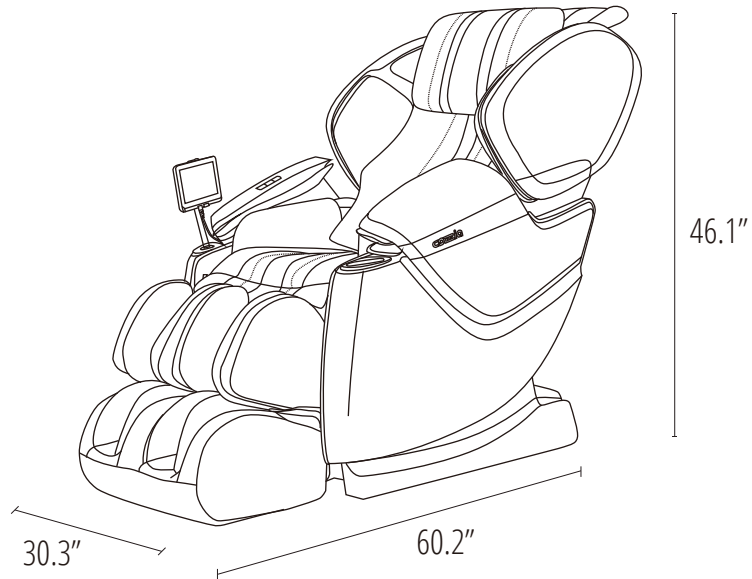

Box 1

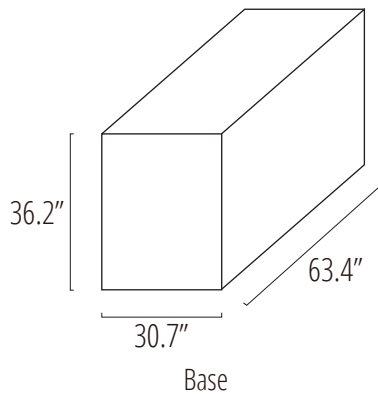

Box 2

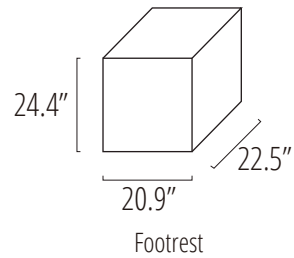

CONTENTS

Everything you need for a relaxing experience.



Installation Manual



Warranty Postcard

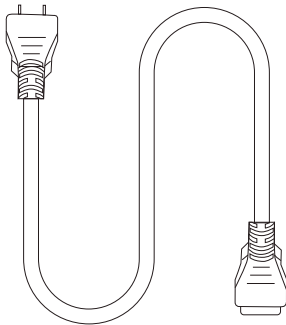

Power Cord

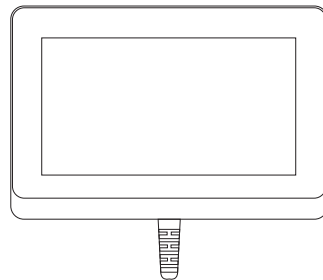

Wired Touch-Pad

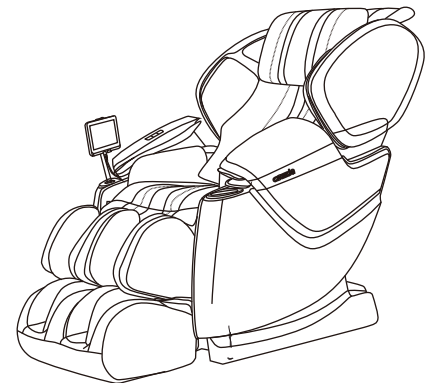

CZ-640 Massage Chair

MOVE & CLEARANCE

A few simple steps to find the best place for your new chair.

HOW TO MOVE

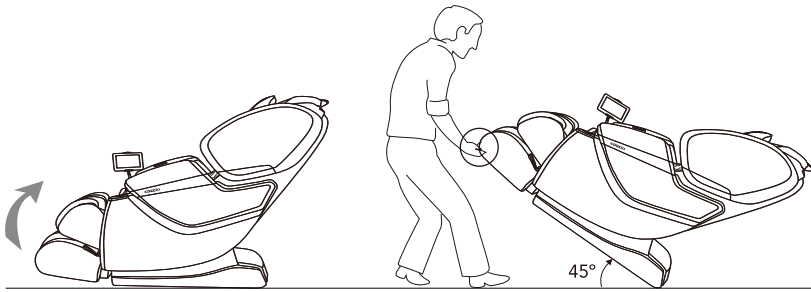

Lift up footrest 45 degrees onto the wheels

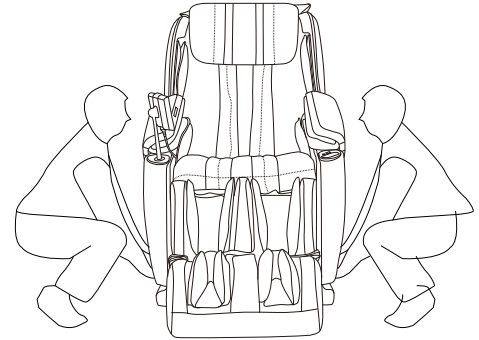

Two people are needed to lift the chair

CLEARANCE

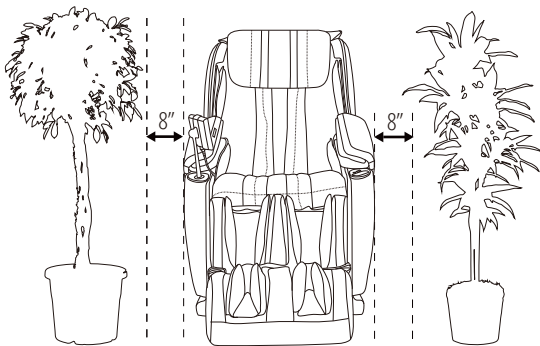

Reserve space on left and right

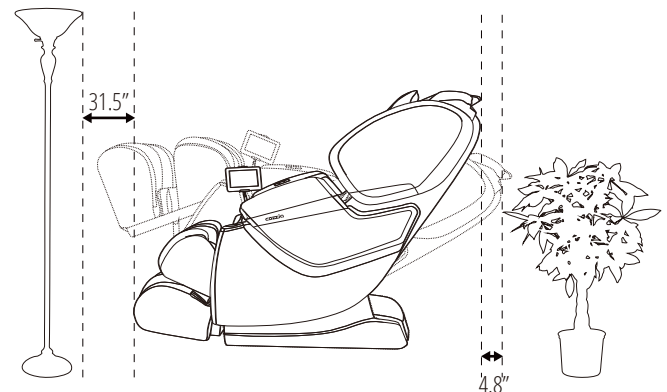

Reserve space on the front and back

CHAIR COMPONENTS

Some of your chair's most important features.

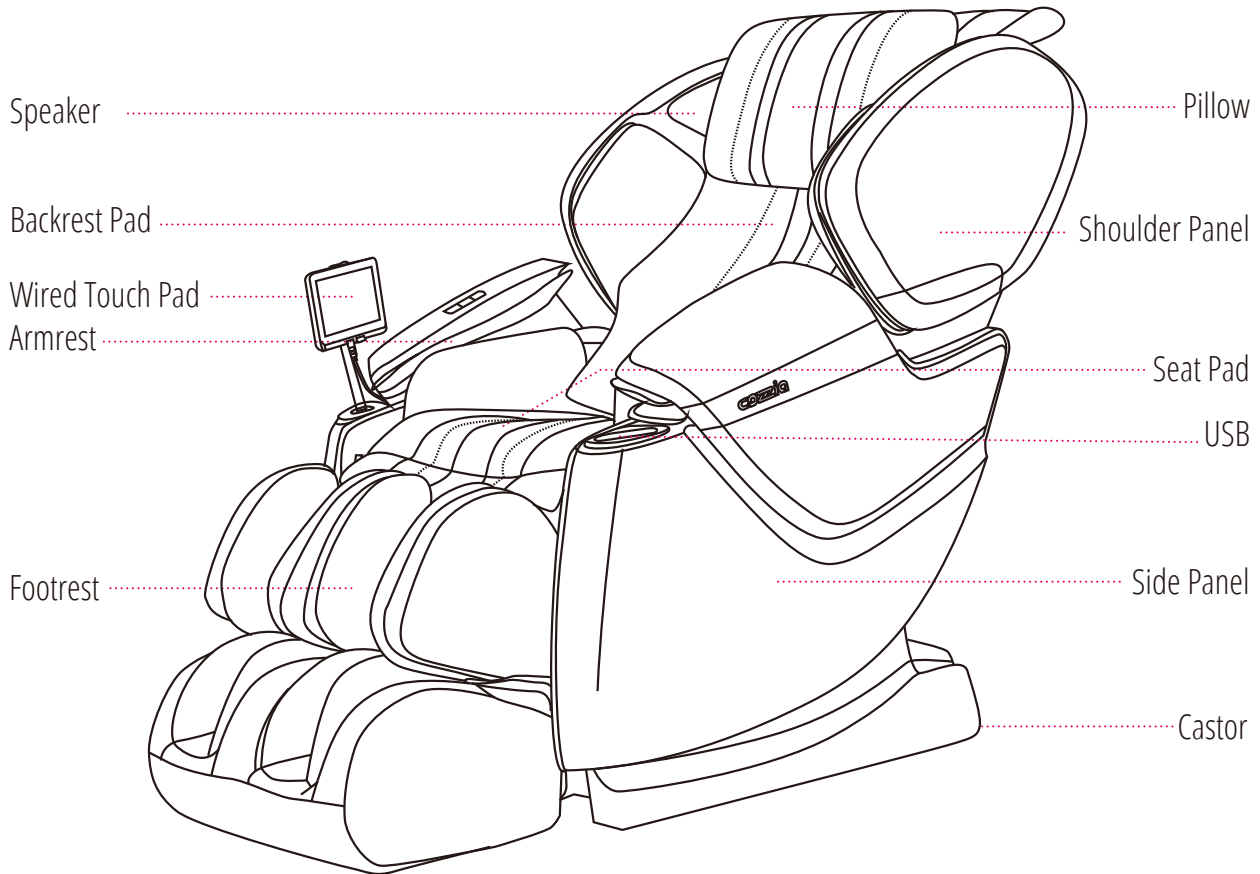

Note: The speaker will only operate when the massage chair is in operation



To play music using your massage chair's speakers please connect your smartphone, tablet, or other electronic device to your chair using bluetooth.

MASSAGE POINTS

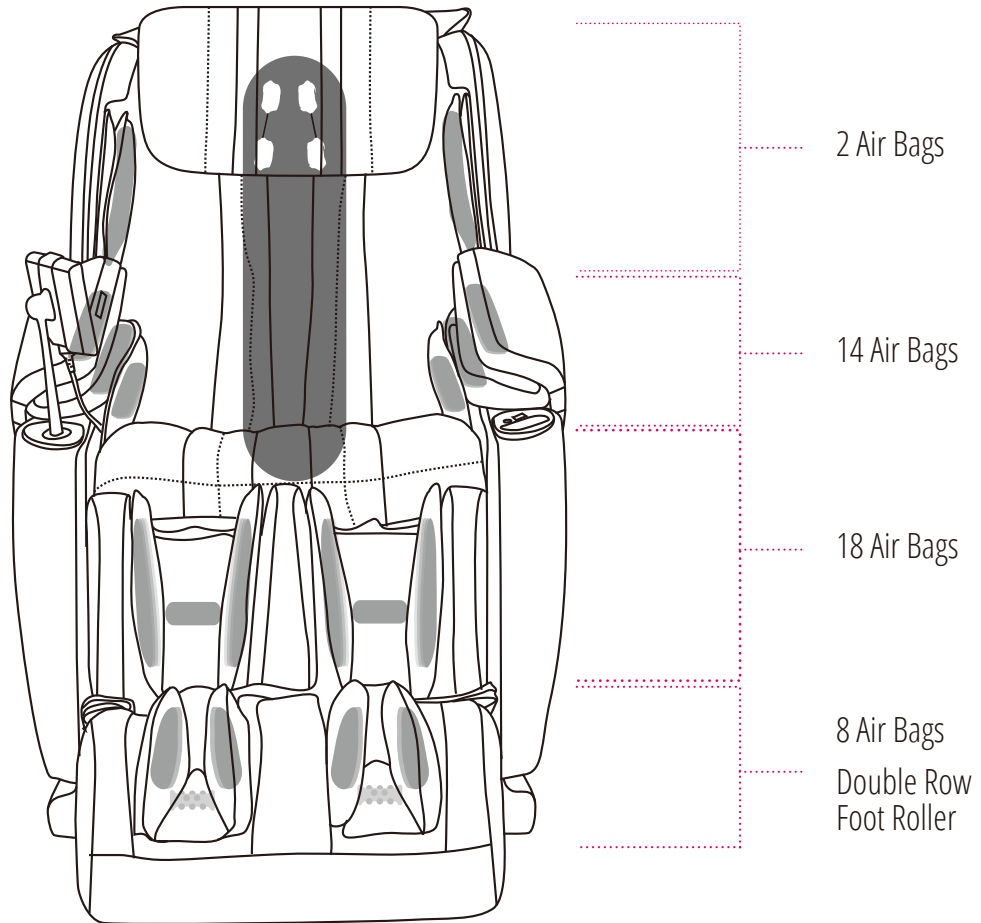

● Back Massage Mode

● Air Bag

●●●● Roller

CHAIR SPECIFICATIONS

A few important facts about your massage chair.



Model No.

CZ-640

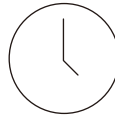

Max Massage Time

30 minutes

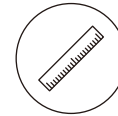

Dimensions (L x W x H)

Chair dimension: 60.2"x30.3"x46.1"
Reclined dimension: 72.8"x30.3"x34.6"



Shipping Weight

Gross weight: 269 lbs
Net weight: 223 lbs

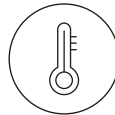

Usage Condition

Environment temperature: 10°C-40°C
Contrasting humidity: 30-85RH

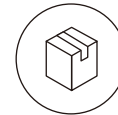

Storage Condition

Storage temperature: -20°C-60°C
Storage humidity level: 30-85RH



Power Consumption

165W



Rated Voltage

110 - 120V



Rated Frequency

60Hz



Power of Speakers

14W (2 sides)



Length of Wiring

Controller wiring 27.6"
Power supply wiring 70.9"



Safety Feature

Equipped with overheating and power surge detectors safety feature

WIRED TOUCH-PAD INTERFACE

We have designed your massage chair's tablet controller with a user-friendly interface to make using your chair even easier.

Home Screen

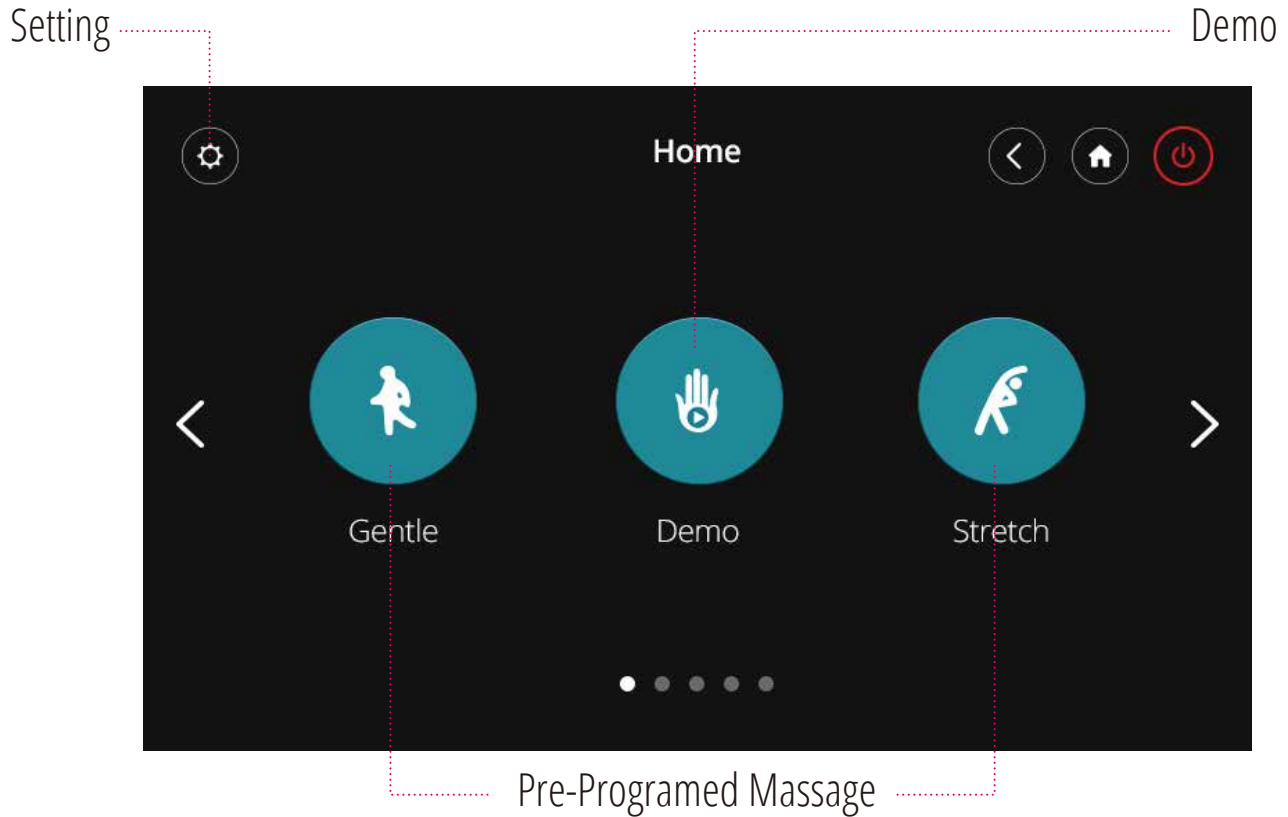

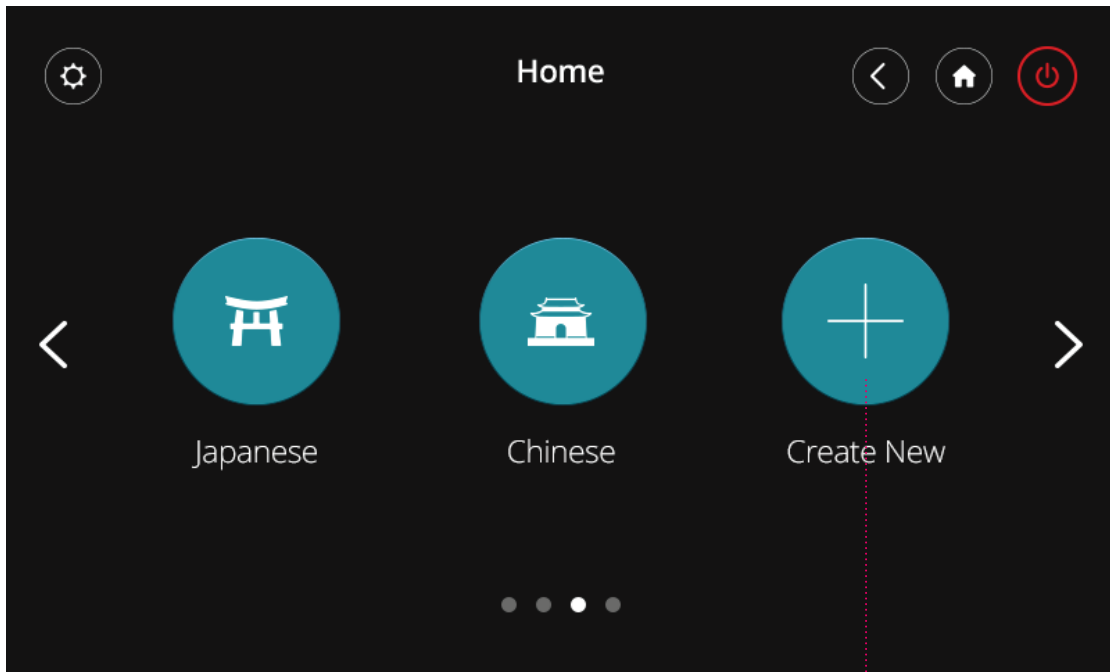

Create New Program

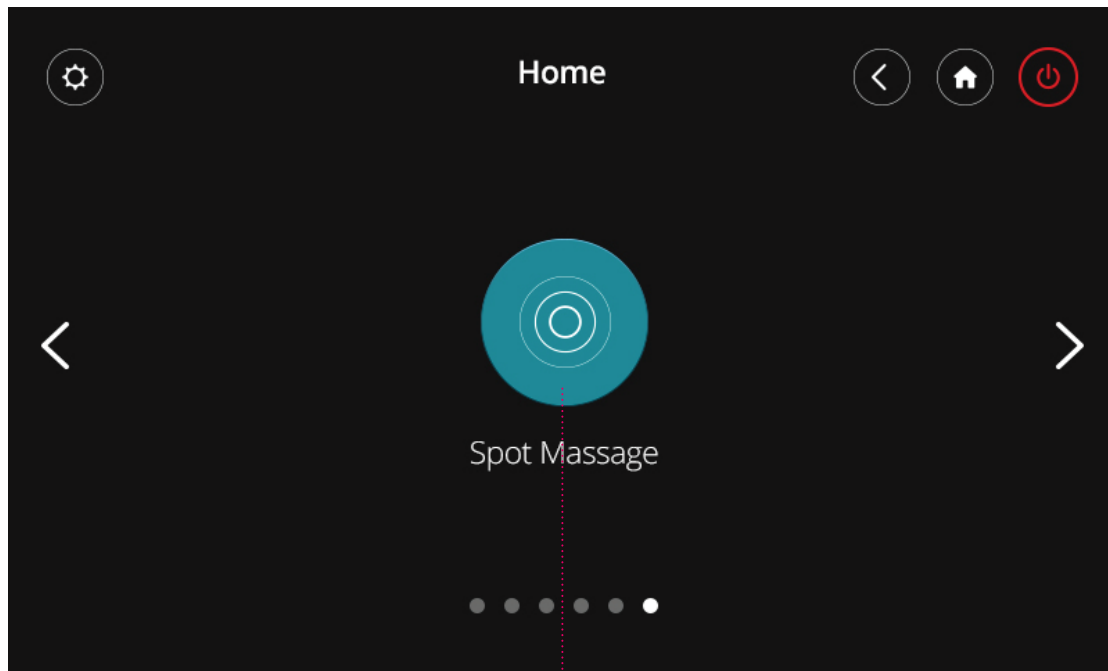

Spot Message

Massage Controls

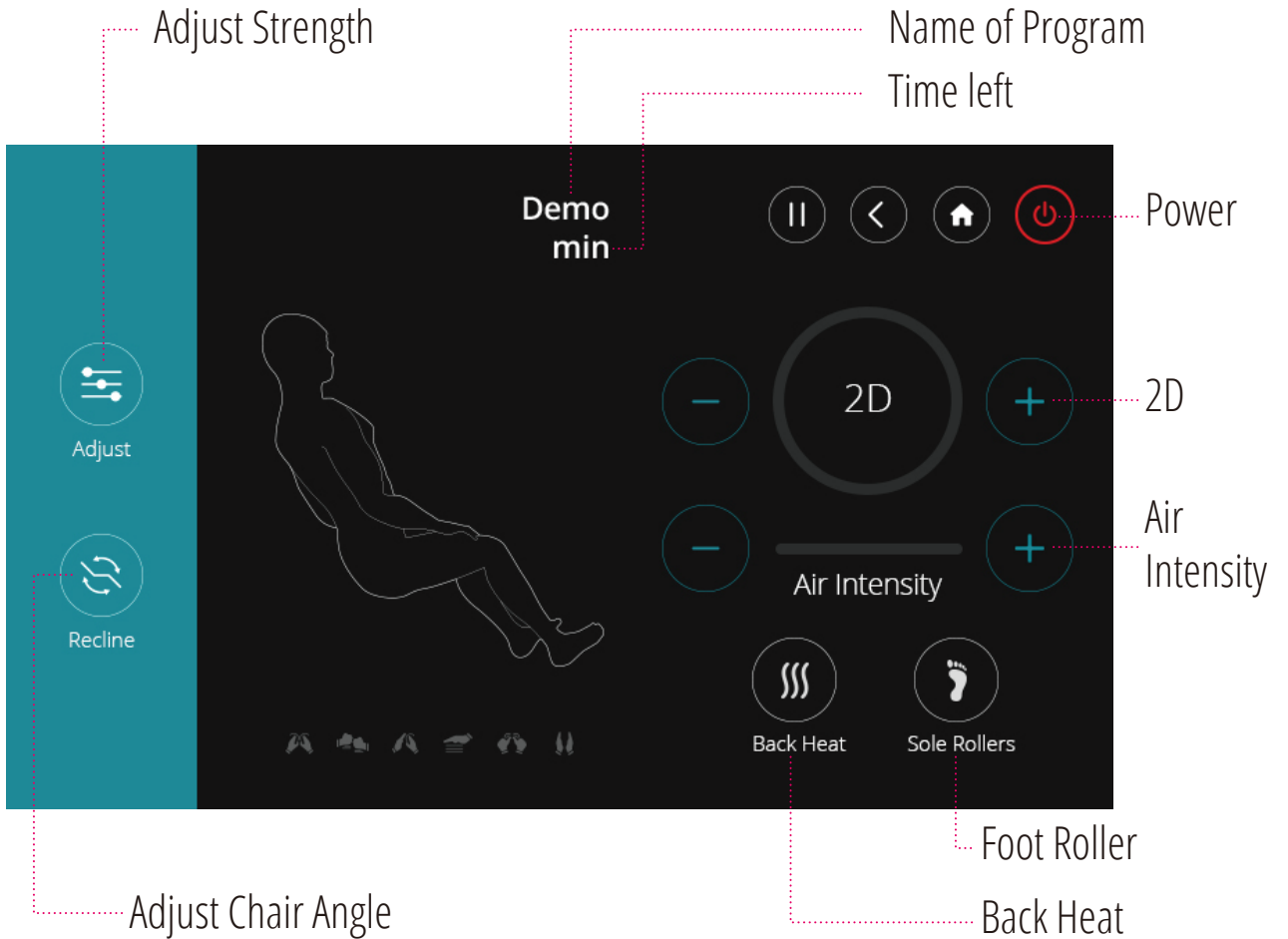

PRE-PROGRAMMED MASSAGE

We have designed your chair with multiple massage options for your changing needs. Follow these simple instructions to begin a new pre-programmed massage.

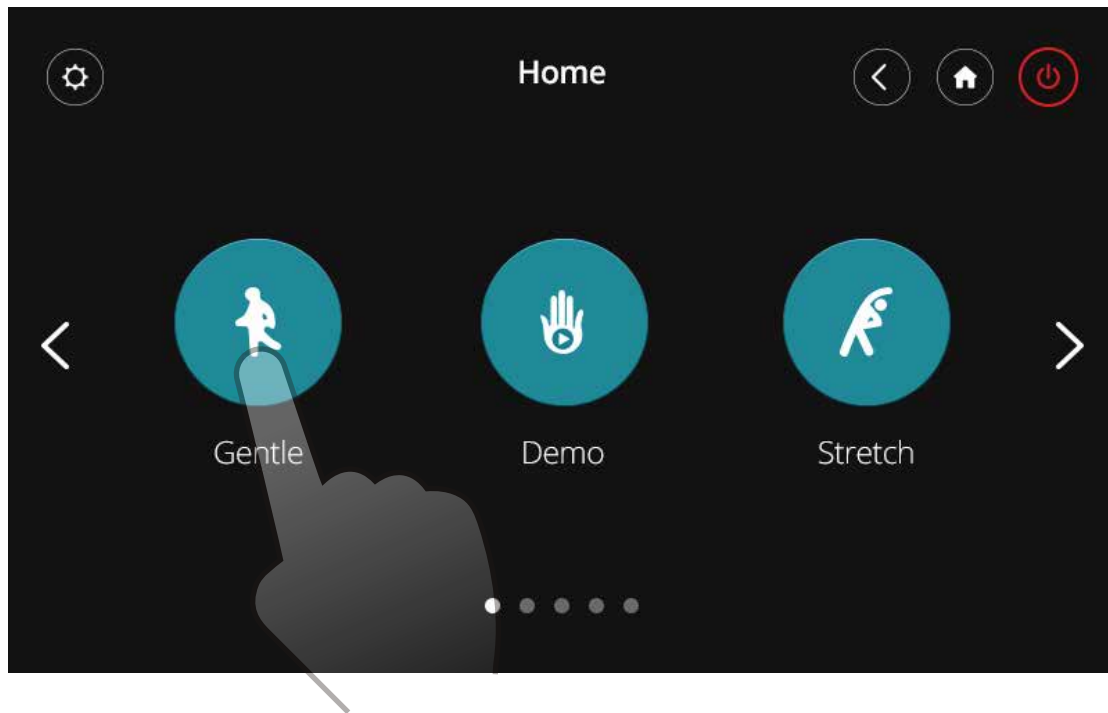

Choose 1 of our 8 pre-programmed massages
(Gentle, Demo, Stretch, Spine Care, Relax, Swedish, Japanese, Chinese)

Pre-Programmed Massage Interface

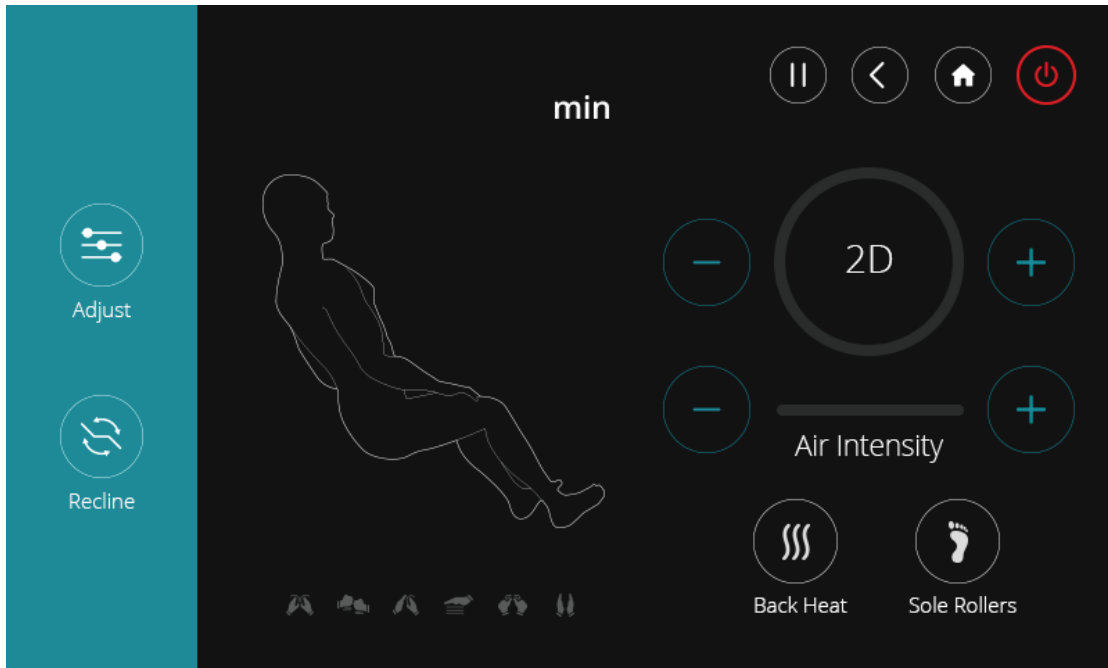

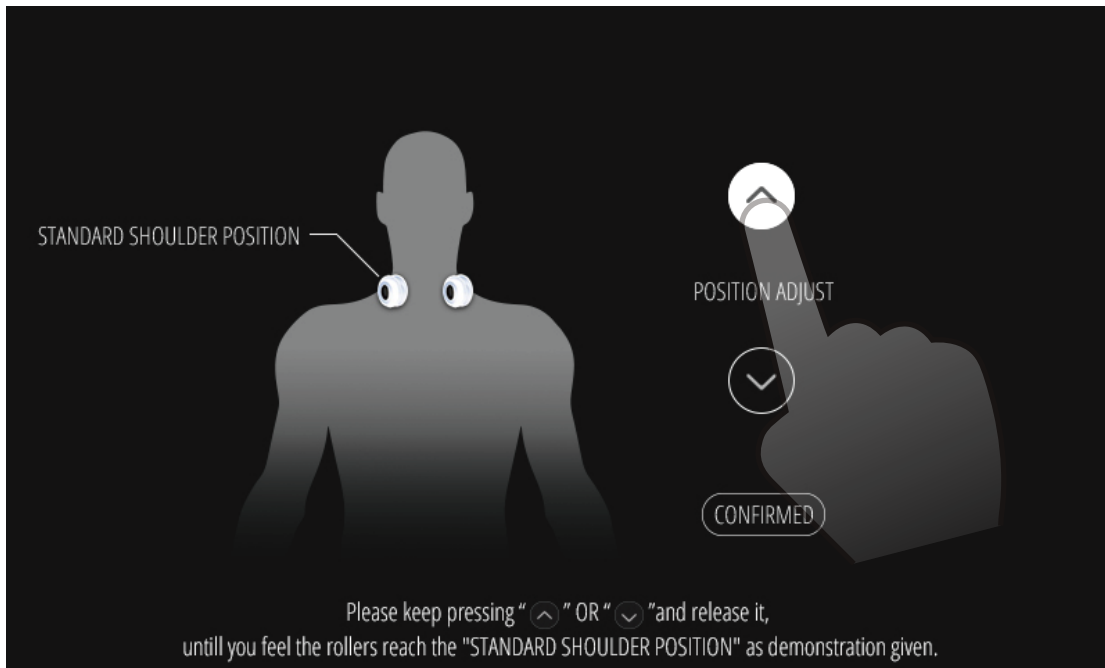

Using the arrows, you can adjust the standard shoulder position

Adjust Massage Strength Interface

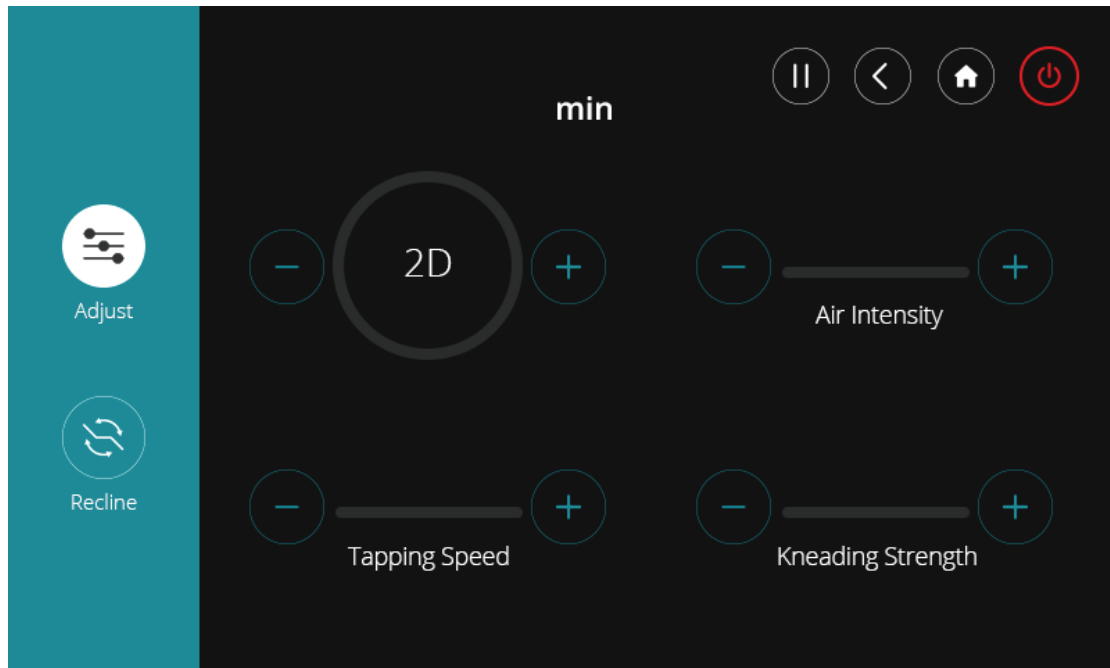

In this interface, you can adjust massage 2D strength, tapping speed, kneading strength and air intensity

Adjust Chair Angle Interface

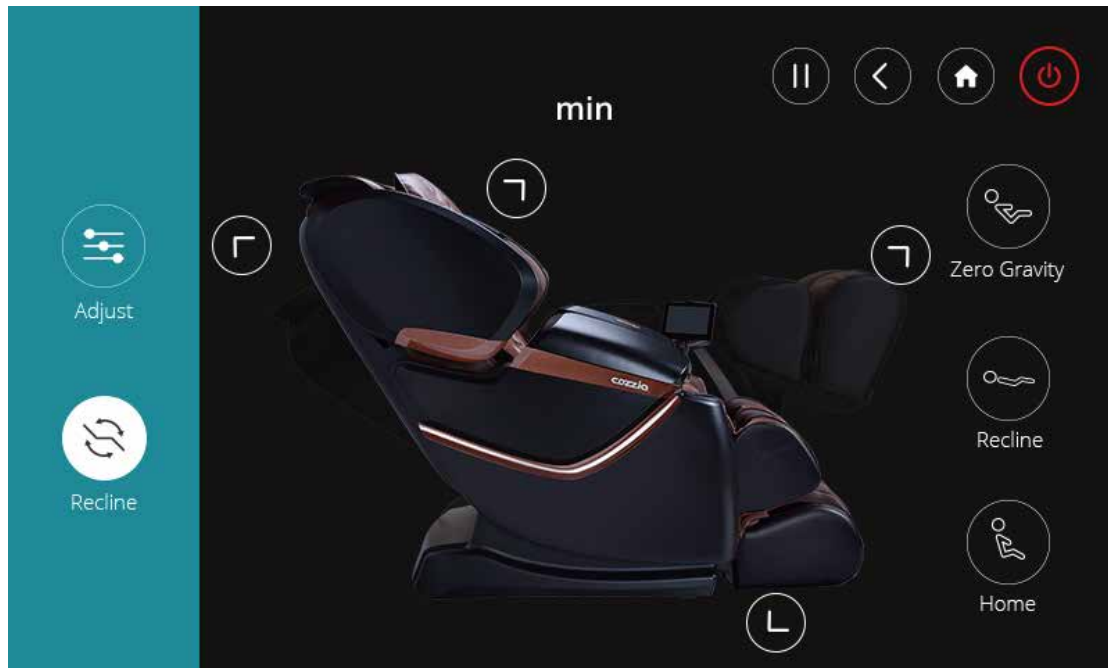

Adjust your chair quickly by choosing one of the three preset seating positions. You can also press and hold the arrows to adjust parts of the chair independently

DEMO

In order to show you a quick glimpse of what this massage chair can do, we created a demo module for you.

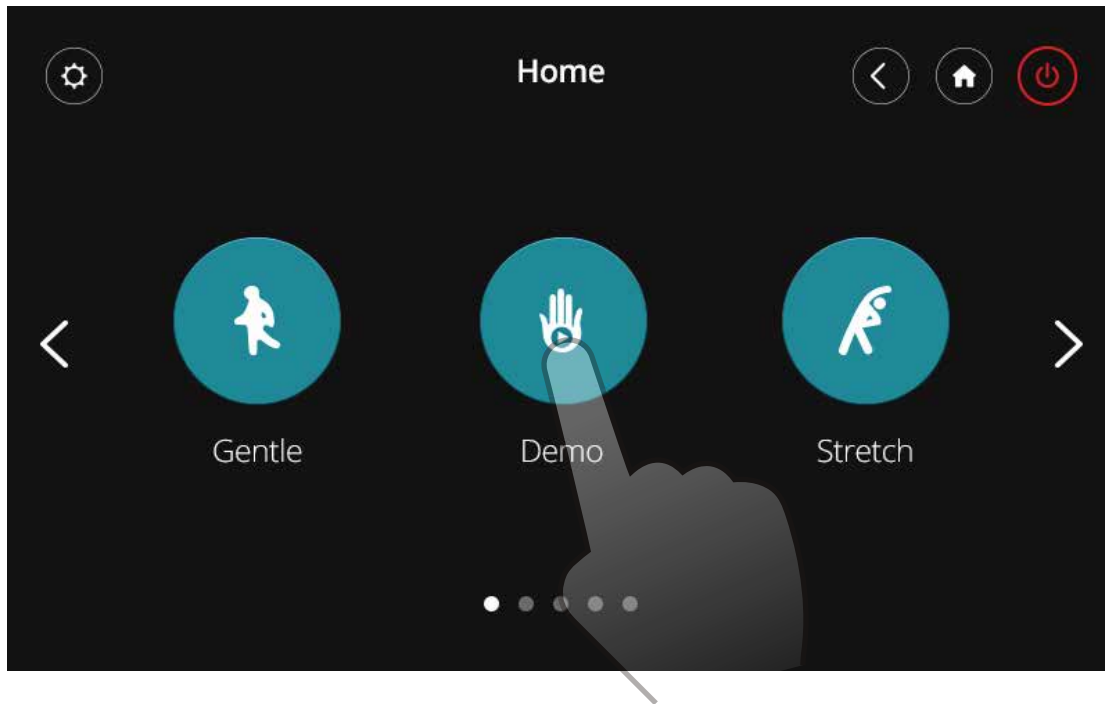

Choose the "Demo" icon to begin demo program

Demo Interface



CUSTOM MESSAGE

Every body is different. That's why we've given you the option to customize your massage to meet your specific needs. Follow these simple instructions to create a new custom massage. You can create up to 3 custom programs. To delete a custom massage program, press and hold that icon and choose the "X". Note that you can only delete a custom program while you are not in any program or you are in an auto program.

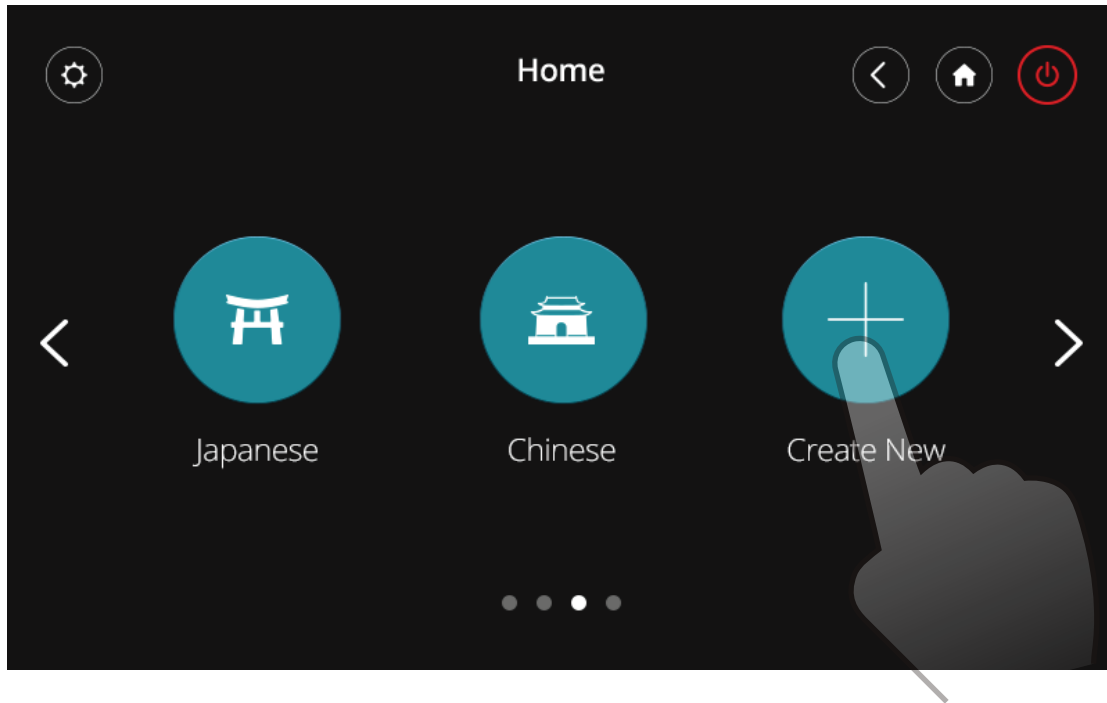

Choose the "Create New" icon to begin creating your massage program

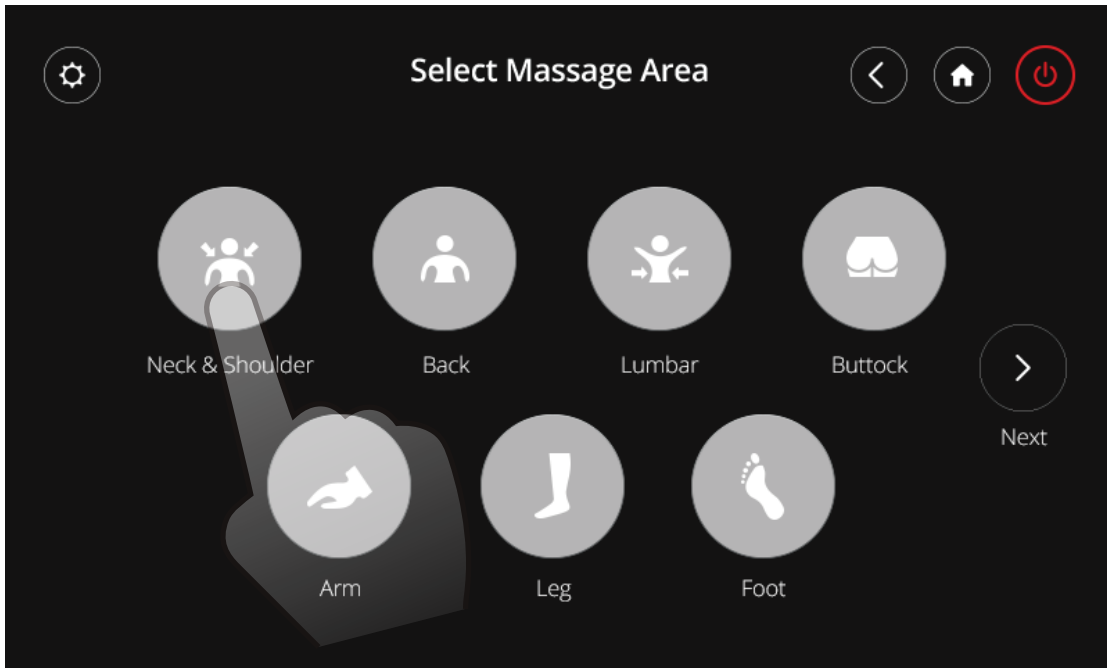

Select which areas you would like massaged

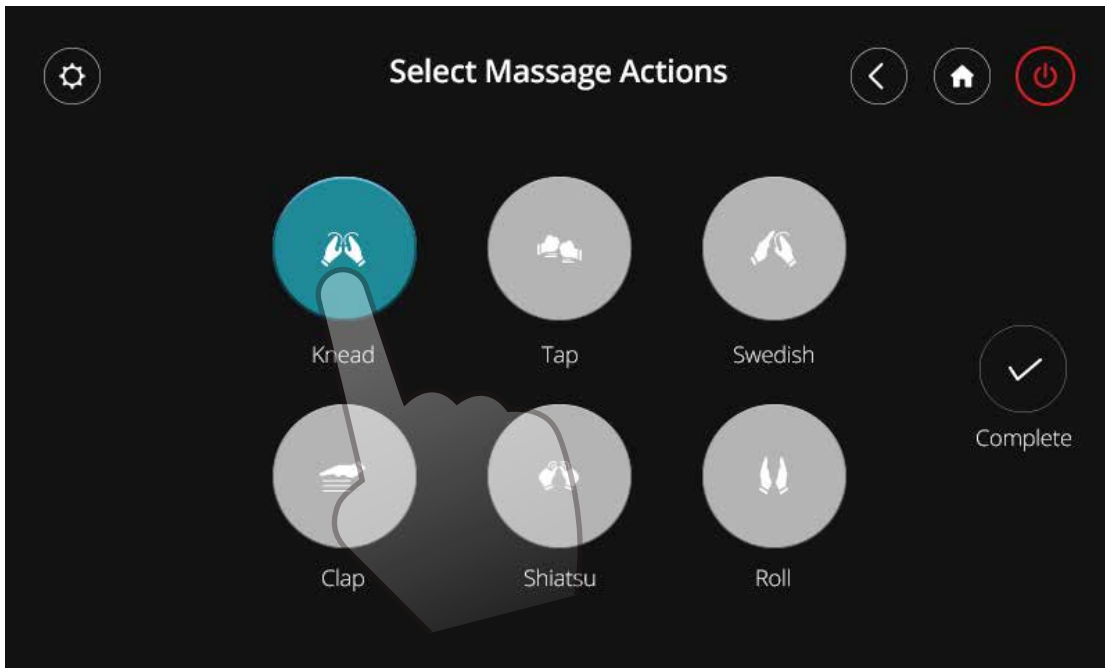

Select your favorite massage actions. The knead, tap, clap, and shiatsu massages can be combined with swedish or roll

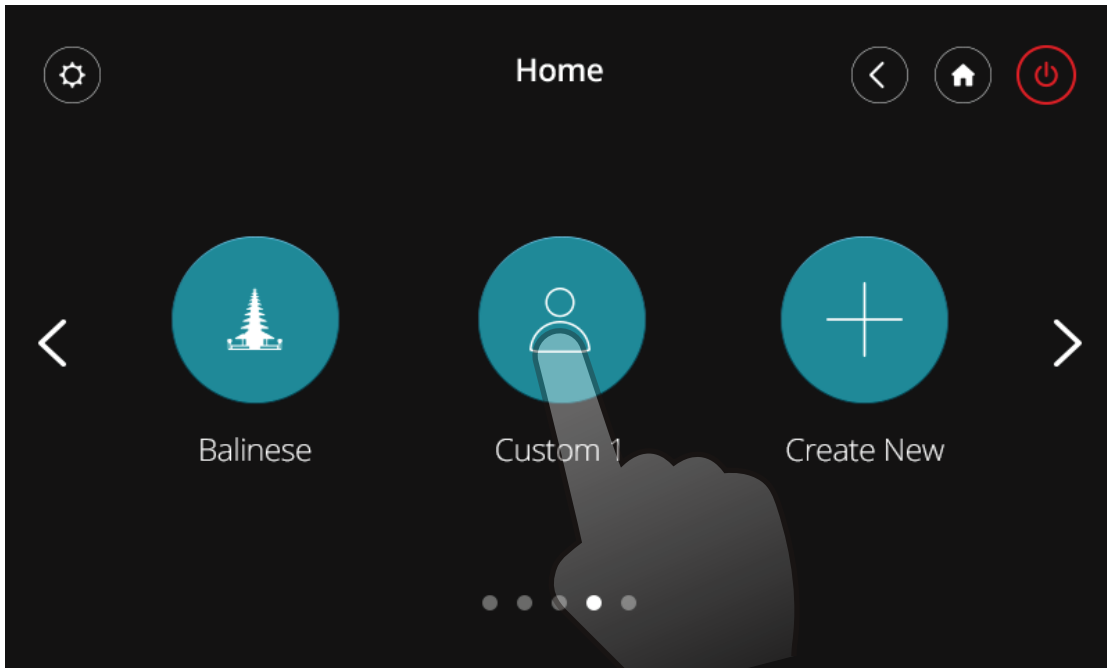

Choose the "Custom 1" icon to start your program

Custom Interface



SPOT MESSAGE

This is a fixed message area and actions program.

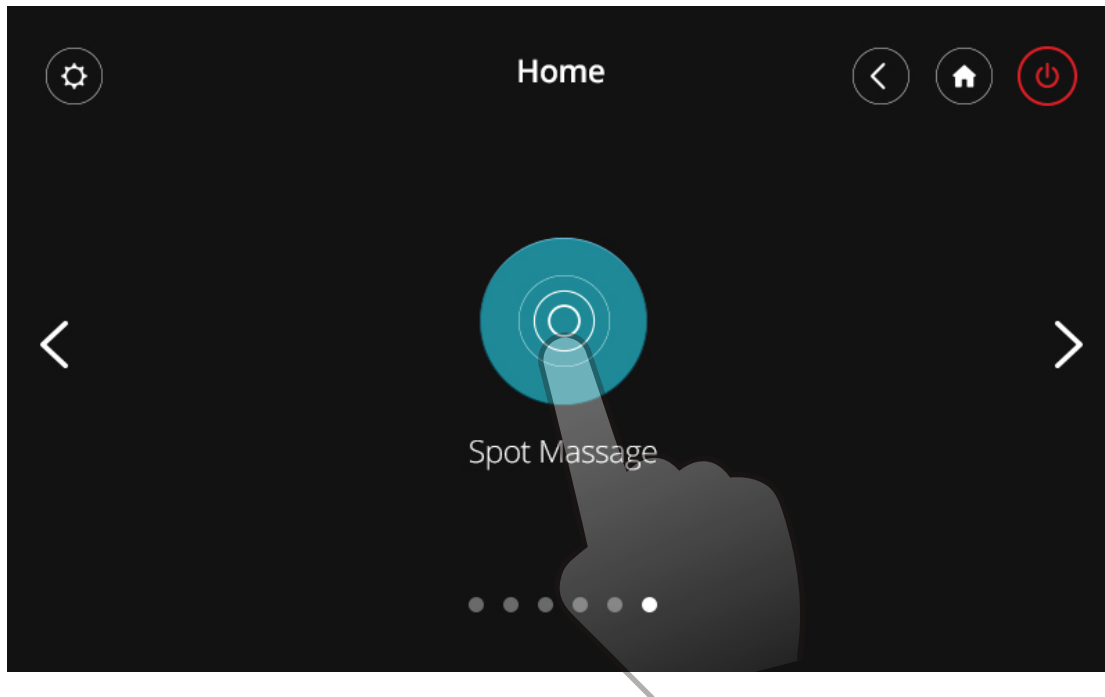

Choose the "Spot Message" button to take you to the Spot Message page

Spot Massage Interface 1

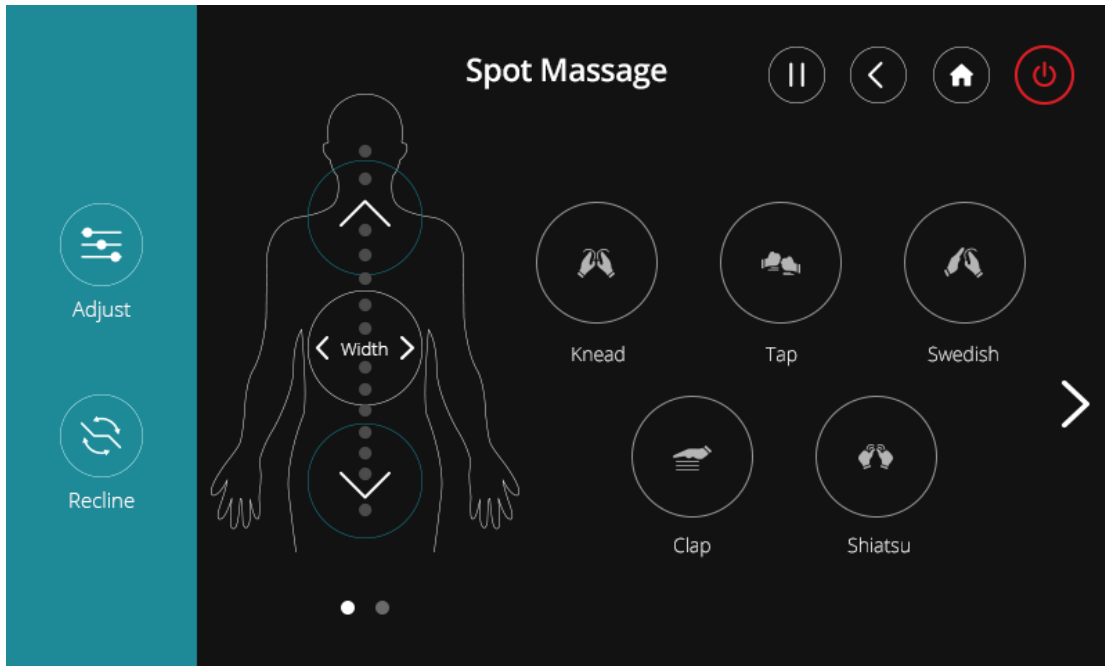

Spot Massage Interface 2

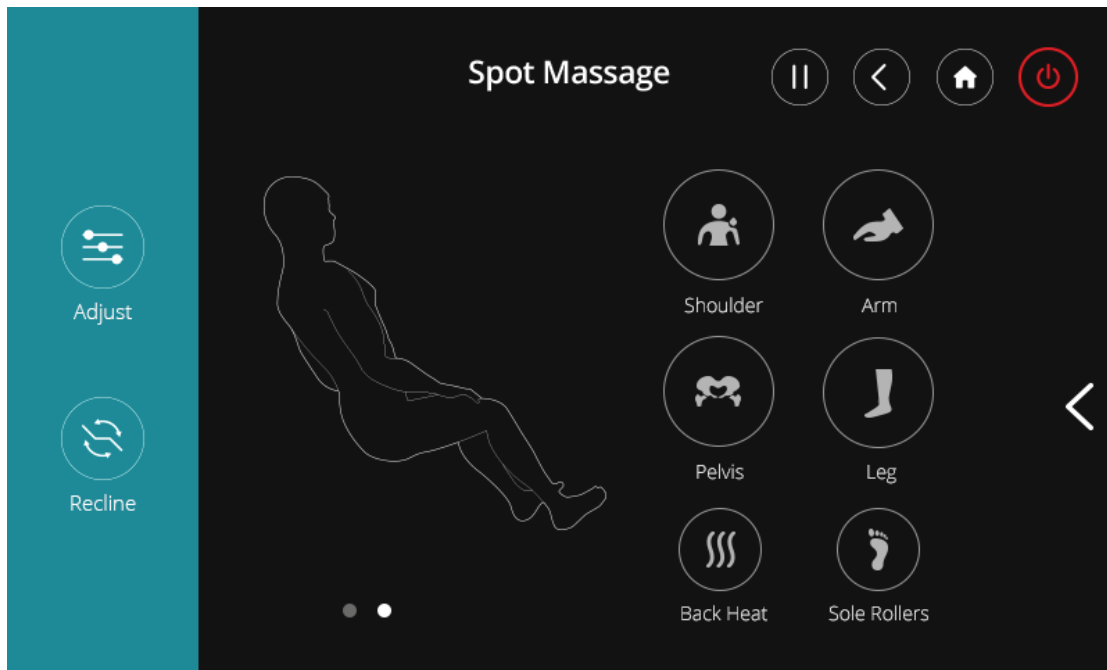

SETTINGS

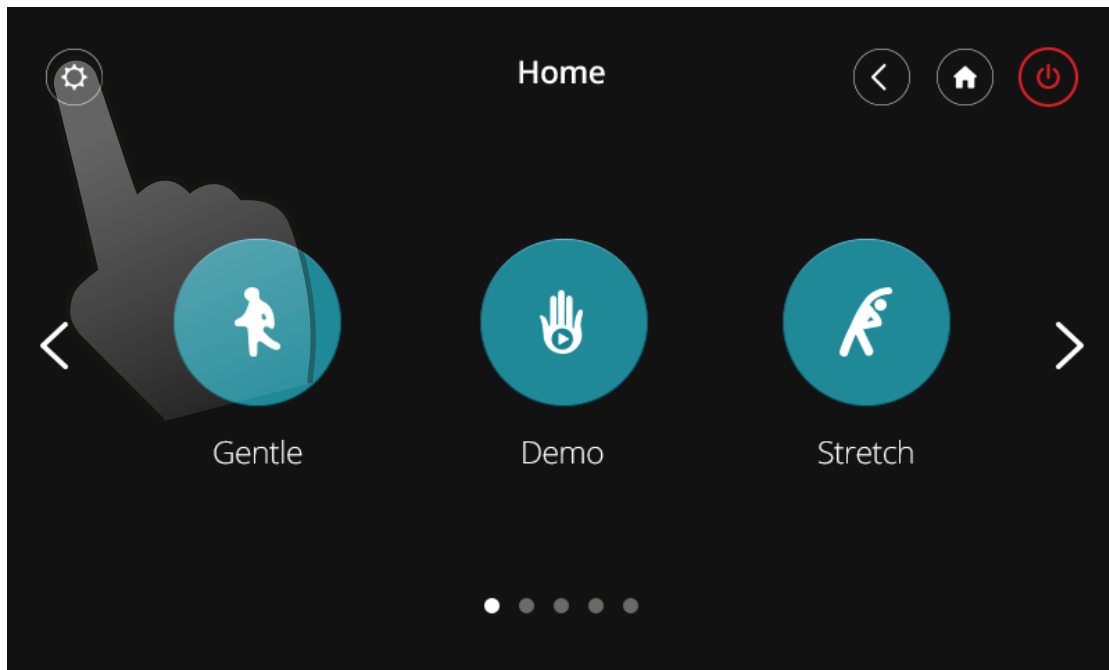

Choose the "Settings" button to take you to the settings page

Settings Interface

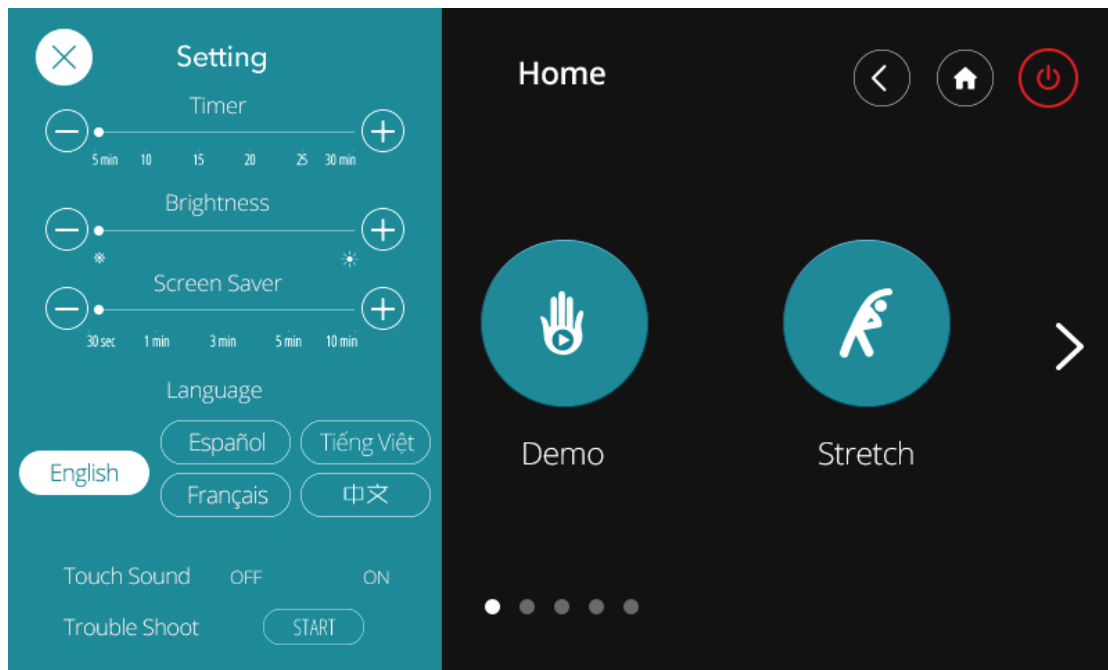

TROUBLESHOOTING

This massage chair is controlled by a microcomputer and is thus susceptible to power surges of +10 to-15%. The following situations may arise in the event of a power surge:

Situation	Solution
The massage chair is connected to the power supply but is not functioning	1. Check to see that the plug is properly connected and working 2. Ensure the massage chair switch is in the 'I' position
The remote control works but the massage chair is not functioning.	Possible overheating due to prolonged use. Turn off the power for at least 30 to 50 minutes
Both the remote control and the massage chair are not functioning	1. Ensure the chair is plugged into a working outlet 2. Turn the power OFF and ON again

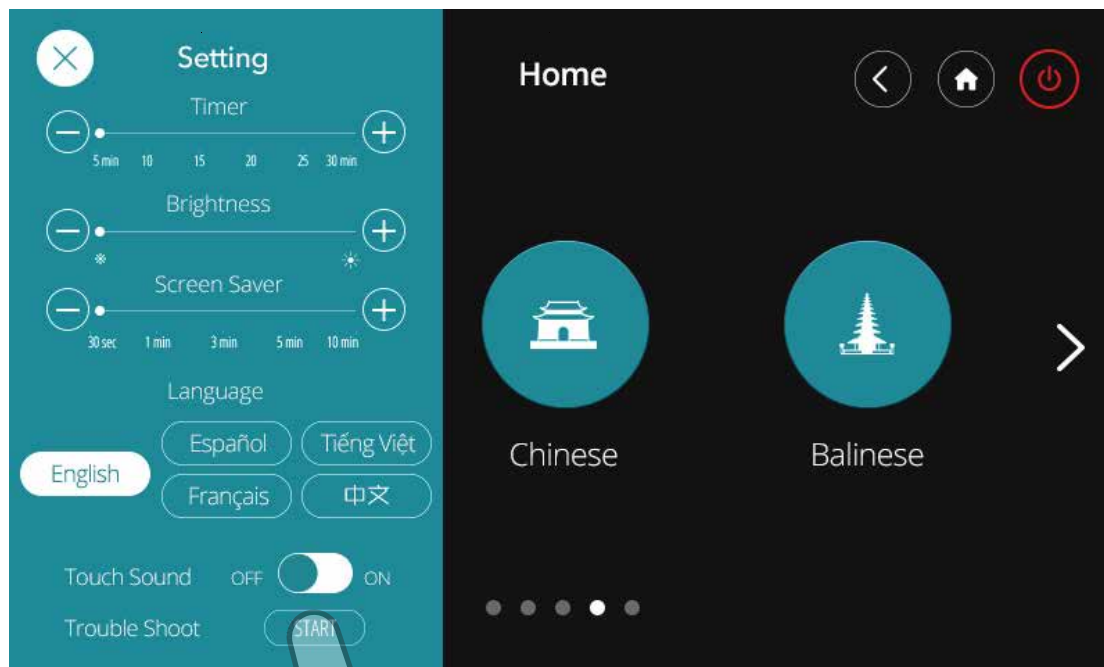

If your chair has any trouble, press the Trouble Shoot "Start" button for the chair to automatically detect problem areas. Use this code when contacting our customer service team

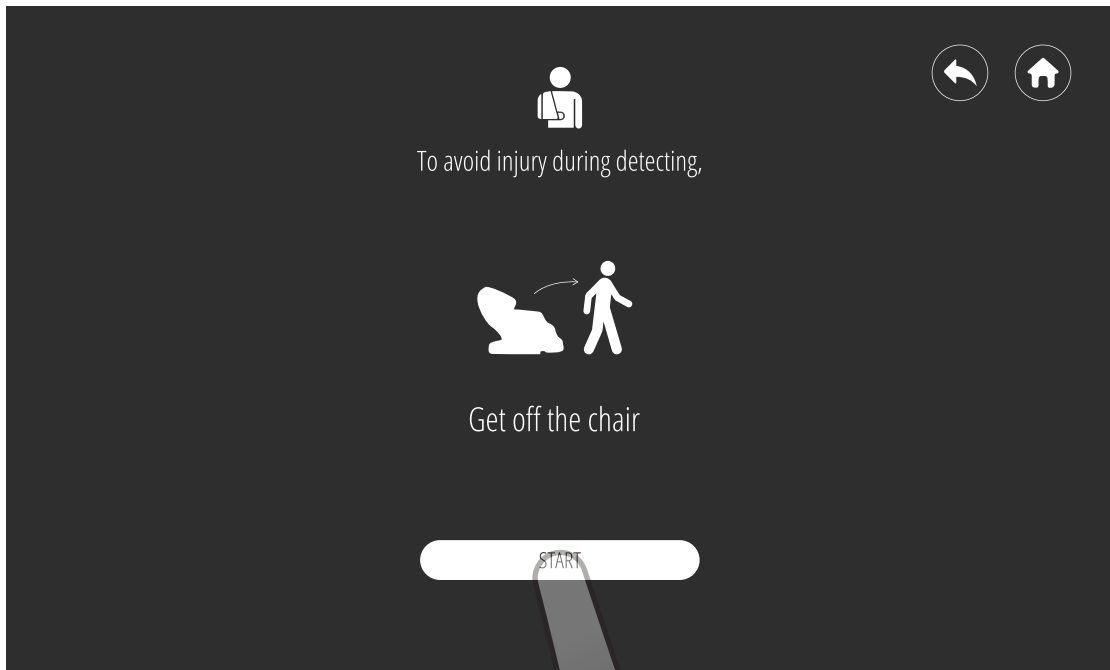

Choose "Start" button and make sure the chair is not occupied during chair detection

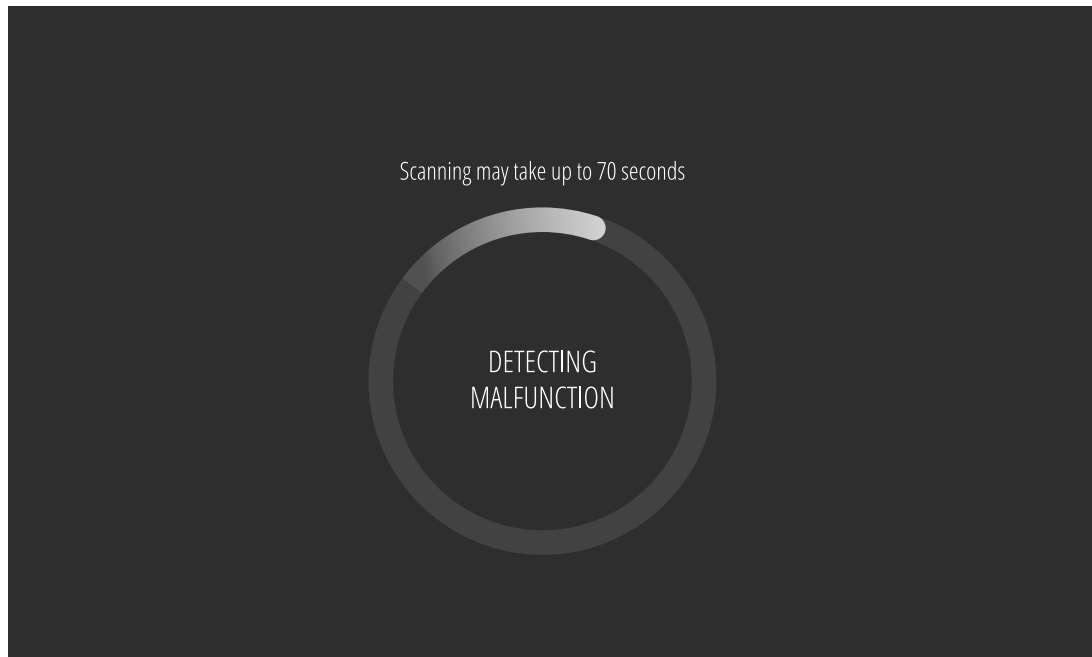

Your chair is detecting possible malfunctions, please wait for the detection result

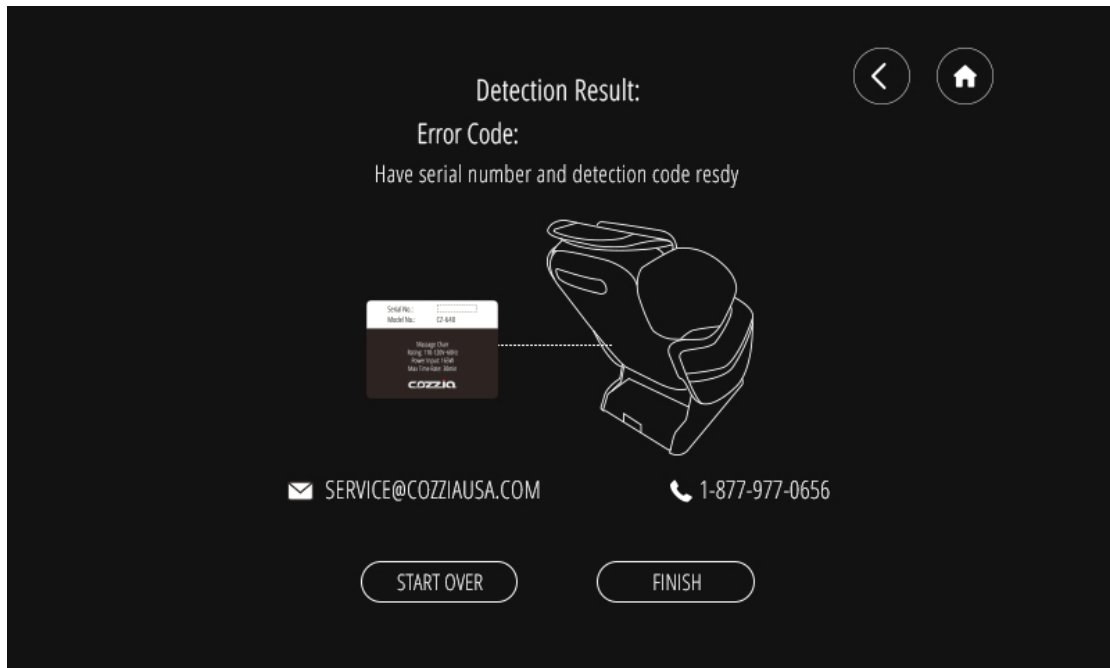

You can use your detection code when contacting the Cozzia customer team about your chair's problems. Note that NULL means that there is no detection of a problem"

PRE-PROGRAMED DESCRIPTION

GENTLE



A program designed to provide a quiet, gentle massage that is good for beginners or those that prefer a soft touch.

FOCUS AREA

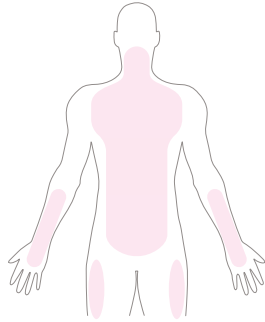

INTENSITY



FOCUS TECHNIQUE



DEMO



This massage will quickly demonstrate all of the massage features in 5 minutes.

FOCUS AREA

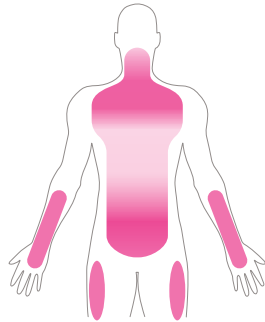

INTENSITY



FOCUS TECHNIQUE

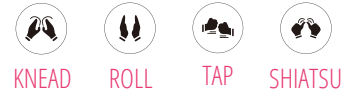

SPINE CARE



This is a full back massage that will focus on your lower back with a deep tissue massage that includes air compression.

FOCUS AREA

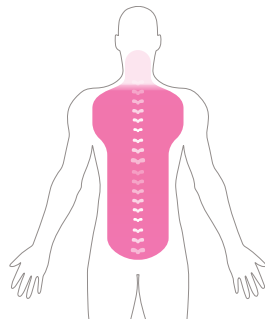

INTENSITY



FOCUS TECHNIQUE



STRETCH



This massage will stretch your legs and back with a combination of gentle tapping, kneading, rolling, and air compression.

FOCUS AREA

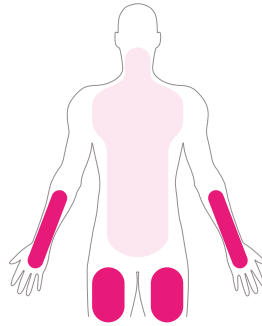

INTENSITY



FOCUS TECHNIQUE



KNEAD ROLL

RELAX

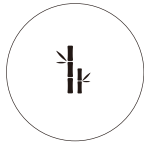

A program designed to provide a mild massage that is great for deep relaxation, best used before going to sleep.

FOCUS AREA

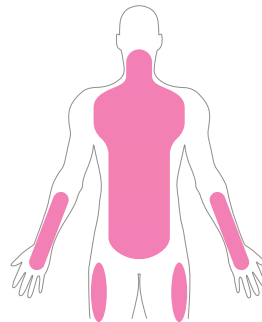

INTENSITY



FOCUS TECHNIQUE



KNEAD ROLL CLAP

SWEDISH



This is a full back massage that will begin at your neck, and travel down to your glutes. It will use the kneading and swedish techniques, and aids in blood circulation.

FOCUS AREA

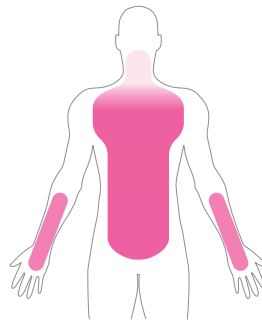

INTENSITY



FOCUS TECHNIQUE



KNEAD SWEDISH

JAPANESE



This is a full body massage that will focus on your mid back and upper shoulders with a deep tissue massage using the shiatsu technique; this will create an acupressure effect.

FOCUS AREA

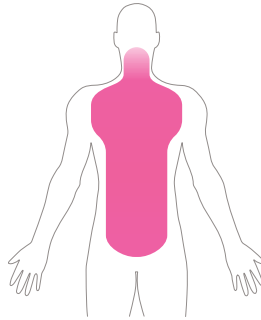

INTENSITY



FOCUS TECHNIQUE



CHINESE



This massage will focus on your entire back with the kneading technique, while also massaging your legs and feet.

FOCUS AREA

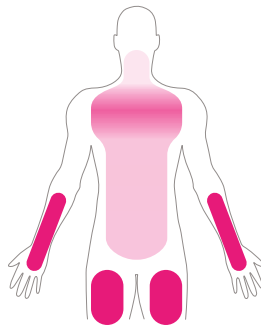

INTENSITY



FOCUS TECHNIQUE



PRODUCT CARE AND STORAGE

1. Storing the Massage Chair

- Wipe off dust and dirt from the massage chair with a dry, soft, clean cloth after use.
- Keep the massage chair clean and away from places of high humidity.
- If the massage is not to be used for a long period of time, cover the massage chair with a dust cover and unplug its power plug from the electrical outlet.

Caution

- Do not store the massage chair in direct sunlight or in places of high temperature. This may cause the color of the upholstery to fade.
- Do not allow the massage chair to remain in contact with vinyl or wallpaper for extended periods of time as this could lead to discoloration.

2. Cleaning the Massage Chair

- Before cleaning, ensure that the main power switch is off and the power plug is disconnected from the electrical outlet.
- Wipe off dust and dirt from the massage with a dry, soft, clean cloth after each use.
- This product can be cleaned thoroughly with a slightly damp cloth.
- Do not iron the upholstery.
- Do not wash the upholstery using a home washing machine as this may result in deterioration of the upholstery's quality.

Caution

- Do not use abrasive cleaning agents like benzene or thinner to clean the massage chair. This may cause the upholstery to fade.

3. Cleaning the Controller

- Use only a clean, dry cloth to clean the controller.

Caution

- Do not use a wet cloth to clean the controller. This may result in malfunction.

COZZIA CONSUMER WARRANTY

Cozzia products have the following warranty:

This chair has a one-year in-home and a two-years parts service warranty. Cozzia customer service will not issue Return Material Authorizations (RMAs) for products. Cozzia products will be either repaired by the consumer or by an in-home technician. Cozzia will not issue Return Material Authorizations (RMAs) for buyer's remorse.

Service And Technical Support

Consumers may contact Cozzia's customer service department at 1-877-977-0656 between 9:00 am and 5:00 pm PST, Monday through Friday or email us at Service@cozziausa.com or visit our web at www.cozziausa.com for warranty or service issues.

Consumers are required to provide the unit serial number and dated proof of purchase (sales receipt) when they contact the Cozzia service department regarding a repair.

A Cozzia customer service representative will attend to most consumer inquiries, but in some cases a technical service specialist will provide advanced support.

Non-warranty repair is provided on a "per incident" basis. Cozzia customer service will verify that the unit has failed and provide instructions for repairing a unit. All applicable repairs, parts, shipping, handling, local tax and a "per incident" fee will be charged for non-warranty repairs and support calls.

Proof of purchase (original receipt) is required for all warranty repairs or service.

Extended Warranties:

Cozzia offers extended warranty programs to enhance the ownership of your massage chair. Please call Cozzia customer service at 877-977-0656 for details and pricing.

Product Repairs

Many Cozzia product repairs may be performed by the consumer in their own home with parts and instructions supplied by Cozzia such as remote controller replacements that don't require a technician. Canadian consumers may contact Cozzia's customer service department at 1-877-977-0656 between 9:00 am and 5:00 pm PST, Monday through Friday for warranty or service issues.

- Floor Models and Demonstration Units have a prorated warranty period that begins the day the model is placed on the floor and connected to an electrical outlet by the retail partner. Proof of purchase is required in order to obtain warranty service and parts. Non-warranty parts and service are available at a "per incident" charge.
- Warranty Coverage Period - Warranty coverage starts at the time that the consumer PURCHASES their chair. Proof of purchase is required for all warranty repairs. The warranty time period is measured by continuous calendar days based on a seven-day week.
- Field Service – Cozzia customer service department will diagnose and schedule an authorized service provider to repair the chair in the consumer's residence.
- Parts - All parts deemed necessary for repairs will be shipped to the consumer at no charge by the Cozzia service department.

CONSUMER WARRANTY LIMITATIONS AND EXCLUSIONS

- Warranties are only valid in the 48 contiguous United States and Canada and are contingent upon the consumer operating the chair according to the corresponding instruction manual.
 - The warranty only applies to Cozzia products and does not include any accessories or enhancements.
 - Field service requires pre-approval and must be performed by Cozzia's authorized field service personnel. Field service is only available in the United States and in major metropolitan areas in Canada.
 - Softening of foams and filling composites in pillows, pads, and memory foam occurs naturally and does not constitute a defect under this warranty.
 - Fading, wear and piling of fabrics occurs naturally and does not constitute a defect under this warranty.
 - Natural markings, grain and dye variations in leather do not constitute a defect under this warranty.
 - Warranties do not cover any loss or damage resulting from improper installation, unauthorized repairs or modifications, improper use of electrical/power supply, loss of power, dropped product, a malfunction or damage of an operating part from failure to provide manufacturer's recommended maintenance, transportation damage, theft, abuse, misuse, neglect, vandalism or environmental conditions (fire, floods, rust, corrosion, sand, dirt, windstorm, hail, earthquake or exposure to weather conditions), loss of use during the period the product is at a repair facility, or otherwise awaiting parts or repair.
 - Damage due to shipping and handling does not constitute a defect under this warranty.
 - Under no circumstance shall Cozzia or its representatives be liable for indirect, consequential, or incidental damages (including damages for lost profits, business interruption, bodily injury, medical and the like), even if any party has been advised of the possibility of such damages.
 - Warranties are non-transferable and shall be in lieu of any other warranty, express or implied, including but not limited to any implied warranty or merchantability or fitness for particular use.
 - Cozzia's sole liability and the purchaser's exclusive remedy shall be for the repair, or at Cozzia's option, for the replacement of the defective part.
Notwithstanding the above, if replacements parts for defective materials are not available, Cozzia reserves the right to make substitutions in lieu of repair or replacement.
-
- All warranties begin on the DATE OF PURCHASE; no allowance or extension is offered for delivery and/or installation.
 - Warranties do not apply to rental, business, commercial, institutional or other non-residential users.



861 S. Oak Park Road,
Covina, CA 91724

TEL: 1-877-977-0656
FAX: 1-800-521-4712
SERVICE@COZZIAUSA.COM

WWW.COZZIAUSA.COM