



# **FCC TEST REPORT**

**FCC ID: YMX-CA017**

On Behalf of

**Xiamen Comfort Science & Technology Group Co., Ltd.**

**Quattromed V Braintronics**

**Model No.: CA-017**

Prepared for : Xiamen Comfort Science & Technology Group Co., Ltd.  
Address : No.168 Qianpu Road, Siming District, Xiamen City, Fujian Province,  
P.R. China

Prepared By : Shenzhen Alpha Product Testing Co., Ltd.  
Address : Building i, No.2, Lixin Road, Fuyong Street, Bao'an District, 518103,  
Shenzhen, Guangdong, China

Report Number : T1890192 04  
Date of Receipt : January 14, 2019  
Date of Test : January 14, 2019 – January 29, 2019  
Date of Report : January 29, 2019  
Version Number : REV0

## TABLE OF CONTENTS

Description	Page
<b>1. Summary of Standards And Results .....</b>	<b>6</b>
1.1. Description of Standards and Results .....	6
<b>2. General Information.....</b>	<b>7</b>
2.1. Description of Device (EUT).....	7
2.2. Accessories of Device (EUT) .....	8
2.3. Tested Supporting System Details .....	8
2.4. Block Diagram of connection between EUT and simulators .....	8
2.5. Test Mode Description.....	8
2.6. Test Conditions .....	8
2.7. Additional instructions.....	9
2.8. Test Facility .....	10
2.9. Measurement Uncertainty .....	10
2.10. Test Equipment List .....	11
<b>3. Maximum Peak Output power .....</b>	<b>12</b>
3.1. Limit .....	12
3.2. Test Procedure .....	12
3.3. Test Setup.....	12
3.4. Test Result .....	12
<b>4. Bandwidth.....</b>	<b>13</b>
4.1. Limit .....	13
4.2. Test Procedure .....	13
4.3. Test Result .....	13
<b>5. Carrier Frequency Separation.....</b>	<b>19</b>
5.1. Limit .....	19
5.2. Test Procedure .....	19
5.3. Test Result .....	19
<b>6. Number Of Hopping Channel.....</b>	<b>22</b>
6.1. Limit .....	22
6.2. Test Procedure .....	22
6.3. Test Result .....	22
<b>7. Dwell Time.....</b>	<b>25</b>
7.1. Test limit .....	25
7.2. Test Procedure .....	25
7.3. Test Result .....	25
<b>8. Radiated emissions.....</b>	<b>32</b>
8.1. Limit .....	32
8.2. Block Diagram of Test setup .....	33
8.3. Test Procedure .....	34
8.4. Test Result .....	34

<b>9. Band Edge Compliance .....</b>	<b>40</b>
9.1. Block Diagram of Test Setup.....	40
9.2. Limit .....	40
9.3. Test Procedure .....	40
9.4. Test Result .....	40
<b>10. Power Line Conducted Emissions .....</b>	<b>59</b>
10.1. Block Diagram of Test Setup.....	59
10.2. Limit .....	59
10.3. Test Procedure .....	59
10.4. Test Result .....	59
<b>11. Antenna Requirements .....</b>	<b>62</b>
11.1. Limit .....	62
11.2. Result .....	62

## TEST REPORT DECLARATION

Applicant : Xiamen Comfort Science & Technology Group Co., Ltd.  
Address : No.168 Qianpu Road, Siming District, Xiamen City, Fujian Province, P.R. China  
Manufacturer : Zhangzhou Easepal Industrial Co., Ltd  
Address : No.228 JiaoSong Road, Taiwanese Investment Zone, Zhangzhou City, Fujian Province, P.R. China  
EUT Description : Quattromed V Braintronics  
(A) Model No. : CA-017  
(B) Trademark : CASADA

Measurement Standard Used:

**FCC Rules and Regulations Part 15 Subpart C Section 15.247: 2018,  
ANSI C63.10:2013**

The device described above is tested by Shenzhen Alpha Product Testing Co., Ltd. to determine the maximum emission levels emanating from the device. The maximum emission levels are compared to the FCC Part 15 Subpart C limits both conducted and radiated emissions. The test results are contained in this test report and Shenzhen Alpha Product Testing Co., Ltd. is assumed of full responsibility for the accuracy and completeness of these tests.

After the test, our opinion is that EUT compliance with the requirement of the above standards.

This report applies to above tested sample only. This report shall not be reproduced in parts without written approval of Shenzhen Alpha Product Testing Co., Ltd.

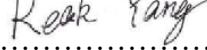
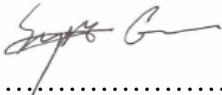
Tested by (name + signature).....: Reak Yang  
Project Engineer   
Approved by (name + signature).....: Simple Guan  
Project Manager   
Date of issue..... : January 29, 2019

**Revision History**

Revision	Issue Date	Revisions	Revised By
00	January 28, 2019	Initial released Issue	Simple Guan

## 1. SUMMARY OF STANDARDS AND RESULTS

### 1.1. Description of Standards and Results

The EUT have been tested according to the applicable standards as referenced below:

Test Item	Standards Paragraph	Result
Maximum Peak Output Power	FCC Part 15: 15.247(b)(1) ANSI C63.10 :2013	P
Bandwidth	FCC Part 15: 15.215 ANSI C63.10 :2013	P
Carrier Frequency Separation	FCC Part 15: 15.247(a)(1) ANSI C63.10 :2013	P
Number Of Hopping Channel	FCC Part 15: 15.247(a)(1)(iii) ANSI C63.10 :2013	P
Dwell Time	FCC Part 15: 15.247(a)(1)(iii) ANSI C63.10 :2013	P
Radiated Emission	FCC Part 15: 15.209 FCC Part 15: 15.247(d) ANSI C63.10 :2013	P
Band Edge Compliance	FCC Part 15: 15.247(d) ANSI C63.10 :2013	P
Power Line Conducted Emissions	FCC Part 15: 15.207 ANSI C63.10 :2013	P
Antenna requirement	FCC Part 15: 15.203	P
Note:	1. P is an abbreviation for Pass. 2. F is an abbreviation for Fail. 3. N/A is an abbreviation for Not Applicable.	

## 2. GENERAL INFORMATION

### 2.1. Description of Device (EUT)

Description	:	Quattromed V Braintronics
Model Number	:	CA-017
Diff	:	N/A
Trademark	:	CASADA
Test Voltage	:	AC 120V/60Hz from power supply.
Radio Technology	:	Bluetooth 3.0
Operation frequency	:	2402-2480MHz
Channel No.	:	79 Channels
Modulation type	:	GFSK, $\pi/4$ DQPSK, 8 DPSK
Antenna Type	:	PCB Antenna, Maximum Gain is 0dBi
Software version	:	N/A
Hardware version	:	N/A
Product Size	:	Length: 360mm Width: 170mm Height: 1170mm

## 2.2. Accessories of Device (EUT)

Accessory 1 : N/A

## 2.3. Tested Supporting System Details

No.	Description	Manufacturer	Model	Serial Number	Certification or SDOC
1	N/A	N/A	N/A	N/A	N/A

## 2.4. Block Diagram of connection between EUT and simulators

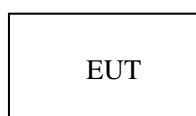

## 2.5. Test Mode Description

Tested mode, channel, and data rate information		
Mode	Channel	Frequency (MHz)
GFSK	Low :CH0	2402
	Middle: CH39	2441
	High: CH78	2480
	Hopping	2402-2480
$\pi/4$ DQPSK	Low :CH0	2402
	Middle: CH39	2441
	High: CH78	2480
	Hopping	2402-2480
8 DPSK	Low :CH0	2402
	Middle: CH39	2441
	High: CH78	2480
	Hopping	2402-2480

## 2.6. Test Conditions

Items	Required	Actual
Temperature range:	15-35 °C	27 °C
Humidity range:	25-75%	56%
Pressure range:	86-106kPa	98kPa



### 2.7. Additional instructions

Software (Used for test) from client

Mode	Special software is used. The software provided by client to enable the EUT under transmission condition continuously at specific channel frequencies individually.		
Power level setup in software			
Test Software Name	FCC Test Tool		
Test Software Version	V1.0		
Mode	Channel	Frequency (MHz)	Soft Set
GFSK, $\pi/4$ DQPSK, 8 DPSK	CH0	2402	TX level is set as defaults value.
	CH39	2441	
	CH78	2480	
	Hopping	2402-2480	

### Run Software

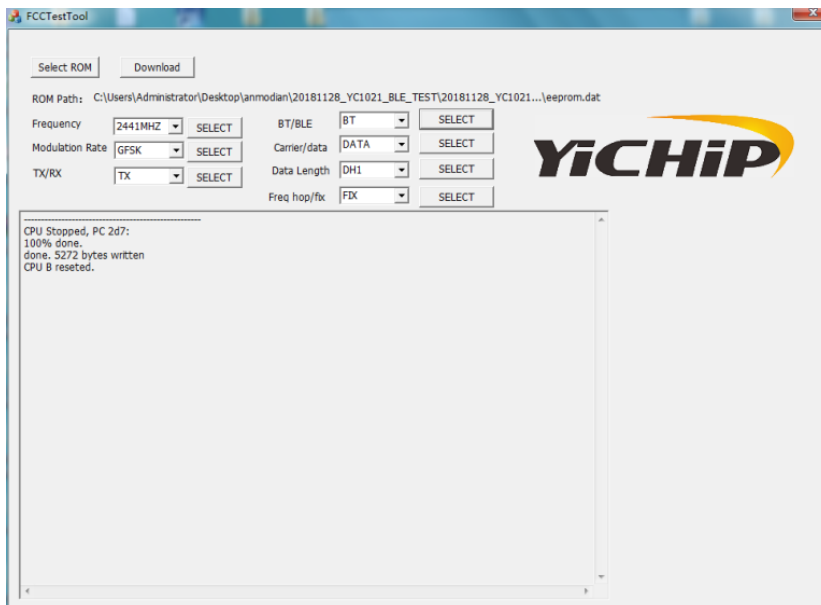

## 2.8. Test Facility

Shenzhen Alpha Product Testing Co., Ltd  
 Building i, No.2, Lixin Road, Fuyong Street, Bao'an District, 518103,  
 Shenzhen, Guangdong, China

June 21, 2018 File on Federal Communication Commission  
 Registration Number: 293961  
 Designation Number: CN1236

July 25, 2017 Certificated by IC  
 Registration Number: 12135A

## 2.9. Measurement Uncertainty

(95% confidence levels, k=2)

Item	Uncertainty
Uncertainty for Power point Conducted Emissions Test	2.74dB
Uncertainty for Radiation Emission test in 3m chamber (below 30MHz)	2.13 dB(Polarize: V)
	2.57dB(Polarize: H)
Uncertainty for Radiation Emission test in 3m chamber (30MHz to 1GHz)	3.77dB(Polarize: V)
	3.80dB(Polarize: H)
Uncertainty for Radiation Emission test in 3m chamber (1GHz to 25GHz)	4.16dB(Polarize: H)
	4.13dB(Polarize: V)
Uncertainty for radio frequency	$5.4 \times 10^{-8}$
Uncertainty for conducted RF Power	0.37dB
Uncertainty for temperature	. °C
Uncertainty for humidity	1%
Uncertainty for DC and low frequency voltages	0.06%

## 2.10. Test Equipment List

Equipment	Manufacturer	Model No.	Serial No.	Last cal.	Cal. Due day
Bilog Antenna	SCHWARZBECK	VULB 9168	9168-438	2018.04.13	2020.04.12
Spectrum analyzer	Agilent	E4407B	MY49510055	2018.09.21	2019.09.20
Horn Antenna	SCHWARZBECK	BBHA 9120 D	BBHA 9120 D(1201)	2018.04.13	2020.04.12
Filter	KANGMAI	ZLPF-LDC-1000-1959	1209002075	2018.09.21	2019.09.20
Filter	WAINWRIGHT	WHKX2.80	SN1	2018.09.21	2019.09.20
RF Cable	Resenberger	Cable 4	N/A	2018.09.21	2019.09.20
Signal Analyzer	Agilent	N9020A	MY499100060	2018.09.11	2019.09.10
vector Signal Generator	Agilent	N5182A	MY49060042	2018.09.11	2019.09.10
vector Signal Generator	Agilent	E4438C	US44271917	2018.09.11	2019.09.10
Amplifier	HP	HP8347A	2834A00455	2018.09.21	2019.09.20
Amplifier	Agilent	8449B	3008A02664	2018.04.13	2020.04.12
Filter	WAINWRIGHT	WHKX1.0G/1	SN40	2018.09.21	2019.09.20
Test Receiver	ROHDE&SCHWA	ESR	1316.3003K03-	2018.09.21	2019.09.20
9*6*6 anechoic chamber	CHENYU	9*6*6	N/A	2016.07.21	2020.07.20
RF Cable	Resenberger	Cable 1	N/A	2018.09.21	2019.09.20
RF Cable	Resenberger	Cable 2	N/A	2018.09.21	2019.09.20
RF Cable	Resenberger	Cable 3	N/A	2018.09.21	2019.09.20
Loop Antenna	SCHWARZBECK	FMZB 1519B	00005	2018.09.26	2020.09.25
Attenuator	HP	8494B	DC-18G	2018.09.21	2019.09.20
Attenuator	HP	8496B	DC-18G	2018.09.21	2019.09.20
20dB Attenuator	ICPROBING	IATS1	82347	2018.09.21	2019.09.20
Horn Antenna	SCHWARZBECK	BBHA 9170	BBHA 9170294	2017.02.22	2019.02.21
L.I.S.N.#1	Schwarzbeck	NSLK8126	8126466	2018.09.21	2019.09.20

### 3. MAXIMUM PEAK OUTPUT POWER

#### 3.1.Limit

Please refer section 15.247.

For frequency hopping systems operating in the 2400-2483.5 MHz band employing at least 75 non-overlapping hopping channels, and all frequency hopping systems in the 5725-5850 MHz band: 1 watt. For all other frequency hopping systems in the 2400-2483.5 MHz band: 0.125 watts, the e.i.r.p shall not exceed 4W

#### 3.2.Test Procedure

The transmitter output is connected to the RF Power Meter. The RF Power Meter is set to the peak power detection.

#### 3.3.Test Setup

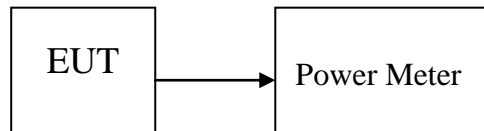

#### 3.4.Test Result

Test site: RF site				
Mode	Freq (MHz)	PK Output Power (dBm)	PK Output Power (mW)	Limit (mW)
GFSK	2402	1.636	1.457	125
	2441	2.159	1.644	125
	2480	1.704	1.480	125
$\pi/4$ DQPSK	2402	1.638	1.458	125
	2441	2.166	1.647	125
	2480	1.709	1.482	125
8 DPSK	2402	1.632	1.456	125
	2441	2.166	1.647	125
	2480	1.705	1.481	125

Conclusion: PASS

## 4. BANDWIDTH

### 4.1.Limit

Intentional radiators operating under the alternative provisions to the general emission limits, as contained in §§ 15.217 through 15.257 and in Subpart E of this part, must be designed to ensure that the 20 dB bandwidth of the emission, or whatever bandwidth may otherwise be specified in the specific rule section under which the equipment operates, is contained within the frequency band designated in the rule section under which the equipment is operated.

### 4.2.Test Procedure

The transmitter output was directly connected to a spectrum analyzer with a 50Ω cable. The bandwidth of the fundamental frequency was measured by spectrum analyzer with 30kHz RBW and 100kHz VBW. The 20dB bandwidth is defined as the total spectrum the power of which is higher than peak power minus 20dB.

### 4.3.Test Result

Mode	Freq (MHz)	20dB Bandwidth (KHz)	Limit (kHz)	Conclusion
GFSK	2402	1165.0	/	PASS
	2441	1187.0	/	PASS
	2480	1163.0	/	PASS
$\pi/4$ DQPSK	2402	1296.0	/	PASS
	2441	1289.0	/	PASS
	2480	1287.0	/	PASS
8 DPSK	2402	1311.0	/	PASS
	2441	1317.0	/	PASS
	2480	1323.0	/	PASS

Original Test data For 20dB bandwidth  
GFSK:

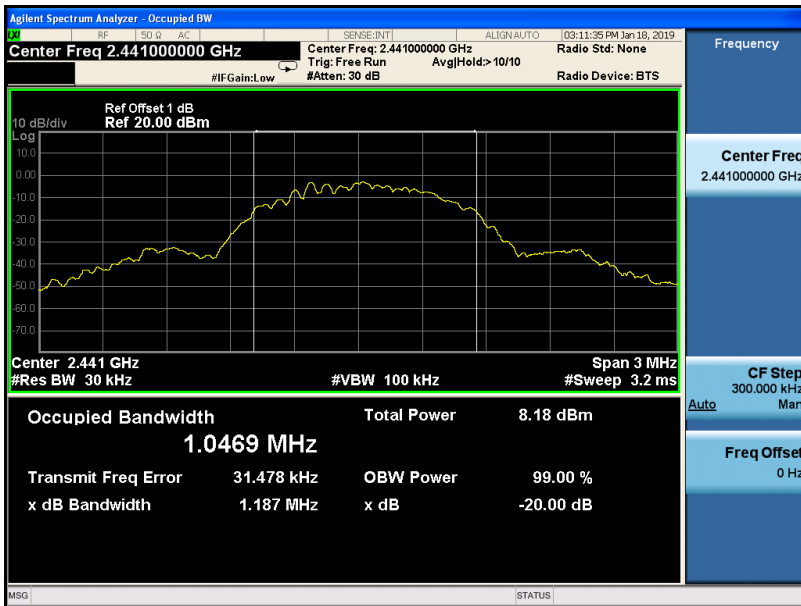
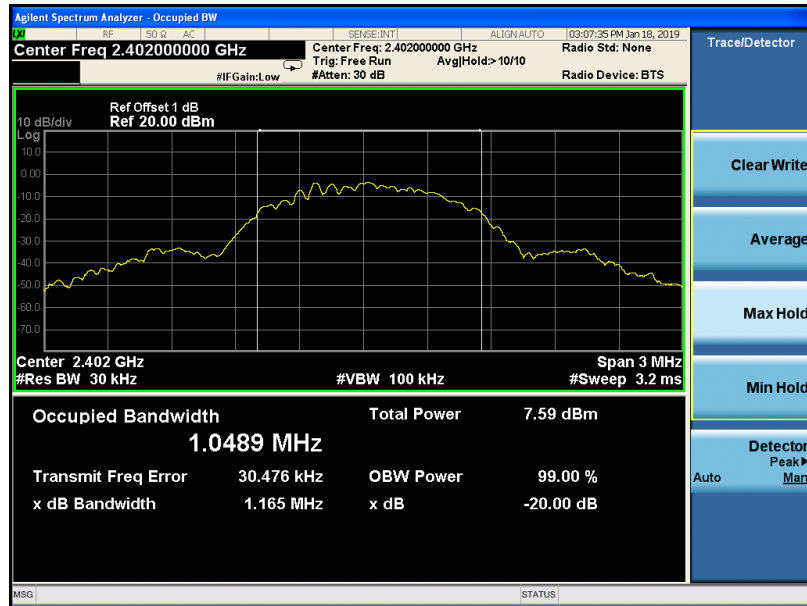

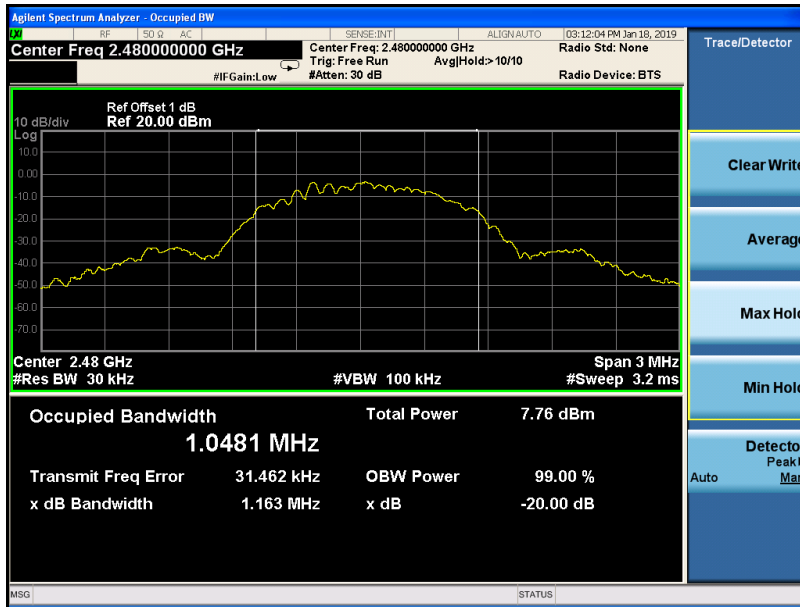

$\pi/4$  DQPSK:

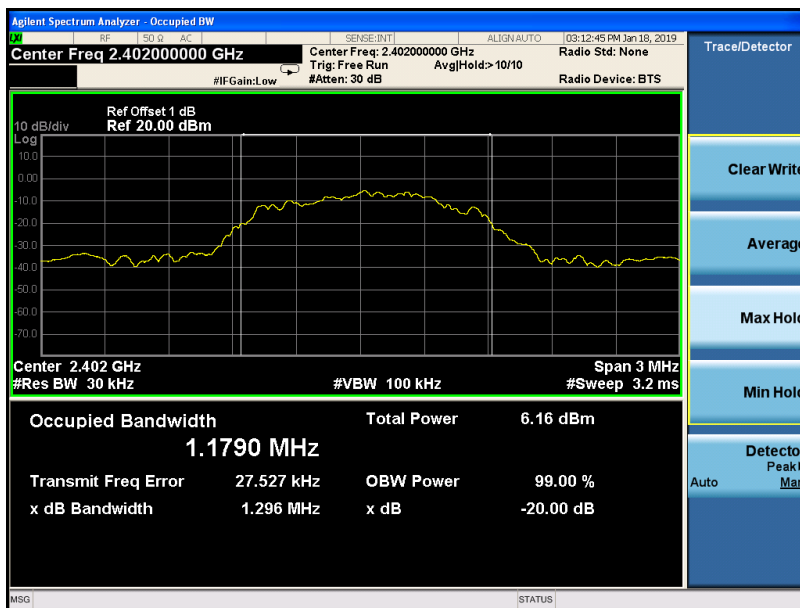

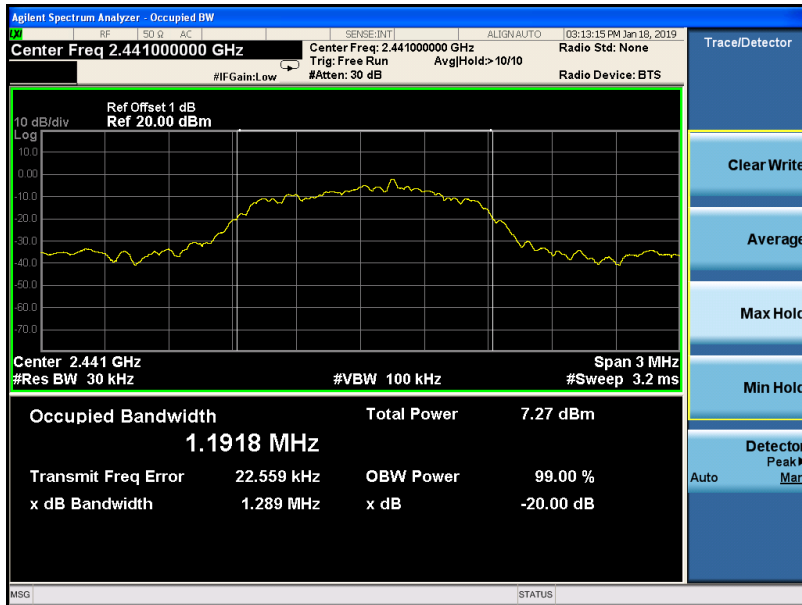



8 DPSK

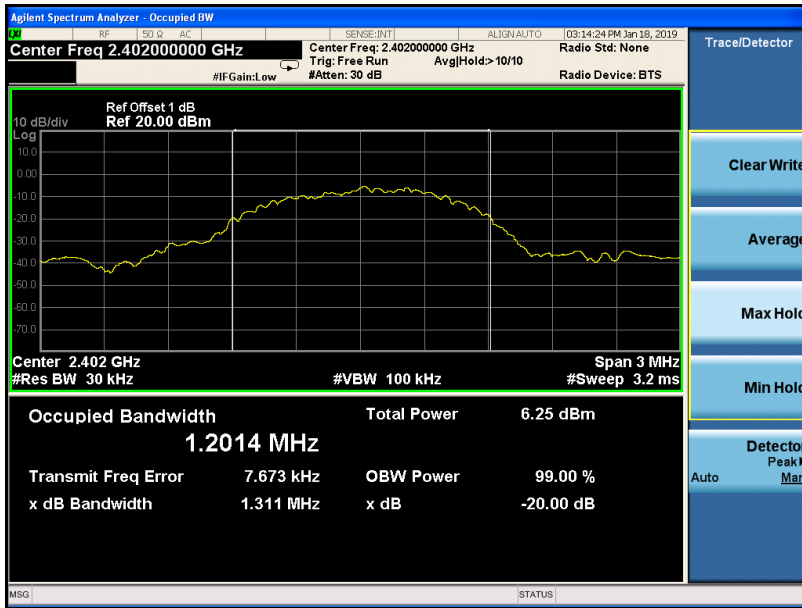



## 5. CARRIER FREQUENCY SEPARATION

### 5.1.Limit

Frequency hopping systems shall have hopping channel carrier frequencies separated by a minimum of 25 kHz or the 20 dB bandwidth of the hopping channel, whichever is greater. Alternatively, frequency hopping systems operating in the 2400-2483.5 MHz band may have hopping channel carrier frequencies that are separated by 25 kHz or two-thirds of the 20 dB bandwidth of the hopping channel, whichever is greater, provided the systems operate with an output power no greater than 125 mW

### 5.2.Test Procedure

The transmitter output was directly connected to a spectrum analyzer with a 50Ω cable. The carrier frequency was measured by spectrum analyzer with 100kHz RBW and 300kHz VBW.

### 5.3.Test Result

Mode/Channel	Channel separation (MHz)	20dB Bandwidth (KHz)	Limit (KHz)	Conclusion
GFSK	0.996	1187.0	791.33	PASS
$\pi/4$ DQPSK	0.999	1296.0	864.00	PASS
8 DPSK	1.002	1323.0	882.00	PASS

Original test data for channel separation  
GFSK



$\pi/4$  DQPSK



8 DPSK



## 6. NUMBER OF HOPPING CHANNEL

### 6.1.Limit

Frequency hopping systems in the 2400-2483.5 MHz band shall use at least 15 channels

### 6.2.Test Procedure

The transmitter output was directly connected to a spectrum analyzer with a 50 $\Omega$  cable. The number of hopping channel was measured by spectrum analyzer with 100kHz RBW and 300KHz VBW.

### 6.3.Test Result

Mode	Number of hopping channel	Limit	Conclusion
GFSK	79	>15	PASS
$\pi$ /4 DQPSK	79	>15	PASS
8 DPSK	79	>15	PASS

Original test data for hopping channel number  
GFSK

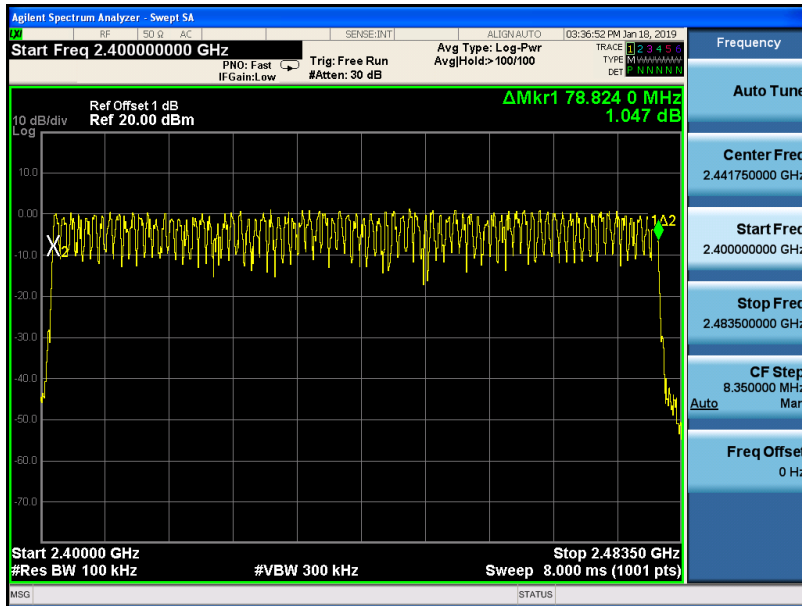

$\pi/4$  DQPSK

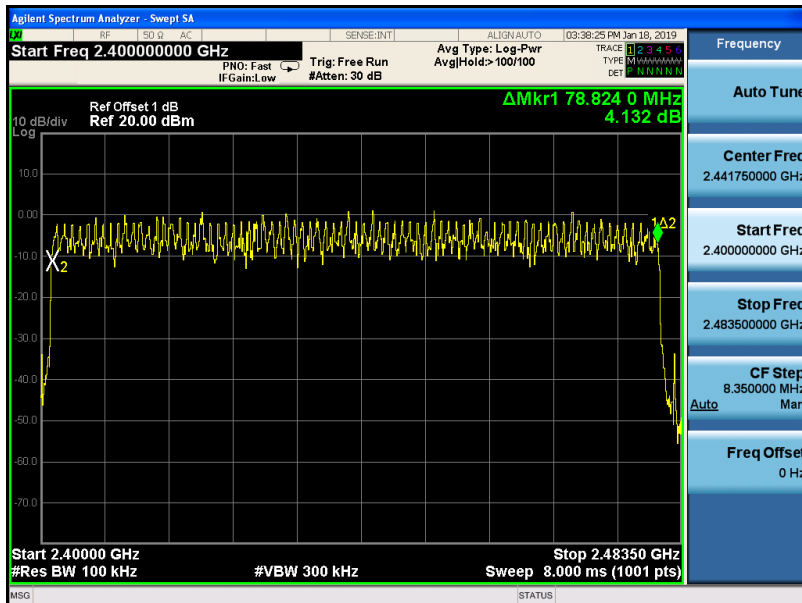

8 DPSK

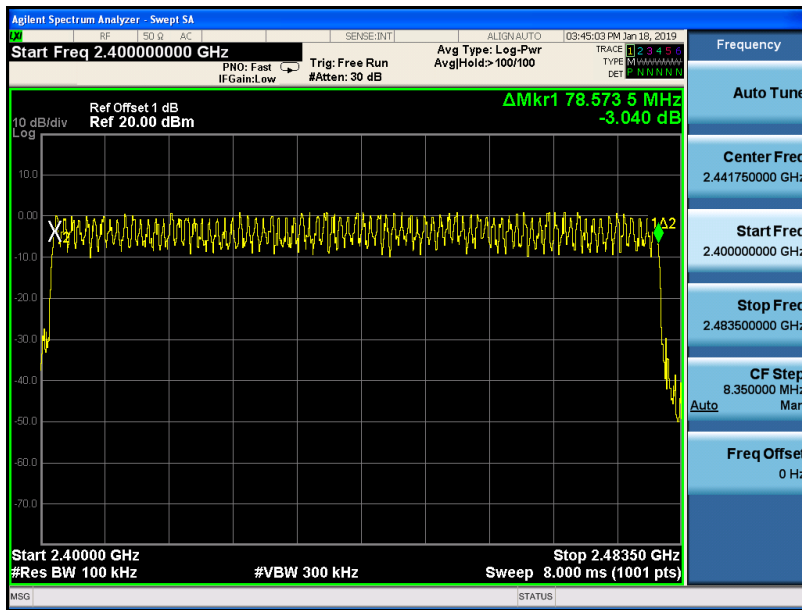



## 7. DWELL TIME

### 7.1. Test limit

Please refer section 15.247

According to §15.247(a)(1)(iii), Frequency hopping systems operating in the 2400MHz-2483.5 MHz. The average time of occupancy on any frequency shall not be greater than 0.4 s within period of 0.4 seconds multiplied by the number of hopping channels employed.

### 7.2. Test Procedure

7.2.1. Place the EUT on the table and set it in transmitting mode.

7.2.2. Remove the antenna from the EUT and then connect a low loss RF cable from the antenna port to the spectrum analyzer.

7.2.3. Set center frequency of spectrum analyzer = operating frequency.

7.2.4. Set the spectrum analyzer as RBW=1MHz, VBW=3MHz, Span = 0Hz, Sweep = auto.

7.2.5. Repeat above procedures until all frequency measurements were complete.

### 7.3. Test Result

PASS.

Detailed information please see the following page.

Mode	Data Packet	Frequency (MHz)	Pulse Duration (ms)	Dwell Time (s)	Limit (s)	Conclusion
GFSK	DH1	2441	0.3936	0.126	<0.4	PASS
	DH3	2441	1.608	0.257	<0.4	PASS
	DH5	2441	2.803	0.299	<0.4	PASS
$\pi/4$ DQPSK	2-DH1	2441	0.3984	0.127	<0.4	PASS
	2-DH3	2441	1.608	0.257	<0.4	PASS
	2-DH5	2441	2.808	0.300	<0.4	PASS
8 DPSK	3-DH1	2441	0.3984	0.127	<0.4	PASS
	3-DH3	2441	1.608	0.257	<0.4	PASS
	3-DH5	2441	2.813	0.300	<0.4	PASS

Note: 1 A period time =  $0.4 \text{ (s)} * 79 = 31.6 \text{ (s)}$

2 DH1 time slot =  $\text{Pulse Duration} * (1600/(2*79)) * \text{A period time}/1000$

DH3 time slot =  $\text{Pulse Duration} * (1600/(4*79)) * \text{A period time}/1000$

DH5 time slot =  $\text{Pulse Duration} * (1600/(6*79)) * \text{A period time}/1000$

GFSK

DH1:

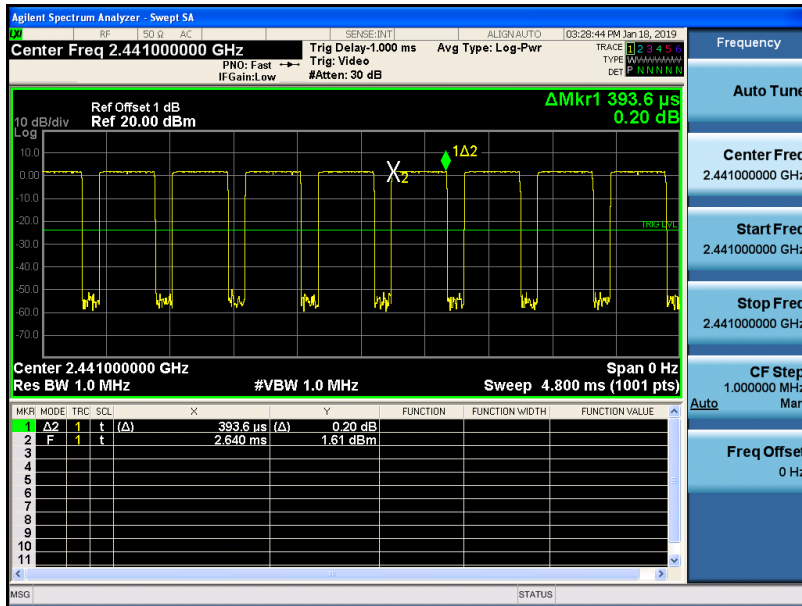

DH3:

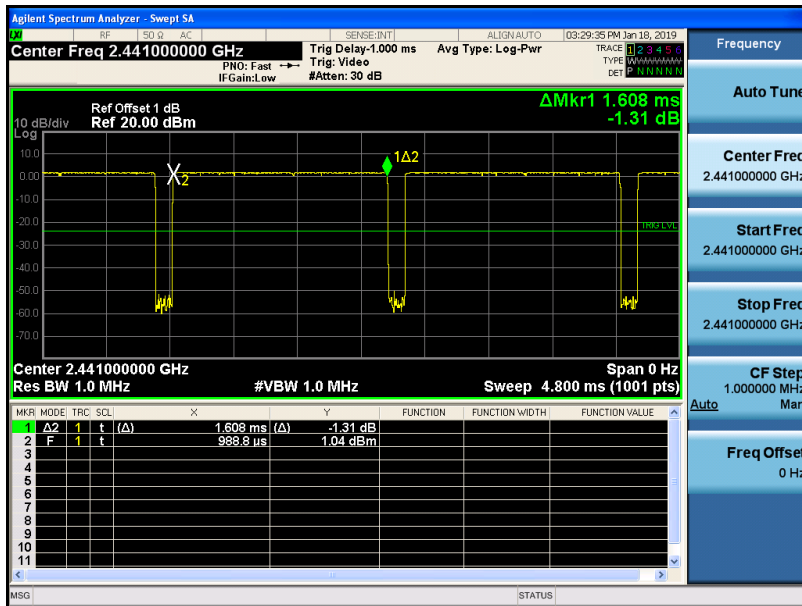



DH3

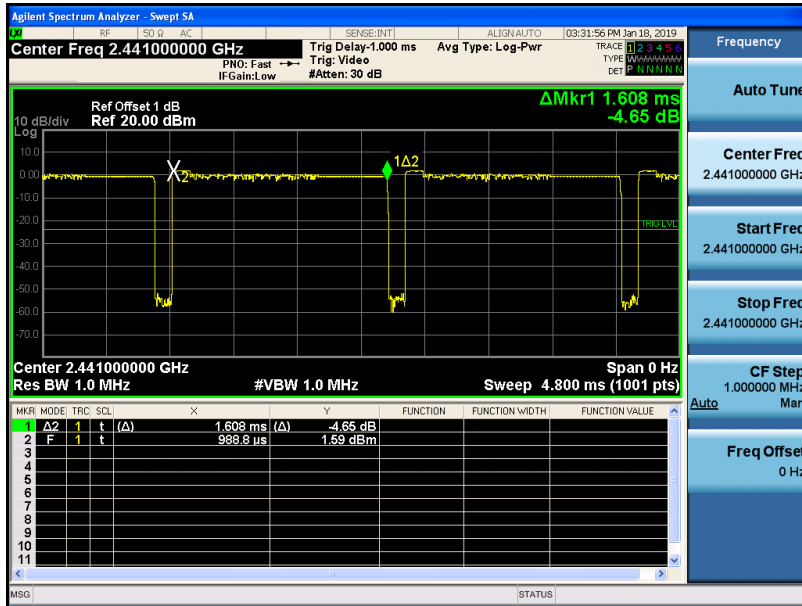

DH5

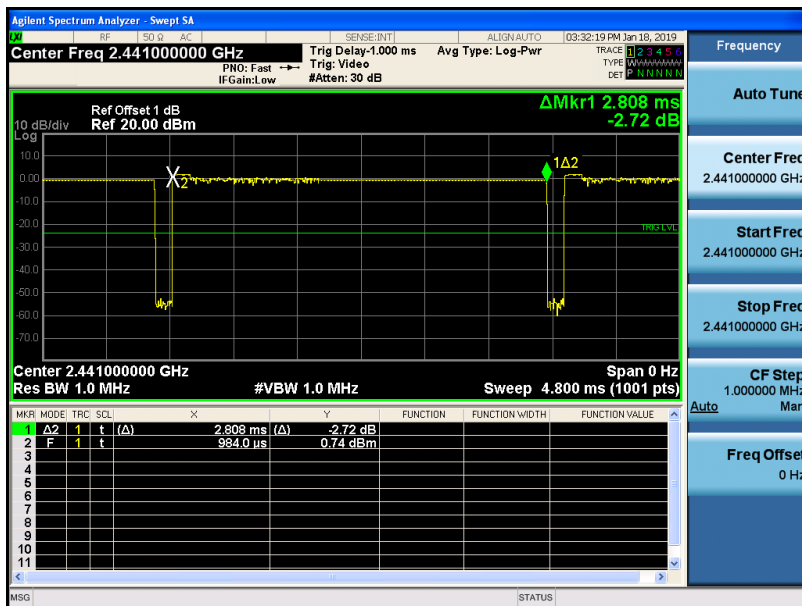

8 DPSK  
DH1

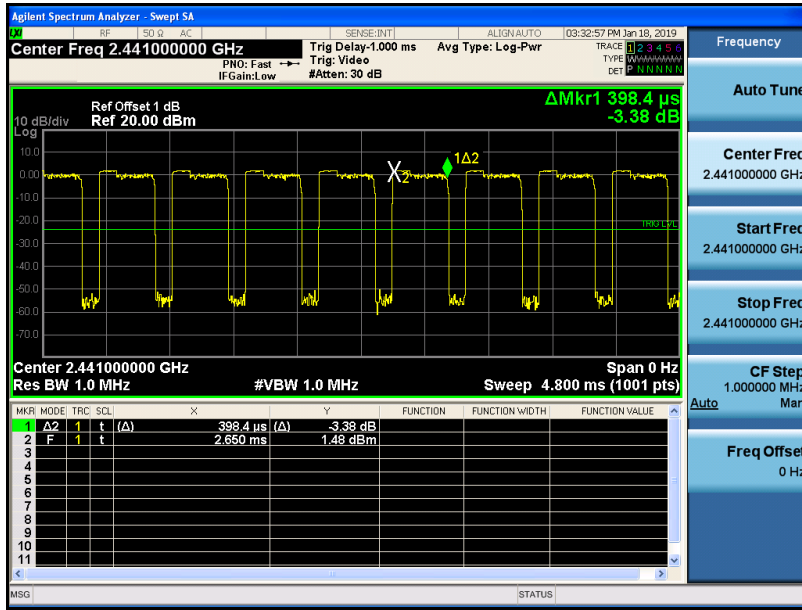

DH3

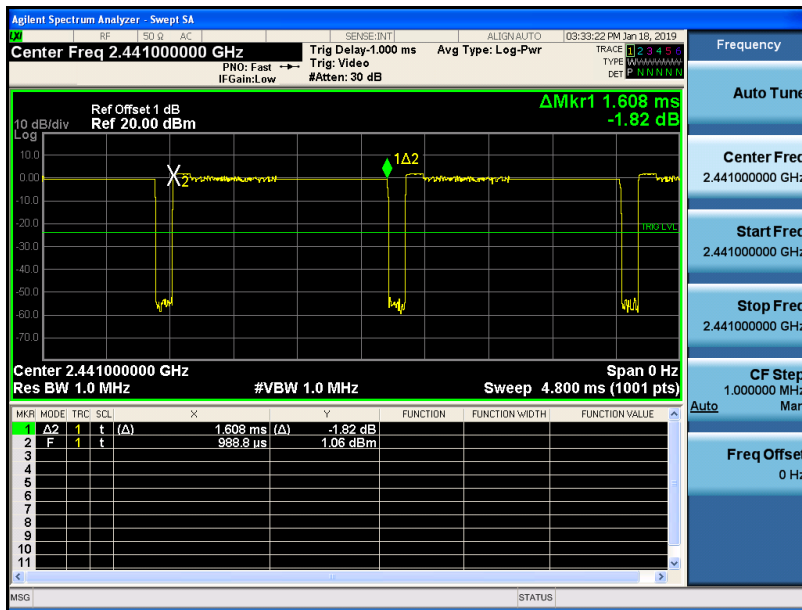

DH5

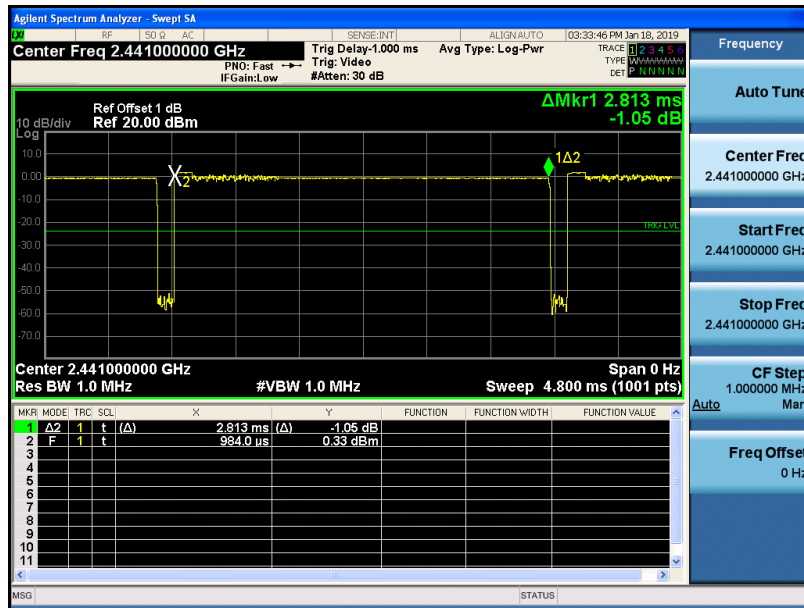

## 8. RADIATED EMISSIONS

### 8.1.Limit

All the emissions appearing within 15.205 restricted frequency bands shall not exceed the limits shown in 15.209, all the other emissions shall be at least 20dB below the fundamental emissions, or comply with 15.209 limits.

#### 15.205 Restricted frequency band

MHz	MHz	MHz	GHz
0.090 - 0.110	16.42 - 16.423	399.9 - 410	4.5 - 5.15
<sup>1</sup> 0.495 - 0.505	16.69475 - 16.69525	608 - 614	5.35 - 5.46
2.1735 - 2.1905	16.80425 - 16.80475	960 - 1240	7.25 - 7.75
4.125 - 4.128	25.5 - 25.67	1300 - 1427	8.025 - 8.5
4.17725 - 4.17775	37.5 - 38.25	1435 - 1626.5	9.0 - 9.2
4.20725 - 4.20775	73 - 74.6	1645.5 - 1646.5	9.3 - 9.5
6.215 - 6.218	74.8 - 75.2	1660 - 1710	10.6 - 12.7
6.26775 - 6.26825	108 - 121.94	1718.8 - 1722.2	13.25 - 13.4
6.31175 - 6.31225	123 - 138	2200 - 2300	14.47 - 14.5
8.291 - 8.294	149.9 - 150.05	2310 - 2390	15.35 - 16.2
8.362 - 8.366	156.52475 - 156.52525	2483.5 - 2500	17.7 - 21.4
8.37625 - 8.38675	156.7 - 156.9	2690 - 2900	22.01 - 23.12
8.41425 - 8.41475	162.0125 - 167.17	3260 - 3267	23.6 - 24.0
12.29 - 12.293	167.72 - 173.2	3332 - 3339	31.2 - 31.8
12.51975 - 12.52025	240 - 285	3345.8 - 3358	36.43 - 36.5
12.57675 - 12.57725	322 - 335.4	3600 - 4400	( <sup>2</sup> )

#### 15.209 Limit

FREQUENCY MHz	DISTANCE Meters	FIELD STRENGTHS LIMIT	
		$\mu\text{V}/\text{m}$	$\text{dB}(\mu\text{V})/\text{m}$
0.009-0.490	300	2400/F(KHz)	/
0.490-1.705	30	24000/F(KHz)	/
1.705-30	30	30	29.5
30 ~ 88	3	100	40.0
88 ~ 216	3	150	43.5
216 ~ 960	3	200	46.0
960 ~ 1000	3	500	54.0
Above 1000	3	74.0 dB( $\mu\text{V}$ )/m (Peak) 54.0 dB( $\mu\text{V}$ )/m (Average)	



## 8.2. Block Diagram of Test setup

### 8.2.1 In 3m Anechoic Chamber Test Setup Diagram for below 1GHz

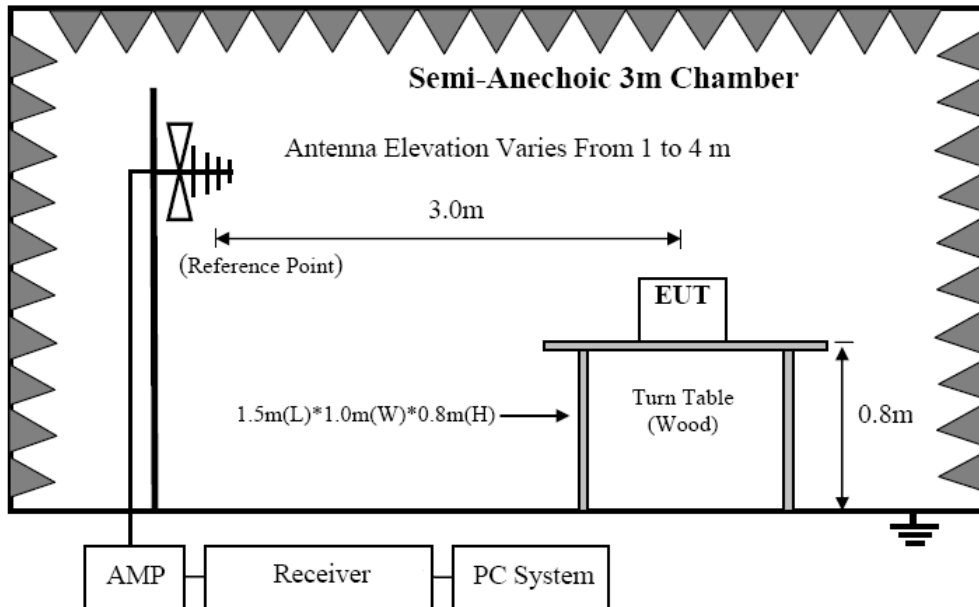

### 8.2.2 In 3m Anechoic Chamber Test Setup Diagram for frequency above 1GHz

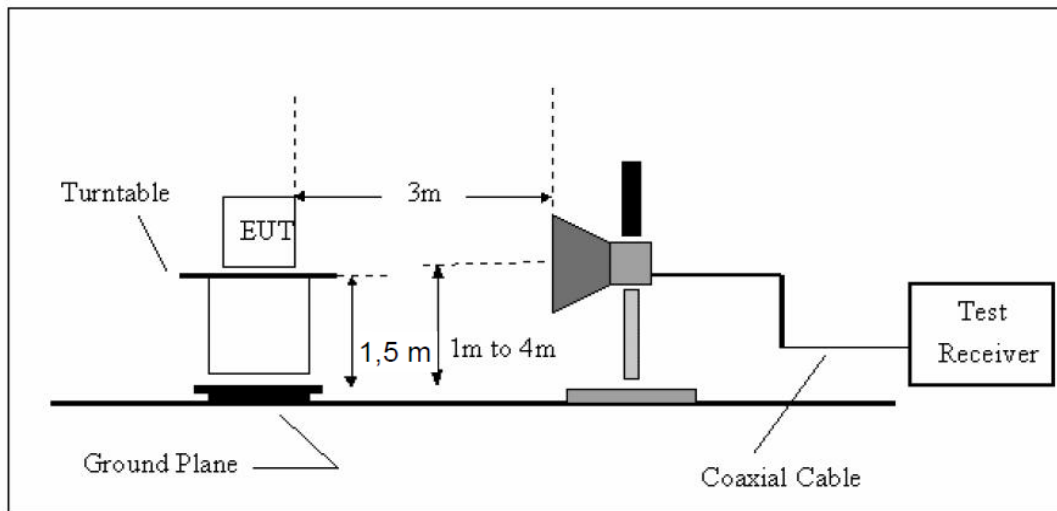

Note: For harmonic emissions test a appropriate high pass filter was inserted in the input port of AMP.

### 8.3. Test Procedure

- (1) EUT was placed on a non-metallic table, 80 cm above the ground plane inside a semi-anechoic chamber for below 1GHz test, 150 cm above the ground plane inside a semi-anechoic chamber for above 1GHz test
- (2) Setup EUT and simulator as shown in section 1.4 and 6.1
- (3) Test antenna was located 3m from the EUT on an adjustable mast. Below pre-scan procedure was first performed in order to find prominent radiated emissions.
  - (a) Change work frequency or channel of device if practicable.
  - (b) Change modulation type of device if practicable.
  - (c) Rotated EUT though three orthogonal axes to determine the attitude of EUT arrangement produces highest emissions
- (4) Spectrum frequency from 9KHz to 25GHz (tenth harmonic of fundamental frequency) was investigated
- (5) For final emissions measurements at each frequency of interest, the EUT were rotated and the antenna height was varied between 1m and 4m in order to maximize the emission. Measurements in both horizontal and vertical polarities were made and the data was recorded. In order to find the maximum emission, the relative positions of equipments and all of the interface cables were changed according to ANSI C63.10:2013on Radiated Emission test.
- (6) For emissions above 1GHz, both Peak and Average level were measured with Spectrum Analyzer, and the RBW is set at 1MHz, VBW is set at 3MHz for Peak measure; RBW is set at 1MHz, VBW is set at 10Hz for Average measure.

### 8.4. Test Result

We have scanned the 10th harmonic from 9KHz to the EUT's highest frequency..  
Detailed information please see the following page.

From 9KHz to 30MHz: Conclusion: PASS

Note: The amplitude of spurious emissions which are attenuated by more than 20dB below the permissible value has no need to be reported.

From 30MHz to 1000MHz: Conclusion: PASS

Polarization: *Vertical*

**Radiated Emission Measurement**

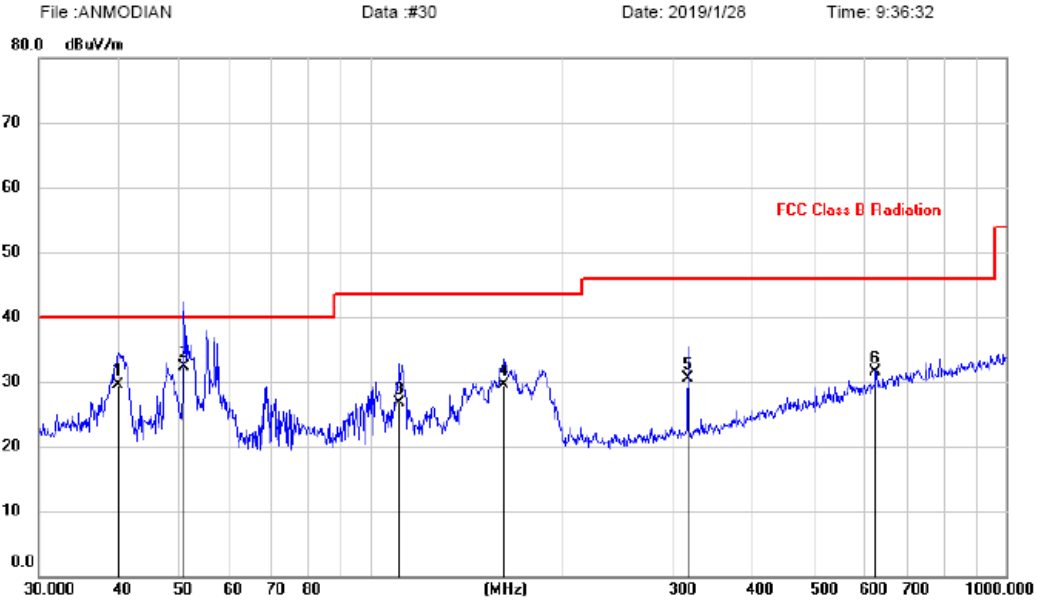

No.	Mk.	Freq.	Reading Level	Correct Factor	Measurement	Limit	Margin	Antenna Height	Table Degree	
		MHz	dBuV	dB	dBuV/m	dBuV/m	dB	cm	degree	Comment
1		39.9942	15.22	14.24	29.46	40.00	-10.54	300	0	
2	*	50.9419	18.73	13.64	32.37	40.00	-7.63	300	0	
3		110.9570	14.99	11.62	26.61	43.50	-16.89	200	0	
4		162.6105	15.18	14.37	29.55	43.50	-13.95	200	360	
5		316.5889	16.66	13.79	30.45	46.00	-15.55	200	360	
6		622.8900	11.74	19.71	31.45	46.00	-14.55	100	0	

Note:1. \*:Maximum data; x:Over limit; !:over margin.

2.Measurement=Reading Level+Correct Factor; Correct Factor=Antenna Factor+Cable Loss.

Polarization: *Horizontal*

**Radiated Emission Measurement**

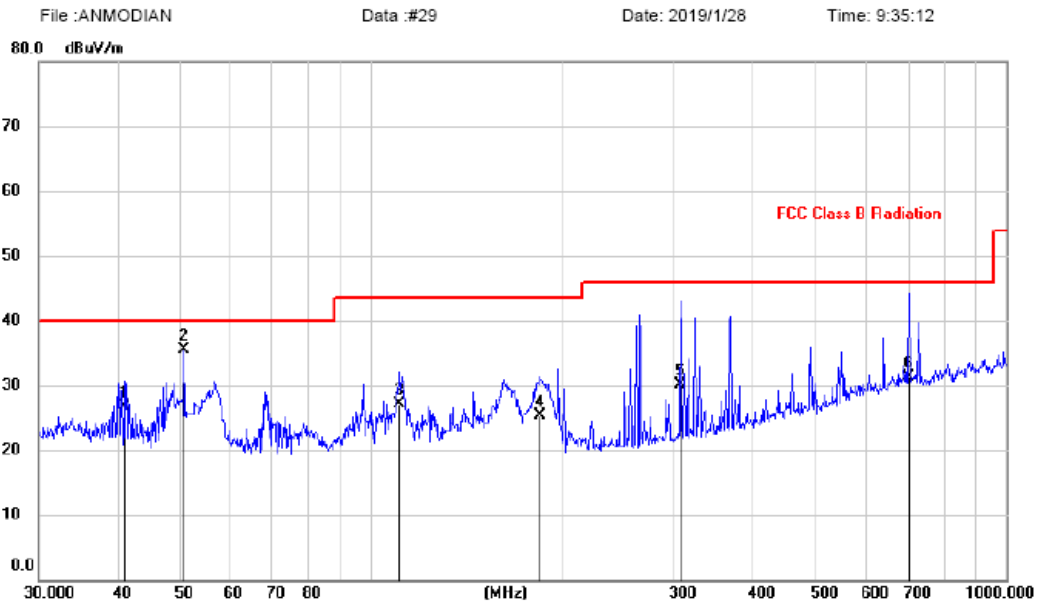

No.	Mk.	Freq.	Reading Level	Correct Factor	Measurement	Limit	Margin	Antenna Height	Table Degree	
		MHz	dBuV	dB	dBuV/m	dBuV/m	dB	cm	degree	Comment
1		40.9881	12.64	14.11	26.75	40.00	-13.25	300	0	
2	*	50.9419	21.83	13.64	35.47	40.00	-4.53	300	360	
3		110.9570	15.44	11.62	27.06	43.50	-16.44	200	0	
4		184.4898	13.73	11.61	25.34	43.50	-18.16	200	0	
5		306.7537	16.54	13.59	30.13	46.00	-15.87	100	360	
6		701.7610	10.92	20.40	31.32	46.00	-14.68	100	0	

Note: 1. \*:Maximum data; x:Over limit; !:over margin.  
 2.Measurement=Reading Level+Correct Factor; Correct Factor=Antenna Factor+Cable Loss.

Remark: All modes have been tested, and only worst data of BT TX GFSK CH0 Link was listed in this report.

From 1G-25GHz

Test Mode: GFSK TX Low									
Freq (MHz)	Read Level (dBuV/m)	Polar (H/V)	Antenna Factor (dB/m)	Cable loss(dB)	Amp Factor (dB)	Result (dBuV/m)	Limit (dBuV/m)	Margin (dB)	Remark
4804	43.98	V	33.95	10.18	34.26	53.85	74	20.15	PK
4804	34.69	V	33.95	10.18	34.26	44.56	54	9.44	AV
7206	/		/						
9608	/		/						
4804	43.72	H	33.95	10.18	34.26	53.59	74	20.41	PK
4804	34.27	H	33.95	10.18	34.26	44.14	54	9.86	AV
7206									
9608									
Test Mode: GFSK TX Mid									
4882	41.02	V	33.93	10.2	34.29	50.86	74	23.14	PK
4882	32.49	V	33.93	10.2	34.29	42.33	54	11.67	AV
7323	/								
9764	/								
4882	42.03	H	33.93	10.2	34.29	51.87	74	22.13	PK
4882	32.58	H	33.93	10.2	34.29	42.42	54	11.58	AV
7323									
9764									
Test Mode: GFSK TX High									
4960	42.72	V	33.98	10.22	34.25	52.67	74	21.33	PK
4960	32.75	V	33.98	10.22	34.25	42.70	54	11.30	AV
7440	/								
9920	/								
4960	42.31	H	33.98	10.22	34.25	52.26	74	21.74	PK
4960	31.97	H	33.98	10.22	34.25	41.92	54	12.08	AV
7440	/								
9920	/								
Note:									
1, Result = Read level + Antenna factor + cable loss-Amp factor									
2, All the other emissions not reported were too low to read and deemed to comply with FCC limit.									

From 1G-25GHz

Test Mode: $\pi/4$ DQPSK TX Low									
Freq (MHz)	Read Level (dBuV/m)	Polar (H/V)	Antenna Factor (dB/m)	Cable loss(dB)	Amp Factor (dB)	Result (dBuV/m)	Limit (dBuV/m)	Margin (dB)	Remark
4804	43.01	V	33.95	10.18	34.26	52.88	74	21.12	PK
4804	31.61	V	33.95	10.18	34.26	41.48	54	12.52	AV
7206	/		/						
9608	/		/						
4804	43.84	H	33.95	10.18	34.26	53.71	74	20.29	PK
4804	31.91	H	33.95	10.18	34.26	41.78	54	12.22	AV
7206									
9608									
Test Mode: $\pi/4$ DQPSK TX Mid									
4882	43.50	V	33.93	10.2	34.25	53.38	74	20.62	PK
4882	30.47	V	33.93	10.2	34.25	40.35	54	13.65	AV
7323	/								
9764	/								
4882	43.15	H	33.93	10.2	34.29	52.99	74	21.01	PK
4882	32.74	H	33.93	10.2	34.29	42.58	54	11.42	AV
7323									
9764									
Test Mode: $\pi/4$ DQPSK TX High									
4960	42.26	V	33.98	10.22	34.25	52.21	74	21.79	PK
4960	32.32	V	33.98	10.22	34.25	42.27	54	11.73	AV
7440	/								
9920	/								
4960	43.08	H	33.98	10.22	34.25	53.03	74	20.97	PK
4960	31.79	H	33.98	10.22	34.25	41.74	54	12.26	AV
7440	/								
9920	/								
Note:									
1, Result = Read level + Antenna factor + cable loss-Amp factor									
2, All the other emissions not reported were too low to read and deemed to comply with FCC limit.									

From 1G-25GHz

Test Mode: 8 DPSK TX Low									
Freq (MHz)	Read Level (dBuV/m)	Polar (H/V)	Antenna Factor (dB/m)	Cable loss(dB)	Amp Factor (dB)	Result (dBuV/m)	Limit (dBuV/m)	Margin (dB)	Remark
4804	41.44	V	33.95	10.18	34.26	51.31	74	22.69	PK
4804	32.26	V	33.95	10.18	34.26	42.13	54	11.87	AV
7206	/		/						
9608	/		/						
4804	40.92	H	33.95	10.18	34.26	50.79	74	23.21	PK
4804	32.30	H	33.95	10.18	34.26	42.17	54	11.83	AV
7206									
9608									
Test Mode: 8 DPSK TX Mid									
4882	42.19	V	33.93	10.2	34.29	52.03	74	21.97	PK
4882	32.05	V	33.93	10.2	34.29	41.89	54	12.11	AV
7323	/								
9764	/								
4882	42.65	H	33.93	10.2	34.29	52.49	74	21.51	PK
4882	33.15	H	33.93	10.2	34.29	42.99	54	11.01	AV
7323									
9764									
Test Mode: 8 DPSK TX High									
4960	41.76	V	33.98	10.22	34.25	51.71	74	22.29	PK
4960	32.37	V	33.98	10.22	34.25	42.32	54	11.68	AV
7440	/								
9920	/								
4960	42.13	H	33.98	10.22	34.25	52.08	74	21.92	PK
4960	33.56	H	33.98	10.22	34.25	43.51	54	10.49	AV
7440	/								
9920	/								
Note:									
1, Result = Read level + Antenna factor + cable loss-Amp factor									
2, All the other emissions not reported were too low to read and deemed to comply with FCC limit.									

## 9. BAND EDGE COMPLIANCE

### 9.1. Block Diagram of Test Setup

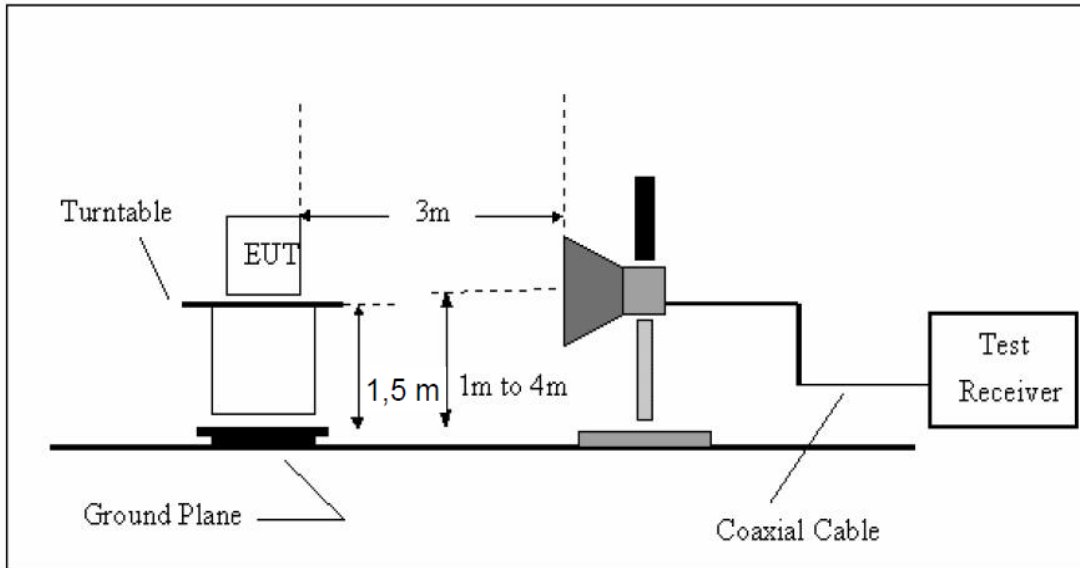

### 9.2. Limit

All the lower and upper band-edges emissions appearing within restricted frequency bands shall not exceed the limits shown in 15.209, all the other emissions outside operation shall be at least 20dB below the fundamental emissions, or comply with 15.209 limits.

### 9.3. Test Procedure

All restriction band and non- restriction band have been tested , only worse case is reported.

### 9.4. Test Result

PASS. (See below detailed test data)



Radiated Method:

Polarization: Vertical

Test Mode: GFSK-Low

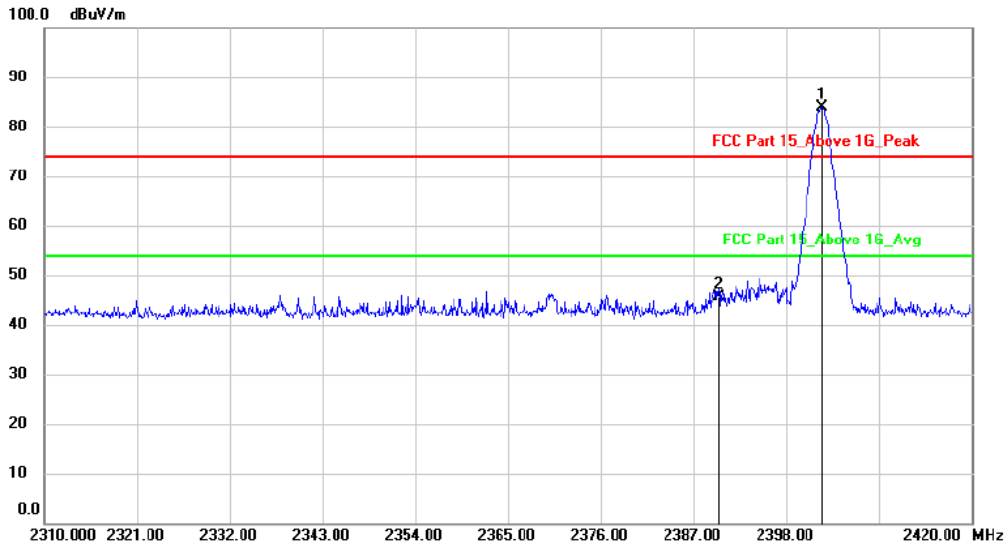

No.	Mk.	Freq.	Reading Level	Correct Factor	Measurement	Limit	Margin	Antenna Height	Table Degree	
		MHz	dBuV	dB	dBuV/m	dBuV/m	dB	cm	degree	Comment
1	*	2402.180	87.27	-3.41	83.86	74.00	9.86	peak		
2		2390.000	49.00	-3.40	45.60	74.00	-28.40	peak		

hopping-off

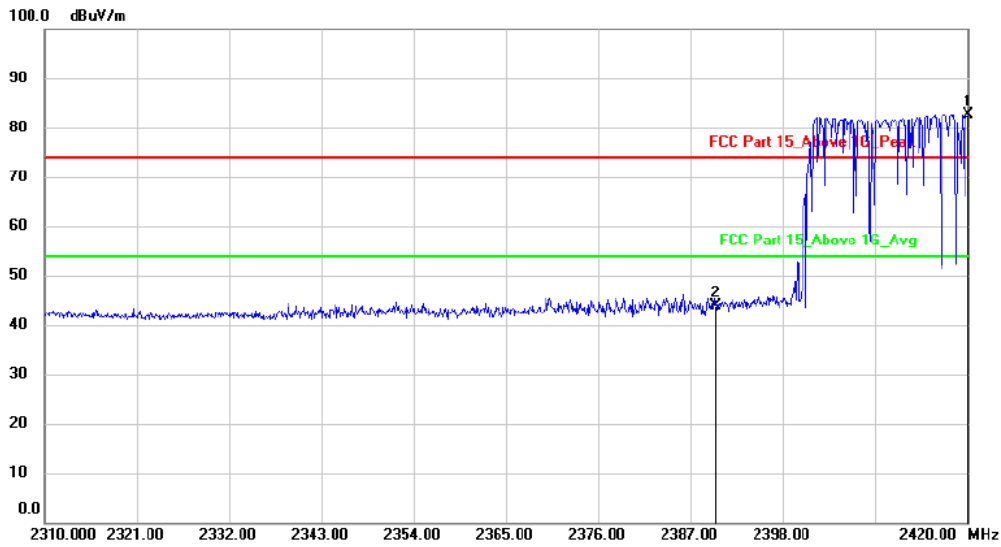

No.	Mk.	Freq.	Reading Level	Correct Factor	Measurement	Limit	Margin	Antenna Height	Table Degree	
		MHz	dBuV	dB	dBuV/m	dBuV/m	dB	cm	degree	Comment
1	*	2420.000	86.06	-3.41	82.65	74.00	8.65	peak		
2		2390.000	47.22	-3.40	43.82	74.00	-30.18	peak		

hopping-on

Polarization: Horizontal Test Mode: GFSK-Low

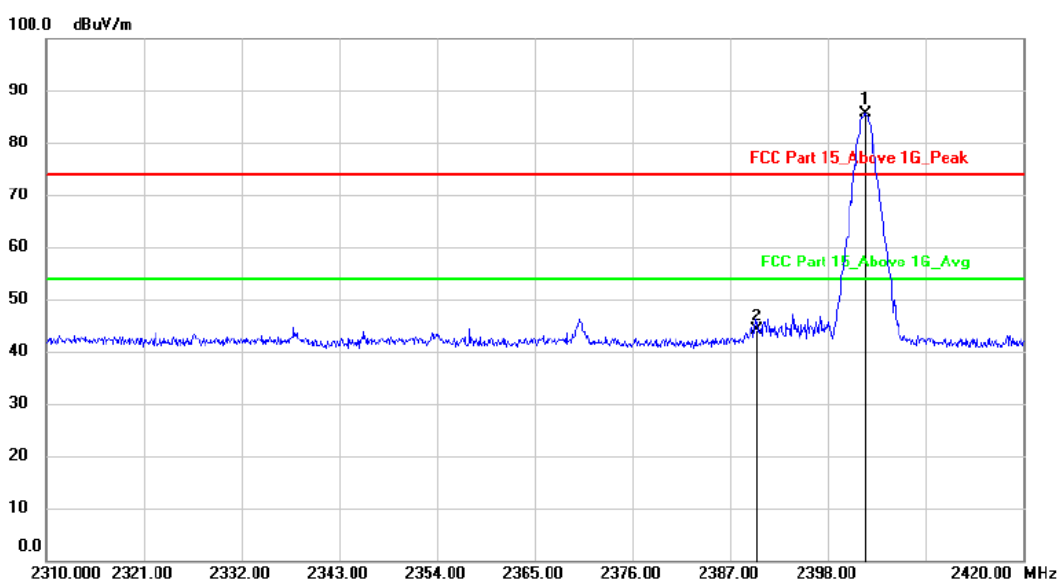

No.	Mk.	Freq.	Reading Level	Correct Factor	Measurement	Limit	Margin	Antenna Height	Table Degree	
		MHz	dBuV	dB	dBuV/m	dBuV/m	dB	cm	degree	Comment
1	*	2402.180	89.08	-3.41	85.67	74.00	11.67	peak		
2		2390.000	47.42	-3.40	44.02	74.00	-29.98	peak		

hopping-off

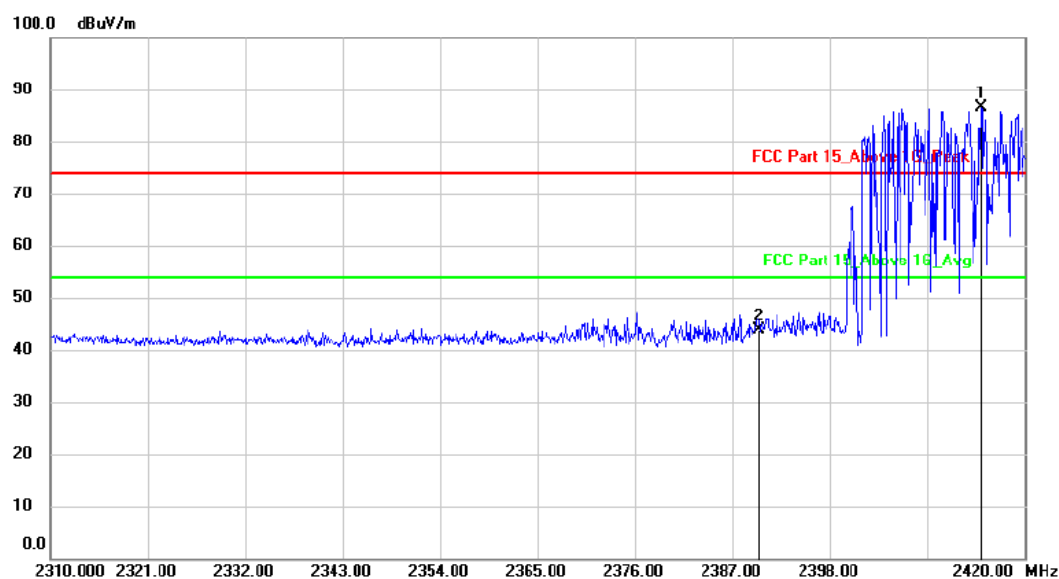

No.	Mk.	Freq.	Reading Level	Correct Factor	Measurement	Limit	Margin	Antenna Height	Table Degree	
		MHz	dBuV	dB	dBuV/m	dBuV/m	dB	cm	degree	Comment
1	*	2415.050	90.00	-3.41	86.59	74.00	12.59	peak		
2		2390.000	47.40	-3.40	44.00	74.00	-30.00	peak		

hopping-on

Polarization: Vertical

Test Mode: GFSK-High

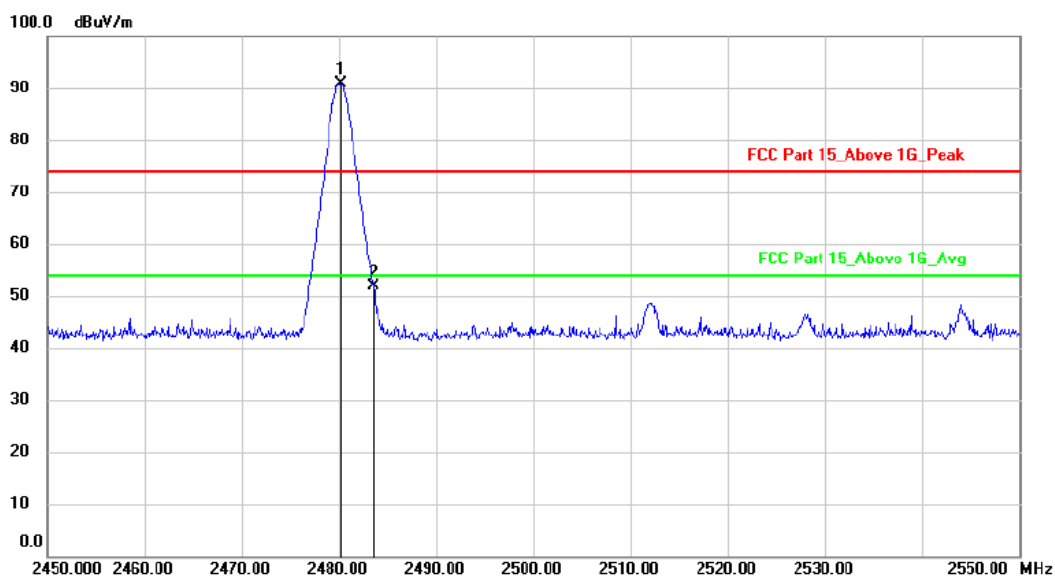

No.	Mk.	Freq.	Reading Level	Correct Factor	Measurement	Limit	Margin	Antenna Height	Table Degree	
		MHz	dBuV	dB	dBuV/m	dBuV/m	dB	cm	degree	Comment
1	*	2480.200	94.35	-3.38	90.97	74.00	16.97			peak
2		2483.500	55.21	-3.38	51.83	74.00	-22.17			peak

hopping-off

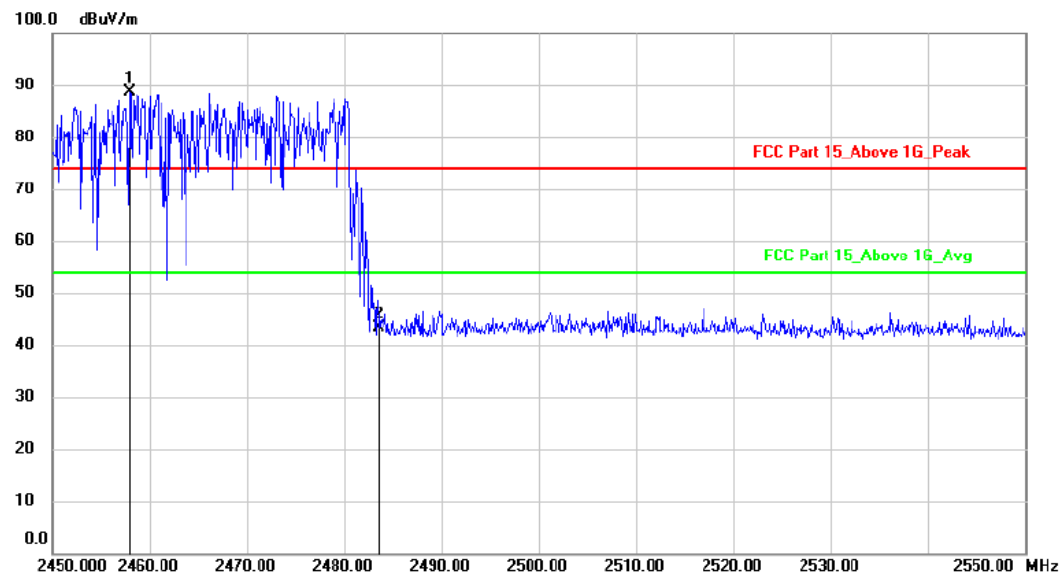

No.	Mk.	Freq.	Reading Level	Correct Factor	Measurement	Limit	Margin	Antenna Height	Table Degree	
		MHz	dBuV	dB	dBuV/m	dBuV/m	dB	cm	degree	Comment
1	*	2457.900	92.00	-3.39	88.61	74.00	14.61			peak
2		2483.500	46.75	-3.38	43.37	74.00	-30.63			peak

hopping-on

Polarization: Horizontal

Test Mode: GFSK-High

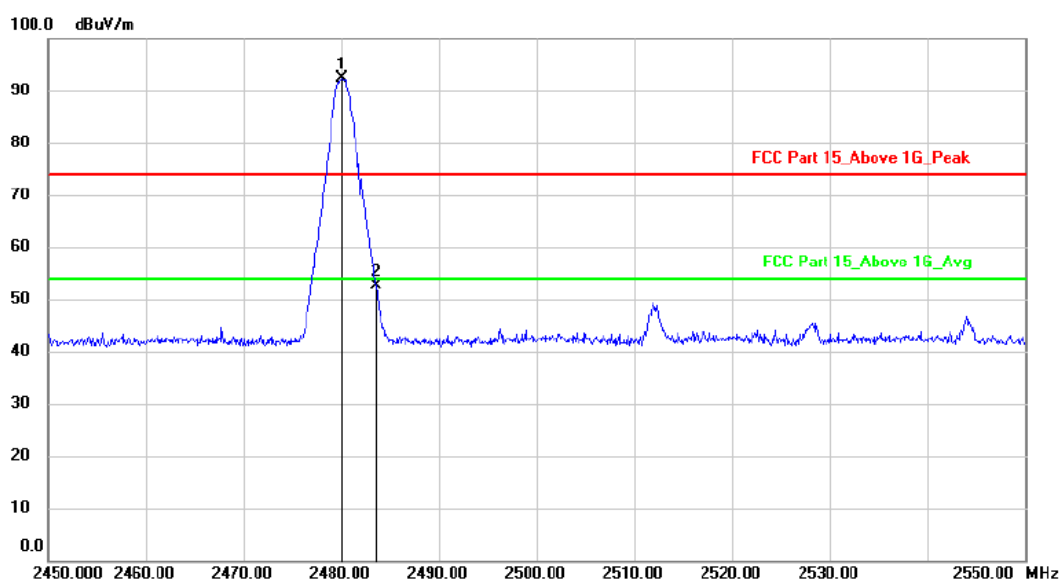

No.	Mk.	Freq.	Reading Level	Correct Factor	Measurement	Limit	Margin	Antenna Height	Table Degree
		MHz	dBuV	dB	dBuV/m	dBuV/m	dB	cm	degree
1	*	2480.000	95.86	-3.38	92.48	74.00	18.48	peak	
2		2483.500	56.07	-3.38	52.69	74.00	-21.31	peak	

hopping-off

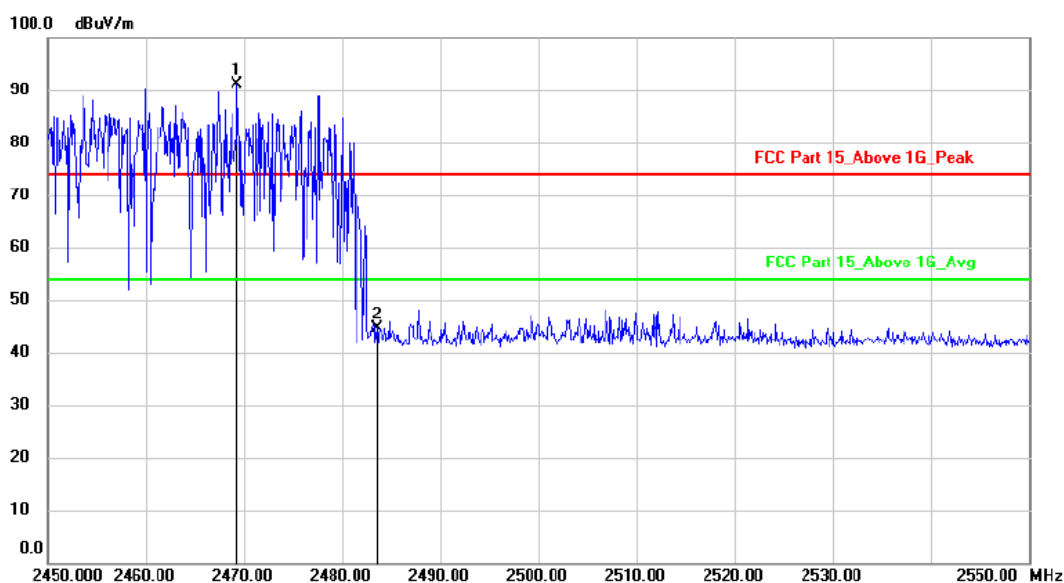

No.	Mk.	Freq.	Reading Level	Correct Factor	Measurement	Limit	Margin	Antenna Height	Table Degree
		MHz	dBuV	dB	dBuV/m	dBuV/m	dB	cm	degree
1	*	2469.300	94.52	-3.39	91.13	74.00	17.13	peak	
2		2483.500	47.89	-3.38	44.51	74.00	-29.49	peak	

hopping-on

Polarization: Vertical

Test Mode:  $\pi/4$  DQPSK-Low

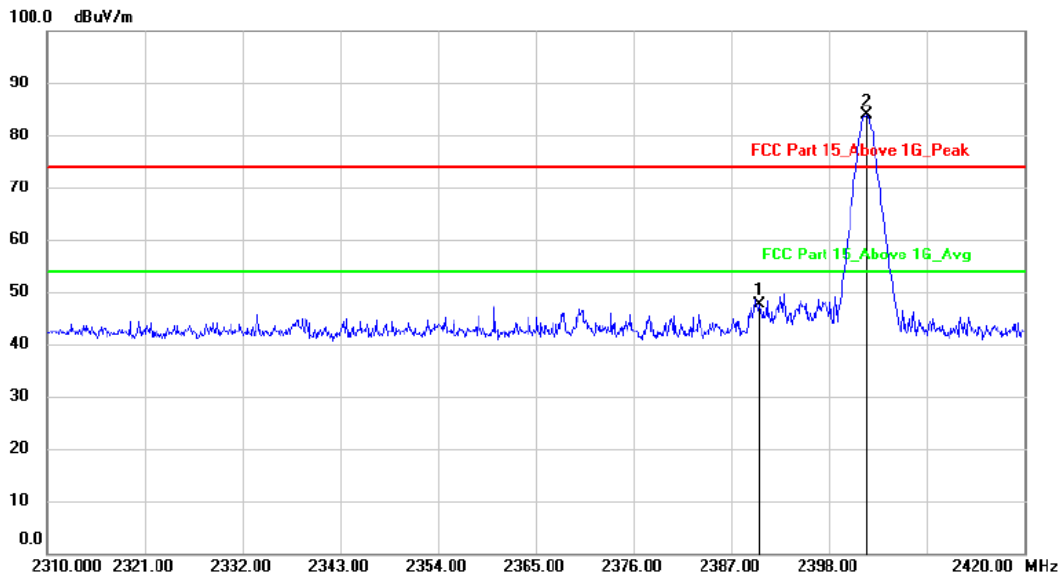

No.	Mk.	Freq. MHz	Reading Level dBuV	Correct Factor dB	Measure- ment dBuV/m	Limit dBuV/m	Margin dB	Antenna Height cm	Table Degree degree	Comment
1		2390.000	51.13	-3.40	47.73	74.00	-26.27	peak		
2	*	2402.180	87.28	-3.41	83.87	74.00	9.87	peak		

hopping-off

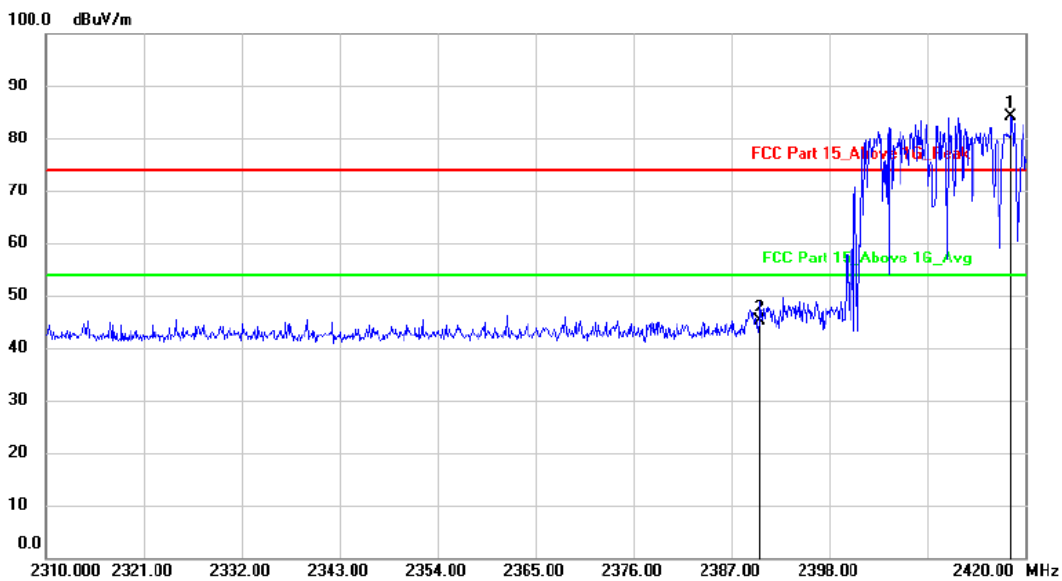

No.	Mk.	Freq. MHz	Reading Level dBuV	Correct Factor dB	Measure- ment dBuV/m	Limit dBuV/m	Margin dB	Antenna Height cm	Table Degree degree	Comment
1	*	2418.350	87.58	-3.41	84.17	74.00	10.17	peak		
2		2390.000	48.60	-3.40	45.20	74.00	-28.80	peak		

hopping-on

Polarization: Horizontal

Test Mode:  $\pi/4$  DQPSK-Low

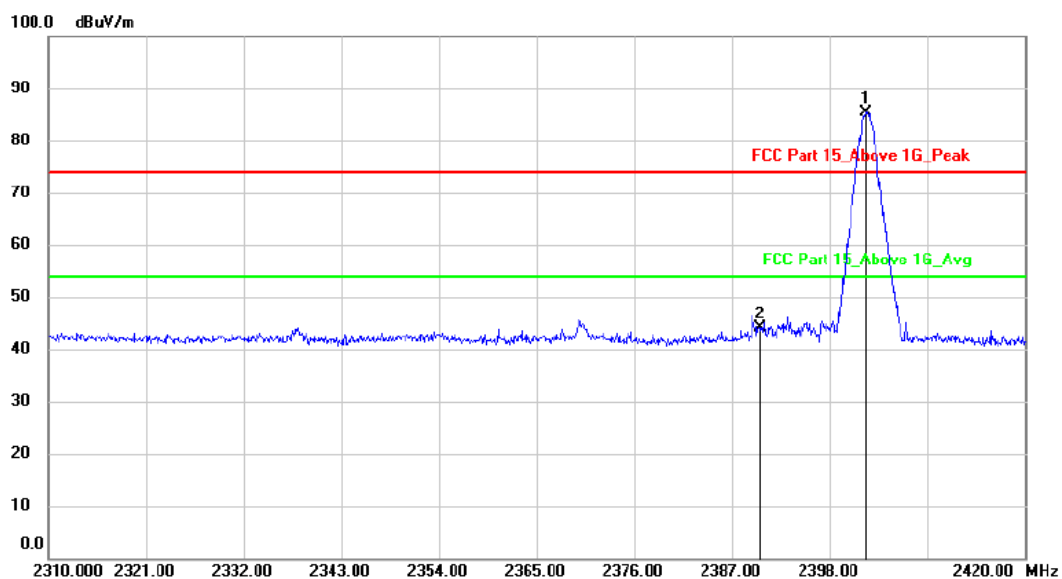

No.	Mk.	Freq.	Reading Level	Correct Factor	Measurement	Limit	Margin	Antenna Height	Table Degree	
		MHz	dBuV	dB	dBuV/m	dBuV/m	dB	cm	degree	Comment
1	*	2401.960	88.85	-3.41	85.44	74.00	11.44	peak		
2		2390.000	47.52	-3.40	44.12	74.00	-29.88	peak		

hopping-off

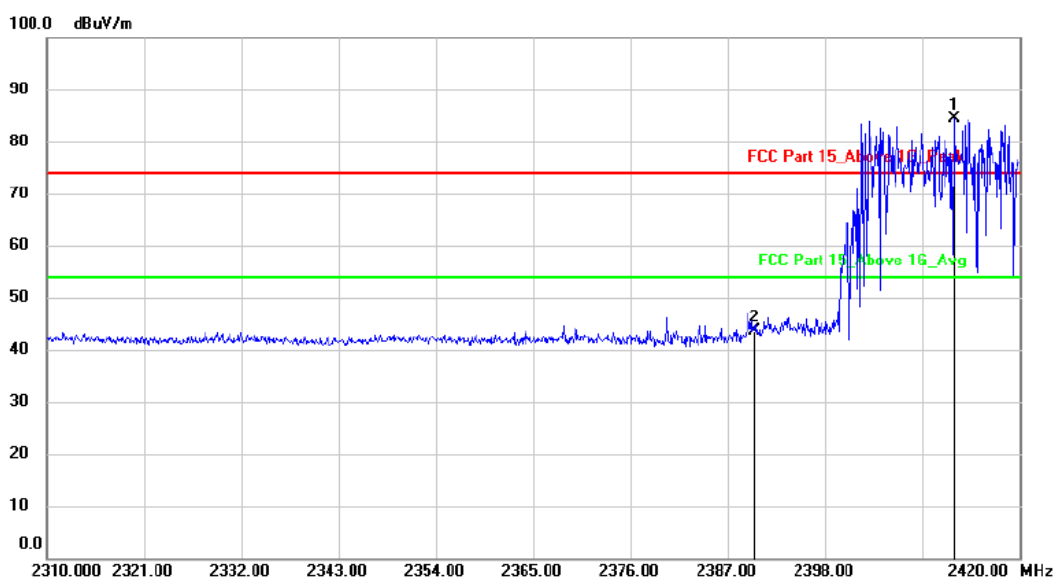

No.	Mk.	Freq.	Reading Level	Correct Factor	Measurement	Limit	Margin	Antenna Height	Table Degree	
		MHz	dBuV	dB	dBuV/m	dBuV/m	dB	cm	degree	Comment
1	*	2412.520	87.81	-3.41	84.40	74.00	10.40	peak		
2		2390.000	47.02	-3.40	43.62	74.00	-30.38	peak		

hopping-on

Polarization: Vertical

Test Mode:  $\pi/4$  DQPSK-High

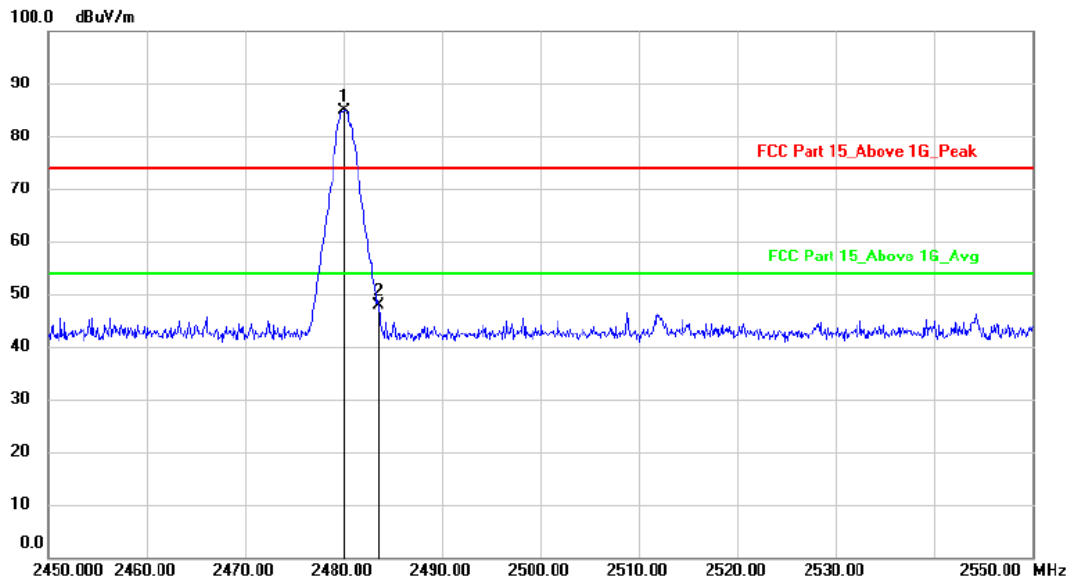

No.	Mk.	Freq.	Reading Level	Correct Factor	Measurement	Limit	Margin	Antenna Height	Table Degree	
		MHz	dBuV	dB	dBuV/m	dBuV/m	dB	cm	degree	Comment
1	*	2480.100	88.36	-3.38	84.98	74.00	10.98			peak
2		2483.500	51.22	-3.38	47.84	74.00	-26.16			peak

hopping-off

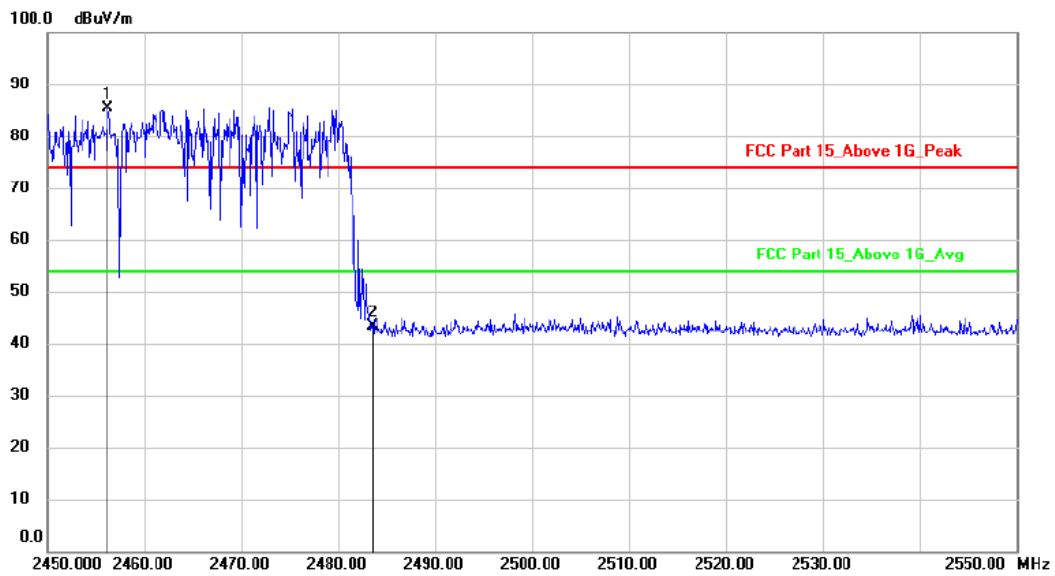

No.	Mk.	Freq.	Reading Level	Correct Factor	Measurement	Limit	Margin	Antenna Height	Table Degree	
		MHz	dBuV	dB	dBuV/m	dBuV/m	dB	cm	degree	Comment
1	*	2456.200	88.84	-3.39	85.45	74.00	11.45			peak
2		2483.500	46.72	-3.38	43.34	74.00	-30.66			peak

hopping-on

Polarization: Horizontal

Test Mode:  $\pi/4$  DQPSK-High

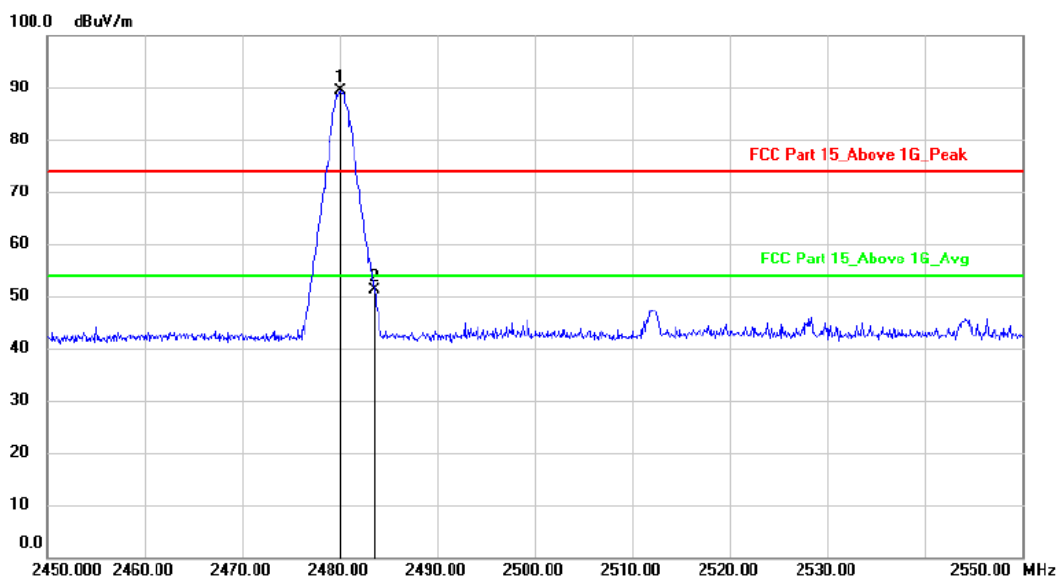

No.	Mk.	Freq.	Reading Level	Correct Factor	Measurement	Limit	Margin	Antenna Height	Table Degree	
		MHz	dBuV	dB	dBuV/m	dBuV/m	dB	cm	degree	Comment
1	*	2480.000	92.79	-3.38	89.41	74.00	15.41	peak		
2		2483.500	54.40	-3.38	51.02	74.00	-22.98	peak		

hopping-off

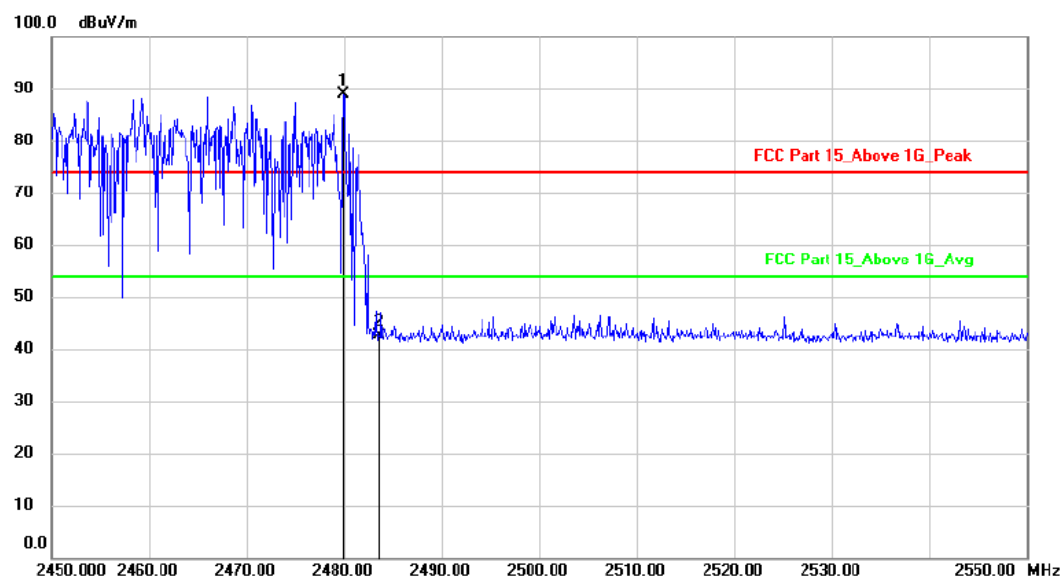

No.	Mk.	Freq.	Reading Level	Correct Factor	Measurement	Limit	Margin	Antenna Height	Table Degree	
		MHz	dBuV	dB	dBuV/m	dBuV/m	dB	cm	degree	Comment
1	*	2479.900	92.14	-3.38	88.76	74.00	14.76	peak		
2		2483.500	45.91	-3.38	42.53	74.00	-31.47	peak		

hopping-on



Polarization: Vertical

Test Mode: 8DPSK-Low

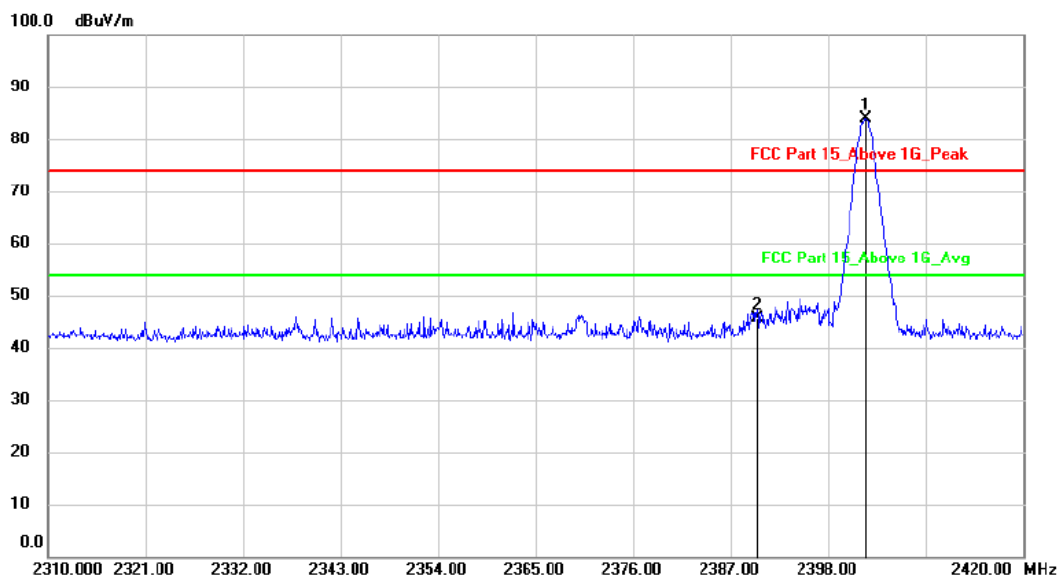

No.	Mk.	Freq.	Reading Level	Correct Factor	Measurement	Limit	Margin	Antenna Height	Table Degree	
		MHz	dBuV	dB	dBuV/m	dBuV/m	dB	cm	degree	Comment
1	*	2402.180	87.27	-3.41	83.86	74.00	9.86			peak
2		2390.000	49.00	-3.40	45.60	74.00	-28.40			peak

hopping-off

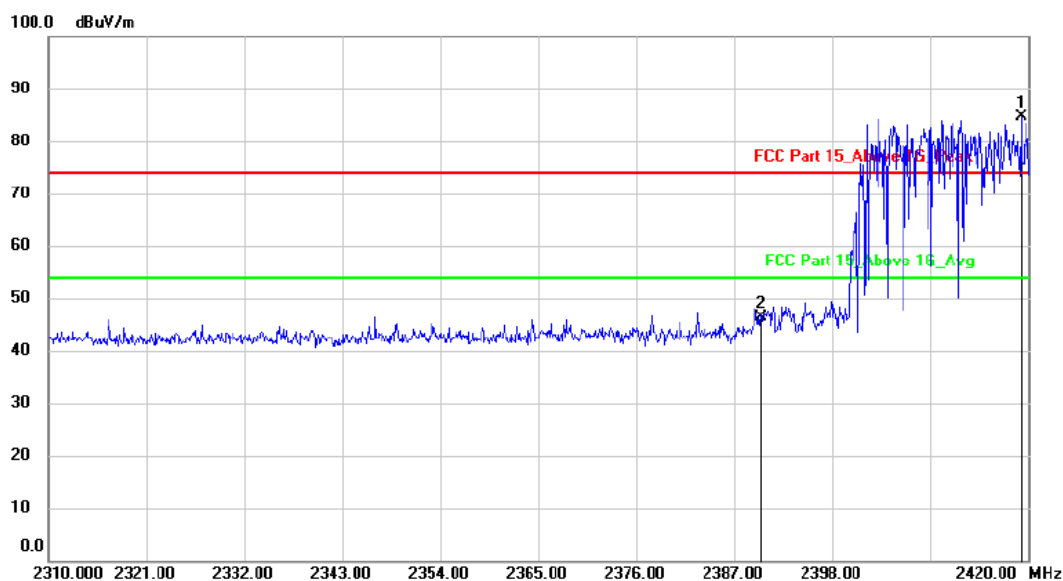

No.	Mk.	Freq.	Reading Level	Correct Factor	Measurement	Limit	Margin	Antenna Height	Table Degree	
		MHz	dBuV	dB	dBuV/m	dBuV/m	dB	cm	degree	Comment
1	*	2419.120	88.15	-3.41	84.74	74.00	10.74			peak
2		2390.000	49.87	-3.40	46.47	74.00	-27.53			peak

hopping-on

Polarization: Horizontal

Test Mode: 8DPSK-Low

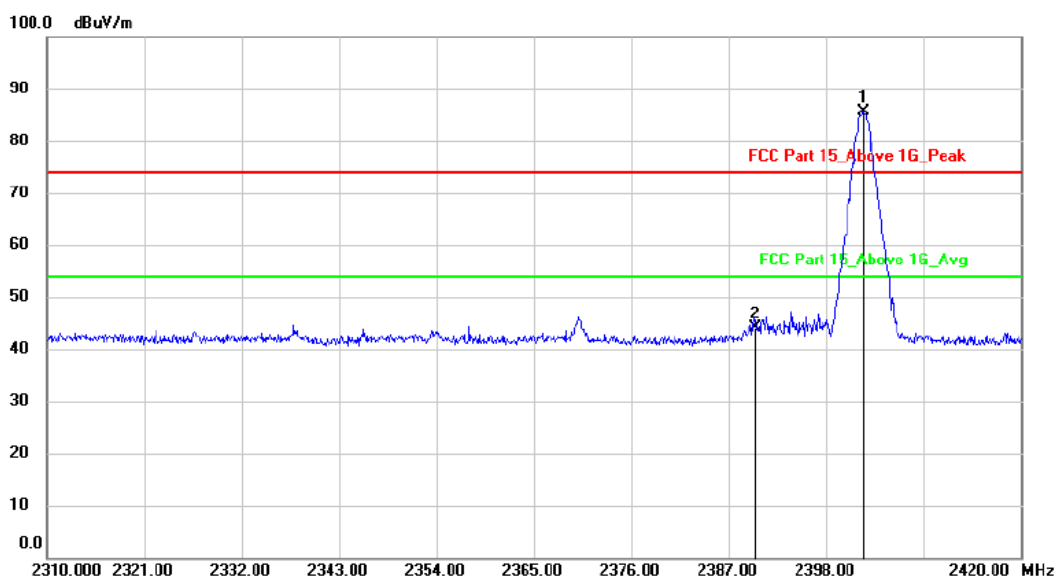

No.	Mk.	Freq.	Reading Level	Correct Factor	Measurement	Limit	Margin	Antenna Height	Table Degree	
		MHz	dBuV	dB	dBuV/m	dBuV/m	dB	cm	degree	Comment
1	*	2402.180	89.08	-3.41	85.67	74.00	11.67			peak
2		2390.000	47.42	-3.40	44.02	74.00	-29.98			peak

hopping-off

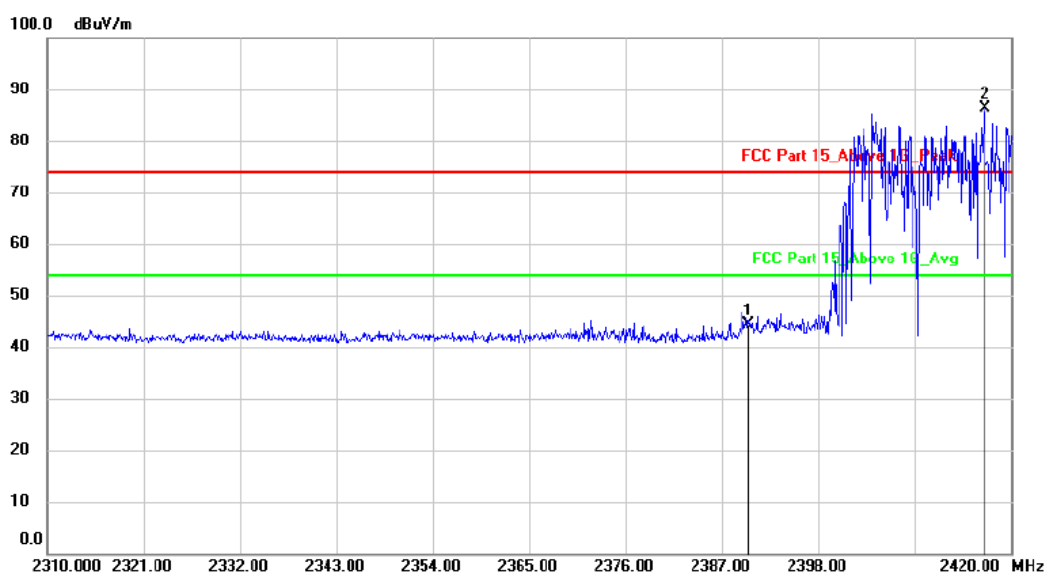

No.	Mk.	Freq.	Reading Level	Correct Factor	Measurement	Limit	Margin	Antenna Height	Table Degree	
		MHz	dBuV	dB	dBuV/m	dBuV/m	dB	cm	degree	Comment
1		2390.000	47.85	-3.40	44.45	74.00	-29.55			peak
2	*	2416.920	89.83	-3.41	86.42	74.00	12.42			peak

hopping-on

Polarization: Vertical

Test Mode: 8DPSK-High

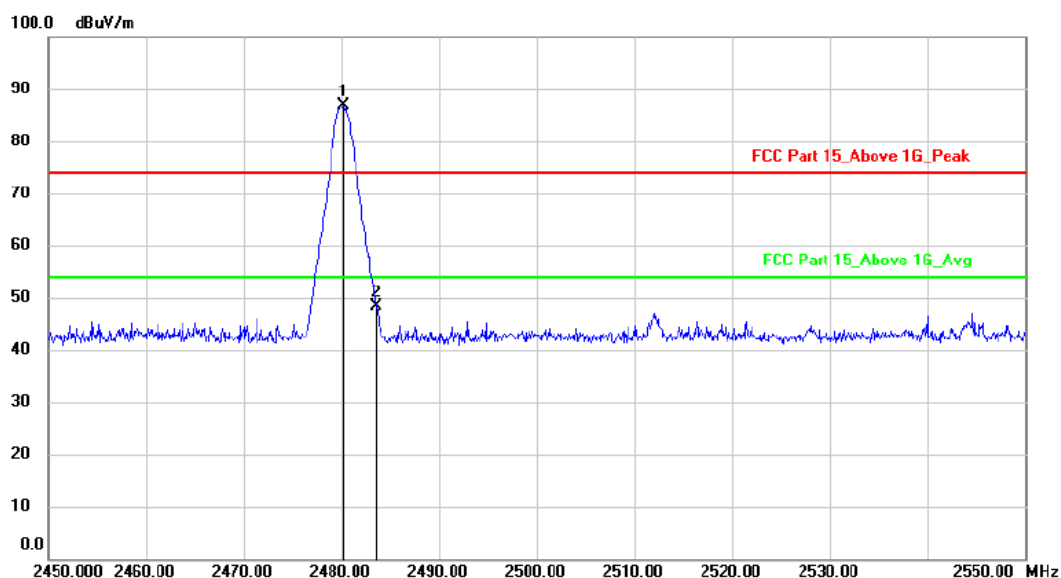

No.	Mk.	Freq.	Reading Level	Correct Factor	Measurement	Limit	Margin	Antenna Height	Table Degree
		MHz	dBuV	dB	dBuV/m	dBuV/m	dB	cm	degree
1	*	2480.200	90.19	-3.38	86.81	74.00	12.81	peak	
2		2483.500	51.75	-3.38	48.37	74.00	-25.63	peak	

hopping-off

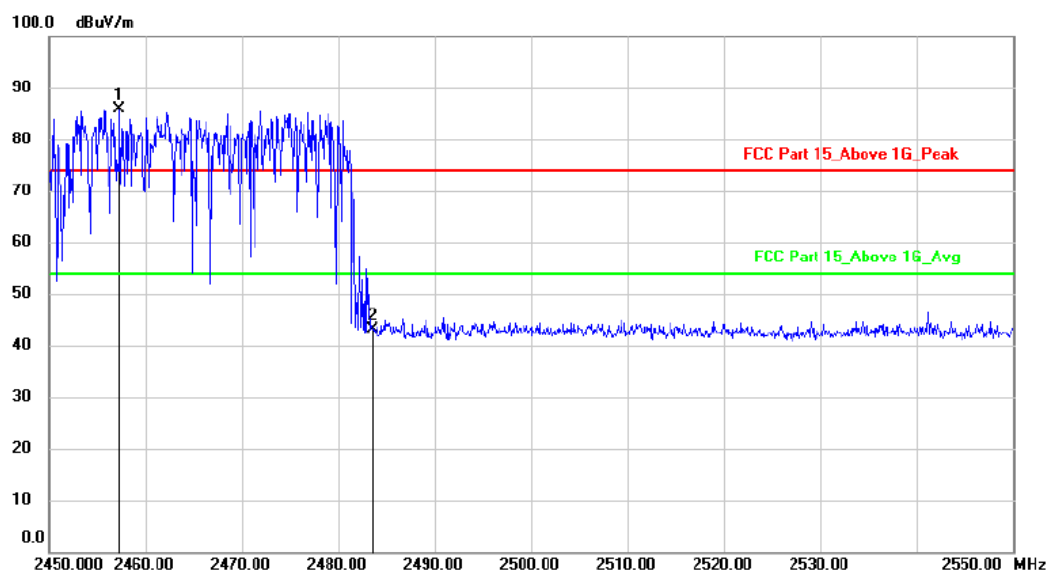

No.	Mk.	Freq.	Reading Level	Correct Factor	Measurement	Limit	Margin	Antenna Height	Table Degree
		MHz	dBuV	dB	dBuV/m	dBuV/m	dB	cm	degree
1	*	2457.300	89.21	-3.39	85.82	74.00	11.82	peak	
2		2483.500	46.60	-3.38	43.22	74.00	-30.78	peak	

hopping-on

Polarization: Horizontal

Test Mode: 8DPSK-High

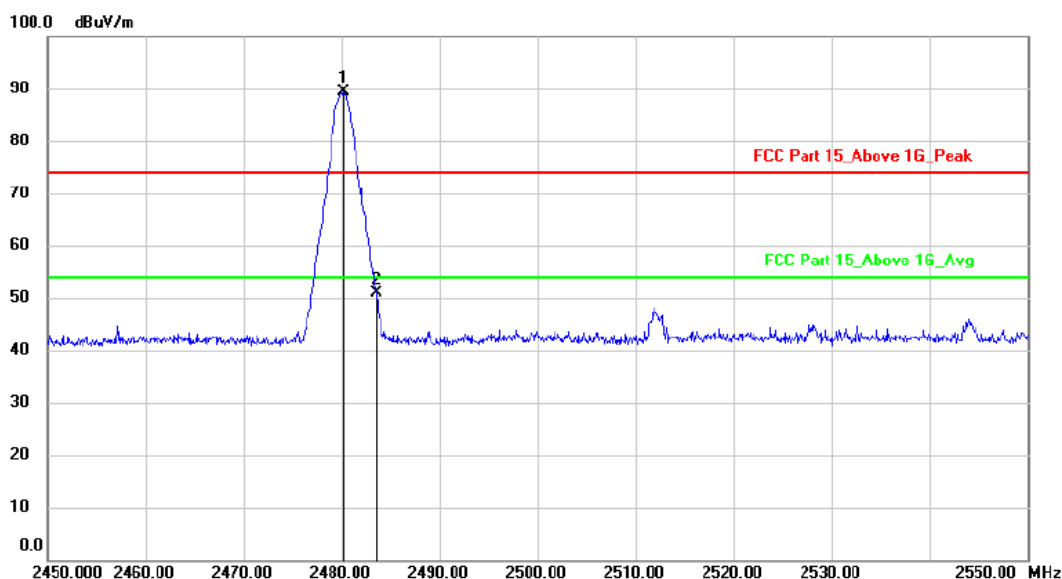

No.	Mk.	Freq.	Reading Level	Correct Factor	Measurement	Limit	Margin	Antenna Height	Table Degree	
		MHz	dBuV	dB	dBuV/m	dBuV/m	dB	cm	degree	Comment
1	*	2480.200	92.68	-3.38	89.30	74.00	15.30			peak
2		2483.500	54.22	-3.38	50.84	74.00	-23.16			peak

hopping-off

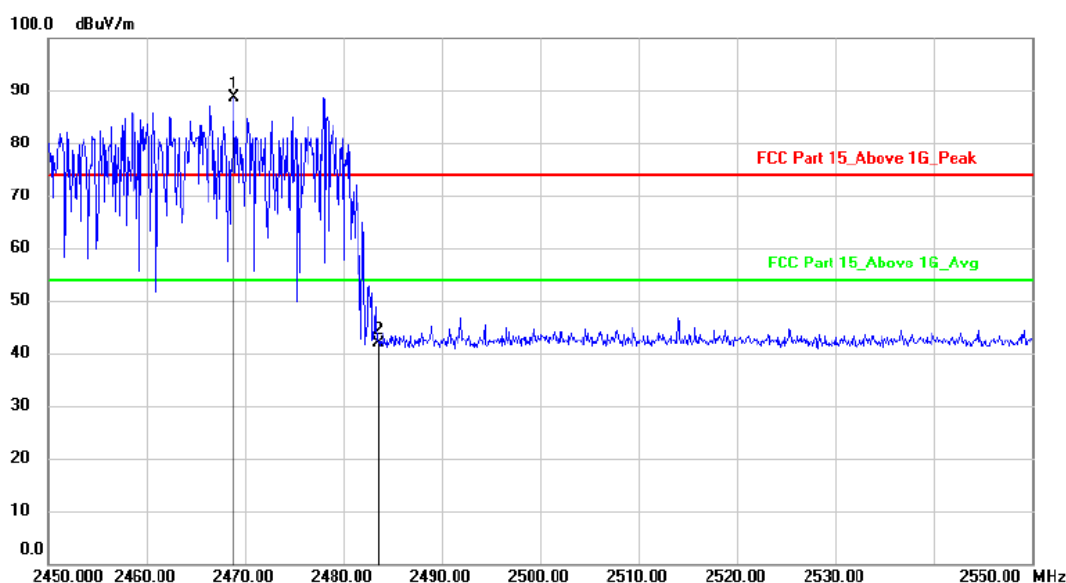

No.	Mk.	Freq.	Reading Level	Correct Factor	Measurement	Limit	Margin	Antenna Height	Table Degree	
		MHz	dBuV	dB	dBuV/m	dBuV/m	dB	cm	degree	Comment
1	*	2468.800	92.06	-3.39	88.67	74.00	14.67			peak
2		2483.500	45.16	-3.38	41.78	74.00	-32.22			peak

hopping-on

Note: 1. \*:Maximum data; x:Over limit; !:over margin.

2.Measurement=Reading Level+Correct Factor; Correct Factor=Antenna Factor+Cable Loss.

Conducted Method

GFSK

CH LOW :

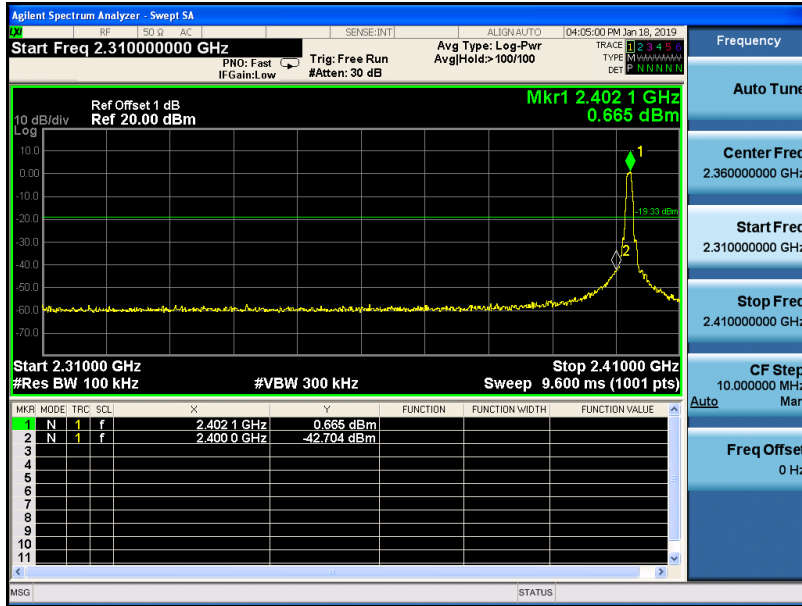

CH High :

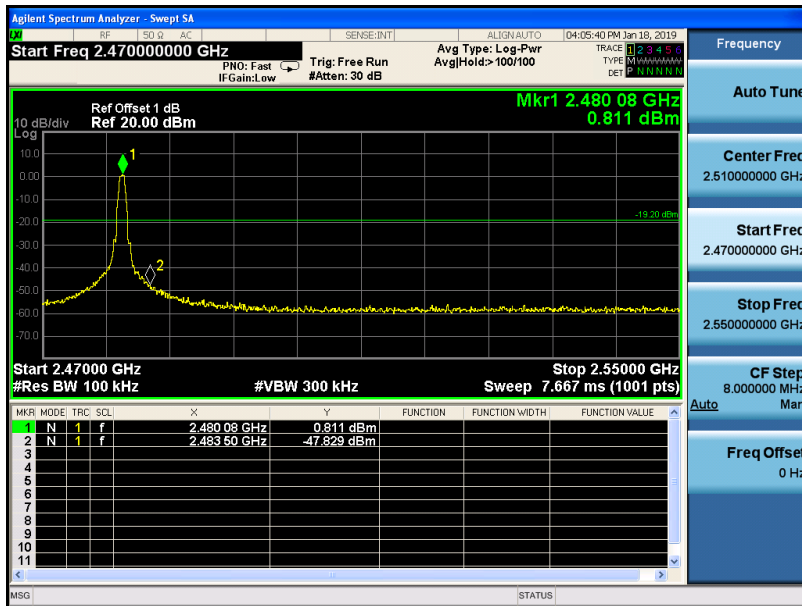



$\pi/4$  DQPSK  
Low

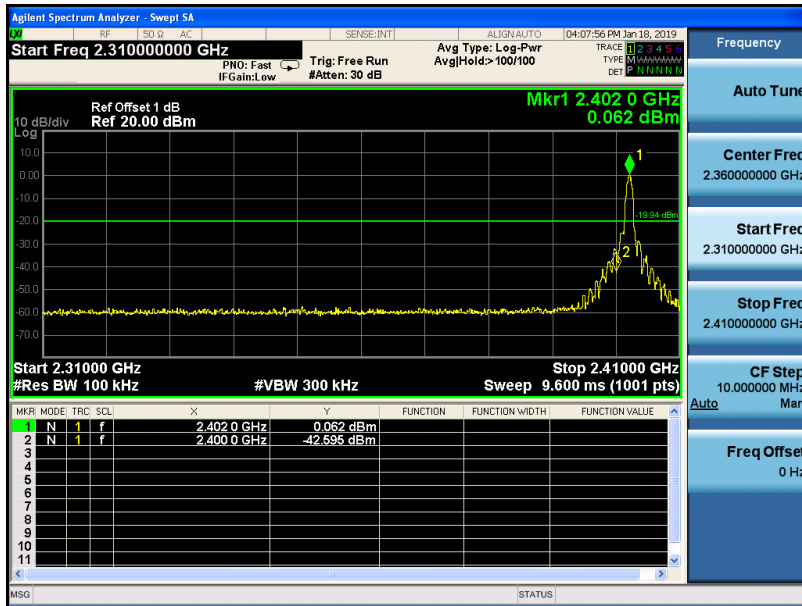

High



Hopping  
Low

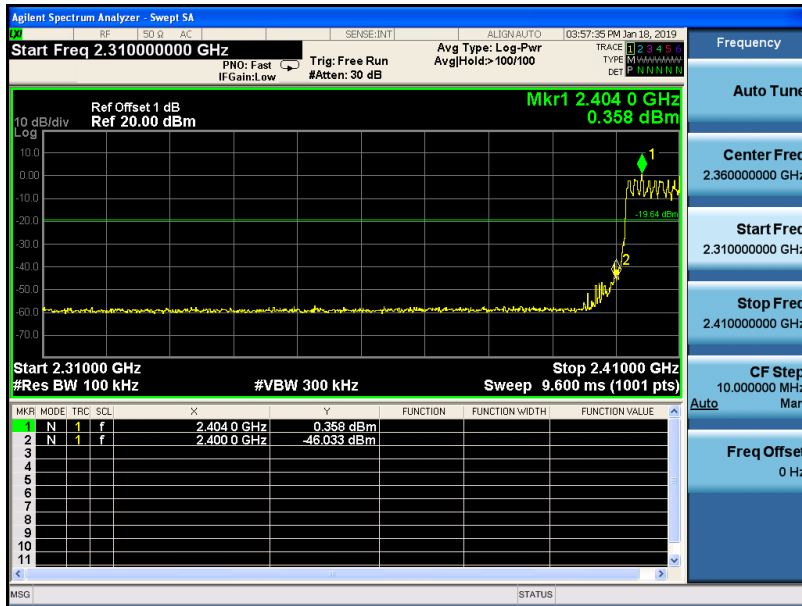

High

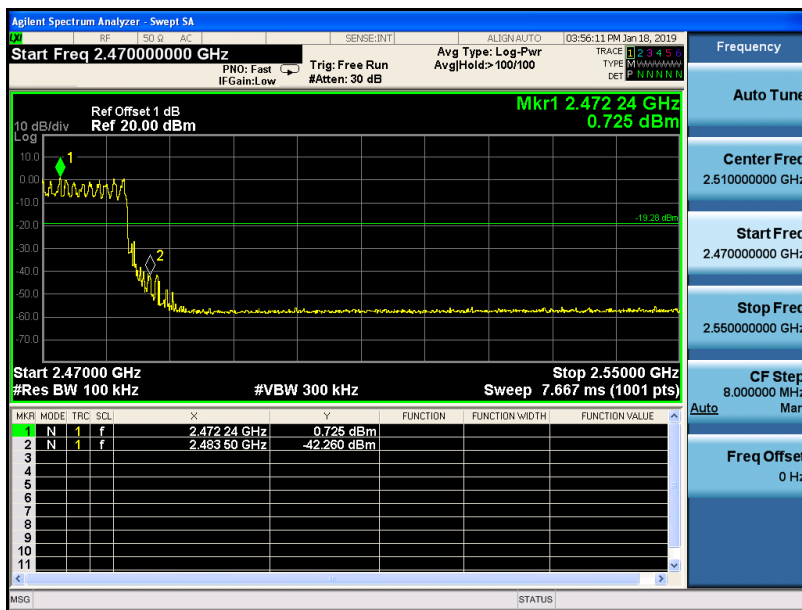





Hopping  
Low

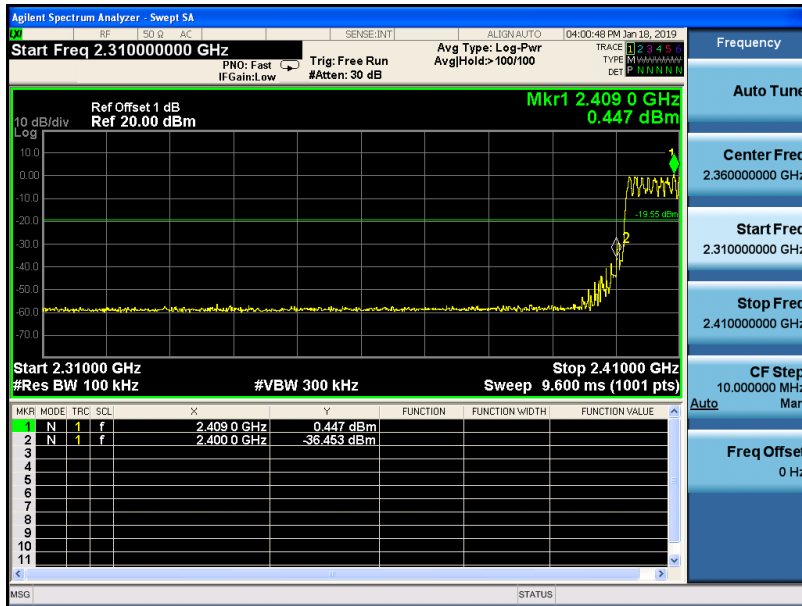

High

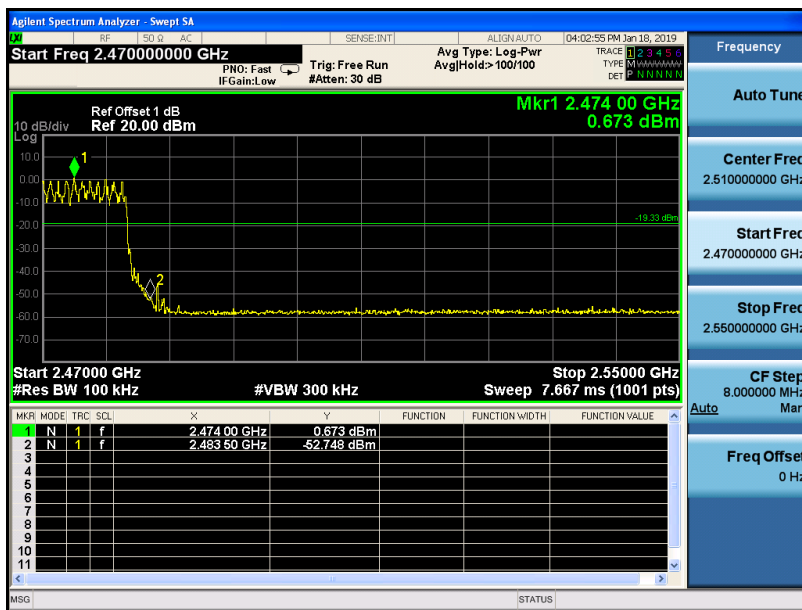

## 10. POWER LINE CONDUCTED EMISSIONS

### 10.1. Block Diagram of Test Setup

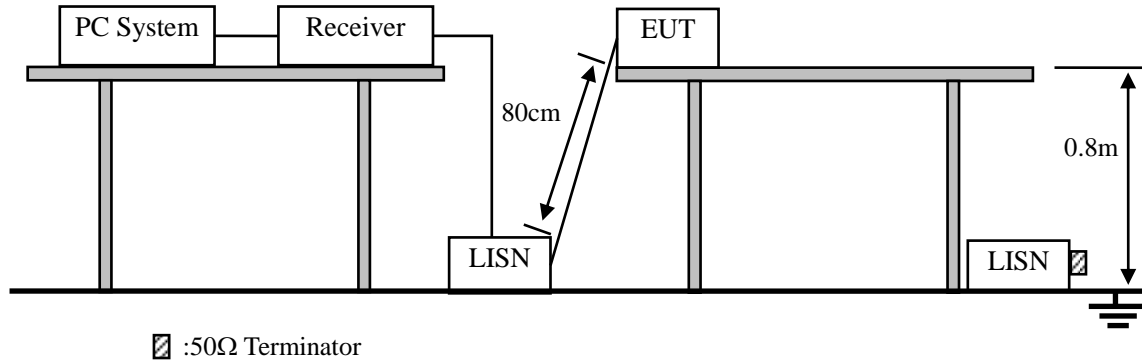

### 10.2. Limit

Frequency	Maximum RF Line Voltage	
	Quasi-Peak Level dB( $\mu$ V)	Average Level dB( $\mu$ V)
150kHz ~ 500kHz	66 ~ 56*	56 ~ 46*
500kHz ~ 5MHz	56	46
5MHz ~ 30MHz	60	50

Notes: 1. \* Decreasing linearly with logarithm of frequency.

2. The lower limit shall apply at the transition frequencies.

### 10.3. Test Procedure

- (1) The EUT was placed on a non-metallic table, 80cm above the ground plane.
- (2) Setup the EUT and simulator as shown in 10.1
- (3) The EUT Power connected to the power mains through a power adapter and a line impedance stabilization network (L.I.S.N1). The other peripheral devices power cord connected to the power mains through a line impedance stabilization network (L.I.S.N2), this provided a 50-ohm coupling impedance for the EUT (Please refer to the block diagram of the test setup and photographs). Both sides of power line were checked for maximum conducted interference. In order to find the maximum emission, the relative positions of equipments and all of the interface cables were changed according to ANSI C63.10 :2013on conducted Emission test.
- (4) The bandwidth of test receiver is set at 10KHz.
- (5) The frequency range from 150 KHz to 30MHz is checked.

### 10.4. Test Result

PASS. (See below detailed test data)

Temperature:	24 °C	Relative Humidity:	57%
Pressure:	1010hPa	Phase :	N
Test Voltage:	AC 120V/60Hz		
Test Mode:	BT Link		

## Conducted Emission Measurement

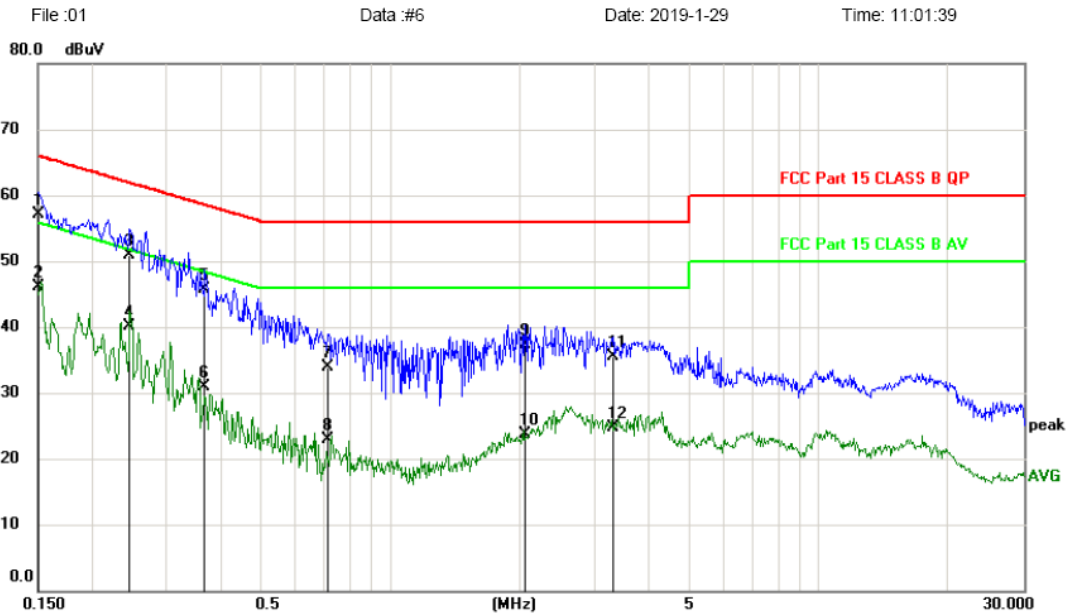

No.	Mk.	Freq. MHz	Reading Level dBuV	Correct Factor dB	Measure- ment dBuV	Limit dBuV	Margin dB	Detector	Comment
1	*	0.1500	47.42	9.63	57.05	66.00	-8.95	QP	
2		0.1500	36.47	9.63	46.10	56.00	-9.90	AVG	
3		0.2459	41.22	9.66	50.88	61.89	-11.01	QP	
4		0.2459	30.51	9.66	40.17	51.89	-11.72	AVG	
5		0.3689	36.12	9.67	45.79	58.53	-12.74	QP	
6		0.3689	21.19	9.67	30.86	48.53	-17.67	AVG	
7		0.7137	24.23	9.70	33.93	56.00	-22.07	QP	
8		0.7137	13.22	9.70	22.92	46.00	-23.08	AVG	
9		2.0548	27.54	9.82	37.36	56.00	-18.64	QP	
10		2.0548	13.84	9.82	23.66	46.00	-22.34	AVG	
11		3.3090	25.64	9.94	35.58	56.00	-20.42	QP	
12		3.3090	14.83	9.94	24.77	46.00	-21.23	AVG	

\*:Maximum data    x:Over limit    !:over margin

Note: Measurement=Reading Level+Correc Factor.    Factor=(LISN or ISN or PLC or Current Probe)Factor+Cable

Temperature:	24 °C	Relative Humidity:	57%
Pressure:	1010hPa	Phase :	L
Test Voltage:	AC 120V/60Hz		
Test Mode:	BT Link		

**Conducted Emission Measurement**

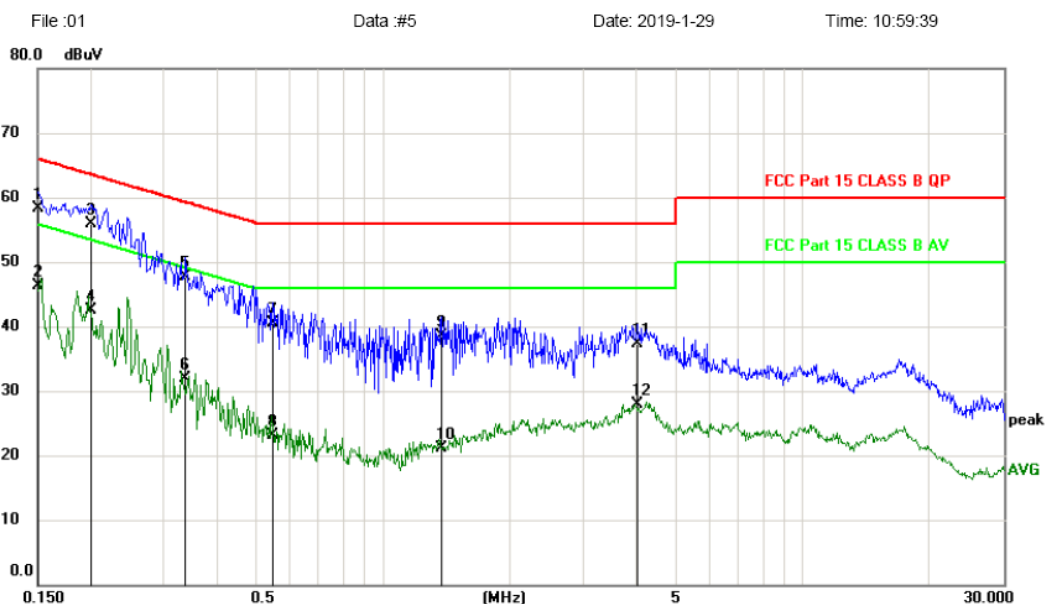

No.	Mk.	Freq.	Reading Level	Correct Factor	Measurement	Limit	Margin	Detector	Comment
		MHz	dBuV	dB	dBuV	dBuV	dB		
1		0.1500	48.72	9.63	58.35	66.00	-7.65	QP	
2		0.1500	36.58	9.63	46.21	56.00	-9.79	AVG	
3	*	0.2010	46.32	9.64	55.96	63.57	-7.61	QP	
4		0.2010	32.94	9.64	42.58	53.57	-10.99	AVG	
5		0.3390	38.04	9.67	47.71	59.23	-11.52	QP	
6		0.3390	22.24	9.67	31.91	49.23	-17.32	AVG	
7		0.5460	30.91	9.69	40.60	56.00	-15.40	QP	
8		0.5460	13.42	9.69	23.11	46.00	-22.89	AVG	
9		1.3731	28.75	9.76	38.51	56.00	-17.49	QP	
10		1.3731	11.33	9.76	21.09	46.00	-24.91	AVG	
11		4.0170	27.25	10.00	37.25	56.00	-18.75	QP	
12		4.0170	17.91	10.00	27.91	46.00	-18.09	AVG	

\*:Maximum data x:Over limit !:over margin

Note: Measurement=Reading Level+Correc Factor. Factor=(LISN or ISN or PLC or Current Probe)Factor+Cable

Remark: All modes and channels have been tested and only listed BT link mode that is worst data

## **11. ANTENNA REQUIREMENTS**

### **11.1. Limit**

For intentional device, according to FCC 47 CFR Section 15.203, an intentional radiator shall be designed to ensure that no antenna other than that furnished by the responsible party shall be used with the device. And according to FCC 47 CFR Section 15.247 (b), if transmitting antennas of directional gain greater than 6dBi are used, the power shall be reduced by the amount in dB that the directional gain of the antenna exceeds 6dBi.

### **11.2. Result**

The EUT antenna is PCB Antenna. It complies with the standard requirement.