



FCC DFS TEST REPORT

Applicant : Alarm.com Incorporated

Address : 8281 Greensboro Drive, Suite 100, Tysons,
VA 22102

Equipment : Wi-Fi Outdoor Two Way Audio Camera

Model No. : ADC-V724

Trade Name : ALARM.COM

FCC ID : YL6-V724

I HEREBY CERTIFY THAT :

The sample was received on Jan. 08, 2021 and the testing was completed on Mar. 10, 2021 at CerpPASS Technology Corp. The test result refers exclusively to the test presented test model / sample. Without written approval of CerpPASS Technology Corp., the test report shall not be reproduced except in full.

Approved by:

Mark Liao / Supervisor

Laboratory Accreditation:

CerpPASS Technology Corporation Test Laboratory





CONTENTS

- 1. Summary of Test Procedure and Test Results 4
 - 1.1. Applicable Standards 4
- 2. Test Configuration of Equipment under Test 5
 - 2.1. Feature of Equipment under Test..... 5
 - 2.2. Description of Test System..... 5
 - 2.3. General Information of Test..... 6
 - 2.4. Measurement Uncertainty 6
- 3. Test Equipment and Ancillaries Used for Tests 7
- 4. Antenna Requirements 8
 - 4.1. Standard Applicable 8
 - 4.2. Antenna Construction and Directional Gain..... 8
- 5. Dynamic Frequency Selection 9
 - 5.1. List of Measurement and Examinations 9
 - 5.2. Test Setup 11
 - 5.3. DFS Detection Threshold..... 13
 - 5.4. Channel Availability Check Time 16
 - 5.5. Radar Burst at the Beginning of the Channel Availability Check Time 17
 - 5.6. Radar Burst at the End of the Channel Availability Check Time 18
 - 5.7. U-NII Detection Bandwidth..... 19
 - 5.8. Statistical Performance Check 20
 - 5.9. In-Service Monitoring 21
 - 5.10. Non-Occupancy Period 23
 - 5.11. EUT Setup Photos 25



History of this test report

Report No.	Issue Date	Description
21010043-TRFCC04	Apr. 09, 2021	Original



1. Summary of Test Procedure and Test Results

1.1. Applicable Standards

ANSI C63.10:2013

FCC Rules and Regulations Part 15 Subpart E §15.407

KDB 789033

KDB 905462

FCC Rule	Description of Test	Result
15.407	Dynamic Frequency Selection	PASS

*The lab has reduced the uncertainty risk factor from test equipment, environment and staff technicians which according to the standard on contract. Therefore, the test result will only be determined by standard requirement.



2. Test Configuration of Equipment under Test

2.1. Feature of Equipment under Test

Frequency Range	BLE: 2402-2480MHz 802.11b/g/n: 2412-2462MHz 802.11a/n/ac: 5180-5240MHz, 5260-5320MHz, 5500-5700MHz, 5745-5825MHz
Modulation Type	BLE: GFSK WLAN: 2.4GHz: 802.11b: CCK, DQPSK, DBPSK 802.11g/n: BPSK, QPSK, 16QAM, 64QAM 5GHz: 802.11n/a: BPSK, QPSK, 16QAM, 64QAM 802.11ac: BPSK, QPSK, 16QAM, 64QAM, 256QAM
Modulation Technology	DSSS, OFDM, DTS
Data Rate	BLE: GFSK: 1Mbps WLAN: 2.4GHz: 802.11b: 1, 2, 5.5, 11Mbps 802.11g: 6, 9, 12, 18, 24, 36, 48, 54Mbps 802.11n: MCS0 – MCS15, HT20/40 5GHz: 802.11a: 6, 9, 12, 18, 24, 36, 48, 54Mbps 802.11n: MCS0 – MCS15, HT20/40 802.11ac: MCS0 – MCS9, VHT20/40/80
Antenna Type	FPCB Antenna
Antenna Gain	For BLE: 2402-2480MHz: ANT B:3.94dBi For WLAN: 2412-2462MHz: ANT A:3.78dBi,ANT B:3.94dBi 5180-5240 MHz: ANT A:2.72dBi, ANT B:3.63dBi 5260-5320MHz: ANT A:3.55dBi, ANT B:4.23dBi 5500-5700MHz: ANT A:4.28dBi, ANT B:5.12dBi 5745-5825MHz: ANT A:4.24dBi, ANT B:5.30dBi
Adapter	Brand:APD Model: WB-12G12FU

Note:

- 1.EUT support TPC Function.
- 2.EUT support Client Mode without radar detection.
- 3.For more details, please refer to the User's manual of the EUT.

2.2. Description of Test System

DFS					
Equipment	Brand	Model	Length/Type	Power cord/Length/Type	FCC ID
Notebook	ASUS	P2430U	N/A	Adapter / 1.8m / NS	
AP	NETGEAR	RAX80	NA	Adapter / 1.5m / NS	PY318200414
RJ45 Cable	N/A	N/A	15m / NS	N/A	

**2.3. General Information of Test**

Test Site	Cerpass Technology Corporation Test Laboratory Address: No.10, Ln. 2, Lianfu St., Luzhu Dist., Taoyuan City 33848, Taiwan (R.O.C.) Tel:+886-3-3226-888 Fax:+886-3-3226-881	
	FCC	TW1439, TW1079
	IC	4934E-1, 4934E-2
	VCCI	T-2205 for Telecommunication test C-4663 for Conducted emission test R-4218 for Radiated emission test G-10812, G-10813 for radiated disturbance above 1GHz
Frequency Range Investigated:	Conducted: from 150kHz to 30 MHz Radiation: from 30 MHz to 40,000MHz	
Test Distance:	The test distance of radiated emission from antenna to EUT is 3 M.	

Test Item	Test Site	Test period	Environmental Conditions	Tested By
DFS	RFDFS01-NK	2021/03/10	23°C / 50%	Dian Chen

2.4. Measurement Uncertainty

Measurement Item	Uncertainty
Channel Move Time	±2.64%
Channel Closing Transmission Time	±5.36%
Threshold	±1.121dB



3. Test Equipment and Ancillaries Used for Tests

Test Item	DFS				
Test Site	RFDFS01-NK				
Instrument	Manufacturer	Model No	Serial No	Calibration Date	Valid Date
Horn Antenna	EMCO	3115	31589	2020/03/26	2021/03/25
Horn Antenna	EMCO	3115	31601	2020/10/16	2021/10/15
EXA Signal Analyzer	KEYSIGHT	N9010A	MY54200207	2020/04/14	2021/04/13
CAX Signal Analyzer	KEYSIGHT	N9000B	MY57100291	2020/11/10	2021/11/09
MXG Vector Signal Generator	KEYSIGHT	N5182A	MY50141551	2020/10/15	2021/10/14
N7607B Signal Studio	KEYSIGHT	v3.2.0.0	NA	NA	NA
InServiceMonitorUtility	Theda	v10.0.0.0	NA	NA	NA



4. Antenna Requirements

4.1. Standard Applicable

For intentional device, according to FCC 47 CFR Section 15.203, an intentional radiator shall be designed to ensure that no antenna other than that furnished by the responsible party shall be used with the device.

And according to FCC 47 CFR Section 15.407 (a), if transmitting antennas of directional gain greater than 6dBi are used, the power shall be reduced by the amount in dB that the directional gain of the antenna exceeds 6dBi.

4.2. Antenna Construction and Directional Gain

Antenna Type	FPCB Antenna
Antenna Gain	5180-5240 MHz: ANT A:2.72dBi, ANT B:3.63dBi 5260-5320MHz: ANT A:3.55dBi, ANT B:4.23dBi 5500-5700MHz: ANT A:4.28dBi, ANT B:5.12dBi 5745-5825MHz: ANT A:4.24dBi, ANT B:5.30dBi



5. Dynamic Frequency Selection

5.1. List of Measurement and Examinations

EUT Applicability of DFS requirements and Frequency Range

Operation Mode		Operating Frequency Range	
		5250-5350MHz	5470-5725MHz (Support 5600MHz-5650MHz)
Master	--	--	--
Client without radar detection	√	√	√
Client with radar detection	--	--	--

DEVICES WITH RADAR DETECTION

MAXIMUM TRANSMIT POWER	VALUE (SEE Note 1 and 2)
≥ 200 milliwatt	-64 dBm
EIRP < 200 milliwatt and power spectral density < 10 dBm/MHz	-62 dBm
EIRP < 200 milliwatt that do not meet the power spectral density requirement	-64 dBm

Note 1: This is the level at the input of the receiver assuming a 0 dBi receive antenna.
Note 2: Throughout these test procedures an additional 1 dB has been added to the amplitude of the test transmission waveforms to account for variations in measurement equipment. This will ensure that the test signal is at or above the detection threshold level to trigger a DFS response.
Note3: EIRP is based on the highest antenna gain. For MIMO devices refer to KDB Publication 662911

Table1: Applicability of DFS requirements prior to use of a channel

REQUIREMENT RADAR	OPERATIONAL MODE		
	MASTER	CLIENT WITHOUT RADAR DETECTION	CLIENT WITH RADAR DETECTION
Non-Occupancy Period	V	Not required	V
DFS Detection Threshold	V	Not required	V
Channel Availability Check Time	V	Not required	Not required
U-NII Detection Bandwidth	V	Not required	V



Table2: Applicability of DFS requirements during normal operation

REQUIREMENT RADAR	OPERATIONAL MODE		
	MASTER	CLIENT WITHOUT RADAR DETECTION	CLIENT WITH RADAR DETECTION
DFS Detection Threshold	√	Not required	√
Channel Closing Transmission Time	√	√	√
Channel Move Time	√	√	√
U-NII Detection Bandwidth	√	Not required	√

Additional requirements for devices with multiple bandwidth modes	Master or Client with radar detection	Client without radar detection
U-NII Detection Bandwidth and Statistical Performance Check	All BW modes must be tested	Not required
Channel Move Time and Channel Closing Transmission Time	Test using widest BW mode available	Test using the widest BW mode available for the link
All other	Any single BW mode	Not required

Note: Frequencies selected for statistical performance check (Section 7.8.4) should include several frequencies within the radar detection bandwidth and frequencies near the edge of the radar detection bandwidth. For 802.11 devices it is suggested to select frequencies in each of the bonded 20 MHz channels and the channel center frequency.



5.2. Test Setup

Setup for Master with injection at the Master

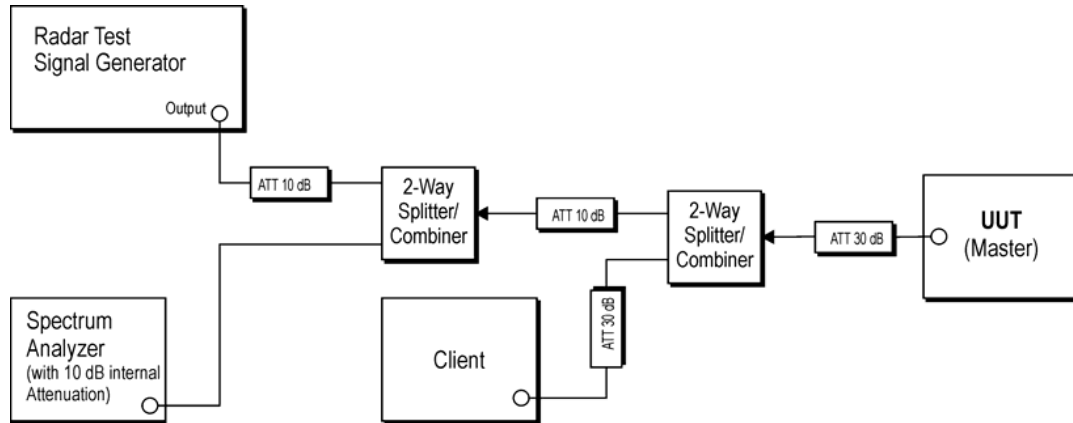

Figure 1: Example Conducted Setup where UUT is a Master and Radar Test Waveforms are injected into the Master

Setup for Client with injection at the Master

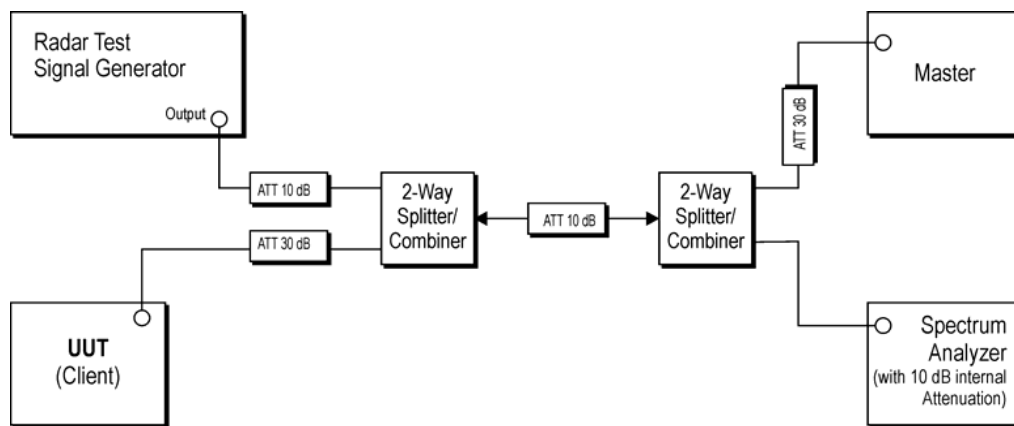

Figure 2: Example Conducted Setup where UUT is a Client and Radar Test Waveforms are injected into the Master



Setup for Client with injection at the Client

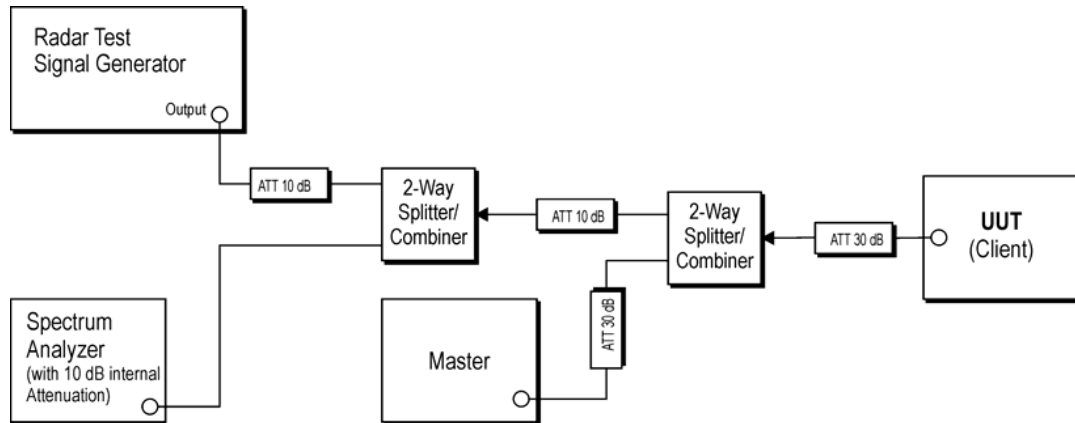

Figure 3: Example Conducted Setup where UUT is a Client and Radar Test Waveforms are injected into the Client



5.3. DFS Detection Threshold

DFS Detection Threshold is the level used by the DFS mechanism to detect radar interference.

5.3.1. Test Limit

Limits Clause 4.7.2.1.2

DFS Detection Thresholds for Master Devices and Client Devices with Radar

Detection

MAXIMUM TRANSMIT POWER	VALUE (SEE Note 1 and 2)
≥ 200 milliwatt	-64 dBm
EIRP < 200 milliwatt and power spectral density < 10 dBm/MHz	-62 dBm
EIRP < 200 milliwatt that do not meet the power spectral density requirement	-64 dBm

Note 1: This is the level at the input of the receiver assuming a 0 dBi receive antenna.
 Note 2: Throughout these test procedures an additional 1 dB has been added to the amplitude of the test transmission waveforms to account for variations in measurement equipment. This will ensure that the test signal is at or above the detection threshold level to trigger a DFS response.
 Note3: EIRP is based on the highest antenna gain. For MIMO devices refer to KDB Publication 662911

Max. output power	Band: 5260MHz ~ 5320MHz 802.11a: 21.20dBm 802.11n HT20: 21.02dBm 802.11n HT40: 23.86dBm 802.11ac VHT20: 21.07dBm 802.11ac VHT40: 23.89dBm 802.11ac VHT80: 17.69dBm
	Band: 5500MHz ~ 5700MHz 802.11a: 20.23dBm 802.11n HT20: 20.44dBm 802.11n HT40: 23.49dBm 802.11ac VHT20: 20.46dBm 802.11ac VHT40: 23.51dBm 802.11ac VHT80: 22.50dBm
Antenna gain (Max)	5260-5320MHz: ANT A: 3.55dBi, ANT B: 4.23dBi 5500-5700MHz: ANT A: 4.28dBi, ANT B: 5.12dBi



5.3.2. Test Result of DFS Detection Threshold

Radar Type 0 Calibration Plot

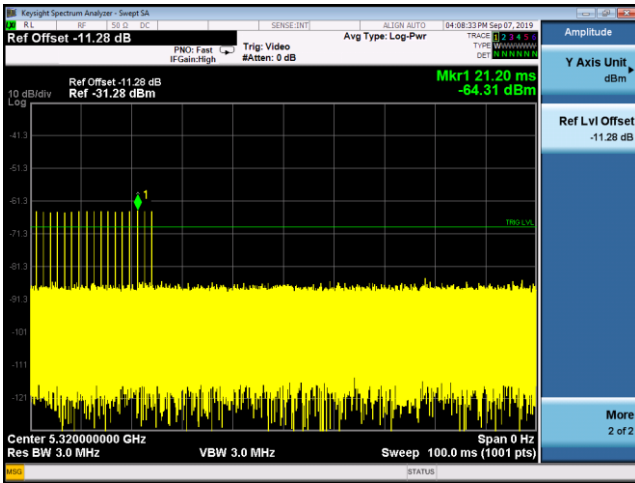

Radar Type 3 Calibration Plot

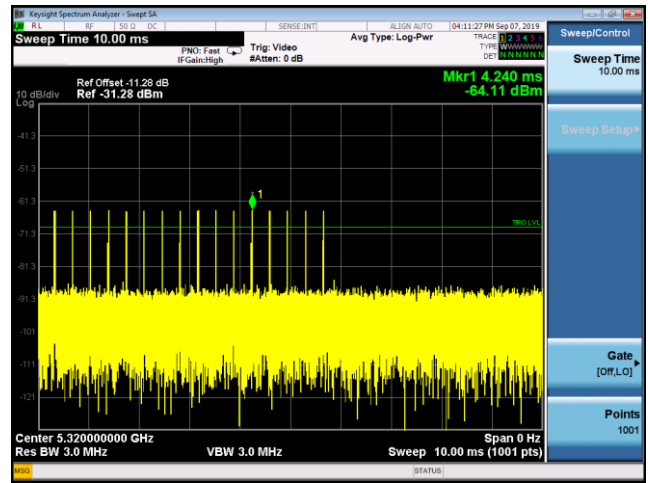

Radar Type 1 Calibration Plot

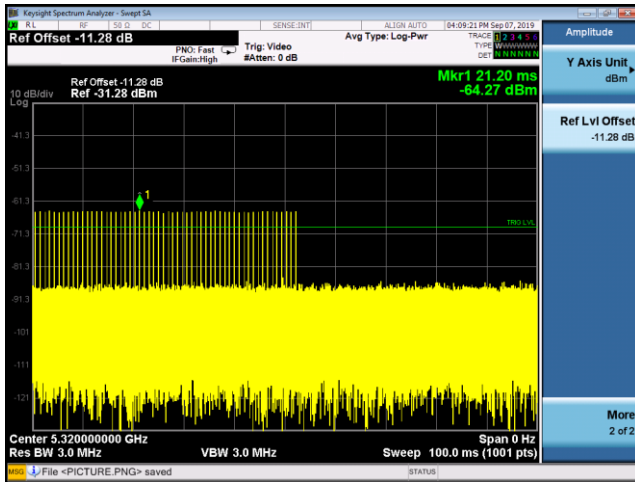

Radar Type 4 Calibration Plot

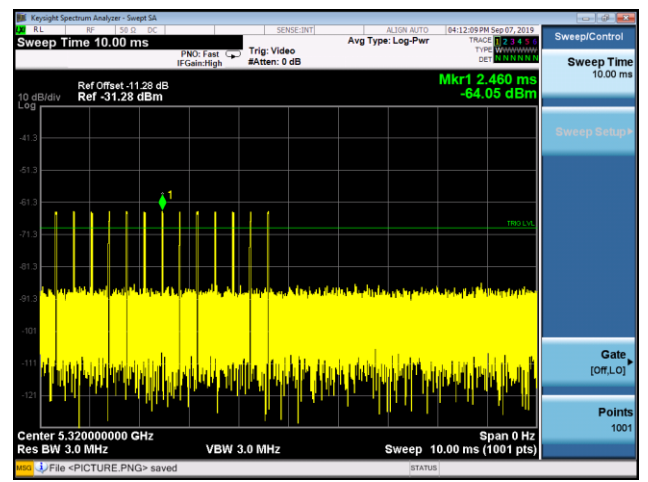

Radar Type 2 Calibration Plot

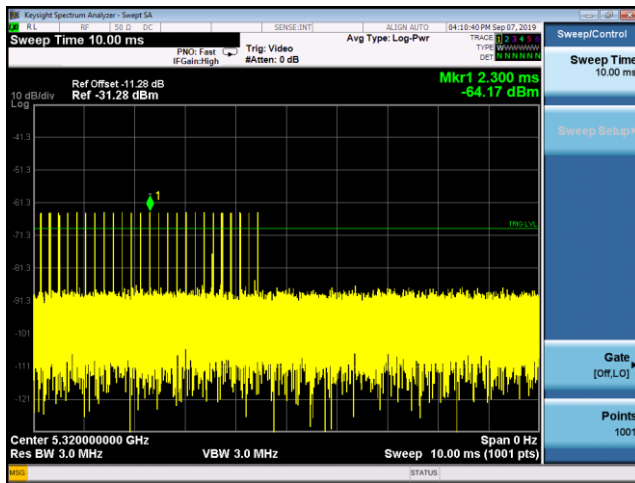

Radar Type 5 Calibration Plot

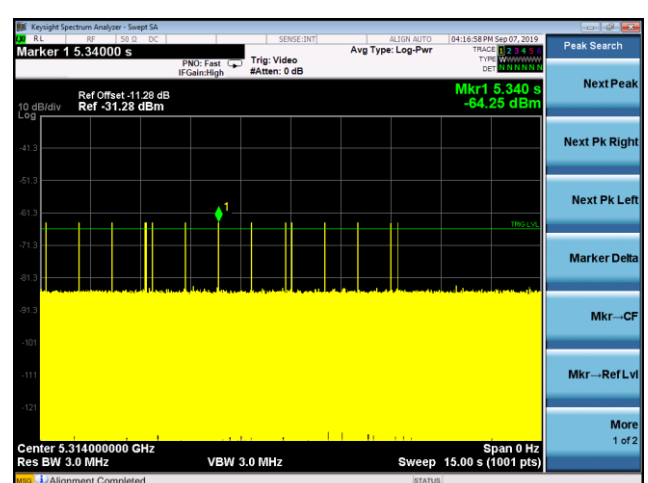



Radar Type 6 Calibration Plot

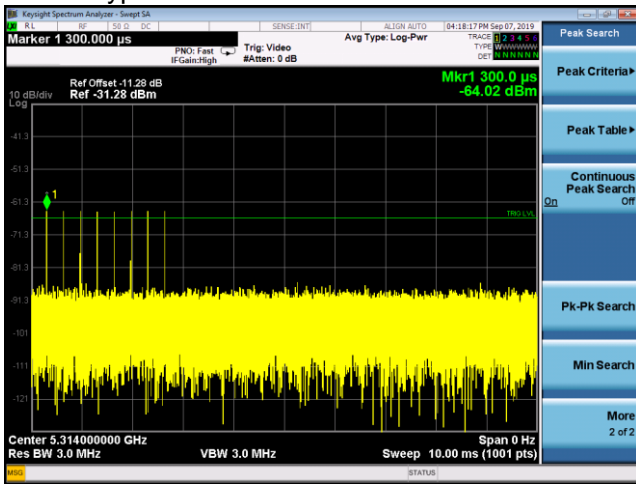



5.4. Channel Availability Check Time

The Channel Availability Check is defined as the mechanism by which an RLAN device checks a channel for the presence of radar signals.

There shall be no transmissions by the device within the channel being checked during this process. If no radars have been detected, the channel becomes an Available Channel valid for a period of time.

The RLAN shall only start transmissions on Available Channels.

At power-up, the RLAN is assumed to have no Available Channels.

5.4.1. Test Limit

Limits Clause 4.7.2.1.2

Table D.2: DFS requirement values

Parameter	Value
Channel Availability Check	> 60s

5.4.2. Test Result of Channel Availability Check

Not required



5.5. Radar Burst at the Beginning of the Channel Availability Check Time

The steps below define the procedure to verify successful radar detection on the test Channel during a period equal to the Channel Availability Check Time and avoidance of operation on that Channel when a radar Burst with a level equal to the DFS Detection Threshold + 1 dB occurs at the beginning of the Channel Availability Check Time. This is illustrated in **Figure 15**.

- a) The Radar Waveform generator and UUT are connected using the applicable test setup described in the sections on configuration for Conducted Tests or Radiated Tests and the power of the UUT is switched off.
- b) The UUT is powered on at T_0 . T_1 denotes the instant when the UUT has completed its power-up sequence (T_{power_up}). The Channel Availability Check Time commences on Chr at instant T_1 and will end no sooner than $T_1 + T_{ch_avail_check}$.
- c) A single Burst of one of the Short Pulse Radar Types 0-4 will commence within a 6 second window starting at T_1 . An additional 1 dB is added to the radar test signal to ensure it is at or above the DFS Detection Threshold, accounting for equipment variations/errors.
- d) Visual indication or measured results on the UUT of successful detection of the radar Burst will be recorded and reported. Observation of Chr for UUT emissions will continue for 2.5 minutes after the radar Burst has been generated.
- e) Verify that during the 2.5 minute measurement window no UUT transmissions occurred on Chr. The Channel Availability Check results will be recorded.

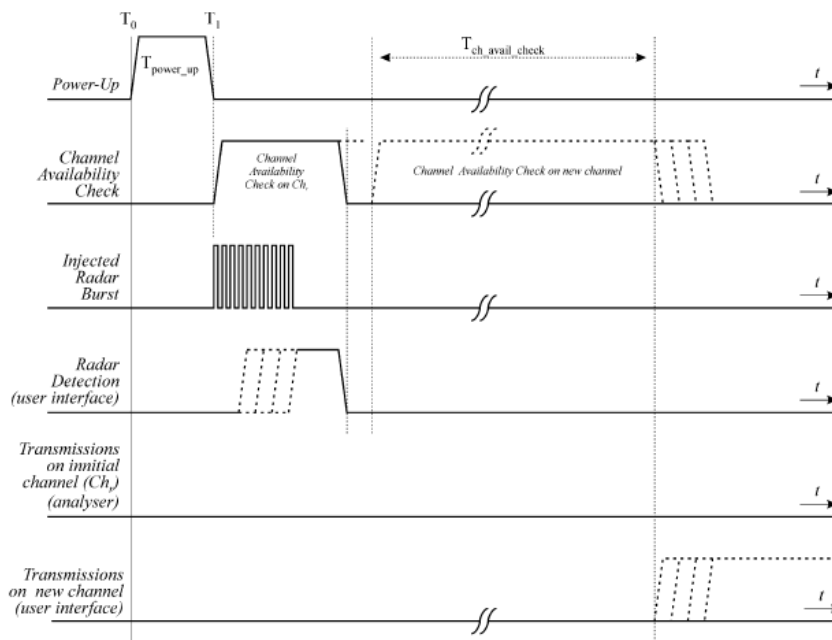

Figure 15: Example of timing for radar testing at the beginning of the Channel Availability Check Time

5.5.1. Test Result of radar burst at the beginning of the Channel Availability Check Time

Not required



5.6. Radar Burst at the End of the Channel Availability Check Time

The steps below define the procedure to verify successful radar detection on the test Channel during a period equal to the Channel Availability Check Time and avoidance of operation on that Channel when a radar Burst with a level equal to the DFS Detection Threshold + 1dB occurs at the end of the Channel Availability Check Time. This is illustrated in **Figure 16**.

- a) The Radar Waveform generator and UUT are connected using the applicable test setup described in the sections for Conducted Tests or Radiated Tests and the power of the UUT is switched off.
- b) The UUT is powered on at T0. T1 denotes the instant when the UUT has completed its power-up sequence (T_{power_up}). The Channel Availability Check Time commences on Chr at instant T1 and will end no sooner than T1 + T_{ch_avail_check}.
- c) A single Burst of one of the Short Pulse Radar Types 0-4 will commence within a 6 second window starting at T1 + 54 seconds. An additional 1 dB is added to the radar test signal to ensure it is at or above the DFS Detection Threshold, accounting for equipment variations/errors.
- d) Visual indication or measured results on the UUT of successful detection of the radar Burst will be recorded and reported. Observation of Chr for UUT emissions will continue for 2.5 minutes after the radar Burst has been generated.
- e) Verify that during the 2.5 minute measurement window no UUT transmissions occurred on Chr. The Channel Availability Check results will be recorded.

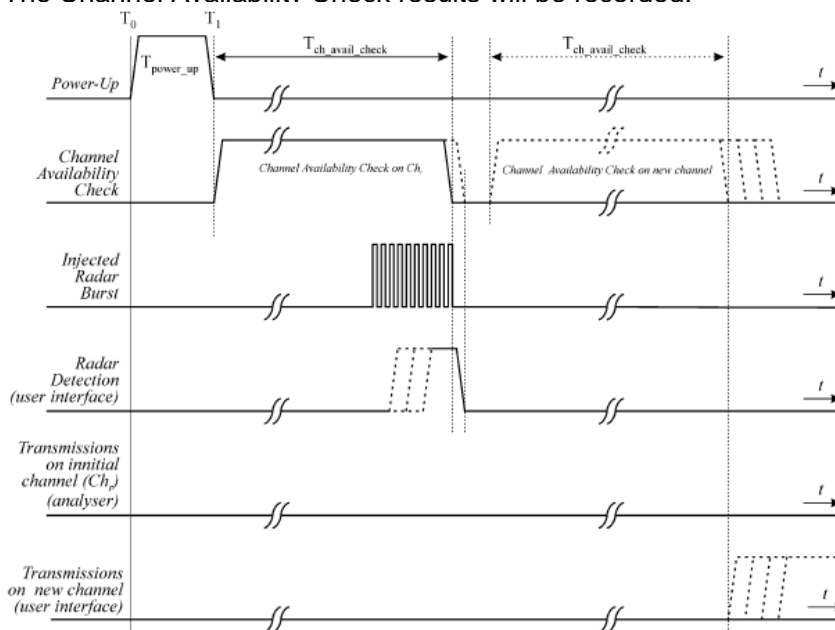

Figure 16: Example of timing for radar testing towards the end of the Channel Availability Check Time

5.6.1. Test Result of radar burst at the end of the Channel Availability Check Time

Not required



5.7. U-NII Detection Bandwidth

Additional requirements for devices with multiple bandwidth modes	Master or Client with radar detection	Client without radar detection
U-NII Detection Bandwidth and Statistical Performance Check	All BW modes must be tested	Not required
Note: Frequencies selected for statistical performance check (Section 7.8.4) should include several frequencies within the radar detection bandwidth and frequencies near the edge of the radar detection bandwidth. For 802.11 devices it is suggested to select frequencies in each of the bonded 20 MHz channels and the channel center frequency.		

5.7.1. Test Limit

Limits Clause 4.7.2.1.2 Table D.2: DFS requirement values

Parameter	Value
U-NII Detection Bandwidth	Minimum 100% of the U-NII 99% transmission
Note : During the U-NII Detection Bandwidth detection test, radar type 0 should be used. For each frequency step the minimum percentage of detection is 90 percent. Measurements are performed with no data traffic.	

5.7.2. Test Result of U-NII Detection Bandwidth

Not required



5.8. Statistical Performance Check

The UUT will select channel by random mode and remember this channel when detect radar signal, so that will select unused channel by random mode.

5.8.1. Test Result of Uniform Spreading

Not required



5.9. In-Service Monitoring

The In-Service Monitoring is defined as the process by which an RLAN monitors the Operating Channel for the presence of radar signals.

Additional requirements for devices with multiple bandwidth modes	Master or Client with radar detection	Client without radar detection
U-NII Detection Bandwidth and Statistical Performance Check	All BW modes must be tested	Not required
Channel Move Time and Channel Closing Transmission Time	Test using widest BW mode available	Test using the widest BW mode available for the link
All other	Any single BW mode	Not required
Note: Frequencies selected for statistical performance check (Section 7.8.4) should include several frequencies within the radar detection bandwidth and frequencies near the edge of the radar detection bandwidth. For 802.11 devices it is suggested to select frequencies in each of the bonded 20 MHz channels and the channel center frequency.		

5.9.1. Test Limit

Parameter	Value
Channel Move Time	< 10 s (See Note 1)
Channel Closing Transmission Time	< 200 ms+ an aggregate of 60 milliseconds over remaining 10 second period. (See Notes 1 and Notes 2.)
Note 1: Channel Move Time and the Channel Closing Transmission Time should be performed with Radar Type 0. The measurement timing begins at the end of the Radar Type 0 burst. Note 2: The Channel Closing Transmission Time is comprised of 200 milliseconds starting at the beginning of the Channel Move Time plus any additional intermittent control signals required to facilitate a Channel move (an aggregate of 60 milliseconds) during the remainder of the 10 second period. The aggregate duration of control signals will not count quiet periods in between transmissions.	

Limits Clause 4.7.2.2.2

The In-Service Monitoring shall be used to continuously monitor an Operating Channel.

The In-Service-Monitoring shall start immediately after the RLAN has started transmissions on an Operating Channel.



5.9.2. Test Result of In-Service Monitoring

	Value	Limit
Channel Move Time	1.5127622	<10 s
Channel Closing Transmission Time	5.5999	< 60 ms

Modulation Type:802.11ac VHT80, ch58@5320MHz

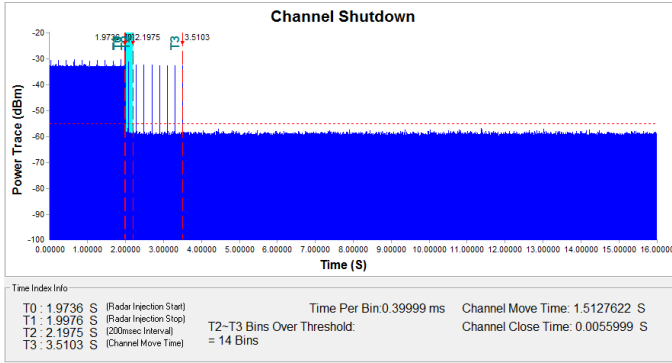

	Value	Limit
Channel Move Time	1.6447589	<10 s
Channel Closing Transmission Time	6.7998	< 60 ms

Modulation Type:802.11ac VHT80, ch106@5500MHz

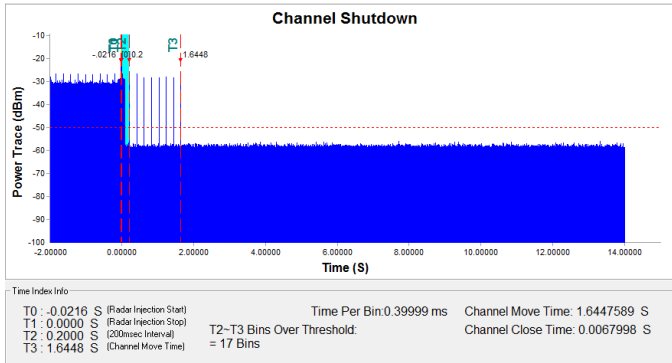



5.10. Non-Occupancy Period

The Channel Shutdown is defined as the process initiated by the RLAN device immediately after a radar signal has been detected on an Operating Channel.

The master device shall instruct all associated slave devices to stop transmitting on this channel, which they shall do within the Channel Move Time.

Slave devices with a Radar Interference Detection function, shall stop their own transmissions within the Channel Move Time.

The aggregate duration of all transmissions of the RLAN device on this channel during the Channel Move Time shall be limited to the Channel Closing Transmission Time. The aggregate duration of all transmissions shall not include quiet periods in between transmissions.

5.10.1. Test Limit

Radar Test Signal	Master (min)	Client (min)
0	> 30	> 30

5.10.2. Channel Loading

A link is established between the AP. Use Iperf ver.2.0.9 Software to simulate data transfer is streamed to generate WLAN traffic.

Timing plots are required with calculations demonstrating a minimum channel loading of approximately 17% or greater. For example, channel loading can be estimated by setting the spectrum analyzer for zero span and approximate the Time On/ (Time On + Off Time). This can be done with any appropriate channel BW and modulation type

Modulation Type:802.11ac VHT80
Time On/ (Time On + Off Time) =18.46%

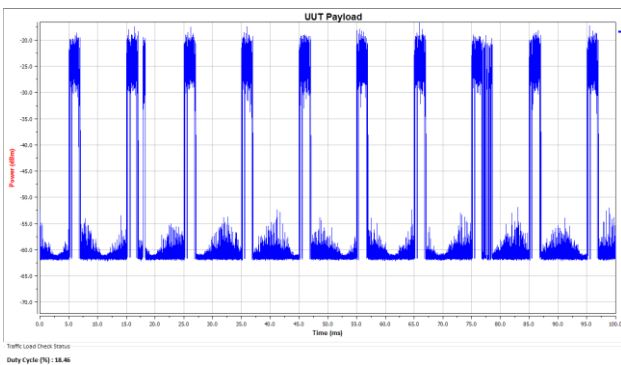



5.10.3. Test Result of Non-Occupancy Period

Modulation Type:802.11ac VHT80, ch58@5260MHz

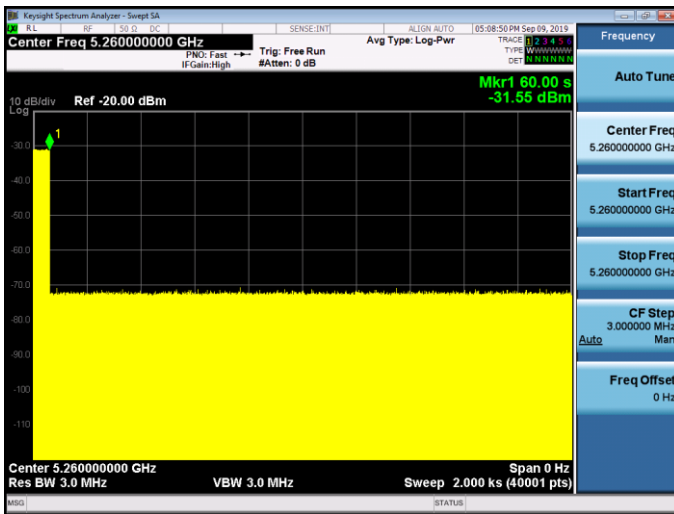

Modulation Type:802.11ac VHT80, ch106@5500MHz

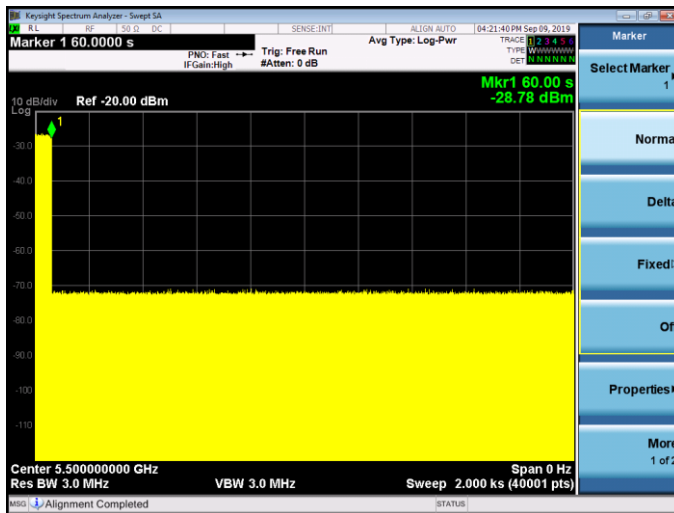

-----THE END OF REPORT-----