



Engineering Solutions & Electromagnetic Compatibility Services

**Certification Application Report  
FCC Part 15.247 & ISED Canada RSS-247**

<b>Test Lab:</b> Rhein Tech Laboratories, Inc.      Tel: 703-689-0368 360 Herndon Parkway              Fax: 703-689-2056 Suite 1400                              www.rheintech.com Herndon, VA 20170 E-Mail: atcbinfo@rheintech.com		<b>Applicant:</b> Alarm.com                              Tel: 703-584-7319 8281 Greensboro Drive Suite 100 Tysons, VA 22102	
<b>FCC ID</b>	YL6-143NK200T	<b>Test Report Date</b>	August 27, 2019
<b>IC</b>	9111A-143NK200T	<b>RTL Work Order #</b>	2019118
<b>Model #/HVIN</b>	ADC-NK-200T-A	<b>RTL Quote #</b>	QRTL19-118A
<b>American National Standard Institute</b>	ANSI C63.10-2013: American National Standard of Procedures for Compliance Testing of Unlicensed Wireless Devices		
<b>FCC Classification</b>	DTS – Digital Transmission System		
<b>FCC Rule Part(s)/Guidance</b>	FCC Rules Part 15.247: Operation within the bands 902-928 MHz, 2400-2483.5 MHz and 5725-5850 MHz Direct Sequence System (2018)		
<b>ISED Canada</b>	RSS-247 Issue 2 Digital Transmission Systems (DTSs), Frequency Hopping Systems (FHSs) and Licence-Exempt Local Area Network (LE-LAN) Devices		
<b>Digital Interface Information</b>	Digital Interface was found to be compliant		
<b>Frequency Range (MHz)</b>	<b>Output Power (W)*</b>	<b>Frequency Tolerance</b>	<b>Emission Designator</b>
912 – 924	0.0083	N/A	889KF1D

\* power is conducted

I, the undersigned, hereby declare that the equipment tested and referenced in this report conforms to the identified standard(s) as described in this test report. No modifications were made to the equipment during testing in order to achieve compliance with these standards. Furthermore, there was no deviation from, additions to, or exclusions from, the applicable parts of FCC Part 2, FCC Part 15, RSS-247 and ANSI C63.10.

Signature: 

Date: August 27, 2019

Typed/Printed Name: Desmond A. Fraser

Position: President

*This report may not be reproduced, except in full, without the written approval of Rhein Tech Laboratories, Inc. and Alarm.com. The test results relate only to the item(s) tested.  
This replaces R0.0.*

*These test(s) are accredited under Rhein Tech Laboratories, Inc. ISO/IEC 17025 accreditation issued by ANAB. Refer to certificate and scope of accreditation AT-1445.*

## Table of Contents

---

1	General Information.....	5
1.1	Scope .....	5
1.2	Description of EUT .....	5
1.3	Test Facility.....	5
1.4	Related Submittal(s)/Grant(s) .....	5
1.5	Modifications .....	5
2	Test Information .....	6
2.1	Description of Test Modes.....	6
2.2	Exercising the EUT.....	6
2.3	Test Result Summary.....	6
2.4	Test System Details .....	7
2.5	Configuration of Tested System.....	7
3	Peak Output Power - 15.247(b)(3); ISED RSS-247 5.4(d), RSS-Gen 6.12.....	8
3.1	Power Output Test Procedure .....	8
3.2	Peak Output Power Test Data .....	8
4	Peak Power Spectral Density – FCC 15.247(e); ISED RSS-247 5.2(b).....	15
4.1	Peak Spectral Density Test Procedure .....	15
4.2	Peak Spectral Density Test Data.....	15
5	Antenna Conducted Spurious Emissions – FCC 15.247(d); ISED RSS-247 5.5, RSS-Gen 6.13 .....	19
5.1	Antenna Conducted Spurious Emissions Test Procedures.....	19
5.2	Antenna Conducted Spurious Emissions Test Results.....	19
6	Compliance with the Band Edge – FCC 15.247(d), 15.205(a); RSS-247 5.5.....	20
6.1	Band Edge Test Procedure .....	20
6.2	Band Edge Test Results.....	21
6.2.1	Lower Band Edge.....	21
6.2.2	Upper Band Edge.....	22
7	Bandwidth – FCC 15.247(a)(2); RSS-247 5.2(a), RSS-Gen 6.7.....	23
7.1	6 dB Bandwidth Test Procedure .....	23
7.2	Bandwidth Test Results.....	23
8	Radiated Emissions – FCC 15.209; ISED RSS-247 5.5, RSS-Gen 6.13/7.....	30
8.1	Limits of Radiated Emissions Measurement.....	30
8.2	Radiated Emissions Measurement Test Procedure.....	30
8.3	Radiated Emissions Test Results .....	31
8.3.1	Unintentional Radiated Emissions Test Data.....	31
8.3.2	Spurious/Harmonics Radiated Emissions Test Data.....	32
9	AC Conducted Emissions - FCC 15.207; ISED RSS-Gen 7.2: AC Power Line Conducted Limits....	36
9.1	Site and Test Description.....	36
9.2	Test Limits.....	36
9.3	Conducted Emissions Test Data.....	37
10	Conclusion .....	46

**Figure Index**

Figure 2-1: Configuration of System Under Test..... 7

**Table Index**

Table 2-1: Channels Tested..... 6  
 Table 2-2: Test Result Summary – FCC Part 15 Subpart C (Section 15.247) & ISED ..... 6  
 Table 2-3: Equipment Under Test ..... 7  
 Table 2-4: Auxiliary Equipment ..... 7  
 Table 3-1: Peak Power Output Test Equipment..... 8  
 Table 3-2: Peak Output Power Test Data..... 8  
 Table 4-1: Peak Spectral Density Test Equipment..... 15  
 Table 4-2: Peak Spectral Density Test Data..... 15  
 Table 5-1: Antenna Conducted Spurious Test Equipment ..... 19  
 Table 6-1: Band Edge Test Equipment ..... 20  
 Table 7-1: 6 dB Bandwidth Test Equipment ..... 23  
 Table 7-2: 6 dB Bandwidth Test Data..... 23  
 Table 7-3: 99% Bandwidth Test Data..... 27  
 Table 8-1: Radiated Emissions Test Equipment..... 30  
 Table 8-2: Digital Radiated Emissions - Mode LTE Module RI7LE910NAV2; Power Supply #1. 31  
 Table 8-3: Digital Radiated Emissions - Mode LTE Module RI7LE910NAV2; Power Supply #2. 31  
 Table 8-4: Digital Radiated Emissions - Mode LTE Module RI7LE910SVL; Power Supply #1 ... 31  
 Table 8-5: Digital Radiated Emissions - Mode LTE Module RI7LE910SVL; Power Supply #2 ... 32  
 Table 8-6: Radiated Emissions Spurious/Harmonics – 912 MHz – Peak Detector ..... 32  
 Table 8-7: Radiated Emissions Spurious/Harmonics – 912 MHz – Average Detector ..... 32  
 Table 8-8: Radiated Emissions Spurious/Harmonics – 918 MHz – Peak Detector ..... 33  
 Table 8-9: Radiated Emissions Spurious/Harmonics – 918 MHz – Average Detector ..... 33  
 Table 8-10: Radiated Emissions Spurious/Harmonics – 924 MHz – Peak Detector ..... 34  
 Table 8-11: Radiated Emissions Spurious/Harmonics – 924 MHz – Average Detector ..... 34  
 Table 8-12: Radiated Emissions - Collocation Frequencies Tested ..... 35  
 Table 9-1: Conducted Emissions Test Equipment..... 36  
 Table 9-2: Conducted Emissions – Phase – BOLT Power Supply #2..... 37  
 Table 9-3: Conducted Emissions – Neutral – BOLT Power Supply #2 ..... 38  
 Table 9-4: Conducted Emissions – Phase – NA LTE; Power Supply #1 ..... 39  
 Table 9-5: Conducted Emissions – Neutral – NA LTE; Power Supply #1 ..... 40  
 Table 9-6: Conducted Emissions – Phase – NA LTE; Power Supply #2 ..... 41  
 Table 9-7: Conducted Emissions – Neutral – NA LTE; Power Supply #2 ..... 42  
 Table 9-8: Conducted Emissions – Phase - SVL LTE; Power Supply #2..... 43  
 Table 9-9: Conducted Emissions – Neutral – SVL LTE; Power Supply #2 ..... 44  
 Table 9-10: Conducted Emissions – Phase – SVL LTE; Power Supply #1..... 45

### Plot Index

Plot 3-1:	Average Power - 912 MHz .....	9
Plot 3-2:	Average Power - 918 MHz .....	10
Plot 3-3:	Average Power - 924 MHz .....	11
Plot 3-4:	Peak Power - 912 MHz .....	12
Plot 3-5:	Peak Power - 918 MHz .....	13
Plot 3-6:	Peak Power - 924 MHz .....	14
Plot 4-1:	Peak Spectral Density – 912 MHz .....	16
Plot 4-2:	Peak Spectral Density – 918 MHz .....	17
Plot 4-3:	Peak Spectral Density – 924 MHz .....	18
Plot 6-1:	Lower Band Edge .....	21
Plot 6-2:	Upper Band Edge .....	22
Plot 7-1:	6 dB Bandwidth – 912 MHz .....	24
Plot 7-2:	6 dB Bandwidth – 918 MHz .....	25
Plot 7-3:	6 dB Bandwidth – 924 MHz .....	26
Plot 7-4:	99% Bandwidth - 912 MHz .....	27
Plot 7-5:	99% Bandwidth - 918 MHz .....	28
Plot 7-6:	99% Bandwidth - 924 MHz .....	29
Plot 9-1:	Conducted Emissions – Phase - BOLT Power Supply #2 .....	37
Plot 9-2:	Conducted Emissions – Neutral - BOLT Power Supply #2 .....	38
Plot 9-3:	Conducted Emissions – Phase – NA LTE; Power Supply #1 .....	39
Plot 9-4:	Conducted Emissions – Neutral – NA LTE; Power Supply #1 .....	40
Plot 9-5:	Conducted Emissions – Phase – NA LTE; Power Supply #2 .....	41
Plot 9-6:	Conducted Emissions – Neutral – NA LTE; Power Supply #2 .....	42
Plot 9-7:	Conducted Emissions – Phase - SVL LTE; Power Supply #2 .....	43
Plot 9-8:	Conducted Emissions – Neutral - SVL LTE; Power Supply #2 .....	44
Plot 9-9:	Conducted Emissions – Phase - SVL LTE; Power Supply #1 .....	45
Plot 9-10:	Conducted Emissions – Neutral - SVL LTE; Power Supply #1 .....	46

### Appendix Index

Appendix A:	FCC Part 1.1307, 1.1310, 2.1091, 2.1093; ISED RSS-102: RF Exposure .....	47
Appendix B:	ACB Agency Authorization Letter .....	48
Appendix C:	FCC & ISED Confidentiality Request Letter .....	49
Appendix D:	ISED Letters .....	50
Appendix E:	Label and Label Location .....	51
Appendix F:	Technical Operational Description .....	52
Appendix G:	Schematics .....	53
Appendix H:	Block Diagram .....	54
Appendix I:	Manual .....	55
Appendix J:	Test Photographs .....	56
Appendix K:	External Photographs .....	62
Appendix L:	Internal Photographs .....	63

### Photograph Index

Photograph 1:	Radiated Emissions Testing – Front View (Digital Emissions, <1 GHz) .....	56
Photograph 2:	Radiated Emissions Testing – Back View (Digital Emissions, <1 GHz) .....	57
Photograph 3:	Radiated Emissions Testing – Front View (Spurious Emissions, >1 GHz) .....	58
Photograph 4:	Radiated Emissions Testing – Back View (Spurious Emissions, >1 GHz) .....	59
Photograph 5:	Conducted AC Emissions Testing – Front View .....	60
Photograph 6:	Conducted AC Emissions Testing – Rear View .....	61

## 1 General Information

### 1.1 Scope

This is an original FCC and ISED certification application request.

### 1.2 Description of EUT

<b>Equipment Under Test</b>	Multi-transceiver communication link
<b>Model</b>	ADC-NK-200T-A
<b>Power Supply</b>	5 VDC
<b>Modulation Type</b>	BPSK
<b>Frequency Range</b>	912-924 MHz
<b>Antenna Type</b>	Chip antenna

### 1.3 Test Facility

The open area test site and conducted measurement facility used to collect the radiated data is located at 360 Herndon Parkway, Suite 1400, Herndon, Virginia 20170. This site has been fully described in a report and approved by the Federal Communications Commission to perform AC line conducted and radiated emissions testing.

### 1.4 Related Submittal(s)/Grant(s)

This is an original certification application for Alarm.com Model ADC-NK-200T-A, FCC ID: YL6-143NK200T, IC: 9111A-143NK200T.

### 1.5 Modifications

No modifications were made to the equipment during testing.

## 2 Test Information

### 2.1 Description of Test Modes

In accordance with FCC 15.31(m), and because the EUT utilizes an operating band greater than 10 MHz, the following frequencies were tested.

**Table 2-1: Channels Tested**

Channel	Frequency
Low	912
Middle	918
High	924

### 2.2 Exercising the EUT

The EUT was supplied with a switch to change channels to a high, mid, and low channel for testing. The EUT was tested in all three orthogonal planes in order to determine worst-case emissions. The EUT was provided with the ability to continuously transmit during testing. The carrier was also checked to verify that information was being transmitted. There were no deviations from the test standard(s) and/or methods. The test results reported relate only to the item tested.

### 2.3 Test Result Summary

**Table 2-2: Test Result Summary – FCC Part 15 Subpart C (Section 15.247) & ISED**

Test	FCC Reference	ISED Reference	Result
Maximum Peak Power Output	15.247(b)(3)	RSS-247 5.4(d), RSS-Gen 6.12	Pass
Peak Power Spectral Density	15.247(e)	RSS-247 5.2(b)	Pass
Antenna Conducted Spurious Emissions	15.247(d)	RSS-247 5.5, RSS-Gen 6.13	Pass
Band Edge Measurement	15.247(d), 15.205(a)	RSS-247 5.5	Pass
Bandwidth	15.247(a)(2)	RSS-247 5.2(a) RSS-Gen 6.7	Pass
Radiated Emissions	15.209	RSS-247 5.5; RSS-Gen 6.13/7	Pass
AC Power Conducted Emissions	15.207	RSS-Gen 7.2	Pass

## 2.4 Test System Details

The test samples were received on June 26, 2019. The FCC identifiers for all applicable equipment, plus descriptions of all cables used in the tested system, are identified in the following table.

**Table 2-3: Equipment Under Test**

Part	Manufacturer	Model	Serial Number	FCC ID	Cable Description	RTL Bar Code
Transceiver	Alarm.com	ADC-NK-200T-A	NA T06611549	YL6-143NK200T	N/A	23286
Transceiver	Alarm.com	ADC-NK-200T-A	SVL T00611559	YL6-143NK200T	N/A	23288

**Table 2-4: Auxiliary Equipment**

Part	Manufacturer	Model	Serial Number	Cable Description	RTL Bar Code
5V DC AC Adapter (Power Supply #1)	Alarm.com	YS16F-0502000	N/A	1.5m unshielded	23290
5V DC AC Adapter (Power Supply #2)	Alarm.com	YS12-050200U	N/A	1.4m unshielded	23287

## 2.5 Configuration of Tested System

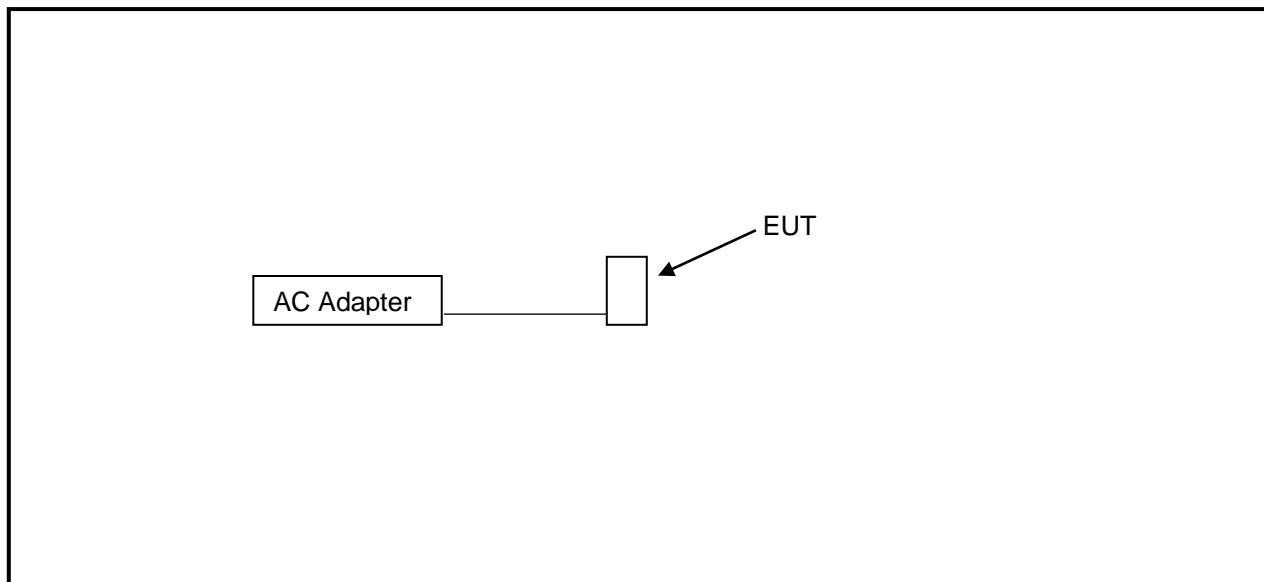

**Figure 2-1: Configuration of System Under Test**

### 3 Peak Output Power - 15.247(b)(3); ISED RSS-247 5.4(d), RSS-Gen 6.12

#### 3.1 Power Output Test Procedure

A conducted antenna port measurement was made with the spectrum analyzer for the low, mid, and high channels. The resolution bandwidth used was 1 MHz, and video bandwidth was 3 MHz for peak measurements.

**Table 3-1: Peak Power Output Test Equipment**

RTL Asset #	Manufacturer	Model	Part Type	Serial Number	Calibration Due Date
901583	Agilent Technologies	N9010A	EXA Signal Analyzer (10 Hz-26.5 GHz)	MY51250846	4/26/21

#### 3.2 Peak Output Power Test Data

**Table 3-2: Peak Output Power Test Data**

Emission Frequency (MHz)	Average Detector (dBm)	Peak Detector (dBm)
912	7.2	9.2
918	6.3	8.5
924	6.7	8.9



**Plot 3-1: Average Power - 912 MHz**

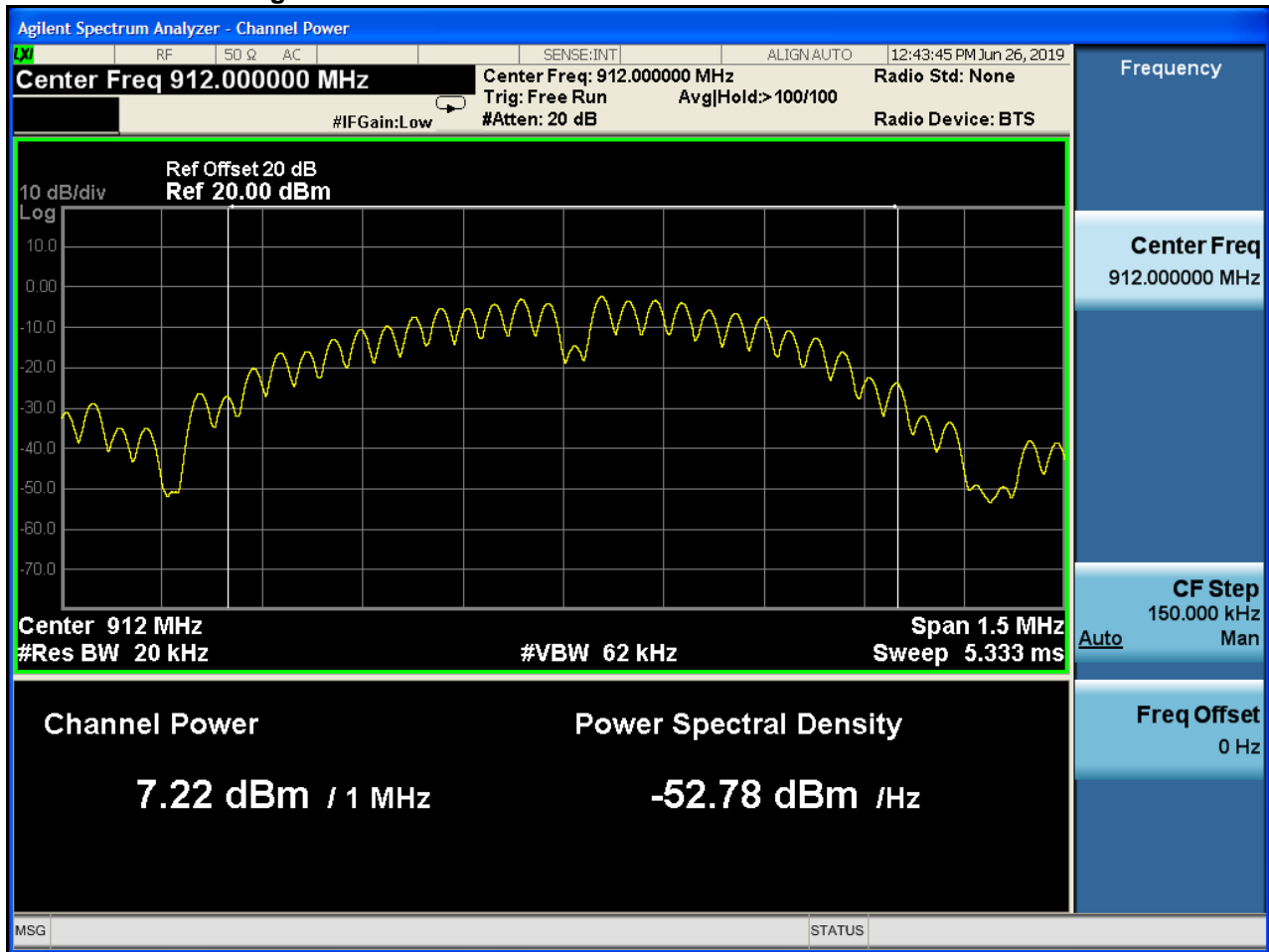

**Plot 3-2: Average Power - 918 MHz**

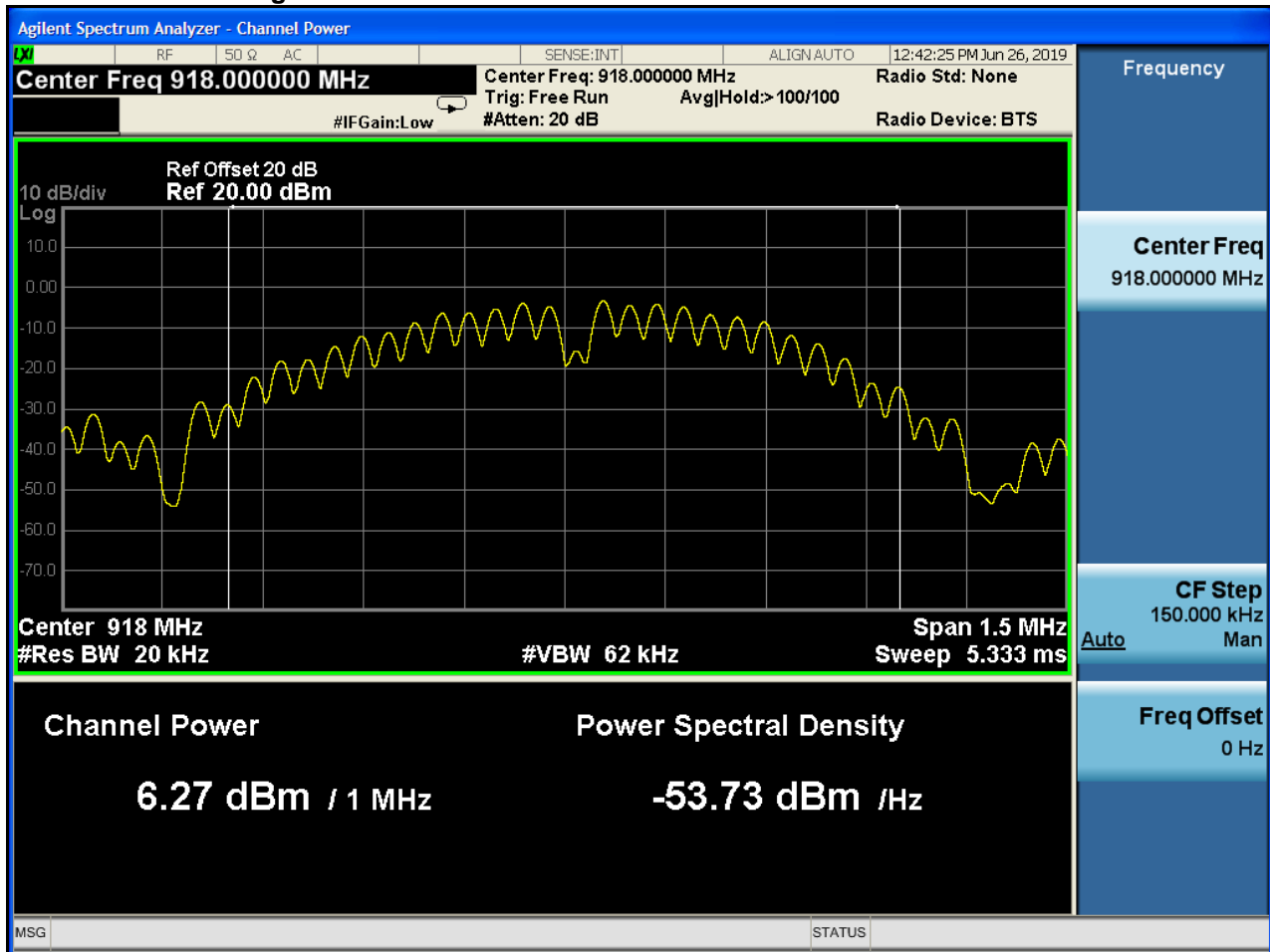

**Plot 3-3: Average Power - 924 MHz**

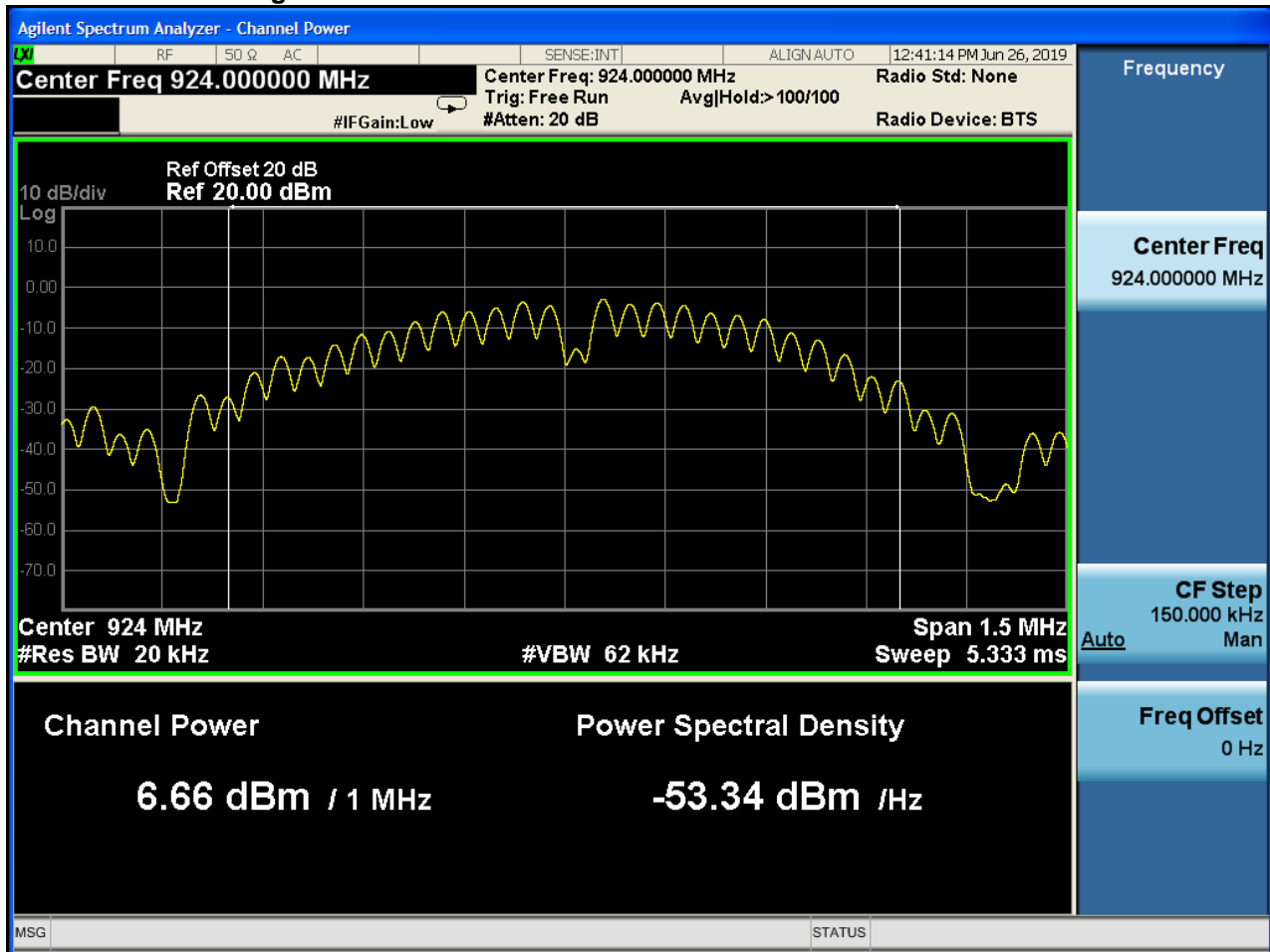

**Plot 3-4: Peak Power - 912 MHz**

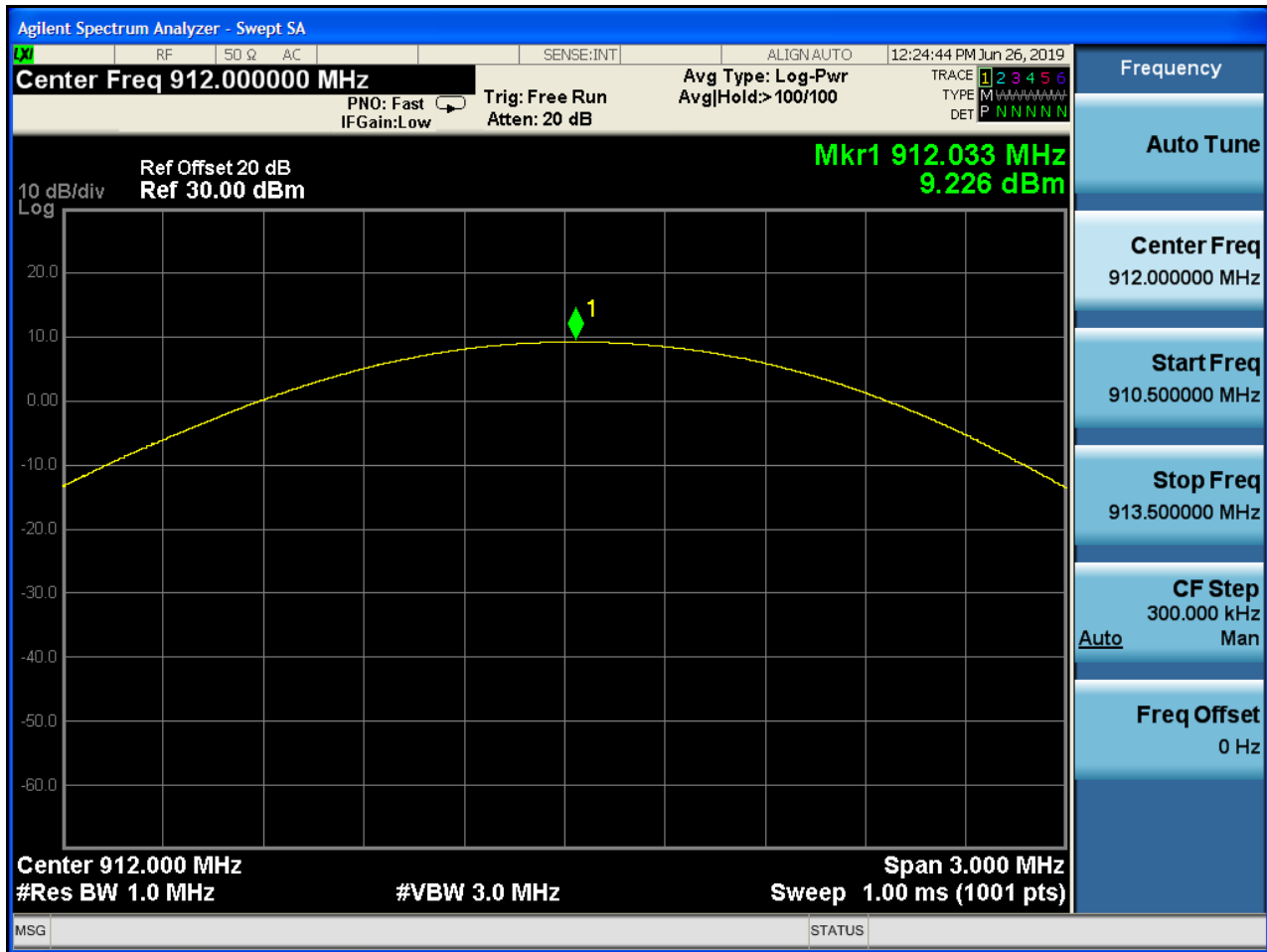

Plot 3-5: Peak Power - 918 MHz

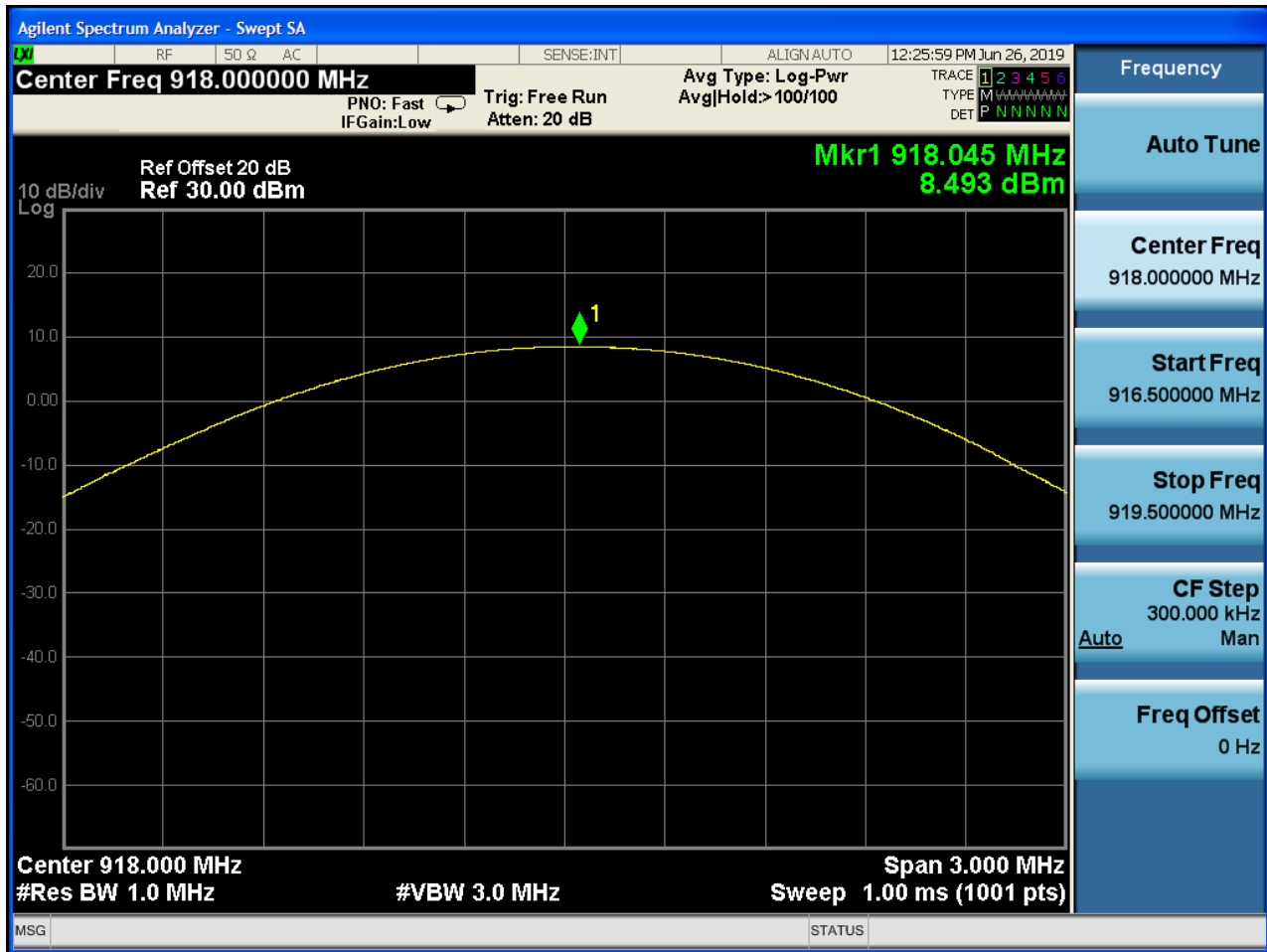

**Plot 3-6: Peak Power - 924 MHz**

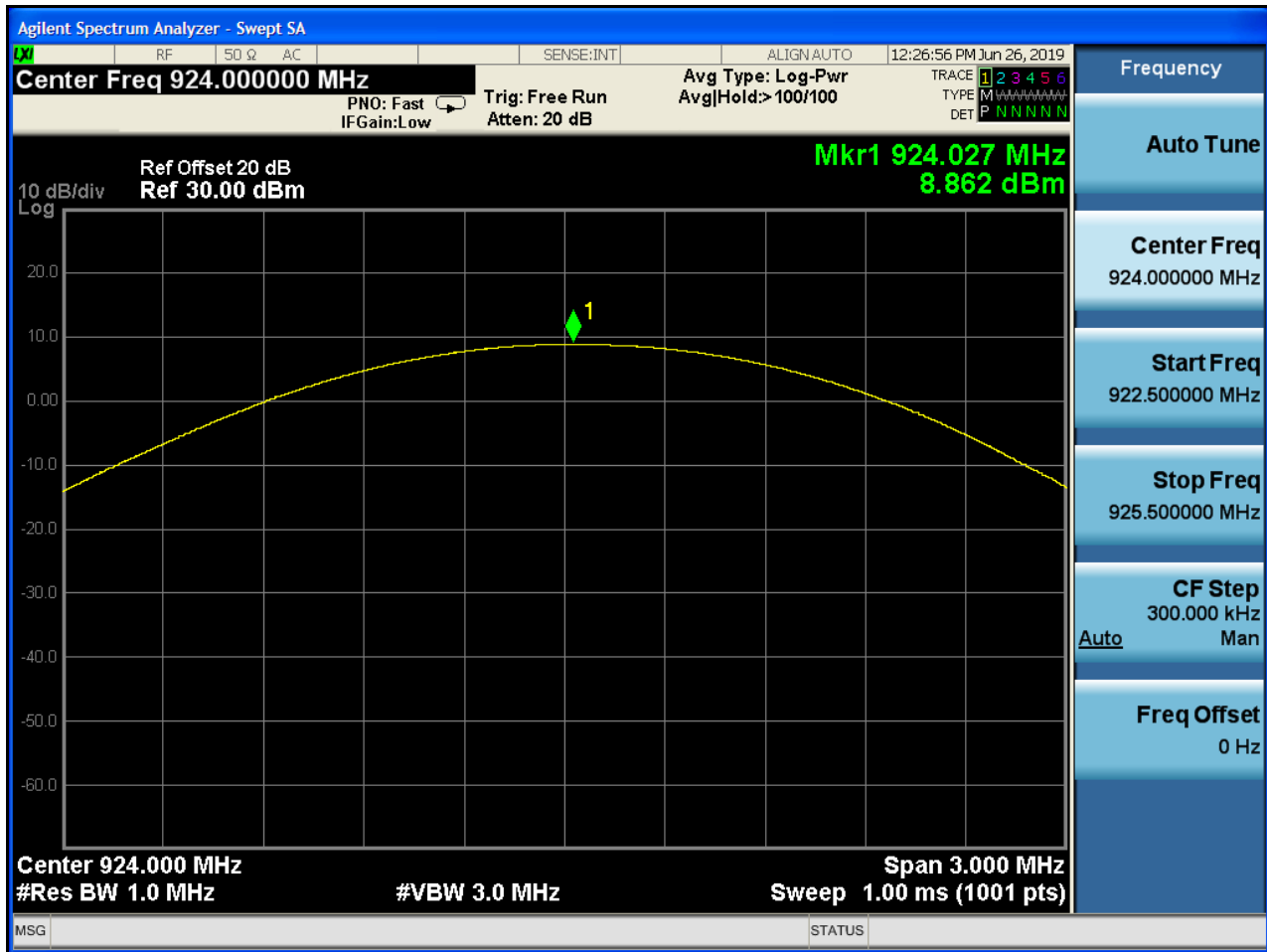

Measurement uncertainties shown for these tests are expanded Gaussian uncertainties expressed at 95% confidence level using a coverage factor  $k = 1.96$ . Measurement uncertainty = 0.5 dB.

**Test Personnel:**

Khue Do  
 Test Engineer

Signature

June 26, 2019  
 Date of Test

#### 4 Peak Power Spectral Density – FCC 15.247(e); ISED RSS-247 5.2(b)

##### 4.1 Peak Spectral Density Test Procedure

Digitally modulated systems shall have conducted peak power spectral density of 8 dBm in any 3 kHz band during any time interval of continuous transmission.

A maximum conducted measurement was established in dBm, a spectrum analyzer resolution bandwidth set to 100 kHz and a plot taken.

**Table 4-1: Peak Spectral Density Test Equipment**

RTL Asset #	Manufacturer	Model	Part Type	Serial Number	Calibration Due Date
901583	Agilent Technologies	N9010A	EXA Signal Analyzer (10 Hz-26.5 GHz)	MY51250846	4/26/21

##### 4.2 Peak Spectral Density Test Data

**Table 4-2: Peak Spectral Density Test Data**

Channels	Frequency (MHz)	Peak Output Power (dBm)
Low	912	4.9
Mid	918	4.0
High	924	4.4

Measurement uncertainties shown for these tests are expanded Gaussian uncertainties expressed at 95% confidence level using a coverage factor  $k = 1.96$ . Measurement uncertainty = 0.5 dB.

**Plot 4-1: Peak Spectral Density – 912 MHz**

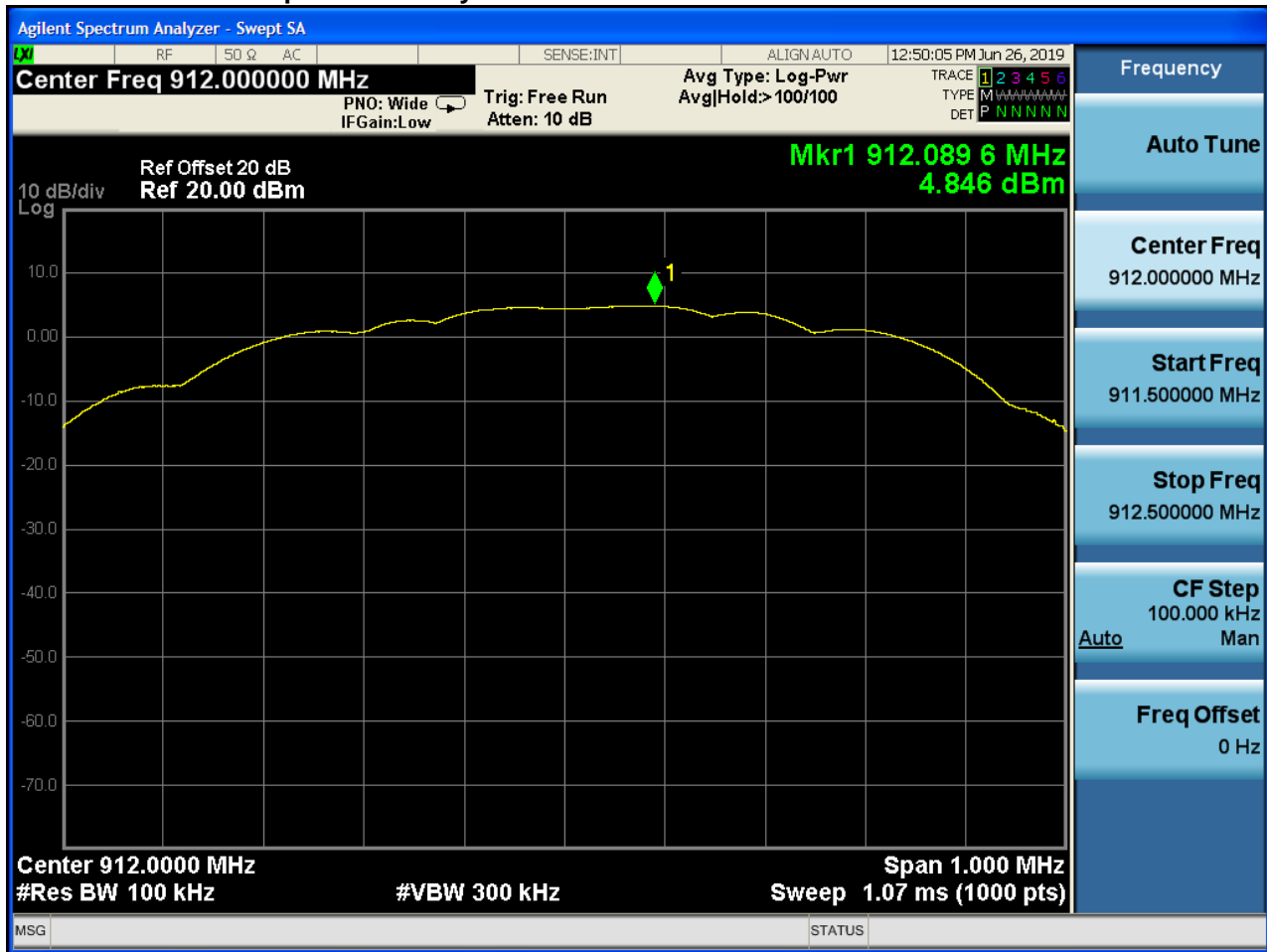



**Plot 4-2: Peak Spectral Density – 918 MHz**

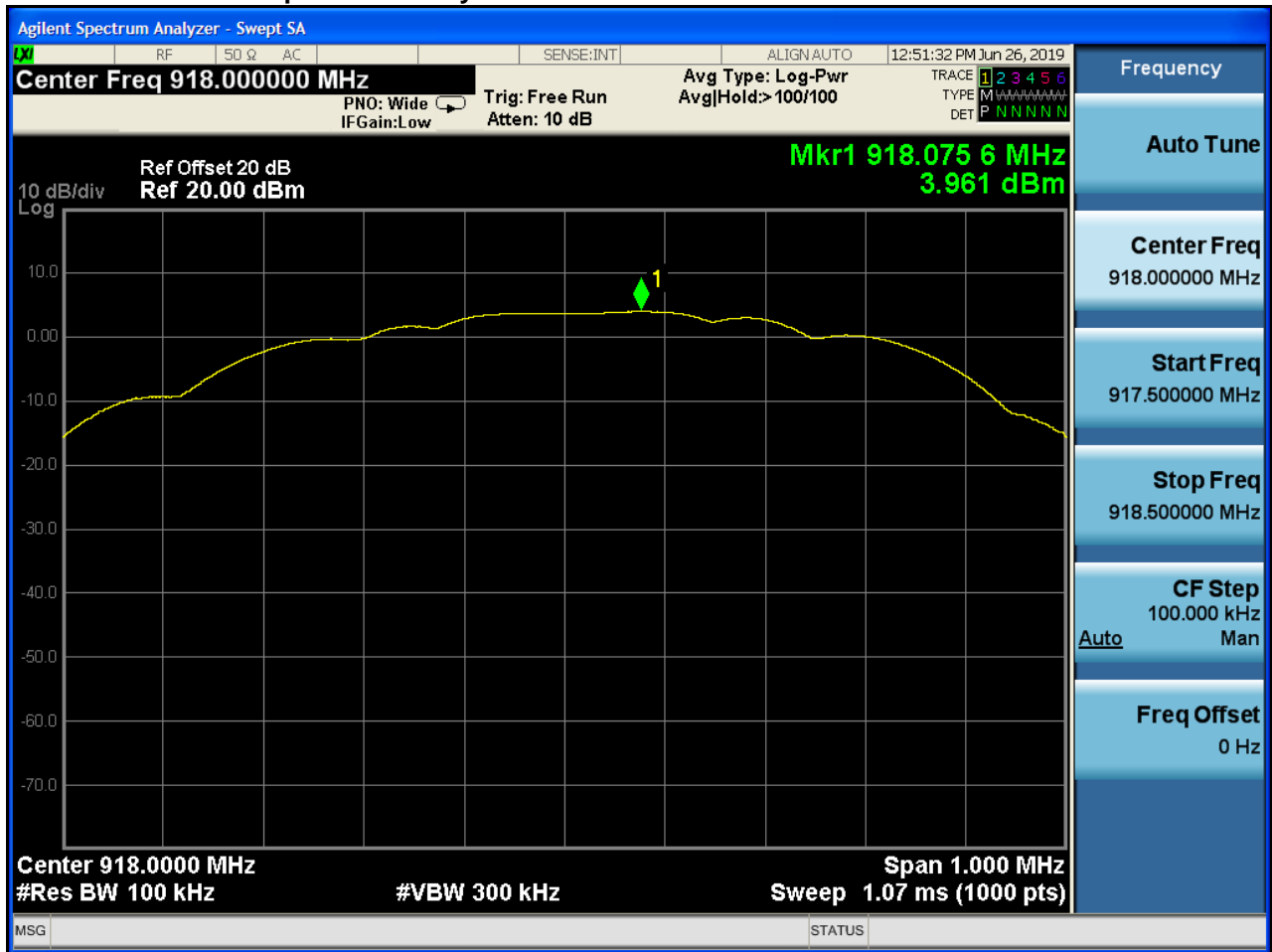

**Plot 4-3: Peak Spectral Density – 924 MHz**

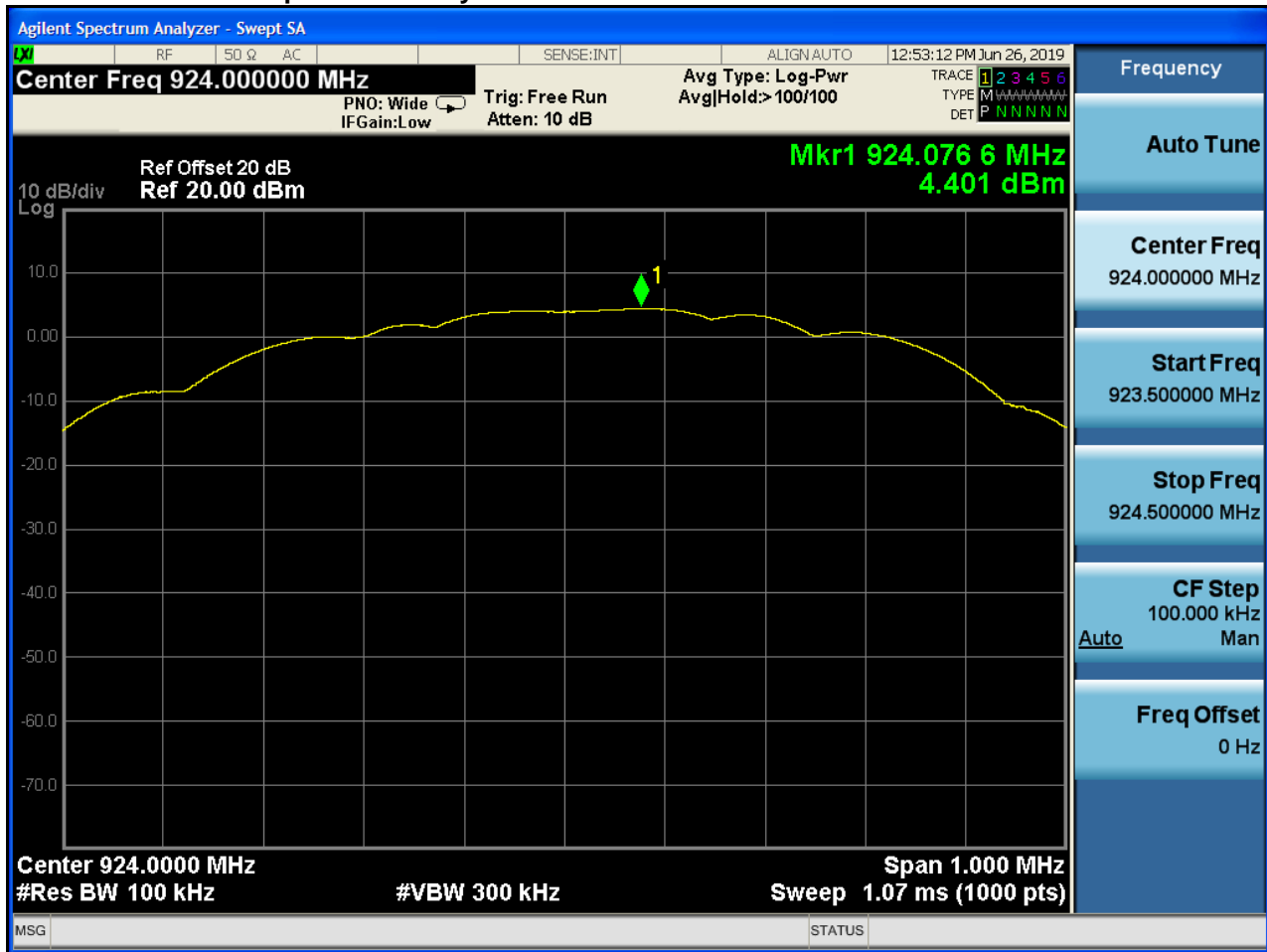

**Test Personnel:**

Khue Do  
 Test Engineer

*[Handwritten Signature]*  
 Signature

June 26, 2019  
 Date of Test

**5 Antenna Conducted Spurious Emissions – FCC 15.247(d); ISED RSS-247 5.5, RSS-Gen 6.13**

**5.1 Antenna Conducted Spurious Emissions Test Procedures**

Antenna spurious emissions per FCC 15.247(d) were measured from the EUT antenna port using a 50-ohm spectrum analyzer with the resolution bandwidth set at 100 kHz, and the video bandwidth set at 300 kHz. The modulated carrier was identified at the following frequencies: 912 MHz, 918 MHz and 924 MHz.

**5.2 Antenna Conducted Spurious Emissions Test Results**

No harmonics or spurs were found within 20 dB (note that we are reporting power as peak) of the carrier level from the carrier to the 10<sup>th</sup> harmonic of the carrier frequency. Per FCC 15.31(o), no data is being reported.

**Table 5-1: Antenna Conducted Spurious Test Equipment**

RTL Asset #	Manufacturer	Model	Part Type	Serial Number	Calibration Due Date
900930	Hewlett Packard	85662A	Spectrum Analyzer Display Section	3144A20839	4/26/20
900931	Hewlett Packard	8566B	Spectrum Analyzer (100 Hz - 22 GHz)	3138A07771	4/26/20

Measurement uncertainties shown for these tests are expanded uncertainties expressed at 95% confidence level using a coverage factor k = 2. Measurement uncertainty: ±0.8 dB.

**Results: PASS**

**Test Personnel:**

Daniel W. Baltzell EMC Test Engineer	 Signature	June 26, 2019 Date of Test
---	--	-------------------------------

## 6 Compliance with the Band Edge – FCC 15.247(d), 15.205(a); RSS-247 5.5

### 6.1 Band Edge Test Procedure

Conducted measurements were taken. The span was set wide enough to capture the peak level of the emission operating on the channel closest to the band edge, as well as any modulation products which fall outside of the authorized band of operation. The spectrum analyzer was set to the following:

RBW > = 1% of span  
VBW > = RBW  
Sweep = auto  
Detector function = peak  
Trace = max hold

The trace was allowed to stabilize. The marker was set on the emission at the band edge. The marker-delta was used to show the delta between the maximum in-band emission and the emission at the band edge, and was compared to the 20 dBc requirement of 15.247(d) (when using peak emissions) or restricted band.

**Table 6-1: Band Edge Test Equipment**

RTL Asset #	Manufacturer	Model	Part Type	Serial Number	Calibration Due Date
901583	Agilent Technologies	N9010A	EXA Signal Analyzer (10 Hz-26.5 GHz)	MY51250846	4/26/21

## 6.2 Band Edge Test Results

### 6.2.1 Lower Band Edge

Plot 6-1: Lower Band Edge

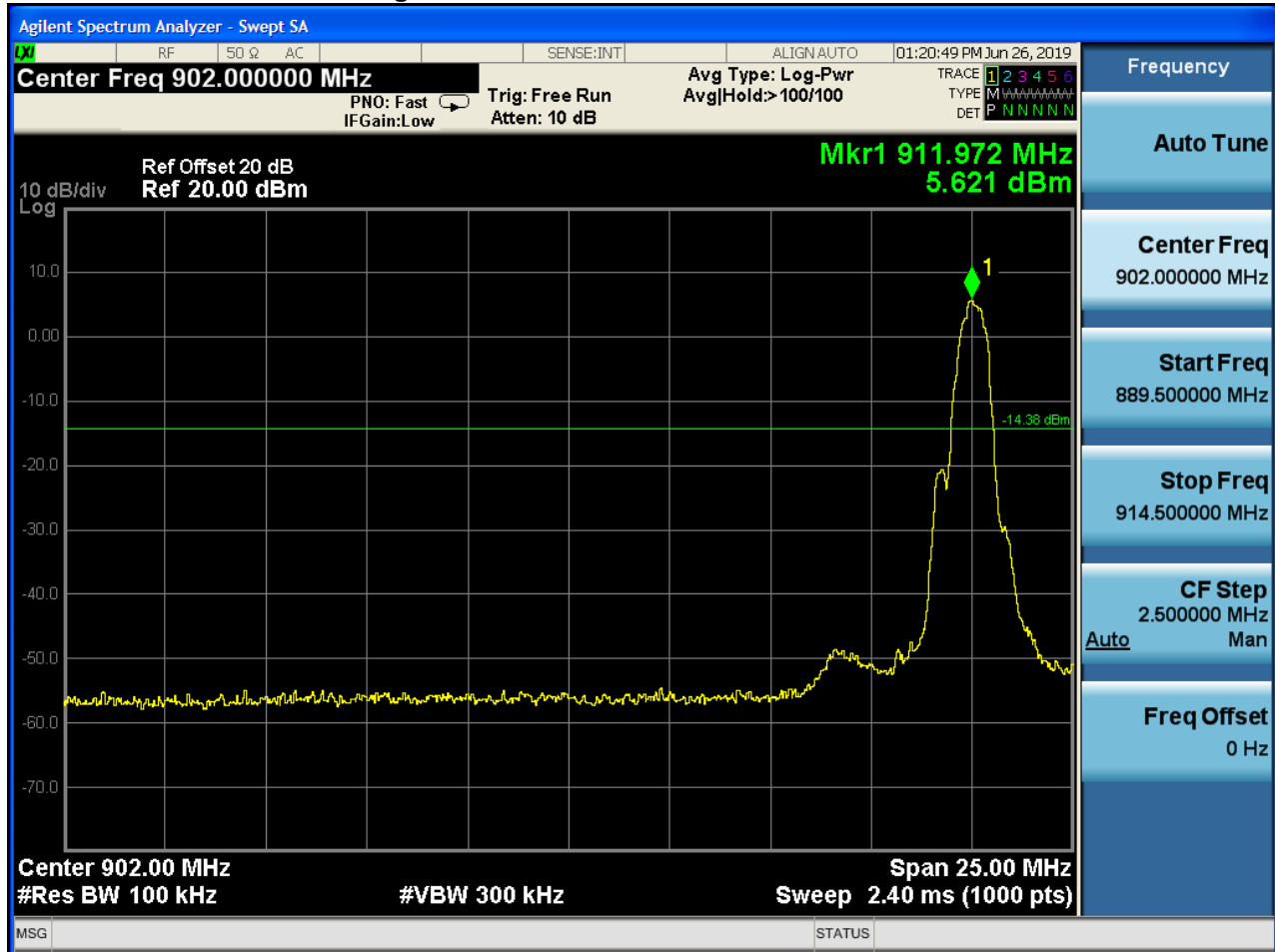

### 6.2.2 Upper Band Edge

Plot 6-2: Upper Band Edge



Measurement uncertainties shown for these tests are expanded Gaussian uncertainties expressed at 95% confidence level using a coverage factor  $k = 1.96$ . Measurement uncertainty = 0.5 dB.

**Test Personnel:**

Khue Do  
 Test Engineer

Signature

June 26, 2019  
 Date of Test

**7 Bandwidth – FCC 15.247(a)(2); RSS-247 5.2(a), RSS-Gen 6.7**

**7.1 6 dB Bandwidth Test Procedure**

The minimum 6 dB bandwidth per FCC 15.247 (a)(1) and RSS-247 were measured using a 50-ohm spectrum analyzer. The carrier was adjusted on the analyzer so that it was displayed entirely on the spectrum analyzer. The sweep time was set to auto and allowed through several sweeps with the max hold function used in peak detector mode. The resolution bandwidth was set to 100 kHz, and the video bandwidth set at 300 kHz.

**Table 7-1: 6 dB Bandwidth Test Equipment**

RTL Asset #	Manufacturer	Model	Part Type	Serial Number	Calibration Due Date
901583	Agilent Technologies	N9010A	EXA Signal Analyzer (10 Hz-26.5 GHz)	MY51250846	4/26/21

**7.2 Bandwidth Test Results**

**Table 7-2: 6 dB Bandwidth Test Data**

Frequency (MHz)	6 dB Bandwidth (kHz)	Limit (MHz)	Pass/Fail
912	664.5	0.5	Pass
918	652.7	0.5	Pass
924	655.5	0.5	Pass

Measurement uncertainties shown for these tests are expanded Gaussian uncertainties expressed at 95% confidence level using a coverage factor  $k = 1.96$ . Measurement uncertainty = 12 Hz.

**Plot 7-1: 6 dB Bandwidth – 912 MHz**

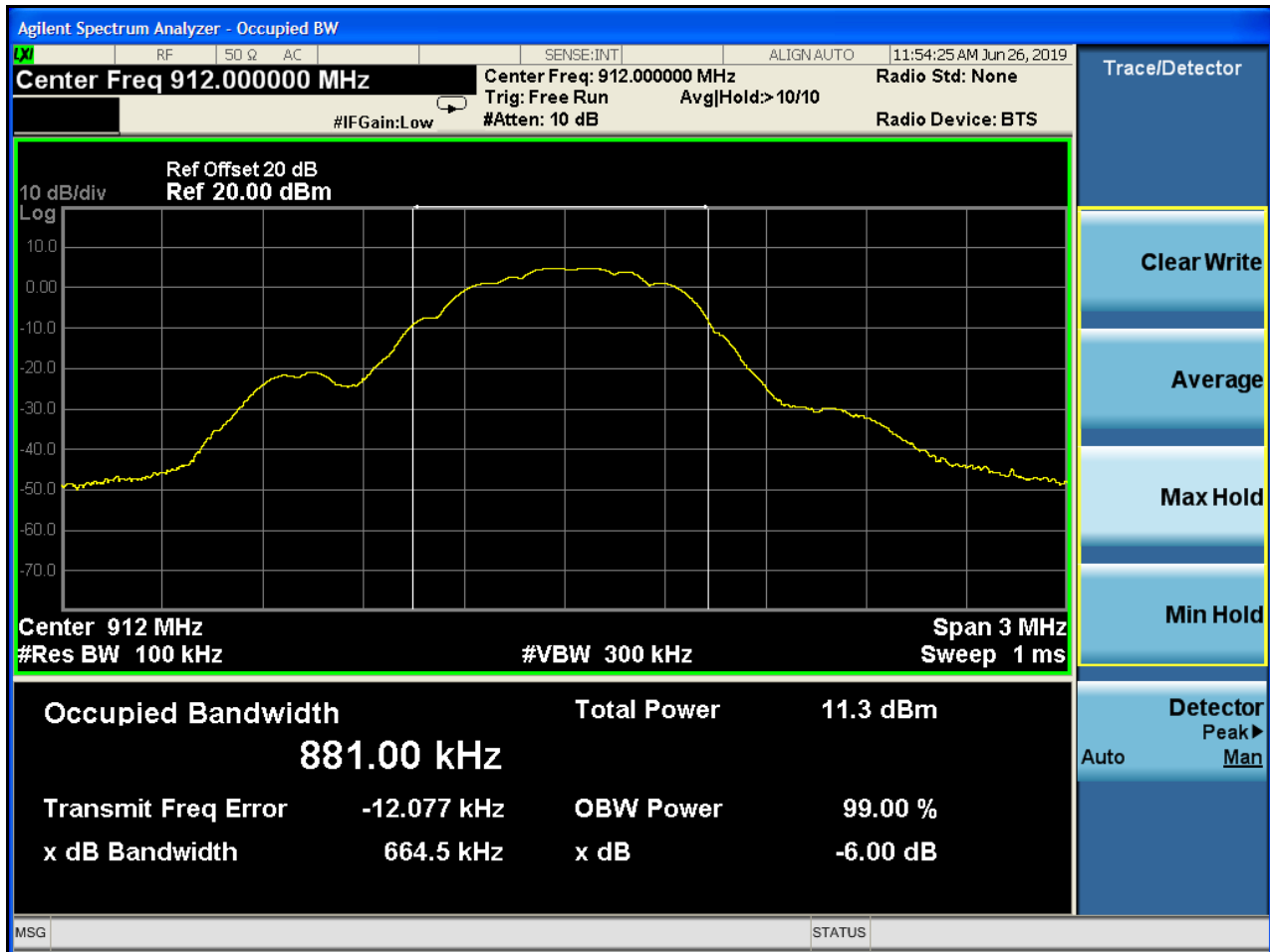



**Plot 7-2: 6 dB Bandwidth – 918 MHz**

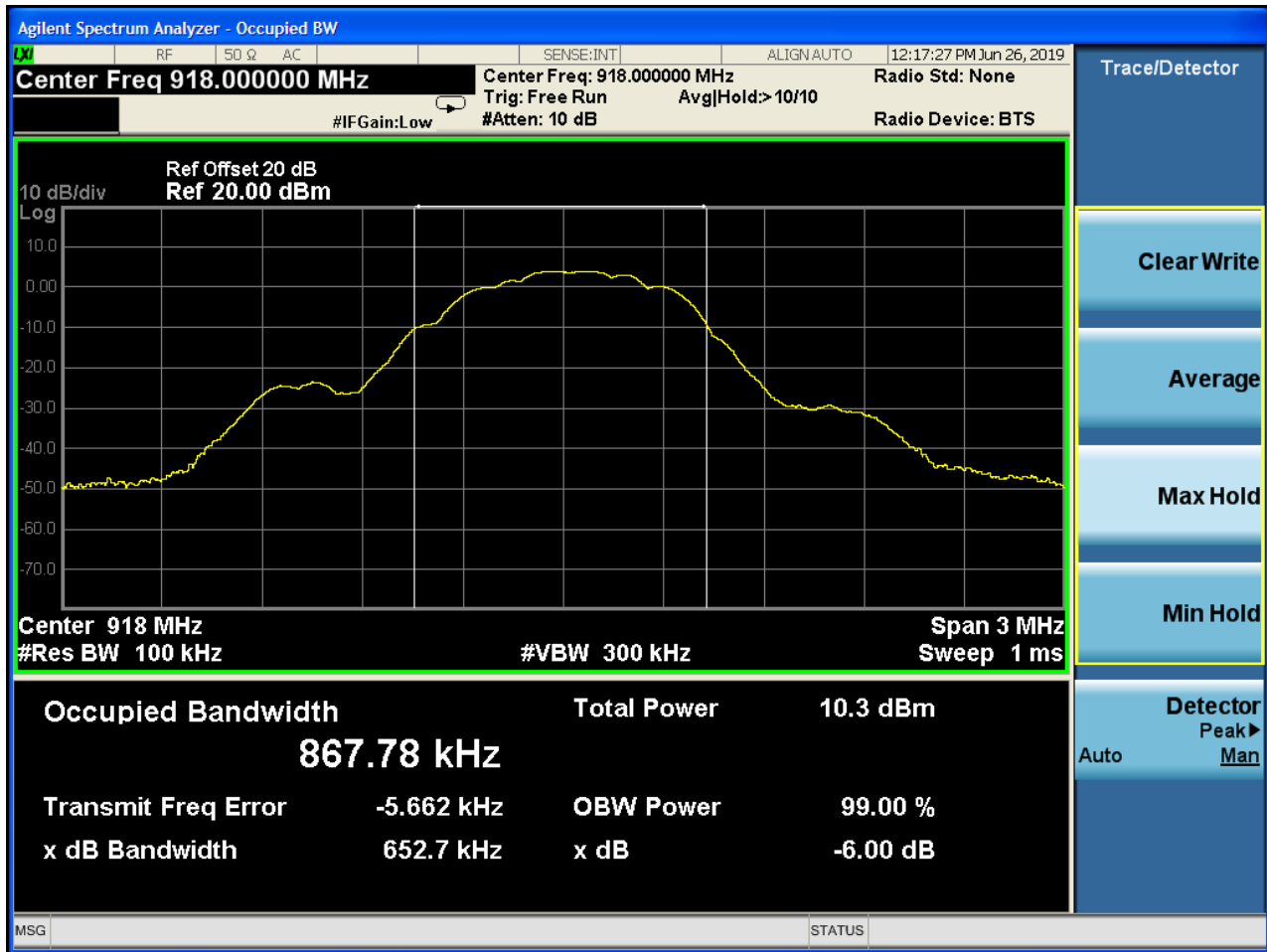

**Plot 7-3: 6 dB Bandwidth – 924 MHz**

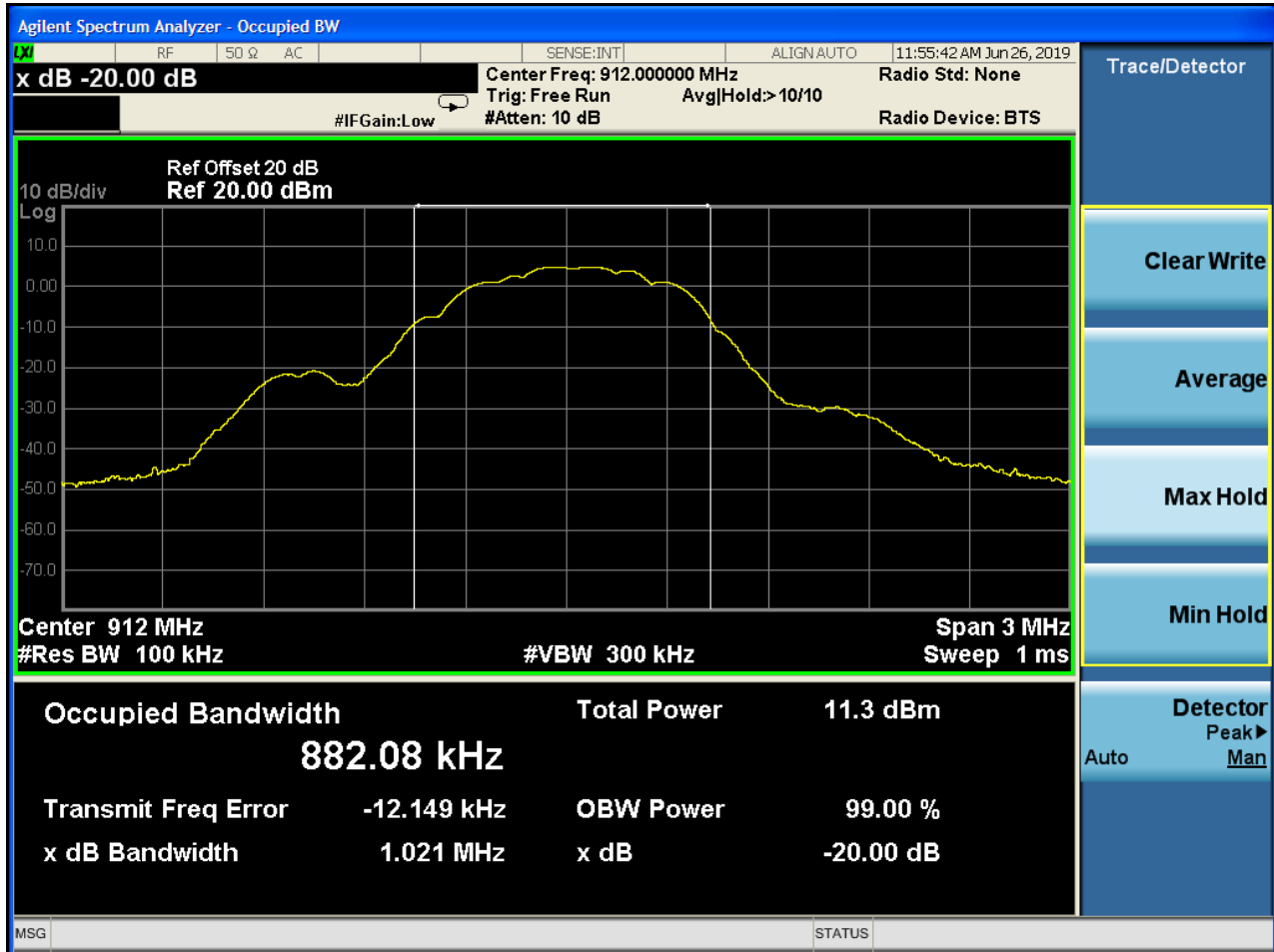

**Table 7-3: 99% Bandwidth Test Data**

99% bandwidths

Frequency (MHz)	Bandwidth (kHz)
912.0	882.1
918.0	868.3
924.0	889.0

**Plot 7-4: 99% Bandwidth - 912 MHz**



**Plot 7-5: 99% Bandwidth - 918 MHz**



**Plot 7-6: 99% Bandwidth - 924 MHz**

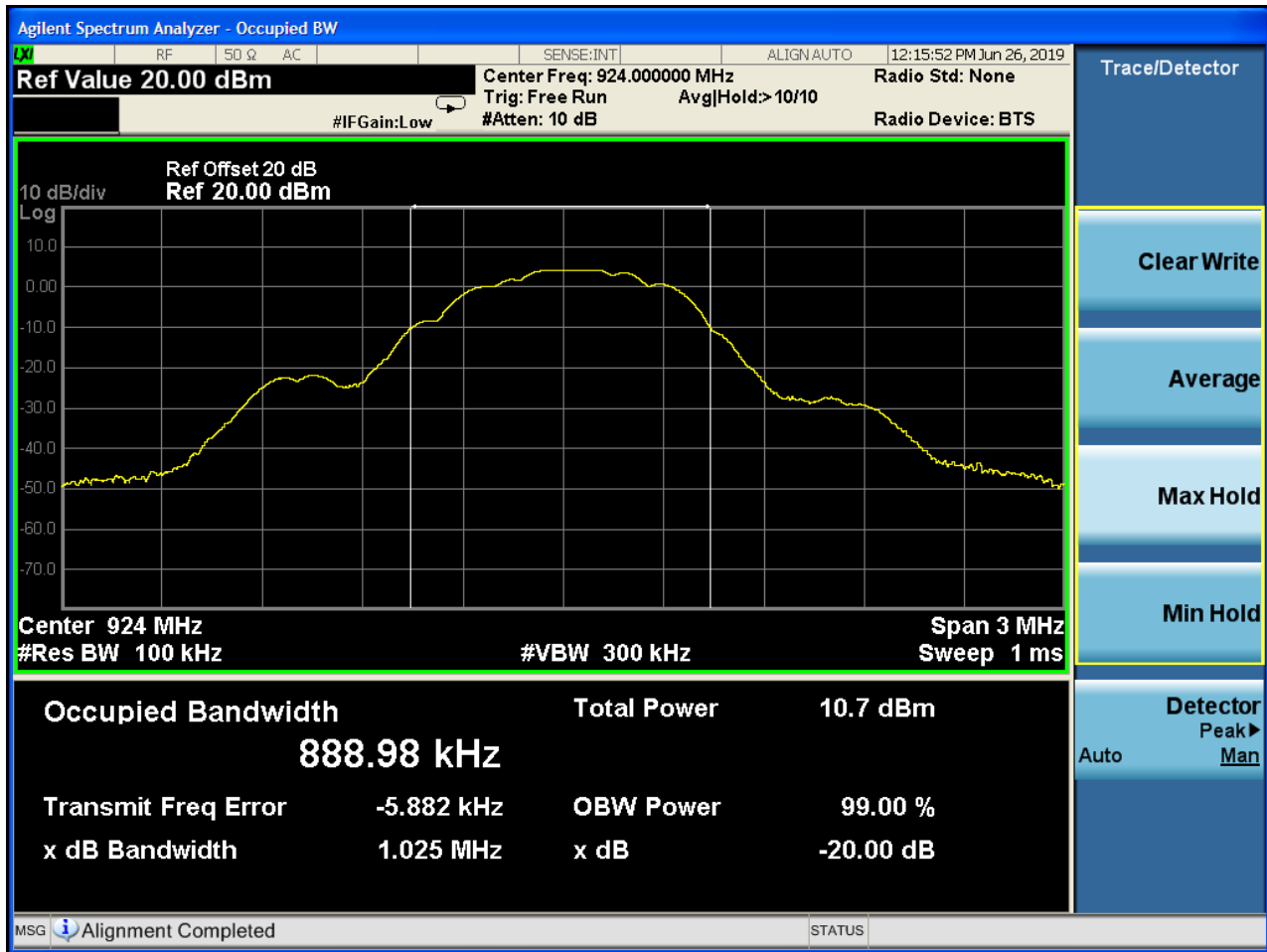

**Test Personnel:**

Khue Do  
 Test Engineer

*[Handwritten Signature]*  
 Signature

June 26, 2019  
 Date of Test

## 8 Radiated Emissions – FCC 15.209; ISED RSS-247 5.5, RSS-Gen 6.13/7

### 8.1 Limits of Radiated Emissions Measurement

Frequency (MHz)	Field Strength (uV/m)	Measurement Distance (m)
0.009-0.490	2400/f (kHz)	300
0.490-1.705	2400/f (kHz)	30
1.705-30.0	30	30
30-88	100	3
88-216	150	3
216-960	200	3
Above 960	500	3

As shown in 15.35(b), for frequencies above 1000 MHz, the field strength limits are based on average detector, however, the peak field strength of any emission shall not exceed the maximum permitted average limits, specified above by more than 20 dB under any circumstances of modulation.

### 8.2 Radiated Emissions Measurement Test Procedure

Before final measurements of radiated emissions were made on the open-field three/ten meter range, the EUT was scanned indoors at one and three meter distances. This was done in order to determine its emissions spectrum signature. The physical arrangement of the test system and associated cabling was varied in order to determine the effect on the EUT's emissions in amplitude, direction and frequency. This process was repeated during final radiated emissions measurements on the open-field range, at each frequency, in order to ensure that maximum emission amplitudes were attained. Final radiated emissions measurements were made on the three/ten-meter, open-field test site. The EUT was placed on a nonconductive turntable 1.5 meters above the ground plane. The spectrum was examined from 9 kHz to the 10<sup>th</sup> harmonic of the highest fundamental transmitter frequency (10 GHz). At each frequency, the EUT was rotated 360°, and the antenna was raised and lowered from 1 to 4 meters in order to determine the emission's maximum level. Measurements were taken using both horizontal and vertical antenna polarizations. For frequencies between 30 and 1000 MHz, the spectrum analyzer's 6 dB bandwidth was set to 120 kHz, and the analyzer was operated in the CISPR quasi-peak detection mode. For emissions above 1000 MHz, emissions are measured using a VBW of 10 Hz, with a minimum resolution bandwidth of 1 MHz. No video filter less than 10 times the resolution bandwidth was used. The highest emission amplitudes relative to the appropriate limit were measured and recorded in this report.

**Table 8-1: Radiated Emissions Test Equipment**

RTL Asset #	Manufacturer	Model	Part Type	Serial Number	Calibration Due Date
900791	Chase	CBL6112	Antenna (.03–2 GHz)	2099	10/4/20
900772	EMCO	3161-02	Horn Antenna (2-4 GHz)	9804-1044	5/17/21
900321	EMCO	3161-03	Horn Antenna (4-8.2 GHz)	9528-1020	5/17/21
900323	EMCO	3160-07	Horn Antenna (8.2-12.4 GHz)	9605-1024	5/17/21
901583	Agilent Technologies	N9010A	EXA Signal Analyzer (10 Hz-26.5 GHz)	MY51250846	4/26/21
901592	Insulated Wire Inc.	KPS-1503-3600-KPR	SMK RF Cables 20'	NA	10/5/19

### 8.3 Radiated Emissions Test Results

#### 8.3.1 Unintentional Radiated Emissions Test Data

**Table 8-2: Digital Radiated Emissions - Mode LTE Module RI7LE910NAV2; Power Supply #1**  
 Temperature: 84°F Humidity: 49%

Emission Frequency (MHz)	Antenna Polarity (H/V)	Emission Level (dBuV)	Site Factor (dB)	Emission Level (dBuV/m)	Limit (dBuV/m)	Azimuth (degrees)	Height (meters)	Margin (dB)	Pass /Fail
150.000	H	44.6	-15.9	28.7	43.5	180.0	2.0	-14.8	Pass
200.000	H	46.3	-16.6	29.7	43.5	225.0	1.0	-13.8	Pass
250.000	H	53.1	-13.3	39.8	46.0	135.0	1.0	-6.2	Pass
400.000	V	44.6	-8.5	36.1	46.0	135.0	1.0	-9.9	Pass
500.000	V	39.8	-6.4	33.4	46.0	180.0	1.5	-12.6	Pass
550.000	V	41.5	-3.9	37.5	46.0	315.0	1.0	-8.5	Pass

**Table 8-3: Digital Radiated Emissions - Mode LTE Module RI7LE910NAV2; Power Supply #2**  
 Temperature: 84°F Humidity: 49%

Emission Frequency (MHz)	Antenna Polarity (H/V)	Emission Level (dBuV)	Site Factor (dB)	Emission Level (dBuV/m)	Limit (dBuV/m)	Azimuth (degrees)	Height (meters)	Margin (dB)	Pass /Fail
150.000	H	47.3	-15.9	31.4	43.5	225.0	2.0	-12.1	Pass
250.000	H	57.1	-13.3	43.8	46.0	180.0	1.0	-2.2	Pass
400.000	H	42.2	-8.5	33.7	46.0	180.0	1.0	-12.3	Pass
500.010	V	40.8	-6.4	34.4	46.0	180.0	1.0	-11.6	Pass
600.000	H	37.9	-3.6	34.2	46.0	45.0	2.0	-11.8	Pass
650.000	V	40.2	-3.0	37.2	46.0	225.0	2.5	-8.8	Pass

**Table 8-4: Digital Radiated Emissions - Mode LTE Module RI7LE910SVL; Power Supply #1**  
 Temperature: 90°F Humidity: 45%

Emission Frequency (MHz)	Antenna Polarity (H/V)	Emission Level (dBuV)	Site Factor (dB)	Emission Level (dBuV/m)	Limit (dBuV/m)	Azimuth (degrees)	Height (meters)	Margin (dB)	Pass /Fail
150.000	H	45.7	-15.9	29.8	43.5	225.0	2.0	-13.7	Pass
200.000	V	49.3	-16.6	32.7	43.5	180.0	3.0	-10.8	Pass
250.000	H	46.1	-13.3	32.9	46.0	135.0	1.0	-13.1	Pass
300.000	H	41.1	-12.0	29.1	46.0	180.0	1.0	-16.9	Pass
350.000	H	37.9	-10.1	27.8	46.0	225.0	1.0	-18.2	Pass
400.000	H	39.3	-8.5	30.8	46.0	270.0	1.0	-15.2	Pass
450.000	H	35.2	-7.1	28.1	46.0	270.0	1.0	-17.9	Pass
500.000	H	40.0	-6.4	33.6	46.0	225.0	2.0	-12.4	Pass
600.000	H	38.8	-3.6	35.2	46.0	45.0	1.5	-10.8	Pass
650.000	V	45.7	-3.0	42.7	46.0	180.0	3.0	-3.3	Pass

**Table 8-5: Digital Radiated Emissions - Mode LTE Module R17LE910SVL; Power Supply #2**  
 Temperature: 90°F Humidity: 45%

Emission Frequency (MHz)	Antenna Polarity (H/V)	Emission Level (dBuV)	Site Factor (dB)	Emission Level (dBuV/m)	Limit (dBuV/m)	Azimuth (degrees)	Height (meters)	Margin (dB)	Pass /Fail
150.000	H	48.6	-15.9	32.7	43.5	225.0	2.5	-10.8	Pass
200.000	H	46.8	-16.6	30.2	43.5	225.0	1.0	-13.3	Pass
250.000	H	46.6	-13.3	33.3	46.0	135.0	1.0	-12.7	Pass
300.000	H	47.1	-12.0	35.1	46.0	270.0	1.0	-10.9	Pass
350.000	H	38.0	-10.1	27.9	46.0	225.0	1.0	-18.1	Pass
400.000	H	40.0	-8.5	31.5	46.0	270.0	1.0	-14.5	Pass
500.000	V	37.7	-6.4	31.3	46.0	270.0	1.0	-14.7	Pass
600.000	H	38.7	-3.6	35.1	46.0	45.0	1.5	-10.9	Pass

**8.3.2 Spurious/Harmonics Radiated Emissions Test Data**

**Table 8-6: Radiated Emissions Spurious/Harmonics – 912 MHz – Peak Detector**

Emission Frequency (MHz)	Analyzer Reading (dBuV)	Site Correction Factor (dB/m)	Emission Level (dBuV/m)	Limit (dBuV/m)	Margin (dB)
1824.0	63.6	-12.4	51.2	74.0	-22.8
2736.0	52.1	-13.5	38.6	74.0	-35.4
3648.0	61.5	-14.7	46.8	74.0	-27.2
4560.0	53.9	-9.7	44.2	74.0	-29.8
5472.0	55.0	-8.3	46.7	74.0	-27.3
6384.0	46.7	-6.2	40.5	74.0	-33.5
7296.0	57.5	-6.5	51.0	74.0	-23.0
8208.0	42.9	-0.7	42.2	74.0	-31.8
9120.0	39.0	-1.1	37.9	74.0	-36.1

**Table 8-7: Radiated Emissions Spurious/Harmonics – 912 MHz – Average Detector**

Emission Frequency (MHz)	Analyzer Reading (dBuV)	Site Correction Factor (dB/m)	Emission Level (dBuV/m)	Limit (dBuV/m)	Margin (dB)
1824.0	62.6	-12.4	50.2	54.0	-3.8
2736.0	50.2	-13.5	36.7	54.0	-17.3
3648.0	60.5	-14.7	45.8	54.0	-8.2
4560.0	48.2	-9.7	38.5	54.0	-15.5
5472.0	45.0	-8.3	36.7	54.0	-17.3
6384.0	37.0	-6.2	30.8	54.0	-23.2
7296.0	52.4	-6.5	45.9	54.0	-8.1
8208.0	32.4	-0.7	31.7	54.0	-22.3
9120.0	29.8	-1.1	28.7	54.0	-25.3



**Table 8-8: Radiated Emissions Spurious/Harmonics – 918 MHz – Peak Detector**

Emission Frequency (MHz)	Analyzer Reading (dBuV)	Site Correction Factor (dB/m)	Emission Level (dBuV/m)	Limit (dBuV/m)	Margin (dB)
1836.0	61.4	-11.4	50.0	74.0	-24.0
2754.0	56.6	-13.2	43.4	74.0	-30.6
3672.0	61.0	-13.8	47.2	74.0	-26.8
4590.0	55.1	-9.5	45.6	74.0	-28.4
5508.0	55.6	-8.4	47.2	74.0	-26.8
6426.0	44.6	-6.0	38.6	74.0	-35.4
7344.0	55.4	-6.3	49.1	74.0	-24.9
8262.0	42.8	-0.6	42.2	74.0	-31.8
9180.0	42.1	-2.2	39.9	74.0	-34.1

**Table 8-9: Radiated Emissions Spurious/Harmonics – 918 MHz – Average Detector**

Emission Frequency (MHz)	Analyzer Reading (dBuV)	Site Correction Factor (dB/m)	Emission Level (dBuV/m)	Limit (dBuV/m)	Margin (dB)
1836.0	60.8	-11.4	49.4	54.0	-4.6
2754.0	55.2	-13.2	42.0	54.0	-12.0
3672.0	59.9	-13.8	46.1	54.0	-7.9
4590.0	50.9	-9.5	41.4	54.0	-12.6
5508.0	48.2	-8.4	39.8	54.0	-14.2
6426.0	30.6	-6.0	24.6	54.0	-29.4
7344.0	48.6	-6.3	42.3	54.0	-11.7
8262.0	30.4	-0.6	29.8	54.0	-24.2
9180.0	30.4	-2.2	28.2	54.0	-25.8

**Table 8-10: Radiated Emissions Spurious/Harmonics – 924 MHz – Peak Detector**

Emission Frequency (MHz)	Analyzer Reading (dBuV)	Site Correction Factor (dB/m)	Emission Level (dBuV/m)	Limit (dBuV/m)	Margin (dB)
1848.0	62.7	-11.3	51.4	74.0	-22.6
2772.0	59.2	-13.2	46.0	74.0	-28.0
3696.0	61.1	-14.1	47.0	74.0	-27.0
4620.0	53.0	-9.5	43.5	74.0	-30.5
5544.0	63.1	-8.4	54.7	74.0	-19.3
6468.0	45.7	-6.0	39.7	74.0	-34.3
7392.0	55.1	-6.3	48.8	74.0	-25.2
8316.0	40.8	-0.6	40.2	74.0	-33.8
9240.0	42.3	-2.2	40.1	74.0	-33.9

**Table 8-11: Radiated Emissions Spurious/Harmonics – 924 MHz – Average Detector**

Emission Frequency (MHz)	Analyzer Reading (dBuV)	Site Correction Factor (dB/m)	Emission Level (dBuV/m)	Limit (dBuV/m)	Margin (dB)
1848.0	61.2	-11.3	49.9	54.0	-4.1
2772.0	57.8	-13.2	44.6	54.0	-9.4
3696.0	60.1	-14.1	46.0	54.0	-8.0
4620.0	46.1	-9.5	36.6	54.0	-17.4
5544.0	56.5	-8.4	48.1	54.0	-5.9
6468.0	33.0	-6.0	27.0	54.0	-27.0
7392.0	48.7	-6.3	42.4	54.0	-11.6
8316.0	31.0	-0.6	30.4	54.0	-23.6
9240.0	33.0	-2.2	30.8	54.0	-23.2

Measurement uncertainty: Measurement uncertainties shown for these tests are expanded uncertainties expressed at 95% confidence level using a coverage factor  $k = 2$ . Measurement uncertainty:  $\pm 4.6$  dB

Radiated emissions were investigated with the LE910B1-NA and LE910-SVL LTE modules collocated and transmitting simultaneously with the Bluetooth, Wi-Fi, Z-Wave and Bolt transceivers. No non-compliant emissions were found; per FCC guidance, no data is being reported.

**Table 8-12: Radiated Emissions - Collocation Frequencies Tested**

Z-Wave (MHz)	Bolt (MHz)	NA Cellular (MHz)	SVL Cellular (MHz)	Bluetooth (MHz)
908.4	924.0	-	786.3	2402.0
916.0	912.0	-	1754.3	2480.0
908.4	924.0	699.7	-	2402.0
916.0	918.0	824.7	-	2440.0
916.0	912.0	1754.3	-	2480.0
916.0	918.0	1909.3	-	2402.0
Z-Wave (MHz)	Bolt (MHz)	NA Cellular (MHz)	SVL Cellular (MHz)	Wi-Fi (MHz)
908.4	912.0	699.7	-	2412.0
916.0	918.0	824.7	-	2437.0
916.0	924.0	1754.3	-	5180.0
916.0	918.0	1909.3	-	5785.0
908.4	924.0	-	786.3	2412.0
916.0	924.0	-	1754.3	5180.0

**Test Personnel:**

Khue Do Test Engineer	 Signature	June 26- July 2, 2019 Dates of Test
--------------------------	--	--

## 9 AC Conducted Emissions - FCC 15.207; ISED RSS-Gen 7.2: AC Power Line Conducted Limits

### 9.1 Site and Test Description

The power line conducted emissions measurements were performed in a Series 81 type shielded enclosure manufactured by Rayproof. The EUT was assembled on a wooden table 80 centimeters high. Power was fed to the EUT through a 50-ohm/50 microhenry Line Impedance Stabilization Network (LISN). The EUT LISN was fed power through an A.C. filter box on the outside of the shielded enclosure. The filter box and EUT LISN housing are bonded to the ground plane of the shielded enclosure. A second LISN, the peripheral LISN, provides isolation for the EUT test peripherals. This peripheral LISN was also fed A.C. power. A metal power outlet box, which is bonded to the ground plane and electrically connected to the peripheral LISN, powers a DC power supply which powers the EUT.

The spectrum analyzer was connected to the AC line through an isolation transformer. The 50-ohm output of the EUT LISN was connected to the spectrum analyzer input through a Solar 100 kHz high-pass filter. The filter is used to prevent overload of the spectrum analyzer from noise below 100 kHz. Conducted emission levels were measured on each current-carrying line with the spectrum analyzer operating in the CISPR quasi-peak mode (or peak mode if applicable).

The analyzer's 6 dB bandwidth was set to 9 kHz. Video filter less than 10 times the resolution bandwidth is not used. Average measurements are performed in linear mode using a 10 kHz resolution bandwidth, a 1 Hz video bandwidth, and by increasing the sweep time in order to obtain a calibrated measurement. The emission spectrum was scanned from 150 kHz to 30 MHz. The highest emission amplitudes relative to the appropriate limits were measured and have been recorded.

### 9.2 Test Limits

Line-Conducted Emissions		
Limit (dBµV)		
Frequency (MHz)	Quasi-Peak	Average
0.15 to 0.50	66 to 56	56 to 46
0.50 to 5.00	56	46
5.00 to 30.00	60	50

Table 9-1: Conducted Emissions Test Equipment

RTL Asset #	Manufacturer	Model	Part Type	Serial Number	Calibration Due Date
901583	Agilent Technologies	N9010A	EXA Signal Analyzer (10 Hz-26.5 GHz)	MY51250846	4/26/21
901083	AFJ International	LS16	16A LISN (110 V)	16010020080	2/13/21
N/A	Quantum Change	Tile!	Test Software	4.0.A.8	N/A
901699	Hewlett Packard	E3610A	DC Power Supply	KR72917306	N/A

### 9.3 Conducted Emissions Test Data

Plot 9-1: Conducted Emissions – Phase - BOLT Power Supply #2

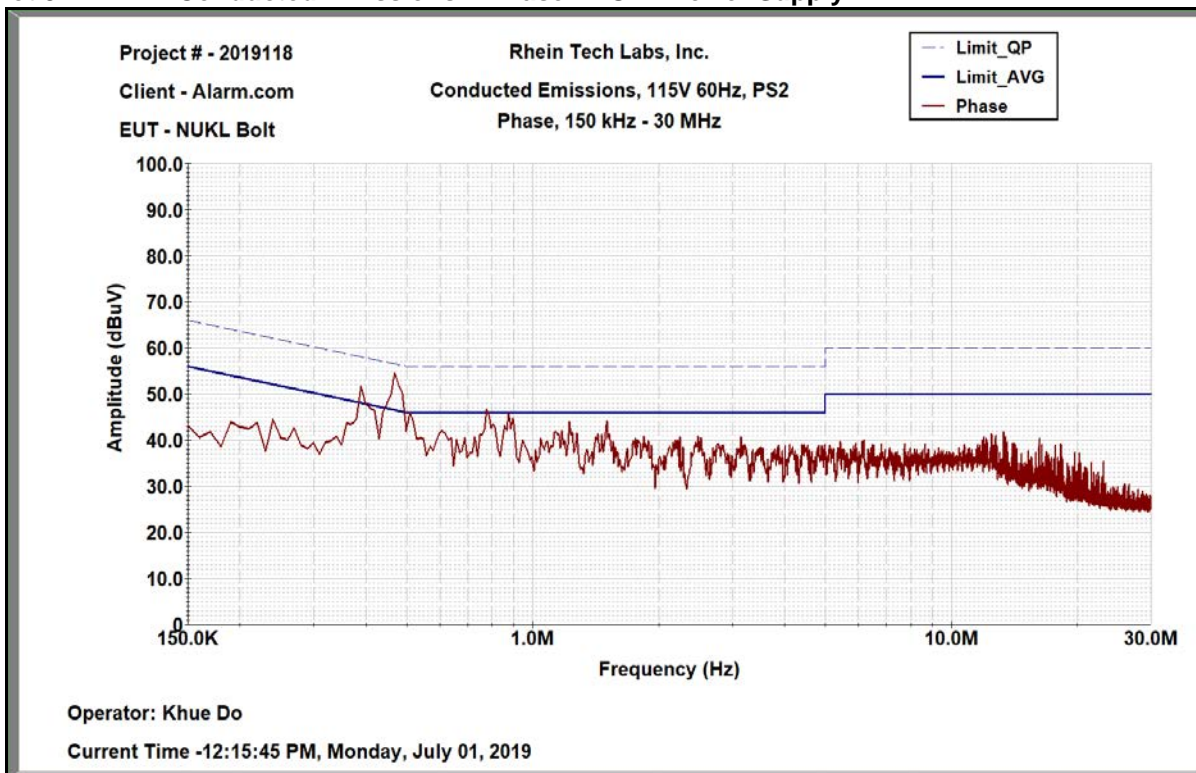
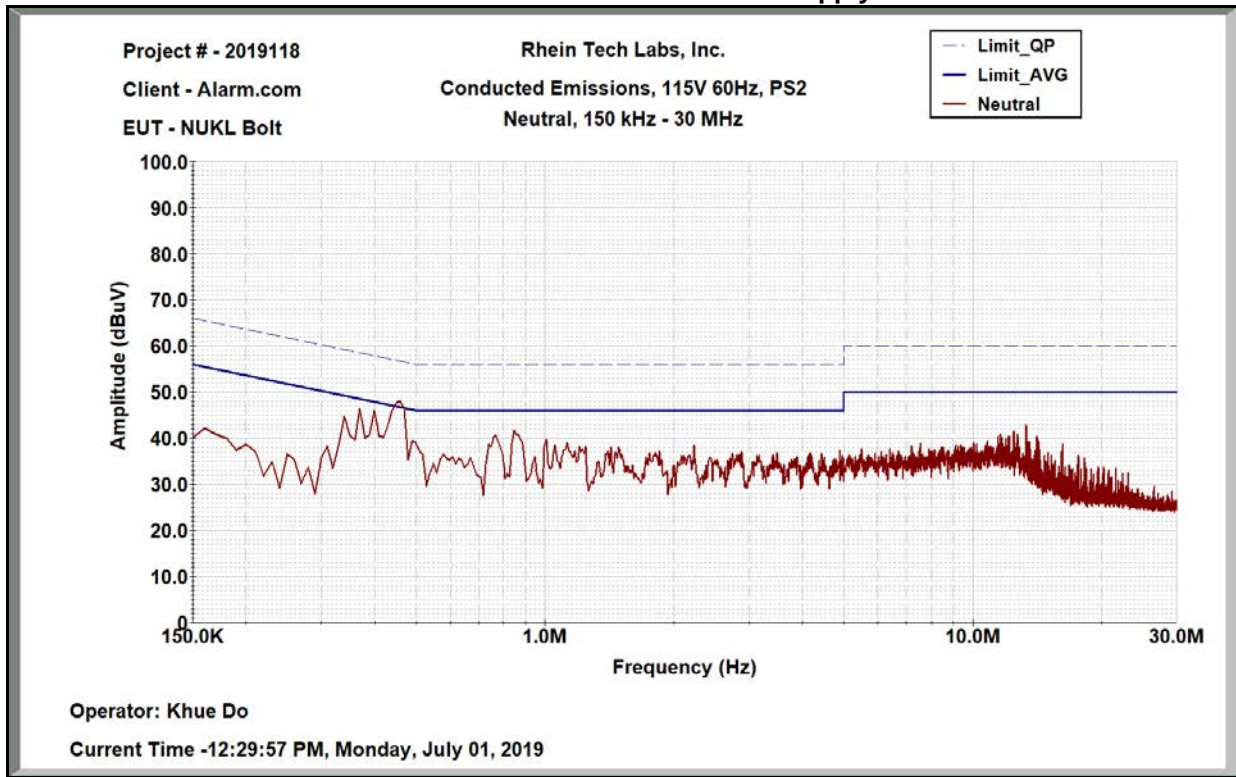

Table 9-2: Conducted Emissions – Phase – BOLT Power Supply #2

Frequency (MHz)	Detector	Level (dB $\mu$ V)	Site Correction Factor (dB)	Corrected Level (dB $\mu$ V)	Limit (dB $\mu$ V)	Margin (dB)	Pass/Fail
0.388	QPK	48.1	0.1	48.2	56.0	-7.8	Pass
0.388	AVG	39.2	0.1	39.3	46.0	-6.7	Pass
0.472	QPK	50.7	0.2	50.9	56.0	-5.1	Pass
0.472	AVG	41.2	0.2	41.4	46.0	-4.6	Pass
0.778	QPK	42.8	0.2	43.0	56.0	-13.0	Pass
0.778	AVG	32.5	0.2	32.7	46.0	-13.3	Pass
0.873	QPK	41.7	0.2	41.9	56.0	-14.1	Pass
0.873	AVG	31.9	0.2	32.1	46.0	-13.9	Pass

**Plot 9-2: Conducted Emissions – Neutral - BOLT Power Supply #2**



**Table 9-3: Conducted Emissions – Neutral – BOLT Power Supply #2**

Frequency (MHz)	Detector	Level (dB $\mu$ V)	Site Correction Factor (dB)	Corrected Level (dB $\mu$ V)	Limit (dB $\mu$ V)	Margin (dB)	Pass/Fail
0.476	QPK	45.6	0.2	45.8	56.0	-10.2	Pass
0.476	AVG	33.2	0.2	33.4	46.0	-12.6	Pass

**Plot 9-3: Conducted Emissions – Phase – NA LTE; Power Supply #1**

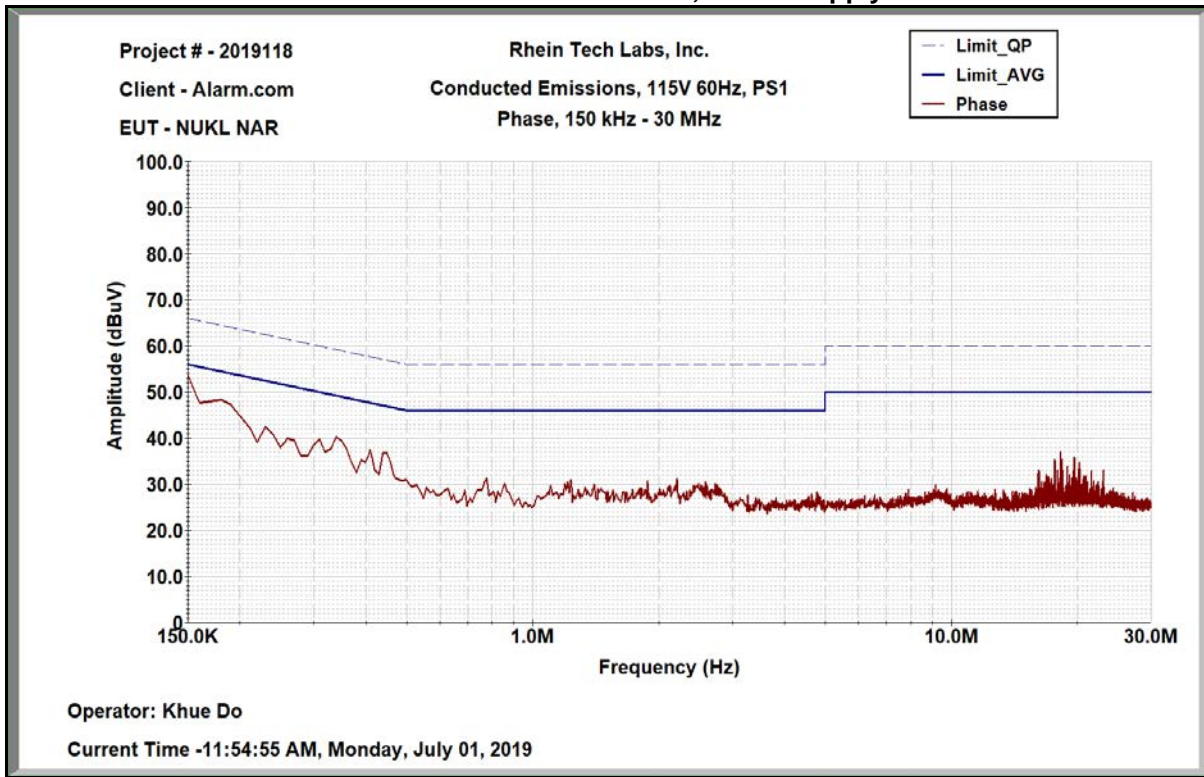

**Table 9-4: Conducted Emissions – Phase – NA LTE; Power Supply #1**

Frequency (MHz)	Detector	Level (dB $\mu$ V)	Site Correction Factor (dB)	Corrected Level (dB $\mu$ V)	Limit (dB $\mu$ V)	Margin (dB)	Pass/Fail
0.150	QPK	51.1	0.1	51.2	56.0	-4.8	Pass
0.150	AVG	40.4	0.1	40.5	46.0	-5.5	Pass

**Plot 9-4: Conducted Emissions – Neutral – NA LTE; Power Supply #1**

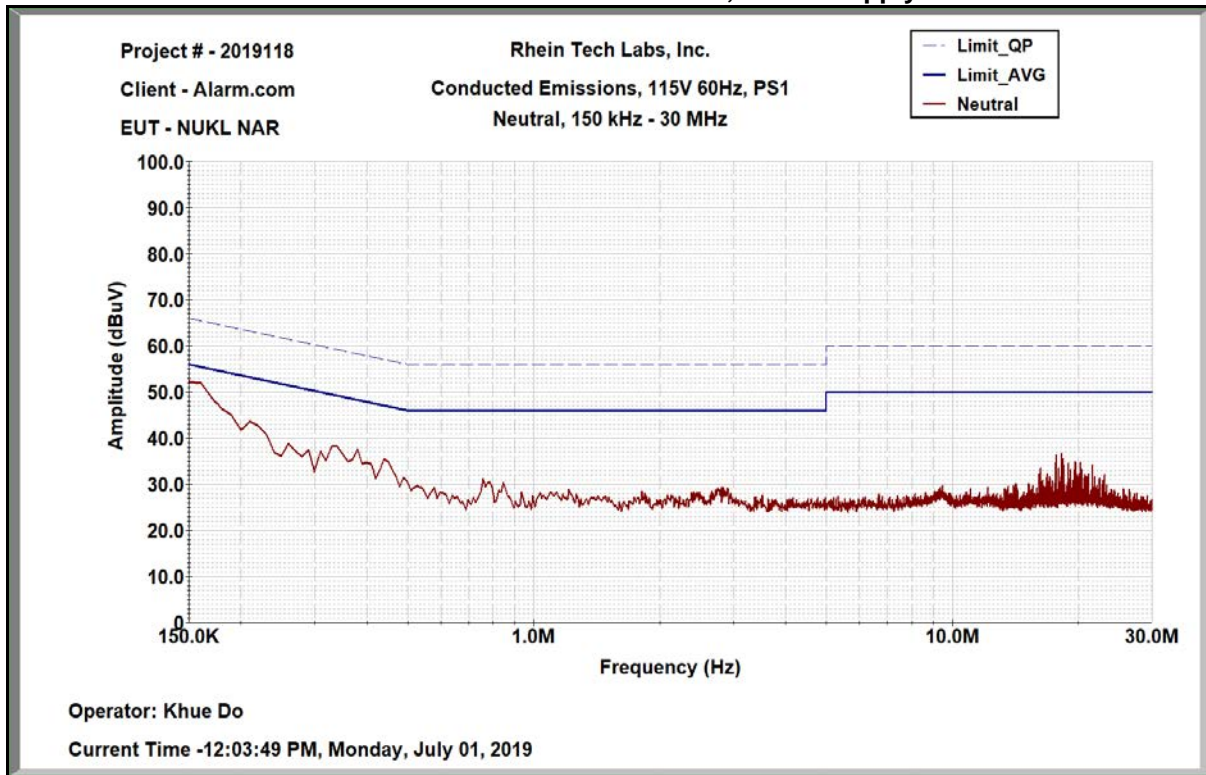
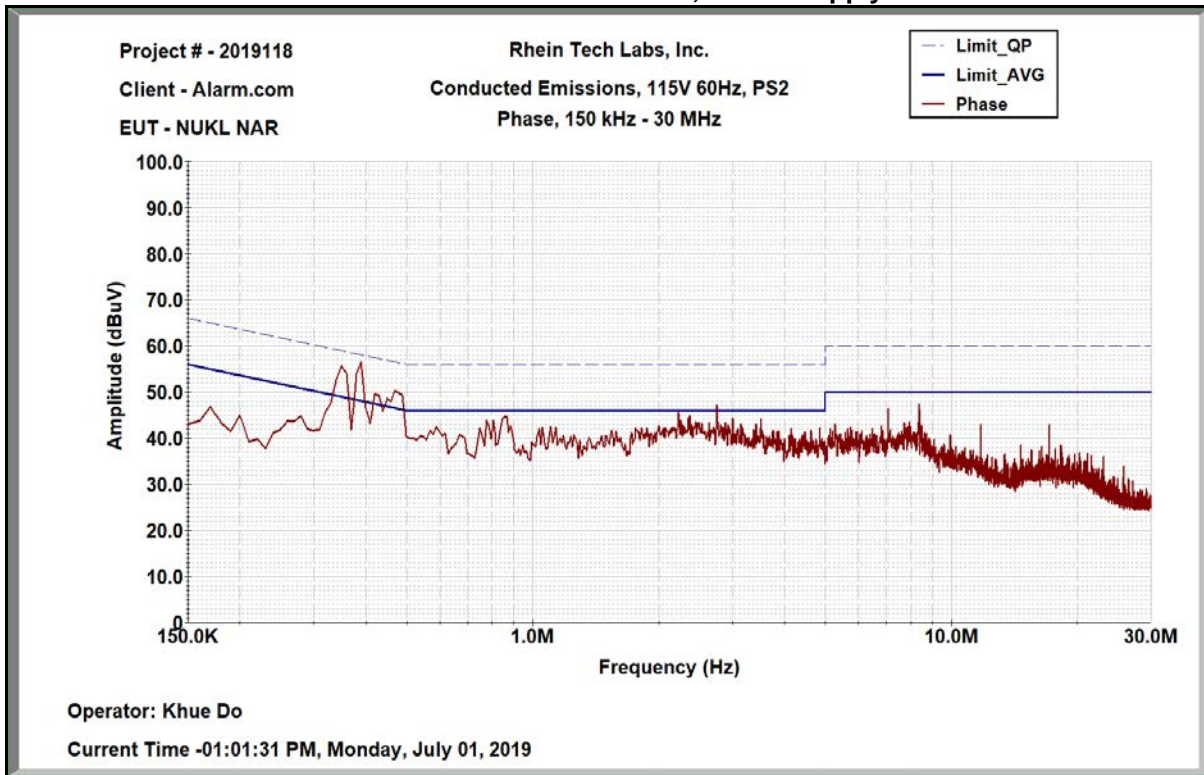

**Table 9-5: Conducted Emissions – Neutral – NA LTE; Power Supply #1**

Frequency (MHz)	Detector	Level (dB $\mu$ V)	Site Correction Factor (dB)	Corrected Level (dB $\mu$ V)	Limit (dB $\mu$ V)	Margin (dB)	Pass/Fail
0.150	QPK	49.5	0.1	49.6	56.0	-6.4	Pass
0.150	AVG	35.8	0.1	35.9	46.0	-10.1	Pass



**Plot 9-5: Conducted Emissions – Phase – NA LTE; Power Supply #2**



**Table 9-6: Conducted Emissions – Phase – NA LTE; Power Supply #2**

Frequency (MHz)	Detector	Level (dB $\mu$ V)	Site Correction Factor (dB)	Corrected Level (dB $\mu$ V)	Limit (dB $\mu$ V)	Margin (dB)	Pass/Fail
0.353	QPK	52.9	0.1	53.0	58.9	-5.9	Pass
0.353	AVG	46.3	0.1	46.4	48.9	-2.5	Pass
0.388	QPK	54.1	0.1	54.2	58.1	-3.9	Pass
0.388	AVG	46.8	0.1	46.9	48.1	-1.2	Pass
0.451	QPK	45.7	0.2	45.9	56.0	-10.1	Pass
0.451	AVG	36.2	0.2	36.4	46.0	-9.6	Pass
2.468	AVG	41.1	0.6	41.7	56.0	-14.3	Pass
2.468	AVG	33.8	0.6	34.4	46.0	-11.6	Pass

**Plot 9-6: Conducted Emissions – Neutral – NA LTE; Power Supply #2**

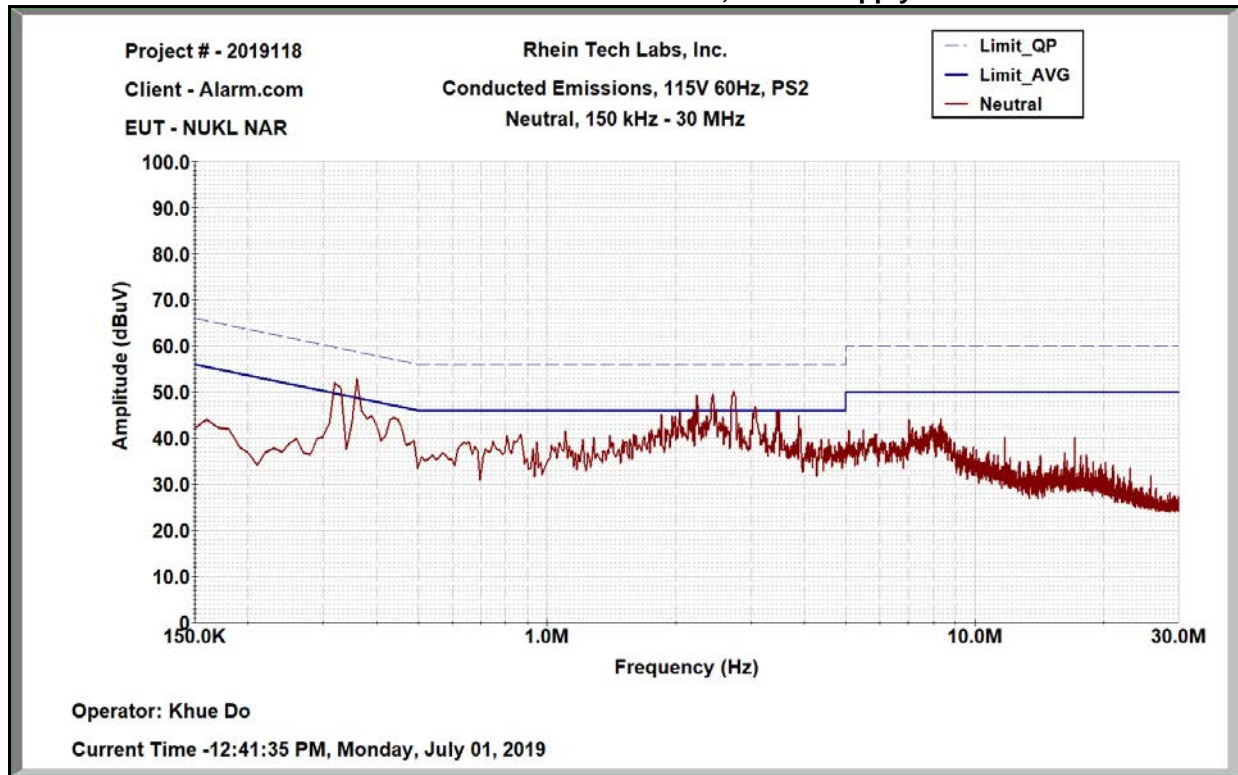

**Table 9-7: Conducted Emissions – Neutral – NA LTE; Power Supply #2**

Frequency (MHz)	Detector	Level (dB $\mu$ V)	Site Correction Factor (dB)	Corrected Level (dB $\mu$ V)	Limit (dB $\mu$ V)	Margin (dB)	Pass/Fail
0.325	QPK	38.5	0.1	38.6	56.0	-17.4	Pass
0.325	AVG	31.7	0.1	31.8	46.0	-14.2	Pass
0.389	QPK	51.1	0.1	51.2	56.0	-4.8	Pass
0.389	AVG	43.0	0.1	43.1	46.0	-2.9	Pass
2.440	QPK	40.5	0.6	41.1	56.0	-14.9	Pass
2.440	AVG	28.5	0.6	29.1	46.0	-16.9	Pass
2.600	QPK	41.9	0.6	42.5	56.0	-13.5	Pass
2.600	AVG	28.8	0.6	29.4	46.0	-16.6	Pass
3.186	QPK	39.4	0.7	40.1	56.0	-15.9	Pass
3.186	AVG	28.4	0.7	29.1	46.0	-16.9	Pass

**Plot 9-7: Conducted Emissions – Phase - SVL LTE; Power Supply #2**

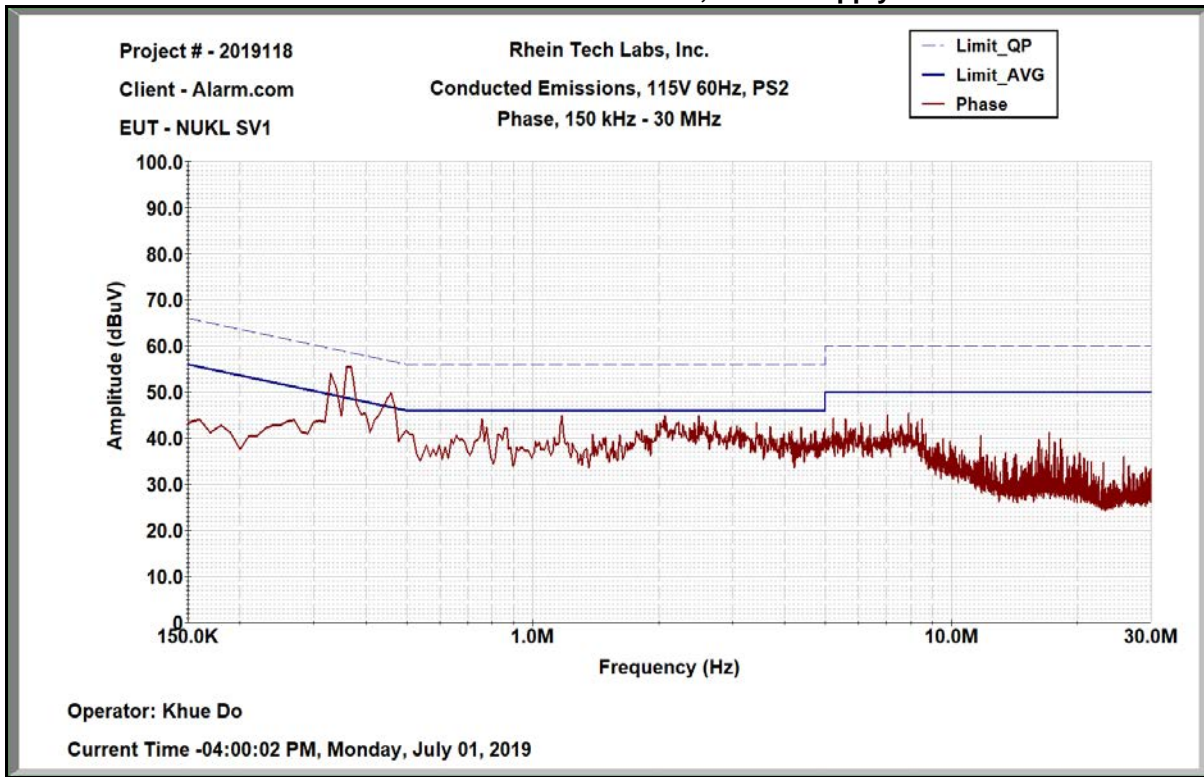

**Table 9-8: Conducted Emissions – Phase - SVL LTE; Power Supply #2**

Frequency (MHz)	Detector	Level (dB $\mu$ V)	Site Correction Factor (dB)	Corrected Level (dB $\mu$ V)	Limit (dB $\mu$ V)	Margin (dB)	Pass/Fail
0.355	QPK	52.1	0.1	52.2	58.8	-6.6	Pass
0.355	AVG	44.7	0.1	44.8	48.8	-4.0	Pass
0.387	QPK	54.3	0.1	54.4	58.1	-3.7	Pass
0.387	AVG	47.0	0.1	47.1	48.1	-1.0	Pass
0.474	QPK	46.6	0.1	46.7	56.4	-9.7	Pass
0.474	AVG	37.9	0.1	38.0	46.4	-8.4	Pass

**Plot 9-8: Conducted Emissions – Neutral - SVL LTE; Power Supply #2**

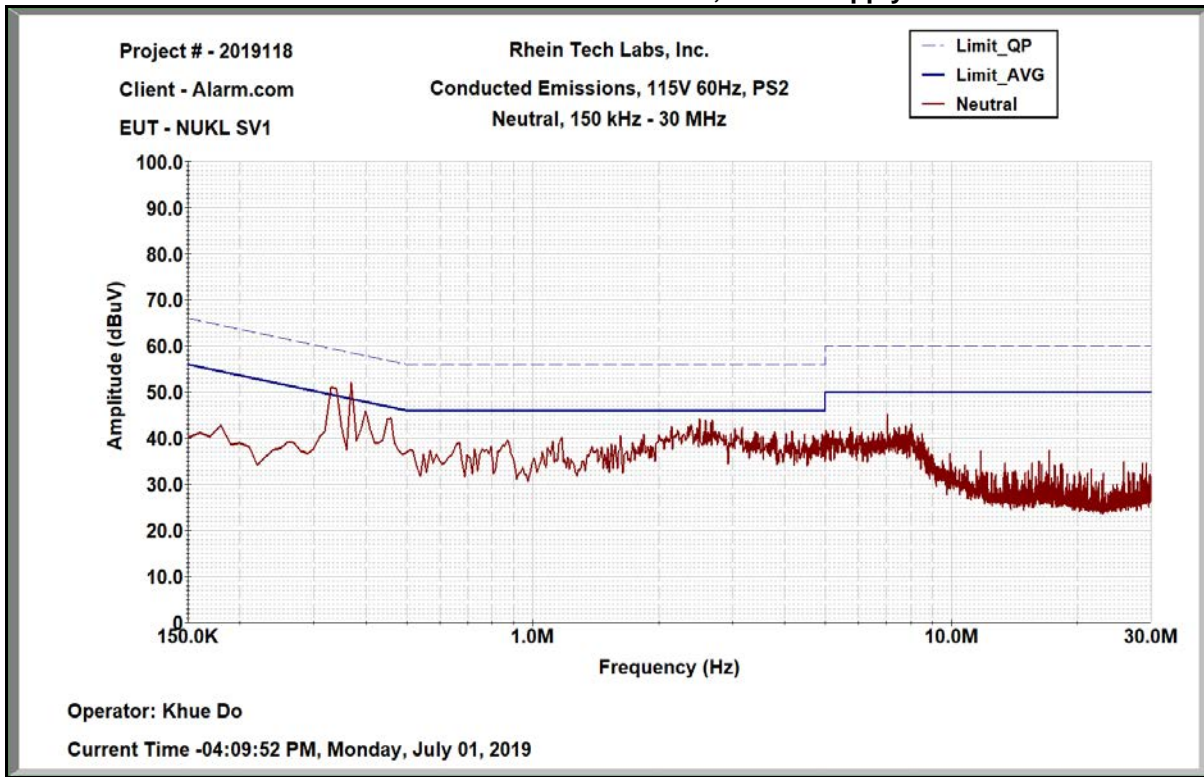

**Table 9-9: Conducted Emissions – Neutral – SVL LTE; Power Supply #2**

Frequency (MHz)	Detector	Level (dB $\mu$ V)	Site Correction Factor (dB)	Corrected Level (dB $\mu$ V)	Limit (dB $\mu$ V)	Margin (dB)	Pass/Fail
0.360	QPK	50.5	0.1	50.6	58.7	-8.1	Pass
0.360	AVG	43.1	0.1	43.2	48.7	-5.5	Pass
0.390	QPK	51.1	0.1	51.2	58.1	-6.9	Pass
0.390	AVG	42.5	0.1	42.6	48.1	-5.5	Pass

**Plot 9-9: Conducted Emissions – Phase - SVL LTE; Power Supply #1**

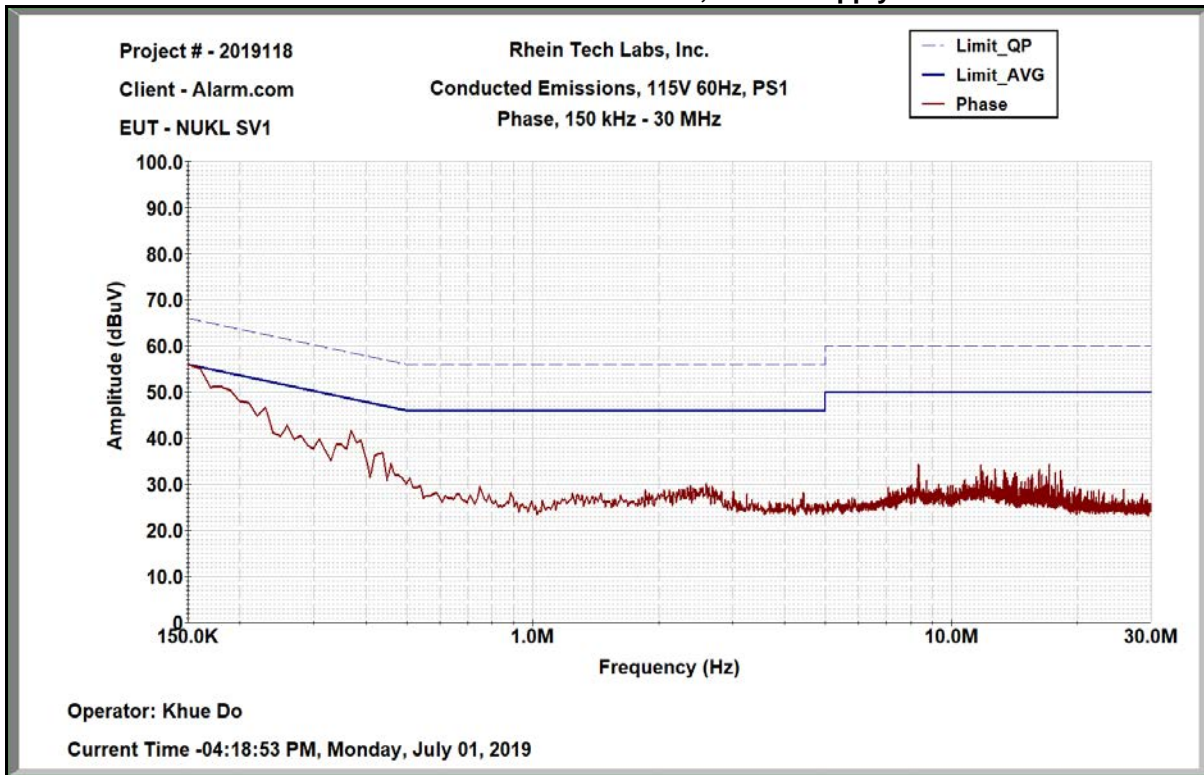

**Table 9-10: Conducted Emissions – Phase – SVL LTE; Power Supply #1**

Frequency (MHz)	Detector	Level (dB $\mu$ V)	Site Correction Factor (dB)	Corrected Level (dB $\mu$ V)	Limit (dB $\mu$ V)	Margin (dB)	Pass/Fail
0.150	QPK	53.3	0.1	53.4	66.0	-12.6	Pass
0.150	AVG	39.0	0.1	39.1	56.0	-16.9	Pass

**Plot 9-10: Conducted Emissions – Neutral - SVL LTE; Power Supply #1**

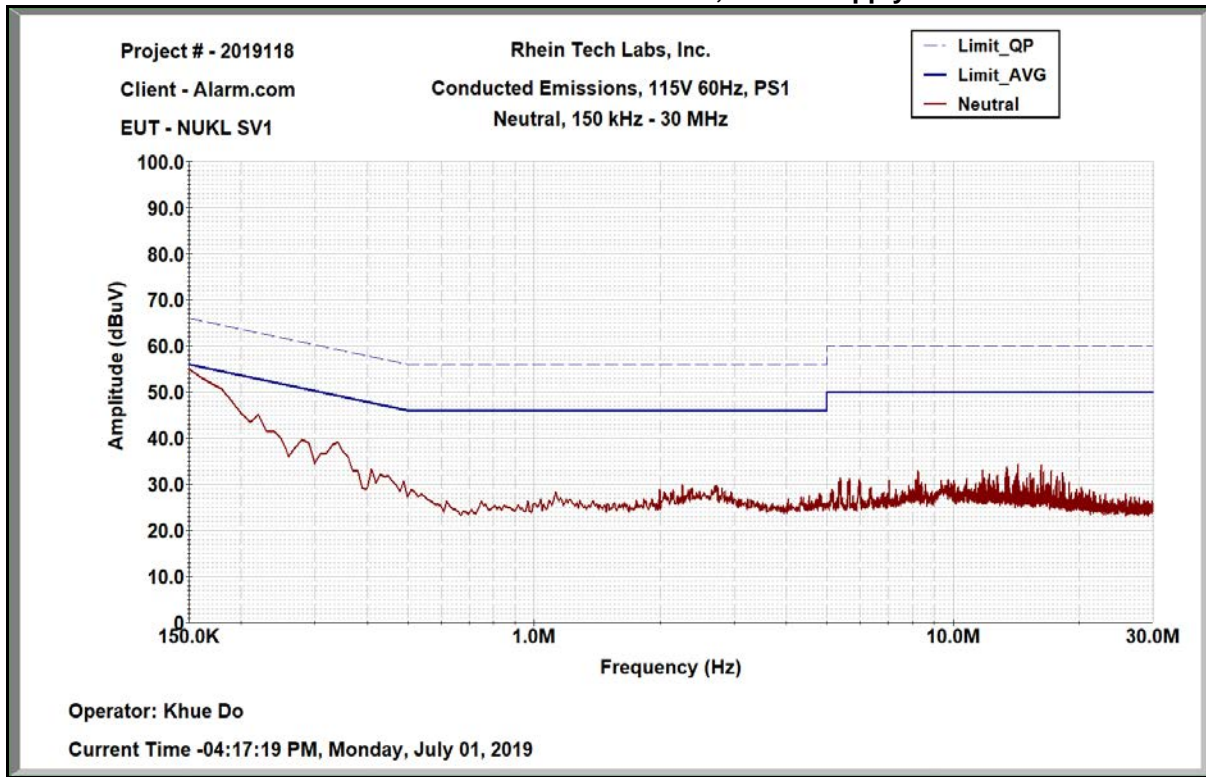

Measurement uncertainty: Measurement uncertainties shown for these tests are expanded uncertainties expressed at 95% confidence level using a coverage factor  $k = 2$ . Measurement uncertainty:  $\pm 3.6$  dB.

**Test Personnel:**

Khue Do		July 1, 2019
Test Engineer	Signature	Date of Test

**10 Conclusion**

The data in this measurement report shows that the EUT as tested, Alarm.com Model ADC-NK-200T-A, FCC ID: YL6-143NK200T, IC: 9111A-143NK200T, complies with the applicable requirements of Parts 2 and 15 of the FCC Rules and Regulations and ISED RSS-247 and RSS-Gen.