



Engineering Solutions & Electromagnetic Compatibility Services

**Certification Application Report
FCC Part 15.249 & ISED RSS-210**

Test Lab: Rhein Tech Laboratories, Inc. 360 Herndon Parkway Suite 1400 Herndon, VA 20170 E-Mail: atcbinfo@rheintech.com		Applicant: Alarm.com 8281 Greensboro Drive Suite 100 Tysons, VA 22102	
Tel: 703-689-0368 Fax: 703-689-2056 www.rheintech.com		Tel: 703-584-7319	
FCC ID	YL6-143NK200T	Test Report Date	August 1, 2019
IC	9111A-143NK200T	RTL Work Order #	2019118
Model #/HVIN	ADC-NK-200T-A	RTL Quote #	QRRTL19-118A
American National Standard Institute	ANSI C63.10-2013: American National Standard of Procedures for Compliance Testing of Unlicensed Wireless Devices		
FCC Classification	DXT – Part 15 Low Power Transceiver		
FCC Rule Part(s)/ Guidance	15.249: Operation within the bands 902-928 MHz, 2400-2483.5 MHz, 5725-5875 MHz, and 24.0-24.25 GHz (2018)		
ISED Canada	RSS-210 Issue 9: Licence-Exempt Radio Apparatus: Category I Equipment RSS-Gen Issue 5: General Requirements for Compliance of Radio Apparatus		
Frequency Range (MHz)	Output Power (W)	Frequency Tolerance	Emission Designator
908.4	N/A	N/A	112KF1D
916.0	N/A	N/A	115KF1D

I, the undersigned, hereby declare that the equipment tested and referenced in this report conforms to the identified standard(s) as described in this test report. No modifications were made to the equipment during testing in order to achieve compliance with these standards. Furthermore, there was no deviation from, additions to, or exclusions from, the applicable parts of FCC Part 2, FCC Part 15, RSS-210, RSS-Gen, and ANSI C63.10.

Signature: 

Date: August 1, 2019

Typed/Printed Name: Desmond A. Fraser

Position: President

*This report may not be reproduced, except in full, without the written approval of Rhein Tech Laboratories, Inc. and Alarm.com. The test results relate only to the item(s) tested.
This replaces DRAFT R0.4.*

These test(s) are accredited under Rhein Tech Laboratories, Inc. ISO/IEC 17025 accreditation issued by ANAB. Refer to certificate and scope of accreditation AT-1445.

Table of Contents

1	General Information.....	5
1.1	Scope	5
1.2	Description of EUT	5
1.3	Test Facility.....	5
1.4	Related Submittal(s)/Grant(s)	5
1.5	Modifications	5
2	Test Information	6
2.1	Description of Test Modes.....	6
2.2	Exercising the EUT.....	6
2.3	Test Result Summary.....	6
2.4	Test System Details	6
2.5	Configuration of Tested System.....	7
3	Radiated Emissions – FCC 15.209, 15.249(a); ISED RSS-210 B.10; RSS-Gen Issue 5 8.9/8.10.....	8
3.1	Limits of Radiated Emissions Measurement.....	8
3.1.1	Radiated Emissions Measurement Test Procedure.....	8
3.2	Radiated Emissions Test Results	9
3.3	Radiated Emissions Harmonics/Spurious Test Data	10
4	AC Conducted Emissions - FCC 15.207; ISED RSS-Gen 7.2: AC Power Line Conducted Limits.....	12
4.1	Site and Test Description.....	12
4.2	Test Limits.....	12
4.3	Conducted Emissions Test Data.....	13
5	99% Bandwidth – ISED RSS-Gen Issue 5 6.6.....	21
5.1	99% Bandwidth Test Procedure	21
5.2	Bandwidth Test Data	21
6	Conclusion	23

Figure Index

Figure 2-1:	Configuration of System Under Test	7
-------------	--	---

Table Index

Table 2-1:	Channels Tested	6
Table 2-2:	Test Result Summary	6
Table 2-3:	Equipment Under Test	6
Table 2-4:	Auxiliary Equipment	7
Table 3-1:	Radiated Emissions Test Equipment	9
Table 3-2:	Radiated Emissions Test Data – Quasi-Peak	9
Table 3-3:	Radiated Emissions Harmonics/Spurious – 908.4 MHz; Peak	10
Table 3-4:	Radiated Emissions Harmonics/Spurious – 908.4 MHz; Average	10
Table 3-5:	Radiated Emissions Harmonics/Spurious – 916.0 MHz; Peak	11
Table 3-6:	Radiated Emissions Harmonics/Spurious – 916.0 MHz; Average	11
Table 4-1:	Conducted Emissions Test Equipment	12
Table 4-2:	Conducted Emissions – Phase – NA LTE; Power Supply #1	13
Table 4-3:	Conducted Emissions – Neutral – NA LTE; Power Supply #1	14
Table 4-4:	Conducted Emissions – Phase – NA LTE; Power Supply #2	15
Table 4-5:	Conducted Emissions – Neutral – NA LTE; Power Supply #2	16
Table 4-6:	Conducted Emissions – Phase - SVL LTE; Power Supply #2	17
Table 4-7:	Conducted Emissions – Neutral – SVL LTE; Power Supply #2	18
Table 4-8:	Conducted Emissions – Phase – SVL LTE; Power Supply #1	19
Table 5-1:	99% Bandwidth Test Equipment	21
Table 5-2:	99% Bandwidth Test Data	21

Plot Index

Plot 4-1:	Conducted Emissions – Phase – NA LTE; Power Supply #1	13
Plot 4-2:	Conducted Emissions – Neutral – NA LTE; Power Supply #1	14
Plot 4-3:	Conducted Emissions – Phase – NA LTE; Power Supply #2	15
Plot 4-4:	Conducted Emissions – Neutral – NA LTE; Power Supply #2	16
Plot 4-5:	Conducted Emissions – Phase - SVL LTE; Power Supply #2	17
Plot 4-6:	Conducted Emissions – Neutral - SVL LTE; Power Supply #2	18
Plot 4-7:	Conducted Emissions – Phase - SVL LTE; Power Supply #1	19
Plot 4-8:	Conducted Emissions – Neutral - SVL LTE; Power Supply #1	20
Plot 5-1:	99% Bandwidth – 908.4 MHz	22
Plot 5-2:	99% Bandwidth - 916.0 MHz	23

Appendix Index

Appendix A:	Test Photographs	24
-------------	------------------------	----

Photograph Index

Photograph 1:	Radiated Emissions Testing – Front View (Digital Emissions, <1 GHz).....	24
Photograph 2:	Radiated Emissions Testing – Back View (Digital Emissions, <1 GHz)	25
Photograph 3:	Radiated Emissions Testing – Front View (Spurious Emissions, >1 GHz).....	26
Photograph 4:	Radiated Emissions Testing – Back View (Spurious Emissions, >1 GHz)	27
Photograph 5:	Conducted AC Emissions Testing – Front View.....	28
Photograph 7:	Conducted AC Emissions Testing – Rear View	29

1 General Information

1.1 Scope

This is an original FCC and ISED certification application request.

Applicable Standards:

- FCC Part 15.249: Operation within the bands 902-928 MHz, 2400-2483.5 MHz, 5725-5875 MHz, and 24.0-24.25 GHz
- ISED RSS-210 Issue 9: Licence-Exempt Radio Apparatus: Category I Equipment
- ISED RSS-Gen Issue 5: General Requirements for Compliance of Radio Apparatus

1.2 Description of EUT

Equipment Under Test	Multi-transceiver communication link
Model	ADC-NK-200T-A
Power Supply	5 VDC
Modulation Type	FSK
Frequency Range	908.4 and 916.0 MHz
Antenna Type	Chip antenna

1.3 Test Facility

The open area test site and conducted measurement facility used to collect the radiated data is located at 360 Herndon Parkway, Suite 1400, Herndon, Virginia 20170. This site has been fully described in a report and approved by the Federal Communications Commission to perform AC line conducted and radiated emissions testing.

1.4 Related Submittal(s)/Grant(s)

This is an original certification application for Alarm.com Model ADC-NK-200T-A, FCC ID: YL6-143NK200T, IC: 9111A-143NK200T.

1.5 Modifications

None.

2 Test Information

2.1 Description of Test Modes

In accordance with FCC 15.31(m), the following frequencies were tested.

Table 2-1: Channels Tested

Frequency (MHz)
908.4
916.0

2.2 Exercising the EUT

The EUT was programmed for continuous transmission at 908.4 and 916.0 MHz. The EUT was tested in all three orthogonal planes in order to determine worst-case emissions. The carrier was also checked to verify that information was being transmitted. There were no deviations from the test standard(s) and/or methods. The test results reported relate only to the item tested.

2.3 Test Result Summary

Table 2-2: Test Result Summary

Test	FCC Reference	ISED Reference	Pass/Fail or N/A
AC Power Conducted Emissions	15.207	RSS-Gen 8.8	Pass
Radiated Emissions	15.209	RSS-Gen 6.13/7.1	Pass
Field Strength of Fundamental and Harmonics	15.249(a)	RSS-210 Issue 9 B.10	Pass
99% Bandwidth	N/A	RSS-Gen 6.7	Pass

2.4 Test System Details

The test samples were received on June 26, 2019. The FCC identifiers for all applicable equipment, plus descriptions of all cables used in the tested system, are identified in the following table.

Table 2-3: Equipment Under Test

Part	Manufacturer	Model	Serial Number	FCC ID	Cable Description	RTL Bar Code
Transceiver	Alarm.com	ADC-NK-200T-A	NA T06611549	YL6-143NK200T	N/A	23286
Transceiver	Alarm.com	ADC-NK-200T-A	SVL T00611559	YL6-143NK200T	N/A	23288

Table 2-4: Auxiliary Equipment

Part	Manufacturer	Model	Serial Number	Cable Description	RTL Bar Code
5V DC AC Adapter	Alarm.com	YS16F-0502000	N/A	1.5m unshielded	23290
5V DC AC Adapter	Alarm.com	YS12-050200U	N/A	1.4m unshielded	23287

2.5 Configuration of Tested System

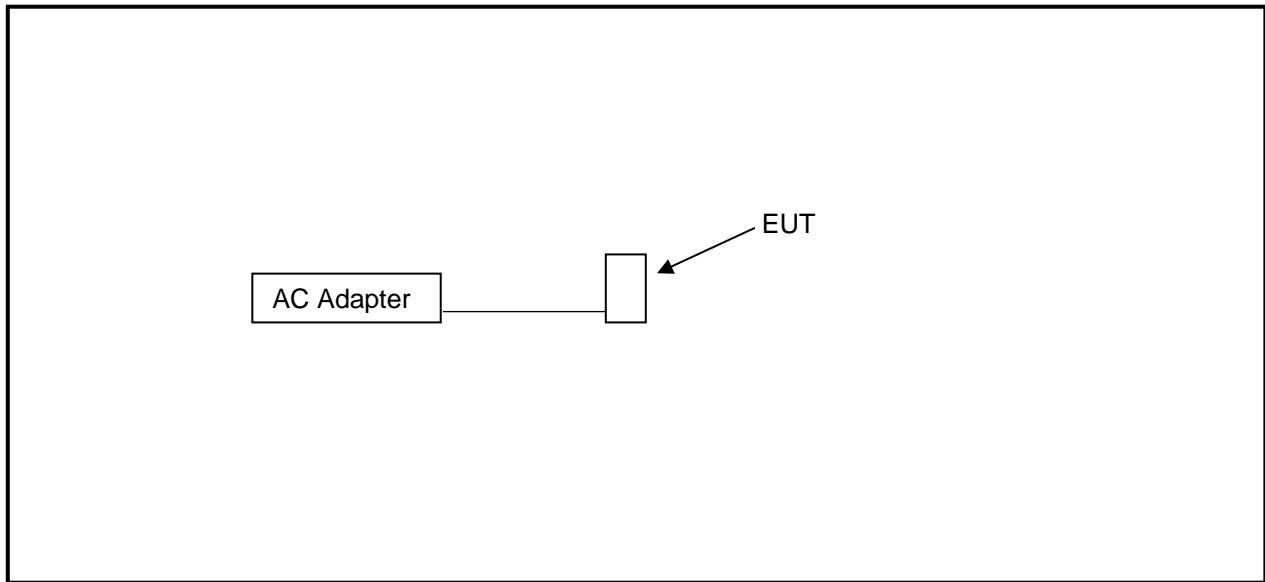

Figure 2-1: Configuration of System Under Test

3 Radiated Emissions – FCC 15.209, 15.249(a); ISED RSS-210 B.10; RSS-Gen Issue 5 8.9/8.10

3.1 Limits of Radiated Emissions Measurement

Frequency (MHz)	Field Strength (uV/m)	Measurement Distance (m)
0.009-0.490	2400/f (kHz)	300
0.490-1.705	2400/f (kHz)	30
1.705-30.0	30	30
30-88	100	3
88-216	150	3
216-960	200	3
Above 960	500	3

As shown in 15.35(b), for frequencies above 1000 MHz, the field strength limits are based on average detector, however, the peak field strength of any emission shall not exceed the maximum permitted average limits specified above by more than 20 dB under any circumstances of modulation.

3.1.1 Radiated Emissions Measurement Test Procedure

Before final measurements of radiated emissions were made on the open-field three/ten meter range, the EUT was scanned indoors at one and three meter distances. This was done in order to determine its emissions spectrum signature. The physical arrangement of the test system and associated cabling was varied in order to determine the effect on the EUT's emissions in amplitude, direction and frequency. This process was repeated during final radiated emissions measurements on the open-field range, at each frequency, in order to ensure that maximum emission amplitudes were attained.

Final radiated emissions measurements were made on the three/ten-meter, open-field test site. The EUT was placed on a nonconductive turntable 0.8 m (< 1 GHz) / 1.5 m (> 1 GHz) above the ground plane. The spectrum was examined from 9 kHz to the 10th harmonic of the highest fundamental transmitter frequency (9.16 GHz).

At each frequency, the EUT was rotated 360°, and the antenna was raised and lowered from 1 to 4 meters in order to determine the emission's maximum level. Measurements were taken using both horizontal and vertical antenna polarizations. For frequencies between 30 and 1000 MHz, the spectrum analyzer's 6 dB bandwidth was set to 120 kHz, and the analyzer was operated in the CISPR quasi-peak detection mode. For emissions above 1000 MHz, emissions are measured using the average detector function with a minimum resolution bandwidth of 1 MHz. No video filter less than 10 times the resolution bandwidth was used. The highest emission amplitudes relative to the appropriate limit were measured and recorded in this report.

Table 3-1: Radiated Emissions Test Equipment

RTL Asset #	Manufacturer	Model	Part Type	Serial Number	Calibration Due Date
900791	Chase	CBL6112	Antenna (30 MHz–2 GHz)	2099	10/4/20
900772	EMCO	3161-02	Horn Antenna (2-4 GHz)	9804-1044	5/17/21
900321	EMCO	3161-03	Horn Antenna (4-8.2 GHz)	9528-1020	5/17/21
900323	EMCO	3160-07	Horn Antenna (8.2-12.4 GHz)	9605-1024	5/17/21
901583	Agilent Technologies	N9010A	EXA Signal Analyzer (10 Hz-26.5 GHz)	MY51250846	4/26/21
901729	Insulated Wire Inc.	KPS-1503-3150-KPR	SMK RF Cables 20'	NA	8/21/19

3.2 Radiated Emissions Test Results

Table 3-2: Radiated Emissions Test Data – Quasi-Peak

Emission Frequency (MHz)	Quasi-Peak Detector Level (dBuV/m) (120 kHz RBW/ 300 kHz VBW)	Site Correction Factor (dB/m)	Quasi-Peak Corrected (dBuV/m)	Quasi-Peak Limit (dBuV/m)	Margin (dB)
908.4	51.7	42.0	93.8	94.0	-0.2
916.0	51.6	42.0	93.6	94.0	-0.4

Note: Testing performed at 3m

3.3 Radiated Emissions Harmonics/Spurious Test Data

Table 3-3: Radiated Emissions Harmonics/Spurious – 908.4 MHz; Peak

Emission Frequency (MHz)	Peak Analyzer Reading (dBuV)	Site Correction Factor (dB/m)	Peak Emission Level (dBuV/m)	Peak Limit (dBuV/m)	Peak Margin (dB)
1816.8	49.8	-12.5	37.3	74.0	-36.7
2725.2	54.0	-13.8	40.2	74.0	-33.8
3633.6	49.9	-15.8	34.1	74.0	-39.9
4542.0	46.9	-9.7	37.2	74.0	-36.8
5450.4	47.2	-8.3	38.9	74.0	-35.1
6358.8	46.9	-6.2	40.7	74.0	-33.3
7267.2	46.5	-6.5	40.0	74.0	-34.0
8175.6	49.3	-0.7	48.6	74.0	-25.4
9084.0	46.7	-1.1	45.6	74.0	-28.4

Table 3-4: Radiated Emissions Harmonics/Spurious – 908.4 MHz; Average

Emission Frequency (MHz)	Average Analyzer Reading (dBuV)	Site Correction Factor (dB/m)	Average Emission Level (dBuV/m)	Average Limit (dBuV/m)	Average Margin (dB)
1816.8	56.0	-12.5	43.5	54.0	-10.5
2725.2	51.9	-13.8	38.1	54.0	-15.9
3633.6	48.5	-15.8	32.7	54.0	-21.3
4542.0	45.3	-9.7	35.6	54.0	-18.4
5450.4	44.9	-8.3	36.6	54.0	-17.4
6358.8	44.1	-6.2	37.9	54.0	-16.1
7267.2	44.5	-6.5	38.0	54.0	-16.0
8175.6	48.2	-0.7	47.5	54.0	-6.5
9084.0	45.2	-1.1	44.1	54.0	-9.9

Table 3-5: Radiated Emissions Harmonics/Spurious – 916.0 MHz; Peak

Emission Frequency (MHz)	Peak Analyzer Reading (dBuV)	Site Correction Factor (dB/m)	Peak Emission Level (dBuV/m)	Peak Limit (dBuV/m)	Peak Margin (dB)
1832.0	49.7	-11.5	38.2	74.0	-35.8
2748.0	56.0	-13.7	42.3	74.0	-31.7
3664.0	48.5	-15.7	32.8	74.0	-41.2
4580.0	48.0	-9.5	38.5	74.0	-35.5
5496.0	46.8	-8.4	38.4	74.0	-35.6
6412.0	47.0	-6.0	41.0	74.0	-33.0
7328.0	46.4	-6.3	40.1	74.0	-33.9
8244.0	50.8	-0.6	50.2	74.0	-23.8
9160.0	47.4	-2.2	45.2	74.0	-28.8

Table 3-6: Radiated Emissions Harmonics/Spurious – 916.0 MHz; Average

Emission Frequency (MHz)	Average Analyzer Reading (dBuV)	Site Correction Factor (dB/m)	Average Emission Level (dBuV/m)	Average Limit (dBuV/m)	Average Margin (dB)
1832.0	48.2	-11.5	36.7	54.0	-17.3
2748.0	54.3	-13.7	40.6	54.0	-13.4
3664.0	46.3	-15.7	30.6	54.0	-23.4
4580.0	46.8	-9.5	37.3	54.0	-16.7
5496.0	45.0	-8.4	36.6	54.0	-17.4
6412.0	45.1	-6.0	39.1	54.0	-14.9
7328.0	44.8	-6.3	38.5	54.0	-15.5
8244.0	49.6	-0.6	49.0	54.0	-5.0
9160.0	45.8	-2.2	43.6	54.0	-10.4

Note: Testing performed at 3m

Measurement uncertainty: Measurement uncertainties shown for these tests are expanded uncertainties expressed at 95% confidence level using a coverage factor k = 2. ±4.6 dB

Result: Pass

Test Personnel:

Khue Do Test Engineer	 Signature	June 26- July 2, 2019 Dates of Test
--------------------------	--	--

4 AC Conducted Emissions - FCC 15.207; ISED RSS-Gen 7.2: AC Power Line Conducted Limits

4.1 Site and Test Description

The power line conducted emissions measurements were performed in a Series 81 type shielded enclosure manufactured by Rayproof. The EUT was assembled on a wooden table 80 centimeters high. Power was fed to the EUT through a 50-ohm/50 microhenry Line Impedance Stabilization Network (LISN). The EUT LISN was fed power through an A.C. filter box on the outside of the shielded enclosure. The filter box and EUT LISN housing are bonded to the ground plane of the shielded enclosure. A second LISN, the peripheral LISN, provides isolation for the EUT test peripherals. This peripheral LISN was also fed A.C. power. A metal power outlet box, which is bonded to the ground plane and electrically connected to the peripheral LISN, powers a DC power supply which powers the EUT.

The spectrum analyzer was connected to the AC line through an isolation transformer. The 50-ohm output of the EUT LISN was connected to the spectrum analyzer input through a Solar 100 kHz high-pass filter. The filter is used to prevent overload of the spectrum analyzer from noise below 100 kHz. Conducted emission levels were measured on each current-carrying line with the spectrum analyzer operating in the CISPR quasi-peak mode (or peak mode if applicable).

The analyzer's 6 dB bandwidth was set to 9 kHz. Video filter less than 10 times the resolution bandwidth is not used. Average measurements are performed in linear mode using a 10 kHz resolution bandwidth, a 1 Hz video bandwidth, and by increasing the sweep time in order to obtain a calibrated measurement. The emission spectrum was scanned from 150 kHz to 30 MHz. The highest emission amplitudes relative to the appropriate limits were measured and have been recorded.

4.2 Test Limits

Line-Conducted Emissions		
Limit (dBµV)		
Frequency (MHz)	Quasi-Peak	Average
0.15 to 0.50	66 to 56	56 to 46
0.50 to 5.00	56	46
5.00 to 30.00	60	50

Table 4-1: Conducted Emissions Test Equipment

RTL Asset #	Manufacturer	Model	Part Type	Serial Number	Calibration Due Date
901583	Agilent Technologies	N9010A	EXA Signal Analyzer (10 Hz-26.5 GHz)	MY51250846	4/26/21
901083	AFJ International	LS16	16A LISN (110 V)	16010020080	2/13/21
N/A	Quantum Change	Tile!	Test Software	4.0.A.8	N/A
901699	Hewlett Packard	E3610A	DC Power Supply	KR72917306	N/A

4.3 Conducted Emissions Test Data

Plot 4-1: Conducted Emissions – Phase – NA LTE; Power Supply #1

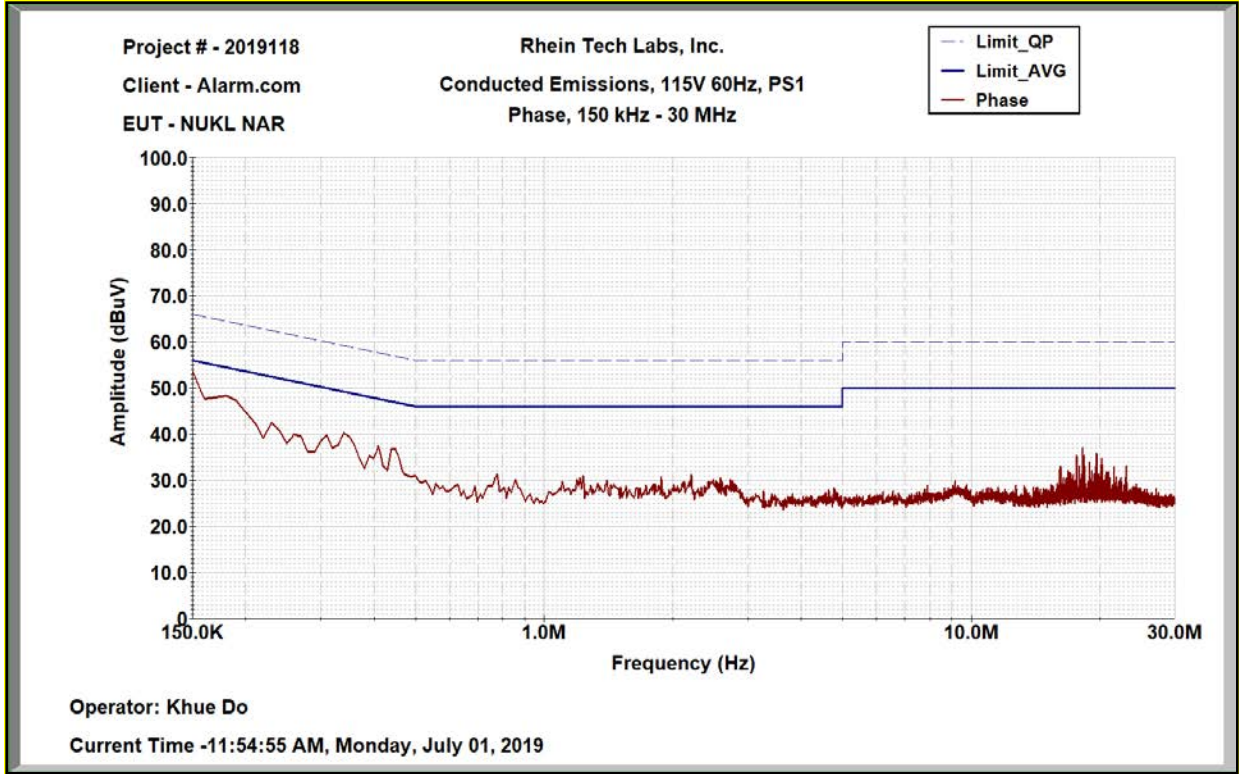

Table 4-2: Conducted Emissions – Phase – NA LTE; Power Supply #1

Frequency (MHz)	Detector	Level (dB μ V)	Site Correction Factor (dB)	Corrected Level (dB μ V)	Limit (dB μ V)	Margin (dB)	Pass/Fail
0.150	QPK	51.1	0.1	51.2	56.0	-4.8	Pass
0.150	AVG	40.4	0.1	40.5	46.0	-5.5	Pass

Plot 4-2: Conducted Emissions – Neutral – NA LTE; Power Supply #1

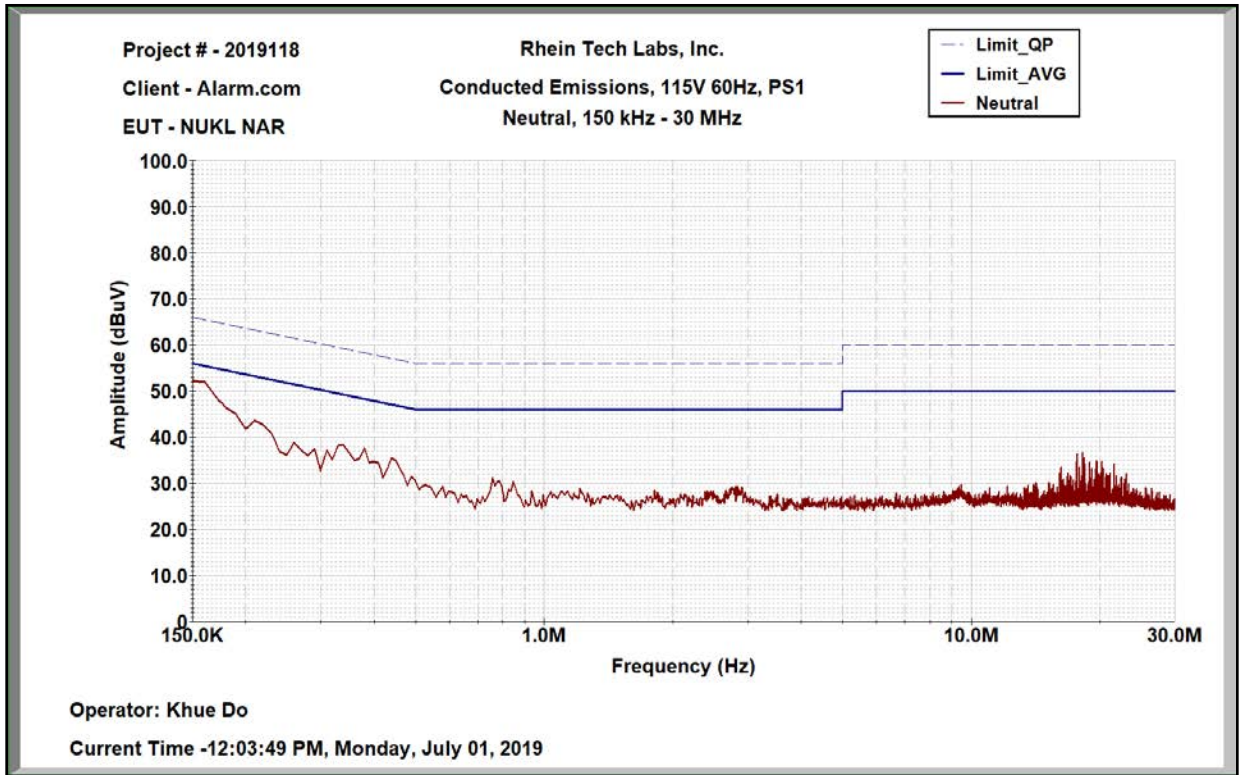

Table 4-3: Conducted Emissions – Neutral – NA LTE; Power Supply #1

Frequency (MHz)	Detector	Level (dB μ V)	Site Correction Factor (dB)	Corrected Level (dB μ V)	Limit (dB μ V)	Margin (dB)	Pass/Fail
0.150	QPK	49.5	0.1	49.6	56.0	-6.4	Pass
0.150	AVG	35.8	0.1	35.9	46.0	-10.1	Pass

Plot 4-3: Conducted Emissions – Phase – NA LTE; Power Supply #2

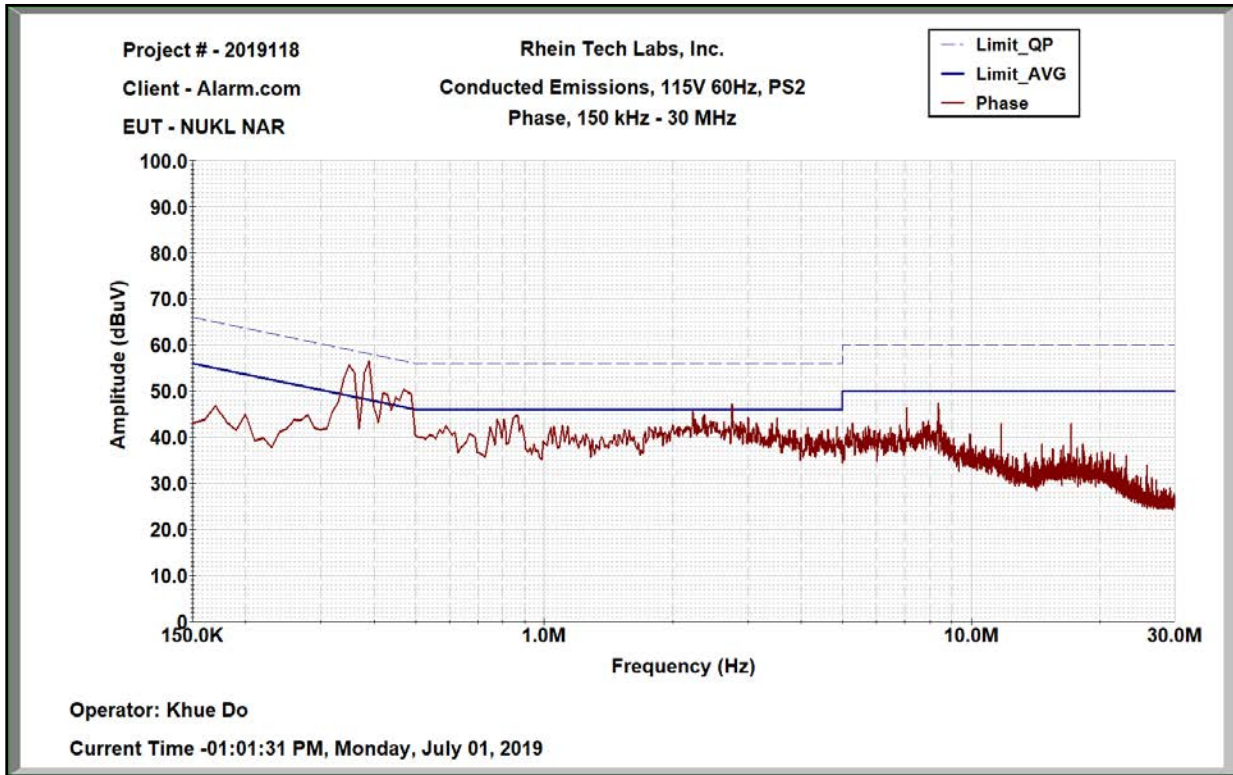

Table 4-4: Conducted Emissions – Phase – NA LTE; Power Supply #2

Frequency (MHz)	Detector	Level (dB μ V)	Site Correction Factor (dB)	Corrected Level (dB μ V)	Limit (dB μ V)	Margin (dB)	Pass/Fail
0.353	QPK	52.9	0.1	53.0	58.9	-5.9	Pass
0.353	AVG	46.3	0.1	46.4	48.9	-2.5	Pass
0.388	QPK	54.1	0.1	54.2	58.1	-3.9	Pass
0.388	AVG	46.8	0.1	46.9	48.1	-1.2	Pass
0.451	QPK	45.7	0.2	45.9	56.0	-10.1	Pass
0.451	AVG	36.2	0.2	36.4	46.0	-9.6	Pass
2.468	AVG	41.1	0.6	41.7	56.0	-14.3	Pass
2.468	AVG	33.8	0.6	34.4	46.0	-11.6	Pass

Plot 4-4: Conducted Emissions – Neutral – NA LTE; Power Supply #2

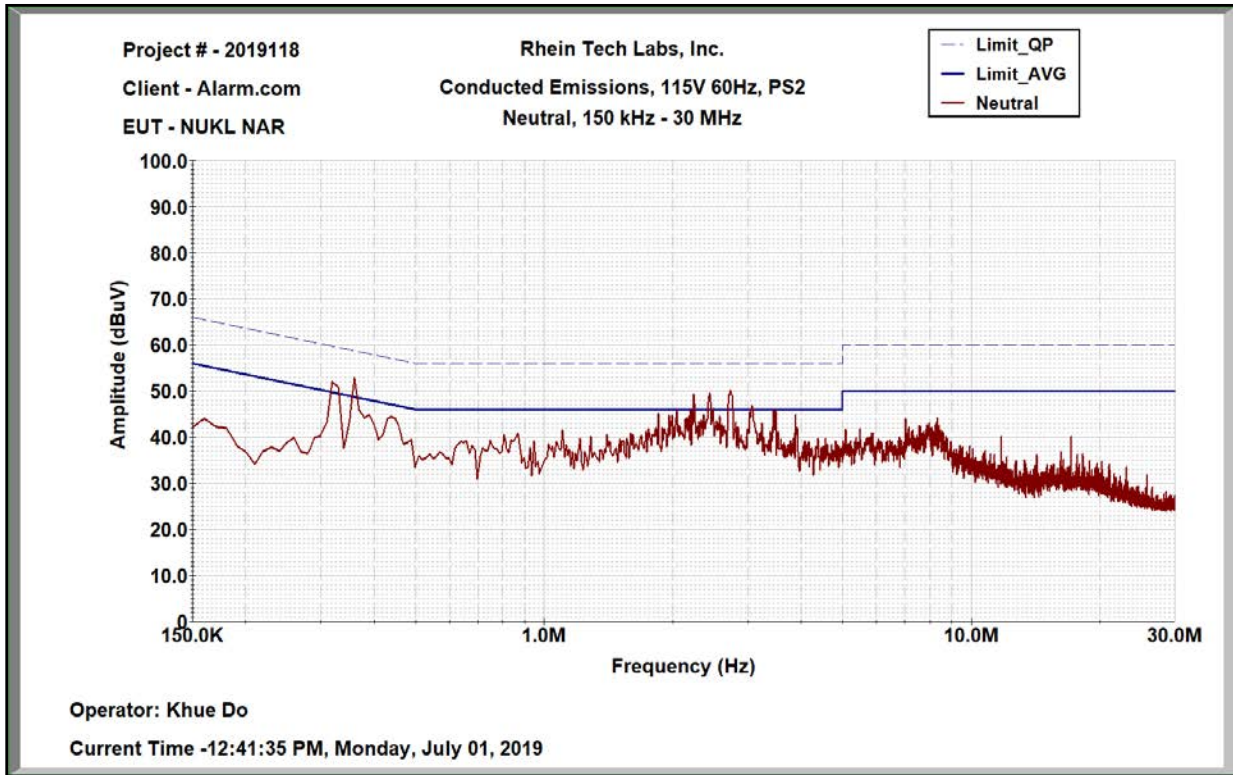

Table 4-5: Conducted Emissions – Neutral – NA LTE; Power Supply #2

Frequency (MHz)	Detector	Level (dB μ V)	Site Correction Factor (dB)	Corrected Level (dB μ V)	Limit (dB μ V)	Margin (dB)	Pass/Fail
0.325	QPK	38.5	0.1	38.6	56.0	-17.4	Pass
0.325	AVG	31.7	0.1	31.8	46.0	-14.2	Pass
0.389	QPK	51.1	0.1	51.2	56.0	-4.8	Pass
0.389	AVG	43.0	0.1	43.1	46.0	-2.9	Pass
2.440	QPK	40.5	0.6	41.1	56.0	-14.9	Pass
2.440	AVG	28.5	0.6	29.1	46.0	-16.9	Pass
2.600	QPK	41.9	0.6	42.5	56.0	-13.5	Pass
2.600	AVG	28.8	0.6	29.4	46.0	-16.6	Pass
3.186	QPK	39.4	0.7	40.1	56.0	-15.9	Pass
3.186	AVG	28.4	0.7	29.1	46.0	-16.9	Pass

Plot 4-5: Conducted Emissions – Phase - SVL LTE; Power Supply #2

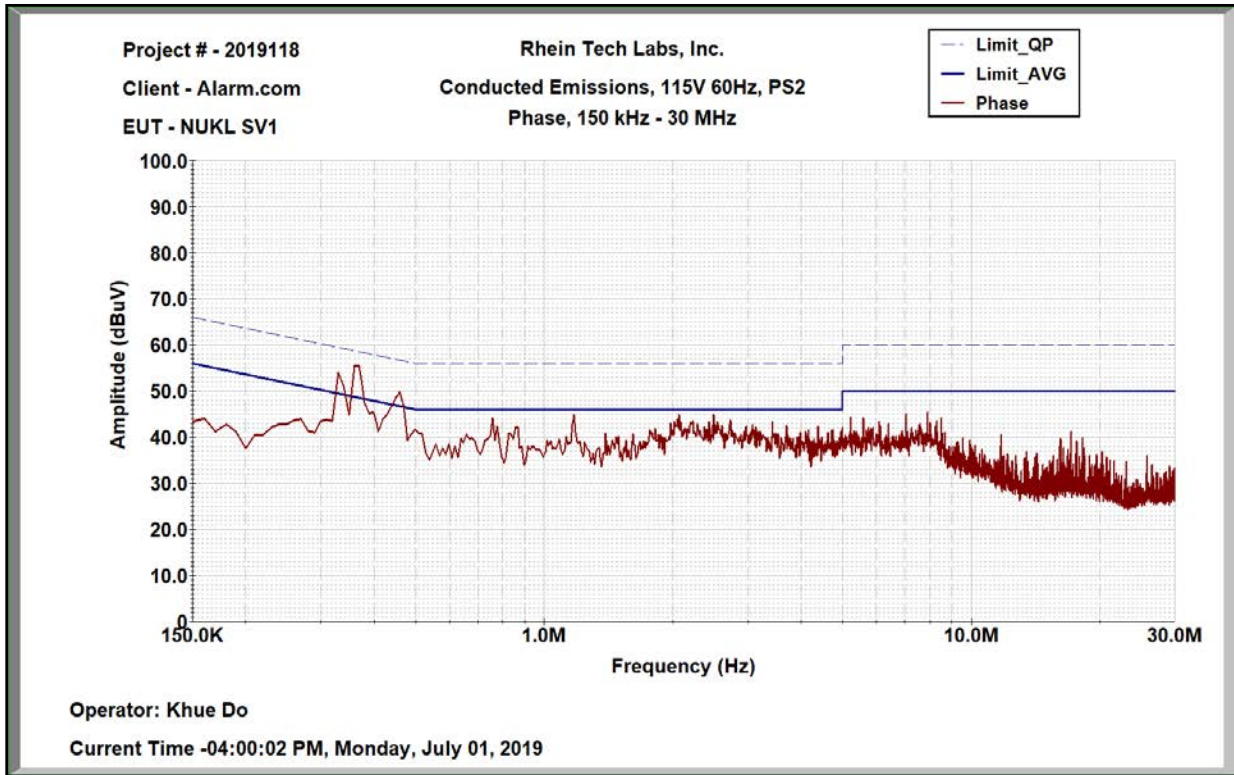

Table 4-6: Conducted Emissions – Phase - SVL LTE; Power Supply #2

Frequency (MHz)	Detector	Level (dB μ V)	Site Correction Factor (dB)	Corrected Level (dB μ V)	Limit (dB μ V)	Margin (dB)	Pass/Fail
0.355	QPK	52.1	0.1	52.2	58.8	-6.6	Pass
0.355	AVG	44.7	0.1	44.8	48.8	-4.0	Pass
0.387	QPK	54.3	0.1	54.4	58.1	-3.7	Pass
0.387	AVG	47.0	0.1	47.1	48.1	-1.0	Pass
0.474	QPK	46.6	0.1	46.7	56.4	-9.7	Pass
0.474	AVG	37.9	0.1	38.0	46.4	-8.4	Pass

Plot 4-6: Conducted Emissions – Neutral - SVL LTE; Power Supply #2

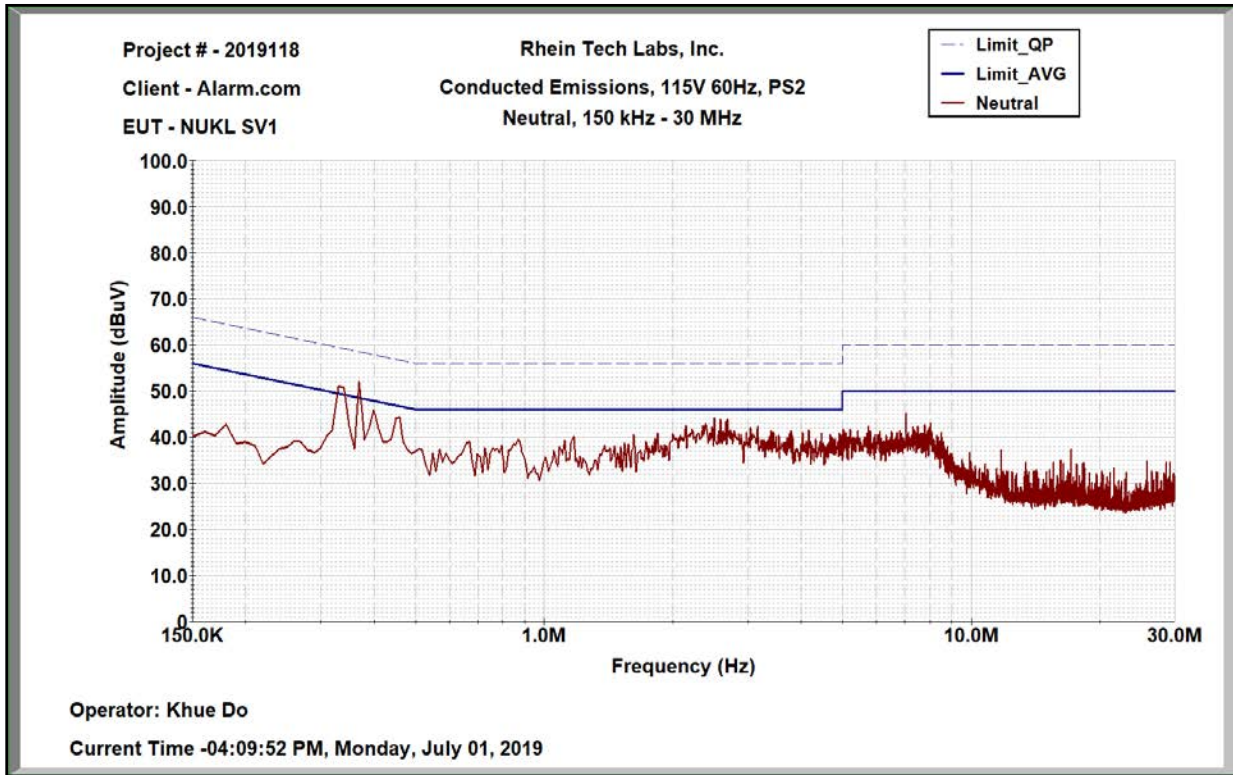

Table 4-7: Conducted Emissions – Neutral – SVL LTE; Power Supply #2

Frequency (MHz)	Detector	Level (dB μ V)	Site Correction Factor (dB)	Corrected Level (dB μ V)	Limit (dB μ V)	Margin (dB)	Pass/Fail
0.360	QPK	50.5	0.1	50.6	58.7	-8.1	Pass
0.360	AVG	43.1	0.1	43.2	48.7	-5.5	Pass
0.390	QPK	51.1	0.1	51.2	58.1	-6.9	Pass
0.390	AVG	42.5	0.1	42.6	48.1	-5.5	Pass

Plot 4-7: Conducted Emissions – Phase - SVL LTE; Power Supply #1

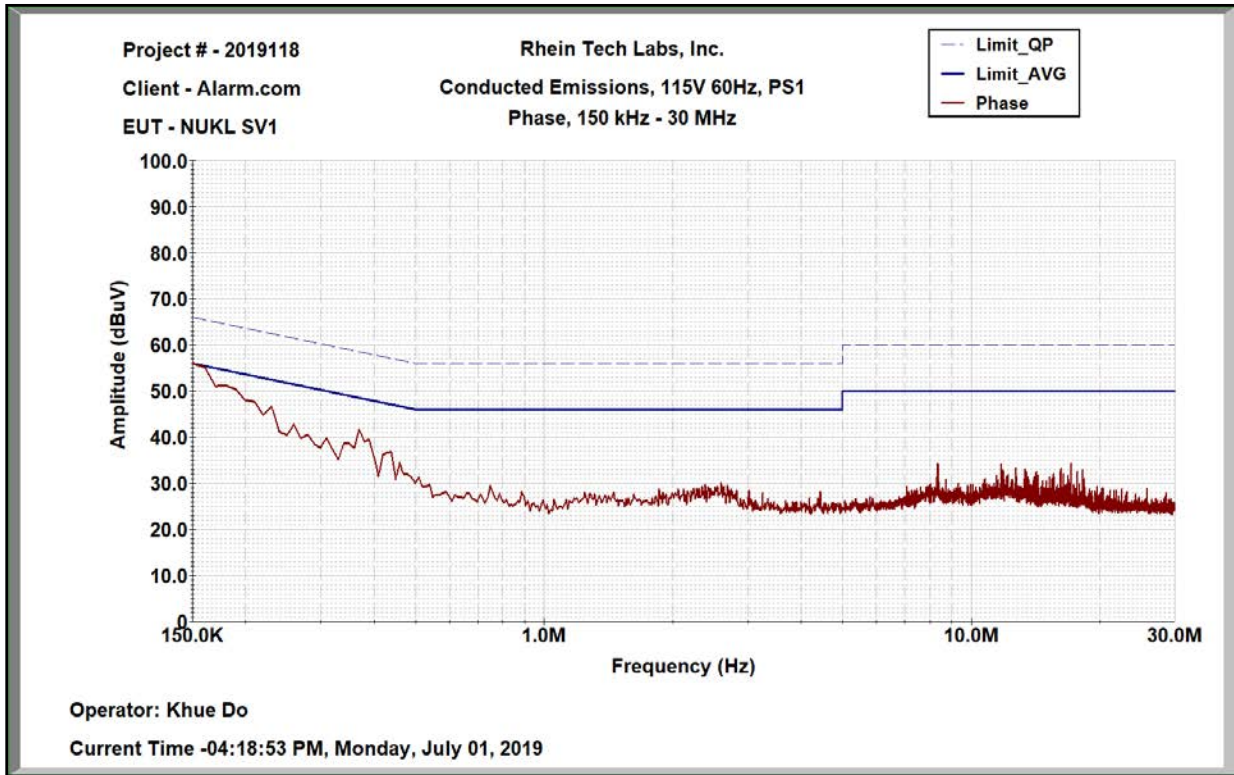
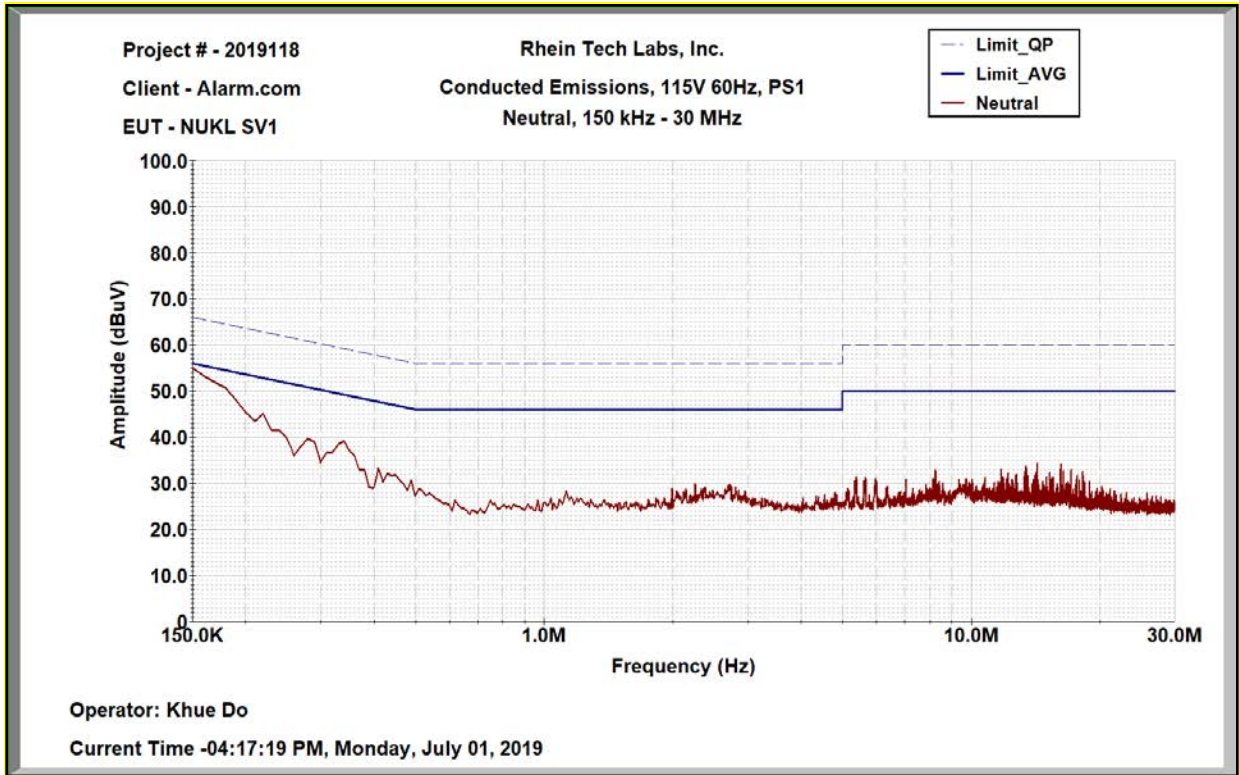

Table 4-8: Conducted Emissions – Phase – SVL LTE; Power Supply #1

Frequency (MHz)	Detector	Level (dB μ V)	Site Correction Factor (dB)	Corrected Level (dB μ V)	Limit (dB μ V)	Margin (dB)	Pass/Fail
0.150	QPK	53.3	0.1	53.4	66.0	-12.6	Pass
0.150	AVG	39.0	0.1	39.1	56.0	-16.9	Pass

Plot 4-8: Conducted Emissions – Neutral - SVL LTE; Power Supply #1



Measurement uncertainty: Measurement uncertainties shown for these tests are expanded uncertainties expressed at 95% confidence level using a coverage factor $k = 2$. ± 3.6 dB

Test Personnel:

Khue Do		July 1, 2019
Test Engineer	Signature	Date of Test

5 99% Bandwidth – ISED RSS-Gen Issue 5 6.6

5.1 99% Bandwidth Test Procedure

The 99% bandwidth per RSS-Gen was measured using a 50-ohm spectrum analyzer, per C63.10 6.9.2. The modulated carrier was adjusted on the analyzer with the RBW 1-5% of the occupied bandwidth and the span 1-5 times the occupied bandwidth. The sweep time was auto and allowed through several sweeps with the max hold function used in peak detector mode. The table below contains the bandwidth measurement results.

Table 5-1: 99% Bandwidth Test Equipment

RTL Asset #	Manufacturer	Model	Part Type	Serial Number	Calibration Due Date
901581	Rohde & Schwarz	FSU	Spectrum Analyzer (20 Hz – 50 GHz)	1166.1660.50	4/26/21

5.2 Bandwidth Test Data

Table 5-2: 99% Bandwidth Test Data

99% bandwidths	
Frequency (MHz)	Bandwidth (kHz)
908.4	112.2
916.0	115.4

Plot 5-1: 99% Bandwidth – 908.4 MHz

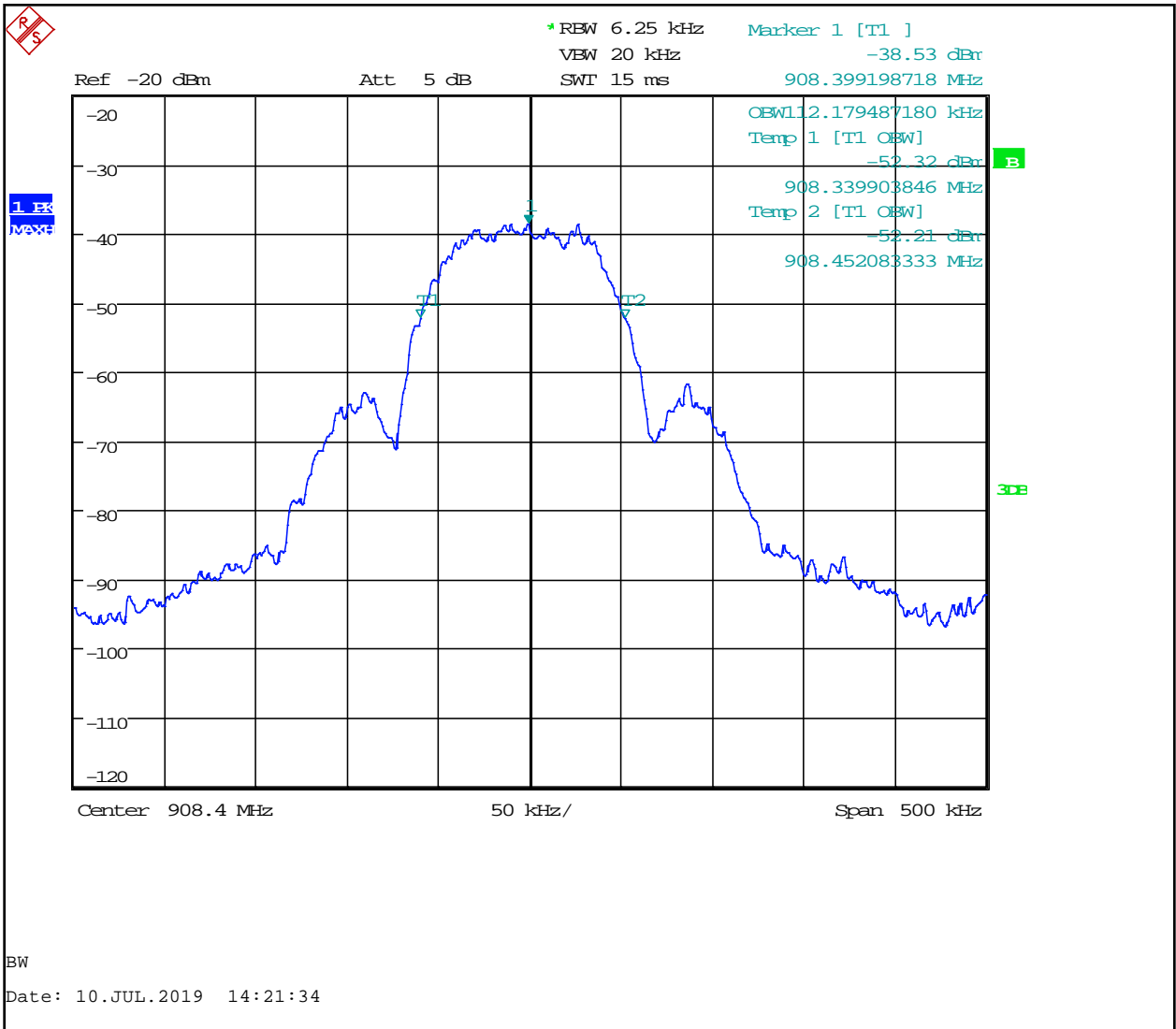

Plot 5-2: 99% Bandwidth - 916.0 MHz

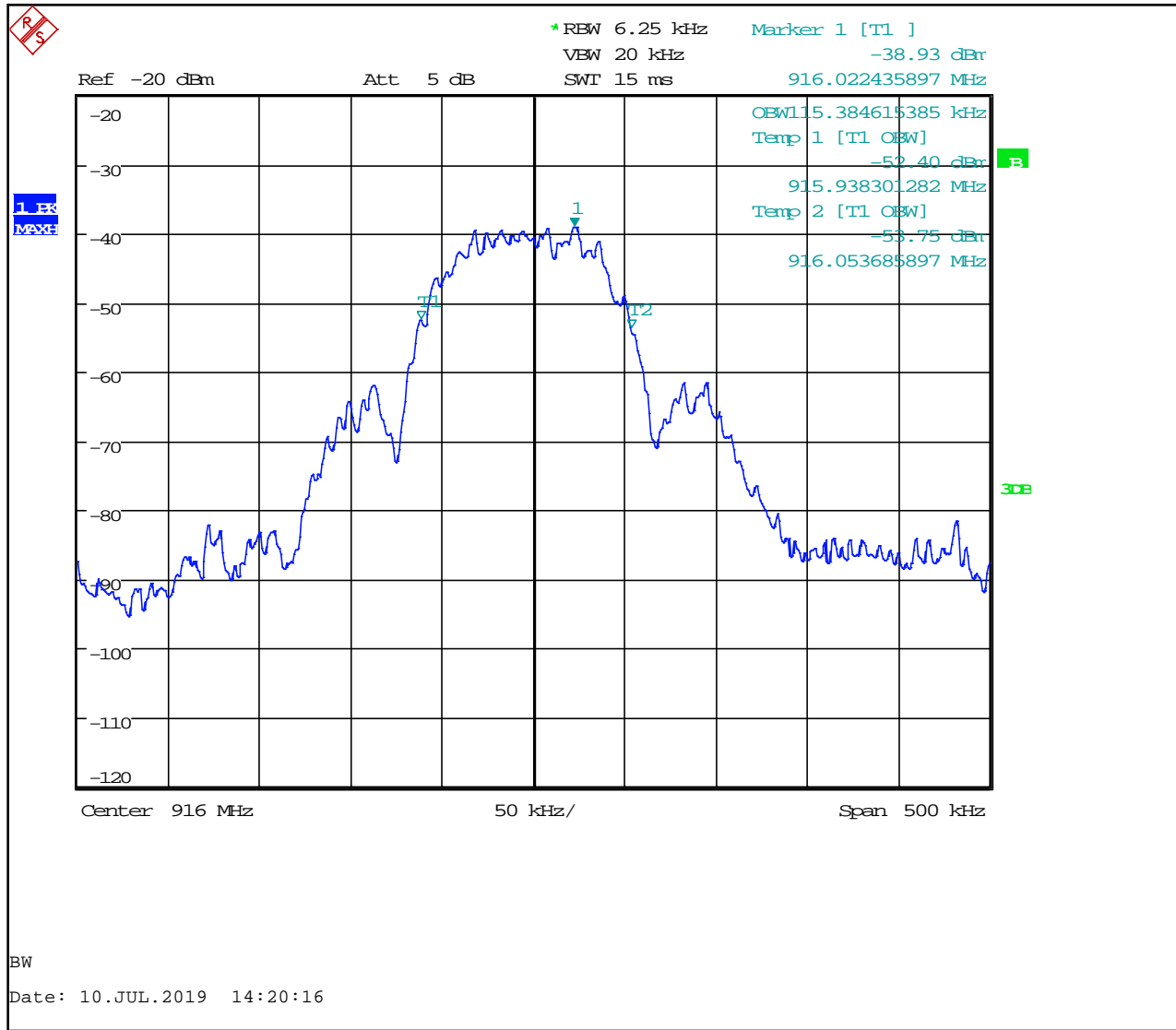

Test Personnel

Dan Baltzell
 Test Engineer

Signature

July 10, 2019
 Date of Test

6 Conclusion

The data in this measurement report shows that the EUT as tested, Alarm.com Model ADC-NK-200T-A, FCC ID: YL6-143NK200T, IC: 9111A-143NK200T, complies with the applicable requirements of Parts 2 and 15 of the FCC Rules and Regulations, and ISED RSS-210 and RSS-Gen.