



MET Laboratories, Inc. *Safety Certification - EMI - Telecom Environmental Simulation*
914 WEST PATAPSCO AVENUE • BALTIMORE, MARYLAND 21230 • PHONE (410) 354-3300 • FAX (410) 354-3313

February 24, 2011

Alarm.com
8150 Leesburg Pike, Suite 1400
Vienna, VA 22182

Dear David Goldfarb,

Enclosed is the EMC Wireless test report for compliance testing of the Alarm.com, ADC-IS-EVD as tested to the requirements of Title 47 of the CFR, Ch. 1 (10-1-06 ed.), Part 15, Subpart B, ICES-003, Issue 4 February 2004 for a Class B Digital Device and FCC Part 15 Subpart C, RSS-210, Issue 7, June 2007 for Intentional Radiators.

Thank you for using the services of MET Laboratories, Inc. If you have any questions regarding these results or if MET can be of further service to you, please feel free to contact me.

Sincerely yours,
MET LABORATORIES, INC.

Jennifer Warnell
Documentation Department

Reference: (\Alarm.com\EMC30157-FCC249 Rev. 2)

Certificates and reports shall not be reproduced except in full, without the written permission of MET Laboratories, Inc.

Electromagnetic Compatibility Criteria Test Report

for the

Alarm.com
ADC-IS-EVD

Verified under
the FCC Certification Rules
contained in
Title 47 of the CFR, Parts 15 Subpart B & ICES-003
for Class B Digital Devices
&
15.249 Subpart C & RSS-210, Issue 7, June 2007
for Intentional Radiators

MET Report: EMC30157-FCC249 Rev. 2

February 24, 2011

Prepared For:

Alarm.com
8150 Leesburg Pike, Suite 1400
Vienna, VA 22182

Prepared By:
MET Laboratories, Inc.
914 W. Patapsco Ave.
Baltimore, MD 21230

**Electromagnetic Compatibility Criteria
Test Report**

for the

**Alarm.com
ADC-IS-EVD**

Tested Under

the FCC Certification Rules
contained in
Title 47 of the CFR, Parts 15 Subpart B & ICES-003
for Class B Digital Devices
&
15.249 Subpart C & RSS-210, Issue 7, June 2007
for Intentional Radiators



Manasi Bhandiwad, Project Engineer
Electromagnetic Compatibility Lab



Jennifer Warnell
Documentation Department

Engineering Statement: The measurements shown in this report were made in accordance with the procedures indicated, and the emissions from this equipment were found to be within the limits applicable. I assume full responsibility for the accuracy and completeness of these measurements, and for the qualifications of all persons taking them. It is further stated that upon the basis of the measurements made, the equipment tested is capable of operation in accordance with the requirements of the FCC Rules Parts 15B, 15.249 and Industry Canada standards ICES-003, Issue 4 February 2004, RSS-210, Issue 7, June 2007 under normal use and maintenance.



Shawn McMillen, Wireless Manager
Electromagnetic Compatibility Lab



Report Status Sheet

Revision	Report Date	Reason for Revision
∅	December 23, 2010	Initial Issue.
1	February 18, 2011	Editorial corrections.
2	February 24, 2011	Editorial corrections.

Table of Contents

I.	Executive Summary	1
	A. Purpose of Test	2
	B. Executive Summary	2
II.	Equipment Configuration	3
	A. Overview	4
	B. References	5
	C. Test Site	5
	D. Description of Test Sample.....	5
	E. Equipment Configuration	6
	F. Support Equipment	6
	G. Ports and Cabling Information.....	6
	H. Mode of Operation.....	7
	I. Modifications.....	7
	a) Modifications to EUT.....	7
	b) Modifications to Test Standard.....	7
	J. Disposition of EUT.....	7
III.	Electromagnetic Compatibility Criteria for Unintentional Radiators	8
	§ 15.107(a) Conducted Emissions Limits.....	9
	§ 15.109(a) Radiated Emission Limits	10
IV.	Electromagnetic Compatibility Criteria for Intentional Radiators.....	14
	§ 15.203 Antenna Requirement.....	15
	§ 15.207(a) Conducted Emissions Limits.....	16
	§ 15.249(a) Radiated Fundament and Harmonics	17
	99% Bandwidth	19
	§ 15.249(d) Spurious Emissions Requirements.....	23
	RSS-GEN Receiver Spurious Emissions.....	30
V.	Test Equipment	33
VI.	Certification & User's Manual Information.....	35
	A. Certification Information	36
	B. Label and User's Manual Information.....	40
VII.	ICES-003 Procedural & Labeling Requirements.....	42

List of Tables

Table 1. Executive Summary of EMC Part 15.249 Compliance Testing	2
Table 2. EUT Specifications	4
Table 3. Equipment Configuration	6
Table 4. Support Equipment.....	6
Table 5. Ports and Cabling Information	6
Table 6. Conducted Limits for Radio Frequency Devices calculated from FCC Part 15 Section 15.107(a) (b)	9
Table 7. Radiated Emissions Limits calculated from FCC Part 15, §15.109 (a) (b)	10
Table 8. Radiated Emissions Limits, Test Results, FCC.....	11
Table 9. Radiated Emissions Limits, Test Results, ICES-003.....	12
Table 10. Conducted Limits for Intentional Radiators from FCC Part 15 § 15.207(a)	16
Table 11. Spurious Emission Limits for Receivers	30

List of Photographs

Photograph 1. Alarm.com, ADC-IS-EVD.....	5
Photograph 2. Radiated Emissions, Test Setup	13
Photograph 3. Transceiver Spurious Emissions, Test Setup	29

List of Plots

Plot 1. Radiated Emissions, Pre-Scan, 30 MHz – 1 GHz, FCC Limits	11
Plot 2. Radiated Emissions, Pre-Scan, 30 MHz – 1 GHz, ICES-003 Limits	12
Plot 3. Fundamental Field Strength, Low Channel, Peak Detector	17
Plot 4. Fundamental Field Strength, Mid Channel, Peak Detector.....	18
Plot 5. Fundamental Field Strength, High Channel, Peak Detector.....	18
Plot 6. Occupied Bandwidth, Low Channel FCC Limits	19
Plot 7. Occupied Bandwidth, Mid Channel FCC Limits	20
Plot 8. Occupied Bandwidth, High Channel FCC Limits.....	20
Plot 9. Occupied Bandwidth, Low Channel, IC Limits	21
Plot 10. Occupied Bandwidth, Mid Channel, IC Limits.....	21
Plot 11. Occupied Bandwidth, High Channel, IC Limits	22
Plot 12. Radiated Spurious Emissions, Low Channel, 30 MHz – 1 GHz.....	23
Plot 13. Radiated Spurious Emissions, Low Channel, Peak.....	24
Plot 14. Radiated Spurious Emissions, Low Channel, Average	24
Plot 15. Radiated Spurious Emissions, Mid Channel, 30 MHz – 1 GHz	25
Plot 16. Radiated Spurious Emissions, Mid Channel, Peak	25
Plot 17. Radiated Spurious Emissions, Mid Channel, Average.....	26
Plot 18. Radiated Spurious Emissions, High Channel, 30 MHz – 1 GHz	26
Plot 19. Radiated Spurious Emissions, High Channel, Peak	27
Plot 20. Radiated Spurious Emissions, High Channel, Average	27
Plot 21. Band Edge, Low Channel	28
Plot 22. Band Edge, High Channel.....	28
Plot 23. Receiver Spurious Emission, 30 MHz – 1 GHz.....	31
Plot 24. Receiver Spurious Emission, 1 GHz – 10 GHz, Peak.....	31
Plot 25. Receiver Spurious Emission, 1 GHz – 10 GHz, Average.....	32

List of Terms and Abbreviations

AC	Alternating Current
ACF	Antenna Correction Factor
Cal	Calibration
<i>d</i>	Measurement Distance
dB	Decibels
dB μ A	Decibels above one microamp
dB μ V	Decibels above one microvolt
dB μ A/m	Decibels above one microamp per meter
dB μ V/m	Decibels above one microvolt per meter
DC	Direct Current
E	Electric Field
DSL	Digital Subscriber Line
ESD	Electrostatic Discharge
EUT	Equipment Under Test
<i>f</i>	Frequency
FCC	Federal Communications Commission
GRP	Ground Reference Plane
H	Magnetic Field
HCP	Horizontal Coupling Plane
Hz	Hertz
IEC	International Electrotechnical Commission
kHz	kilohertz
kPa	kilopascal
kV	kilovolt
LISN	Line Impedance Stabilization Network
MHz	Megahertz
μ H	microhenry
μ F	microfarad
μ s	microseconds
PRF	Pulse Repetition Frequency
RF	Radio Frequency
RMS	Root-Mean-Square
TWT	Traveling Wave Tube
V/m	Volts per meter
VCP	Vertical Coupling Plane

I. Executive Summary

A. Purpose of Test

An EMC evaluation was performed to determine compliance of the Alarm.com ADC-IS-EVD, with the requirements of Part 15, §15.249. All references are to the most current version of Title 47 of the Code of Federal Regulations in effect. In accordance with §2.1033, the following data is presented in support of the Certification of the ADC-IS-EVD. Alarm.com should retain a copy of this document which should be kept on file for at least two years after the manufacturing of the ADC-IS-EVD, has been **permanently** discontinued.

B. Executive Summary

The following tests were conducted on a sample of the equipment for the purpose of demonstrating compliance with Part 15, §15.249, in accordance with Alarm.com, purchase order number T00732. All tests were conducted using measurement procedure ANSI C63.4-2003.

FCC Reference	RSS-210 and RSS-GEN	Description	Results
15.107	RSS-GEN §7.2.3	AC Power Line Conducted Emissions	Not Applicable
15.109	RSS-Gen §4.8 and RSS-Gen §6(a)	Radiated Emissions	Compliant
§15.203	RSS GEN §7.1.4	Antenna Requirement	Compliant
§15.207	RSS GEN §7.2.2	AC Power Line Conducted Emissions	Not Applicable
§15.249 (a)	RSS-Gen§4.7 and RSS-210 §2.7	Field Strength of Fundamental	Compliant
§15.249(a)(d), §15.209	RSS-Gen §4.7 and RSS-210 §2.7	Harmonics and Spurious Emissions	Compliant
§15.215 (c)	RSS GEN §4.4.1	20 dB and 99% Bandwidth	Compliant
N/A	RSS-GEN §6(a)	Receiver Spurs	Compliant

Table 1. Executive Summary of EMC Part 15.249 Compliance Testing

II. Equipment Configuration

A. Overview

MET Laboratories, Inc. was contracted by Alarm.com to perform testing on the ADC-IS-EVD, under Alarm.com's purchase order number T00732.

This document describes the test setups, test methods, required test equipment, and the test limit criteria used to perform compliance testing of the Alarm.com, ADC-IS-EVD.

The results obtained relate only to the item(s) tested.

Model(s) Tested:	ADC-IS-EVD	
EUT Specifications:	Primary Power to Module: 12 VDC Supplied by Host	
	FCC ID: YL6-143IS15V4 IC: 9111A-143IS15V4	
	Type of Modulations:	FSK
	Equipment Code:	DXX
	Highest Fundamental Field Strength:	69.73 dBuV/m
	EUT Frequency Ranges:	906 – 924 MHz
Analysis:	The results obtained relate only to the item(s) tested.	
Environmental Test Conditions:	Temperature (15-35° C)	
	Relative Humidity (30-60%)	
	Barometric Pressure (860-1060 mbar)	
Evaluated by:	Manasi Bhandiwad	
Report Date(s):	February 24, 2011	

Table 2. EUT Specifications

B. References

CFR 47, Part 15, Subpart C	Federal Communication Commission, Code of Federal Regulations, Title 47, Part 15: General Rules and Regulations, Allocation, Assignment, and Use of Radio Frequencies
CFR 47, Part 15, Subpart B	Electromagnetic Compatibility: Criteria for Radio Frequency Devices
ANSI C63.4:2003	Methods and Measurements of Radio-Noise Emissions from Low-Voltage Electrical And Electronic Equipment in the Range of 9 kHz to 40 GHz
ANSI/NCSL Z540-1-1994	Calibration Laboratories and Measuring and Test Equipment - General Requirements
ANSI/ISO/IEC 17025:2005	General Requirements for the Competence of Testing and Calibration Laboratories
ANSI C63.10-2009	American National Standard for Testing Unlicensed Wireless Devices

C. Test Site

All testing was performed at MET Laboratories, Inc., 914 W. Patapsco Ave., Baltimore, MD 21230. All equipment used in making physical determinations is accurate and bears recent traceability to the National Institute of Standards and Technology.

Radiated Emissions measurements were performed in a semi-anechoic chamber (equivalent to an Open Area Test Site). In accordance with §2.948(a)(3), a complete site description is contained at MET Laboratories.

D. Description of Test Sample

The Alarm.com ADC-IS-EVD, sends and receives data from a Image Sensor Camera.

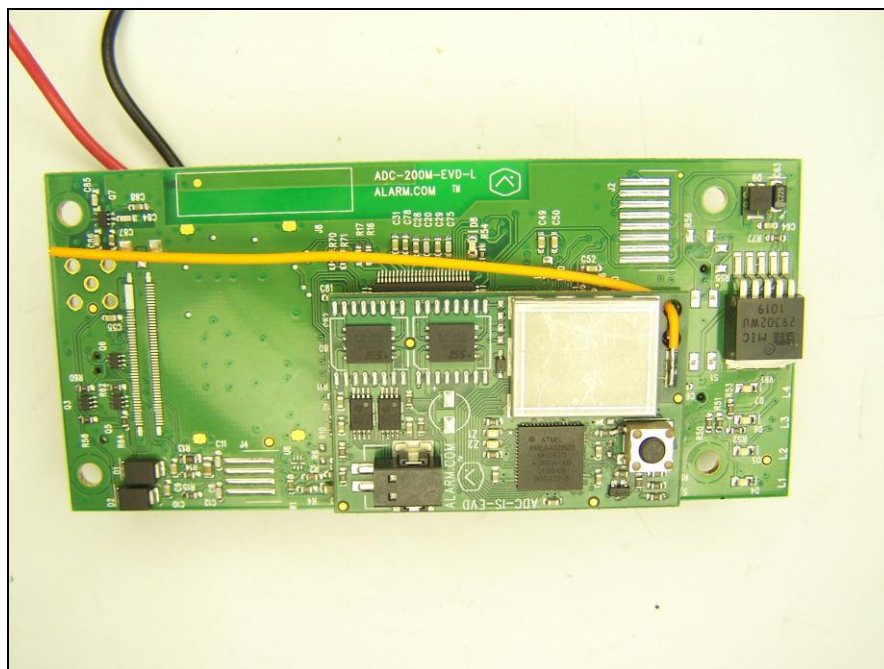

Photograph 1. Alarm.com, ADC-IS-EVD

E. Equipment Configuration

Ref. ID	Name / Description	Model Number	Serial Number
A	ISC Daughterboard	ADC-IS-EVD	N/A

Table 3. Equipment Configuration

F. Support Equipment

Ref. ID	Name / Description	Manufacturer	Model Number	Serial Number
B	Alarm.com Module	Alarm.com	ADC-200T-EVD	N/A

Table 4. Support Equipment

G. Ports and Cabling Information

Ref. ID	Port Name on EUT	Cable Description or Reason for No Cable	Qty.	Length (m)	Shielded (Y/N)	Termination Box ID & Port ID
1	Power	ADC-200M-EVD's physical API is a 22-pin connector. It receives power/data through this connector	1	N/A	N/A	N/A

Table 5. Ports and Cabling Information

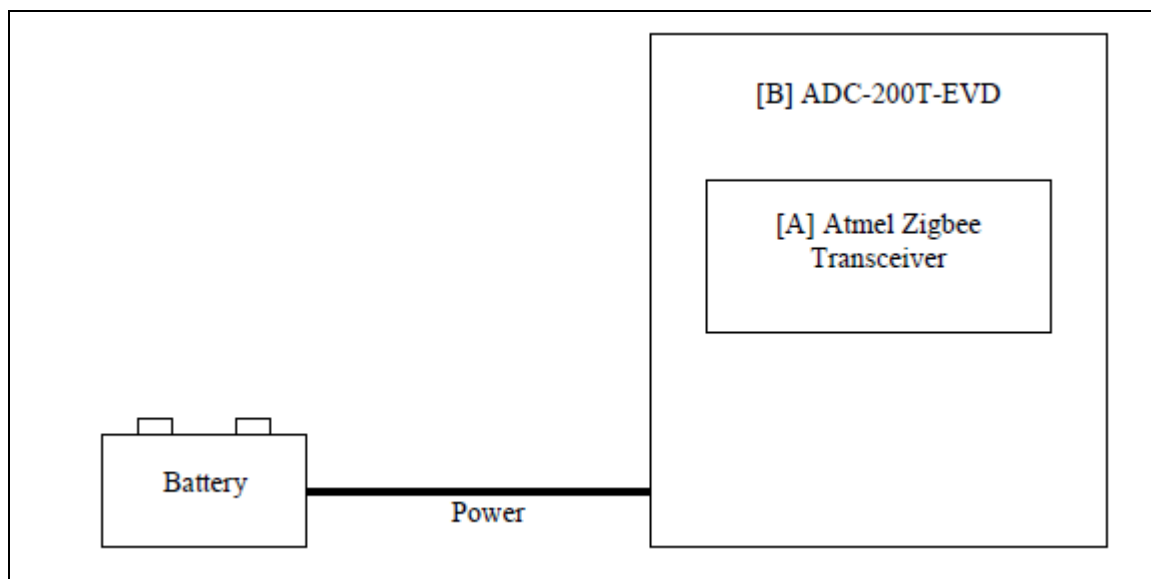

Figure 1. Block Diagram of Test Configuration

H. Mode of Operation

The Atmel Zigbee Radio is powered on for testing. As long as the ADC-IS-EVD is powered, there is a continual exchange of information between the Atmel Zigbee Radio and local Atmel Zigbee Radio devices.

I. Modifications

a) Modifications to EUT

No modifications were made to the EUT.

b) Modifications to Test Standard

No modifications were made to the test standard.

J. Disposition of EUT

The test sample including all support equipment submitted to the Electro-Magnetic Compatibility Lab for testing was returned to Alarm.com upon completion of testing.

III. Electromagnetic Compatibility Criteria for Unintentional Radiators

Electromagnetic Compatibility Criteria for Unintentional Radiators

§ 15.107 Conducted Emissions Limits

Test Requirement(s): **15.107 (a)** “Except for Class A digital devices, for equipment that is designed to be connected to the public utility (AC) power line, the radio frequency voltage that is conducted back onto the AC power line on any frequency or frequencies within the band 150 kHz to 30 MHz shall not exceed the limits in Table 6. Compliance with this provision shall be based on the measurement of the radio frequency voltage between each power line and ground at the power terminals.”

15.107 (b) “For a Class A digital device that is designed to be connected to the public utility (AC) power line, the radio frequency voltage that is conducted back onto the AC power line on any frequency or frequencies within the band 150 kHz to 30 MHz shall not exceed the limits in Table 6. Compliance with this provision shall be based on the measurement of the radio frequency voltage between each power line and ground at the power terminals. The lower limit applies at the band edges.”

Frequency range (MHz)	15.107(b), Class A Limits (dBµV)		15.107(a), Class B Limits (dBµV)	
	Quasi-Peak	Average	Quasi-Peak	Average
0.15- 0.5	79	66	66 - 56	56 - 46
0.5 – 5.0	73	60	56	46
5.0 - 30	73	60	60	50

Note 1 — The lower limit shall apply at the transition frequencies.

Table 6. Conducted Limits for Radio Frequency Devices calculated from FCC Part 15 Section 15.107(a) (b)

Test Results: The EUT was not applicable with the Class B requirement(s) of this section. The EUT is battery powered.

Radiated Emission Limits

§ 15.109 Radiated Emissions Limits

Test Requirement(s): **15.109 (a)** Except for Class A digital devices, the field strength of radiated emissions from unintentional radiators at a distance of 3 meters shall not exceed the Class B limits expressed in Table 7.

15.109 (b) The field strength of radiated emissions from a Class A digital device, as determined at a distance of 10 meters, shall not exceed the Class A limits expressed in Table 7.

Frequency (MHz)	Field Strength (dB μ V/m)	
	§15.109 (b), Class A Limit (dB μ V) @ 10m	§15.109 (a), Class B Limit (dB μ V) @ 3m
30 - 88	39.00	40.00
88 - 216	43.50	43.50
216 - 960	46.40	46.00
Above 960	49.50	54.00

Table 7. Radiated Emissions Limits calculated from FCC Part 15, §15.109 (a) (b)

Test Procedures: The EUT was placed on a 0.8m-high acrylic table inside a semi-anechoic chamber. The method of testing and test conditions of ANSI C63.4 were used. An antenna was located 3 m from the EUT on an adjustable mast. A pre-scan was first performed in order to find prominent radiated emissions. For final emissions measurements at each frequency of interest, the EUT was rotated and the antenna height was varied between 1 m and 4 m in order to maximize the emission. Measurements in both horizontal and vertical polarities were made and the data was recorded. Unless otherwise specified, measurements were made using a quasi-peak detector with a 120 kHz bandwidth.

Test Results: The EUT was found compliant with the Class B requirement(s) of this section. Measured emissions were below applicable limits.

Test Engineer(s): Manasi Bhandiwad

Test Date(s): 11/29/10

Radiated Emissions Limits Test Results, Class B

Frequency (MHz)	EUT Azimuth (Degrees)	Antenna Polarity (H/V)	Antenna HEIGHT (m)	Uncorrected Amplitude (dBuV)	Antenna Correction Factor (dB) (+)	Cable Loss (dB) (+)	Distance Correction Factor (dB) (-)	Corrected Amplitude (dBuV/m)	Limit (dBuV/m)	Margin (dB)
44.729459	188	H	1.42	16.03	10.96	0.23	0.00	27.22	40.00	-12.78
44.729459	54	V	1.25	16.03	10.96	0.23	0.00	27.22	40.00	-12.78
165.53106	268	H	1.62	16.48	12.50	0.23	0.00	29.21	43.50	-14.29
165.53106	63	V	1.55	16.48	12.50	0.23	0.00	29.21	43.50	-14.29
222.44489	176	H	1.71	12.73	11.45	0.23	0.00	24.41	46.00	-21.59
222.44489	30	V	1.02	12.73	11.45	0.23	0.00	24.41	46.00	-21.59
131.46293	213	H	1.06	16.48	13.65	0.23	0.00	30.36	43.50	-13.14
131.46293	12	V	1.69	16.26	13.65	0.23	0.00	30.14	43.50	-13.36
340.88176	313	H	1.02	13.06	14.84	0.83	0.00	28.73	46.00	-17.27
340.88176	0	V	1.28	13.06	14.84	0.83	0.00	28.73	46.00	-17.27
600	218	H	1.15	14.26	19.50	1.17	0.00	34.93	46.00	-11.07
600	41	V	1.71	14.26	19.50	1.17	0.00	34.93	46.00	-11.07

Table 8. Radiated Emissions Limits, Test Results, FCC

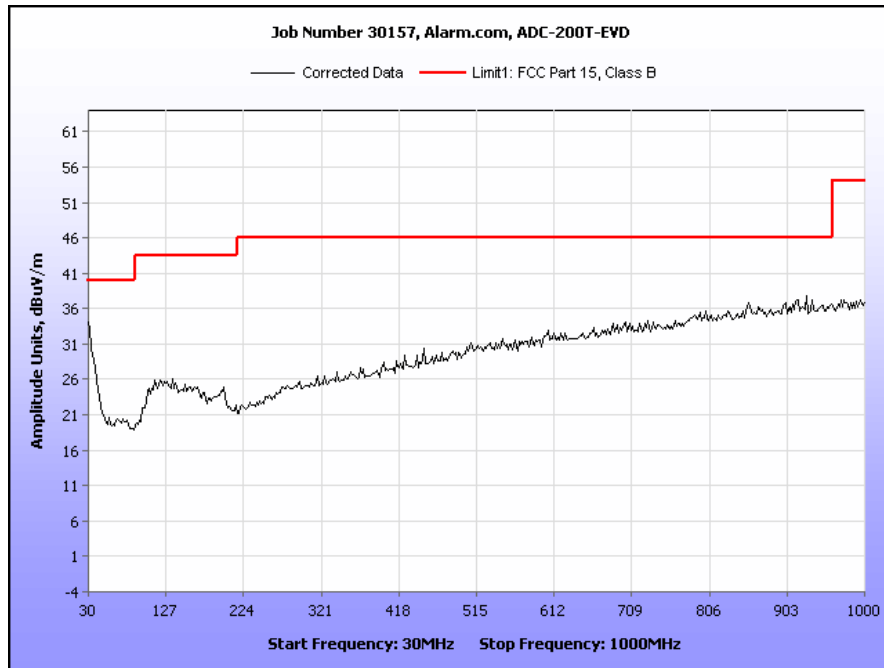

Plot 1. Radiated Emissions, Pre-Scan, 30 MHz – 1 GHz, FCC Limits

Frequency (MHz)	EUT Azimuth (Degrees)	Antenna Polarity (H/V)	Antenna HEIGHT (m)	Uncorrected Amplitude (dBuV)	Antenna Correction Factor (dB) (+)	Cable Loss (dB) (+)	Distance Correction Factor (dB) (-)	Corrected Amplitude (dBuV/m)	Limit (dBuV/m)	Margin (dB)
44.729459	188	H	1.42	16.03	10.96	0.23	10.46	16.76	30.00	-13.24
44.729459	54	V	1.25	16.03	10.96	0.23	10.46	16.76	30.00	-13.24
165.53106	268	H	1.62	16.48	12.50	0.23	10.46	18.75	30.00	-11.25
165.53106	63	V	1.55	16.48	12.50	0.23	10.46	18.75	30.00	-11.25
222.44489	176	H	1.71	12.73	11.45	0.23	10.46	13.95	30.00	-16.05
222.44489	30	V	1.02	12.73	11.45	0.23	10.46	13.95	30.00	-16.05
131.46293	213	H	1.06	16.48	13.65	0.23	10.46	19.90	30.00	-10.10
131.46293	12	V	1.69	16.26	13.65	0.23	10.46	19.68	30.00	-10.32
340.88176	313	H	1.02	13.06	14.84	0.83	10.46	18.27	37.00	-18.73
340.88176	0	V	1.28	13.06	14.84	0.83	10.46	18.27	37.00	-18.73
600	218	H	1.15	14.26	19.50	1.17	10.46	24.47	37.00	-12.53
600	41	V	1.71	14.26	19.50	1.17	10.46	24.47	37.00	-12.53

Table 9. Radiated Emissions Limits, Test Results, ICES-003

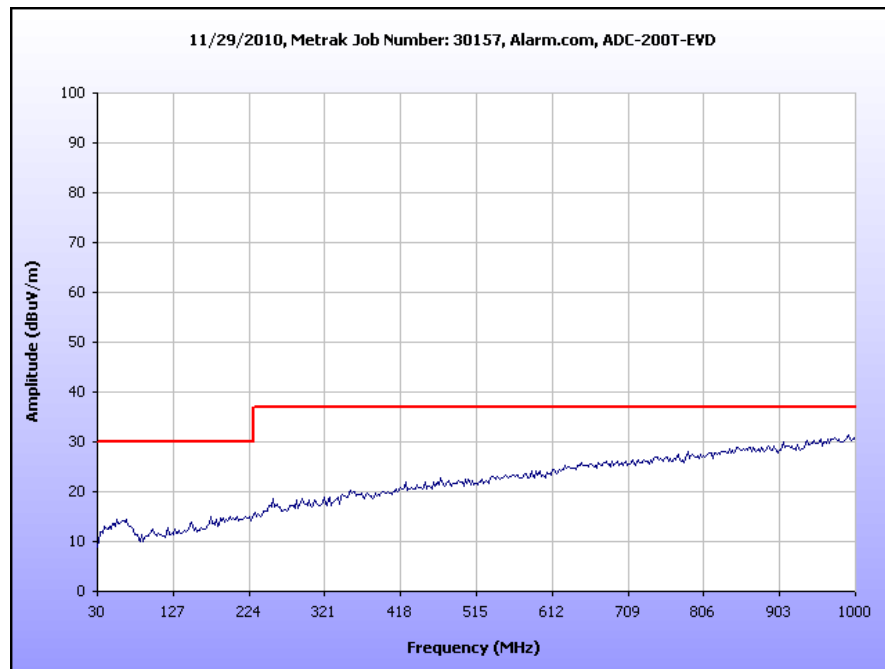

Plot 2. Radiated Emissions, Pre-Scan, 30 MHz – 1 GHz, ICES-003 Limits



Photograph 2. Radiated Emissions, Test Setup

IV. Electromagnetic Compatibility Criteria for Intentional Radiators

Electromagnetic Compatibility Criteria for Intentional Radiators

§ 15.203 Antenna Requirement

Test Requirement: § 15.203: An intentional radiator shall be designed to ensure that no antenna other than that furnished by the responsible party shall be used with the device. The use of a permanently attached antenna or of an antenna that uses a unique coupling to the intentional radiator shall be considered sufficient to comply with the provisions of this section. The manufacturer may design the unit so that a broken antenna can be replaced by the user, but the use of a standard antenna jack or electrical connector is prohibited.

The structure and application of the EUT were analyzed to determine compliance with Section 15.203 of the Rules. Section 15.203 states that the subject device must meet at least one of the following criteria:

- a.) Antenna must be permanently attached to the unit.
- b.) Antenna must use a unique type of connector to attach to the EUT.
- c.) Unit must be professionally installed. Installer shall be responsible for verifying that the correct antenna is employed with the unit.

Results: The EUT is compliant with §15.203. The device has an integral antenna.

Test Engineer(s): Manasi Bhandiwad

Test Date(s): 12/01/10

Electromagnetic Compatibility Criteria for Intentional Radiators

§ 15.207 Conducted Emissions Limits

Test Requirement(s): § 15.207 (a): For an intentional radiator that is designed to be connected to the public utility (AC) power line, the radio frequency voltage that is conducted back onto the AC power line on any frequency or frequencies, within the band 150 kHz to 30MHz, shall not exceed the limits in the following table, as measured using a 50 μ H/50 Ω line impedance stabilization network (LISN). Compliance with the provisions of this paragraph shall be based on the measurement of the radio frequency voltage between each power line and ground at the power terminal. The lower limit applies at the boundary between the frequency ranges.

Frequency range (MHz)	§ 15.207(a), Conducted Limit (dB μ V)	
	Quasi-Peak	Average
* 0.15- 0.45	66 - 56	56 - 46
0.45 - 0.5	56	46
0.5 - 30	60	50

Table 10. Conducted Limits for Intentional Radiators from FCC Part 15 § 15.207(a)

Test Procedure: The EUT was placed on a 0.8 m-high wooden table inside a screen room. The EUT was situated such that the back of the EUT was 0.4 m from one wall of the vertical ground plane, and the remaining sides of the EUT were no closer than 0.8 m from any other conductive surface. The EUT was powered from a 50 Ω /50 μ H Line Impedance Stabilization Network (LISN). The EMC receiver scanned the frequency range from 150 kHz to 30 MHz. Conducted Emissions measurements were made in accordance with *ANSI C63.4-2003 "Methods and Measurements of Radio-Noise Emissions from Low-Voltage Electrical and Electronic Equipment in the Range of 9kHz to 40 GHz"*. The measurements were performed over the frequency range of 0.15 MHz to 30 MHz using a 50 Ω /50 μ H LISN as the input transducer to an EMC/field intensity meter. For the purposes of testing, the radio transmitter was turned on. The radio has two different data rates, 9.6 kBPS and 40 kBPS. Both data rates were pre scanned and tabular data was taken for the worst case.

Test Results: The EUT was not applicable with this requirement. The EUT is battery operated.

Electromagnetic Compatibility Criteria for Intentional Radiators

§ 15.249(a) Radiated Field Strength of Fundamental

Test Requirements: § 15.249(a): The 3 meter field strength of the fundamental emissions from intentional radiators operated within the 902 – 928 MHz frequency bands shall comply with the following requirement: 50 millivolts/meter (94dB μ V/m), quasi-peak mode measurement.

Test Procedure: Measurements were performed with the EUT rotated 360 degrees and varying the adjustable antenna mast with 1 m to 4 m height to determine worst case orientation for maximum emissions. The antenna was placed 3m away from the EUT.

Measurements were made using a peak detector.

The plot shows the worst case emission. The plot is corrected for both antenna correction factor and cable loss and represents a field strength in dBuV/m at 3 meters.

Test Results The EUT is compliant with the requirements of § 15.249(a).

Test Engineer(s): Manasi Bhandiwad

Test Date(s): 11/30/10

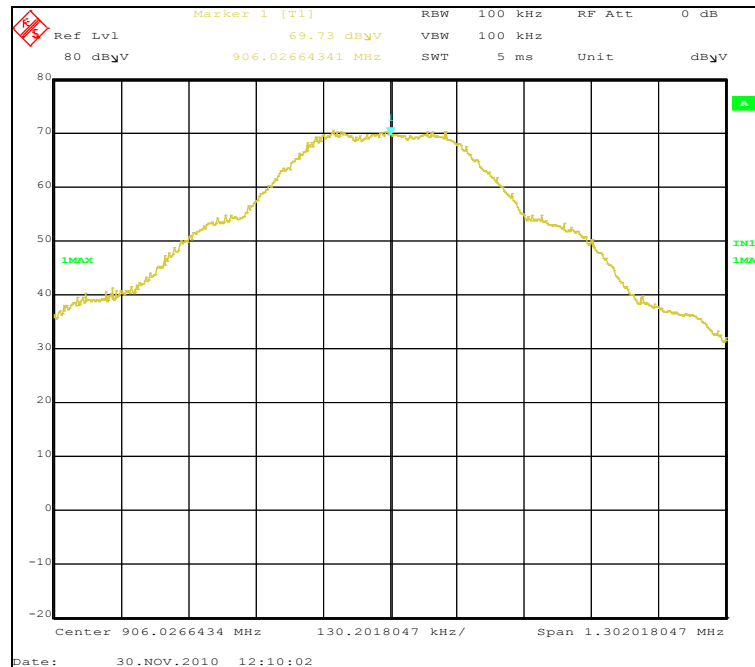

Plot 3. Fundamental Field Strength, Low Channel, Peak Detector

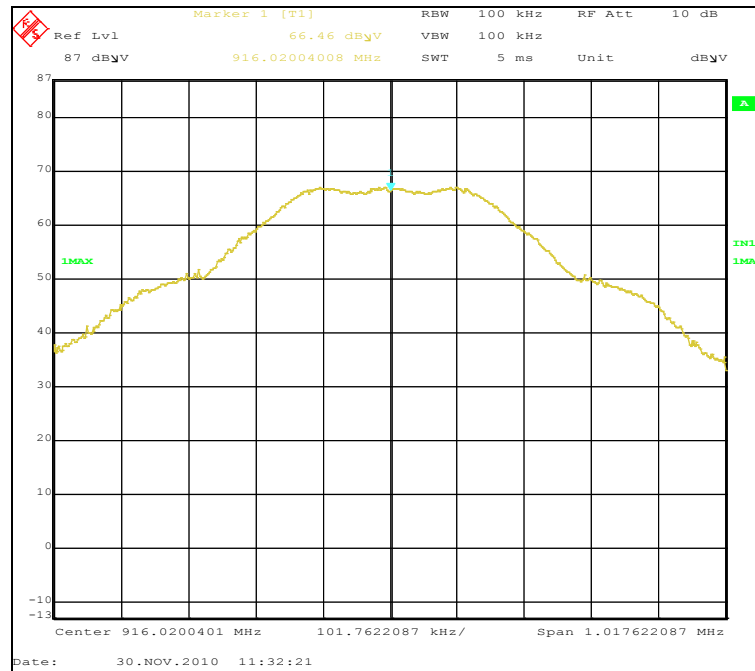

Plot 4. Fundamental Field Strength, Mid Channel, Peak Detector

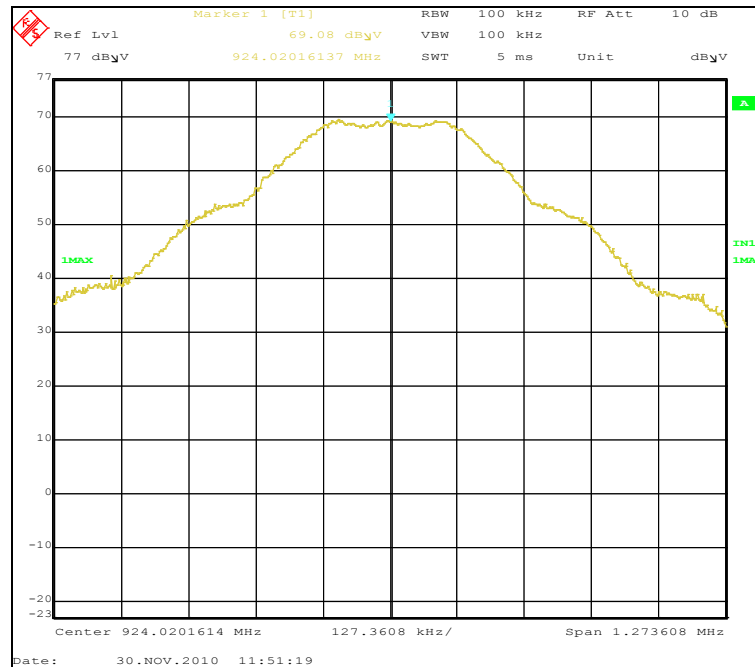

Plot 5. Fundamental Field Strength, High Channel, Peak Detector

Electromagnetic Compatibility Criteria for Intentional Radiators

20 dB and 99% Bandwidth

Test Procedure: The 20 dB and 99% Bandwidth was measured and recorded.

Test Results See the following plots.

Test Engineer(s): Manasi Bhandiwad

Test Date(s): 11/30/10

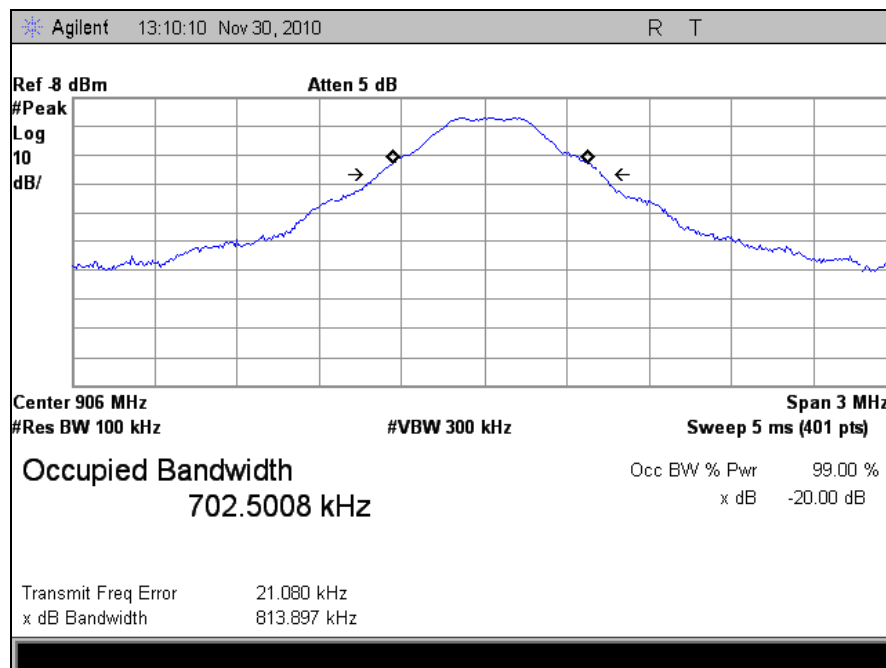

Plot 6. Occupied Bandwidth, Low Channel FCC Limits

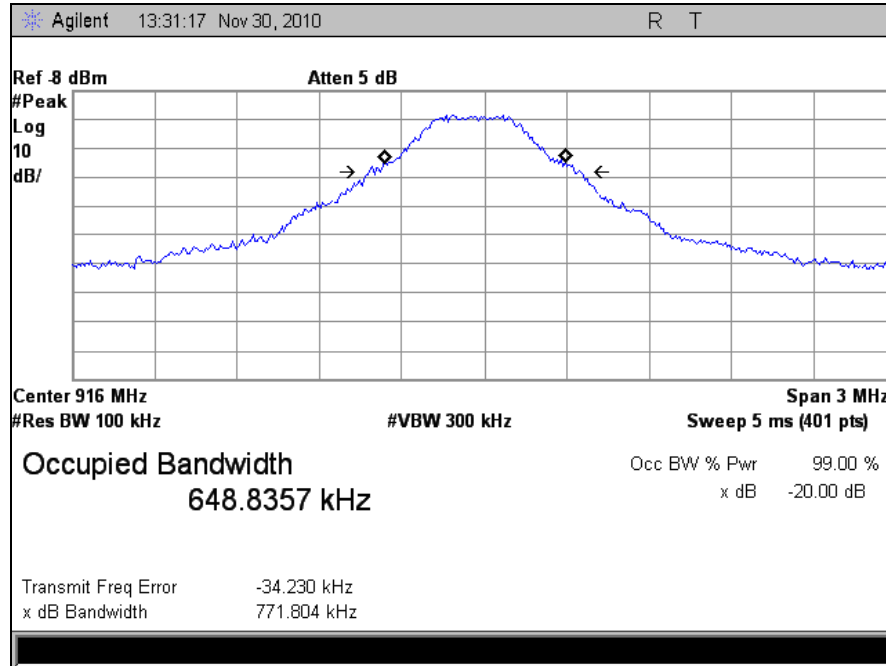

Plot 7. Occupied Bandwidth, Mid Channel FCC Limits

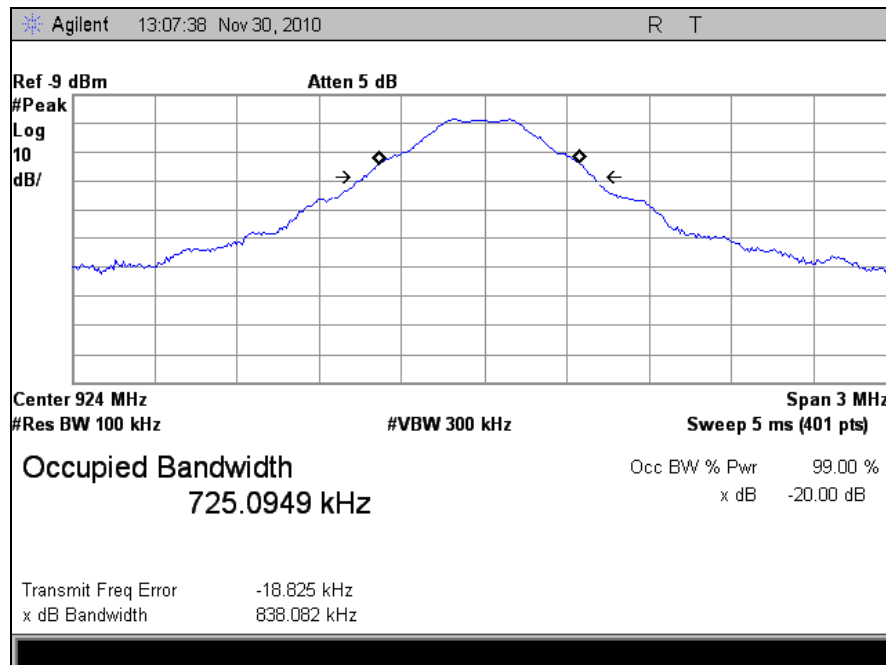

Plot 8. Occupied Bandwidth, High Channel FCC Limits

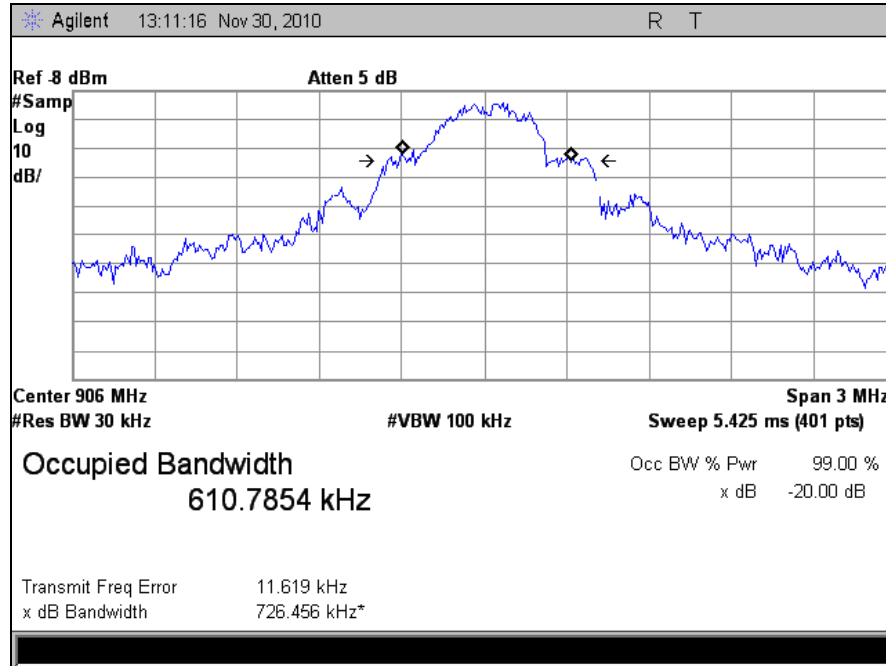

Plot 9. Occupied Bandwidth, Low Channel, IC Limits

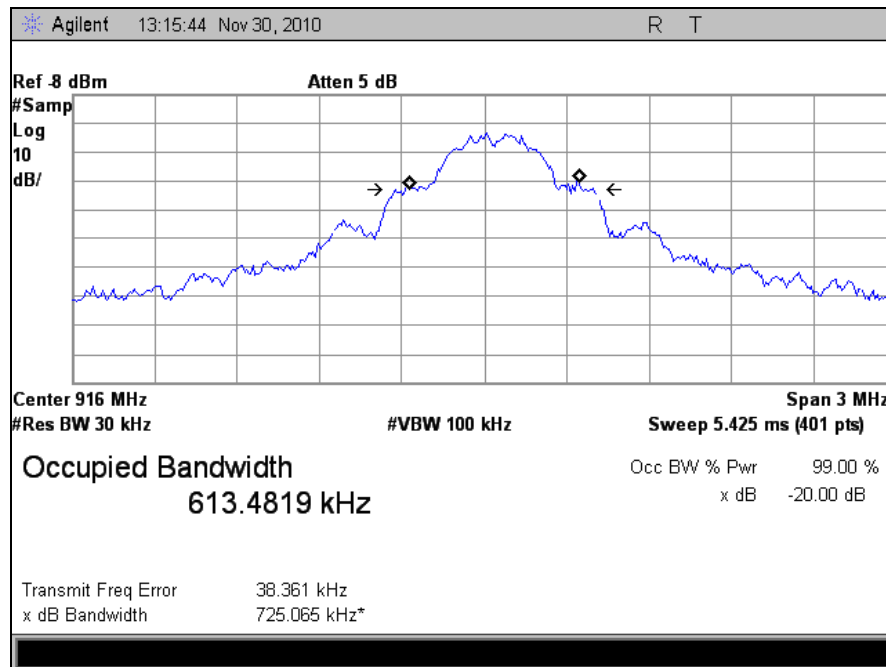

Plot 10. Occupied Bandwidth, Mid Channel, IC Limits

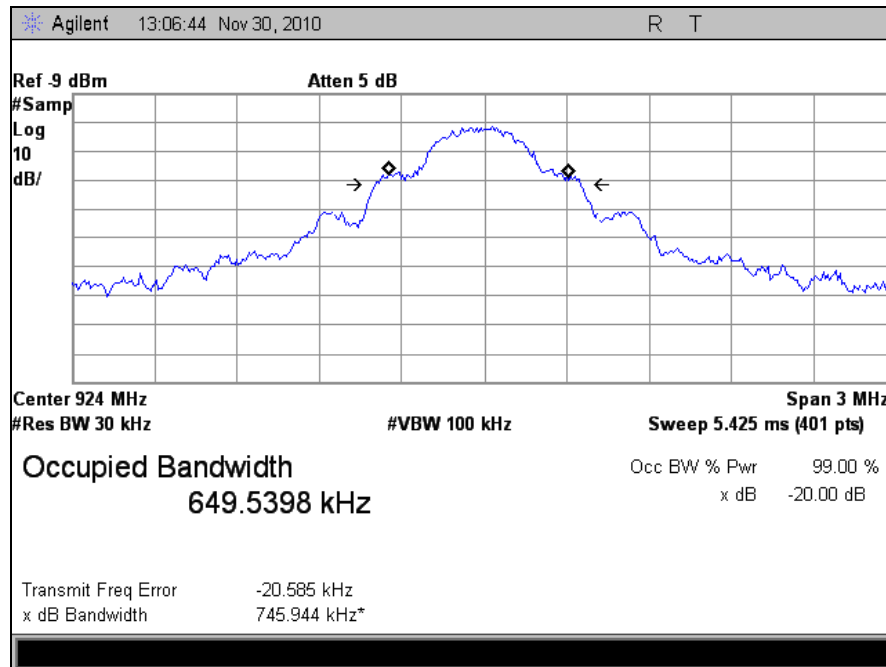

Plot 11. Occupied Bandwidth, High Channel, IC Limits

Electromagnetic Compatibility Criteria for Intentional Radiators

§ 15.249(a)(d) Harmonics and Spurious Emissions Requirements

Test Requirements: Harmonics originating from devices that operate in the 902-928 MHz band shall meet the 500 microvolts/meter limit (i.e. 54 dBuV/m) with an average detector. In addition, emissions radiated outside of the specified frequency bands, except for harmonics, shall be attenuated by at least 50 dB below the level of the fundamental or to the general radiated emission limits in § 15.209, whichever is the lesser attenuation.

Test Procedure: Measurements were performed with the EUT rotated 360 degrees and varying the adjustable antenna mast with 1 m to 4 m height to determine worst case orientation for maximum emissions. Emissions below 1 GHz were performed with the antenna placed 3m away from EUT. For above 1 GHz, the measuring antenna was placed 1m away.

Test Results: The EUT is compliant with the harmonics and Spurious Emissions Requirements of § 15.249(a)(d). For spurious emissions the lesser attenuation was the 15.209 limits.

Test Engineer(s): Manasi Bhandiwad

Test Date(s): 11/30/10

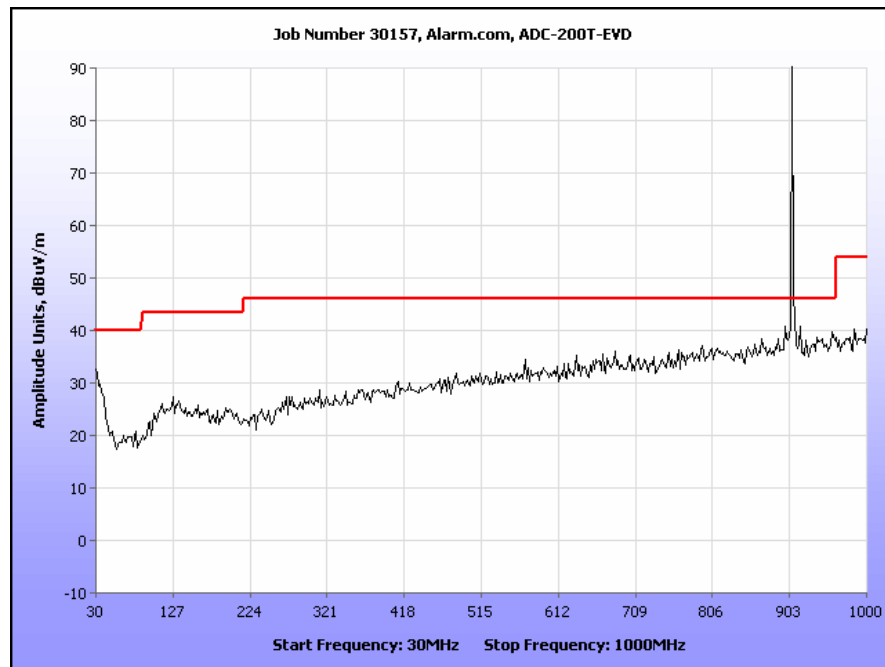

Plot 12. Radiated Spurious Emissions, Low Channel, 30 MHz – 1 GHz

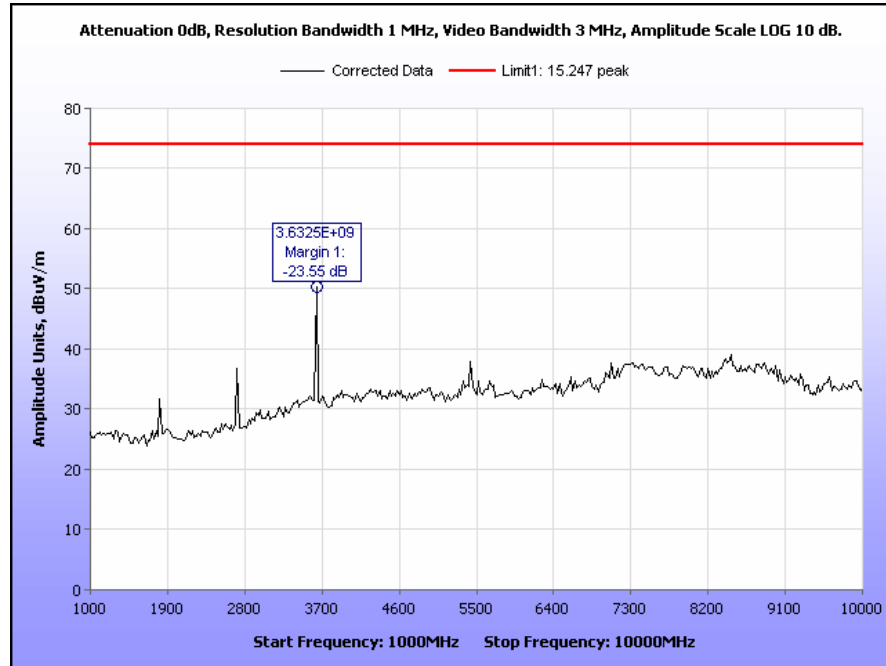

Plot 13. Radiated Spurious Emissions, Low Channel, Peak

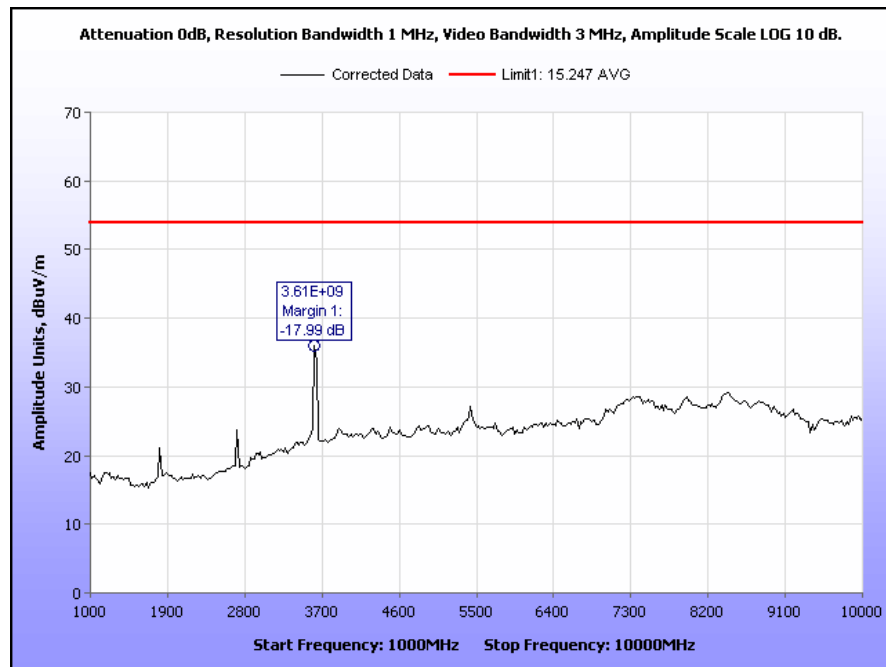

Plot 14. Radiated Spurious Emissions, Low Channel, Average

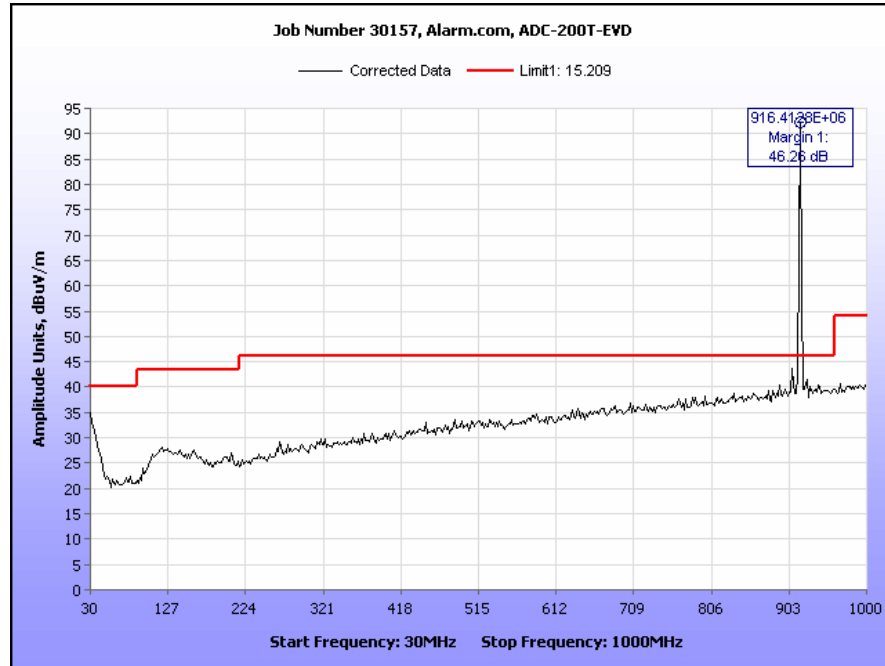

Plot 15. Radiated Spurious Emissions, Mid Channel, 30 MHz – 1 GHz

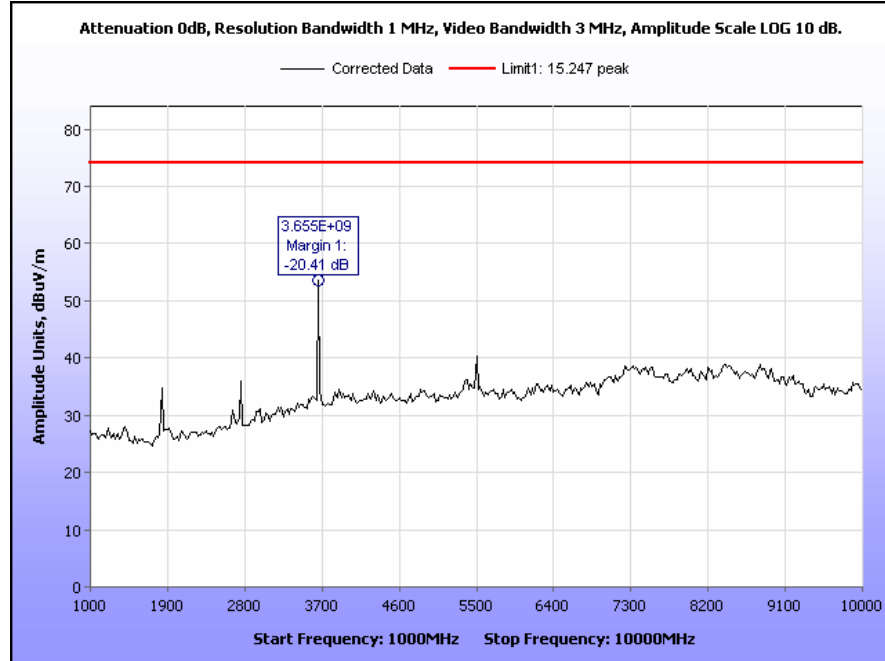

Plot 16. Radiated Spurious Emissions, Mid Channel, Peak

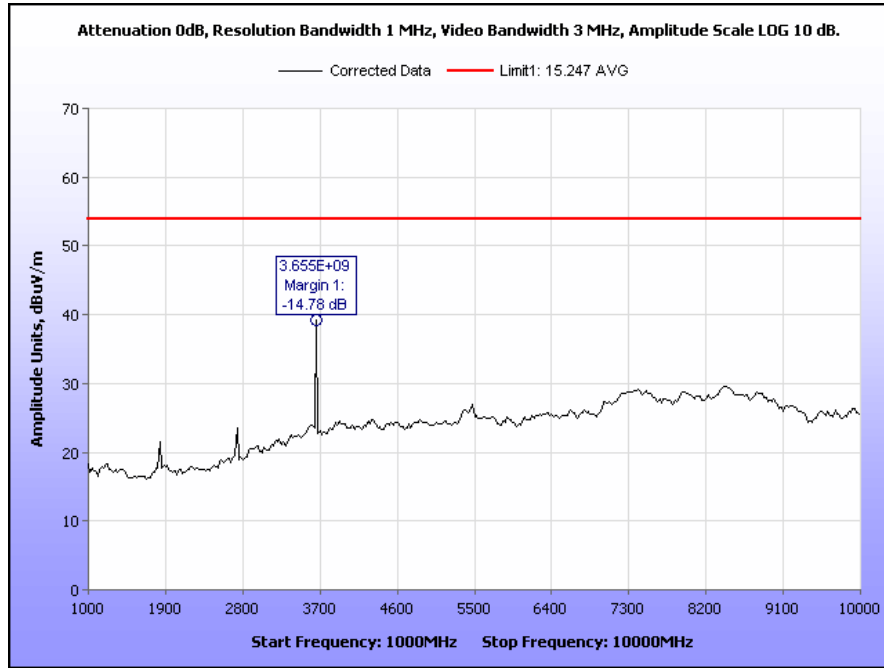

Plot 17. Radiated Spurious Emissions, Mid Channel, Average

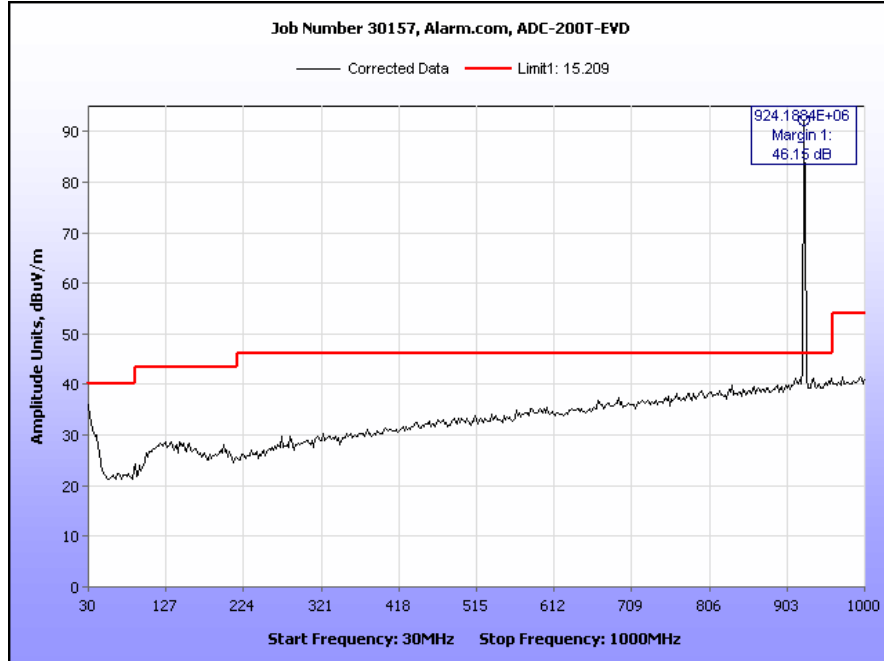

Plot 18. Radiated Spurious Emissions, High Channel, 30 MHz – 1 GHz

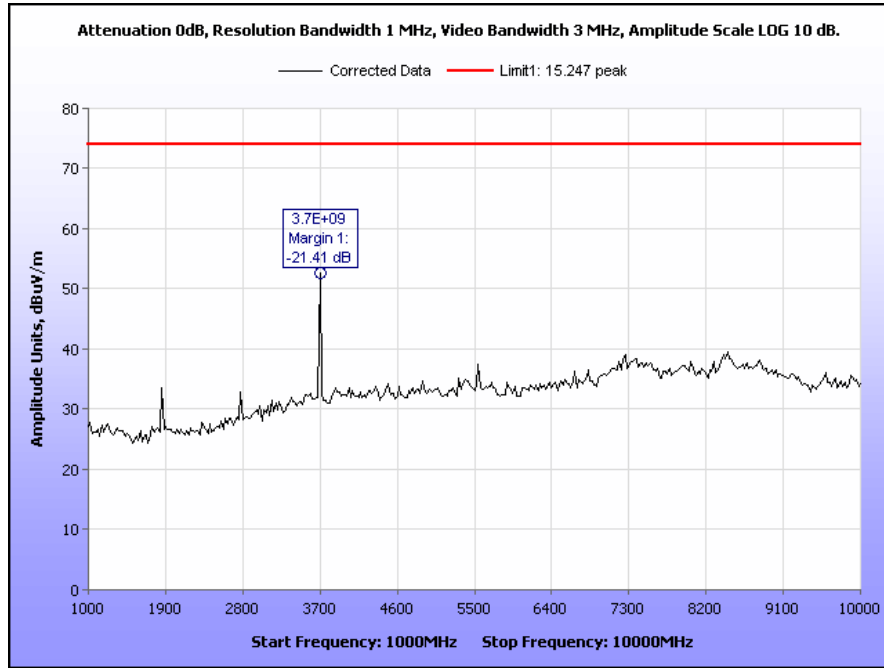

Plot 19. Radiated Spurious Emissions, High Channel, Peak

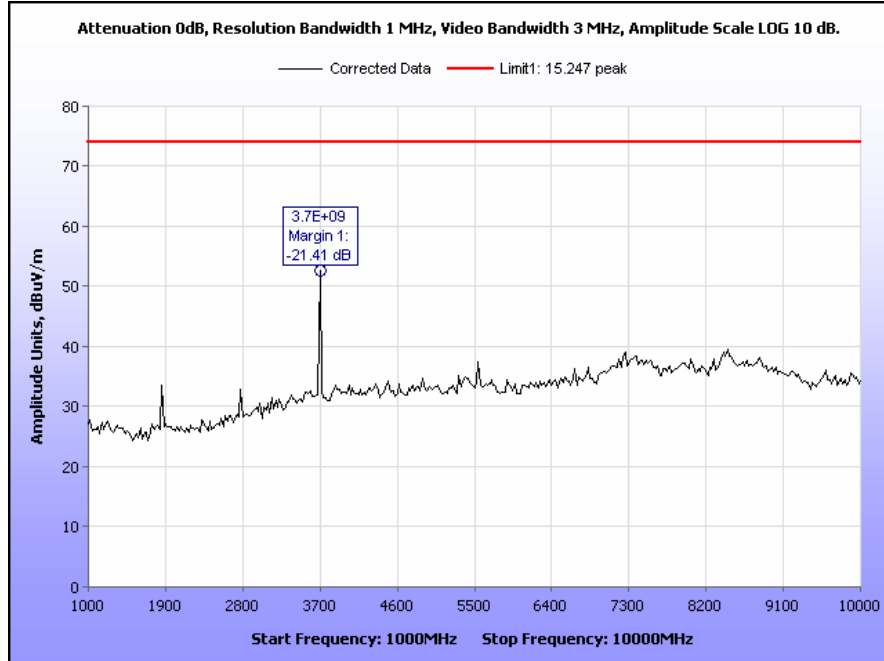

Plot 20. Radiated Spurious Emissions, High Channel, Average

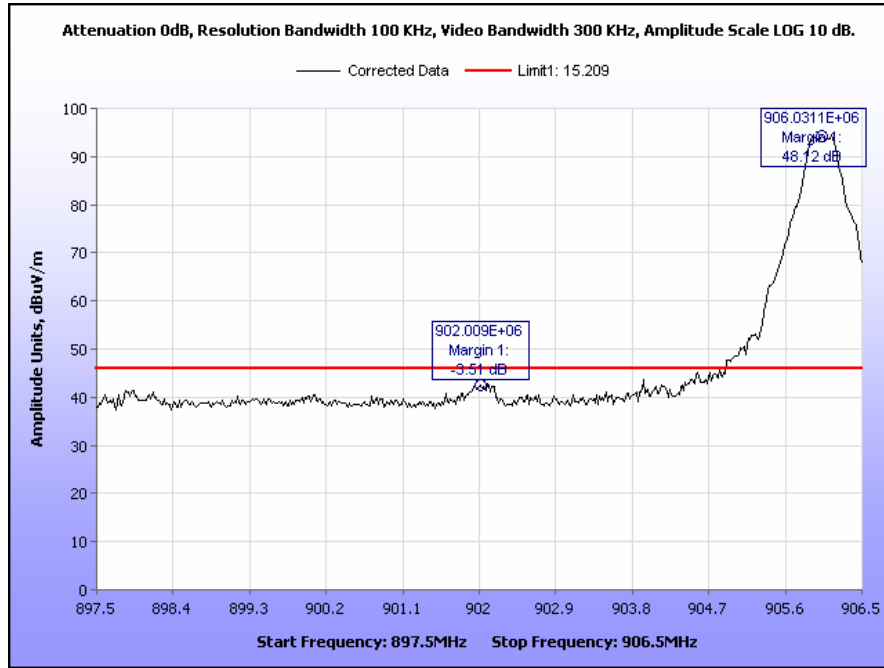

Plot 21. Band Edge, Low Channel

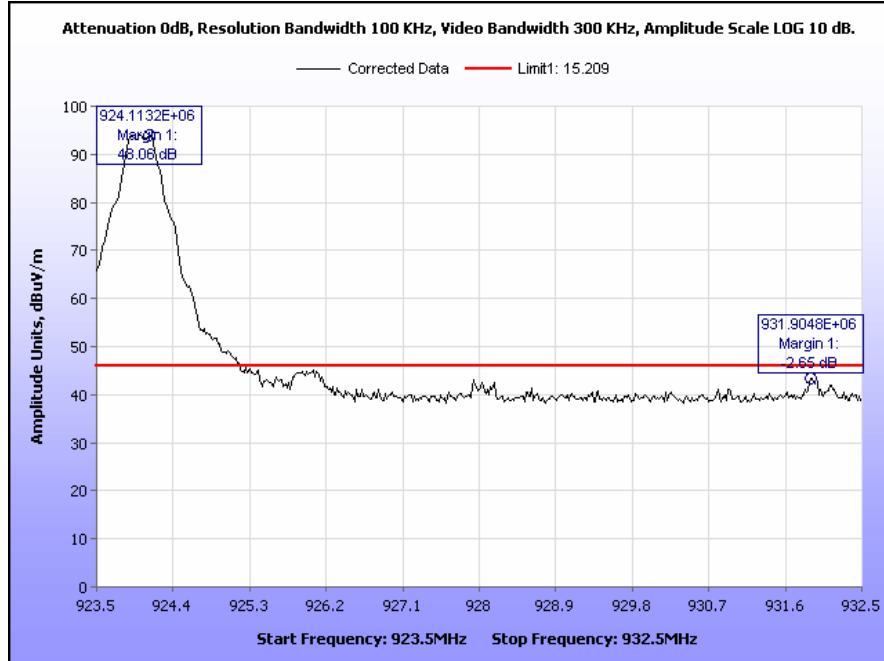

Plot 22. Band Edge, High Channel

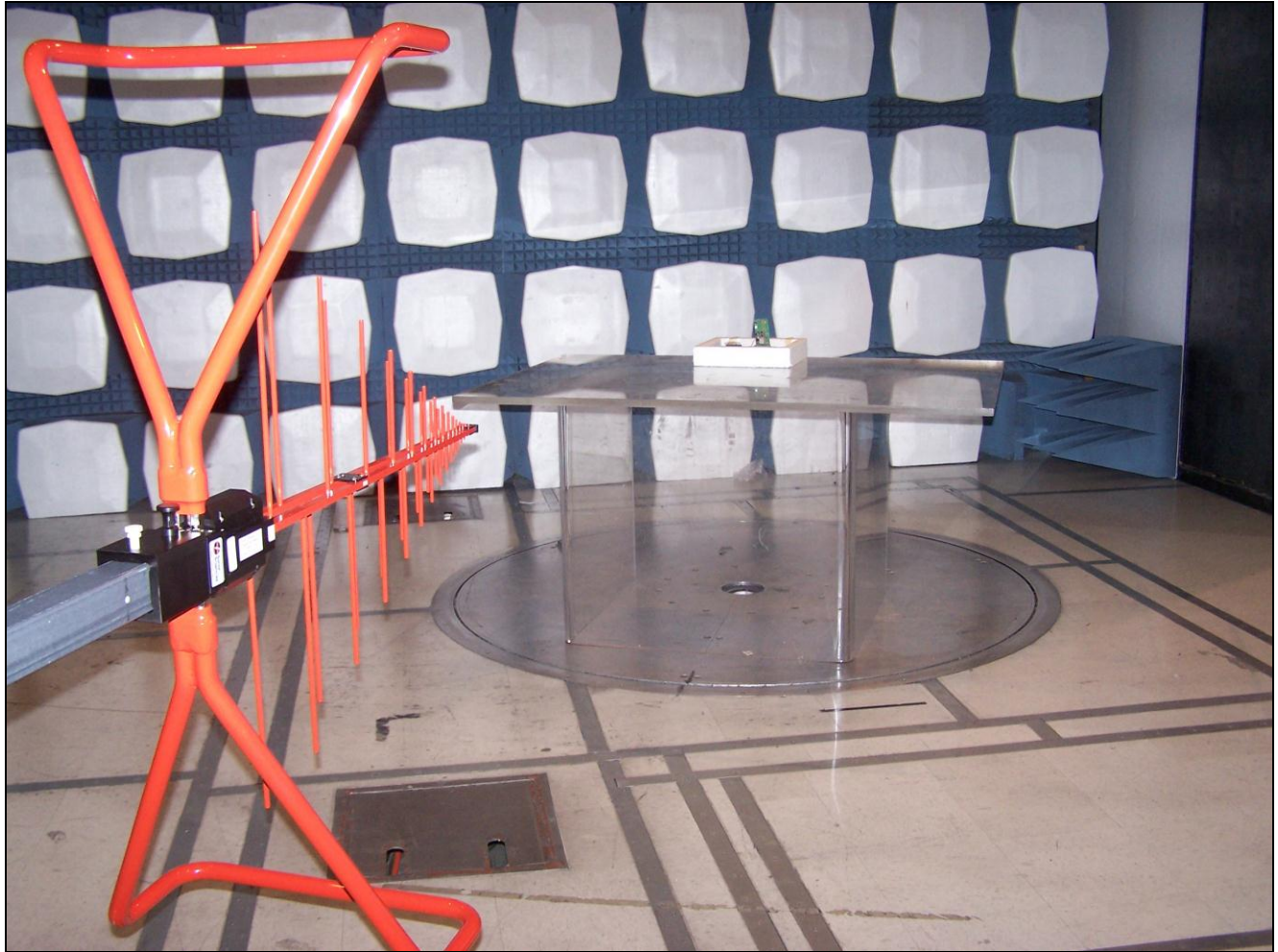

Photograph 3. Transceiver Spurious Emissions, Test Setup

Electromagnetic Compatibility Criteria for Intentional Radiators

RSS-GEN Receiver Spurious Emissions Requirements

Test Requirements: The following receiver spurious emission limits shall be complied with:

- (a) If a radiated measurement is made, all spurious emissions shall comply with the limits of Table 11.

Spurious Frequency (MHz)	Field Strength (microvolt/m at 3 metres)
30 – 88	100
88 – 216	150
216 – 960	200
Above 960	500

Table 11. Spurious Emission Limits for Receivers

Test Procedures: 100 kHz resolution bandwidth was used from 30 MHz - 1 GHz and 1 MHz resolution was used for measurements done above 1 GHz. All plots are corrected for cable loss, antenna correction factor, and pre-amp gain.

Test Results: Equipment is compliant with the Receiver Spurious Emissions Requirements of RSS-GEN.

Test Engineer(s): Manasi Bhandiwad

Test Date(s): 12/01/10

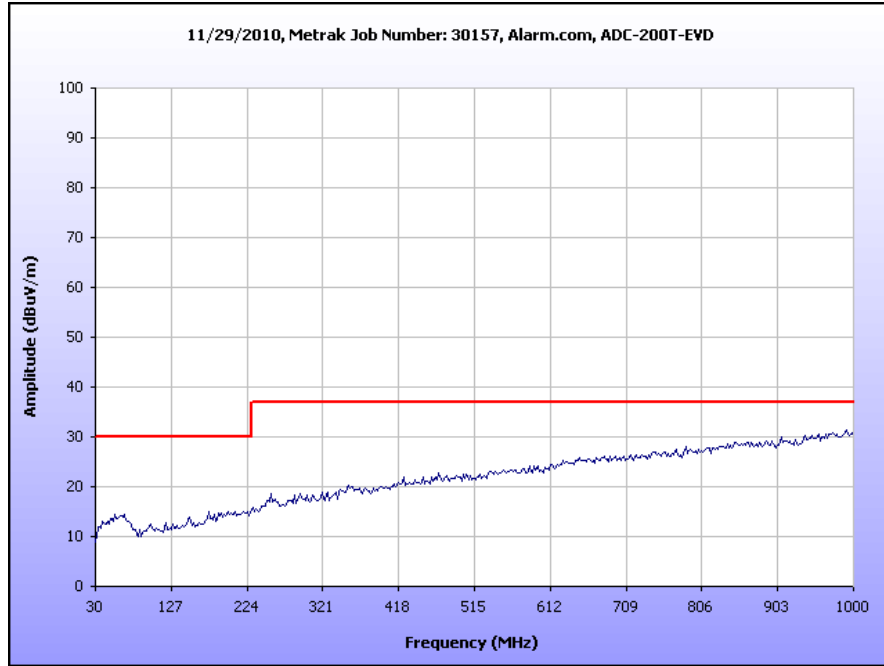

Plot 23. Receiver Spurious Emission, 30 MHz – 1 GHz

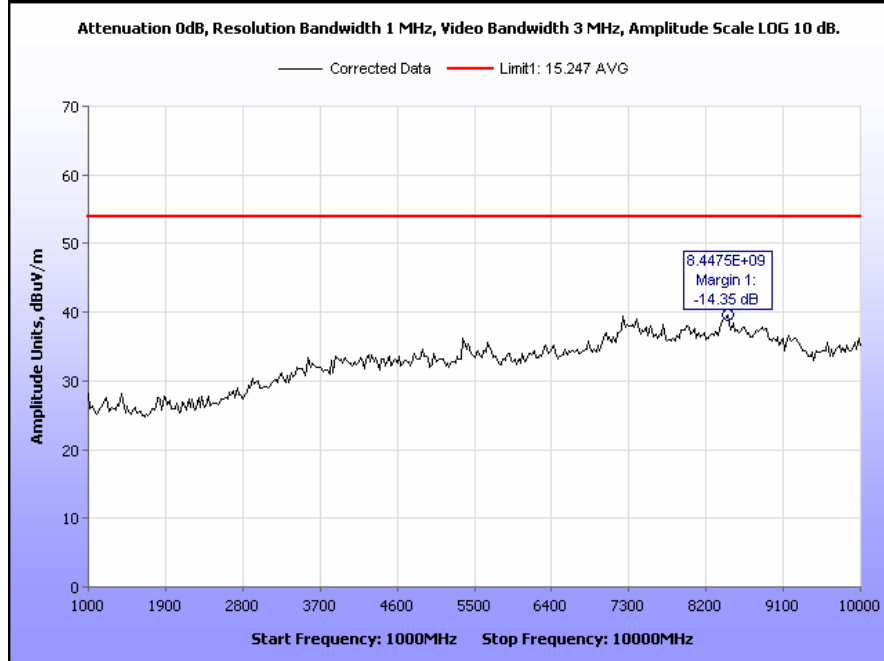

Plot 24. Receiver Spurious Emission, 1 GHz – 10 GHz, Peak

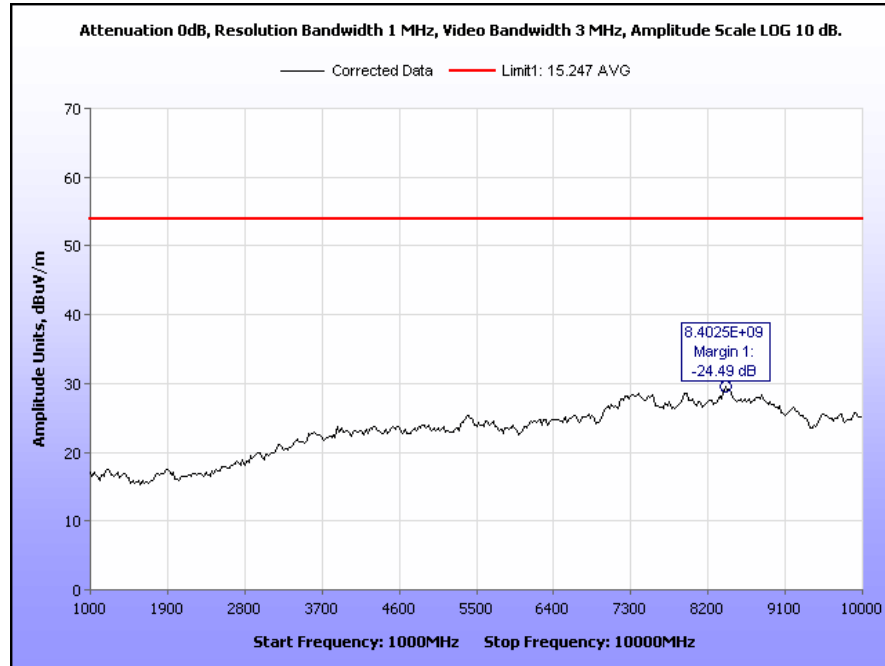

Plot 25. Receiver Spurious Emission, 1 GHz – 10 GHz, Average

IV. Test Equipment

Test Equipment

Calibrated test equipment utilized during testing was maintained in a current state of calibration per the requirements of ANSI/NCSL Z540-1-1994 and ANSI/ISO/IEC 17025:2000.

MET Asset #	Equipment	Manufacturer	Model	Last Cal Date	Cal Due Date
1T4300	SEMI-ANECHOIC CHAMBER # 1	EMC TEST SYSTEMS	NONE	08/23/2010	08/23/2013
1T4751	ANTENNA - BILOG	SUNOL SCIENCES	JB6	11/03/2010	11/03/2011
1T4409	EMI RECEIVER	ROHDE & SCHWARZ	ESIB7	05/25/2010	05/25/2011
1T4627	THERMO/HYGROMETER	CONTROL COMPANY	S6-627-9	10/09/2009	10/09/2011
1T4568	RADIATING NOISE SOURCE	MET LABORATORIES	N/A	SEE NOTE	

Note: Functionally tested equipment is verified using calibrated instrumentation at the time of testing.



V. Certification & User's Manual Information



Certification & User's Manual Information

A. Certification Information

The following is extracted from Title 47 of the Code of Federal Regulations, Part 2, Subpart I — Marketing of Radio frequency devices:

§ 2.801 Radio-frequency device defined.

As used in this part, a radio-frequency device is any device which in its operation is capable of Emitting radio-frequency energy by radiation, conduction, or other means. Radio- frequency devices include, but are not limited to:

- (a) The various types of radio communication transmitting devices described throughout this chapter.
- (b) *The incidental, unintentional and intentional radiators defined in Part 15 of this chapter.*
- (c) The industrial, scientific, and medical equipment described in Part 18 of this chapter.
- (d) Any part or component thereof which in use emits radio-frequency energy by radiation, conduction, or other means.

§ 2.803 Marketing of radio frequency devices prior to equipment authorization.

- (a) Except as provided elsewhere in this chapter, no person shall sell or lease, or offer for sale or lease (including advertising for sale or lease), or import, ship or distribute for the purpose of selling or leasing or offering for sale or lease, any radio frequency device unless:
 - (1) In the case of a device subject to certification, such device has been authorized by the Commission in accordance with the rules in this chapter and is properly identified and labeled as required by §2.925 and other relevant sections in this chapter; or
 - (2) In the case of a device that is not required to have a grant of equipment authorization issued by the Commission, but which must comply with the specified technical standards prior to use, such device also complies with all applicable administrative (including verification of the equipment or authorization under a Declaration of Conformity, where required), technical, labeling and identification requirements specified in this chapter.
- (d) Notwithstanding the provisions of paragraph (a) of this section, the offer for sale solely to business, commercial, industrial, scientific or medical users (but not an offer for sale to other parties or to end users located in a residential environment) of a radio frequency device that is in the conceptual, developmental, design or pre-production stage is permitted prior to equipment authorization or, for devices not subject to the equipment authorization requirements, prior to a determination of compliance with the applicable technical requirements *provided* that the prospective buyer is advised in writing at the time of the offer for sale that the equipment is subject to the FCC rules and that the equipment will comply with the appropriate rules before delivery to the buyer or to centers of distribution.



- (e)(1) Notwithstanding the provisions of paragraph (a) of this section, prior to equipment authorization or determination of compliance with the applicable technical requirements any radio frequency device may be operated, but not marketed, for the following purposes and under the following conditions:
- (i) *Compliance testing;*
 - (ii) Demonstrations at a trade show provided the notice contained in paragraph (c) of this section is displayed in a conspicuous location on, or immediately adjacent to, the device;
 - (iii) Demonstrations at an exhibition conducted at a business, commercial, industrial, scientific or medical location, but excluding locations in a residential environment, provided the notice contained in paragraphs (c) or (d) of this section, as appropriate, is displayed in a conspicuous location on, or immediately adjacent to, the device;
 - (iv) Evaluation of product performance and determination of customer acceptability, provided such operation takes place at the manufacturer's facilities during developmental, design or pre-production states; or
 - (v) Evaluation of product performance and determination of customer acceptability where customer acceptability of a radio frequency device cannot be determined at the manufacturer's facilities because of size or unique capability of the device, provided the device is operated at a business, commercial, industrial, scientific or medical user's site, but not at a residential site, during the development, design or pre-production stages.
- (e)(2) For the purpose of paragraphs (e)(1)(iv) and (e)(1)(v) of this section, the term *manufacturer's facilities* includes the facilities of the party responsible for compliance with the regulations and the manufacturer's premises, as well as the facilities of other entities working under the authorization of the responsible party in connection with the development and manufacture, but not the marketing, of the equipment.
- (f) For radio frequency devices subject to verification and sold solely to business, commercial, industrial, scientific and medical users (excluding products sold to other parties or for operation in a residential environment), parties responsible for verification of the devices shall have the option of ensuring compliance with the applicable technical specifications of this chapter at each end user's location after installation, provided that the purchase or lease agreement includes a proviso that such a determination of compliance be made and is the responsibility of the party responsible for verification of the equipment.



Certification & User's Manual Information

The following is extracted from Title 47 of the Code of Federal Regulations, Part 2, Subpart J — Equipment Authorization Procedures:

§ 2.901 Basis and Purpose

- (a) In order to carry out its responsibilities under the Communications Act and the various treaties and international regulations, and in order to promote efficient use of the radio spectrum, the Commission has developed technical standards for radio frequency equipment and parts or components thereof. The technical standards applicable to individual types of equipment are found in that part of the rules governing the service wherein the equipment is to be operated.¹ *In addition to the technical standards provided, the rules governing the service may require that such equipment be verified by the manufacturer or importer, be authorized under a Declaration of Conformity, or receive an equipment authorization from the Commission by one of the following procedures: certification or registration.*
- (b) The following sections describe the verification procedure, the procedure for a Declaration of Conformity, and the procedures to be followed in obtaining certification from the Commission and the conditions attendant to such a grant.

§ 2.907 Certification.

- (a) Certification is an equipment authorization issued by the Commission, based on representation and test data submitted by the applicant.
- (b) Certification attaches to all units subsequently marketed by the grantee which are identical (see Section 2.908) to the sample tested except for permissive changes or other variations authorized by the Commission pursuant to Section 2.1043.

¹ In this case, the equipment is subject to the rules of Part 15. More specifically, the equipment falls under Subpart B (of Part 15), which deals with unintentional radiators.



Certification & User's Manual Information

§ 2.948 Description of measurement facilities.

- (a) Each party making measurements of equipment that is subject to an equipment authorization under Part 15 or Part 18 of this chapter, regardless of whether the measurements are filed with the Commission or kept on file by the party responsible for compliance of equipment marketed within the U.S. or its possessions, shall compile a description of the measurement facilities employed.
 - (1) If the measured equipment is subject to the verification procedure, the description of the measurement facilities shall be retained by the party responsible for verification of the equipment.
 - (i) *If the equipment is verified through measurements performed by an independent laboratory, it is acceptable for the party responsible for verification of the equipment to rely upon the description of the measurement facilities retained by or placed on file with the Commission by that laboratory. In this situation, the party responsible for the verification of the equipment is not required to retain a duplicate copy of the description of the measurement facilities.*
 - (ii) If the equipment is verified based on measurements performed at the installation site of the equipment, no specific site calibration data is required. It is acceptable to retain the description of the measurement facilities at the site at which the measurements were performed.
 - (2) If the equipment is to be authorized by the Commission under the certification procedure, the description of the measurement facilities shall be filed with the Commission's Laboratory in Columbia, Maryland. The data describing the measurement facilities need only be filed once but must be updated as changes are made to the measurement facilities or as otherwise described in this section. At least every three years, the organization responsible for filing the data with the Commission shall certify that the data on file is current.



Certification & User's Manual Information

Label and User's Manual Information

The following is extracted from Title 47 of the Code of Federal Regulations, Part 15, Subpart A — General:

§ 15.19 Labeling requirements.

(a) *In addition to the requirements in Part 2 of this chapter, a device subject to certification or verification shall be labeled as follows:*

- (1) Receivers associated with the operation of a licensed radio service, e.g., FM broadcast under Part 73 of this chapter, land mobile operation under Part 90, etc., shall bear the following statement in a conspicuous location on the device:

This device complies with Part 15 of the FCC Rules. Operation is subject to the condition that this device does not cause harmful interference.

- (2) A stand-alone cable input selector switch, shall bear the following statement in a conspicuous location on the device:

This device is verified to comply with Part 15 of the FCC Rules for use with cable television service.

- (3) All other devices shall bear the following statement in a conspicuous location on the device:

This device complies with Part 15 of the FCC Rules. Operation is subject to the following two conditions: (1) This device may not cause harmful interference, and (2) this device must accept any interference received, including interference that may cause undesired operation.

- (4) Where a device is constructed in two or more sections connected by wires and marketed together, the statement specified under paragraph (a) of this section is required to be affixed only to the main control unit.

- (5) When the device is so small or for such use that it is not practicable to place the statement specified under paragraph (a) of this section on it, the information required by this paragraph shall be placed in a prominent location in the instruction manual or pamphlet supplied to the user or, alternatively, shall be placed on the container in which the device is marketed. However, the FCC identifier or the unique identifier, as appropriate, must be displayed on the device.

§ 15.21 Information to user.

The users manual or instruction manual for an intentional or unintentional radiator shall caution the user that changes or modifications not expressly approved by the party responsible for compliance could void the user's authority to operate the equipment.



Verification & User's Manual Information

The following is extracted from Title 47 of the Code of Federal Regulations, Part 15, Subpart B — Unintentional Radiators:

§ 15.105 Information to the user.

- (a) For a Class A digital device or peripheral, the instructions furnished the user shall include the following or similar statement, placed in a prominent location in the text of the manual:

Note: This equipment has been tested and found to comply with the limits for a Class A digital device, pursuant to Part 15 of the FCC Rules. These limits are designed to provide reasonable protection against harmful interference when the equipment is operated in a commercial environment. This equipment generates, uses, and can radiate radio frequency energy and, if not installed and used in accordance with the instruction manual, may cause harmful interference to radio communications. Operation of this equipment in a residential area is likely to cause harmful interference in which case the user will be required to correct the interference at own expense.

- (b) For a Class B digital device or peripheral, the instructions furnished the user shall include the following or similar statement, placed in a prominent location in the text of the manual:

Note: This equipment has been tested and found to comply with the limits for a Class B digital device, pursuant to Part 15 of the FCC Rules. These limits are designed to provide reasonable protection against harmful interference when the equipment is operated in a residential environment. This equipment generates, uses, and can radiate radio frequency energy and, if not installed and used in accordance with the instruction manual, may cause harmful interference to radio communications. However, there is no guarantee that interference will not occur in a particular installation. If this equipment does cause harmful interference to radio or television reception, which can be determined by turning the equipment off and on, the user is encouraged to try to correct the interference by one or more of the following measures:

- Reorient or relocate the receiving antenna.
- Increase the separation between the equipment and receiver.
- Connect the equipment into an outlet on a circuit different from that to which the receiver is connected.
- Consult the dealer or an experienced radio/TV technician for help.

ICES-003 Procedural & Labeling Requirements

From the Industry Canada Electromagnetic Compatibility Advisory Bulletin entitled, "Implementation and Interpretation of the Interference-Causing Equipment Standard for Digital Apparatus, ICES-003" (EMCAB-3, Issue 2, July 1995):

"At present, CISPR 22: 2002 and ICES technical requirements are essentially equivalent. Therefore, if you have CISPR 22: 2002 approval by meeting CISPR Publication 22, the only additional requirements are: to attach a note to the report of the test results for compliance, indicating that these results are deemed satisfactory evidence of compliance with ICES-003 of the Canadian Interference-Causing Equipment Regulations; to maintain these records on file for the requisite five year period; and to provide the device with a notice of compliance in accordance with ICES-003."

Procedural Requirements:

According to Industry Canada's Interference Causing Equipment Standard for Digital Apparatus ICES-003 Issue 4, February 2004:

- Section 6.1: A record of the measurements and results, showing the date that the measurements were completed, shall be retained by the manufacturer or importer for a period of at least five years from the date shown in the record and made available for examination on the request of the Minister.
- Section 6.2: A written notice indicating compliance must accompany each unit of digital apparatus to the end user. The notice shall be in the form of a label that is affixed to the apparatus. Where because of insufficient space or other constraints it is not feasible to affix a label to the apparatus, the notice may be in the form of a statement in the user's manual.

Labeling Requirements:

The suggested text for the notice, in English and in French, is provided below, from the Annex of ICES-003:

This Class [²] digital apparatus complies with Canadian ICES-003.

Cet appareil numérique de la classe [¹] est conforme à la norme NMB-003 du Canada.

² Insert either A or B but not both as appropriate for the equipment requirements.

End of Report