



Engineering Solutions & Electromagnetic Compatibility Services

**Certification Application Report
FCC Part 15.247 & Industry Canada RSS-247**

Test Lab: Rhein Tech Laboratories, Inc. Tel: 703-689-0368 360 Herndon Parkway Fax: 703-689-2056 Suite 1400 www.rheintech.com Herndon, VA 20170 E-Mail: atcbinfo@rheintech.com		Applicant: Alarm.com Tel: 703-584-7319 8281 Greensboro Drive Suite 100 Tysons, VA 22102	
FCC ID	YL6-143470L	Test Report Date	December 14, 2016
IC	9111A-143470L	RTL Work Order #	2016204
Model	ADC-470L	RTL Quote #	QRTL16-204A
American National Standard Institute	ANSI C63.10-2013: American National Standard of Procedures for Compliance Testing of Unlicensed Wireless Devices		
FCC Classification	DTS – Digital Transmission System		
FCC Rule Part(s)/Guidance	FCC Rules Part 15.247: Operation within the bands 902-928 MHz, 2400-2483.5 MHz and 5725-5850 MHz Direct Sequence System (10/01/2015)		
Industry Canada	RSS-247 Issue 1 Digital Transmission Systems (DTSs), Frequency Hopping Systems (FHSs) and Licence-Exempt Local Area Network (LE-LAN) Devices RSS-Gen Issue 4: General Requirements for Compliance of Radio Apparatus		
Digital Interface Information	Digital Interface was found to be compliant		
Frequency Range (MHz)	Output Power (W)*	Frequency Tolerance	Emission Designator
912 – 924	0.009	N/A	667KF1D

* power is peak conducted

I, the undersigned, hereby declare that the equipment tested and referenced in this report conforms to the identified standard(s) as described in this test report. No modifications were made to the equipment during testing in order to achieve compliance with these standards. Furthermore, there was no deviation from, additions to, or exclusions from, the applicable parts of FCC Part 2, FCC Part 15, Industry Canada RSS-247, RSS-Gen, and ANSI C63.10.

Signature: 

Date: December 14, 2016

Typed/Printed Name: Desmond A. Fraser

Position: President

This report may not be reproduced, except in full, without the written approval of Rhein Tech Laboratories, Inc. and Alarm.com. The test results relate only to the item(s) tested.

These test(s) are accredited under Rhein Tech Laboratories, Inc. ISO/IEC 17025 accreditation issued by ANAB. Refer to certificate and scope of accreditation AT-1445.

Table of Contents

1	General Information	5
1.1	Scope	5
1.2	Description of EUT	5
1.3	Test Facility	5
1.4	Related Submittal(s)/Grant(s)	5
1.5	Modifications	5
2	Test Information	6
2.1	Description of Test Modes	6
2.2	Exercising the EUT	6
2.3	Test Result Summary.....	6
2.4	Test System Details	7
2.5	Configuration of Tested System.....	8
3	Peak Output Power - 15.247(b)(3); IC RSS-247 5.4(4), RSS-Gen 6.12	9
3.1	Power Output Test Procedure.....	9
3.2	Peak Output Power Test Data	9
4	Peak Power Spectral Density – FCC 15.247(e); IC RSS-247 5.2(2)	10
4.1	Peak Spectral Density Test Procedure	10
4.2	Peak Spectral Density Test Data	10
5	Antenna Conducted Spurious Emissions – FCC 15.247(d), RSS-247 5.5	14
5.1	Antenna Conducted Spurious Emissions Test Procedure.....	14
5.2	Peak Output Power Test Data	14
6	Compliance with the Band Edge – FCC 15.247(d); RSS-247 5.5.....	17
6.1	Band Edge Test Procedure.....	17
6.2	Band Edge Test Results	18
6.2.1	Lower Band Edge.....	18
6.2.2	Upper Band Edge.....	19
7	Bandwidth – FCC 15.247(a)(2); RSS-247 5.2(1).....	20
7.1	6 dB Bandwidth Test Procedure	20
7.2	Bandwidth Test Results	20
8	Radiated Emissions - 15.209; RSS-247 2.2; RSS-Gen 6.13/7.1	24
8.1	Limits of Radiated Emissions Measurement.....	24
8.2	Radiated Emissions Measurement Test Procedure.....	24
8.3	Radiated Emissions Test Results	25
8.3.1	Unintentional Radiated Emissions Test Data.....	25
8.3.2	Spurious/Harmonics Radiated Emissions Test Data	26
9	AC Conducted Emissions - FCC 15.207; RSS-Gen 7.2.4: Conducted Limits.....	29
9.1	Site and Test Description	29
9.2	Test Limits.....	29
9.3	Conducted Emissions Test Data.....	30
10	Conclusion	34

Figure Index

Figure 2-1:	Configuration of System Under Test.....	8
-------------	---	---

Table Index

Table 2-1:	Channels Tested	6
Table 2-2:	Test Result Summary – FCC Part 15 Subpart C (Section 15.247) & IC.....	6
Table 2-3:	Equipment Under Test	7
Table 2-4:	Auxiliary Equipment Used	7
Table 3-1:	Peak Power Output Test Equipment.....	9
Table 3-2:	Peak Output Power Test Data	9
Table 4-1:	Peak Spectral Density Test Equipment.....	10
Table 4-2:	Peak Spectral Density Test Data	10
Table 5-1:	Antenna Conducted Spurious Emissions Test Equipment	14
Table 6-1:	Band Edge Test Equipment	17
Table 7-1:	6 dB Bandwidth Test Equipment.....	20
Table 7-2:	6 dB Bandwidth Test Data	20
Table 8-1:	Radiated Emissions Test Equipment	25
Table 8-2:	Radiated Emissions Test Data, Digital Unintentional Emissions	25
Table 8-3:	Radiated Emissions Spurious/Harmonics – 912 MHz – Peak Detector	26
Table 8-4:	Radiated Emissions Spurious/Harmonics – 912 MHz – Average Detector	26
Table 8-5:	Radiated Emissions Spurious/Harmonics – 918 MHz – Peak Detector	26
Table 8-6:	Radiated Emissions Spurious/Harmonics – 918 MHz – Average Detector	27
Table 8-7:	Radiated Emissions Spurious/Harmonics – 924 MHz – Peak Detector	27
Table 8-8:	Radiated Emissions Spurious/Harmonics – 924 MHz – Average Detector	27
Table 9-1:	Conducted Emissions Test Equipment	29

Plot Index

Plot 4-1:	Peak Spectral Density – 912 MHz	11
Plot 4-2:	Peak Spectral Density – 918 MHz	12
Plot 4-3:	Peak Spectral Density – 924 MHz	13
Plot 5-1:	Antenna Conducted Spurious Emissions – 912 MHz	14
Plot 5-2:	Antenna Conducted Spurious Emissions – 918 MHz	15
Plot 5-3:	Antenna Conducted Spurious Emissions – 924 MHz	16
Plot 6-1:	Lower Band Edge.....	18
Plot 6-2:	Upper Band Edge.....	19
Plot 7-1:	6 dB Bandwidth – 912 MHz.....	21
Plot 7-2:	6 dB Bandwidth – 918 MHz.....	22
Plot 7-3:	6 dB Bandwidth – 924 MHz.....	23
Plot 9-1:	Conducted Emissions - Phase - Receive Mode.....	30
Plot 9-2:	Conducted Emissions - Neutral - Receive Mode	31
Plot 9-3:	Conducted Emissions – Phase – Transmit Mode	32
Plot 9-4:	Conducted Emissions – Neutral – Transmit Mode.....	33
Plot 9-5:	Conducted Emissions – Telecom (Ethernet).....	34

Appendix Index

Appendix A:	FCC Part 1.1307, 1.1310, 2.1091, 2.1093; IC RSS-Gen: RF Exposure	35
Appendix B:	ACB Agency Authorization Letter.....	36
Appendix C:	FCC & IC Confidentiality Request Letter.....	37
Appendix D:	IC Letters.....	38
Appendix E:	Canadian-Based Representative Attestation	39
Appendix F:	Label and Label Location	40
Appendix G:	Technical Operational Description	41
Appendix H:	Schematics.....	42
Appendix I:	Block Diagram	43
Appendix J:	Manual.....	44
Appendix K:	Test Photographs.....	45
Appendix L:	External Photographs.....	49
Appendix M:	Internal Photographs	53

Photograph Index

Photograph 1:	ID Label & Location	40
Photograph 2:	Radiated Emissions Testing – Front View (Digital Emissions, <1 GHz)	45
Photograph 3:	Radiated Emissions Testing – Back View (Digital Emissions, <1 GHz)	46
Photograph 4:	Radiated Emissions Testing – Front View (Spurious Emissions, >1 GHz).....	47
Photograph 5:	Conducted Emissions Testing.....	48
Photograph 6:	Module Top View.....	49
Photograph 7:	Module Bottom View	50
Photograph 8:	Module Top View – No Shields	51
Photograph 9:	Module Bottom View – No Shields.....	52
Photograph 10:	Module Top View.....	53
Photograph 11:	Module Bottom View	54
Photograph 12:	Module Top View – No Shields	55
Photograph 13:	Module Bottom View – No Shields.....	56

1 General Information

1.1 Scope

This is an original FCC and Industry Canada certification application request for modular approval.

1.2 Description of EUT

Equipment Under Test	Multisensor Transceiver
Model	ADC-470L
Power Supply	9-12VDC
Modulation Type	BPSK
Frequency Range	912-924 MHz
Antenna Type	Copper Wire Monopole

1.3 Test Facility

The open area test site and conducted measurement facility used to collect the radiated data is located at 360 Herndon Parkway, Suite 1400, Herndon, Virginia 20170. This site has been fully described in a report and approved by the Federal Communications Commission to perform AC line conducted and radiated emissions testing.

1.4 Related Submittal(s)/Grant(s)

This is an original application for Modular Approval for Alarm.com Model ADC-470L, FCC ID: YL6-143470L, IC: 9111A-143470L.

1.5 Modifications

No modifications were made to the equipment during testing.

2 Test Information

2.1 Description of Test Modes

In accordance with FCC 15.31(m), and because the EUT utilizes an operating band greater than 10 MHz, the following frequencies were tested.

Table 2-1: Channels Tested

Channel	Frequency
Low	912
Middle	918
High	924

2.2 Exercising the EUT

The EUT was supplied with a switch to change channels to a high, mid, and low channel for testing. The EUT was tested in all three orthogonal planes in order to determine worst-case emissions. The EUT was provided with ability to continuously transmit during testing. The carrier was also checked to verify that information was being transmitted. There were no deviations from the test standard(s) and/or methods. The test results reported relate only to the item tested.

2.3 Test Result Summary

Table 2-2: Test Result Summary – FCC Part 15 Subpart C (Section 15.247) & IC

Test	FCC Reference	IC Reference	Result
AC Power Conducted Emissions	FCC 15.207	RSS-Gen 8.8	Pass
Radiated Emissions	FCC 15.209	RSS-247 5.5; RSS-Gen 6.13/7.1	Pass
Maximum Peak Power Output	FCC 15.247(b)(3)	RSS-247 5.4(4), RSS-Gen 6.12	Pass
Peak Power Spectral Density	FCC 15.247(e)	RSS-247 A8.1(b)	Pass
Antenna Conducted Spurious Emissions	FCC 15.247(d)	RSS-247 5.5, RSS-Gen 6.13	Pass
Band Edge Measurement	FCC 15.247(d)	RSS-247 5.5	Pass
Bandwidth	FCC 15.247(a)(2)	RSS-247 A8.1(a)(b)(d)	Pass

2.4 Test System Details

The test samples were received on October 17, 2016. The FCC identifiers for all applicable equipment, plus descriptions of all cables used in the tested system, are identified in the following table.

Table 2-3: Equipment Under Test

Part	Manufacturer	Model	Serial Number	FCC ID	Cable Description	RTL Bar Code
Transceiver (radiated emissions)	Alarm.com	ADC-470L	NX-1, 503414-520	YL6-143470L	0.45m unshielded, 0.15 unshielded Ethernet	22254
Transceiver (conducted port)	Alarm.com	ADC-470L	SEM-2, 503414-210	YL6-143470L	0.45m unshielded, 0.15 unshielded Ethernet	22255
Transceiver (radiated emissions)	Alarm.com	ADC-470L	SEM-1, 503414-210	YL6-143470L	0.45m unshielded, 0.15 unshielded Ethernet	22256
Transceiver (radiated emissions)	Alarm.com	ADC-470L	XT-1, 503414-000	YL6-143470L	0.45m unshielded, 0.15 unshielded Ethernet	22257
AC Adapter	JFEC	JF006WR-0900066UH	N/A	N/A	1.5m unshielded	22261

Table 2-4: Auxiliary Equipment Used

Part	Manufacturer	Model	Serial Number	FCC ID	Cable Description	RTL Bar Code
Breakout Board	Alarm.com	ADC-20-504001-004	N/A	N/A	0.3 ribbon, 0.95m USB	22262
Pogo Connector Board	Alarm.com	ADC-20-500018-001	500018-000	N/A	N/A	22263
MR815T Ethernet Hub	CentreCOM	AT-MR815T	F1YQ7050A	N/A	1 m unshielded	11689

2.5 Configuration of Tested System

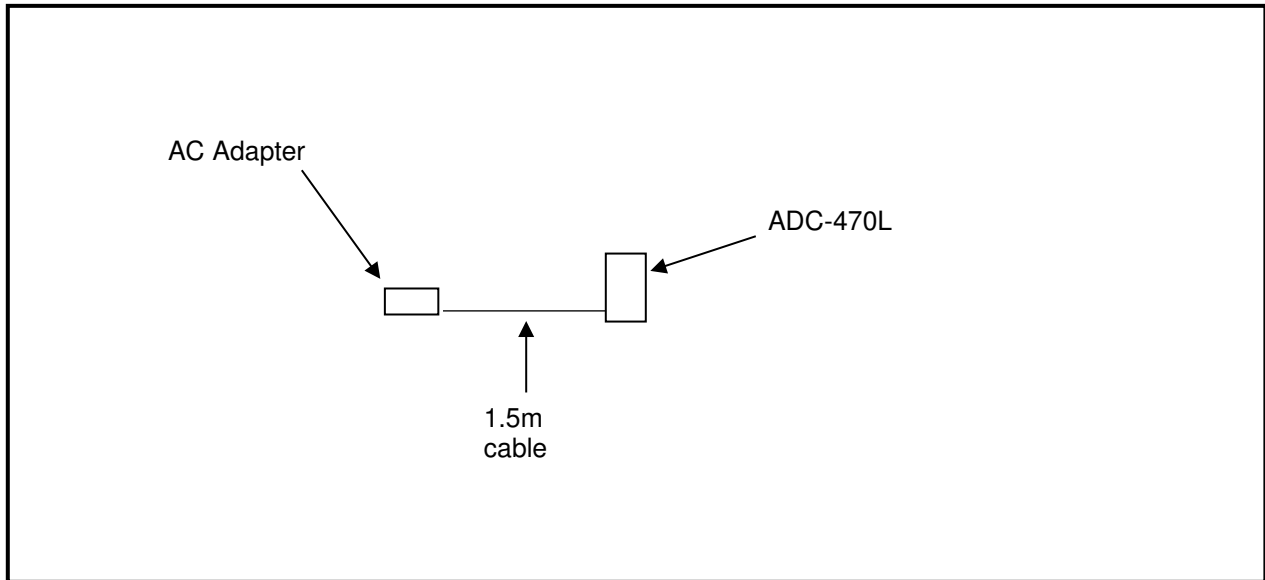

Figure 2-1: Configuration of System Under Test

3 Peak Output Power - 15.247(b)(3); IC RSS-247 5.4(4), RSS-Gen 6.12

3.1 Power Output Test Procedure

A PCB mounted U.FL connector provided a port for measurement using the automated channel power measurement on the spectrum analyzer, for the low, mid, and high channels.

Table 3-1: Peak Power Output Test Equipment

RTL Asset #	Manufacturer	Model	Part Type	Serial Number	Calibration Due Date
901581	Rohde & Schwarz	FSU	Spectrum Analyzer	1166.1660.50	3/22/18

3.2 Peak Output Power Test Data

Table 3-2: Peak Output Power Test Data

Emission Frequency (MHz)	Peak Detector (dBm)	Peak Detector (W)
912	9.6	0.009
918	9.6	0.009
924	9.5	0.009

Measurement uncertainties shown for these tests are expanded Gaussian uncertainties expressed at 95% confidence level using a coverage factor $k = 1.96$. Measurement uncertainty = 0.5 dB.

Test Personnel:

Daniel W. Baltzell Test Engineer	 Signature	October 17, 2016 Date of Test
-------------------------------------	--	----------------------------------

4 Peak Power Spectral Density – FCC 15.247(e); IC RSS-247 5.2(2)

4.1 Peak Spectral Density Test Procedure

Digitally modulated systems shall have conducted peak power spectral density of 8 dBm in any 3 kHz band during any time interval of continuous transmission.

Table 4-1: Peak Spectral Density Test Equipment

RTL Asset #	Manufacturer	Model	Part Type	Serial Number	Calibration Due Date
901581	Rohde & Schwarz	FSU	Spectrum Analyzer	1166.1660.50	3/22/18

4.2 Peak Spectral Density Test Data

Table 4-2: Peak Spectral Density Test Data

Channels	Frequency (MHz)	Peak Output Power (dBm)
Low	912	-2.4
Mid	918	-2.2
High	924	-2.7

Measurement uncertainties shown for these tests are expanded Gaussian uncertainties expressed at 95% confidence level using a coverage factor $k = 1.96$. Measurement uncertainty = 0.5 dB.

Plot 4-1: Peak Spectral Density – 912 MHz

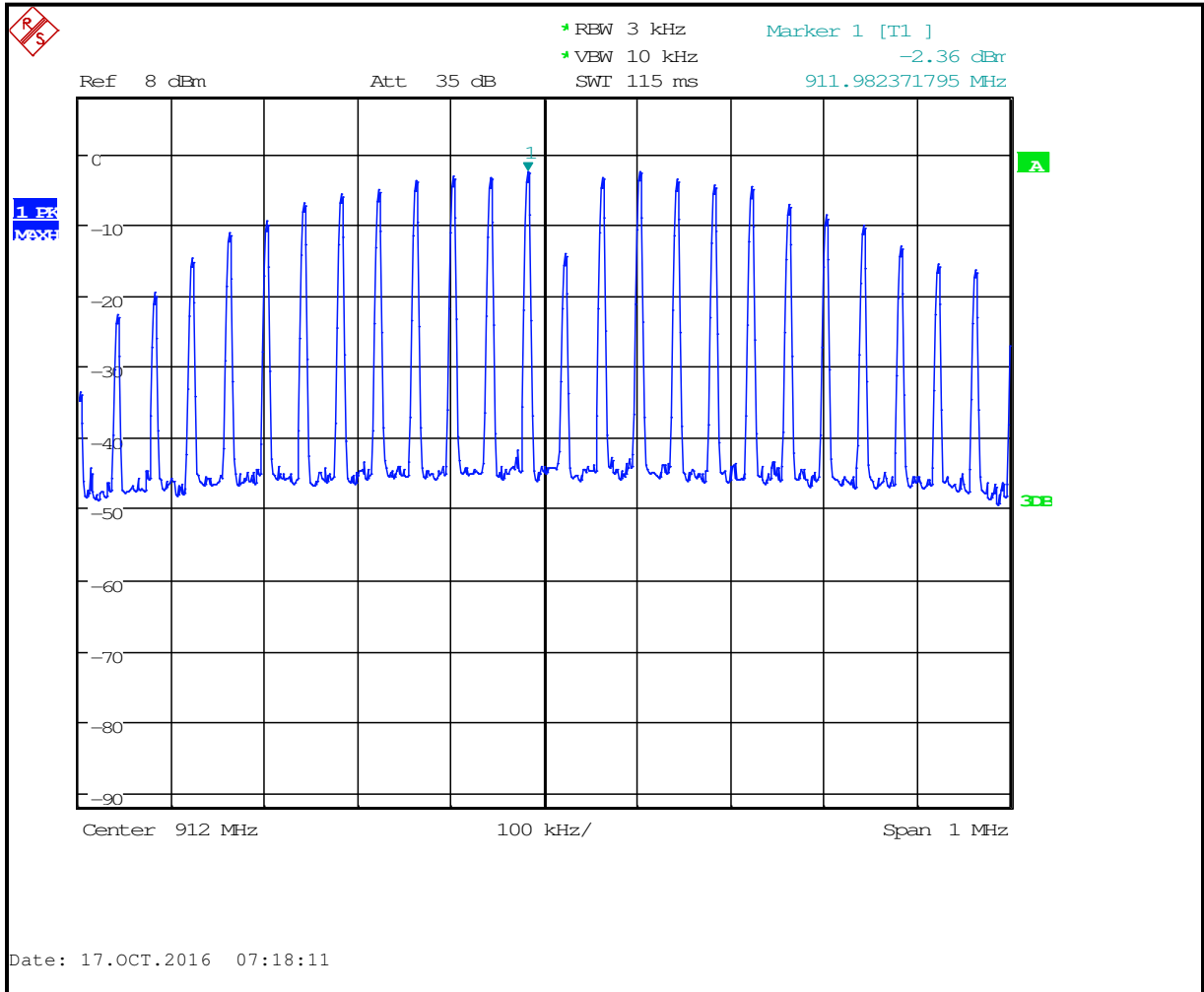

Plot 4-2: Peak Spectral Density – 918 MHz

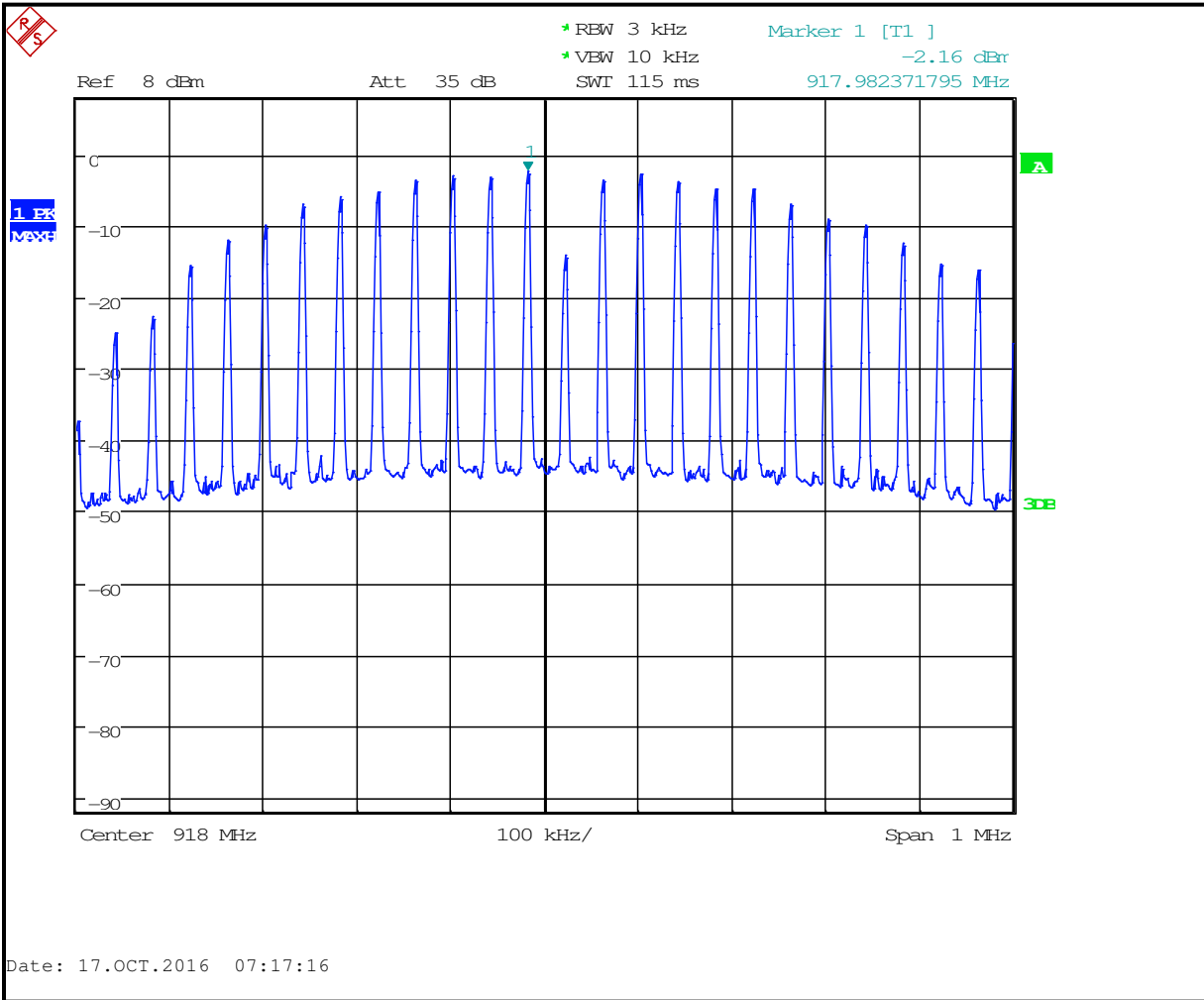

Plot 4-3: Peak Spectral Density – 924 MHz

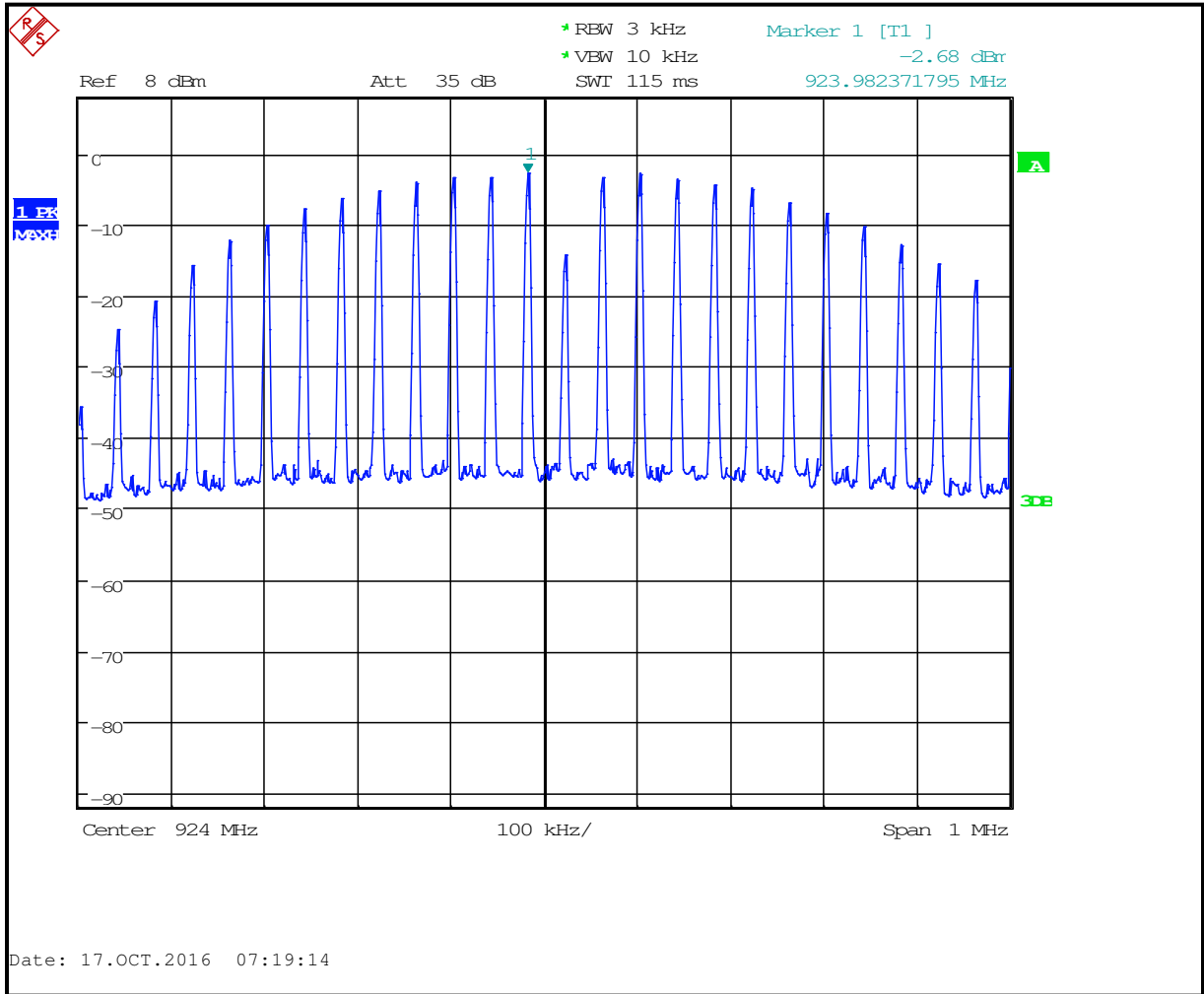

Test Personnel:

Daniel W. Baltzell
Test Engineer

Signature

October 17, 2016
Date of Test

5 Antenna Conducted Spurious Emissions – FCC 15.247(d), RSS-247 5.5

5.1 Antenna Conducted Spurious Emissions Test Procedure

A PCB mounted U.FL connector provided a port for measurement from 9 kHz to the 10th harmonic with the spectrum analyzer, for the low, mid, and high channels.

Table 5-1: Antenna Conducted Spurious Emissions Test Equipment

RTL Asset #	Manufacturer	Model	Part Type	Serial Number	Calibration Due Date
901581	Rohde & Schwarz	FSU	Spectrum Analyzer	1166.1660.50	3/22/18

5.2 Peak Output Power Test Data

Plot 5-1: Antenna Conducted Spurious Emissions – 912 MHz

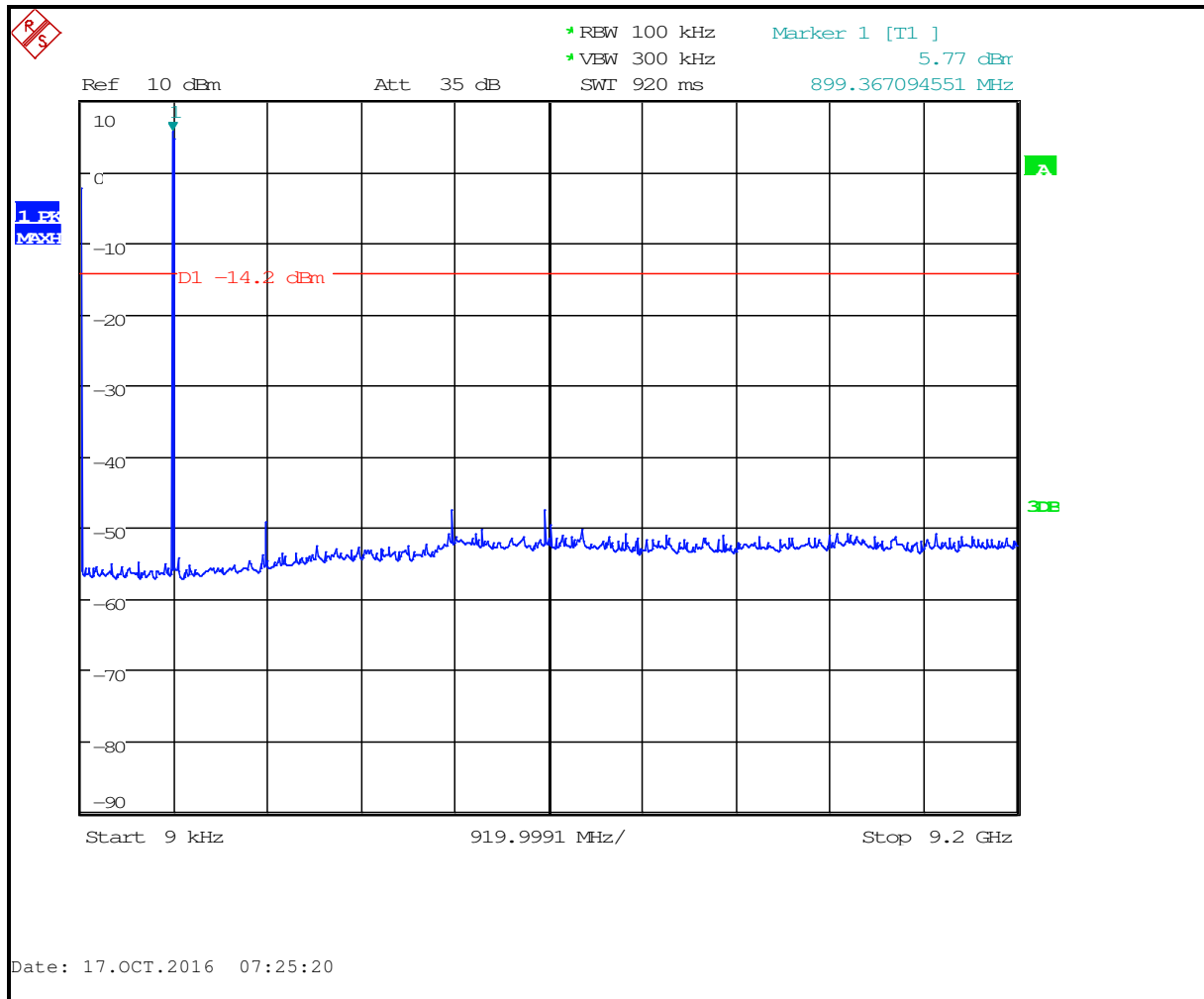

Plot 5-2: Antenna Conducted Spurious Emissions – 918 MHz

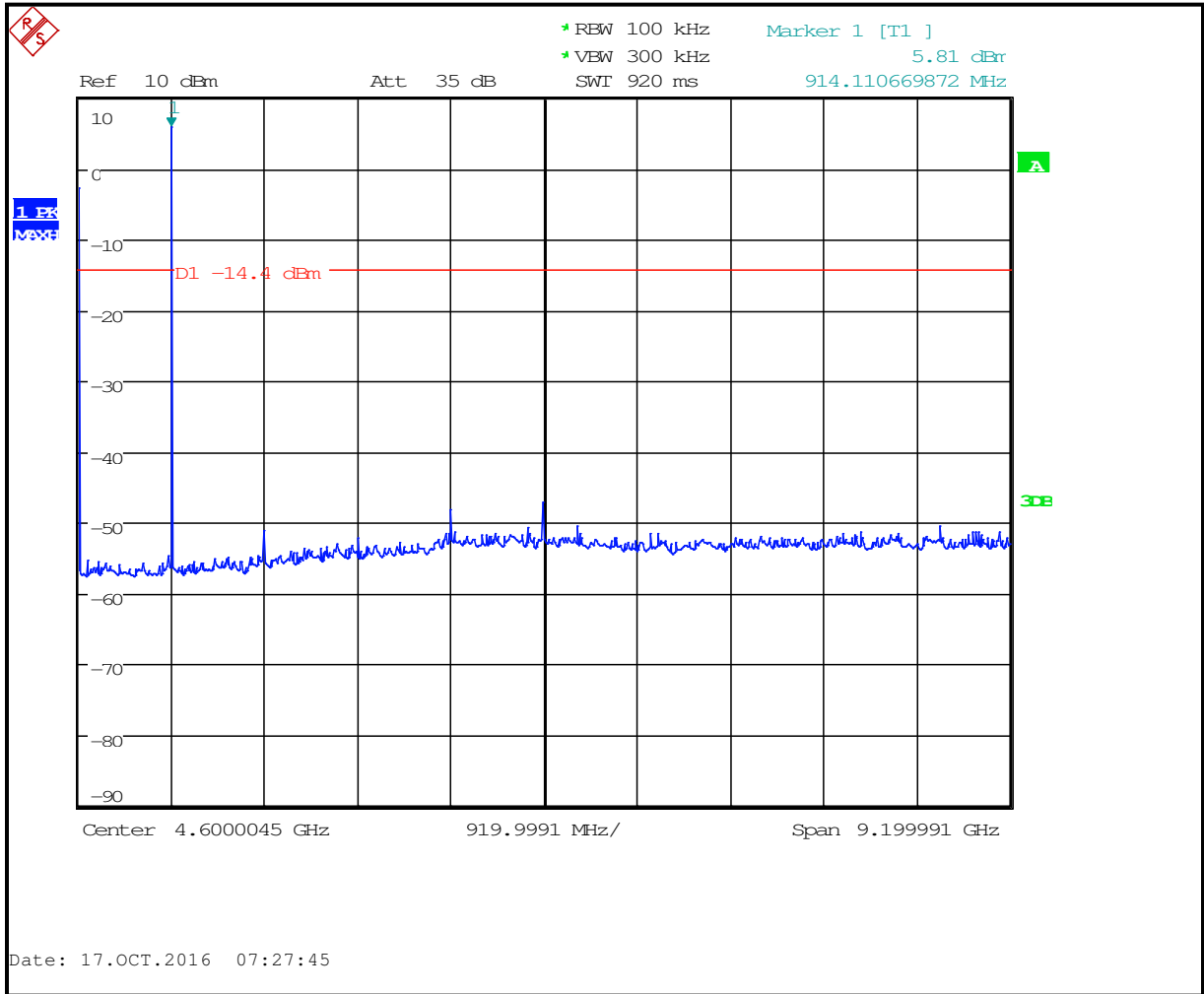

Plot 5-3: Antenna Conducted Spurious Emissions – 924 MHz

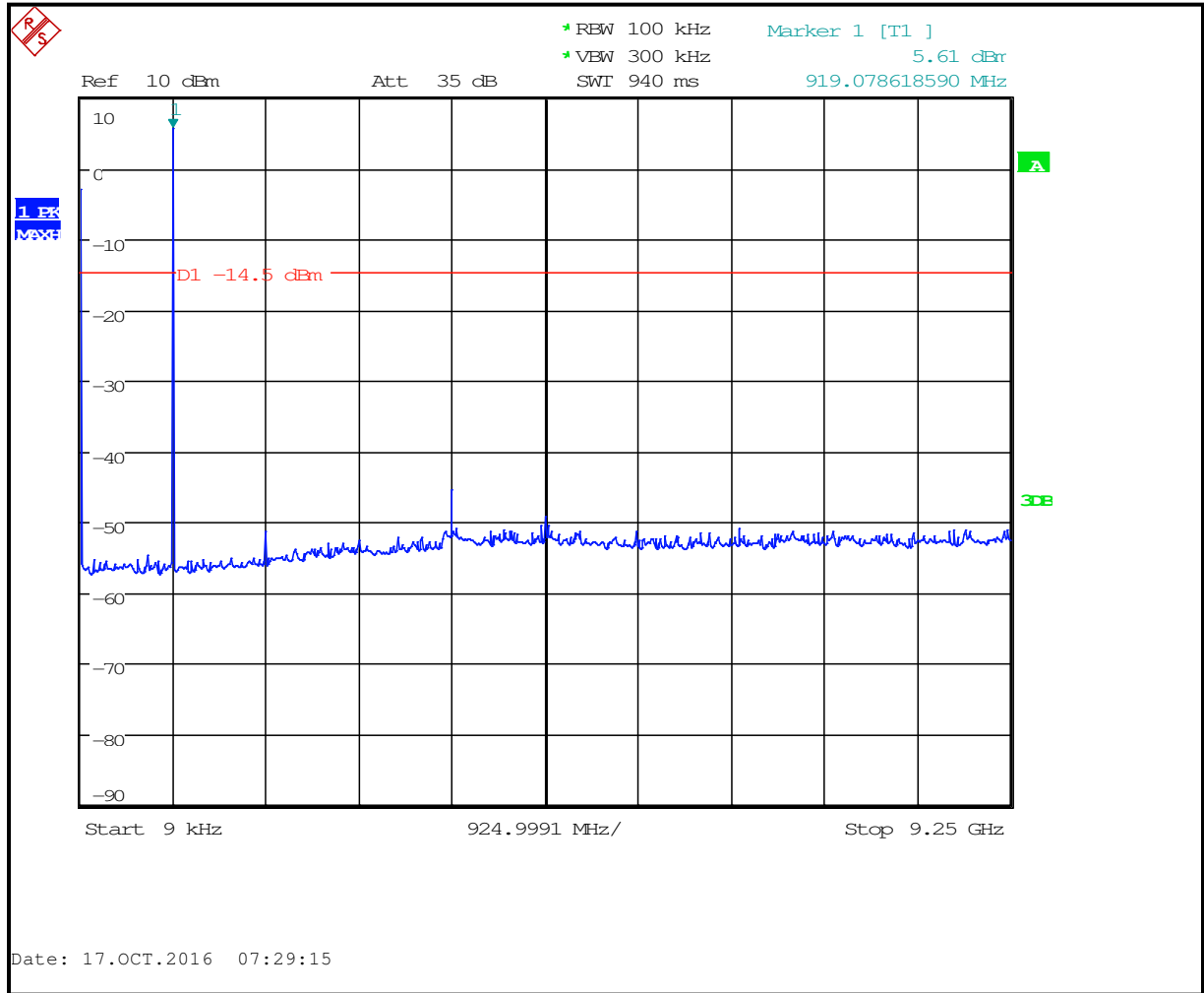

Measurement uncertainties shown for these tests are expanded Gaussian uncertainties expressed at 95% confidence level using a coverage factor $k = 1.96$. Measurement uncertainty = 0.5 dB.

Test Personnel:

Daniel W. Baltzell
 Test Engineer

Signature

October 17, 2016
 Date of Test

6 Compliance with the Band Edge – FCC 15.247(d); RSS-247 5.5

6.1 Band Edge Test Procedure

Conducted measurements were taken. The span was set wide enough to capture the peak level of the emission operating on the channel closest to the band edge, as well as any modulation products which fall outside of the authorized band of operation. The spectrum analyzer was set to the following:

RBW = 100 kHz
VBW > = RBW
Sweep = auto
Detector function = peak
Trace = max hold

The trace was allowed to stabilize. No emission was greater than 20 dB below the limit when using peak emissions.

Table 6-1: Band Edge Test Equipment

RTL Asset #	Manufacturer	Model	Part Type	Serial Number	Calibration Due Date
901581	Rohde & Schwarz	FSU	Spectrum Analyzer	1166.1660.50	3/22/18

6.2 Band Edge Test Results

6.2.1 Lower Band Edge

Plot 6-1: Lower Band Edge

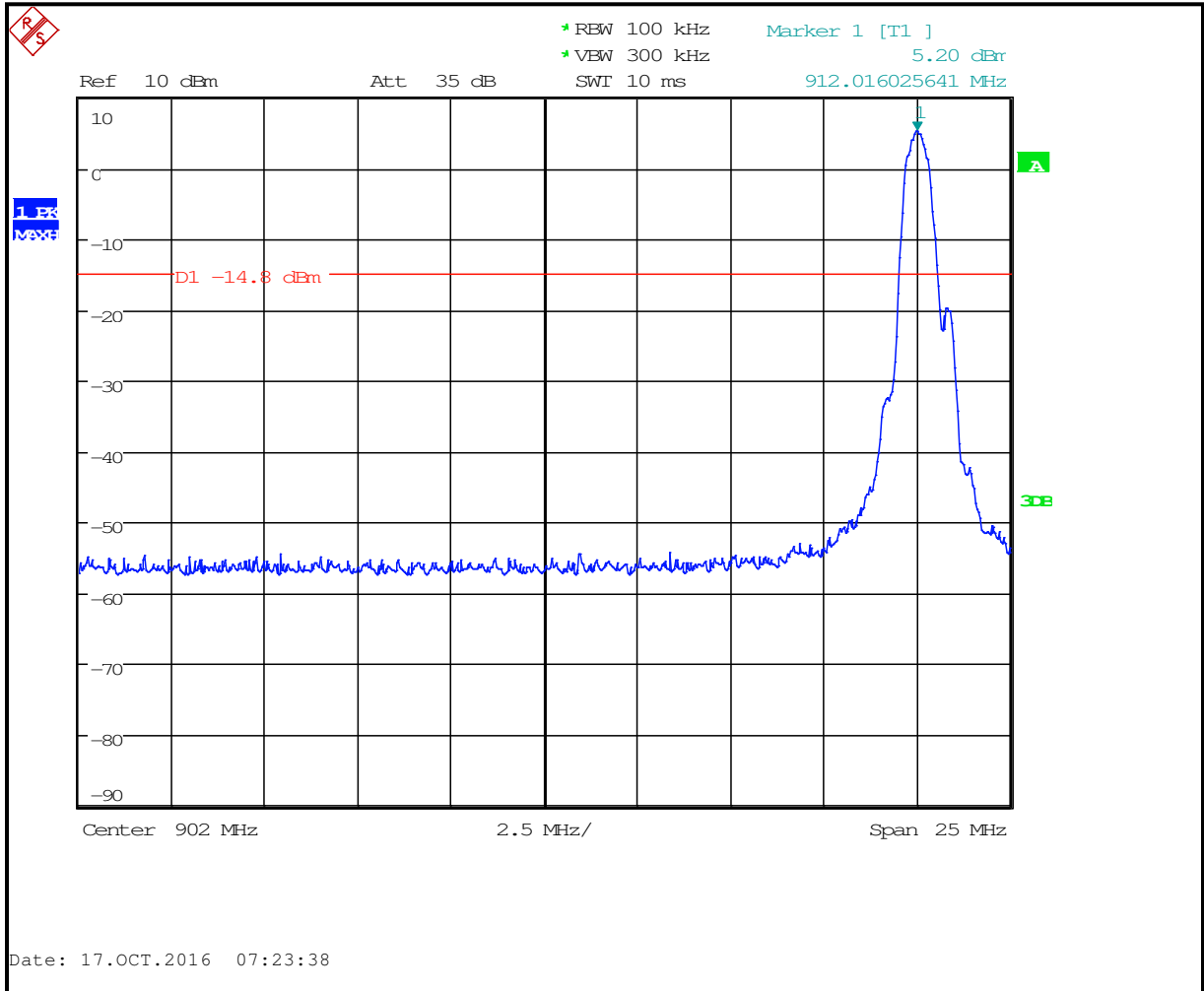

6.2.2 Upper Band Edge

Plot 6-2: Upper Band Edge

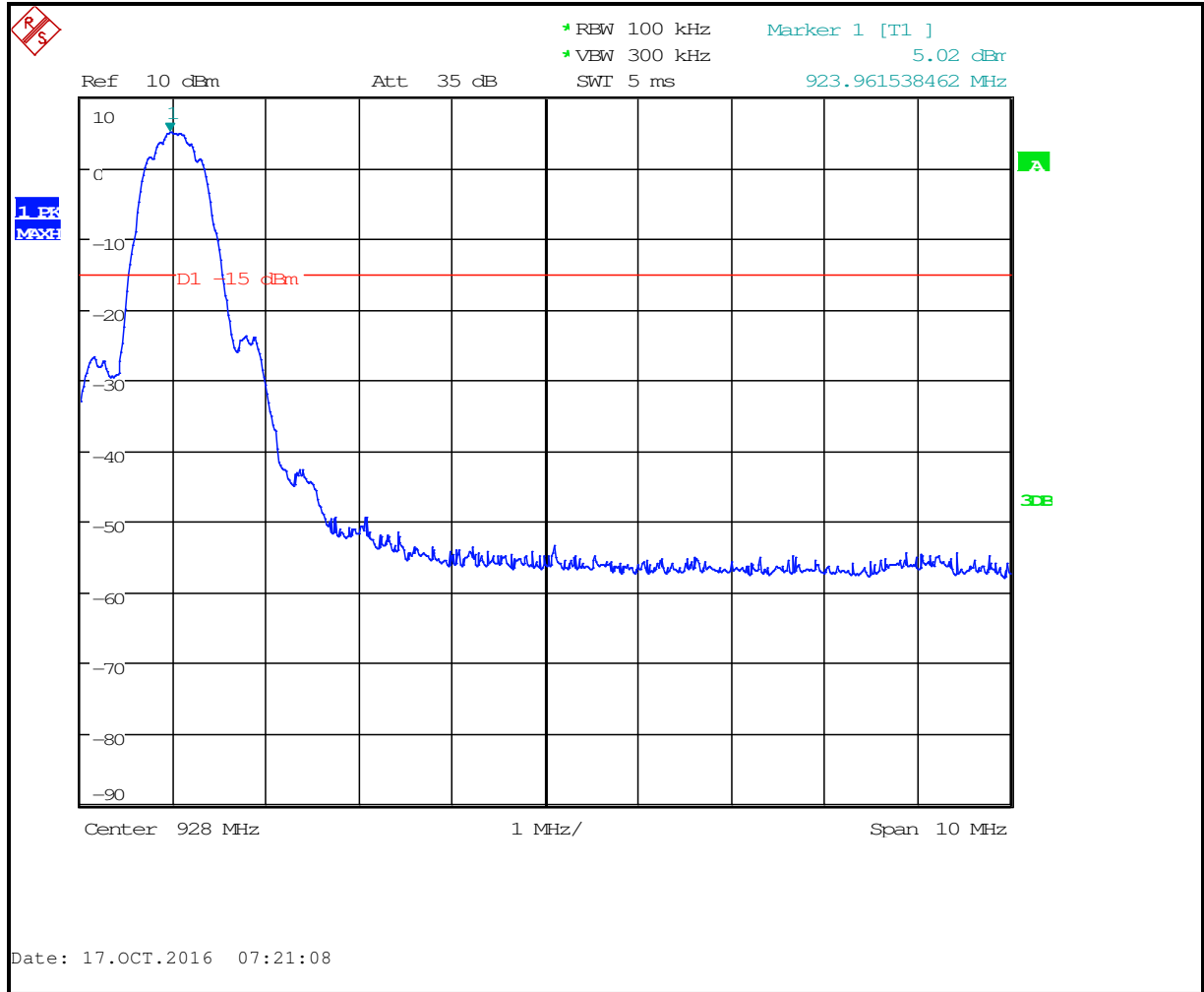

Measurement uncertainties shown for these tests are expanded Gaussian uncertainties expressed at 95% confidence level using a coverage factor $k = 1.96$. Measurement uncertainty = 0.5 dB.

Test Personnel:

Daniel W. Baltzell Test Engineer	 Signature	October 17, 2016 Date of Test
-------------------------------------	--	----------------------------------

7 Bandwidth – FCC 15.247(a)(2); RSS-247 5.2(1)

7.1 6 dB Bandwidth Test Procedure

The minimum 6 bandwidth per FCC 15.247 (a)(1) and RSS-247 were measured using a 50-ohm spectrum analyzer. The carrier was adjusted on the analyzer so that it was displayed entirely on the spectrum analyzer. The sweep time was set to auto and allowed through several sweeps with the max hold function used in peak detector mode. The resolution bandwidth was set to 100 kHz, and the video bandwidth set at 300 kHz.

Table 7-1: 6 dB Bandwidth Test Equipment

RTL Asset #	Manufacturer	Model	Part Type	Serial Number	Calibration Due Date
901581	Rohde & Schwarz	FSU	Spectrum Analyzer	1166.1660.50	3/22/18

7.2 Bandwidth Test Results

Table 7-2: 6 dB Bandwidth Test Data

Frequency (MHz)	6 dB Bandwidth (kHz)	Limit (MHz)	Pass/Fail
912	666.7	0.5	Pass
918	660.3	0.5	Pass
924	657.1	0.5	Pass

Measurement uncertainties shown for these tests are expanded Gaussian uncertainties expressed at 95% confidence level using a coverage factor $k = 1.96$. Measurement uncertainty = 12 Hz.

Plot 7-1: 6 dB Bandwidth – 912 MHz

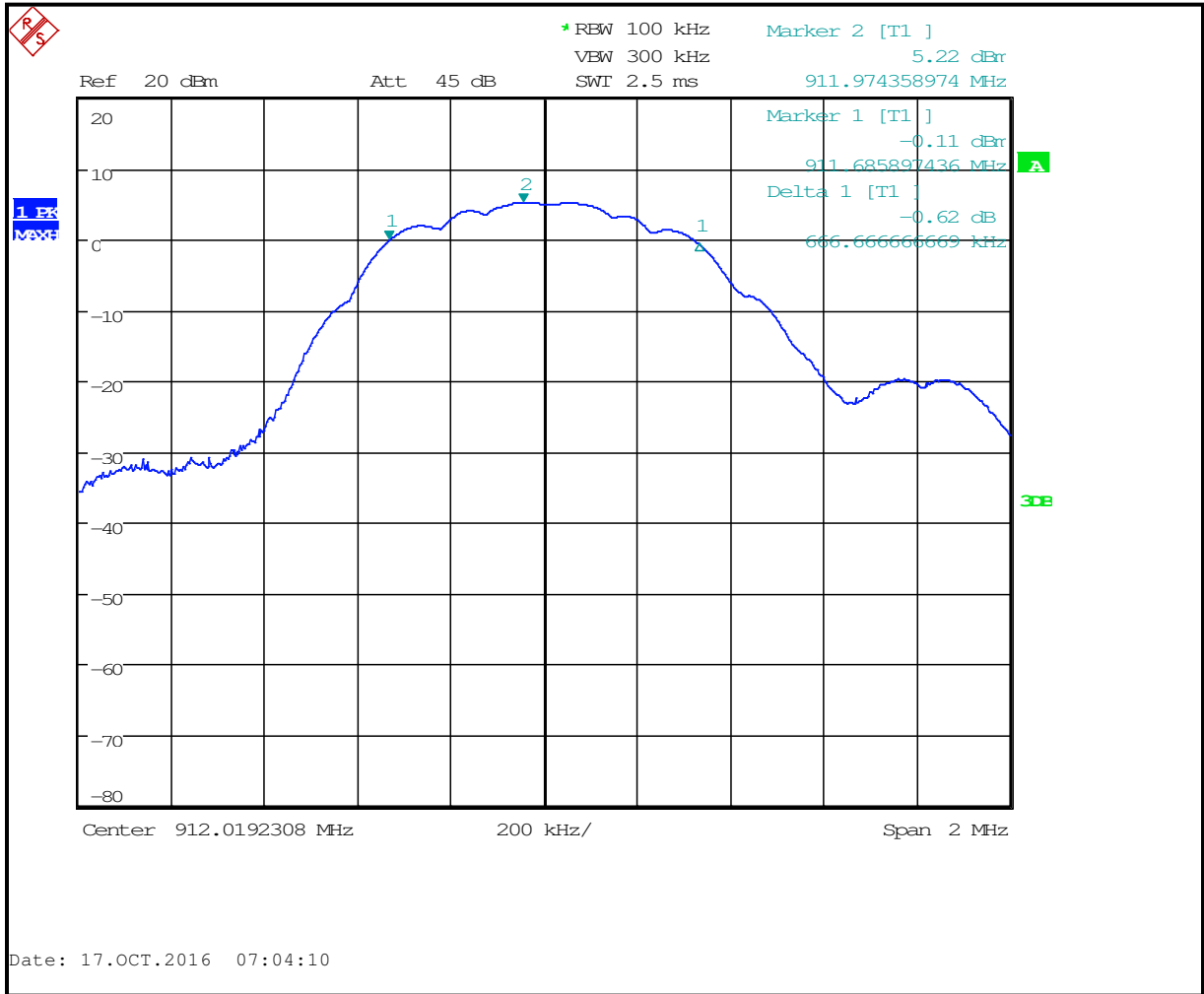

Plot 7-2: 6 dB Bandwidth – 918 MHz



Plot 7-3: 6 dB Bandwidth – 924 MHz

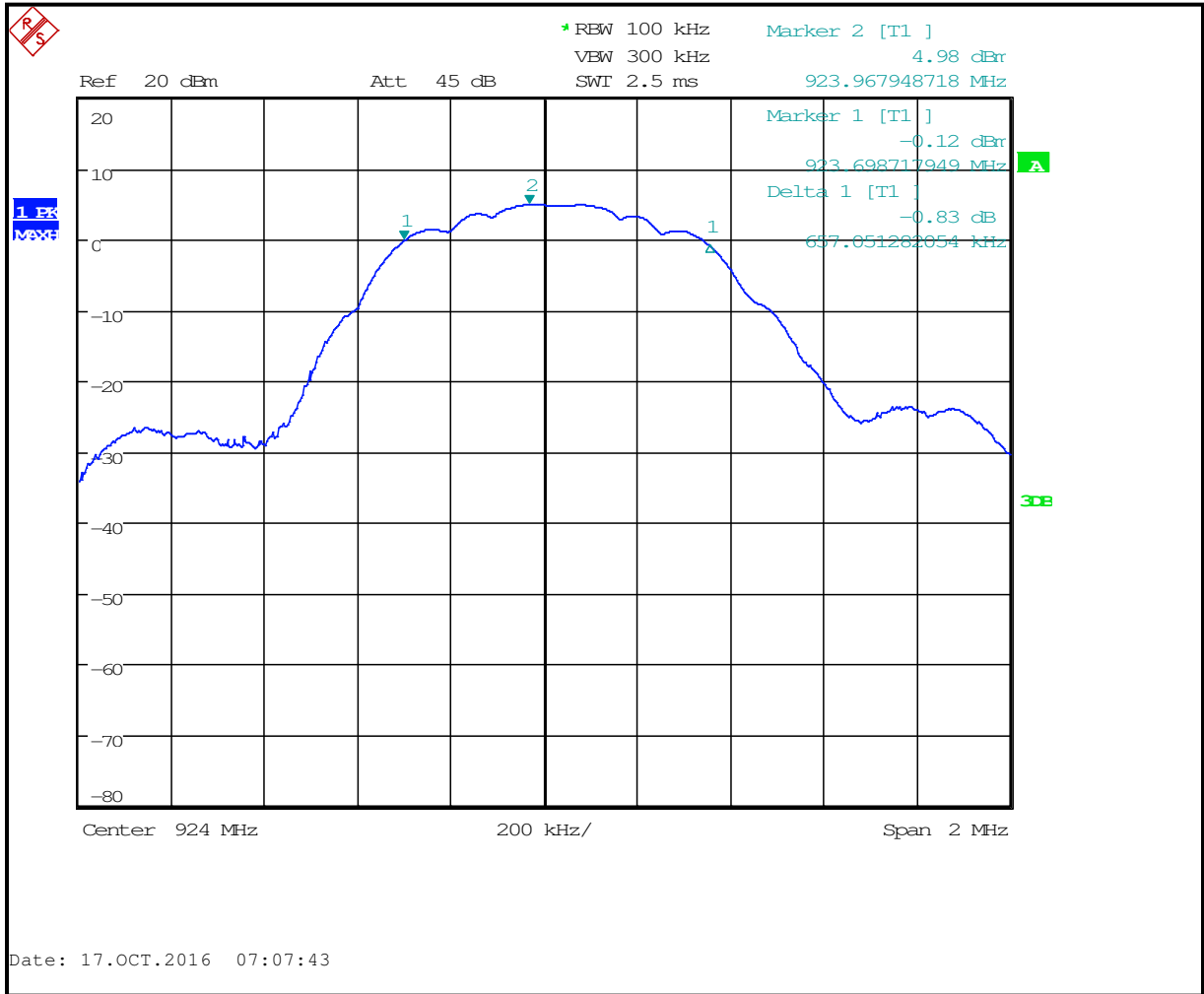

Test Personnel:

Daniel W. Baltzell Test Engineer	 Signature	October 17, 2016 Date of Test
-------------------------------------	--	----------------------------------

8 Radiated Emissions - 15.209; RSS-247 2.2; RSS-Gen 6.13/7.1

8.1 Limits of Radiated Emissions Measurement

Frequency (MHz)	Field Strength (uV/m)	Measurement Distance (m)
0.009-0.490	2400/f (kHz)	300
0.490-1.705	2400/f (kHz)	30
1.705-30.0	30	30
30-88	100	3
88-216	150	3
216-960	200	3
Above 960	500	3

As shown in 15.35(b), for frequencies above 1000 MHz, the field strength limits are based on average detector, however, the peak field strength of any emission shall not exceed the maximum permitted average limits, specified above by more than 20 dB under any circumstances of modulation.

8.2 Radiated Emissions Measurement Test Procedure

Before final measurements of radiated emissions were made on the open-field three/ten meter range, the EUT was scanned indoors at one and three meter distances. This was done in order to determine its emissions spectrum signature. The physical arrangement of the test system and associated cabling was varied in order to determine the effect on the EUT's emissions in amplitude, direction and frequency. This process was repeated during final radiated emissions measurements on the open-field range, at each frequency, in order to ensure that maximum emission amplitudes were attained.

Final radiated emissions measurements were made on the three/ten-meter, open-field test site. The EUT was placed on a nonconductive turntable 0.8 m (< 1 GHz) / 1.5 m (> 1 GHz) above the ground plane. The spectrum was examined from 9 kHz to the 10th harmonic of the highest fundamental transmitter frequency (9.3 GHz).

At each frequency, the EUT was rotated 360°, and the antenna was raised and lowered from 1 to 4 meters in order to determine the emission's maximum level. Measurements were taken using both horizontal and vertical antenna polarizations. For frequencies between 30 and 1000 MHz, the spectrum analyzer's 6 dB bandwidth was set to 120 kHz, and the analyzer was operated in the CISPR quasi-peak detection mode. For emissions above 1000 MHz, emissions are measured using the average detector function with a minimum resolution bandwidth of 1 MHz. No video filter less than 10 times the resolution bandwidth was used. The highest emission amplitudes relative to the appropriate limit were measured and recorded in this report.

Table 8-1: Radiated Emissions Test Equipment

RTL Asset #	Manufacturer	Model	Part Type	Serial Number	Calibration Due Date
900791	Chase	CBL6112	Antenna (30 MHz – 2 GHz)	2099	6/11/17
N/A	Rhein Tech Laboratories, Inc.	Automated Emission Tester	Emissions Testing Software	Rev. 14.0.2	N/A
901581	Rohde & Schwarz	FSU	Spectrum Analyzer	1166.1660.50	3/22/18
900772	EMCO	3161-02	Horn Antenna	9804-1044	4/9/18
900321	EMCO	3161-03	Horn Antenna	9528-1020	4/9/18
900323	EMCO	3160-07	Horn Antenna	9605-1024	4/9/18
900913	Hewlett Packard	85462A	EMI Receiver RF Section (9 kHz – 6.5 GHz)	3325A00159	12/9/16
900914	Hewlett Packard	85460A	RF Filter Section (100 kHz - 6.5 GHz)	3330A00107	12/9/16
901592	Insulated Wire Inc.	KPS-1503-3600-KPR	SMK RF Cables 20'	NA	8/3/17
901593	Insulated Wire Inc.	KPS-1503-360-KPR	SMK RF Cables 36"	NA	8/1/17

8.3 Radiated Emissions Test Results

8.3.1 Unintentional Radiated Emissions Test Data

Table 8-2: Radiated Emissions Test Data, Digital Unintentional Emissions

Temperature: 76°F Humidity: 59%										
Emission Frequency (MHz)	Test Detector	Antenna Polarity (H/V)	Turntable Azimuth (deg)	Antenna Height (m)	Analyzer Reading (dBuV)	Site Correction Factor (dB/m)	Emission Level (dBuV/m)	Limit (dBuV/m)	Margin (dB)	Pass/Fail
175.780	Qp	V	0	1.0	51.9	-17.4	34.5	43.5	-9.0	Pass
199.420	Qp	H	0	1.0	36.2	-16.9	19.3	43.5	-24.2	Pass
250.640	Qp	H	0	3.0	38.1	-13.4	24.7	46.0	-21.3	Pass
297.920	Qp	V	1	180.0	32.5	-12.1	20.4	46.0	-25.6	Pass
335.350	Qp	H	90	1.0	32.0	-11.1	20.9	46.0	-25.1	Pass
1975.000	Av	V	1	90.0	31.7	18.2	49.9	54.0	-4.1	Pass

* testing performed at 3m

8.3.2 Spurious/Harmonics Radiated Emissions Test Data

Table 8-3: Radiated Emissions Spurious/Harmonics – 912 MHz – Peak Detector

Emission Frequency (MHz)	Analyzer Reading (dBuV)	Site Correction Factor (dB/m)	Emission Level (dBuV/m)	Limit (dBuV/m)	Margin (dB)
2736.0	20.8	25.8	46.6	74.0	-27.4
3648.0	23.3	27.6	50.9	74.0	-23.1
4560.0	19.1	33.6	52.7	74.0	-21.3
7296.0	14.1	35.7	49.8	74.0	-24.2
8208.0	13.9	41.7	55.6	74.0	-18.4
9120.0	13.6	41.9	55.5	74.0	-18.5

Table 8-4: Radiated Emissions Spurious/Harmonics – 912 MHz – Average Detector

Emission Frequency (MHz)	Analyzer Reading (dBuV)	Site Correction Factor (dB/m)	Emission Level (dBuV/m)	Limit (dBuV/m)	Margin (dB)
2736.0	17.7	25.8	43.5	54.0	-10.5
3648.0	18.7	27.6	46.3	54.0	-7.7
4560.0	12.1	33.6	45.7	54.0	-8.3
7296.0	4.9	35.7	40.6	54.0	-13.4
8208.0	2.7	41.7	44.4	54.0	-9.6
9120.0	2.3	41.9	44.2	54.0	-9.8

Table 8-5: Radiated Emissions Spurious/Harmonics – 918 MHz – Peak Detector

Emission Frequency (MHz)	Analyzer Reading (dBuV)	Site Correction Factor (dB/m)	Emission Level (dBuV/m)	Limit (dBuV/m)	Margin (dB)
2754.0	20.6	25.8	46.4	74.0	-27.6
3672.0	22.9	27.6	50.5	74.0	-23.5
4590.0	21.2	33.5	54.7	74.0	-19.3
7344.0	14.9	35.7	50.6	74.0	-23.4
8262.0	14.1	41.7	55.8	74.0	-18.2
9180.0	13.4	42.0	55.4	74.0	-18.6

Table 8-6: Radiated Emissions Spurious/Harmonics – 918 MHz – Average Detector

Emission Frequency (MHz)	Analyzer Reading (dBuV)	Site Correction Factor (dB/m)	Emission Level (dBuV/m)	Limit (dBuV/m)	Margin (dB)
2754.0	16.4	25.8	42.2	54.0	-11.8
3672.0	17.7	27.6	45.3	54.0	-8.7
4590.0	16.4	33.5	49.9	54.0	-4.1
7344.0	5.3	35.7	41.0	54.0	-13.0
8262.0	2.6	41.7	44.3	54.0	-9.7
9180.0	2.3	42.0	44.3	54.0	-9.7

Table 8-7: Radiated Emissions Spurious/Harmonics – 924 MHz – Peak Detector

Emission Frequency (MHz)	Analyzer Reading (dBuV)	Site Correction Factor (dB/m)	Emission Level (dBuV/m)	Limit (dBuV/m)	Margin (dB)
2772.0	22.5	25.9	48.4	74.0	-25.6
3696.0	23.9	27.7	51.6	74.0	-22.4
4620.0	20.4	33.4	53.8	74.0	-20.2
7392.0	14.6	35.7	50.3	74.0	-23.7
8316.0	14.3	41.8	56.1	74.0	-17.9

Table 8-8: Radiated Emissions Spurious/Harmonics – 924 MHz – Average Detector

Emission Frequency (MHz)	Analyzer Reading (dBuV)	Site Correction Factor (dB/m)	Emission Level (dBuV/m)	Limit (dBuV/m)	Margin (dB)
2772.0	18.8	25.9	44.7	54.0	-9.3
3696.0	18.7	27.7	46.4	54.0	-7.6
4620.0	14.9	33.4	48.3	54.0	-5.7
7392.0	5.8	35.7	41.5	54.0	-12.5
8316.0	3.7	41.8	45.5	54.0	-8.5

Measurement uncertainty: Measurement uncertainties shown for these tests are expanded uncertainties expressed at 95% confidence level using a coverage factor $k = 2$. +4.0 dB / -2.65 dB

Test Personnel:

Daniel W. Baltzell
 Test Engineer



Signature

October 19-20, 2016
 Dates of Test

Rhein Tech Laboratories, Inc.
360 Herndon Parkway
Suite 1400
Herndon, VA 20170
<http://www.rheintech.com>

Client: Alarm.com
Model/HVIN: ADC-470L
Standards: FCC 15.247/IC RSS-247
ID's: YL6-143470L/91111A-143470L
Report #: 2016204DTS

Note: Radiated emissions were investigated with the module collocated and transmitting simultaneously with the DXT transceiver submitted in this same application. No non-compliant emissions were found; per FCC guidance, no data is being reported.

Test Personnel:

Daniel W. Baltzell Test Engineer		October 18, 2016 Date of Test
-------------------------------------	---	----------------------------------

9 AC Conducted Emissions - FCC 15.207; RSS-Gen 7.2.4: Conducted Limits

9.1 Site and Test Description

The power line conducted emissions measurements were performed in a Series 81 type shielded enclosure manufactured by Rayproof. The EUT was assembled on a wooden table 80 centimeters high. Power was fed to the EUT through a 50-ohm/50 microhenry Line Impedance Stabilization Network (LISN). The EUT LISN was fed power through an A.C. filter box on the outside of the shielded enclosure. The filter box and EUT LISN housing are bonded to the ground plane of the shielded enclosure. A second LISN, the peripheral LISN, provides isolation for the EUT test peripherals. This peripheral LISN was also fed A.C. power. A metal power outlet box, which is bonded to the ground plane and electrically connected to the peripheral LISN, powers a DC power supply which powers the EUT.

The spectrum analyzer was connected to the AC line through an isolation transformer. The 50-ohm output of the EUT LISN was connected to the spectrum analyzer input through a Solar 100 kHz high-pass filter. The filter is used to prevent overload of the spectrum analyzer from noise below 100 kHz. Conducted emission levels were measured on each current-carrying line with the spectrum analyzer operating in the CISPR quasi-peak mode (or peak mode if applicable).

The analyzer's 6 dB bandwidth was set to 9 kHz. Video filter less than 10 times the resolution bandwidth is not used. Average measurements are performed in linear mode using a 10 kHz resolution bandwidth, a 1 Hz video bandwidth, and by increasing the sweep time in order to obtain a calibrated measurement. The emission spectrum was scanned from 150 kHz to 30 MHz. The highest emission amplitudes relative to the appropriate limits were measured and have been recorded.

9.2 Test Limits

Line-Conducted Emissions		
Limit (dBμV)		
Frequency (MHz)	Quasi-Peak	Average
0.15 to 0.50	66 to 56	56 to 46
0.50 to 5.00	56	46
5.00 to 30.00	60	50

Table 9-1: Conducted Emissions Test Equipment

RTL Asset #	Manufacturer	Model	Part Type	Serial Number	Calibration Due Date
901581	Rohde & Schwarz	FSU	Spectrum Analyzer	1166.1660.50	3/22/18
901083	AFJ International	LS16/110VAC	16A LISN	16010020080	3/11/17
N/A	Quantum Change	Tile!	Test Software	4.0.A.8	N/A

9.3 Conducted Emissions Test Data

Plot 9-1: Conducted Emissions - Phase - Receive Mode

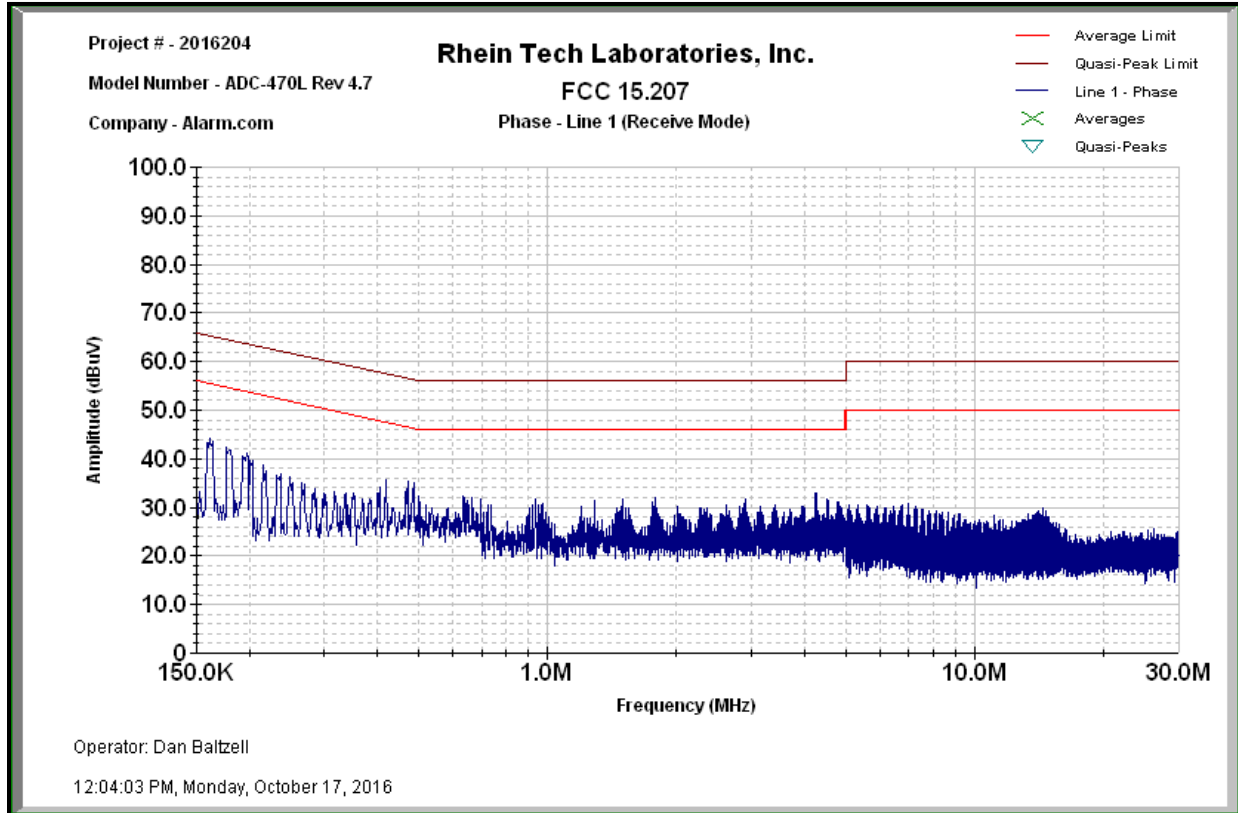

Plot 9-2: Conducted Emissions - Neutral - Receive Mode

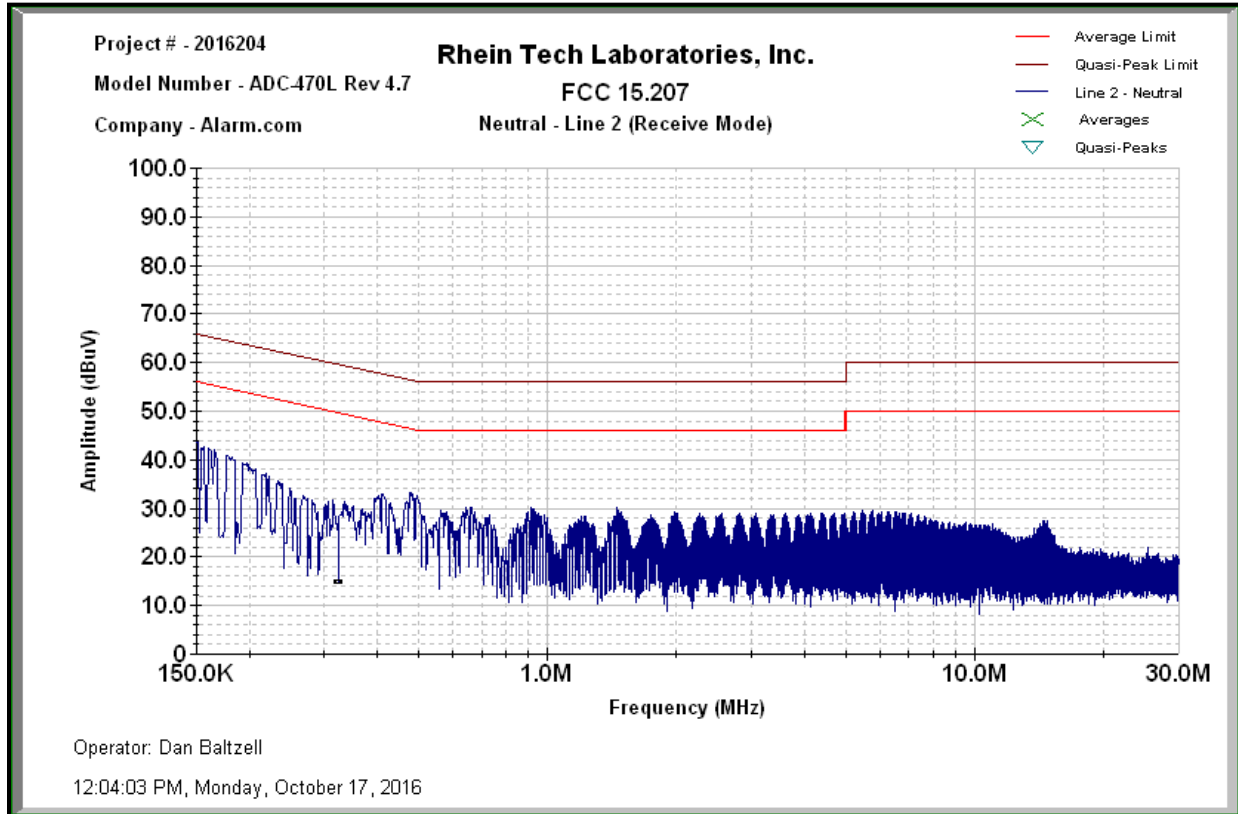

Plot 9-3: Conducted Emissions – Phase – Transmit Mode

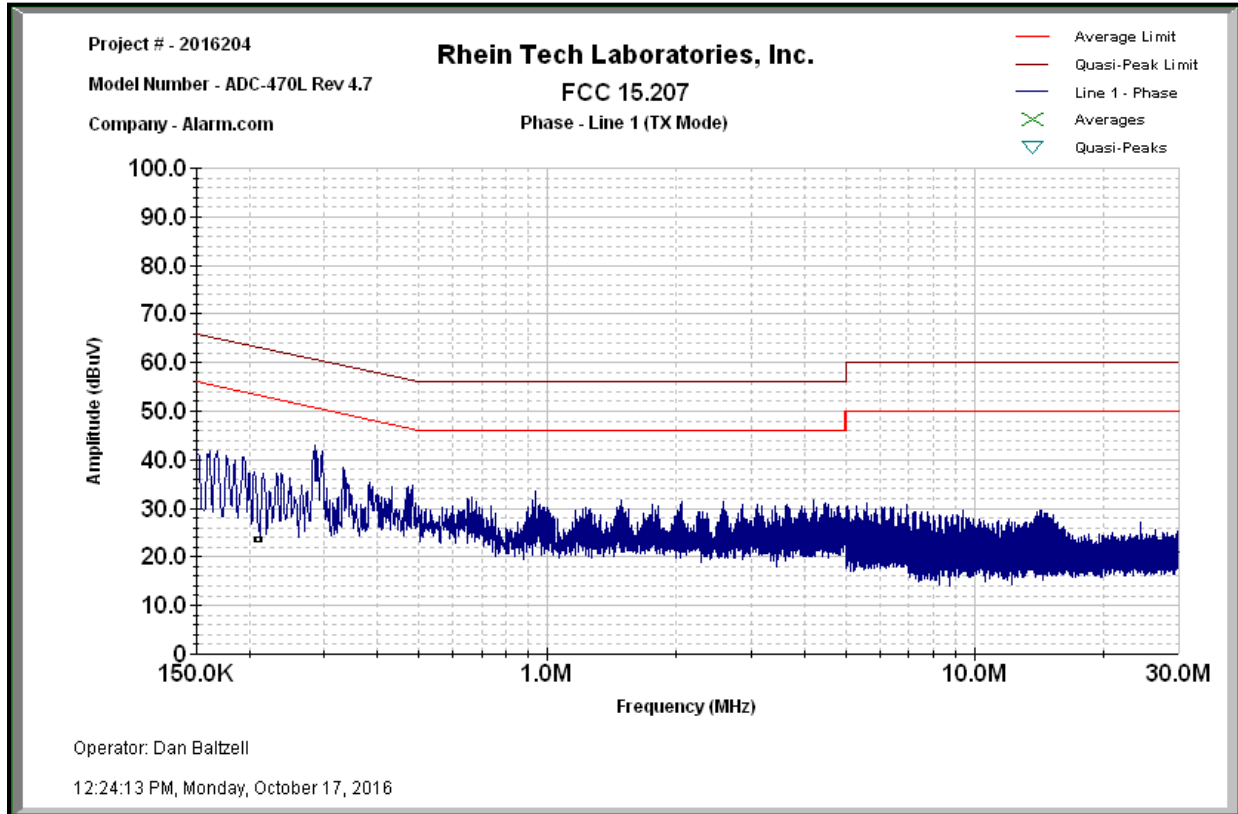

Plot 9-4: Conducted Emissions – Neutral – Transmit Mode

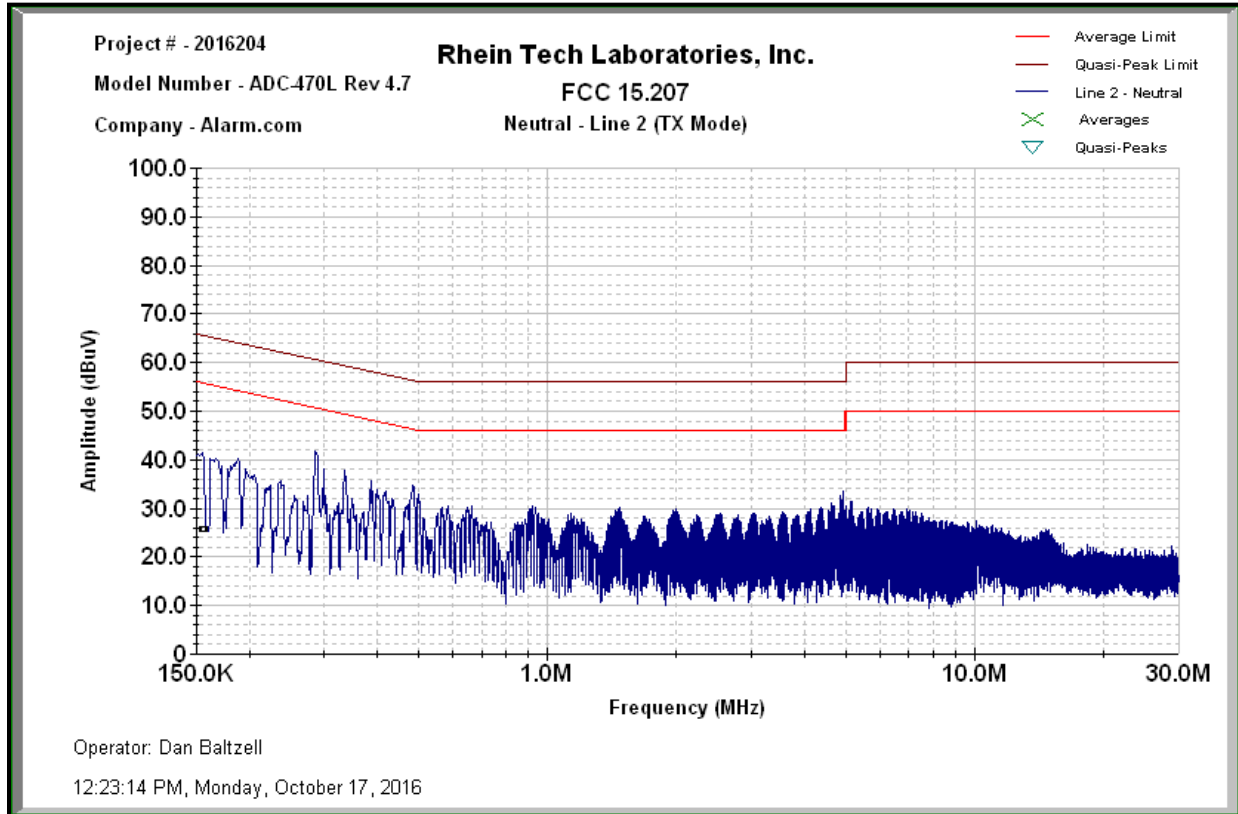

Plot 9-5: Conducted Emissions – Telecom (Ethernet)

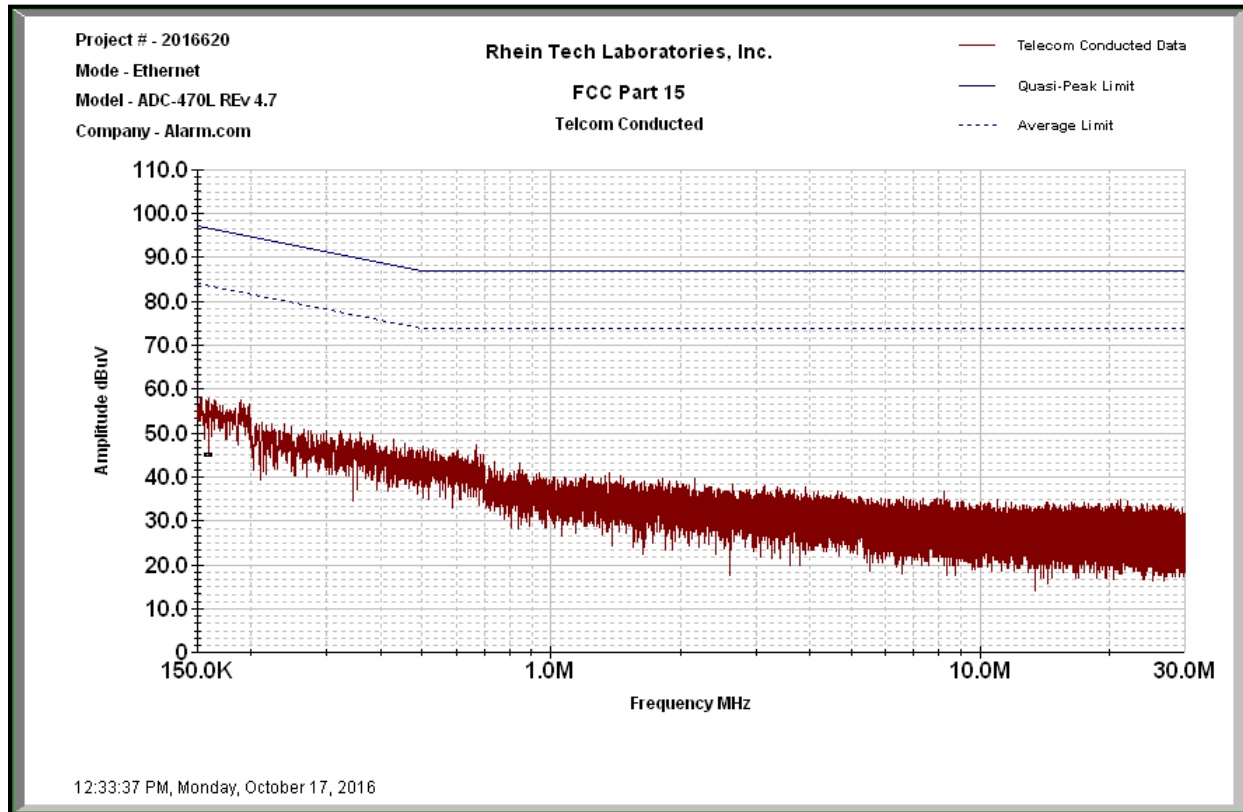

Measurement uncertainty: Measurement uncertainties shown for these tests are expanded uncertainties expressed at 95% confidence level using a coverage factor $k = 2$. ± 3.6 dB

Test Personnel:

Daniel W. Baltzell Test Engineer	 Signature	October 17, 2016 Date of Test
-------------------------------------	--	----------------------------------

10 Conclusion

The data in this measurement report shows that the EUT as tested, Alarm.com Model ADC-470L, FCC ID: YL6-143470L, IC: 9111A-143470L, complies with the applicable requirements of Parts 2 and 15 of the FCC Rules and Regulations and Industry Canada RSS-247 and RSS-Gen.