



Engineering Solutions & Electromagnetic Compatibility Services

**Modular Approval Certification Application Report  
FCC Part 15.249 & Industry Canada RSS-210**

<b>Test Lab:</b> Rhein Tech Laboratories, Inc.      Tel: 703-689-0368 360 Herndon Parkway                      Fax: 703-689-2056 Suite 1400                                      www.rheintech.com Herndon, VA 20170 E-Mail: atcbinfo@rheintech.com		<b>Applicant:</b> Alarm.com                                      Tel: 703-584-7319 8150 Leesburg Pike Suite 1400 Vienna, VA 22182	
<b>FCC ID:</b>	YL6-143450L	<b>Test Report Date:</b>	August 27, 2014
<b>IC:</b>	9111A-143450L		
<b>Platform:</b>	N/A	<b>RTL Work Order #:</b>	2014100
<b>Model:</b>	ADC-450L	<b>RTL Quote #:</b>	QRTL14-100B
<b>American National Standard Institute:</b>	ANSI C63.4-2003: Methods of Measurement of Radio-Noise Emissions from Low-Voltage Electrical and Electronic Equipment in the Range of 9 kHz to 40 GHz		
<b>FCC Classification:</b>	DXT – Part 15 Low Power Transceiver		
<b>FCC Rule Part(s)/ Guidance:</b>	15.249: Operation within the bands 902-928 MHz, 2400-2483.5 MHz, 5725-5875 MHz, and 24.0-24.25 GHz, October 1, 2013		
<b>Industry Canada:</b>	RSS-210 Issue 8: License-Exempt Radio Apparatus (All Frequency Bands): Category I Equipment		
<b>Digital Interface Information:</b>	Digital Interface was found to be compliant		
<b>Frequency Range (MHz)</b>	<b>Output Power (W)</b>	<b>Frequency Tolerance</b>	<b>Emission Designator</b>
908.4	N/A	N/A	106KF1D

I, the undersigned, hereby declare that the equipment tested and referenced in this report conforms to the identified standard(s) as described in this test report. No modifications were made to the equipment during testing in order to achieve compliance with these standards. Furthermore, there was no deviation from, additions to, or exclusions from, the applicable parts of FCC Part 2, FCC Part 15, RSS-210, and ANSI C63.4.

Signature: 

Date: August 27, 2014

Typed/Printed Name: Desmond A. Fraser

Position: President

*This report may not be reproduced, except in full, without the written approval of Rhein Tech Laboratories, Inc. and Alarm.com. The test results relate only to the item(s) tested.*

*These tests are accredited and meet the requirements of ISO/IEC 17025 as verified by ANSI-ASQ National Accreditation Board/ACLASS. Refer to certificate and scope of accreditation AT-1445.*

## Table of Contents

---

1	General Information .....	5
1.1	Scope .....	5
1.2	Description of EUT .....	5
1.3	Test Facility .....	5
1.4	Related Submittal(s)/Grant(s) .....	5
1.5	Modifications .....	5
2	Test Information .....	6
2.1	Description of Test Modes .....	6
2.2	Exercising the EUT .....	6
2.3	Test Result Summary.....	6
2.4	Test System Details .....	7
2.5	Configuration of Tested System.....	8
3	Radiated Emissions – FCC 15.209, 15.249(a); RSS-210 A2.9; RSS-Gen .....	9
3.1	Limits of Radiated Emissions Measurement.....	9
3.2	Radiated Emissions Measurement Test Procedure.....	9
3.3	Radiated Emissions Test Results .....	11
3.4	Radiated Emissions Harmonics/Spurious with ISDB on Board Test Data .....	11
3.5	Radiated Emissions Digital Test Data.....	12
4	AC Conducted Emissions - FCC 15.207; RSS-Gen 7.2.4: Conducted Limits.....	13
4.1	Site and Test Description .....	13
4.2	Test Limits .....	13
4.3	Conducted Emissions Test Data.....	14
5	20 dB Bandwidth – IC RSS-Gen.....	19
5.1	20 dB Bandwidth Test Procedure .....	19
5.2	20 dB Modulated Bandwidth Test Data .....	19
5.3	20 dB Bandwidth Plots .....	20
6	Conclusion .....	21

---

### Figure Index

---

Figure 2-1: Configuration of System Under Test.....	8
---	---

---

### Table Index

---

Table 2-1: Channels Tested .....	6
Table 2-2: Test Result Summary – FCC Part 15, Subpart C (Section 15.249).....	6
Table 2-3: Equipment Under Test .....	7
Table 3-1: Radiated Emissions Test Equipment .....	10
Table 3-2: Radiated Emissions with ISDB on Board Test Data .....	11
Table 3-3: Peak Radiated Emissions Harmonics/Spurious – 908.4 MHz .....	11
Table 3-4: Radiated Emissions Harmonics/Spurious – 908.4 MHz .....	11
Table 3-5: Digital Radiated Emissions Test Data.....	12
Table 4-1: Conducted Emissions Test Equipment .....	18
Table 5-1: 20 dB Bandwidth Test Equipment.....	19
Table 5-2: 20 dB Modulated Bandwidth Test Data .....	19

---

### Plot Index

---

Plot 4-1: Conducted Emissions Transmit - Neutral Side – Z-Wave Module.....	14
Plot 4-2: Conducted Emissions Transmit - Hot Side – Z-Wave Module.....	15
Plot 4-3: Conducted Emissions Receive - Neutral Side – Z-Wave Module.....	16
Plot 4-4: Conducted Emissions Receive - Hot Side – Z-Wave Module.....	17
Plot 5-1: 20 dB Bandwidth; 908.4 MHz.....	20

---

### Appendix Index

---

Appendix A: FCC Part 1.1307, 1.1310, 2.1091, 2.1093; IC RSS-Gen: RF Exposure.....	22
Appendix B: Agency Authorization Letter.....	23
Appendix C: FCC Confidentiality Request Letter.....	24
Appendix D: FCC Part 15 Unlicensed Modular Transmitter Equipment Approval .....	25
Appendix E: IC Letters.....	26
Appendix F: Canadian Based Representative Attestation Letter .....	27
Appendix G: IC Confidentiality Request Letter.....	28
Appendix H: RSS-Gen 3.2.3 Modular Approval.....	29
Appendix I: Label and Label Location .....	30
Appendix J: Technical Operational Description .....	32
Appendix K: Schematics.....	33
Appendix L: Block Diagram .....	34
Appendix M: Manual.....	35
Appendix N: Test Photographs .....	36
Appendix O: External Photographs .....	40
Appendix P: Internal Photographs .....	44

### Photograph Index

---

Photograph 1:	ID Label on Back of EUT .....	30
Photograph 2:	"Contains FCC ID....." Label Sample for Host .....	31
Photograph 3:	Radiated Emissions Testing – Front View .....	36
Photograph 4:	Radiated Emissions Testing – Back View .....	37
Photograph 5:	Conducted AC Testing – Front View .....	38
Photograph 6:	Conducted AC Testing – Back View .....	39
Photograph 7:	EUT Front View .....	40
Photograph 8:	EUT Back View with Shield .....	41
Photograph 9:	EUT Back View without Shields .....	42
Photograph 10:	Sample Host .....	43
Photograph 11:	EUT Front View .....	44
Photograph 12:	EUT Back View with Shield .....	45
Photograph 13:	EUT Back View without Shield .....	46

## 1 General Information

### 1.1 Scope

This is an original certification application request for full modular approval.

Applicable Standards:

- FCC Part 15.249: Operation within the bands 902-928 MHz, 2400-2483.5 MHz, 5725-5875 MHz, and 24.0-24.25 GHz
- Industry Canada RSS-210: Low Power License-Exempt Communications Devices

### 1.2 Description of EUT

<b>Equipment Under Test</b>	Transceiver
<b>Model</b>	ADC-450L
<b>Power Supply</b>	12 VDC
<b>Modulation Type</b>	FSK
<b>Frequency Range</b>	908.4 MHz
<b>Antenna Connector Type</b>	N/A
<b>Antenna Type</b>	Wire

### 1.3 Test Facility

The open area test site and conducted measurement facility used to collect the radiated data is located at 360 Herndon Parkway, Suite 1400, Herndon, Virginia 20170. This site has been fully described in a report and approved by the Federal Communications Commission to perform AC line conducted and radiated emissions testing (ANSI C63.4-2003).

### 1.4 Related Submittal(s)/Grant(s)

This is an original certification application for Full Modular Approval for Alarm.com, Model: ADC-450L, FCC ID: YL6-143450L, IC: 9111A-143450L.

Requested grant notes: This module may be collocated with the following modules:

FCC ID: YL6-143IS205V4 (IC: 9111A-143IS205V4)

### 1.5 Modifications

N/A

## 2 Test Information

### 2.1 Description of Test Modes

In accordance with FCC 15.31(m), and because the EUT utilizes an operating band greater than 10 MHz, the following frequencies were tested:

**Table 2-1: Channels Tested**

Frequency (MHz)
908.4

### 2.2 Exercising the EUT

The EUT was programmed for continuous transmission at 908.4 MHz. The EUT was tested in all three orthogonal planes in order to determine worst-case emissions. The carrier was also checked to verify that information was being transmitted.

### 2.3 Test Result Summary

**Table 2-2: Test Result Summary – FCC Part 15, Subpart C (Section 15.249)**

Standard	Test	Pass/Fail or N/A
FCC 15.207	AC Power Conducted Emissions	Pass
FCC 15.209	Radiated Emissions	Pass
FCC 15.249(a)	Field Strength of Fundamental and Harmonics	Pass
RSS-Gen	20 dB Bandwidth	Pass

## 2.4 Test System Details

The test samples were received on August 21, 2014. The FCC identifiers for all applicable equipment, plus descriptions of all cables used in the tested system, are identified in the following table.

**Table 2-3: Equipment Under Test**

Part	Manufacturer	Model	Serial Number	FCC ID	Cable Description	RTL Bar Code
Transceiver	Alarm.com	ADC-450L	8069001096	YL6-143450L	N/A	21537
Transceiver	Alarm.com	ADC-450L	8069001419	YL6-143450L	N/A	21538
12 V DC/AC Adapter	Triad	WSU120-3000	N/A	N/A	1.8m unshielded power	21544
12 V DC/AC Adapter	Triad	WSU120-3000	N/A	N/A	1.8m unshielded power	21543
Image Sensor Daughter Board	Alarm.com	ADC-IS20-EVD	1	YL6-143IS205V4	N/A	21533
Image Sensor Daughter Board	Alarm.com	ADC-IS20-EVD	2	YL6-143IS205V4	N/A	21534
LTE UWB 698-3000 MHz Antenna	Taoglas	FXUB63	1	N/A	20 cm shielded	21536
LTE UWB 698-3000 MHz Antenna	Taoglas	FXUB63	2	N/A	20 cm shielded	21541
140 x 25 LTE Antenna	SANAV	N/A	N/A	N/A	6' shielded	21539
140 x 25 LTE Antenna	SANAV	N/A	N/A	N/A	6' shielded	21540

## 2.5 Configuration of Tested System

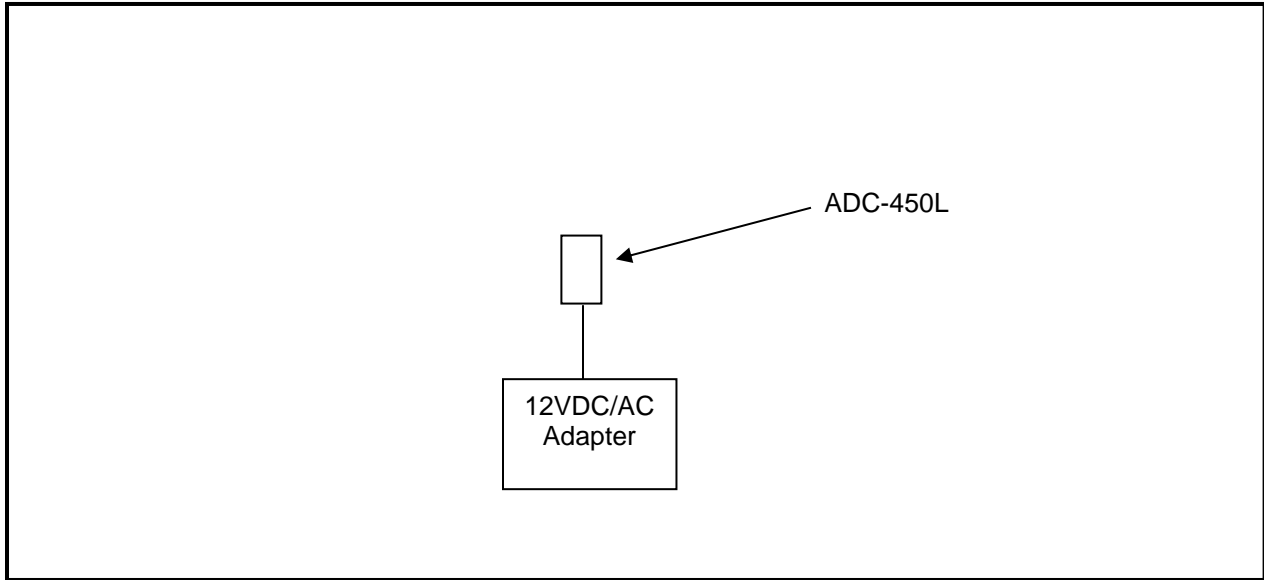

Figure 2-1: Configuration of System Under Test



### 3 Radiated Emissions – FCC 15.209, 15.249(a); RSS-210 A2.9; RSS-Gen

#### 3.1 Limits of Radiated Emissions Measurement

Frequency (MHz)	Field Strength (uV/m)	Measurement Distance (m)
0.009-0.490	2400/f (kHz)	300
0.490-1.705	2400/f (kHz)	30
1.705-30.0	30	30
30-88	100	3
88-216	150	3
216-960	200	3
Above 960	500	3

As shown in 15.35(b), for frequencies above 1000 MHz, the field strength limits are based on average detector, however, the peak field strength of any emission shall not exceed the maximum permitted average limits specified above by more than 20 dB under any circumstances of modulation.

#### 3.2 Radiated Emissions Measurement Test Procedure

Before final measurements of radiated emissions were made on the open-field three/ten meter range, the EUT was scanned indoors at one and three meter distances. This was done in order to determine its emissions spectrum signature. The physical arrangement of the test system and associated cabling was varied in order to determine the effect on the EUT's emissions in amplitude, direction and frequency. This process was repeated during final radiated emissions measurements on the open-field range, at each frequency, in order to ensure that maximum emission amplitudes were attained.

Final radiated emissions measurements were made on the three/ten-meter, open-field test site. The EUT was placed on a nonconductive turntable 0.8 meters above the ground plane. The spectrum was examined from 9 kHz to the 10<sup>th</sup> harmonic of the highest fundamental transmitter frequency (9.08 GHz).

At each frequency, the EUT was rotated 360°, and the antenna was raised and lowered from 1 to 4 meters in order to determine the emission's maximum level. Measurements were taken using both horizontal and vertical antenna polarizations. For frequencies between 30 and 1000 MHz, the spectrum analyzer's 6 dB bandwidth was set to 120 kHz, and the analyzer was operated in the CISPR quasi-peak detection mode. For emissions above 1000 MHz, emissions are measured using the average detector function with a minimum resolution bandwidth of 1 MHz. No video filter less than 10 times the resolution bandwidth was used. The highest emission amplitudes relative to the appropriate limit were measured and recorded in this report.

**Table 3-1: Radiated Emissions Test Equipment**

RTL Asset #	Manufacturer	Model	Part Type	Serial Number	Calibration Due Date
900151	Rohde and Schwarz	HFH2-Z2	Loop Antenna (9 kHz-30 MHz)	827525/019	10/1/14
900932	Hewlett Packard	8449B OPT H02	Preamplifier (1-26.5 GHz)	3008A00505	8/27/14
900905	Rhein Tech Laboratories	PR-1040	OATS 1 Preamplifier 40dB (30 MHz-2 GHz)	1006	9/4/14
900878	Rhein Tech Laboratories	AM3-1197-0005	3 meter antenna mast, polarizing	Outdoor Range 1	Not Required
901593	Insulated Wire Inc.	KPS-1503-360-KPR	SMK RF Cables 36"	NA	8/27/14
901592	Insulated Wire Inc.	KPS-1503-3600-KPR	SMK RF Cables 20'	NA	8/27/14
901242	Rhein Tech Laboratories	WRT-000-0003	Wood rotating table	N/A	Not Required
900913	Hewlett Packard	85462A	EMI Receiver RF Section (9 kHz-6.5 GHz)	3325A00159	11/14/14
900914	Hewlett Packard	85460A	RF Filter Section (100 kHz-6.5 GHz)	3330A00107	11/14/14
900772	EMCO	3161-02	Horn Antenna (2-4 GHz)	9804-1044	4/20/15
900321	EMCO	3161-03	Horn Antenna (4.0-8.2 GHz)	9508-1020	4/20/15
900323	EMCO	3160-07	Horn Antenna (8.2-12.4 GHz)	9605-1054	4/20/15
900356	EMCO	3160-08	Horn Antenna (12.4-18 GHz)	9607-1044	4/20/15
900325	EMCO	3160-9	Horn Antenna (18-26.5 GHz)	9605-1051	4/19/15
901581	Rohde & Schwarz	FSU	Spectrum Analyzer	1166.1660.50	11/13/14
900724	Antenna Research Associates, Inc.	LPB-2520	BiLog Antenna (25-1000 MHz)	1037	4/19/15

### 3.3 Radiated Emissions Test Results

**Table 3-2: Radiated Emissions with ISDB on Board Test Data**

Emission Frequency (MHz)	Peak Detector Level (dBuV/m) (1 MHz RBW/VBW)	Site Correction Factor (dB/m)	Peak Corrected (dBuV/m)	Limit (dBuV/m)	Margin (dB)
908.4	64.0	25.1	89.1	94.0	-4.9

\* testing performed at 3m

### 3.4 Radiated Emissions Harmonics/Spurious with ISDB on Board Test Data

**Table 3-3: Peak Radiated Emissions Harmonics/Spurious – 908.4 MHz**

Emission Frequency (MHz)	Peak Detector (dBuV/m) (1 MHz RBW/VBW)	Site Correction Factor (dB/m)	Peak Corrected (dBuV/m)	Peak Limit (dBuV/m)	Peak Margin (dB)
1816.794	10.4	31.7	42.1	74.0	-31.9
2725.191	60.8	-9.1	51.7	74.0	-22.3
3633.588	42.3	-5.5	36.8	74.0	-37.2
4541.985	43.3	-1.4	41.9	74.0	-32.1
5450.382	43.5	-0.8	42.7	74.0	-31.3
6358.779	43.0	0.0	43.0	74.0	-31.0
7267.176	42.0	0.9	42.9	74.0	-31.1
8175.573	42.9	5.9	48.8	74.0	-25.2

**Table 3-4: Radiated Emissions Harmonics/Spurious – 908.4 MHz**

Emission Frequency (MHz)	Average Detector (dBuV/m) (1 MHz RBW/10 Hz VBW)	Site Correction Factor (dB/m)	Average Corrected (dBuV/m)	Average Limit (dBuV/m)	Average Margin (dB)
1816.794	7.8	31.7	39.5	54.0	-14.5
2725.200	50.7	-9.1	41.6	54.0	-12.4
3633.600	30.0	-5.5	24.5	54.0	-29.5
4542.000	28.3	-1.4	26.9	54.0	-27.1
5450.400	28.6	-0.8	27.8	54.0	-26.2
6358.779	28.4	0.0	28.4	54.0	-25.6
7267.200	27.6	0.9	28.5	54.0	-25.5
8175.600	28.5	5.9	34.4	54.0	-19.6

### 3.5 Radiated Emissions Digital/Receive Test Data

**Table 3-5: Digital/Receive Radiated Emissions Test Data**

Temperature: 82.2°F Humidity: 40%										
Emission Frequency (MHz)	Test Detector	Antenna Polarity (H/V)	Turntable Azimuth (deg)	Antenna Height (m)	Analyzer Reading (dBuV)	Site Correction Factor (dB/m)	Emission Level (dBuV/m)	Limit (dBuV/m)	Margin (dB)	Pass/Fail
40.000	Qp	V	0	1.0	34.1	-16.4	17.7	40.0	-22.3	Pass
60.000	Qp	H	0	1.0	33.5	-21.4	12.1	40.0	-27.9	Pass
80.000	Qp	H	0	1.0	32.2	-25.2	7.0	40.0	-33.0	Pass
81.375	Qp	V	180	1.0	41.7	-25.0	16.7	40.0	-23.3	Pass
85.500	Qp	V	180	1.0	40.3	-24.5	15.8	40.0	-24.2	Pass
120.000	Qp	V	0	1.0	34.5	-19.8	14.7	43.5	-28.8	Pass
140.000	Qp	H	0	1.0	31.4	-22.1	9.3	43.5	-34.2	Pass
160.000	Qp	H	0	1.0	31.7	-23.0	8.7	43.5	-34.8	Pass
180.000	Qp	H	0	1.0	34.8	-22.0	12.8	43.5	-30.7	Pass
200.000	Qp	H	0	1.0	37.4	-20.8	16.6	43.5	-26.9	Pass

Note: radiated emissions were investigated with the module collocated and transmitting simultaneously with the following modularly approved device: FCC ID: YL6-143IS205V4 (IC: 9111A-143IS205V4)

No non-compliant emissions were found; per FCC guidance, no data is being reported.

**Test Personnel:**

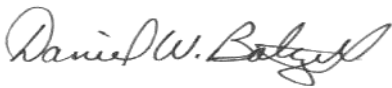
Daniel W. Baltzell Test Engineer	 Signature	August 25, 2014 Date of Test
-------------------------------------	--	---------------------------------

#### 4 AC Conducted Emissions - FCC 15.207; RSS-Gen 7.2.4: Conducted Limits

##### 4.1 Site and Test Description

The power line conducted emissions measurements were performed in a Series 81 type shielded enclosure manufactured by Rayproof. The EUT was assembled on a wooden table 80 centimeters high. Power was fed to the EUT through a 50-ohm/50 microhenry Line Impedance Stabilization Network (LISN). The EUT LISN was fed power through an A.C. filter box on the outside of the shielded enclosure. The filter box and EUT LISN housing are bonded to the ground plane of the shielded enclosure. A second LISN, the peripheral LISN, provides isolation for the EUT test peripherals. This peripheral LISN was also fed A.C. power. A metal power outlet box, which is bonded to the ground plane and electrically connected to the peripheral LISN, powers the EUT host peripherals.

The spectrum analyzer was connected to the AC line through an isolation transformer. The 50-ohm output of the EUT LISN was connected to the spectrum analyzer input through a Solar 100 kHz high-pass filter. The filter is used to prevent overload of the spectrum analyzer from noise below 100 kHz. Conducted emission levels were measured on each current-carrying line with the spectrum analyzer operating in the CISPR quasi-peak mode (or peak mode if applicable).

The analyzer's 6 dB bandwidth was set to 9 kHz. Video filter less than 10 times the resolution bandwidth is not used. Average measurements are performed in linear mode using a 10 kHz resolution bandwidth, a 1 Hz video bandwidth, and by increasing the sweep time in order to obtain a calibrated measurement. The emission spectrum was scanned from 150 kHz to 30 MHz. The highest emission amplitudes relative to the appropriate limits were measured and have been recorded.

##### 4.2 Test Limits

Line-Conducted Emissions		
Limit (dB $\mu$ V)		
Frequency (MHz)	Quasi-Peak	Average
0.15 to 0.50	66 to 56	56 to 46
0.50 to 5.00	56	46
5.00 to 30.00	60	50

### 4.3 Conducted Emissions Test Data

Plot 4-1: Conducted Emissions Transmit - Neutral Side – Z-Wave Module

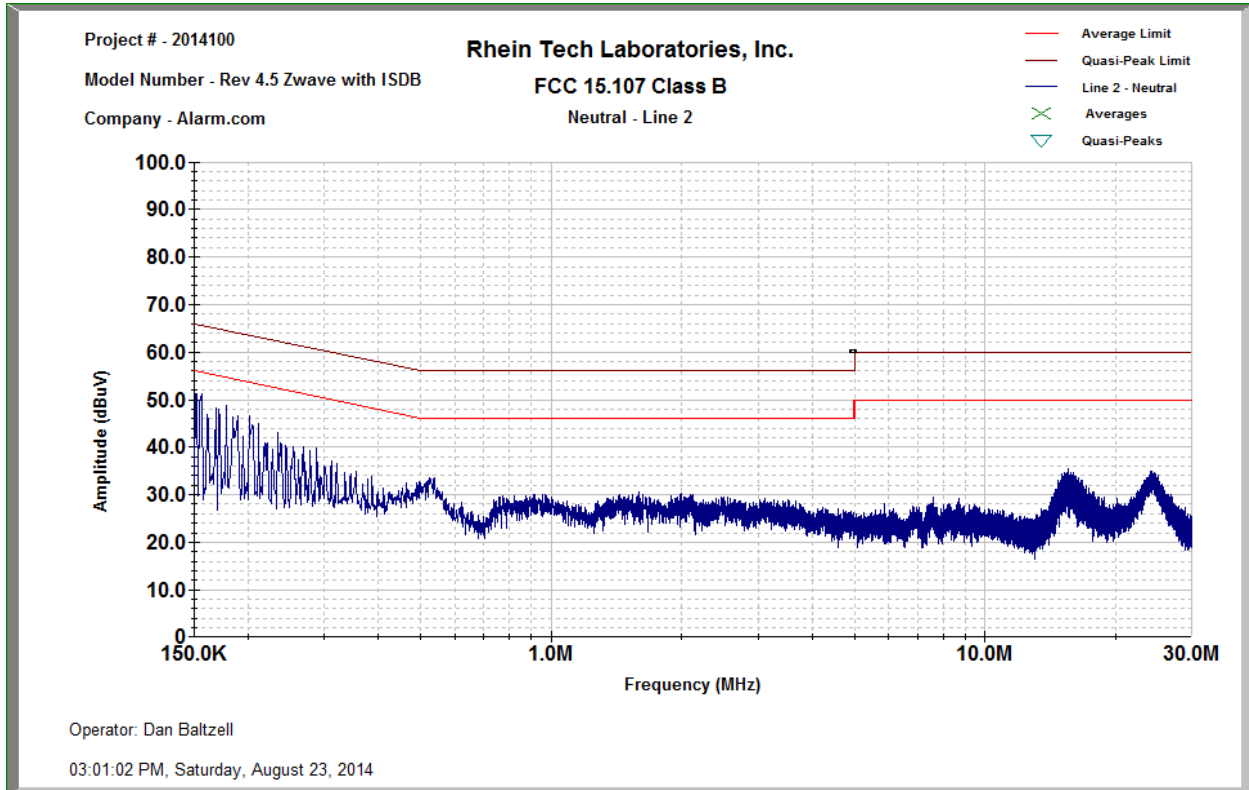

**Plot 4-2: Conducted Emissions Transmit - Hot Side – Z-Wave Module**

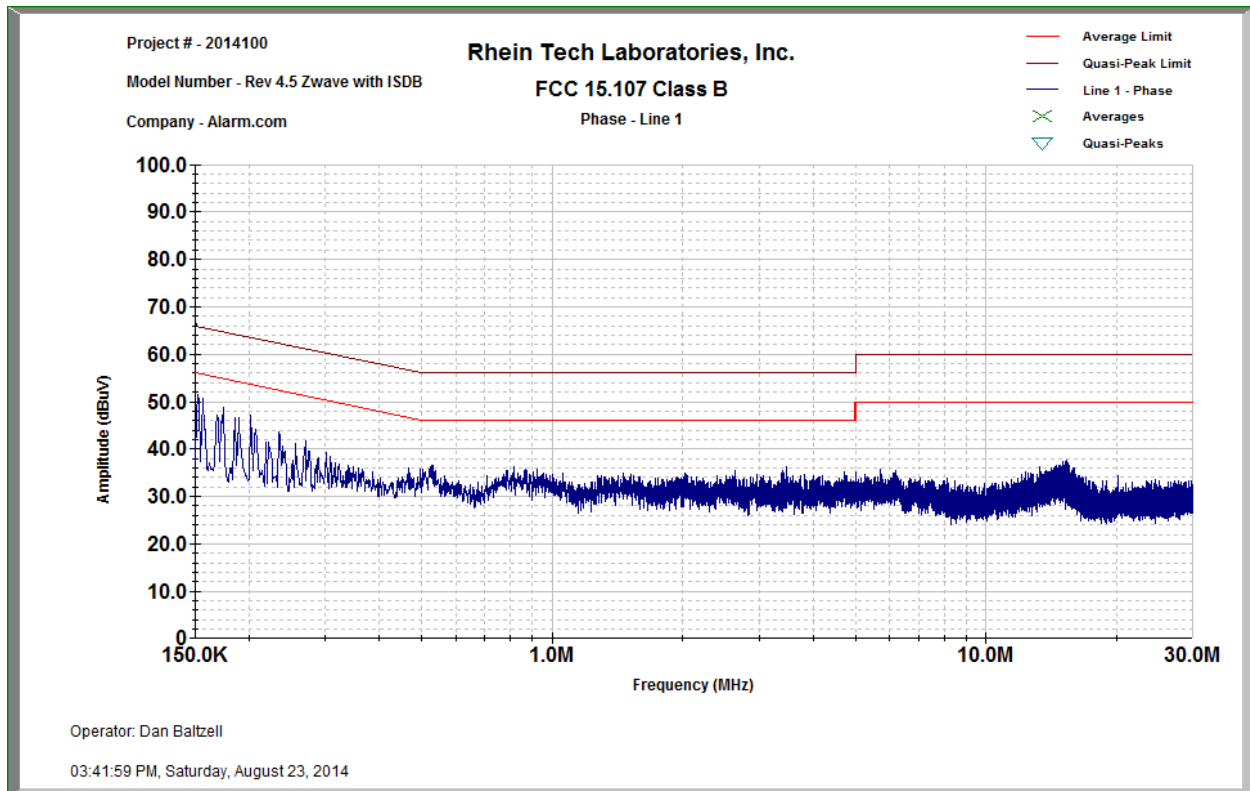

**Plot 4-3: Conducted Emissions Receive - Neutral Side – Z-Wave Module**

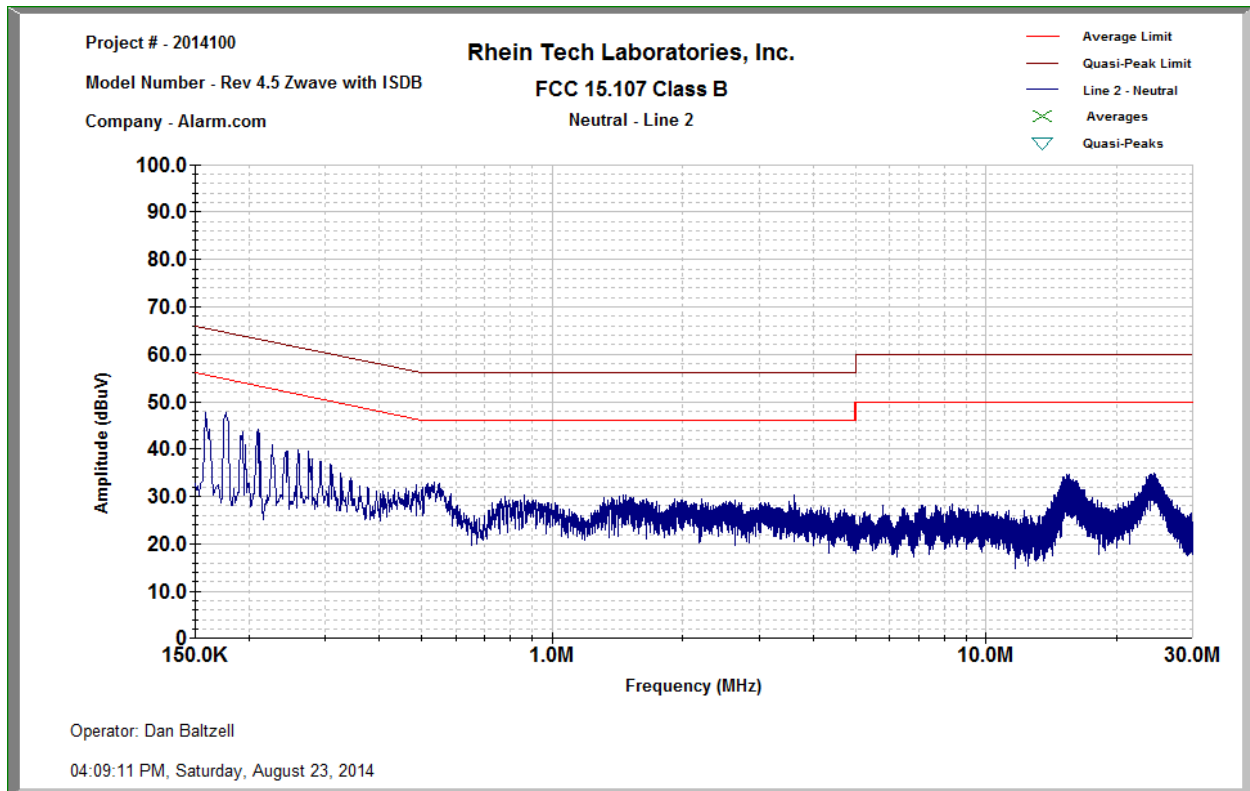



**Plot 4-4: Conducted Emissions Receive - Hot Side – Z-Wave Module**

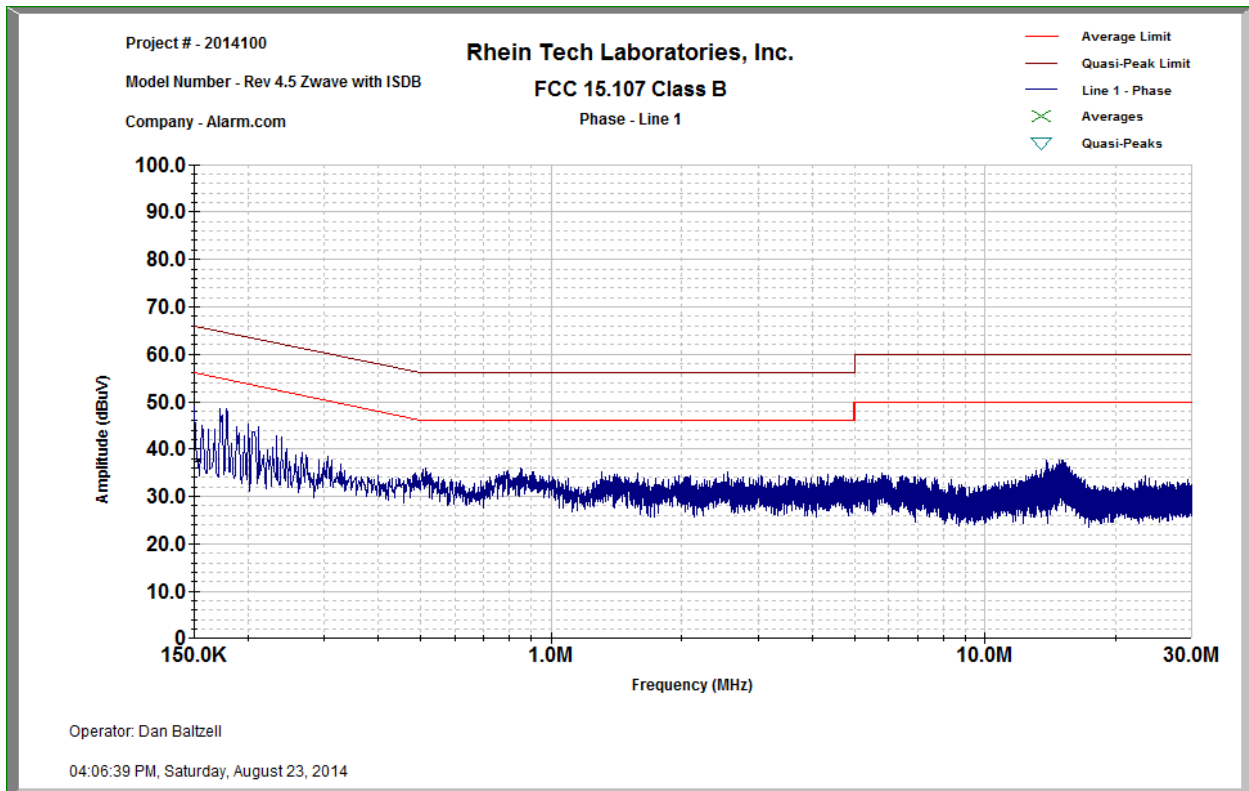

**Table 4-1: Conducted Emissions Test Equipment**

RTL Asset #	Manufacturer	Model	Part Type	Serial Number	Calibration Due Date
901583	Agilent Technologies	N9010A	EXA Signal Analyzer (10 Hz-26.5 GHz)	MY51250846	4/16/15
901083	AFJ International	LS16	16A LISN (110 V)	16010020080	8/27/14
N/A	ETS-Lindgren	TILE	Emissions Testing Software Rev. 7	N/A	N/A

**Test Personnel:**

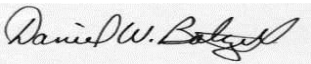
Daniel W. Baltzell Test Engineer	 Signature	August 23, 2014 Date of Test
-------------------------------------	--	---------------------------------

**5 20 dB Bandwidth – IC RSS-Gen**

**5.1 20 dB Bandwidth Test Procedure**

The minimum 20 dB bandwidths per RSS-Gen were measured using a 50-ohm spectrum analyzer. The modulated carrier was adjusted on the analyzer so that it was displayed entirely on the spectrum analyzer. The sweep time was auto and allowed through several sweeps with the max hold function used in peak detector mode. The resolution bandwidth was set to 100 kHz, and the video bandwidth set to 1 MHz. The table below contains the bandwidth measurement results.

**Table 5-1: 20 dB Bandwidth Test Equipment**

RTL Asset #	Manufacturer	Model	Part Type	Serial Number	Calibration Due Date
901581	Rohde & Schwarz	FSU	Spectrum Analyzer	1166.1660.50	11/13/14

**5.2 20 dB Modulated Bandwidth Test Data**

**Table 5-2: 20 dB Modulated Bandwidth Test Data**

**Minimum 20 dB bandwidths**

Frequency (MHz)	20 dB Bandwidth (kHz)
908.4	105.8

### 5.3 20 dB Bandwidth Plots

Plot 5-1: 20 dB Bandwidth; 908.4 MHz

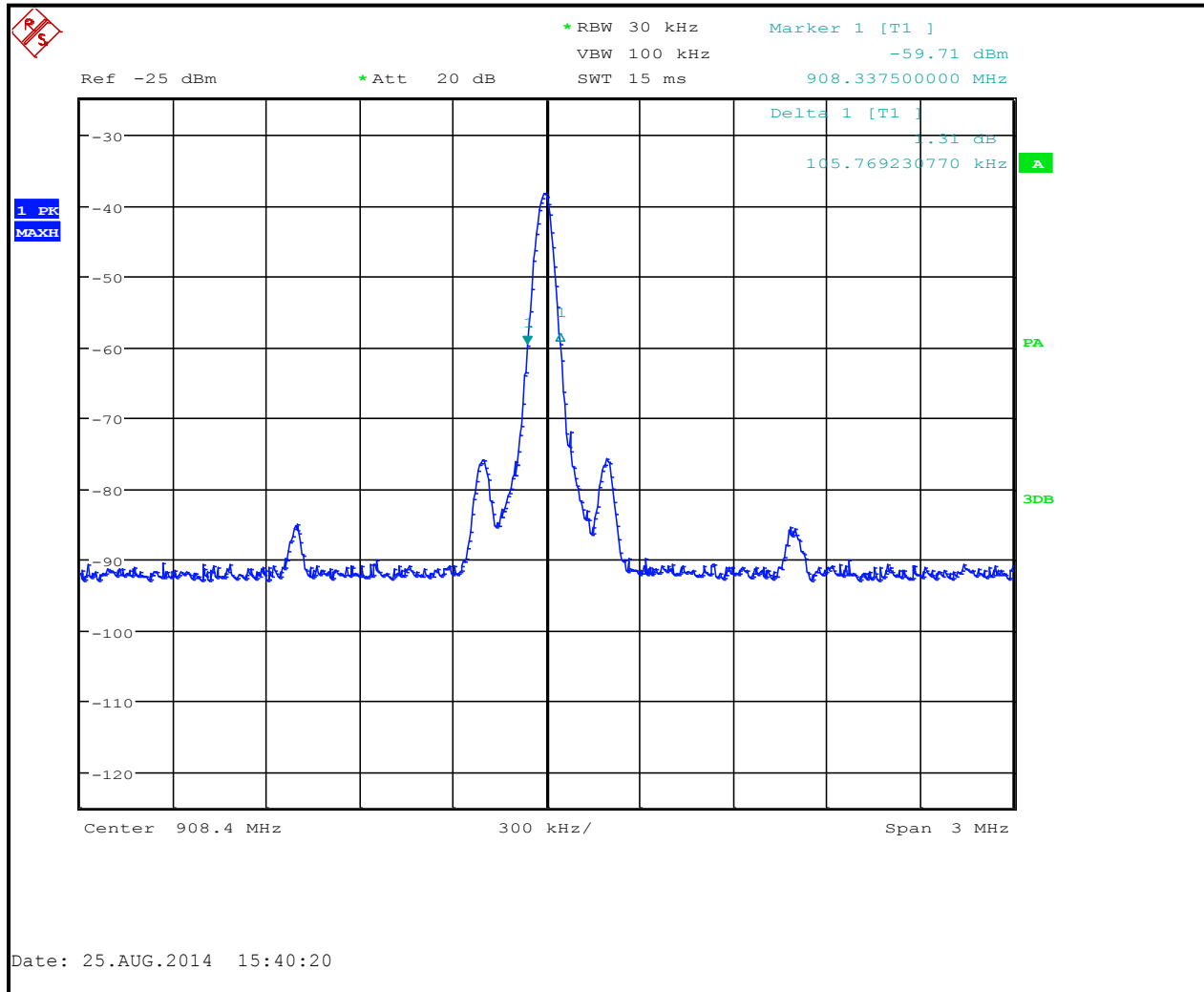

#### Test Personnel:

Daniel W. Baltzell  
Test Engineer

Signature

August 25, 2014  
Date of Test

Rhein Tech Laboratories, Inc.  
360 Herndon Parkway  
Suite 1400  
Herndon, VA 20170  
<http://www.rheintech.com>

Client: Alarm.com  
Model: ADC-450L  
Standards: FCC 15.249/IC RSS-210  
IDs: YL6-143450L/9111A-143450L  
Report #: 2014100

## **6 Conclusion**

The data in this measurement report shows that the EUT as tested, Alarm.com, Model: ADC-450L, FCC ID: YL6-143450L, IC: 9111A-143450L, complies with all the applicable requirements of Parts 2 and 15 of the FCC Rules and Regulations, and IC RSS-210 and RSS-Gen for modular approval.

**Appendix A: FCC Part 1.1307, 1.1310, 2.1091, 2.1093; IC RSS-Gen: RF Exposure**

**MPE Calculation – Co-Location of Z-wave module FCC ID: YL6-143450L and FCC ID: YL6-143IS205V4**

Equation from page 18 of OET 65, Edition 97-01:  $S = \text{EIRP} / (4 \pi R^2)$

**FCC ID: YL6-143IS205V4**

EUT operating frequency range: 912 - 924 MHz.

Therefore, limit for uncontrolled exposure:  $0.6 \text{ mW/cm}^2$

EIRP = 16 mW

$S = 16 / (4 * 3.14 * 20^2) = 0.0032 \text{ mW/cm}^2$  at 20 cm separation

**FCC ID: YL6-143450L**

EUT operating frequency: 908.4 MHz.

Therefore, limit for uncontrolled exposure:  $0.6 \text{ mW/cm}^2$

Field strength = 89.1 dBuV/m @ 3 m

Using  $\text{EIRP} = E + 20 \log(d) - 104.8 = 89.1 + 20 \log(3) - 104.8 = -6.16 \text{ dBm} = \underline{0.24 \text{ mW}}$

$S = 0.24 / (4 * 3.14 * 20^2) = 0.00005 \text{ mW/cm}^2$  at 20 cm separation

**MPE Summary**

FCC ID	Frequency Range (MHz)	MPE (mW/cm <sup>2</sup> )	Limit (mW/cm <sup>2</sup> )
YL6-143IS205V4	912 – 924	0.0032	0.6
YL6-143450L	908.4	0.00005	0.6

FCC requirement:  $\text{MPE1} + \text{MPE2} < 0.6$

Combined MPE =  $0.00325 \text{ mW/cm}^2$

MPE as a fraction of the limit:  $0.00325 / 0.6 = 0.54\%$

Therefore, the uncontrolled exposure limit is met at 20 cm when both transmitters are operating simultaneously.

Rhein Tech Laboratories, Inc.  
360 Herndon Parkway  
Suite 1400  
Herndon, VA 20170  
<http://www.rheintech.com>

Client: Alarm.com  
Model: ADC-450L  
Standards: FCC 15.249/IC RSS-210  
IDs: YL6-143450L/91111A-143450L  
Report #: 2014100

**Appendix B: Agency Authorization Letter**

Please refer to the following page.

Rhein Tech Laboratories, Inc.  
360 Herndon Parkway  
Suite 1400  
Herndon, VA 20170  
<http://www.rheintech.com>

Client: Alarm.com  
Model: ADC-450L  
Standards: FCC 15.249/IC RSS-210  
IDs: YL6-143450L/91111A-143450L  
Report #: 2014100

**Appendix C: FCC Confidentiality Request Letter**

Please refer to the following page.



Rhein Tech Laboratories, Inc.  
360 Herndon Parkway  
Suite 1400  
Herndon, VA 20170  
<http://www.rheintech.com>

Client: Alarm.com  
Model: ADC-450L  
Standards: FCC 15.249/IC RSS-210  
IDs: YL6-143450L/9111A-143450L  
Report #: 2014100

**Appendix D: FCC Part 15 Unlicensed Modular Transmitter Equipment Approval**

Please refer to the following page.

Rhein Tech Laboratories, Inc.  
360 Herndon Parkway  
Suite 1400  
Herndon, VA 20170  
<http://www.rheintech.com>

Client: Alarm.com  
Model: ADC-450L  
Standards: FCC 15.249/IC RSS-210  
IDs: YL6-143450L/91111A-143450L  
Report #: 2014100

**Appendix E: IC Letters**

Please refer to the following pages.

**Appendix F: Canadian Based Representative Attestation Letter**

CANADIAN REPRESENTATIVE LETTER OF ATTESTATION

**Canadian Representative**

Company Name: Canadian Radio Standards Consulting Inc.  
Industry Canada Agent Number: 4000A.  
Contact Name: Kwai Lum  
Address: 6038 Vineyard Drive, Ottawa, Ontario, K1C2M5  
Telephone No: (1) 613-8246438  
Fax No: (1) 613- 8246438  
Email: Lumkwai@rogers.com

To: Industry Canada  
3701 Carling Ave., Bldg. 94,  
Ottawa, ON, K2H 8S2

ATTENTION: Certification and Engineering Bureau

This letter is to confirm that we have accepted the responsibility to act as Canadian Representative on behalf of the Applicant noted below for Industry Canada certification/registration.

As Canadian Representative, we are aware of the requirements involved as outlined in Industry Canada applicable documents (RSP-100, Section 3.4 and/or DC-01, Section 6.5.2-6.5.3).

**Applicant**

Company name: Alarm.com Incorporated  
Contact Name: Daniel Ramos  
Address: 8150 Leesburg Pike, Suite 1400 Vienna, VA 22182  
Telephone -No: 703-962-1881  
Fax No: 703-940-8990  
Email: [dramos@alarm.com](mailto:dramos@alarm.com)  
Model Nos.: ADC-450L  
IC Cert. # : 9111A-143450L

This Agreement is valid ONLY for the model ADC-450L and valid until notified otherwise by the Canadian Representative.



Signature:  
Signed by Kwai Lum (Canadian Radio Standards Consulting Inc.)  
Date: Sept 12, 2014

Rhein Tech Laboratories, Inc.  
360 Herndon Parkway  
Suite 1400  
Herndon, VA 20170  
<http://www.rheintech.com>

Client: Alarm.com  
Model: ADC-450L  
Standards: FCC 15.249/IC RSS-210  
IDs: YL6-143450L/91111A-143450L  
Report #: 2014100

**Appendix G: IC Confidentiality Request Letter**

Please refer to the following page.

Rhein Tech Laboratories, Inc.  
360 Herndon Parkway  
Suite 1400  
Herndon, VA 20170  
<http://www.rheintech.com>

Client: Alarm.com  
Model: ADC-450L  
Standards: FCC 15.249/IC RSS-210  
IDs: YL6-143450L/9111A-143450L  
Report #: 2014100

**Appendix H: RSS-Gen 3.2.3 Modular Approval**

Please refer to the following page.

**Appendix I: Label and Label Location**

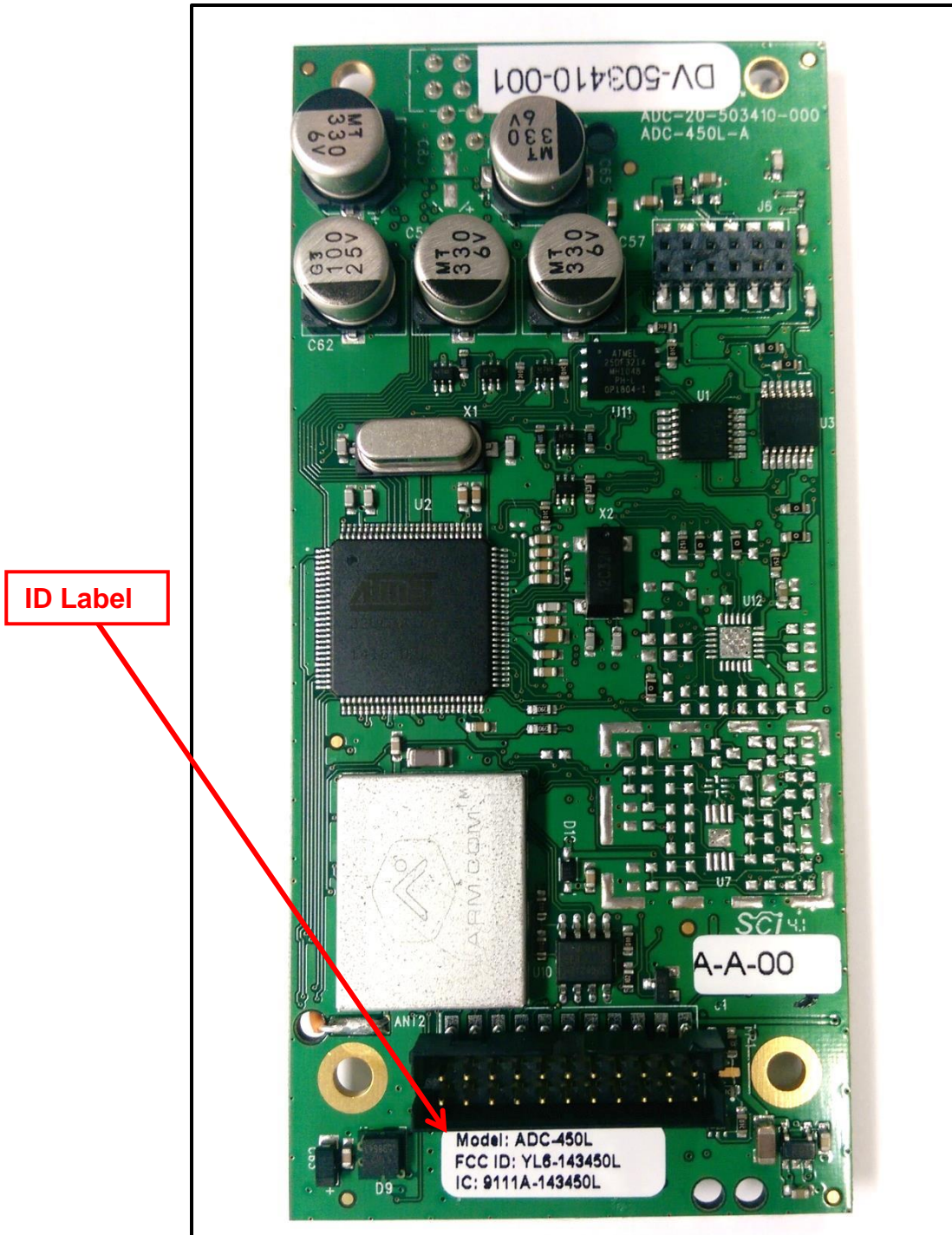

**Photograph 1: ID Label on Back of EUT**



Photograph 2: "Contains FCC ID....." Label Sample for Host

Rhein Tech Laboratories, Inc.  
360 Herndon Parkway  
Suite 1400  
Herndon, VA 20170  
<http://www.rheintech.com>

Client: Alarm.com  
Model: ADC-450L  
Standards: FCC 15.249/IC RSS-210  
IDs: YL6-143450L/91111A-143450L  
Report #: 2014100

**Appendix J: Technical Operational Description**

Please refer to the following page.



Rhein Tech Laboratories, Inc.  
360 Herndon Parkway  
Suite 1400  
Herndon, VA 20170  
<http://www.rheintech.com>

Client: Alarm.com  
Model: ADC-450L  
Standards: FCC 15.249/IC RSS-210  
IDs: YL6-143450L/91111A-143450L  
Report #: 2014100

**Appendix K: Schematics**

Please refer to the following pages.

Rhein Tech Laboratories, Inc.  
360 Herndon Parkway  
Suite 1400  
Herndon, VA 20170  
<http://www.rheintech.com>

Client: Alarm.com  
Model: ADC-450L  
Standards: FCC 15.249/IC RSS-210  
IDs: YL6-143450L/91111A-143450L  
Report #: 2014100

**Appendix L: Block Diagram**

Please refer to the following page.

Rhein Tech Laboratories, Inc.  
360 Herndon Parkway  
Suite 1400  
Herndon, VA 20170  
<http://www.rheintech.com>

Client: Alarm.com  
Model: ADC-450L  
Standards: FCC 15.249/IC RSS-210  
IDs: YL6-143450L/91111A-143450L  
Report #: 2014100

**Appendix M: Manual**

Please refer to the following pages.

**Appendix N: Test Photographs**

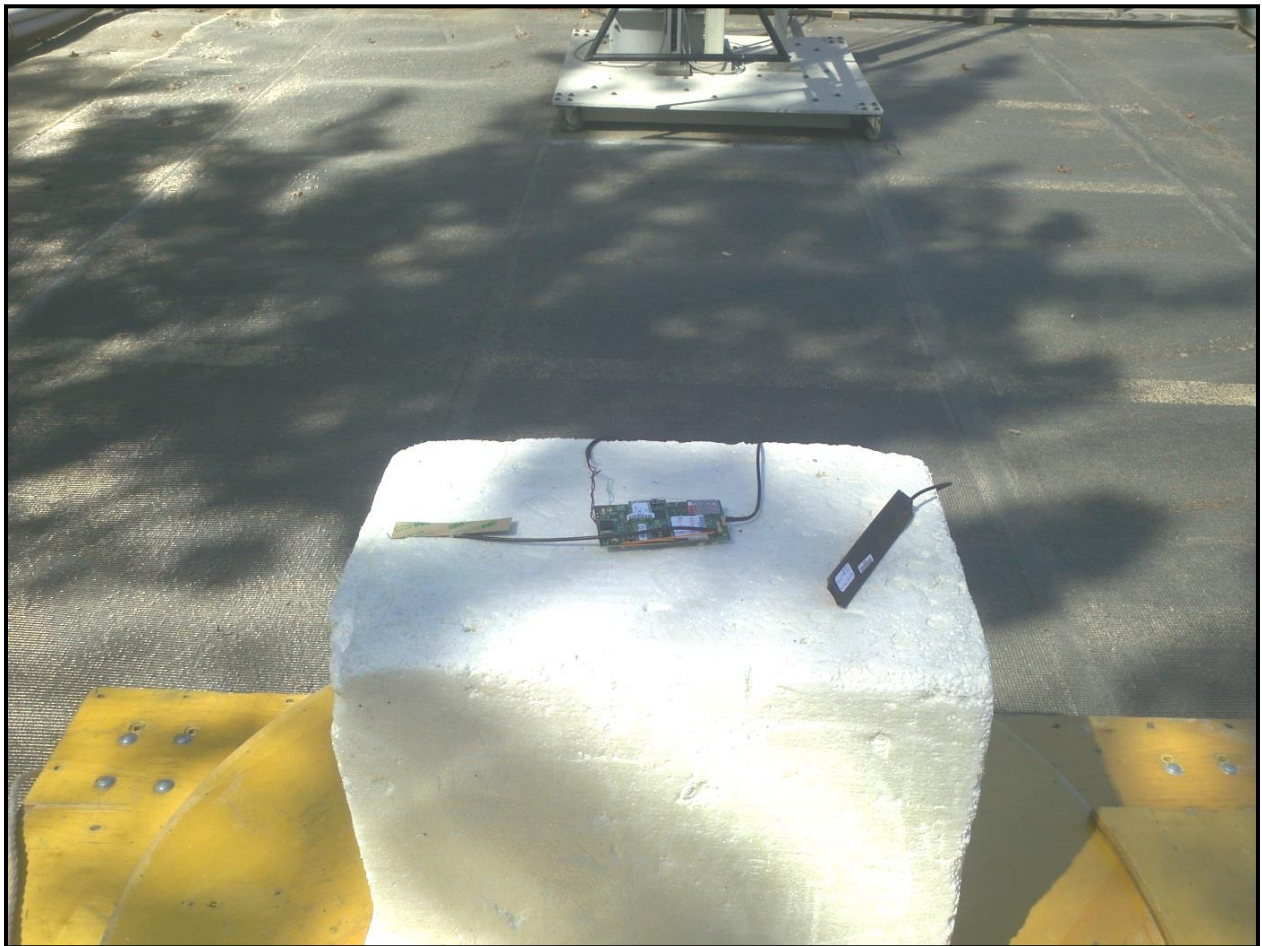

**Photograph 3: Radiated Emissions Testing – Front View**

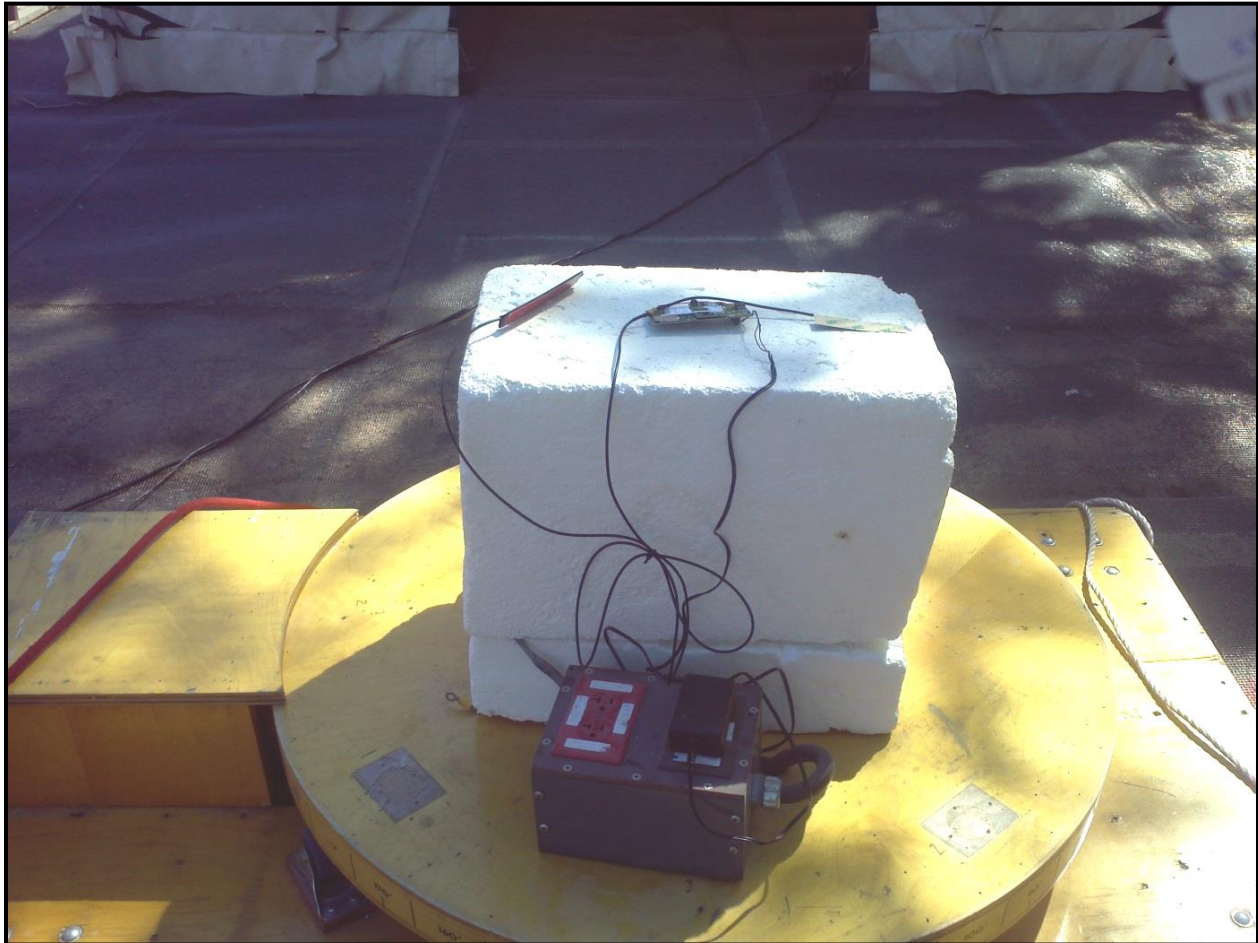

**Photograph 4: Radiated Emissions Testing – Back View**



**Photograph 5: Conducted AC Testing – Front View**



**Photograph 6: Conducted AC Testing – Back View**

**Appendix O: External Photographs**



**Photograph 7: EUT Front View**



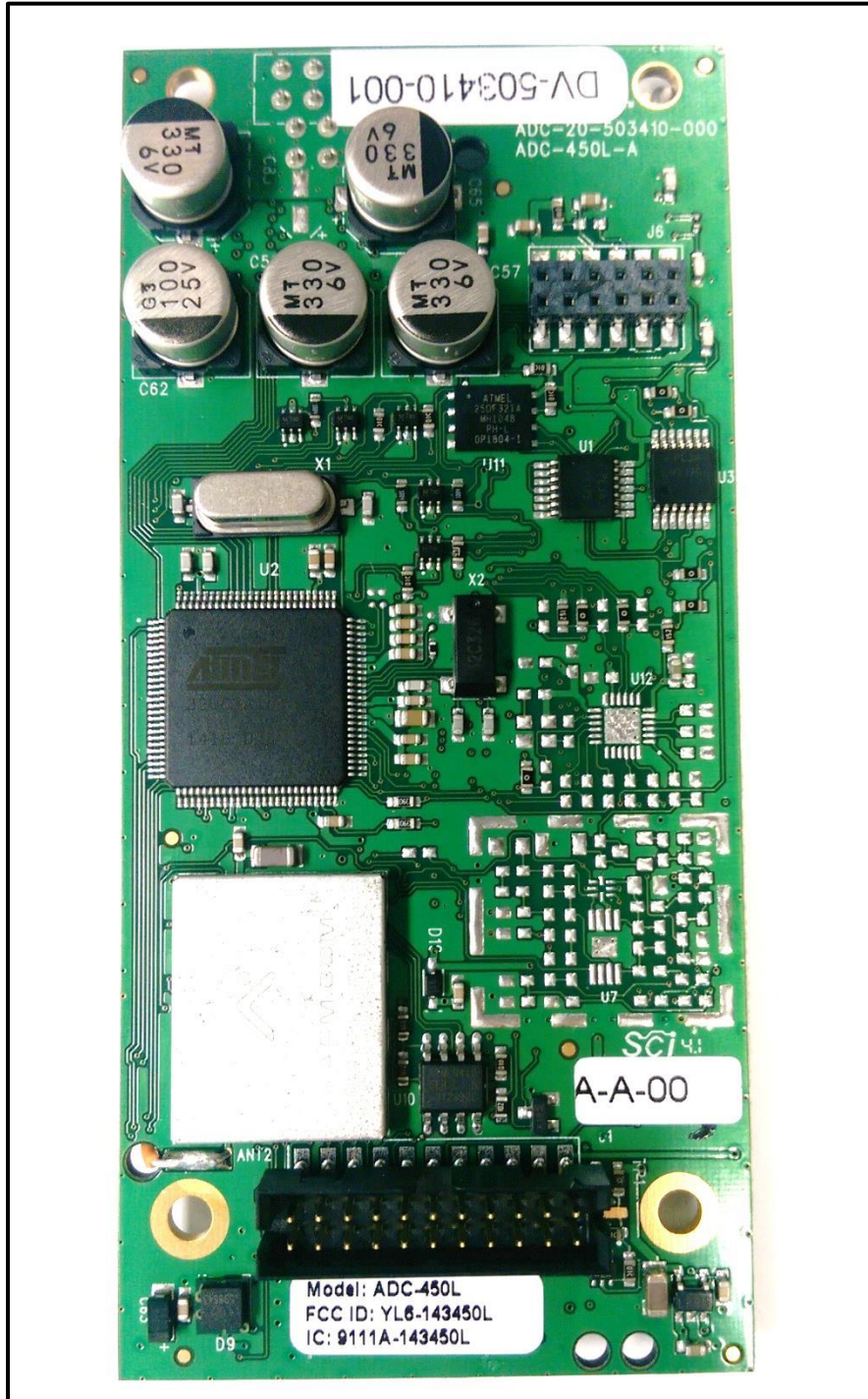

Photograph 8: EUT Back View with Shield

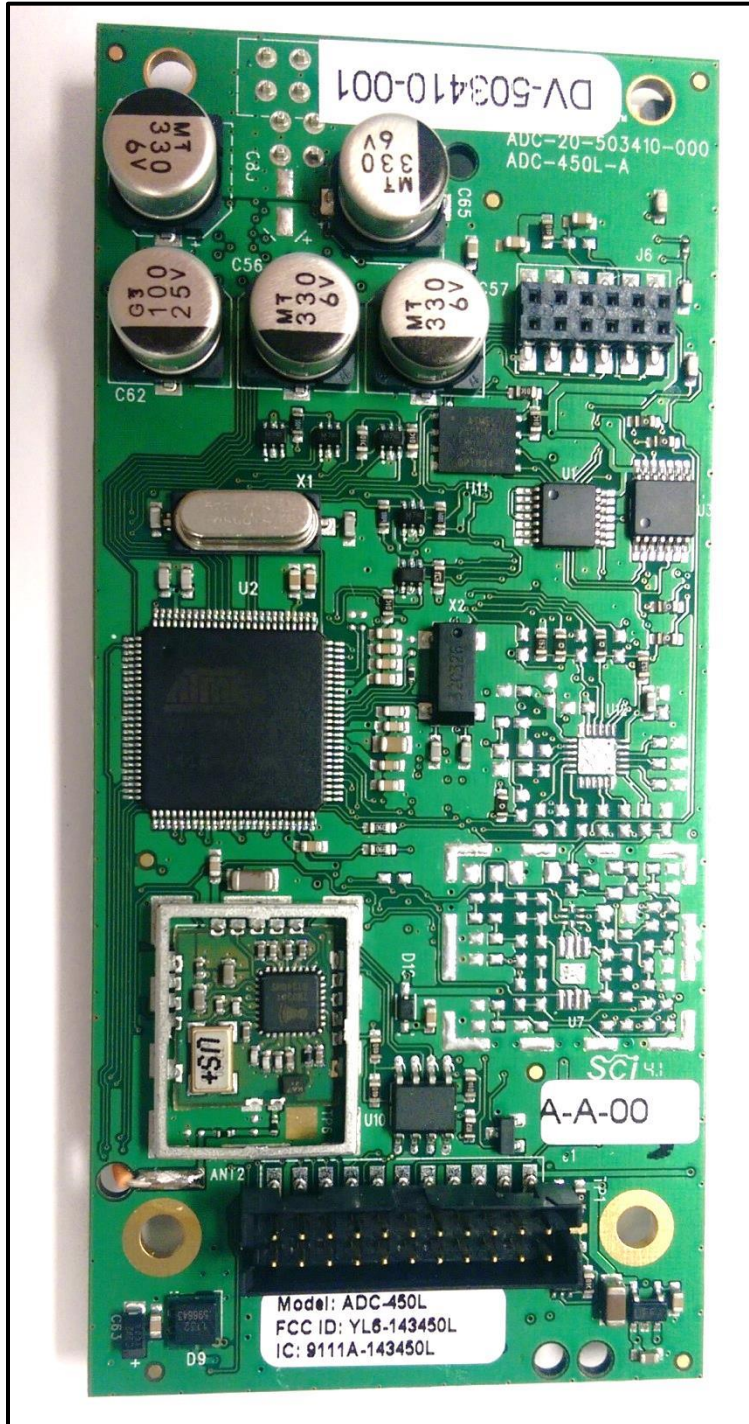

Photograph 9: EUT Back View without Shields



Photograph 10: Sample Host

**Appendix P: Internal Photographs**



**Photograph 11: EUT Front View**

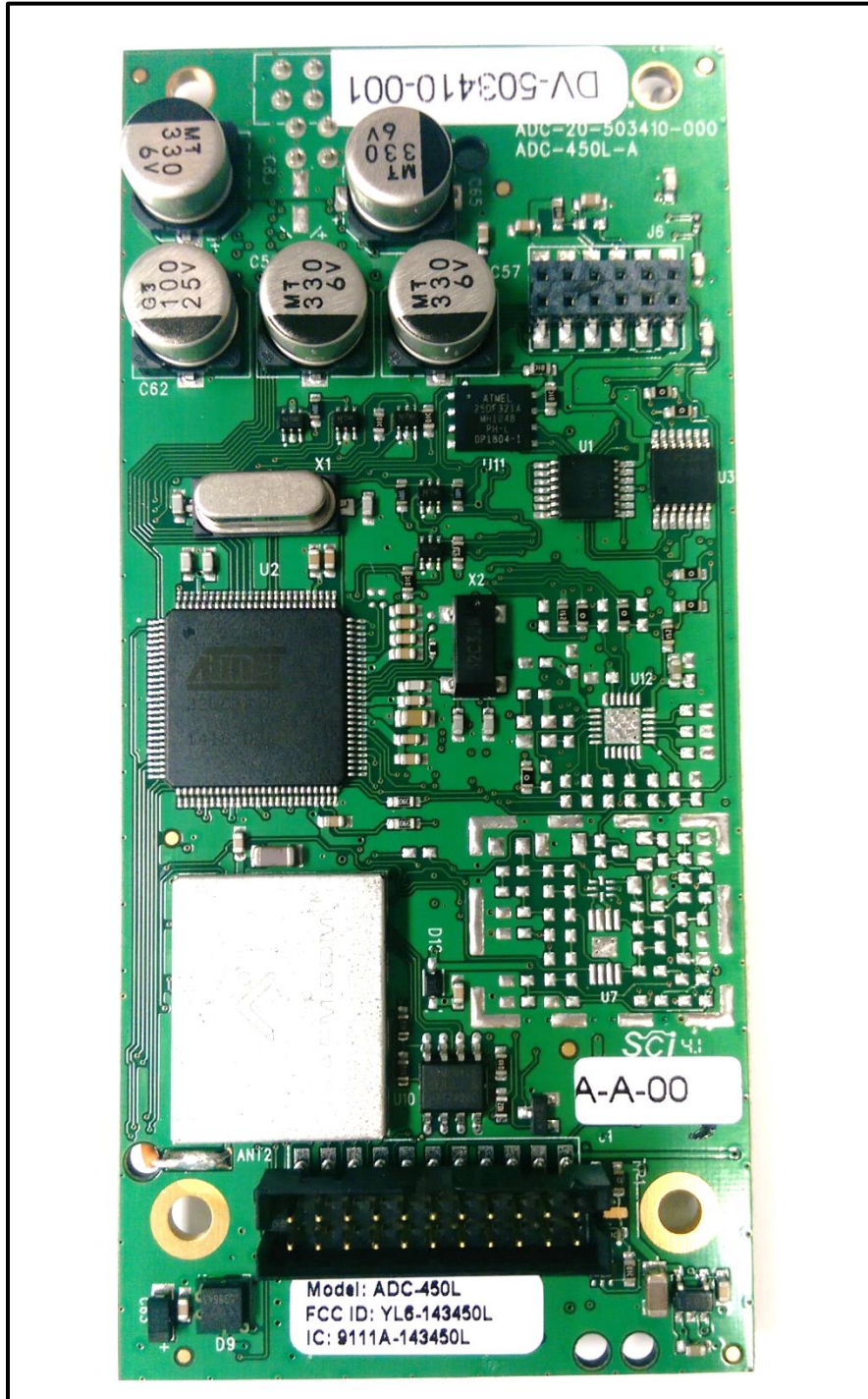

Photograph 12: EUT Back View with Shield

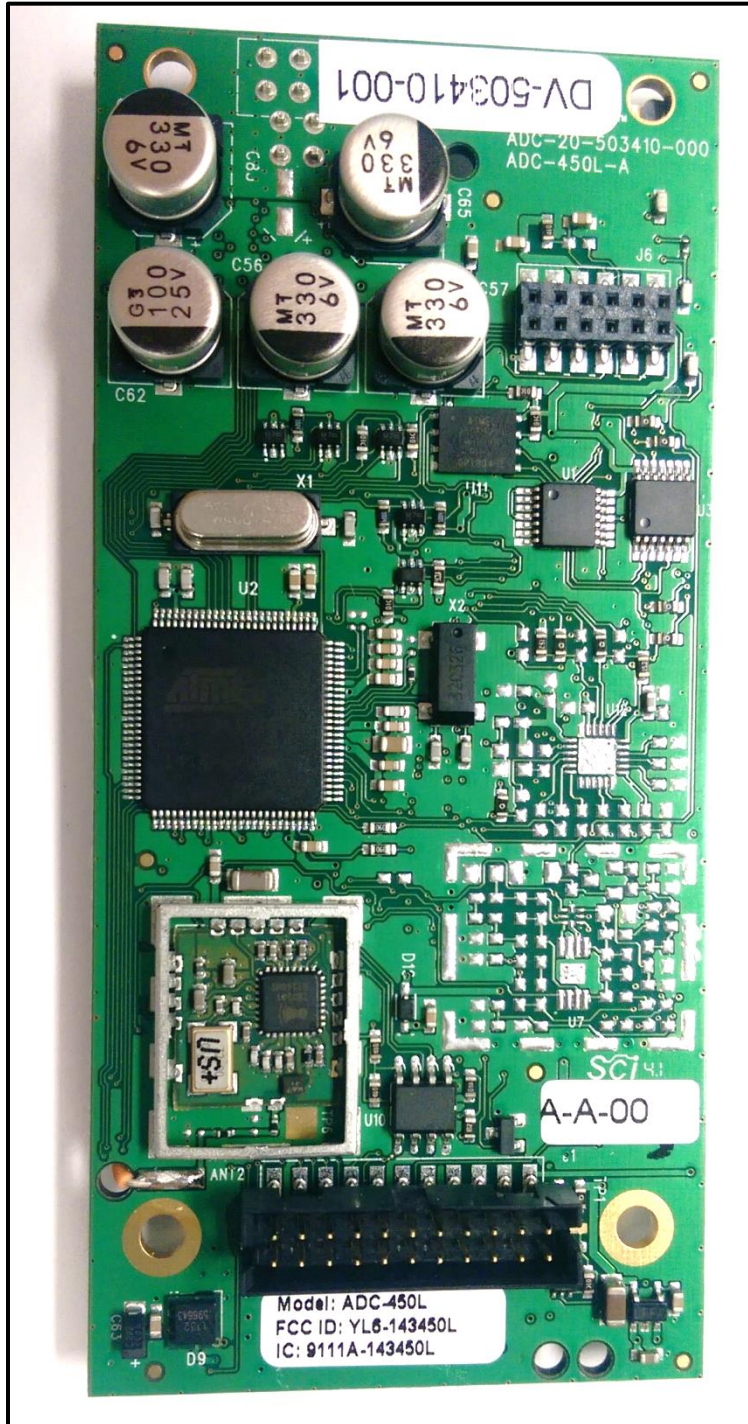

Photograph 13: EUT Back View without Shield