



MET Laboratories, Inc. *Safety Certification - EMI - Telecom Environmental Simulation*
914 WEST PATAPSCO AVENUE • BALTIMORE, MARYLAND 21230 • PHONE (410) 354-3300 • FAX (410) 354-3313

February 14, 2011

Alarm.com
8150 Leesburg Pike, Suite 1400
Vienna, VA 22182

Dear David Goldfarb,

Enclosed is the EMC Wireless test report for compliance testing of the Alarm.com, ADC-200T-EVD as tested to the requirements of Title 47 of the CFR, Ch. 1 (10-1-06 ed.), Part 15, Subpart B, ICES-003, Issue 4 February 2004 for a Class B Digital Device and FCC Part 15 Subpart C, RSS-210, Issue 8, December 2010 for Intentional Radiators.

Thank you for using the services of MET Laboratories, Inc. If you have any questions regarding these results or if MET can be of further service to you, please feel free to contact me.

Sincerely yours,
MET LABORATORIES, INC.

Jennifer Warnell
Documentation Department

Reference: (\Alarm.com\EMC30291-FCC249)

Certificates and reports shall not be reproduced except in full, without the written permission of MET Laboratories, Inc.

Electromagnetic Compatibility Criteria Test Report

for the

**Alarm.com
ADC-200T-EVD**

Verified under
the FCC Certification Rules
contained in
Title 47 of the CFR, Parts 15 Subpart B & ICES-003
for Class B Digital Devices
&
15.249 Subpart C & RSS-210, Issue 8, December 2010
for Intentional Radiators

MET Report: EMC30291-FCC249

February 14, 2011

Prepared For:

**Alarm.com
8150 Leesburg Pike, Suite 1400
Vienna, VA 22182**

Prepared By:
MET Laboratories, Inc.
914 W. Patapsco Ave.
Baltimore, MD 21230

**Electromagnetic Compatibility Criteria
Test Report**

for the

**Alarm.com
ADC-200T-EVD**

Tested Under

the FCC Certification Rules
contained in
Title 47 of the CFR, Parts 15 Subpart B & ICES-003
for Class B Digital Devices
&
15.249 Subpart C & RSS-210, Issue 8, December 2010
for Intentional Radiators



Len Knight, Project Engineer
Electromagnetic Compatibility Lab



Jennifer Warnell
Documentation Department

Engineering Statement: The measurements shown in this report were made in accordance with the procedures indicated, and the emissions from this equipment were found to be within the limits applicable. I assume full responsibility for the accuracy and completeness of these measurements, and for the qualifications of all persons taking them. It is further stated that upon the basis of the measurements made, the equipment tested is capable of operation in accordance with the requirements of the FCC Rules Parts 15B, 15.249 and Industry Canada standards ICES-003, Issue 4 February 2004, RSS-210, Issue 8, December 2010 under normal use and maintenance.



Shawn McMillen, Wireless Manager
Electromagnetic Compatibility Lab



Report Status Sheet

| Revision | Report Date | Reason for Revision |
|----------|-------------------|---------------------|
| Ø | February 14, 2011 | Initial Issue. |

Table of Contents

| | | |
|-------------|---|-----------|
| I. | Executive Summary | 1 |
| | A. Purpose of Test | 2 |
| | B. Executive Summary | 2 |
| II. | Equipment Configuration | 3 |
| | A. Overview | 4 |
| | B. References | 5 |
| | C. Test Site | 5 |
| | D. Description of Test Sample..... | 5 |
| | E. Equipment Configuration | 6 |
| | F. Ports and Cabling Information..... | 6 |
| | G. Mode of Operation..... | 7 |
| | H. Modifications..... | 7 |
| | a) Modifications to EUT..... | 7 |
| | b) Modifications to Test Standard..... | 7 |
| | I. Disposition of EUT..... | 7 |
| III. | Electromagnetic Compatibility Criteria for Unintentional Radiators | 8 |
| | § 15.107(a) Conducted Emissions Limits..... | 9 |
| | § 15.109(a) Radiated Emission Limits | 10 |
| IV. | Electromagnetic Compatibility Criteria for Intentional Radiators..... | 14 |
| | § 15.203 Antenna Requirement | 15 |
| | § 15.207(a) Conducted Emissions Limits..... | 16 |
| | § 15.249(a) Radiated Fundament and Harmonics | 17 |
| | 99% Bandwidth | 19 |
| | § 15.249(d) Spurious Emissions Requirements..... | 20 |
| | RSS-GEN Receiver Spurious Emissions..... | 24 |
| V. | Test Equipment | 26 |
| VI. | Certification & User's Manual Information..... | 28 |
| | A. Certification Information | 29 |
| | B. Label and User's Manual Information..... | 33 |
| VII. | ICES-003 Procedural & Labeling Requirements..... | 35 |

List of Tables

| | |
|---|----|
| Table 1. Executive Summary of EMC Part 15.249 Compliance Testing | 2 |
| Table 2. EUT Specifications | 4 |
| Table 3. Equipment Configuration | 6 |
| Table 4. Ports and Cabling Information | 6 |
| Table 5. Conducted Limits for Radio Frequency Devices calculated from FCC Part 15 Section 15.107(a) (b) | 9 |
| Table 6. Radiated Emissions Limits calculated from FCC Part 15, §15.109 (a) (b) | 10 |
| Table 7. Radiated Emissions Limits, Test Results, FCC Limits | 11 |
| Table 8. Radiated Emissions Limits, Test Results, ICES-003 | 12 |
| Table 9. Conducted Limits for Intentional Radiators from FCC Part 15 § 15.207(a) | 16 |
| Table 10. Radiated Field Strength of Fundamental, Test Results | 17 |
| Table 11. Radiated Spurious Emissions, Test Results | 20 |
| Table 12. Spurious Emission Limits for Receivers | 24 |

List of Photographs

| | |
|--|----|
| Photograph 1. Alarm.com, ADC-200T-EVD | 5 |
| Photograph 2. Radiated Emissions, Test Setup | 13 |
| Photograph 3. Radiated Field Strength of Fundamental, Test Setup | 18 |
| Photograph 4. Radiated Harmonics, Test Setup | 23 |

List of Plots

| | |
|--|----|
| Plot 1. Radiated Emissions, Pre-Scan, 30 MHz – 1 GHz, FCC Limits | 11 |
| Plot 2. Occupied Bandwidth, Test Results | 19 |
| Plot 3. 99% Occupied Bandwidth, Test Results | 19 |
| Plot 4. Radiated Spurious Emissions, Low Channel, 30 MHz – 1 GHz | 21 |
| Plot 5. Transmitter Spurious Emissions, 1 GHz – 3 GHz, 9.6 kbps | 21 |
| Plot 6. Transmitter Spurious Emissions, 1 GHz – 3 GHz, 40 kbps | 22 |
| Plot 7. Transmitter Spurious Emissions, 6 GHz – 10 GHz, 9.6 kbps | 22 |
| Plot 8. Transmitter Spurious Emissions, 6 GHz – 10 GHz, 40 kbps | 23 |
| Plot 9. Receiver Spurious Emission, 30 MHz – 1 GHz | 25 |
| Plot 10. Receiver Spurious Emission, 1 GHz – 26.5 GHz | 25 |

List of Terms and Abbreviations

| | |
|--------------|---|
| AC | Alternating Current |
| ACF | Antenna Correction Factor |
| Cal | Calibration |
| <i>d</i> | Measurement Distance |
| dB | Decibels |
| dB μ A | Decibels above one microamp |
| dB μ V | Decibels above one microvolt |
| dB μ A/m | Decibels above one microamp per meter |
| dB μ V/m | Decibels above one microvolt per meter |
| DC | Direct Current |
| E | Electric Field |
| DSL | Digital Subscriber Line |
| ESD | Electrostatic Discharge |
| EUT | Equipment Under Test |
| <i>f</i> | Frequency |
| FCC | Federal Communications Commission |
| GRP | Ground Reference Plane |
| H | Magnetic Field |
| HCP | Horizontal Coupling Plane |
| Hz | Hertz |
| IEC | International Electrotechnical Commission |
| kHz | kilohertz |
| kPa | kilopascal |
| kV | kilovolt |
| LISN | Line Impedance Stabilization Network |
| MHz | Megahertz |
| μ H | microhenry |
| μ F | microfarad |
| μ s | microseconds |
| PRF | Pulse Repetition Frequency |
| RF | Radio Frequency |
| RMS | Root-Mean-Square |
| TWT | Traveling Wave Tube |
| V/m | Volts per meter |
| VCP | Vertical Coupling Plane |

I. Executive Summary

A. Purpose of Test

An EMC evaluation was performed to determine compliance of the Alarm.com ADC-200T-EVD, with the requirements of Part 15, §15.249. All references are to the most current version of Title 47 of the Code of Federal Regulations in effect. In accordance with §2.1033, the following data is presented in support of the Certification of the ADC-200T-EVD. Alarm.com should retain a copy of this document which should be kept on file for at least two years after the manufacturing of the ADC-200T-EVD, has been **permanently** discontinued.

B. Executive Summary

The following tests were conducted on a sample of the equipment for the purpose of demonstrating compliance with Part 15, §15.249, in accordance with Alarm.com, purchase order number T00732. All tests were conducted using measurement procedure ANSI C63.4-2003.

| FCC Reference | Canada Reference | Description | Results |
|------------------------|---------------------------------|-----------------------------------|----------------|
| 15.107 | ICES-003 | AC Power Line Conducted Emissions | Not Applicable |
| 15.109 | ICES-003 | Radiated Emissions | Compliant |
| §15.203 | RSS GEN §7.1.2 | Antenna Requirement | Compliant |
| §15.207 | RSS GEN §7.2.4 | AC Power Line Conducted Emissions | Not Applicable |
| §15.249 (a) | RSS-210 A2.9 | Field Strength of Fundamental | Compliant |
| §15.249(a)(d), §15.209 | RSS-Gen §7.2.5 and RSS-210 A2.0 | Harmonics and Spurious Emissions | Compliant |
| §15.215 (c) | RSS GEN §4.6.1 | 20 dB and 99% Bandwidth | Compliant |
| N/A | RSS-GEN §6.2 | Receiver Spurs | Compliant |

Table 1. Executive Summary of EMC Part 15.249 Compliance Testing

II. Equipment Configuration

A. Overview

MET Laboratories, Inc. was contracted by Alarm.com to perform testing on the ADC-200T-EVD, under Alarm.com's purchase order number T00732.

This document describes the test setups, test methods, required test equipment, and the test limit criteria used to perform compliance testing of the Alarm.com, ADC-200T-EVD.

The results obtained relate only to the item(s) tested.

| | | |
|---------------------------------------|---|--------------|
| Model(s) Tested: | ADC-200T-EVD | |
| EUT Specifications: | Primary Power to Module: 12 VDC Supplied by Host | |
| | FCC ID: YL6-143200T5V4 IC: 9111A-143200T5V4 | |
| | Type of Modulations: | FSK |
| | Equipment Code: | DXX |
| | Highest Fundamental Field Strength: | 93.95 dBuV/m |
| | EUT Frequency Ranges: | 908.40 MHz |
| Analysis: | The results obtained relate only to the item(s) tested. | |
| Environmental Test Conditions: | Temperature (15-35° C) | |
| | Relative Humidity (30-60%) | |
| | Barometric Pressure (860-1060 mbar) | |
| Evaluated by: | Len Knight | |
| Report Date(s): | February 14, 2011 | |

Table 2. EUT Specifications

B. References

| | |
|---------------------------------|---|
| CFR 47, Part 15, Subpart C | Federal Communication Commission, Code of Federal Regulations, Title 47, Part 15: General Rules and Regulations, Allocation, Assignment, and Use of Radio Frequencies |
| CFR 47, Part 15, Subpart B | Electromagnetic Compatibility: Criteria for Radio Frequency Devices |
| RSS-210, Issue 8, December 2010 | Low-power Licence-exempt Radiocommunications Devices (All Frequency Bands): Category I Equipment |
| ICES-003, Issue 4 February 2004 | Electromagnetic Compatibility: Criteria for Radio Frequency Devices |
| ANSI C63.4:2003 | Methods and Measurements of Radio-Noise Emissions from Low-Voltage Electrical And Electronic Equipment in the Range of 9 kHz to 40 GHz |
| ANSI/NCSL Z540-1-1994 | Calibration Laboratories and Measuring and Test Equipment - General Requirements |
| ANSI/ISO/IEC 17025:2005 | General Requirements for the Competence of Testing and Calibration Laboratories |
| ANSI C63.10-2009 | American National Standard for Testing Unlicensed Wireless Devices |

C. Test Site

All testing was performed at MET Laboratories, Inc., 914 W. Patapsco Ave., Baltimore, MD 21230. All equipment used in making physical determinations is accurate and bears recent traceability to the National Institute of Standards and Technology.

Radiated Emissions measurements were performed in a semi-anechoic chamber (equivalent to an Open Area Test Site). In accordance with §2.948(a)(3), a complete site description is contained at MET Laboratories.

D. Description of Test Sample

The Alarm.com ADC-200T-EVD allows its hosting device to send data and receive commands from a NOC (Network Operations Center).

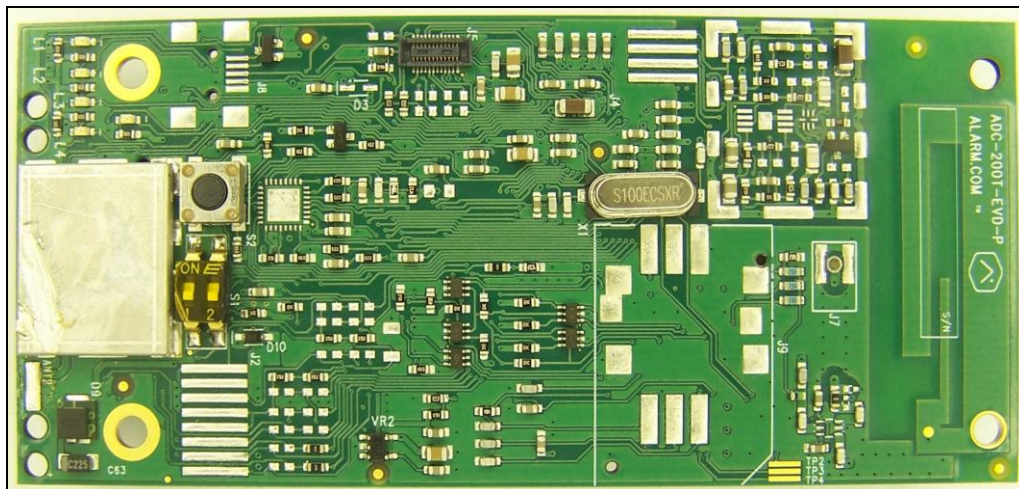

Photograph 1. Alarm.com, ADC-200T-EVD

E. Equipment Configuration

| Ref. ID | Name / Description | Model Number | Serial Number |
|---------|--------------------|--------------|---------------|
| A | Alarm.com Module | ADC-200T-EVD | N/A |

Table 3. Equipment Configuration

F. Ports and Cabling Information

| Ref. ID | Port Name on EUT | Cable Description or Reason for No Cable | Qty. | Length (m) | Shielded (Y/N) | Termination Box ID & Port ID |
|---------|------------------|--|------|------------|----------------|------------------------------|
| 1 | Power | ADC-200M-EVD's physical API is a 22-pin connector. It receives power/data through this connector | 1 | N/A | N/A | N/A |

Table 4. Ports and Cabling Information

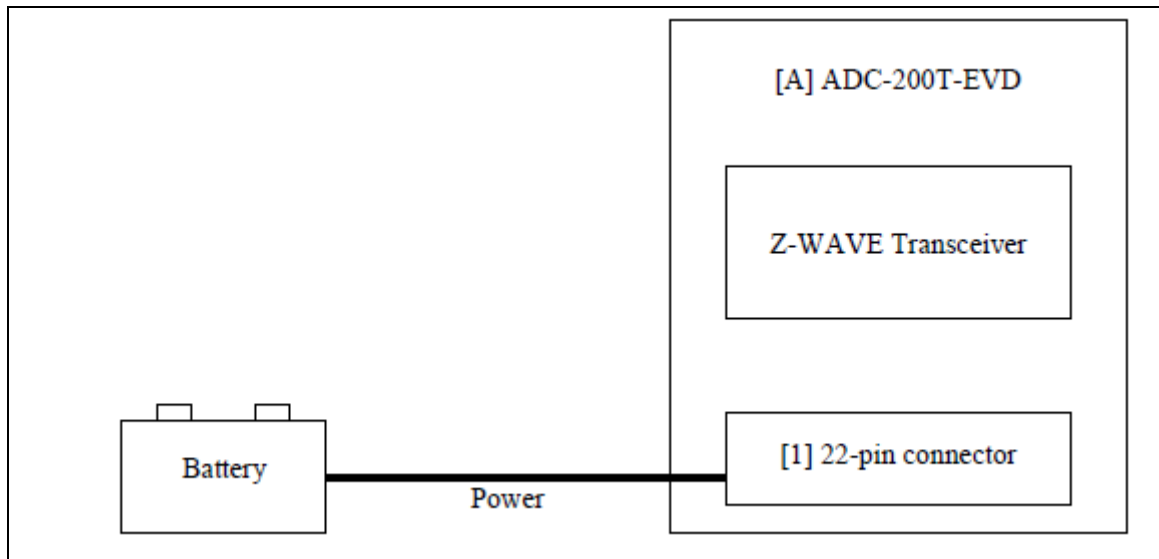

Figure 1. Block Diagram of Test Configuration

G. Mode of Operation

The Z-WAVE Radio is powered on for testing. As long as the ADC-200T-EVD is powered, there is a continual exchange of information between the Z-WAVE Radio and local Z-WAVE devices.

H. Modifications

a) Modifications to EUT

No modifications were made to the EUT.

b) Modifications to Test Standard

No modifications were made to the test standard.

I. Disposition of EUT

The test sample including all support equipment submitted to the Electro-Magnetic Compatibility Lab for testing was returned to Alarm.com upon completion of testing.

III. Electromagnetic Compatibility Criteria for Unintentional Radiators

Electromagnetic Compatibility Criteria for Unintentional Radiators

§ 15.107 Conducted Emissions Limits

Test Requirement(s): **15.107 (a)** “Except for Class A digital devices, for equipment that is designed to be connected to the public utility (AC) power line, the radio frequency voltage that is conducted back onto the AC power line on any frequency or frequencies within the band 150 kHz to 30 MHz shall not exceed the limits in Table 5. Compliance with this provision shall be based on the measurement of the radio frequency voltage between each power line and ground at the power terminals.”

15.107 (b) “For a Class A digital device that is designed to be connected to the public utility (AC) power line, the radio frequency voltage that is conducted back onto the AC power line on any frequency or frequencies within the band 150 kHz to 30 MHz shall not exceed the limits in Table 5. Compliance with this provision shall be based on the measurement of the radio frequency voltage between each power line and ground at the power terminals. The lower limit applies at the band edges.”

| Frequency range (MHz) | 15.107(b), Class A Limits (dBμV) | | 15.107(a), Class B Limits (dBμV) | |
|--------------------------|-------------------------------------|---------|-------------------------------------|---------|
| | Quasi-Peak | Average | Quasi-Peak | Average |
| 0.15- 0.5 | 79 | 66 | 66 - 56 | 56 - 46 |
| 0.5 – 5.0 | 73 | 60 | 56 | 46 |
| 5.0 - 30 | 73 | 60 | 60 | 50 |

Note 1 — The lower limit shall apply at the transition frequencies.

Table 5. Conducted Limits for Radio Frequency Devices calculated from FCC Part 15 Section 15.107(a) (b)

Test Results: The EUT was not applicable with the Class B requirement(s) of this section. The EUT is DC powered from a lead acid battery.

Radiated Emission Limits

§ 15.109 Radiated Emissions Limits

Test Requirement(s): **15.109 (a)** Except for Class A digital devices, the field strength of radiated emissions from unintentional radiators at a distance of 3 meters shall not exceed the Class B limits expressed in Table 6.

15.109 (b) The field strength of radiated emissions from a Class A digital device, as determined at a distance of 10 meters, shall not exceed the Class A limits expressed in Table 6.

| Frequency (MHz) | Field Strength (dBµV/m) | |
|-----------------|---|--|
| | §15.109 (b), Class A Limit (dBµV) @ 10m | §15.109 (a), Class B Limit (dBµV) @ 3m |
| 30 - 88 | 39.00 | 40.00 |
| 88 - 216 | 43.50 | 43.50 |
| 216 - 960 | 46.40 | 46.00 |
| Above 960 | 49.50 | 54.00 |

Table 6. Radiated Emissions Limits calculated from FCC Part 15, §15.109 (a) (b)

Test Procedures: The EUT was placed on a 0.8m-high acrylic table inside a semi-anechoic chamber. The method of testing and test conditions of ANSI C63.4 were used. An antenna was located 3 m from the EUT on an adjustable mast. A pre-scan was first performed in order to find prominent radiated emissions. For final emissions measurements at each frequency of interest, the EUT was rotated and the antenna height was varied between 1 m and 4 m in order to maximize the emission. Measurements in both horizontal and vertical polarities were made and the data was recorded. Unless otherwise specified, measurements were made using a quasi-peak detector with a 120 kHz bandwidth.

Test Results: The EUT was found compliant with the Class B requirement(s) of this section. Measured emissions were below applicable limits.

Test Engineer(s): Len Knight

Test Date(s): 12/13/10

Radiated Emissions Limits Test Results, Class B

| Frequency (MHz) | EUT Azimuth (Degrees) | Antenna Polarity (H/V) | Antenna HEIGHT (m) | Uncorrected Amplitude (dBuV) | Antenna Correction Factor (dB) (+) | Cable Loss (dB) (+) | Distance Correction Factor (dB) (-) | Corrected Amplitude (dBuV/m) | Limit (dBuV/m) | Margin (dB) |
|-----------------|-----------------------|------------------------|--------------------|------------------------------|------------------------------------|---------------------|-------------------------------------|------------------------------|----------------|-------------|
| 37.915832 | 247 | H | 2.50 | 6.17 | 15.84 | 0.23 | 0.00 | 22.24 | 40.00 | -17.76 |
| 37.915832 | 171 | V | 1.02 | 19.20 | 15.84 | 0.23 | 0.00 | 35.27 | 40.00 | -4.73 |
| 41.683367 | 221 | H | 1.46 | 7.66 | 12.92 | 0.23 | 0.00 | 20.81 | 40.00 | -19.19 |
| 41.683367 | 0 | V | 1.00 | 25.26 | 12.92 | 0.23 | 0.00 | 38.41 | 40.00 | -1.59 |
| 41.302605 | 242 | H | 1.65 | 9.10 | 13.19 | 0.23 | 0.00 | 22.52 | 40.00 | -17.48 |
| 41.302605 | 221 | V | 1.00 | 26.18 | 13.19 | 0.23 | 0.00 | 39.60 | 40.00 | -0.40 |
| 53.086172 | 73 | H | 2.61 | 5.80 | 7.87 | 0.23 | 0.00 | 13.90 | 40.00 | -26.10 |
| 53.086172 | 360 | V | 1.00 | 21.10 | 7.87 | 0.23 | 0.00 | 29.20 | 40.00 | -10.80 |
| 53.266533 | 213 | H | 2.51 | 6.23 | 7.82 | 0.23 | 0.00 | 14.28 | 40.00 | -25.72 |
| 53.266533 | 285 | V | 1.00 | 19.27 | 7.82 | 0.23 | 0.00 | 27.32 | 40.00 | -12.68 |
| 68.216433 | 216 | H | 2.70 | 8.07 | 8.00 | 0.23 | 0.00 | 16.30 | 40.00 | -23.70 |
| 68.216433 | 309 | V | 1.04 | 18.36 | 8.00 | 0.23 | 0.00 | 26.59 | 40.00 | -13.41 |
| 66.813627 | 266 | H | 2.47 | 7.96 | 7.90 | 0.23 | 0.00 | 16.09 | 40.00 | -23.91 |
| 66.813627 | 325 | V | 1.00 | 18.42 | 7.90 | 0.23 | 0.00 | 26.55 | 40.00 | -13.45 |

Table 7. Radiated Emissions Limits, Test Results, FCC Limits

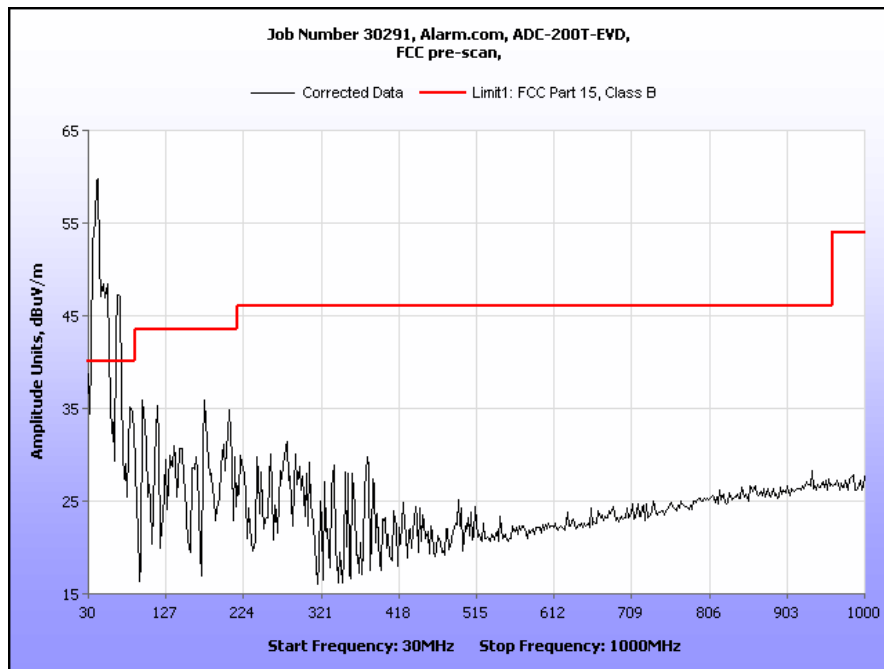

Plot 1. Radiated Emissions, Pre-Scan, 30 MHz – 1 GHz, FCC Limits

| Frequency (MHz) | EUT Azimuth (Degrees) | Antenna Polarity (H/V) | Antenna HEIGHT (m) | Uncorrected Amplitude (dBuV) | Antenna Correction Factor (dB) (+) | Cable Loss (dB) (+) | Distance Correction Factor (dB) (-) | Corrected Amplitude (dBuV/m) | Limit (dBuV/m) | Margin (dB) |
|-----------------|-----------------------|------------------------|--------------------|------------------------------|------------------------------------|---------------------|-------------------------------------|------------------------------|----------------|-------------|
| 37.915832 | 247 | H | 2.50 | 6.17 | 15.84 | 0.23 | 10.46 | 11.78 | 30.00 | -18.22 |
| 37.915832 | 171 | V | 1.02 | 19.20 | 15.84 | 0.23 | 10.46 | 24.81 | 30.00 | -5.19 |
| 41.683367 | 221 | H | 1.46 | 7.66 | 12.92 | 0.23 | 10.46 | 10.35 | 30.00 | -19.65 |
| 41.683367 | 0 | V | 1.00 | 25.26 | 12.92 | 0.23 | 10.46 | 27.95 | 30.00 | -2.05 |
| 41.302605 | 242 | H | 1.65 | 9.10 | 13.19 | 0.23 | 10.46 | 12.06 | 30.00 | -17.94 |
| 41.302605 | 221 | V | 1.00 | 26.18 | 13.19 | 0.23 | 10.46 | 29.14 | 30.00 | -0.86 |
| 53.086172 | 73 | H | 2.61 | 5.80 | 7.87 | 0.23 | 10.46 | 3.44 | 30.00 | -26.56 |
| 53.086172 | 360 | V | 1.00 | 21.10 | 7.87 | 0.23 | 10.46 | 18.74 | 30.00 | -11.26 |
| 53.266533 | 213 | H | 2.51 | 6.23 | 7.82 | 0.23 | 10.46 | 3.82 | 30.00 | -26.18 |
| 53.266533 | 285 | V | 1.00 | 19.27 | 7.82 | 0.23 | 10.46 | 16.86 | 30.00 | -13.14 |
| 68.216433 | 216 | H | 2.70 | 8.07 | 8.00 | 0.23 | 10.46 | 5.84 | 30.00 | -24.16 |
| 68.216433 | 309 | V | 1.04 | 18.36 | 8.00 | 0.23 | 10.46 | 16.13 | 30.00 | -13.87 |
| 66.813627 | 266 | H | 2.47 | 7.96 | 7.90 | 0.23 | 10.46 | 5.63 | 30.00 | -24.37 |
| 66.813627 | 325 | V | 1.00 | 18.42 | 7.90 | 0.23 | 10.46 | 16.09 | 30.00 | -13.91 |

Table 8. Radiated Emissions Limits, Test Results, ICES-003

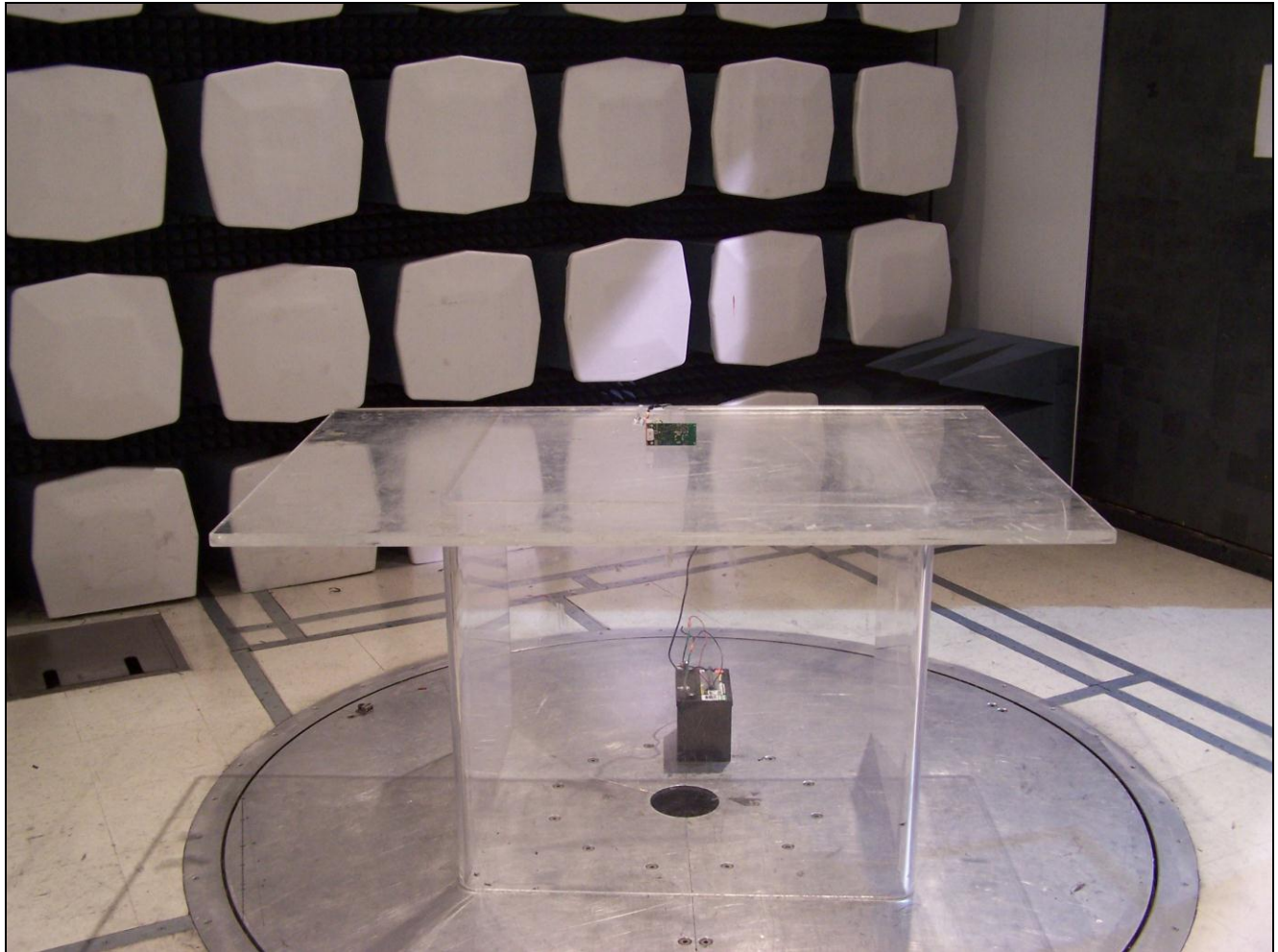

Photograph 2. Radiated Emissions, Test Setup

IV. Electromagnetic Compatibility Criteria for Intentional Radiators

Electromagnetic Compatibility Criteria for Intentional Radiators

§ 15.203 Antenna Requirement

Test Requirement: § 15.203: An intentional radiator shall be designed to ensure that no antenna other than that furnished by the responsible party shall be used with the device. The use of a permanently attached antenna or of an antenna that uses a unique coupling to the intentional radiator shall be considered sufficient to comply with the provisions of this section. The manufacturer may design the unit so that a broken antenna can be replaced by the user, but the use of a standard antenna jack or electrical connector is prohibited.

The structure and application of the EUT were analyzed to determine compliance with Section 15.203 of the Rules. Section 15.203 states that the subject device must meet at least one of the following criteria:

- a.) Antenna must be permanently attached to the unit.
- b.) Antenna must use a unique type of connector to attach to the EUT.
- c.) Unit must be professionally installed. Installer shall be responsible for verifying that the correct antenna is employed with the unit.

Test Results: The EUT is compliant with §15.203. The EUT uses an integral antenna.

Test Engineer(s): Len Knight

Test Date(s): 12/13/10

Electromagnetic Compatibility Criteria for Intentional Radiators

§ 15.207 Conducted Emissions Limits

Test Requirement(s): § 15.207 (a): For an intentional radiator that is designed to be connected to the public utility (AC) power line, the radio frequency voltage that is conducted back onto the AC power line on any frequency or frequencies, within the band 150 kHz to 30MHz, shall not exceed the limits in the following table, as measured using a 50 μ H/50 Ω line impedance stabilization network (LISN). Compliance with the provisions of this paragraph shall be based on the measurement of the radio frequency voltage between each power line and ground at the power terminal. The lower limit applies at the boundary between the frequency ranges.

| Frequency range (MHz) | § 15.207(a), Conducted Limit (dB μ V) | |
|--------------------------|---|---------|
| | Quasi-Peak | Average |
| * 0.15- 0.45 | 66 - 56 | 56 - 46 |
| 0.45 - 0.5 | 56 | 46 |
| 0.5 - 30 | 60 | 50 |

Table 9. Conducted Limits for Intentional Radiators from FCC Part 15 § 15.207(a)

Test Results: The EUT was not applicable with this requirement. The EUT is DC powered from a lead acid battery.

Electromagnetic Compatibility Criteria for Intentional Radiators

§ 15.249(a) Radiated Field Strength of Fundamental

Test Requirements: § 15.249(a): The 3 meter field strength of the fundamental emissions from intentional radiators operated within the 902 – 928 MHz frequency bands shall comply with the following requirement: 50 millivolts/meter (94dB μ V/m), quasi-peak mode measurement.

Test Procedure: Measurements were performed with the EUT rotated 360 degrees and varying the adjustable antenna mast with 1 m to 4 m height to determine worst case orientation for maximum emissions. The antenna was placed 3m away from the EUT. The EUT was rotated about all three orthogonal axis.

For the purposes of testing, the 9.6 kbps sample was used since it demonstrated a higher power than the 40 kbps unit.

Measurements were made using a quasi-peak detector.

Test Results: The EUT is compliant with the requirements of § 15.249(a).

Test Engineer(s): Len Knight

Test Date(s): 12/13/10

| Frequency (MHz) | EUT Azimuth (Degrees) | Antenna Polarity (H/V) | Antenna HEIGHT (m) | Uncorrected Amplitude (dB μ V) | Antenna Correction Factor (dB) (+) | Cable Loss (dB) (+) | Distance Correction Factor (dB) (-) | Corrected Amplitude (dB μ V/m) | Limit (dB μ V/m) | Margin (dB) |
|-----------------|-----------------------|------------------------|--------------------|------------------------------------|------------------------------------|---------------------|-------------------------------------|------------------------------------|----------------------|-------------|
| 908.39479 | 186 | H | 1.00 | 69.51 | 22.77 | 1.67 | 0.00 | 93.95 | 94.00 | -0.05 |

Table 10. Radiated Field Strength of Fundamental, Test Results

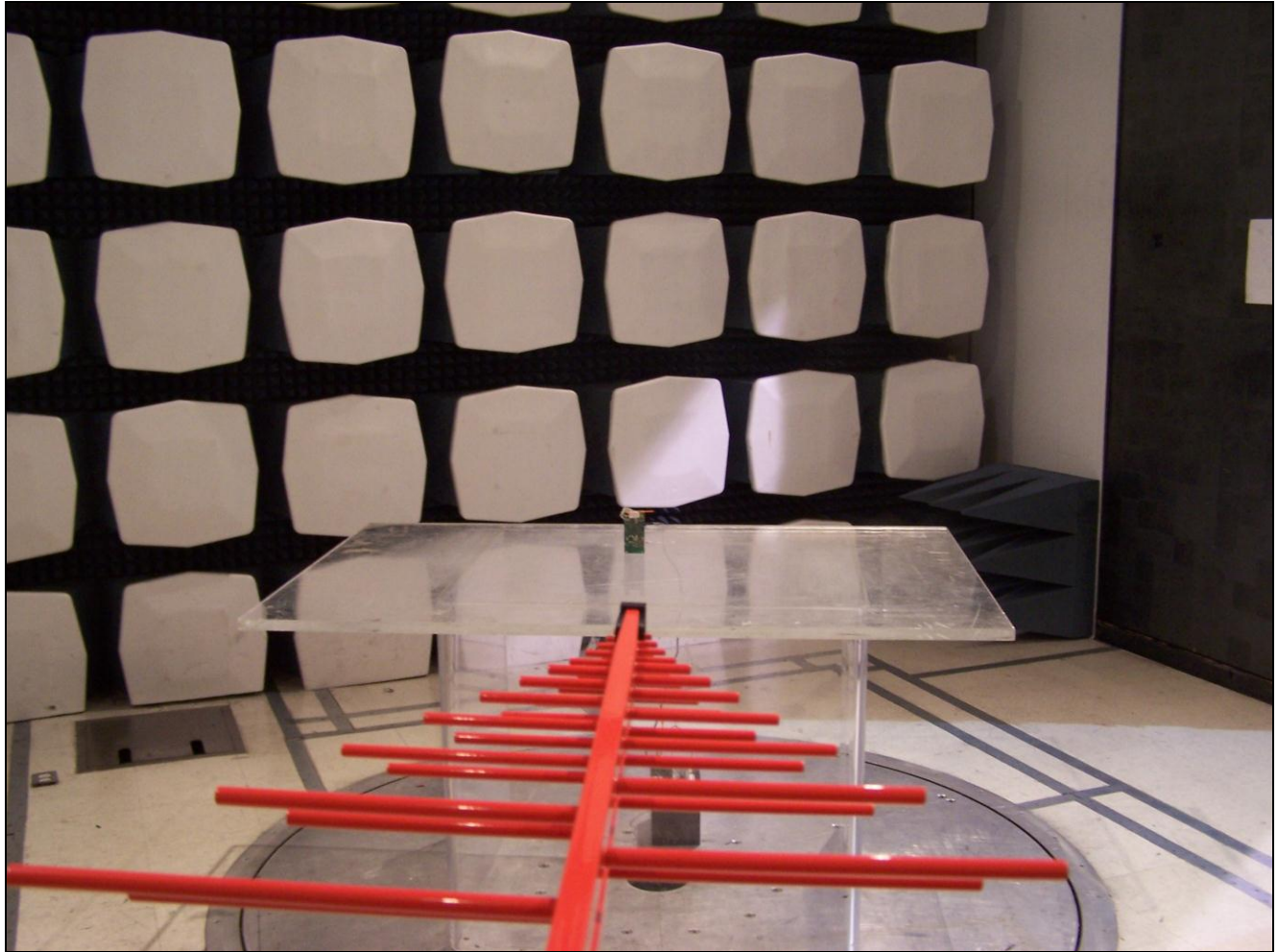

Photograph 3. Radiated Field Strength of Fundamental, Test Setup

Electromagnetic Compatibility Criteria for Intentional Radiators

20 dB and 99% Bandwidth

Test Procedure: The 20 dB and 99% Bandwidth was measured and recorded.

Test Results: See the following plot.

Test Engineer(s): Len Knight

Test Date(s): 12/15/10

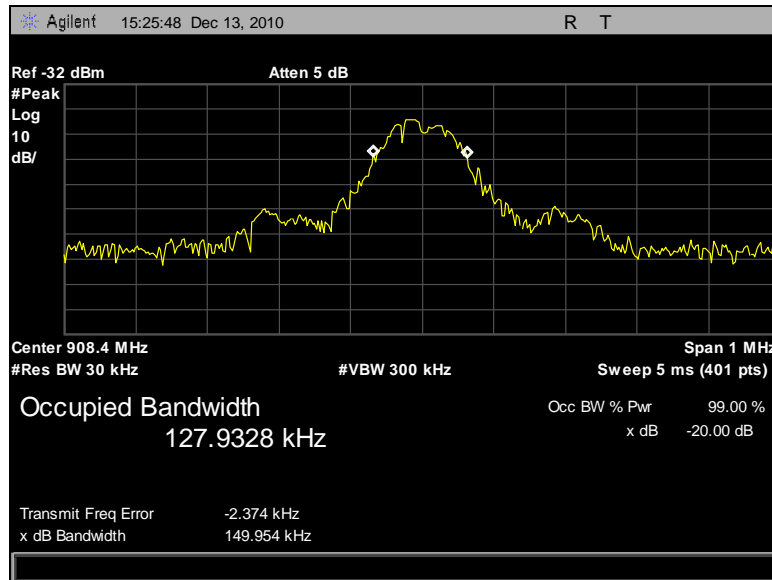

Plot 2. Occupied Bandwidth, Test Results

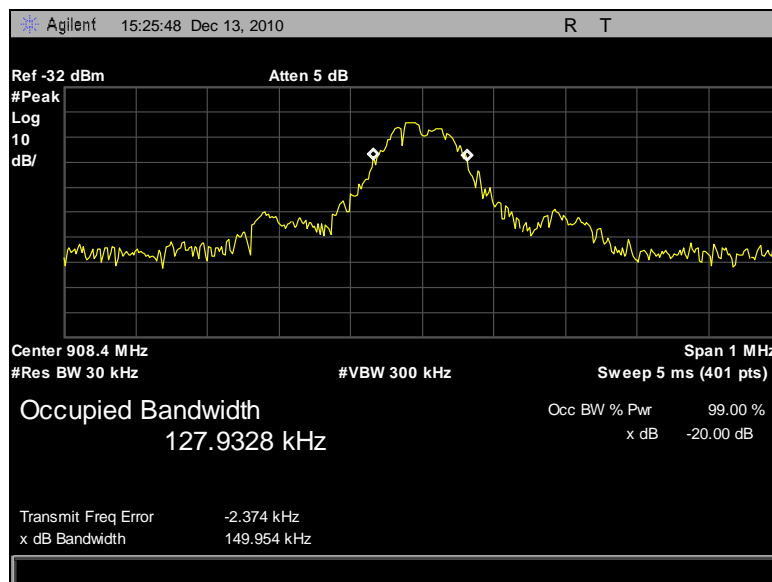

Plot 3. 99% Occupied Bandwidth, Test Results

Electromagnetic Compatibility Criteria for Intentional Radiators

§ 15.249(a)(d) Harmonics and Spurious Emissions Requirements

Test Requirements: Harmonics originating from devices that operate in the 902-928 MHz band shall meet the 500 microvolts/meter limit (i.e. 54 dBuV/m) with an average detector. In addition, emissions radiated outside of the specified frequency bands, except for harmonics, shall be attenuated by at least 50 dB below the level of the fundamental or to the general radiated emission limits in §15.209, whichever is the lesser attenuation.

Test Procedure: Measurements were performed with the EUT rotated 360 degrees and varying the adjustable antenna mast with 1 m to 4 m height to determine worst case orientation for maximum emissions. Emissions below 1 GHz were performed with the antenna placed 3m away from EUT. For above 1 GHz, the measuring antenna was placed 1m away.

Both the 9.6 kbps and 40 kbps units were tested.

Test Results: The EUT is compliant with the harmonics and Spurious Emissions Requirements of § 15.249(a)(d). For spurious emissions the lesser attenuation was the 15.209 limits.

Test Engineer(s): Len Knight

Test Date(s): 12/13/10

| Frequency (MHz) | EUT Azimuth (Degrees) | Antenna Polarity (H/V) | Antenna HEIGHT (m) | Uncorrected Amplitude (dBuV) | Antenna Correction Factor (dB) (+) | Cable Loss (dB) (+) | Distance Correction Factor (dB) (-) | Corrected Amplitude (dBuV/m) | Limit (dBuV/m) | Margin (dB) |
|-----------------|-----------------------|------------------------|--------------------|------------------------------|------------------------------------|---------------------|-------------------------------------|------------------------------|----------------|-------------|
| 53.33 | 183 | H | 2.23 | 6.51 | 7.80 | 0.23 | 0.00 | 14.54 | 40.00 | -25.46 |
| 53.33 | 0 | V | 1.30 | 26.16 | 7.80 | 0.23 | 0.00 | 34.19 | 40.00 | -5.81 |
| 37.775 | 215 | H | 1.52 | 5.95 | 15.91 | 0.23 | 0.00 | 22.09 | 40.00 | -17.91 |
| 37.775 | 360 | V | 1.02 | 19.10 | 15.91 | 0.23 | 0.00 | 35.24 | 40.00 | -4.76 |
| 66.934 | 256 | H | 2.07 | 7.04 | 7.90 | 0.23 | 0.00 | 15.17 | 40.00 | -24.83 |
| 66.934 | 0 | V | 1.01 | 16.94 | 7.90 | 0.23 | 0.00 | 25.07 | 40.00 | -14.93 |

Table 11. Radiated Spurious Emissions, Test Results

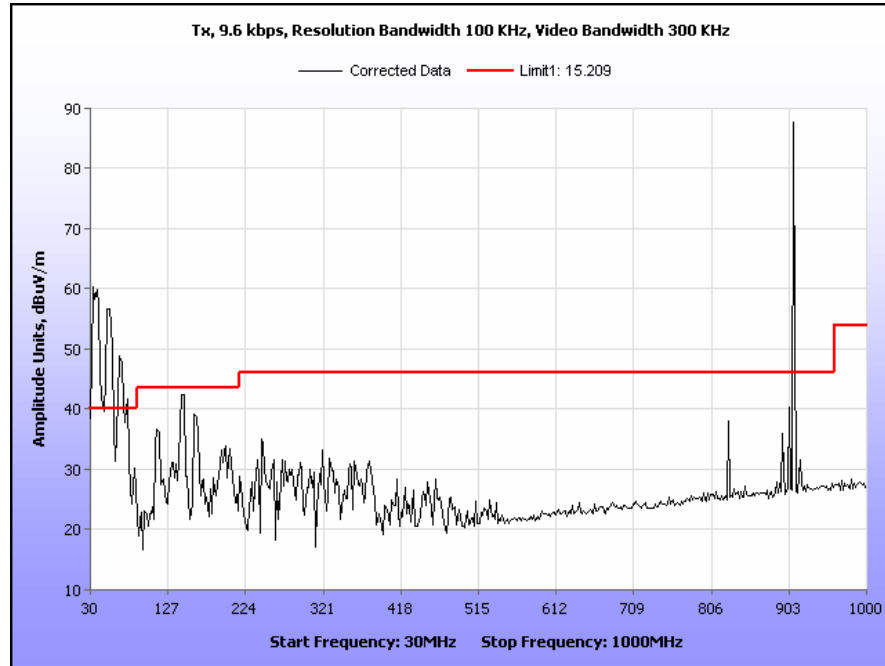

Plot 4. Radiated Spurious Emissions, 30 MHz – 1 GHz, 9.6 kbps

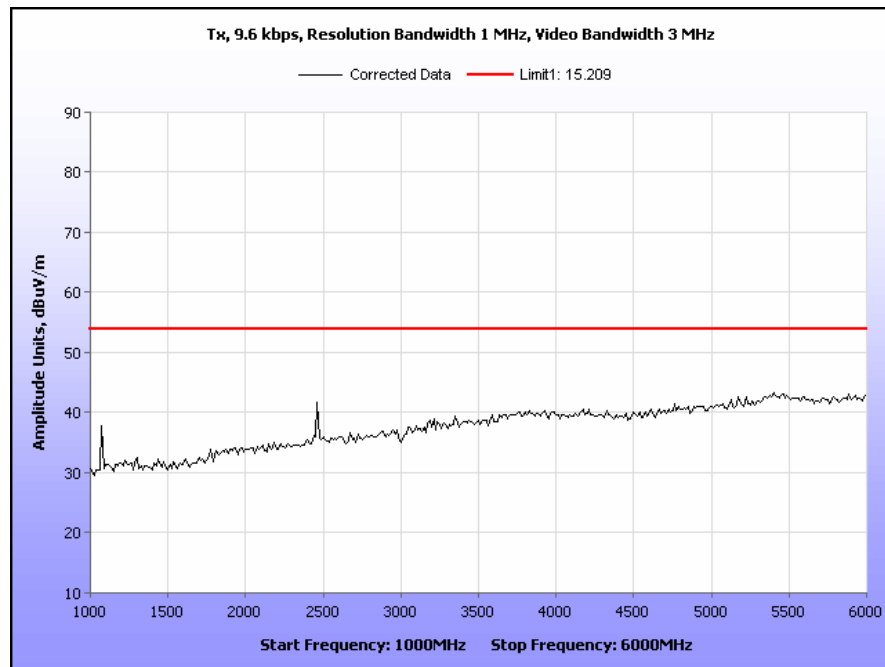

Plot 5. Transmitter Spurious Emissions, 1 GHz – 6 GHz, 9.6 kbps

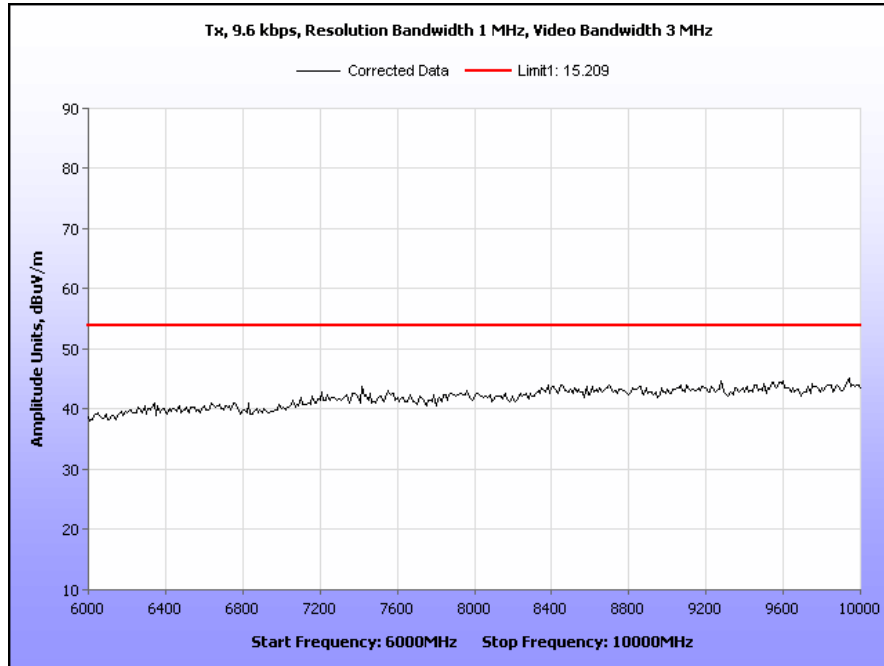

Plot 6. Transmitter Spurious Emissions, 6 GHz – 10 GHz, 9.6 kbps

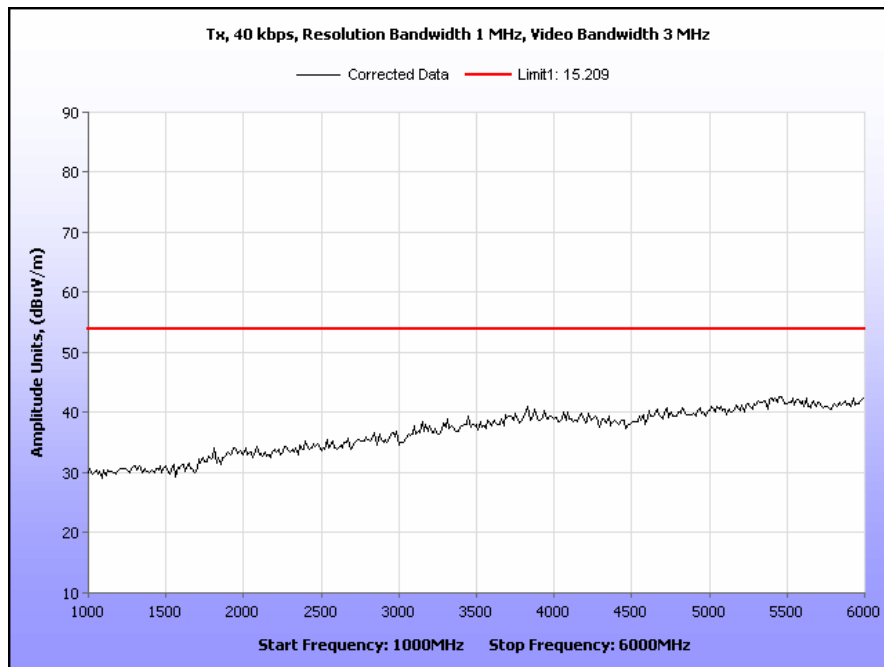

Plot 7. Transmitter Spurious Emissions, 1 GHz – 6 GHz, 40 kbps

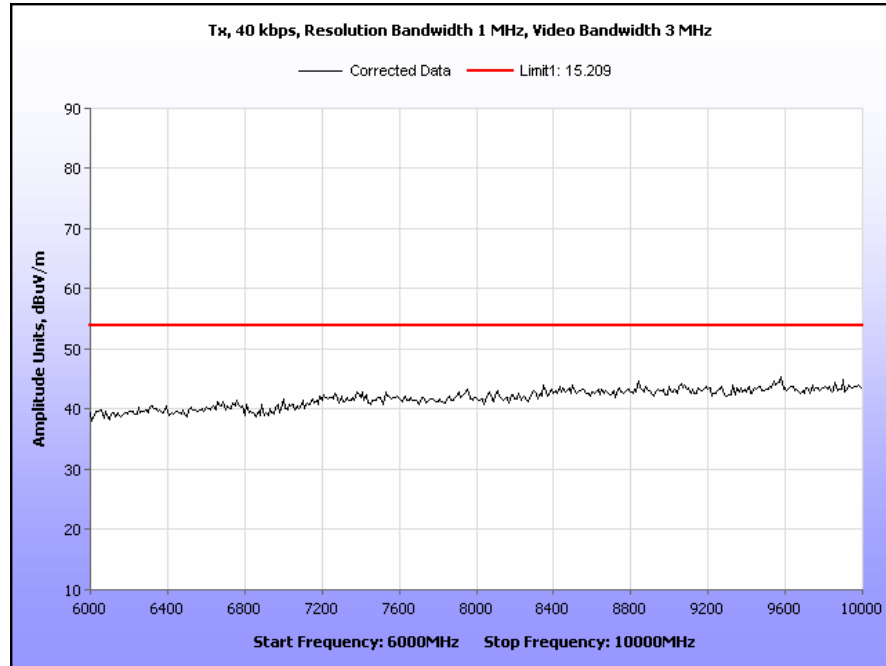

Plot 8. Transmitter Spurious Emissions, 6 GHz – 10 GHz, 40 kbps

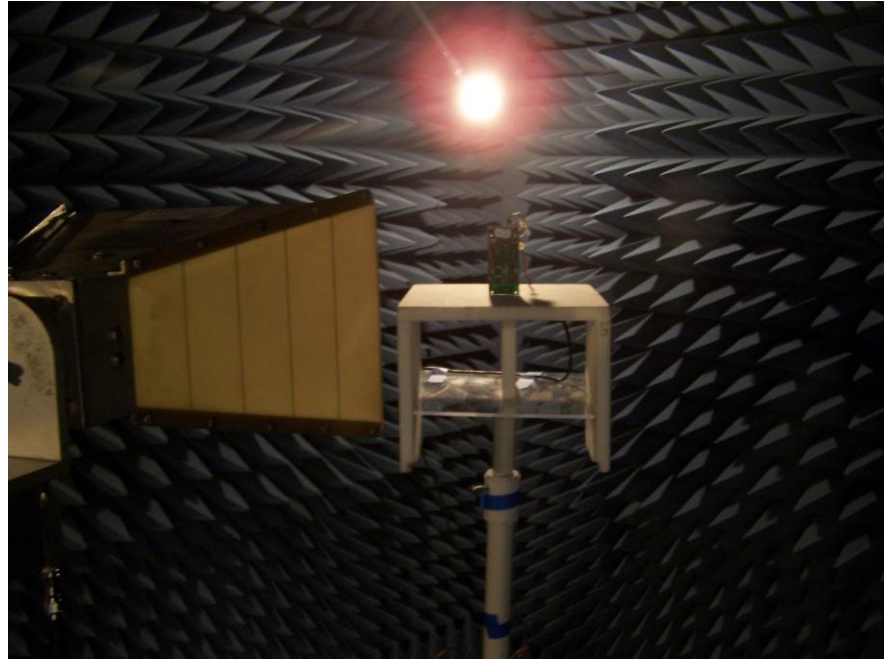

Photograph 4. Radiated Harmonics, Test Setup

Electromagnetic Compatibility Criteria for Intentional Radiators

RSS-GEN Receiver Spurious Emissions Requirements

Test Requirements: The following receiver spurious emission limits shall be complied with:

If a radiated measurement is made, all spurious emissions shall comply with the limits of Table 12.

| Spurious Frequency (MHz) | Field Strength (microvolt/m at 3 metres) |
|--------------------------|--|
| 30 – 88 | 100 |
| 88 – 216 | 150 |
| 216 – 960 | 200 |
| Above 960 | 500 |

Table 12. Spurious Emission Limits for Receivers

If a conducted measurement is made, receiver spurious emissions at any discrete frequency shall not exceed 2 nanowatts in the band 30 – 1000 MHz, and 5 nanowatts above 1000 MHz.

Test Procedures: A sample of the EUT with an SMA in place of the antenna was fabricated. The EUT was placed in a receive only mode. The EUT was connected directly to a spectrum analyzer.

Test Results: Equipment is compliant with the Receiver Spurious Emissions Requirements of RSS-GEN.

Test Engineer(s): Len Knight

Test Date(s): 12/14/10

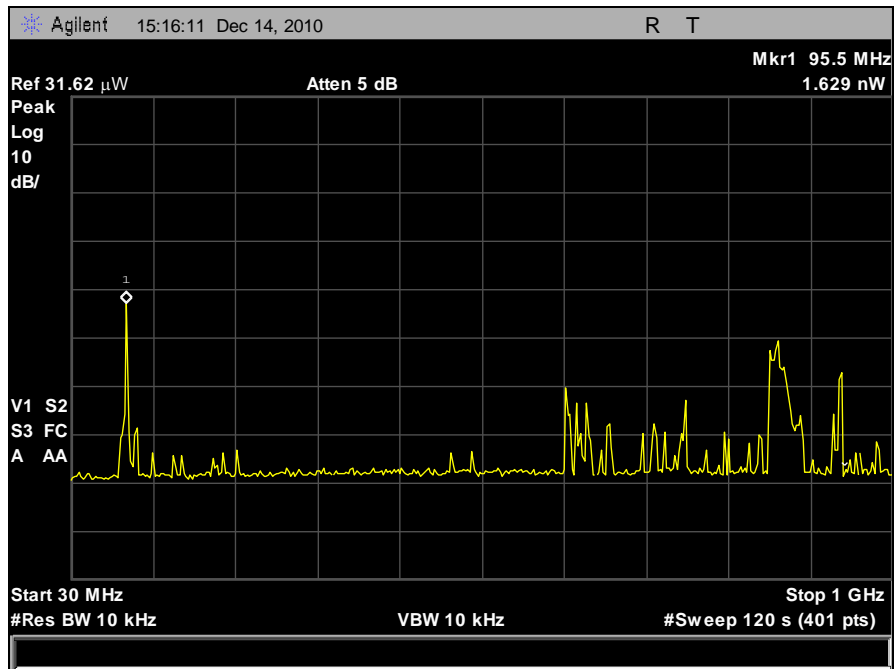

Plot 9. Receiver Spurious Emission, 30 MHz – 1 GHz

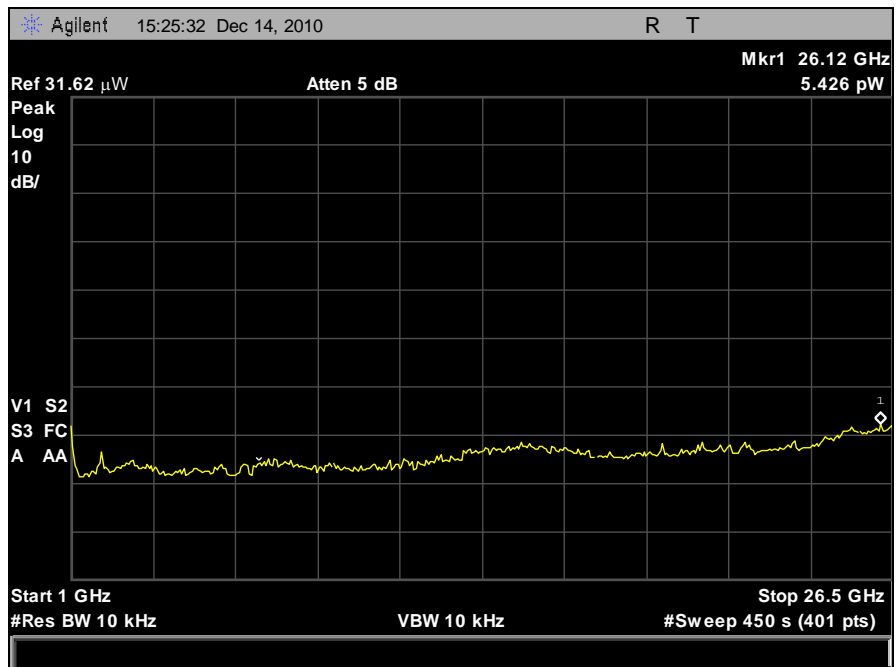

Plot 10. Receiver Spurious Emission, 1 GHz – 26.5 GHz

IV. Test Equipment

Test Equipment

Calibrated test equipment utilized during testing was maintained in a current state of calibration per the requirements of ANSI/NCSL Z540-1-1994 and ANSI/ISO/IEC 17025:2000.

| MET Asset # | Equipment | Manufacturer | Model | Last Cal Date | Cal Due Date |
|-------------|--------------------------------|------------------|-----------------------|---------------|--------------|
| 1T4300 | SEMI-ANECHOIC CHAMBER # 1 | EMC TEST SYSTEMS | NONE | 08/23/2010 | 08/23/2013 |
| 1T4409 | EMI RECEIVER | ROHDE & SCHWARZ | ESIB7 | 05/25/2010 | 05/25/2011 |
| 1T4627 | THERMO/HYGROMETER | CONTROL COMPANY | S6-627-9 | 10/09/2009 | 10/09/2011 |
| 1T4751 | ANTENNA - BILOG | SUNOL SCIENCES | JB6 | 11/03/2010 | 11/03/2011 |
| 1T4442 | PRE-AMPLIFIER, MICROWAVE | MITEQ | AFS42-01001800-30-10P | SEE NOTE | |
| 1T4592 | RF FILTER KIT | VARIOUS | N/A | SEE NOTE | |
| 1T2665 | HORN ANTENNA | EMCO | 3115 | 07/15/2010 | 07/15/2011 |
| 1T4612 | ESA-E SERIES SPECTRUM ANALYZER | AGILENT | E4407B | 09/27/2010 | 09/27/2011 |

Note: Functionally tested equipment is verified using calibrated instrumentation at the time of testing.



V. Certification & User's Manual Information



Certification & User's Manual Information

A. Certification Information

The following is extracted from Title 47 of the Code of Federal Regulations, Part 2, Subpart I — Marketing of Radio frequency devices:

§ 2.801 Radio-frequency device defined.

As used in this part, a radio-frequency device is any device which in its operation is capable of Emitting radio-frequency energy by radiation, conduction, or other means. Radio- frequency devices include, but are not limited to:

- (a) The various types of radio communication transmitting devices described throughout this chapter.
- (b) *The incidental, unintentional and intentional radiators defined in Part 15 of this chapter.*
- (c) The industrial, scientific, and medical equipment described in Part 18 of this chapter.
- (d) Any part or component thereof which in use emits radio-frequency energy by radiation, conduction, or other means.

§ 2.803 Marketing of radio frequency devices prior to equipment authorization.

- (a) Except as provided elsewhere in this chapter, no person shall sell or lease, or offer for sale or lease (including advertising for sale or lease), or import, ship or distribute for the purpose of selling or leasing or offering for sale or lease, any radio frequency device unless:
 - (1) In the case of a device subject to certification, such device has been authorized by the Commission in accordance with the rules in this chapter and is properly identified and labeled as required by §2.925 and other relevant sections in this chapter; or
 - (2) In the case of a device that is not required to have a grant of equipment authorization issued by the Commission, but which must comply with the specified technical standards prior to use, such device also complies with all applicable administrative (including verification of the equipment or authorization under a Declaration of Conformity, where required), technical, labeling and identification requirements specified in this chapter.
- (d) Notwithstanding the provisions of paragraph (a) of this section, the offer for sale solely to business, commercial, industrial, scientific or medical users (but not an offer for sale to other parties or to end users located in a residential environment) of a radio frequency device that is in the conceptual, developmental, design or pre-production stage is permitted prior to equipment authorization or, for devices not subject to the equipment authorization requirements, prior to a determination of compliance with the applicable technical requirements *provided* that the prospective buyer is advised in writing at the time of the offer for sale that the equipment is subject to the FCC rules and that the equipment will comply with the appropriate rules before delivery to the buyer or to centers of distribution.



- (e)(1) Notwithstanding the provisions of paragraph (a) of this section, prior to equipment authorization or determination of compliance with the applicable technical requirements any radio frequency device may be operated, but not marketed, for the following purposes and under the following conditions:
- (i) *Compliance testing;*
 - (ii) Demonstrations at a trade show provided the notice contained in paragraph (c) of this section is displayed in a conspicuous location on, or immediately adjacent to, the device;
 - (iii) Demonstrations at an exhibition conducted at a business, commercial, industrial, scientific or medical location, but excluding locations in a residential environment, provided the notice contained in paragraphs (c) or (d) of this section, as appropriate, is displayed in a conspicuous location on, or immediately adjacent to, the device;
 - (iv) Evaluation of product performance and determination of customer acceptability, provided such operation takes place at the manufacturer's facilities during developmental, design or pre-production states; or
 - (v) Evaluation of product performance and determination of customer acceptability where customer acceptability of a radio frequency device cannot be determined at the manufacturer's facilities because of size or unique capability of the device, provided the device is operated at a business, commercial, industrial, scientific or medical user's site, but not at a residential site, during the development, design or pre-production stages.
- (e)(2) For the purpose of paragraphs (e)(1)(iv) and (e)(1)(v) of this section, the term *manufacturer's facilities* includes the facilities of the party responsible for compliance with the regulations and the manufacturer's premises, as well as the facilities of other entities working under the authorization of the responsible party in connection with the development and manufacture, but not the marketing, of the equipment.
- (f) For radio frequency devices subject to verification and sold solely to business, commercial, industrial, scientific and medical users (excluding products sold to other parties or for operation in a residential environment), parties responsible for verification of the devices shall have the option of ensuring compliance with the applicable technical specifications of this chapter at each end user's location after installation, provided that the purchase or lease agreement includes a proviso that such a determination of compliance be made and is the responsibility of the party responsible for verification of the equipment.



Certification & User's Manual Information

The following is extracted from Title 47 of the Code of Federal Regulations, Part 2, Subpart J — Equipment Authorization Procedures:

§ 2.901 Basis and Purpose

- (a) In order to carry out its responsibilities under the Communications Act and the various treaties and international regulations, and in order to promote efficient use of the radio spectrum, the Commission has developed technical standards for radio frequency equipment and parts or components thereof. The technical standards applicable to individual types of equipment are found in that part of the rules governing the service wherein the equipment is to be operated.¹ *In addition to the technical standards provided, the rules governing the service may require that such equipment be verified by the manufacturer or importer, be authorized under a Declaration of Conformity, or receive an equipment authorization from the Commission by one of the following procedures: certification or registration.*
- (b) The following sections describe the verification procedure, the procedure for a Declaration of Conformity, and the procedures to be followed in obtaining certification from the Commission and the conditions attendant to such a grant.

§ 2.907 Certification.

- (a) Certification is an equipment authorization issued by the Commission, based on representation and test data submitted by the applicant.
- (b) Certification attaches to all units subsequently marketed by the grantee which are identical (see Section 2.908) to the sample tested except for permissive changes or other variations authorized by the Commission pursuant to Section 2.1043.

¹ In this case, the equipment is subject to the rules of Part 15. More specifically, the equipment falls under Subpart B (of Part 15), which deals with unintentional radiators.



Certification & User's Manual Information

§ 2.948 Description of measurement facilities.

- (a) Each party making measurements of equipment that is subject to an equipment authorization under Part 15 or Part 18 of this chapter, regardless of whether the measurements are filed with the Commission or kept on file by the party responsible for compliance of equipment marketed within the U.S. or its possessions, shall compile a description of the measurement facilities employed.
 - (1) If the measured equipment is subject to the verification procedure, the description of the measurement facilities shall be retained by the party responsible for verification of the equipment.
 - (i) *If the equipment is verified through measurements performed by an independent laboratory, it is acceptable for the party responsible for verification of the equipment to rely upon the description of the measurement facilities retained by or placed on file with the Commission by that laboratory. In this situation, the party responsible for the verification of the equipment is not required to retain a duplicate copy of the description of the measurement facilities.*
 - (ii) If the equipment is verified based on measurements performed at the installation site of the equipment, no specific site calibration data is required. It is acceptable to retain the description of the measurement facilities at the site at which the measurements were performed.
 - (2) If the equipment is to be authorized by the Commission under the certification procedure, the description of the measurement facilities shall be filed with the Commission's Laboratory in Columbia, Maryland. The data describing the measurement facilities need only be filed once but must be updated as changes are made to the measurement facilities or as otherwise described in this section. At least every three years, the organization responsible for filing the data with the Commission shall certify that the data on file is current.



Certification & User's Manual Information

Label and User's Manual Information

The following is extracted from Title 47 of the Code of Federal Regulations, Part 15, Subpart A — General:

§ 15.19 Labeling requirements.

(a) *In addition to the requirements in Part 2 of this chapter, a device subject to certification or verification shall be labeled as follows:*

- (1) Receivers associated with the operation of a licensed radio service, e.g., FM broadcast under Part 73 of this chapter, land mobile operation under Part 90, etc., shall bear the following statement in a conspicuous location on the device:

This device complies with Part 15 of the FCC Rules. Operation is subject to the condition that this device does not cause harmful interference.

- (2) A stand-alone cable input selector switch, shall bear the following statement in a conspicuous location on the device:

This device is verified to comply with Part 15 of the FCC Rules for use with cable television service.

- (3) All other devices shall bear the following statement in a conspicuous location on the device:

This device complies with Part 15 of the FCC Rules. Operation is subject to the following two conditions: (1) This device may not cause harmful interference, and (2) this device must accept any interference received, including interference that may cause undesired operation.

- (4) Where a device is constructed in two or more sections connected by wires and marketed together, the statement specified under paragraph (a) of this section is required to be affixed only to the main control unit.

- (5) When the device is so small or for such use that it is not practicable to place the statement specified under paragraph (a) of this section on it, the information required by this paragraph shall be placed in a prominent location in the instruction manual or pamphlet supplied to the user or, alternatively, shall be placed on the container in which the device is marketed. However, the FCC identifier or the unique identifier, as appropriate, must be displayed on the device.

§ 15.21 Information to user.

The users manual or instruction manual for an intentional or unintentional radiator shall caution the user that changes or modifications not expressly approved by the party responsible for compliance could void the user's authority to operate the equipment.



Verification & User's Manual Information

The following is extracted from Title 47 of the Code of Federal Regulations, Part 15, Subpart B — Unintentional Radiators:

§ 15.105 Information to the user.

- (a) For a Class A digital device or peripheral, the instructions furnished the user shall include the following or similar statement, placed in a prominent location in the text of the manual:

Note: This equipment has been tested and found to comply with the limits for a Class A digital device, pursuant to Part 15 of the FCC Rules. These limits are designed to provide reasonable protection against harmful interference when the equipment is operated in a commercial environment. This equipment generates, uses, and can radiate radio frequency energy and, if not installed and used in accordance with the instruction manual, may cause harmful interference to radio communications. Operation of this equipment in a residential area is likely to cause harmful interference in which case the user will be required to correct the interference at own expense.

- (b) For a Class B digital device or peripheral, the instructions furnished the user shall include the following or similar statement, placed in a prominent location in the text of the manual:

Note: This equipment has been tested and found to comply with the limits for a Class B digital device, pursuant to Part 15 of the FCC Rules. These limits are designed to provide reasonable protection against harmful interference when the equipment is operated in a residential environment. This equipment generates, uses, and can radiate radio frequency energy and, if not installed and used in accordance with the instruction manual, may cause harmful interference to radio communications. However, there is no guarantee that interference will not occur in a particular installation. If this equipment does cause harmful interference to radio or television reception, which can be determined by turning the equipment off and on, the user is encouraged to try to correct the interference by one or more of the following measures:

- Reorient or relocate the receiving antenna.
- Increase the separation between the equipment and receiver.
- Connect the equipment into an outlet on a circuit different from that to which the receiver is connected.
- Consult the dealer or an experienced radio/TV technician for help.



ICES-003 Procedural & Labeling Requirements

From the Industry Canada Electromagnetic Compatibility Advisory Bulletin entitled, "Implementation and Interpretation of the Interference-Causing Equipment Standard for Digital Apparatus, ICES-003" (EMCAB-3, Issue 2, July 1995):

"At present, CISPR 22: 2002 and ICES technical requirements are essentially equivalent. Therefore, if you have CISPR 22: 2002 approval by meeting CISPR Publication 22, the only additional requirements are: to attach a note to the report of the test results for compliance, indicating that these results are deemed satisfactory evidence of compliance with ICES-003 of the Canadian Interference-Causing Equipment Regulations; to maintain these records on file for the requisite five year period; and to provide the device with a notice of compliance in accordance with ICES-003."

Procedural Requirements:

According to Industry Canada's Interference Causing Equipment Standard for Digital Apparatus ICES-003 Issue 4, February 2004:

- Section 6.1: A record of the measurements and results, showing the date that the measurements were completed, shall be retained by the manufacturer or importer for a period of at least five years from the date shown in the record and made available for examination on the request of the Minister.
- Section 6.2: A written notice indicating compliance must accompany each unit of digital apparatus to the end user. The notice shall be in the form of a label that is affixed to the apparatus. Where because of insufficient space or other constraints it is not feasible to affix a label to the apparatus, the notice may be in the form of a statement in the user's manual.

Labeling Requirements:

The suggested text for the notice, in English and in French, is provided below, from the Annex of ICES-003:

This Class [²] digital apparatus complies with Canadian ICES-003.

Cet appareil numérique de la classe [¹] est conforme à la norme NMB-003 du Canada.

² Insert either A or B but not both as appropriate for the equipment requirements.

End of Report