

Antenna Info

Antenna 1:

Manufacturer: Ethertronics Incorporated
Model: 1000418
Gain @ 4.9-5.9GHz: 3.5 dBi peak
Gain @ 2.39-2.49GHz: 2.5 dBi peak
Description: Isolated Magnetic Dipole (IMD)

Antenna Cable Info

Manufacturer: Sunridge Corporation
Model: MCD-R-60-105-MCBG
Cable Loss @ 4.9-5.9GHz: 0.78 dB
Cable Loss @ 2.39-2.49GHz: 0.47 dB
Description: Coax, MCD/W.FL to MCB/U.FL, 105mm

Compliance with FCC Part 15.203: The antenna cable connects to the device through a W.FL connector. The other end is a U.FL connector, which is then attached to the antenna. This does not use a standard antenna jack.

The Ethertronics Incorporated and Sunridge Corporation datasheets follow.

Antenna 2:

Manufacturer: Pulse Electronics
Model: W3006
Gain @ 4.9-5.9GHz: 4.2 dBi peak
Gain @ 2.39-2.49GHz: 3.2 dBi peak
Description: Ceramic Chip Antenna

Antenna Cable Info

Manufacturer: Sunridge Corporation
Model: MCD-DH-68-035A
Cable Loss @ 4.9-5.9GHz: 0.33 dB
Cable Loss @ 2.39-2.49GHz: 0.20 dB
Description: Coax, MCD/W.FL to MCD/W.FL, 35mm

Antenna Feed Trace Requirements:

All host board designs using a feed trace with chip antenna Pulse W3006 must be approved and signed off by Logic PD prior to production.

The design must follow these guidelines:

- The 37x Torpedo + Wireless SOM -31 must have a cable, Sunridge Corporation MCD-DH-68-035A of length 35mm or longer (same or more dB loss), attached to the W.FL antenna connector of the SOM. The other end of this cable must connect to a W.FL connector on the host board.
- The trace on the host board shall be 50 ohms microstrip over a continuous ground plane. That ground plane shall be the same ground plane as the one that the chip antenna is coupled to.
- There shall be no other traces within 4 times the width of the feed trace, and no traces between the feed trace and the continuous ground plane.

- The feed trace must be routed on the outside layers of the board with ground guard vias every .100" or less.
- The feed trace may have 1 through-hole via allowing the trace to transition from the top to bottom (or vice versa).
- The feed trace must be less than 1" in length.
- The feed trace may include passive components for impedance matching purposes.
- The ground plane must be cleared under the chip antenna for an area of 11.60 x 6.00mm. The cleared ground plane must follow the image guidelines below (dimensions in mm):

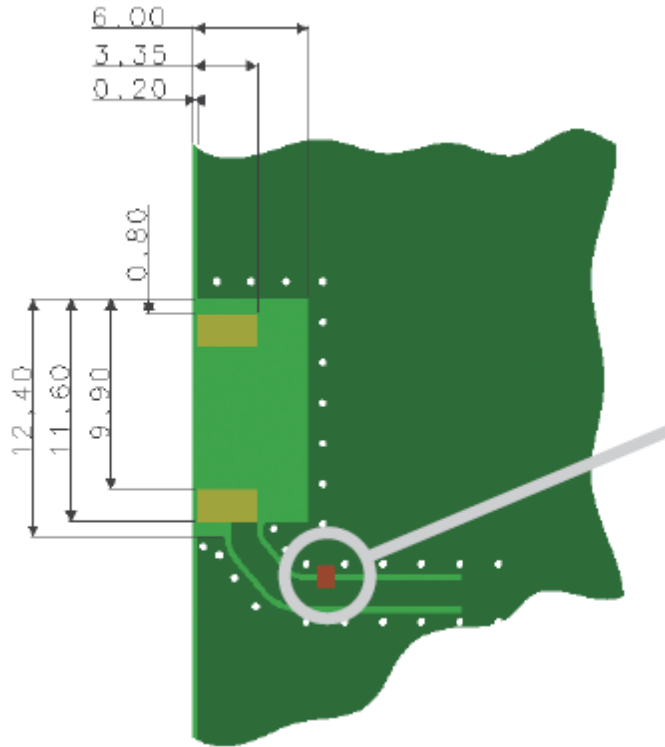

Compliance with FCC Part 15.203: The antenna cable connects to the device through a W.FL connector. The other end is a W.FL connector, which is then attached to the host PCB. This does not use a standard antenna jack.

The Pulse Electronics and Sunridge Corporation datasheets follow.

Prestta™ WLAN Embedded Antenna

2.4/4.9/5.2/5.8 GHz (802.11 a/b/g/n + Japan)

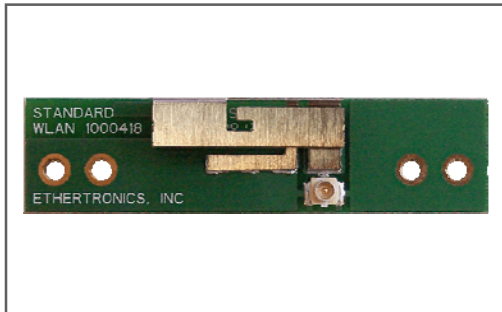

Ethertronics' Prestta series of Isolated Magnetic Dipole™ (IMD) stamped metal antennas address the challenges facing today's product designers. IMD's high performance and isolation characteristics offer better connectivity and minimal interference. IMD antennas can be used in a variety of devices:

- Notebook Computers
- Access Points
- Industrial Handhelds
- WiFi enabled Televisions & Monitors

TECHNOLOGY ADVANTAGES



Stays in Tune
IMD antenna technology provides superior RF field containment, resulting in less interaction with surrounding components. Ethertronics IMD antennas resist de-tuning; providing a robust radio link regardless of the usage position.

Prestta WLAN antennas use patented IMD technology in a stamped metal configuration to provide high performance. IMD antennas requires a smaller design keep-out area, carry lower program development risk which yields a quicker time-to-market, without sacrificing RF performance.

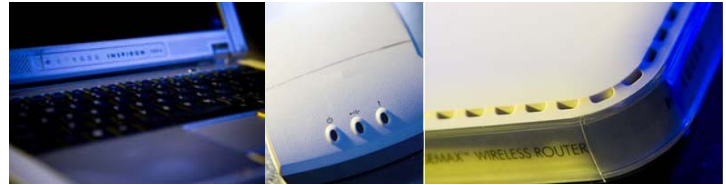

KEY BENEFITS

DESIGN ADVANTAGES

Quicker Time-to-Market

- By optimizing antenna size, performance and emissions, customer and regulatory specifications are more easily met.

Greater Flexibility

- Ethertronics' first-in-class IMD technology enables you to develop concept designs that are more advanced and that deliver superior performance in reception-critical applications.
- Connector located on the PCB allows for custom cable lengths to fit a variety of devices

RoHS Compliant

- Ethertronics' antennas are fully compliant with the European RoHS Directive 2002/95/EC.

END USER ADVANTAGES

Unique Form Factors Support Advanced Industrial Designs

- Smaller, more efficient IMD embedded antennas break through restrictive design rules and provide new freedom in component placement.

Superior Range & Signal Strength

- Better antenna function means longer range and greater sensitivity to critically precise signals—delivering greater customer satisfaction while building brand loyalty.

SERVICE AND SUPPORT

Extensive RF Experience

- Our WLAN antennas are supported by documentation, and when needed, by the expertise of RF engineers who have integrated hundreds of antenna designs into wireless devices.

Global Operations & Design Support

- Ethertronics' global operations supports an integrated network of design centers that can take projects from concept to production.

PRODUCT: WLAN a/b/g/n + Japan

Ethertronics' Internal (Embedded) Antenna Specifications.

Below are the typical specs for a WLAN application.

Electrical Specifications Typical Characteristics

WLAN a/b/g/n + Japan Antenna (GHz)	2.390-2.490 b, g	4.900-5.100 Japan	5.150-5.350 a	5.70-5.900 a
Peak Gain	1.5-2.5 dBi	1.5-3.5 dBi	2-3.5 dBi	2-3.5 dBi
Efficiency	65%	65%	65%	70%
VSWR Match	<2.0:1	<1.5:1	<2.0:1	<2.0:1
Feed Point Impedance	50 Ω unbalanced (other if required)			

Mechanical Specifications

Dimensions	17.9 x 6.9 x 4.3 mm (Antenna); 45.0 x 11.3 x 0.8 mm (PCB)
Weight	1.6 g
Cable / Connector	Contact Ethertronics for details.
Cable Length	150 mm, 300mm 450mm, 600mm available

VSWR

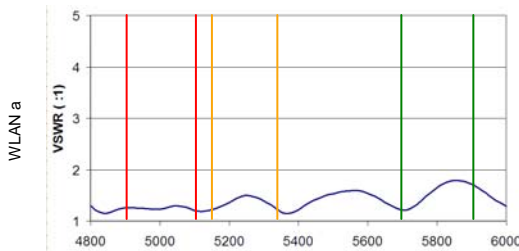
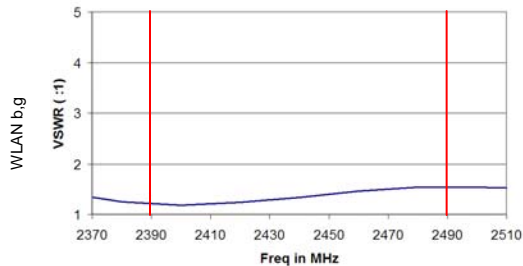

Efficiencies

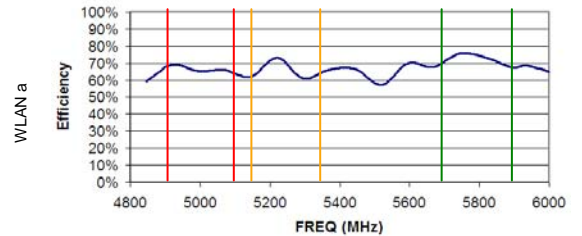
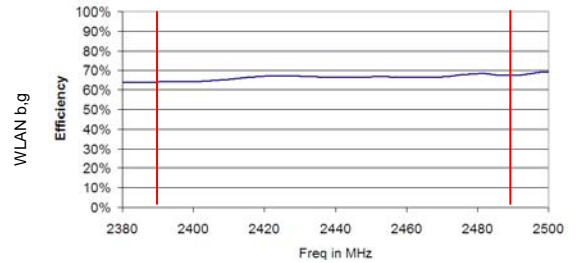

Antenna Radiation Patterns

Typical Performance

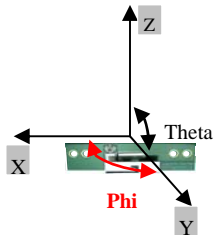

Phi = 0° Plane

Phi = 90° Plane

Theta = 90° Plane

2.390-2.490 GHz Band

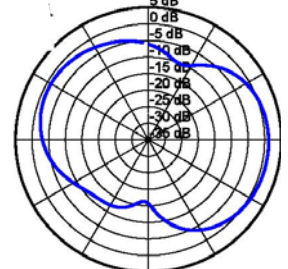
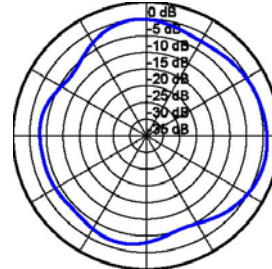
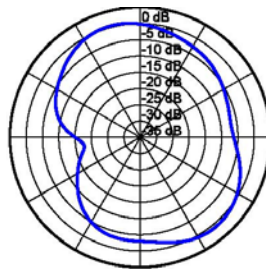

4.900-5.900 GHz

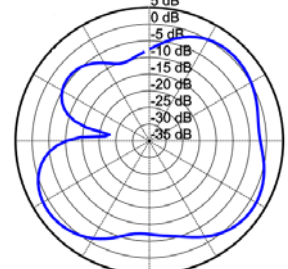
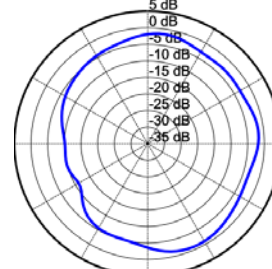
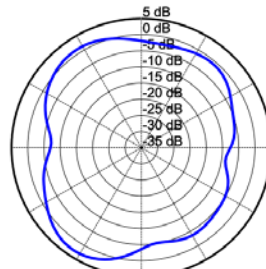

Sunridge MCB Series – Miniature Coaxial Interconnect, 2.5mm or 2.0mm Mated Height



Sunridge MCB series coaxial product fulfills the rigorous requirements of high frequency data transmission in digital world. Constructed in supreme Teflon coax cable and advanced mechanical design, MCB delivers high electrical performance of a typical 1.3 max VSWR measurement at 6.0GHz, while providing for a sturdy interconnection in a slim form factor of 3.0mm square footprint by 2.5mm max mated height. For tight spaced application, MCB2 plug offers an ultra low-mated profile of 2.0mm on the same MCB socket.

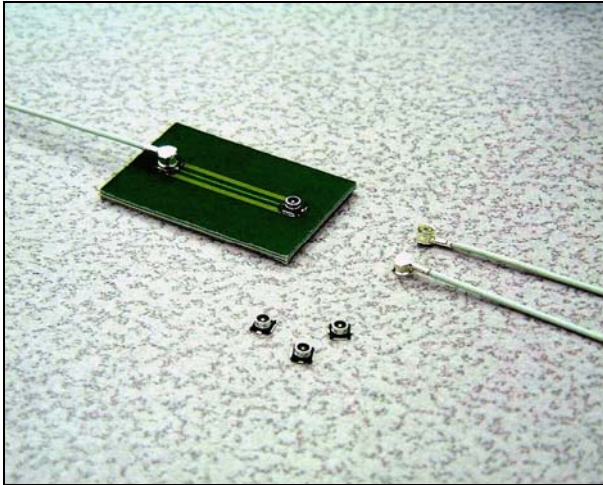

Applications: For Bluetooth, 802.11 WLAN, GPS, wireless communication designs in smart cell phone, PDA, and notebook or hand held information devices - for up to 6GHz frequency. A perfect push-button solution for antenna feedline.

■ Features

- Space Economy: PCB footprint of 3.1mm x 3.0mm, mated height of 2.5mm or 2.0mm.
- Teflon Cable: Silver-plated center conductor with Teflon dielectric and jacket.
- Application-specific cable options: from 0.81mm OD flexible cable ideal for intricate routing inside a cramped package, to 1.24mm or 1.32mm OD cable that delivers RG178 performance with space and weight saving.
- PCB connector: Integral molded construction ensures product reliability.
- Sturdy Connection: Lead-in and interlock features among mating pair ensure solid coupling.
- Accessory: Extraction tool for easy replacement, and MCB-SMA adapter for tester fitting.

■ Form Factor

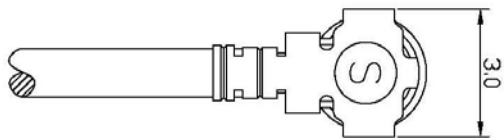

Cable Assembly (Plug)

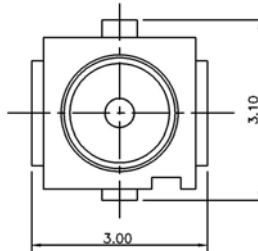

PCB Connector (Receptacle)
Pn: MCB-ST-00T

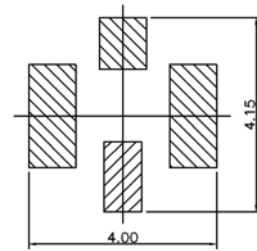

Recommended PCB Layout

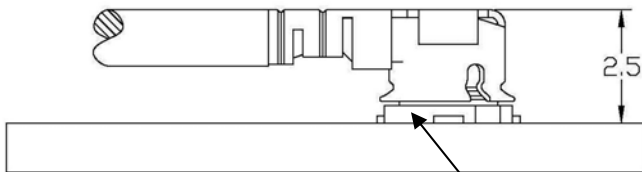

MCB Profile

Pn: MCB-ST-00T(Ref)

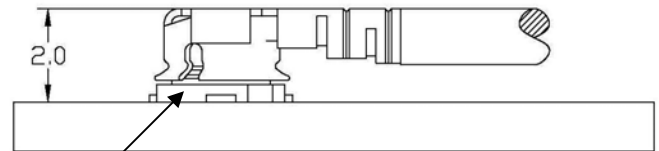

MCB2 Profile
(With same PCB connector)

(dimension: mm)



www.sunridgecorp.com

Sunridge Corporation

Specialist in Interconnect Solutions



Sunridge MCB Series – Miniature Coaxial Interconnect, 2.5mm or 2.0mm Mated Height



MCB Cable Assembly

(Mate with MCB-ST-00T: 2.5mm max heights.)

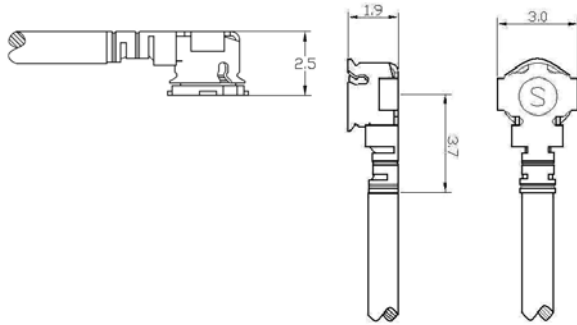

Cable Option: MCB head can be assembled with cables of 0.81mm OD to 1.33mm OD.

MCB2 Cable Assembly -- For Space Tight Applications

(Mate with MCB-ST-00T: 2.0mm heights.)

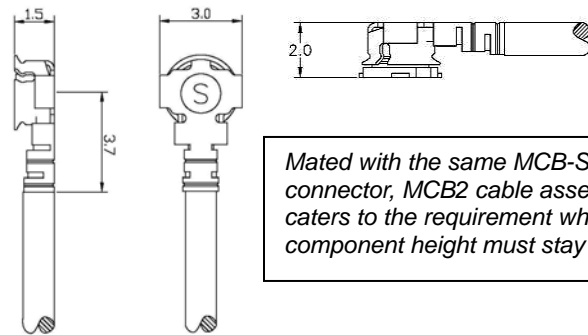

Mated with the same MCB-ST-00T pcb connector, MCB2 cable assembly caters to the requirement where component height must stay at 2.0mm.

Cable Option: Due to its miniature structure, MCB2 head can only be assembled with cable of 1.13mm OD or smaller, i.e., #59, #60 or #68 cable.

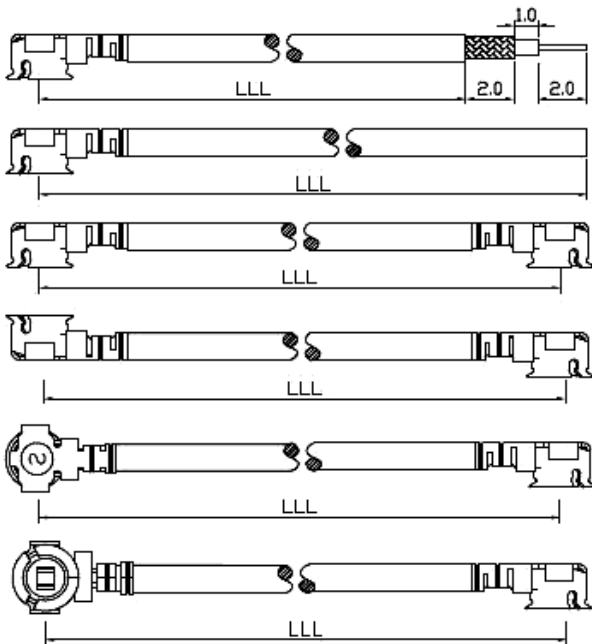

PN: MCB-SH-XX-LLL-T

PN: MCB-SH-XX-LLL-F

PN: MCB-DH-XX-LLL

(Both connectors face down)

PN: MCB-DH-XX-LLL-R1

(One connector faces down, one faces up)

PN: MCB-DH-XX-LLL-R2

(End view: near conn faces down, far conn faces right)

PN: MCB-DH-XX-LLL-R3

(End view: near conn faces down, far conn faces left)

● P/N Designation

For MCB head

MCBG - XX - XX - XXX - X (gold plated)

MCB - XX - XX - XXX - X (silver plated)

A B C D

For MCB2 head

MCB2G - XX - XX - XXX - X (gold plated)

MCB2 - XX - XX - XXX - X (silver plated)

A B C D

A. Head Configuration: SH: Single-Headed Cable Assembly
DH: Double-Headed Cable Assembly

B. Coaxial Cable Code: see cable selection guide (p.4)

C. Length (in mm): e.g., LLL = 200 means 200mm; LLL = 073 means 73mm

D. End Cut (for SH) T: stripped, tinned at outer & center conductor
F: open end flat cut

D. Orientation: blank: Both connectors face down
(for DH) R1: One faces down, one up
R2: End view: near one faces down, far one right
R3: End view: near one faces down, far one left

www.sunridgecorp.com

(dimension: mm)



Sunridge Corporation

Specialist in Interconnect Solutions





PCB Connector

Pn: MCBG-ST-00T (gold plated)
 MCB-ST-00T (silver plated)

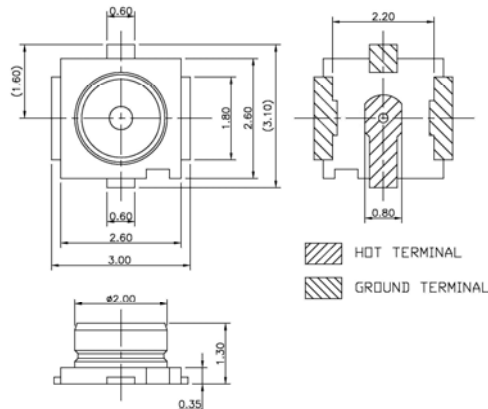

Stranded Package: 5,000pcs per tape reel.

Material Spec

Outer Contact: Copper Alloy, Gold or Silver Plated.
Center Contact: Copper Alloy, Gold Plated.
Insulator: Engineering Plastic.
Cable: Silver plated center conductor with Teflon dielectric and jacket.

Recommended PCB Layout

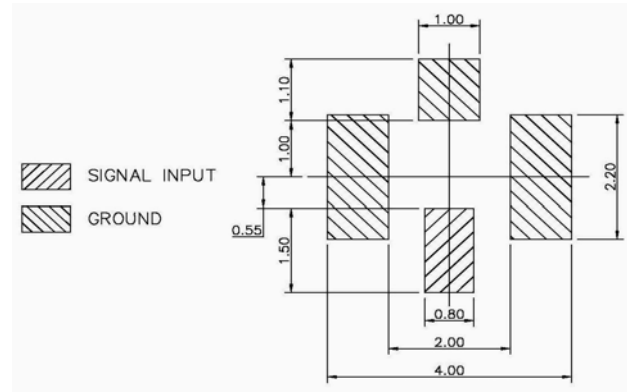

Electrical Characteristics	
VSWR @ 6GHz	1.3 Max.
Nominal Impedance	50 ohm
Temperature Range	-40°C to +90°C
Voltage Rating	250Vrms
Contact Resistance	15m ohm Max
Withstanding Voltage	AC300Vrms
Insulation Resistance	500m ohm Min

Insertion/Extraction Tool: Pn: ET-MCB



Mechanical Application:

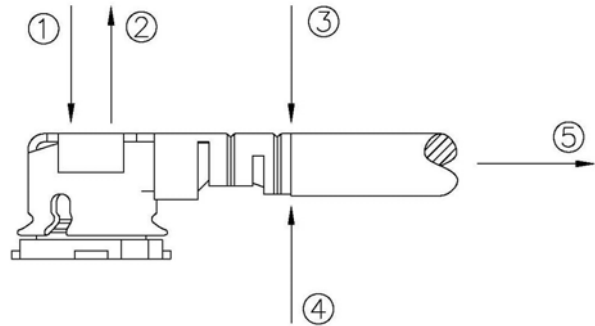

- ① Insertion force (with tool): 800gf.
 - ② Extraction force (with tool): 600gf.
 - ③ Retention, downward force: 200gf max.
 - ④ Retention, upward force: 200gf max.
 - ⑤ Retention, pull back: 400gf max
- Durability: 30 cycles

Adapter: Pn: MCBP-SMAJ
 (Connection to Network Analyzer)

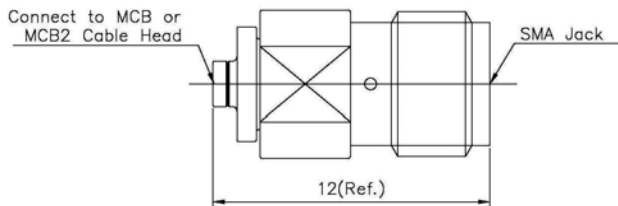

MCB Plug to SMA Jack

Sunridge MCB Series – Miniature Coaxial Interconnect, 2.5mm or 2.0mm Mated Height



Cable Selection Guide

Cable Designation Code			#54 *	#56 *	#53	#59	#60	#68
Inner conductor	No. and Dia.	(No./mm)	7/0.102	1/0.26	7/0.08	7/0.08	7/0.064	7/0.05
	Material	—	Silver plated copper wire	Silver pltd/copper covered steel wire	Silver plated copper wire	Silver plated copper wire	Silver plated copper wire	Silver plated copper wire
	Total Dia.	(mm)	0.305	0.26	0.24	0.24	0.192	0.15
Dielectric	Material	—	FEP	FEP	FEP	FEP	FEP	PFA
	Total Dia .	(mm)	0.88	0.8	0.66	0.68	0.53	0.4
Outer conductor	Material	—	Tinned copper wire	Tinned copper wire	Tinned copper wire	Tinned copper wire	Tinned copper wire	Tinned copper wire
	Dia. of wire	(mm)	0.05	0.05	0.05	0.05	0.05	0.05
	Total Dia.	(mm)	1.13	1.05	1.12 (double shield)	0.93	0.78	0.65
Jacket	Material	—	FEP	FEP	FEP	FEP	FEP	PFA
	Nominal thickness	(mm)	0.1	0.1	0.1	0.1	0.1	0.08
Overall Dia.		(mm)	1.33	1.24	1.32	1.13	0.98	0.81
Nominal impedance		(Ohm)	50	50	50	50	50	50
Voltage rating		Vrms Max.	300	300	300	300	300	300
Nominal static capacitance		(pF/m)	96	100	95	97	97	96
Insertion loss	dB/m at 1GHz		1.61	1.56	2.11	2.06	2.66	3.53
	dB/m at 2GHz		2.33	2.30	3.04	2.97	3.82	5.17
	dB/m at 2.4GHz		2.58	2.54	3.35	3.27	4.45	5.71
	dB/m at 3GHz		2.92	2.90	3.77	3.69	4.73	6.45
	dB/m at 5GHz		4.10	4.25	4.98	4.87	6.21	8.53
	dB/m at 6GHz		4.31	4.48	5.50	5.38	7.45	9.42

(data as provided by material suppliers, for reference only)

* #54 or #56 performs as well as RG178 (1.80mm OD) in a much smaller size, which works well for MCB's unique design; its RG178 alike structure, meanwhile, is process compatible for a wide variety of RF connector types.

Integrated Solution

MCB- single headed cable is typically integrated with another R/F connector for interconnection, say, from module board to panel or to antenna fitting. Sunridge is equally committed to both R/F cable assy customers and OEM's. Send your application requirement to engineering@sunridgecorp.com for a project evaluation.

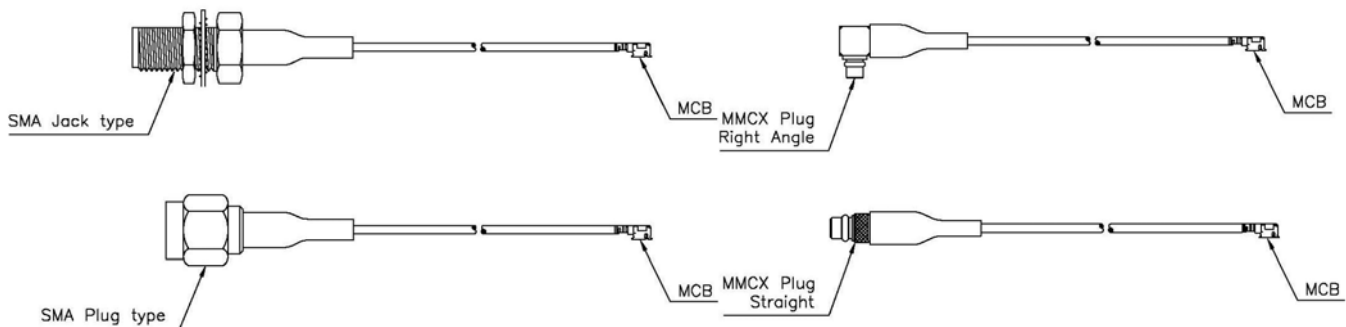

(dimension: mm)



www.sunridgecorp.com

Sunridge Corporation

Specialist in Interconnect Solutions



Sunridge MCB Series – Miniature Coaxial Interconnect, 2.5mm or 2.0mm Mated Height



MCB- Derivative Cable Assembly P/N Selector:

(Illustration of the most commonly used MCB-RF cable assy. A variety of other RF configurations is readily available at Sunridge Corp. Contact engineering@sunridgecorp.com for project inquiry.)

MCB to SMA Bulkhead Jack (Panel Mount) Cable Assembly:

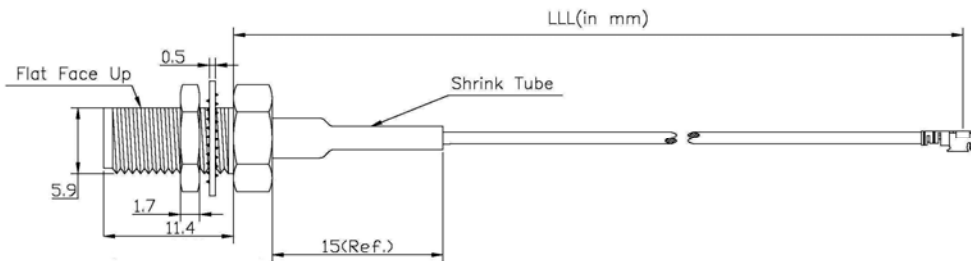

Range	Tolerance
50 < LLL < 100	± 2
100 < LLL < 200	± 3
300 < LLL < 300	± 5
300 < LLL < 500	± 10
500 < LLL < 1000	± 25
1000 < LLL	± 60

LLL: Length in mm. e.g., LLL = 200 means 200mm; LLL = 073 means 73mm

Descriptions	Recommended Cable	Sunridge P/N (MCB gold plated)
MCB to SMAJB	#54, 1.33 mm OD	MCBG-RH-54-LLL-SMAJB207
MCB to SMAJB Reverse Polarity (RP)	#54, 1.33 mm OD	MCBG-RH-54-LLL-SMAJB281
MCB to SMAJB with O-Ring Seal	#54, 1.33 mm OD	MCBG-RH-54-LLL-SMAJB209
MCB to SMAJB RP with O-ring Seal	#54, 1.33 mm OD	MCBG-RH-54-LLL-SMAJB283
MCB2 to SMAJB	#59, 1.13 mm OD	MCB2G-RH-59-LLL-SMAJB103
MCB2 to SMAJB Reverse Polarity (RP)	#59, 1.13 mm OD	MCB2G-RH-59-LLL-SMAJB181
MCB2 to SMAJB with O-Ring Seal	#59, 1.13 mm OD	MCB2G-RH-59-LLL-SMAJB105
MCB2 to SMAJB RP with O-ring Seal	#59, 1.13 mm OD	MCB2G-RH-59-LLL-SMAJB183

P/N Selection (referring to catalog P.2): For MCB silver-plated option, use MCB- or MCB2- prefix. For 2.5mm mated height, use MCBG (or MCB) prefix; for 2.0mm mated height application, use MCB2G (or MCB2) prefix.

MCB to SMA Plug Cable Assembly:

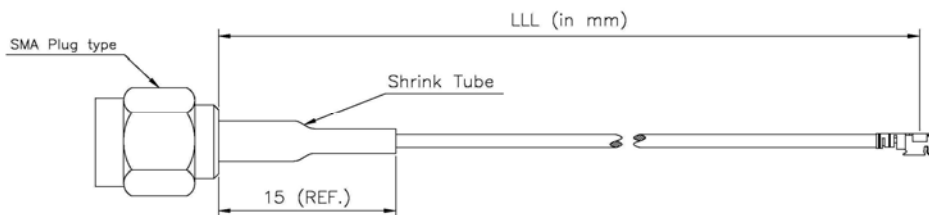

Range	Tolerance
50 < LLL < 100	± 2
100 < LLL < 200	± 3
300 < LLL < 300	± 5
300 < LLL < 500	± 10
500 < LLL < 1000	± 25
1000 < LLL	± 60

LLL: Length in mm. e.g., LLL = 200 means 200mm; LLL = 073 means 73mm

Descriptions	Recommended Cable	Sunridge P/N (MCB gold plated)
MCB to SMAP	#54, 1.33 mm OD	MCBG-RH-54-LLL-SMAP205
MCB to SMAP Reverse Polarity (RP)	#54, 1.33 mm OD	MCBG-RH-54-LLL-SMAP281
MCB2 to SMAP	#59, 1.13 mm OD	MCB2G-RH-59-LLL-SMAP103
MCB2 to SMAP Reverse Polarity (RP)	#59, 1.13 mm OD	MCB2G-RH-59-LLL-SMAP181

P/N Selection (referring to catalog P.2): For MCB silver-plated option, use MCB- or MCB2- prefix. For 2.5mm mated height, use MCBG (or MCB) prefix; for 2.0mm mated height application, use MCB2G (or MCB2) prefix.

Sunridge MCB Series – Miniature Coaxial Interconnect, 2.5mm or 2.0mm Mated Height



Performance Measurement Reference:

(Test sample: MCB dual head cable assy, 200mm; Test instrument: Agilent 8753ES network analyzer.)

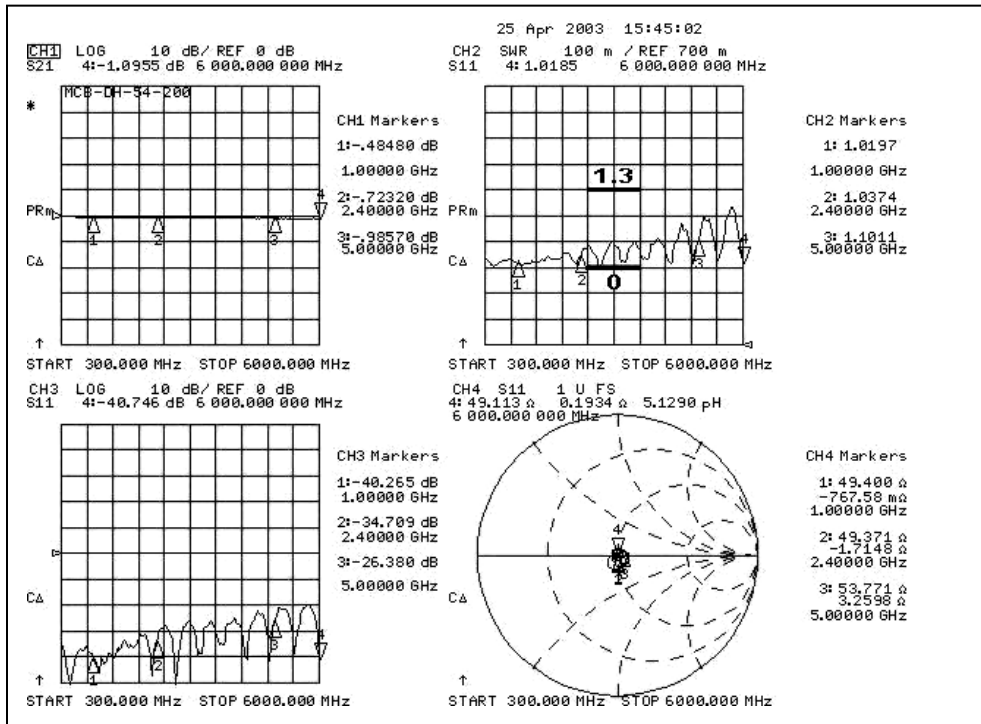

MCB-DH-54-200

Length: 200mm
Cable Code: #54
OD: 1.33mm
Inner Conductor: 0.24mm
Dielectric: 0.88mm
Outer Conductor: 1.13mm
Jacket: 1.33mm

RG178 grade

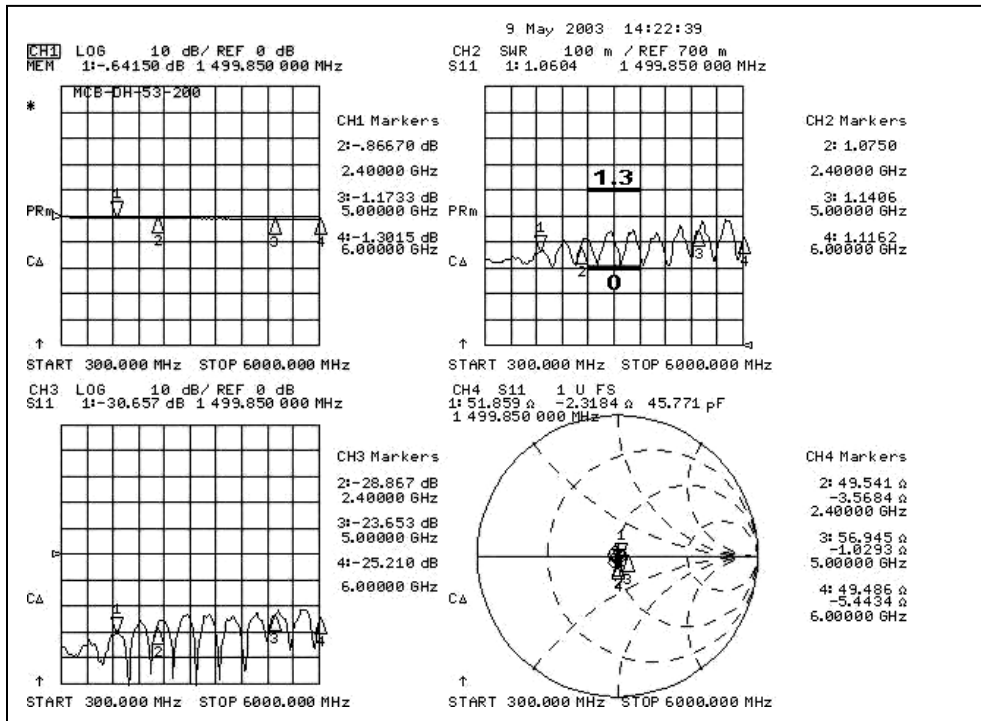

MCB-DH-53-200

Length: 200mm
Cable Code: #53
OD: 1.32mm
Inner Conductor: 0.24mm
Dielectric: 0.66mm
Outer Conductor: 1.12mm, double shielded
Jacket: 1.32mm



www.sunridgecorp.com

Sunridge Corporation

Specialist in Interconnect Solutions

Sunridge MCB Series – Miniature Coaxial Interconnect, 2.5mm or 2.0mm Mated Height



Performance Measurement Reference:

(Test sample: MCB dual head cable assy, 200mm; Test instrument: Agilent 8753ES network analyzer.)

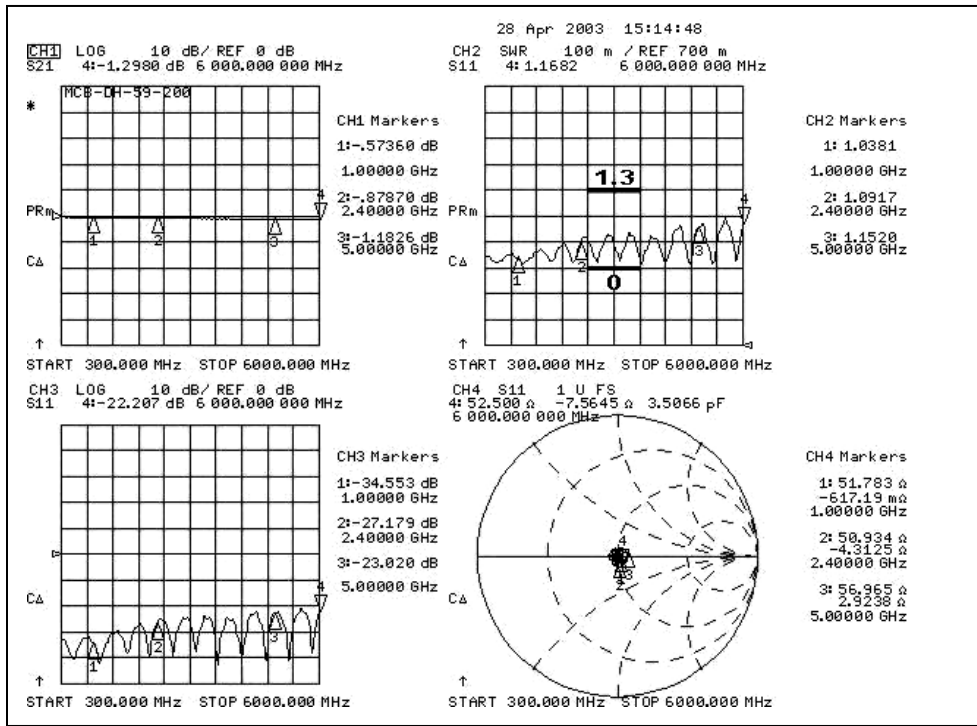

MCB-DH-59-200

Length: 200mm
Cable Code: #59
OD: 1.13mm
Inner Conductor: 0.24mm
Dielectric: 0.68mm
Outer Conductor: 0.93mm
Jacket: 1.13mm

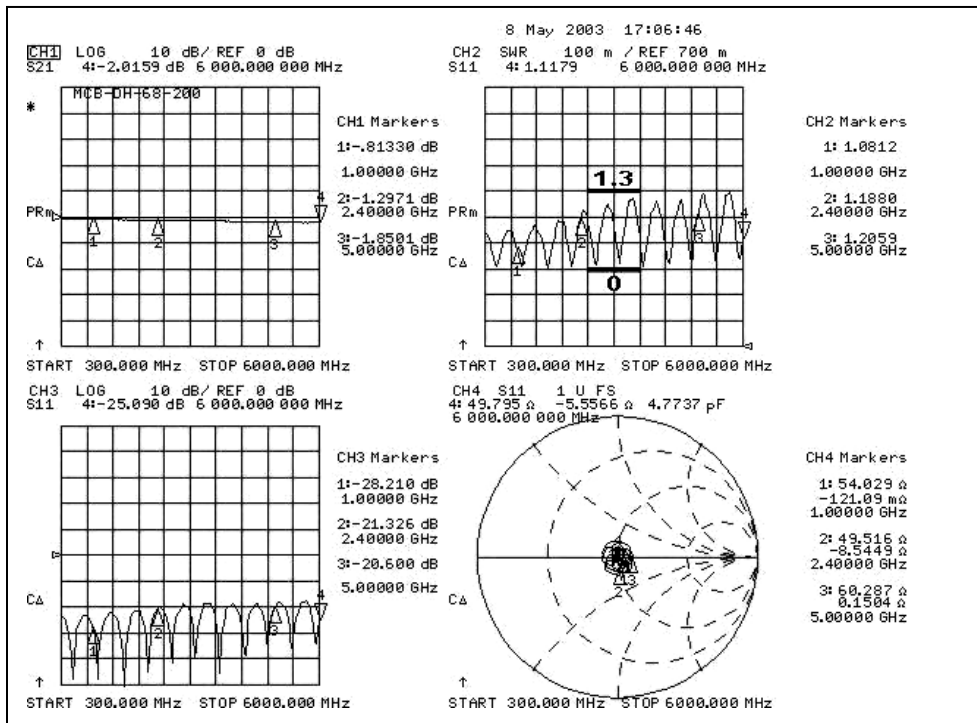

MCB-DH-68-200

Length: 200mm
Cable Code: #68
OD: 0.81mm
Inner Conductor: 0.15mm
Dielectric: 0.40mm
Outer Conductor: 0.65mm
Jacket: 0.81mm



www.sunridgecorp.com

Sunridge Corporation

Specialist in Interconnect Solutions



Sunridge MCB Series – Miniature Coaxial Interconnect, 2.5mm or 2.0mm Mated Height



Performance Measurement Reference:

(Test sample: MCB2 dual head cable assy, 200mm; Test instrument: Agilent 8753ES network analyzer.)

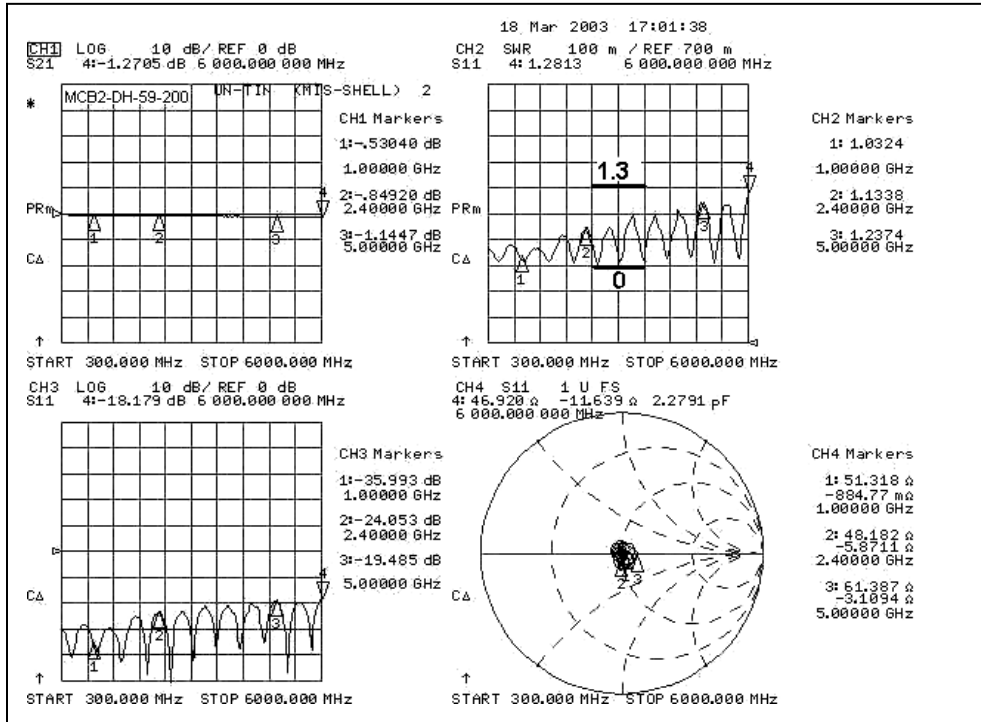

MCB2-DH-59-200

Length: 200mm
Cable Code: #59
OD: 1.13mm
Inner Conductor: 0.24mm
Dielectric: 0.68mm
Outer Conductor: 0.93mm
Jacket: 1.13mm

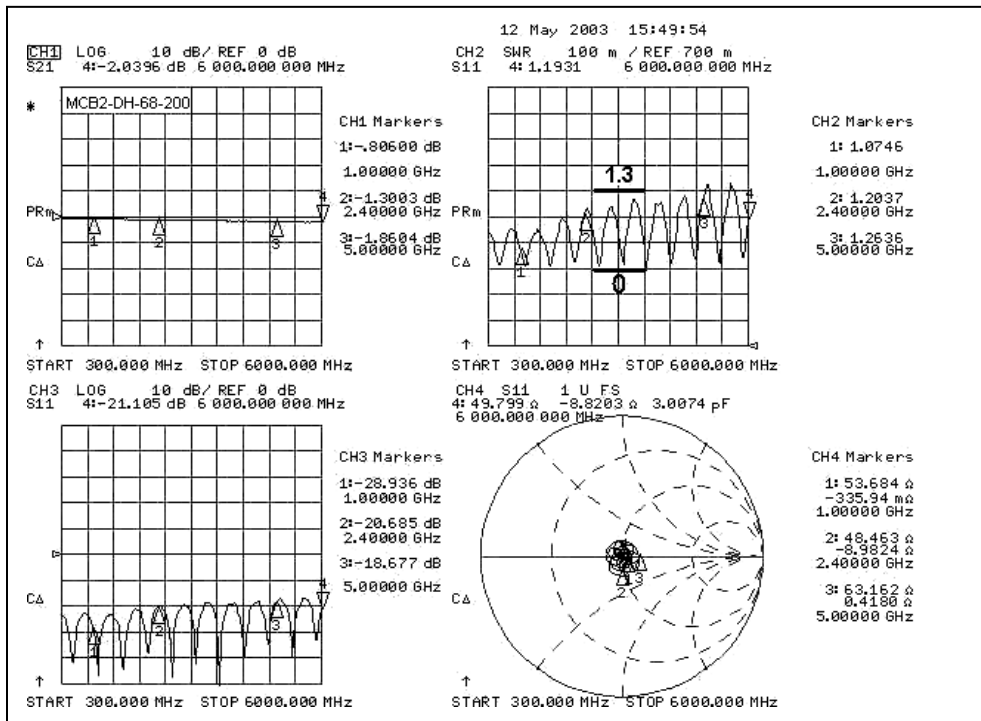

MCB2-DH-68-200

Length: 200mm
Cable Code: #68
OD: 0.81mm
Inner Conductor: 0.15mm
Dielectric: 0.40mm
Outer Conductor: 0.65mm
Jacket: 0.81mm



www.sunridgecorp.com

Sunridge Corporation

Specialist in Interconnect Solutions



Sunridge MCD Series – Ultimate Miniature Coaxial Interconnect, 1.55mm Mated Height



Sunridge MCD series coaxial product fulfills the rigorous requirements of high frequency data transmission in digital world. Constructed in supreme Teflon coax cable and advanced mechanical design, MCD delivers high electrical performance of a typical 1.3 max VSWR at 6.0GHz, while providing for a sturdy interconnection in a slim form factor of 2.0mm x 2.0mm footprint by 1.55mm mated height.



Typical Application:
Smart cell phone, portable or wearable information devices, such as GPS receiver in wrist watch form factor, or hand-free sunglass cell phone.

Features

- Space Economy: 2.0mm x 2.0mm PCB footprint, mated height of 1.55mm.
- Teflon Cable s: Silver plated center conductor, Teflon dielectric and jacket.
- Cable Options: 0.81mm OD for routing flexibility; 0.91mm OD (with copper foil shield) for low insertion loss; 0.98mm OD, for structure strength.
- PCB connector: Integral molded construction ensures product reliability.
- Sturdy Connection: Lead-in and interlock features among mating pair ensure solid coupling.
- Accessory: Insertion/extraction tool, test adapters for connection to MCD cable head and PCB connector.

Form Factor

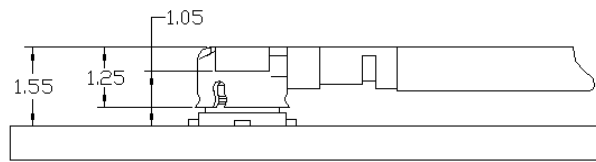

PCB Connector Pn: MCD-ST-00T

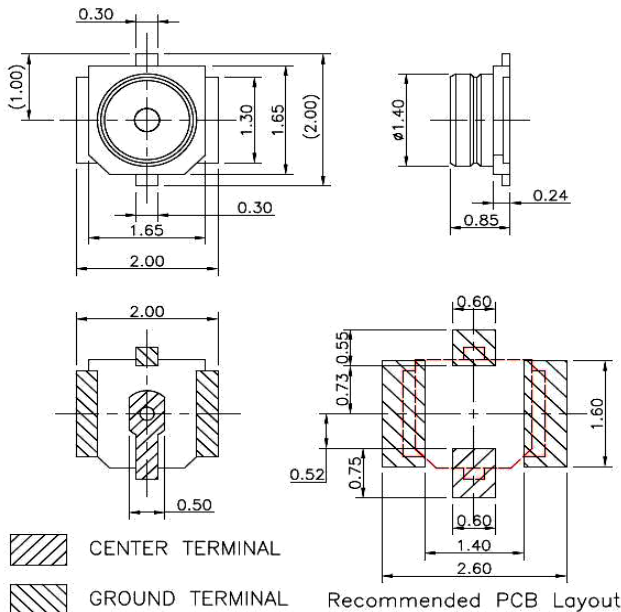

MCD Test Probe Pn: MCD-TP-LLL-SMAJB207 (For Production Test on MCD-ST-00T)

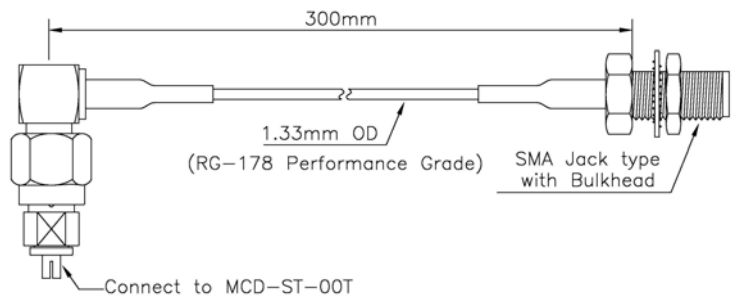

Note: For "SMA Plug" fitting, specify Pn MCD-TP-300-SMAP205

Characteristics	
Frequency Range	DC to 6GHz
Nominal Impedance	50 ohm
Temperature Range	-40°C to +90°C
Contact Resistance	25m ohm max
Withstanding Voltage	AC 200Vrms
Insulation Resistance	500M ohm min
Durability	20 Cycles

www.sunridgecorp.com



(dimension: mm)



Sunridge Corporation

Specialist in Interconnect Solutions



MCD Cable Assembly

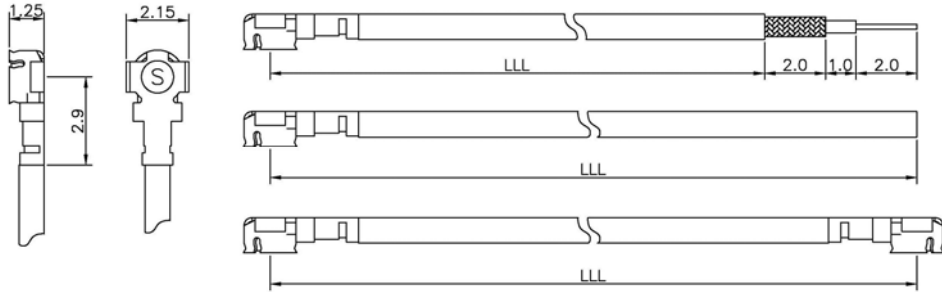

Pn: MCD-SH-□□-LLL-T

Pn: MCD-SH-□□-LLL-F

Pn: MCD-DH-□□-LLL

P/N Designation

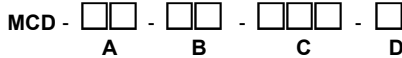

- A. Head Configuration: SH: Single-Headed Cable construction
DH: Double-Headed Cable construction
- B. Coaxial Cable Code: see cable selection guide
- C. Length (in mm): Ex: LLL = 200: 200mm.
- D. End Cut (SH only): T : open end striped & tinned.
F : open end flat cut

Insertion/Extraction Tool Pn: ET-MCD



Mechanical Application

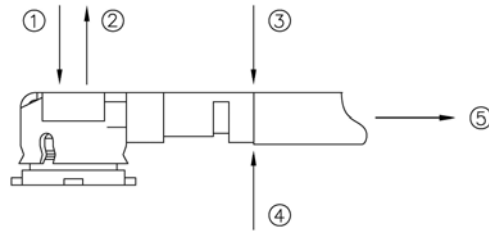

Test Adaptor Pn: MCDP-SMAJ
(Connection to Network Analyzer)

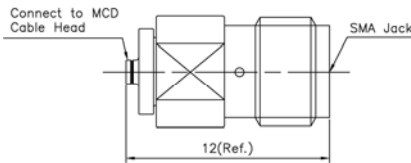

- ① Insertion force (with tool): 600gf.
 - ② Extraction force (with tool): 400gf.
 - ③ Retention, downward force: 200gf max.
 - ④ Retention, upward force: 200gf max.
 - ⑤ Retention, pull back: 400gf max
- Durability: 20 cycles

Integrated Solution

MCD- cable head is typically integrated with another R/F connector for a variety of applications, such as from module to host board or to panel fitting. Sunridge is committed to support customers' integration requirement. Send your project inquiry to engineering@sunridgecorp.com for an effective solution.

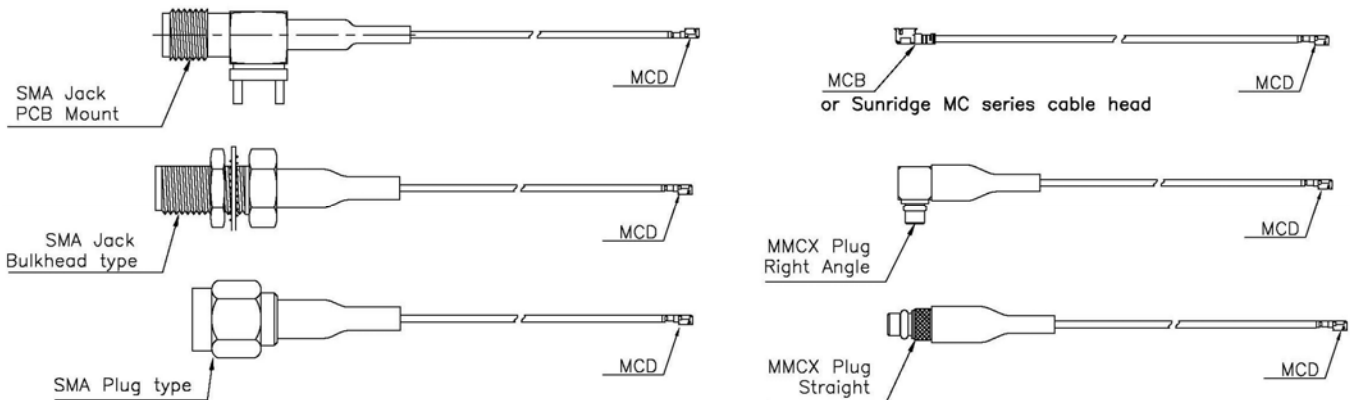

www.sunridgecorp.com

(dimension: mm)



Cable Selection Guide

Cable Designation Code			#62	#60	#68
Inner conductor	No. and Dia.	(No./mm)	7/0.07	7/0.064	7/0.05
	Material	—	Silver plated copper wire	Silver plated copper wire	Silver plated copper wire
	Total Dia.	(mm)	0.21	0.192	0.15
Dielectric	Material	—	FEP	FEP	PFA
	Total Dia .	(mm)	0.63	0.53	0.4
Outer conductor	Material	—	Tinned copper wire/copper tape	Tinned copper wire	Silver plated copper wire
	Dia. of wire	(mm)	0.05	0.05	0.05
	Total Dia.	(mm)	0.80	0.78	0.65
Jacket	Material	—	FEP	FEP	PFA
	Nominal thickness	(mm)	0.05	0.1	0.08
Overall Dia.		(mm)	0.91	0.98	0.81
Nominal impedance		(Ohm)	50	50	50
Voltage rating		Vrms Max.	300	300	300
Nominal static capacitance		(pF/m)	97	97	96
Insertion loss	dB/m at 1GHz		2.00	2.66	3.53
	dB/m at 2GHz		2.60	3.82	5.17
	dB/m at 2.4GHz		3.10	4.45	5.71
	dB/m at 3GHz		3.50	4.73	6.45
	dB/m at 5GHz		4.00	6.21	8.53
	dB/m at 6GHz		4.40	7.45	9.42

Application Note:

● #68 Cable of 0.81mm OD:

Feature: Thin and flexible. Good for short-length application that requires maximum flexibility and minimum pull-strain.

Suitable for: (1.) MCD-SH-68-LLL-T, single head cable assy with stripped end, for soldering directly to PCB. (2.) Board to board connection between two Sunridge MC- series PCB connectors, e.g., MCD-to-MCD or MCD-to-MCB (if the other end is free of the height constraint of 1.55mm) cable assy, etc. (3.) MCD-to-RF cable assy, such as MCD to SMA Jack (either panel mount or PCB mount) for connection to external antenna.

● #60 Cable of 0.98mm OD:

Features: Lower insertion loss. Strong mechanical structure.

Suitable for: (1.) MCD-SH-60-LLL-T, single head cable assy with stripped end, for soldering directly to PCB. (2.) Board to board connection between two Sunridge MC- series PCB connectors, e.g., MCD-to-MCD or MCD-to-MCB (if the other end is free of the height constraint of 1.55mm) cable assy, etc. (3.) MCD-to-RF cable assy, such as MCD to SMA Jack (either panel mount or PCB mount) for connection to external antenna.

● #62 Cable of 0.91mm OD:

Features: Very low insertion loss, and good EMI-shielding.

Caution: #62 cable is highly heat sensitive; thus, it should NOT be used for subsequent manual soldering. MCD-SH-62-LLL-T is NOT recommended for soldering directly to PCB or for assembly with another RF connector.

Suitable for: (1.) Board to board connection between two Sunridge MC- series PCB connectors, e.g., MCD-to-MCD or MCD-to-MCB (if the other end is free of the height constraint of 1.55mm) cable assy, etc. (2.) For low insertion-loss and low EMI requirement, Sunridge can offer MCD-to-RF cable assy solution with #62 cable, such as MCD to SMA Jack, upon customer's request.

www.sunridgecorp.com

(dimension: mm)



Sunridge Corporation

Specialist in Interconnect Solutions





MCD- Derivative Cable Assembly P/N Selector:

(Illustration of the most commonly used MCD-RF cable assy. A variety of other RF configurations is readily available at Sunridge Corp. Contact engineering@sunridgecorp.com for project inquiry.)

■ **MCD to SMA Bulkhead Jack (Panel Mount) Cable Assembly:**

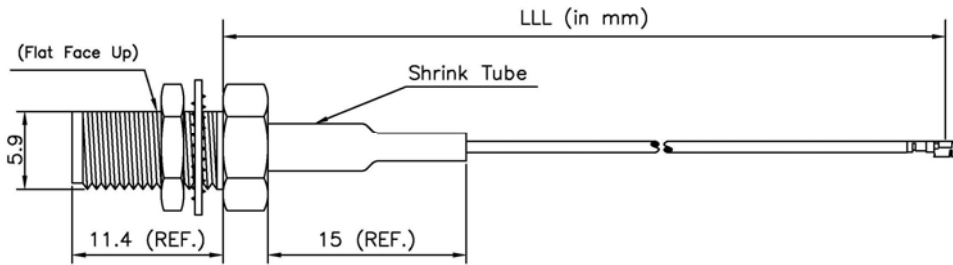

Range	Tolerance
50 < LLL < 100	± 2
100 < LLL < 200	± 3
300 < LLL < 300	± 5
300 < LLL < 500	± 10
500 < LLL < 1000	± 25
1000 < LLL	±60

LLL: Length in mm. e.g., LLL = 200 means 200mm; LLL = 073 means 73mm

Descriptions	Recommended Cable	Sunridge P/N
MCD to SMAJB	#60, 0.98 mm OD	MCD-RH-60-LLL-SMAJB103
MCD to SMAJB Reverse Polarity (RP)	#60, 0.98 mm OD	MCD-RH-60-LLL-SMAJB181
MCD to SMAJB with O-Ring Seal	#60, 0.98 mm OD	MCD-RH-60-LLL-SMAJB105
MCD to SMAJB RP with O-ring Seal	#60, 0.98 mm OD	MCD-RH-60-LLL-SMAJB183

■ **MCD to SMA Plug Cable Assembly:**

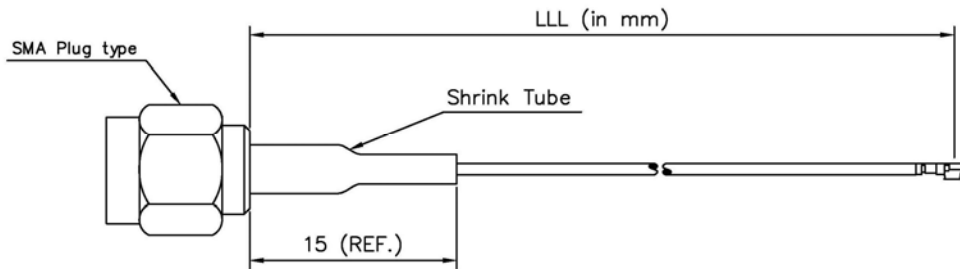

Range	Tolerance
50 < LLL < 100	± 2
100 < LLL < 200	± 3
300 < LLL < 300	± 5
300 < LLL < 500	± 10
500 < LLL < 1000	± 25
1000 < LLL	±60

LLL: Length in mm. e.g., LLL = 200 means 200mm; LLL = 073 means 73mm

Descriptions	Recommended Cable	Sunridge P/N
MCD to SMAP	#60, 0.98 mm OD	MCD-RH-60-LLL-SMAP103
MCD to SMAP Reverse Polarity (RP)	#60, 0.98 mm OD	MCD-RH-60-LLL-SMAP181





MCD to SMA Jack (PCB Mount) Cable Assembly:

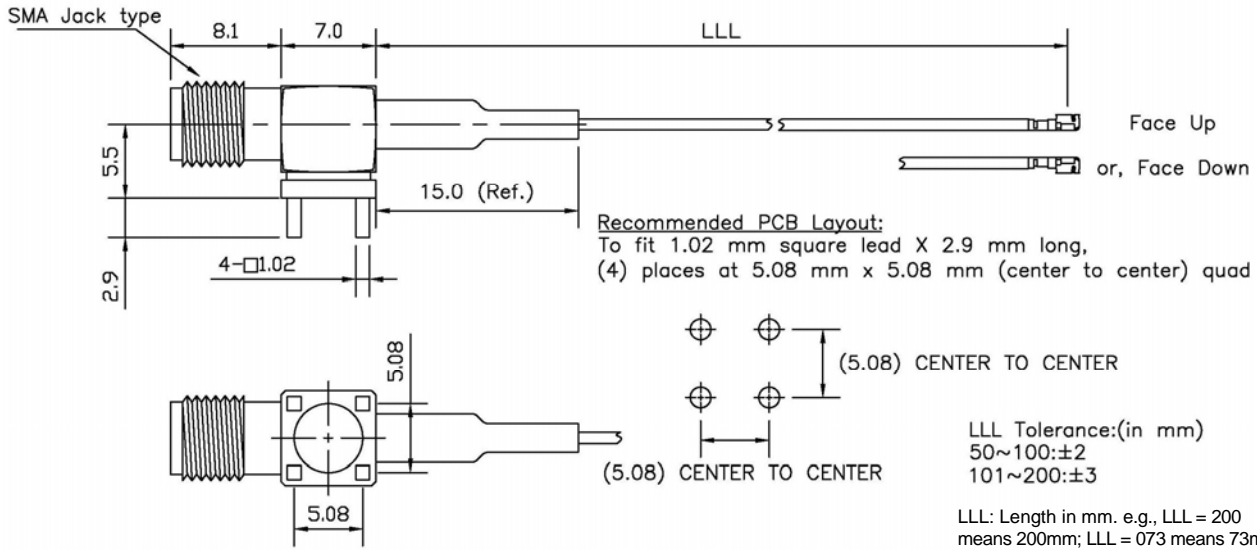

Descriptions	Recommended Cable	Sunridge P/N
MCD to SMAJ PCB Mount (Converse Orientation, MCD Faces Up)	#60, 0.98 mm OD	MCD-RH-60-LLL-SMAJX105-R1
MCD to SMAJ PCB Mount (Regular Orientation, MCD Faces Down)	#60, 0.98 mm OD	MCD-RH-60-LLL-SMAJX105

Performance Measurement Reference:

(Test sample: MCD dual head cable assy; Test instrument: Agilent 8753ES.)

MCD-DH-60-100

Length: 100mm
Cable Code: #60
OD: 0.98mm
Inner Conductor: 0.192mm
Dielectric: 0.53mm
Outer Conductor: 0.78mm
Jacket: 0.98mm

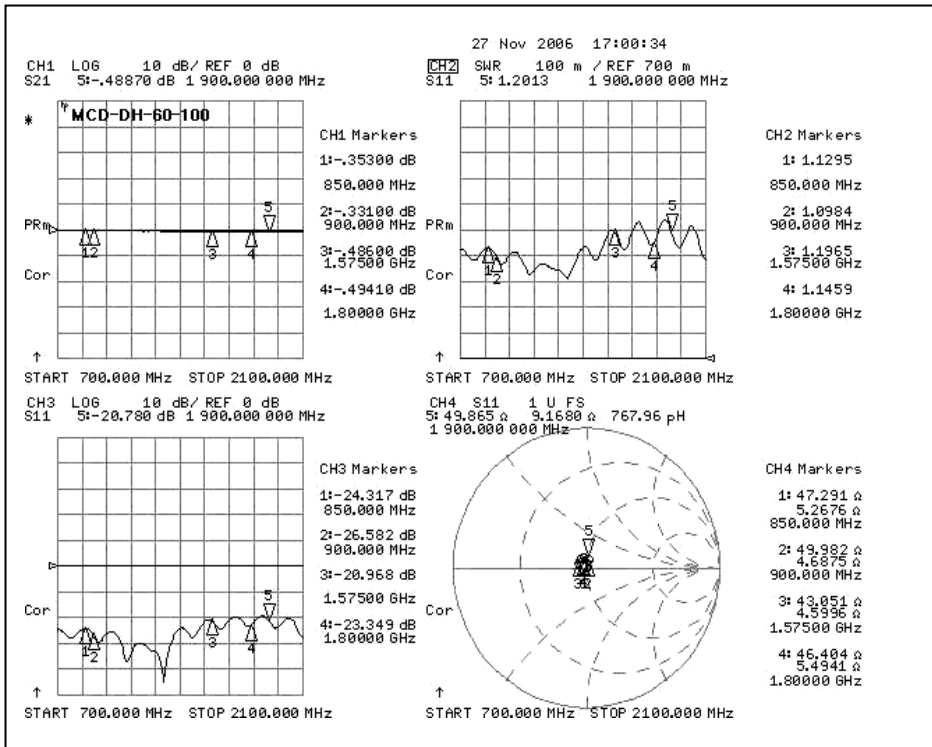



Performance Measurement Reference:

(Test sample: MCD dual head cable assy,100mm;Test instrument: Agilent 8753ES.)

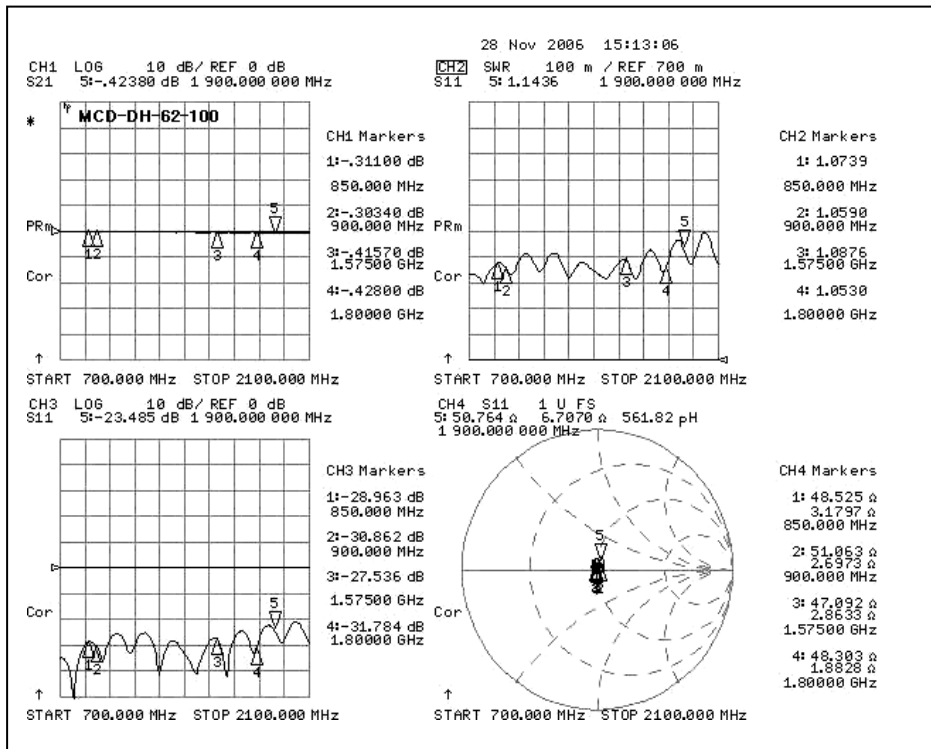

MCD-DH-62-100

Length: 100mm
Cable Code: #62
OD: 0.90mm
Inner Conductor: 0.21mm
Dielectric: 0.63mm
Outer Conductor(Copper PET):0.65mm
Outer Conductor: 0.80mm
Jacket: 0.90mm

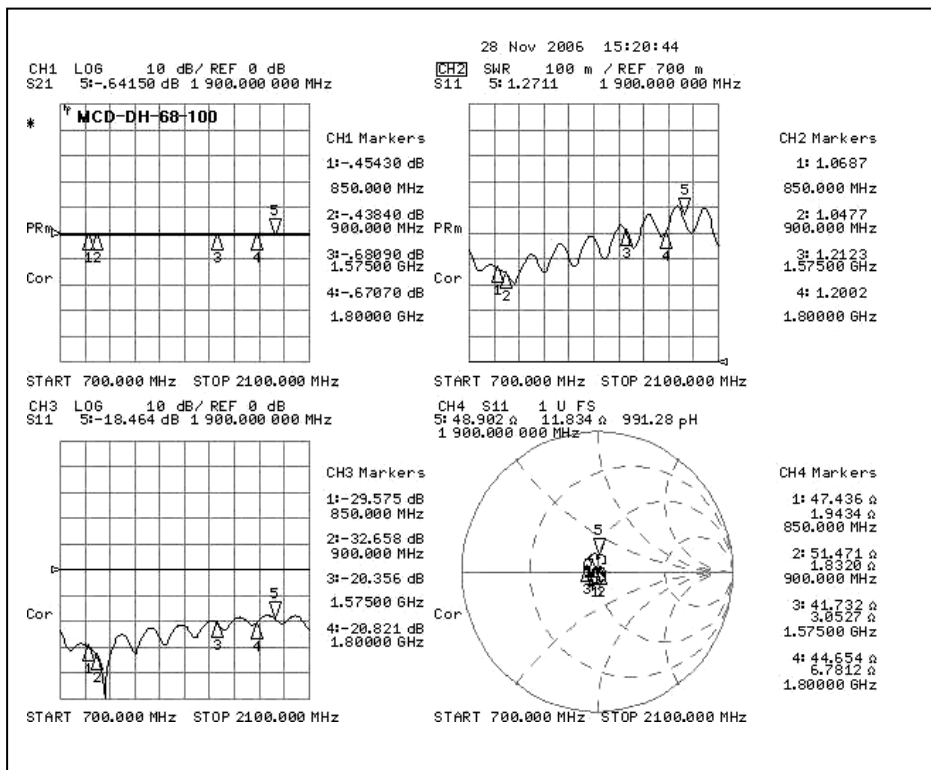

MCD-DH-68-100

Length: 100mm
Cable Code: #68
OD: 0.81mm
Inner Conductor: 0.15mm
Dielectric: 0.4mm
Outer Conductor: 0.65mm
Jacket: 0.81mm



Dualband WLAN Ceramic Chip Antenna

Ground cleared under antenna 11.60 x 6.00 mm. Pulse Part Number: W3006

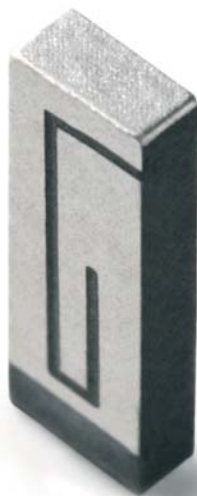

Features

- Omnidirectional radiation
- Low profile
- Compact size WxLxH (10.0 x 3.2 x 1.5 mm)
- Low weight (240 mg)
- Fully SMD compatible
- Lead free soldering compatible
- Tape and reel packing
- RoHS Compliant Product
- Single feed point

Applications

- IEEE 802.11a/b/g
- 5 GHz WLAN
- 2.4 GHz WLAN
- 2.4 GHz ISM Band Systems
- ZigBee IEEE 802.15.4

Electrical specifications @ +25 °C

Note: Electrical characteristics depend on test board (GP) size and antenna positioning on GP and Ground Clearance area size.

Dualband WLAN

Typical performance (testboard size 80 x 37 mm, PWB ground clearance area 11.60 x 6.00 mm)
1.5nH shunt inductor used for impedance matching.

Frequency Range [MHz]	Max Gain [dBi]	Efficiency [%] / [dB]	Return loss min. [dB]	Impedance [Ω]	Operating Temperature [°C]
2400–2483.5	3.2 (peak) 2.7 (band edges)	70 / -1.55 (peak) 65 / -1.85 (band edges)	-8	50	-40 to +85
5150–5850	4.2 (peak) 3.0 (band edges)	80 / -0.95 (peak) 70 / -1.55 (band edges)	-10	50	-40 to +85

Pulse Finland Oy

Takatie 6
90440 Kempele, Finland
Tel: +358 207 935 500
Fax: +358 207 935 501
www.pulseeng.com/antennas



Dualband WLAN Ceramic Chip Antenna

Ground cleared under antenna 11.60 x 6.00 mm. Pulse Part Number: W3006

**Recommended test board layout for electrical characteristic measurement,
test board outline size 80 x 37mm**

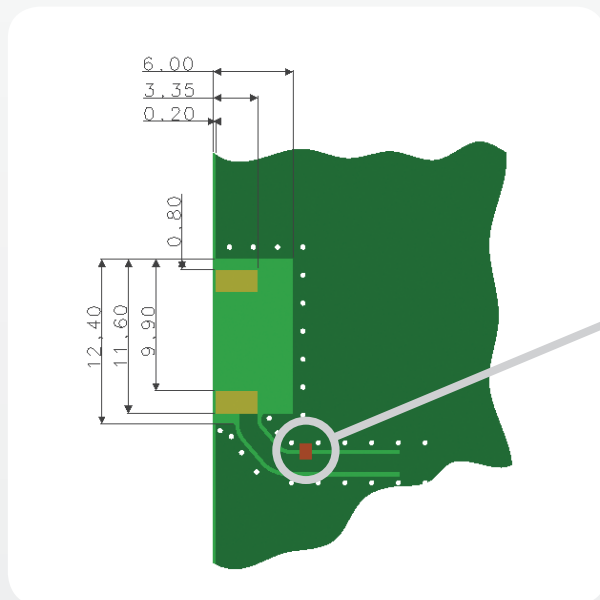

Shunt matching inductor,
1.5nH with presented setup.
Exact inductor value depends
on specific application.

Feed line should be designed to match 50 Ω characteristic impedance, depending on PWB material and thickness.

Pulse Finland Oy

Takatie 6
90440 Kempele, Finland
Tel: +358 207 935 500
Fax: +358 207 935 501

www.pulseeng.com/antennas

Dualband WLAN Ceramic Chip Antenna

Ground cleared under antenna 11.60 x 6.00 mm. Pulse Part Number: W3006

Typical Electrical Characteristics (T=25 °C)

2,4 GHz Typical Return Loss S11/ impedance, measured on the test board

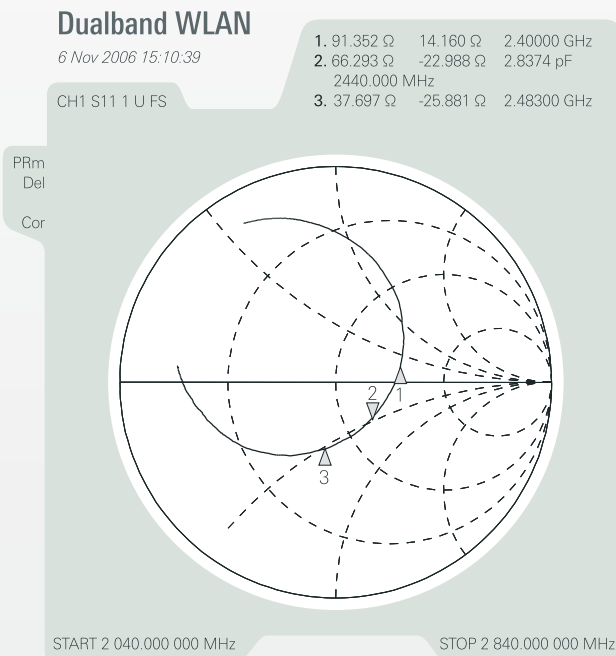
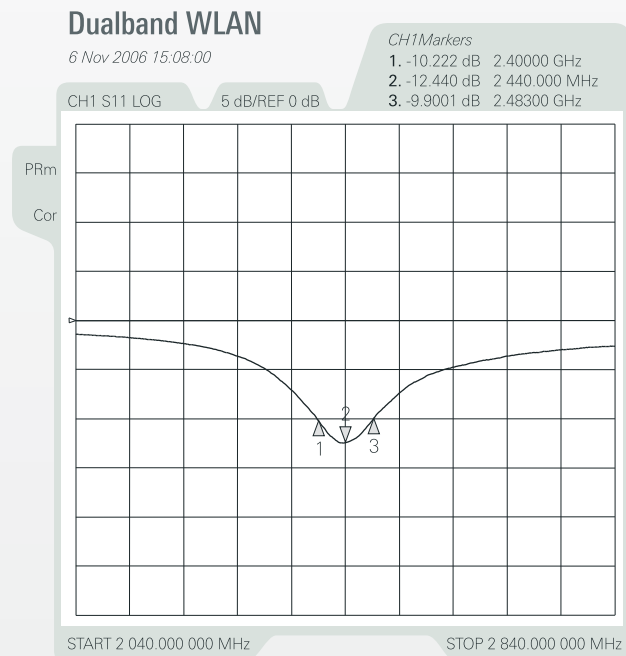

5GHz Typical Return Loss S11/ impedance, measured on the test board

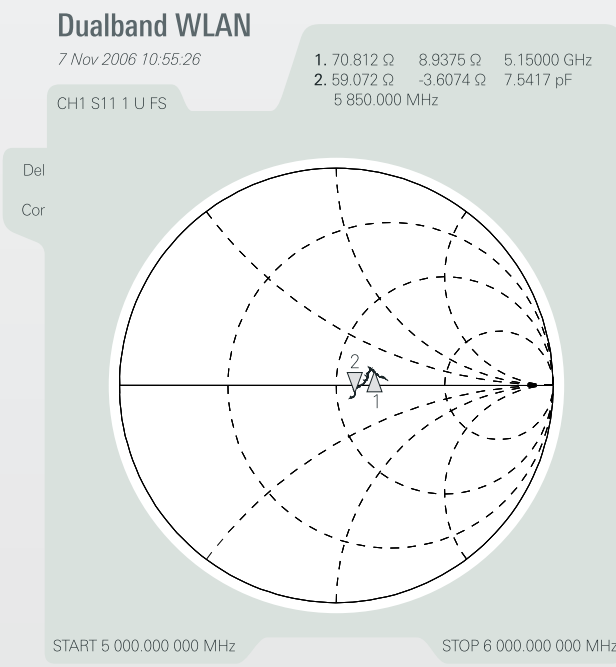
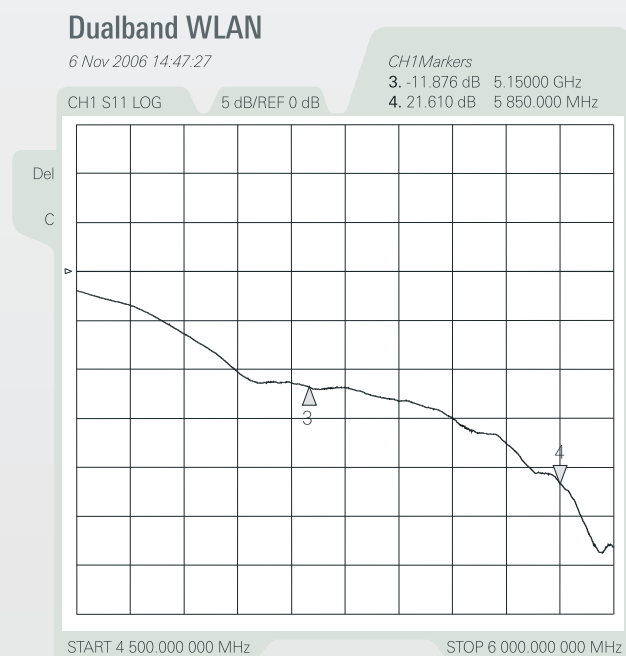

Pulse Finland Oy

Takatie 6
90440 Kempele, Finland
Tel: +358 207 935 500
Fax: +358 207 935 501
www.pulseeng.com/antennas



Dualband WLAN Ceramic Chip Antenna

Ground cleared under antenna 11.60 x 6.00 mm. Pulse Part Number: W3006

2,4 GHz free space efficiency and maximum gain

DualBand WiFi 2.4G 10 x 3.2 x 1.5 mm



DualBand WiFi 2.4G 10 x 3.2 x 1.5 mm

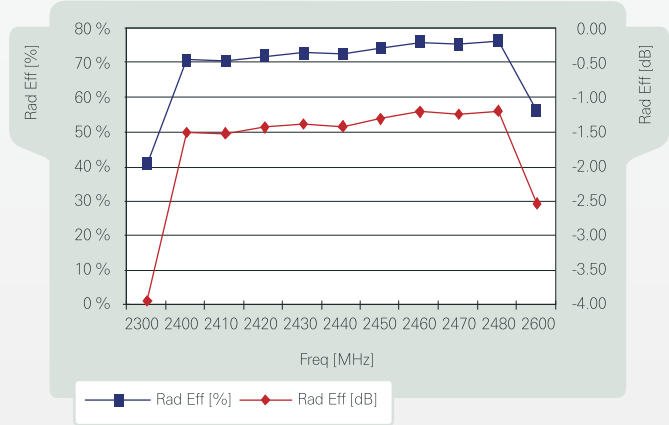

5 GHz free space efficiency and maximum gain

DualBand WiFi 5G 10 x 3.2 x 1.5 mm

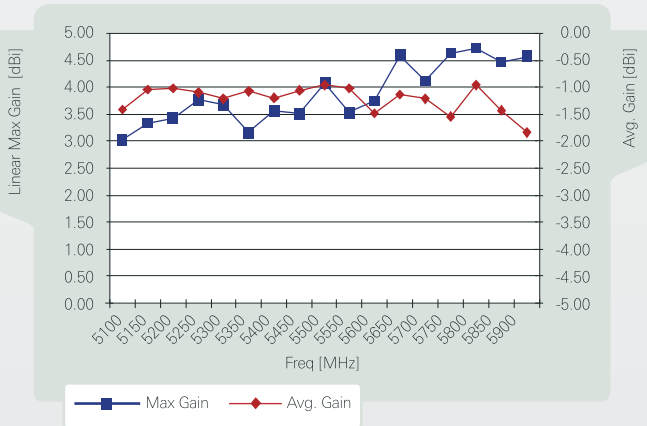

DualBand WiFi 5G 10 x 3.2 x 1.5 mm

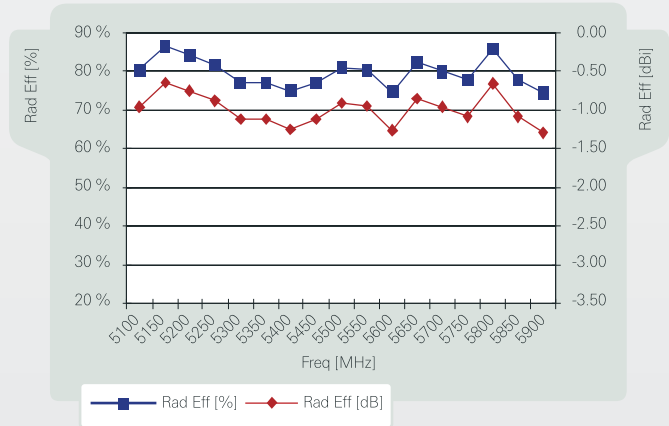

Pulse Finland Oy

Takatie 6
 90440 Kempele, Finland
 Tel: +358 207 935 500
 Fax: +358 207 935 501
www.pulseeng.com/antennas



Dualband WLAN Ceramic Chip Antenna

Ground cleared under antenna 11.60 x 6.00 mm. Pulse Part Number: W3006

2,4 GHz Typical Free space Radiation Patterns

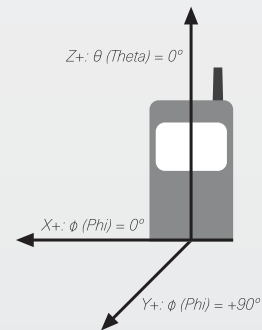
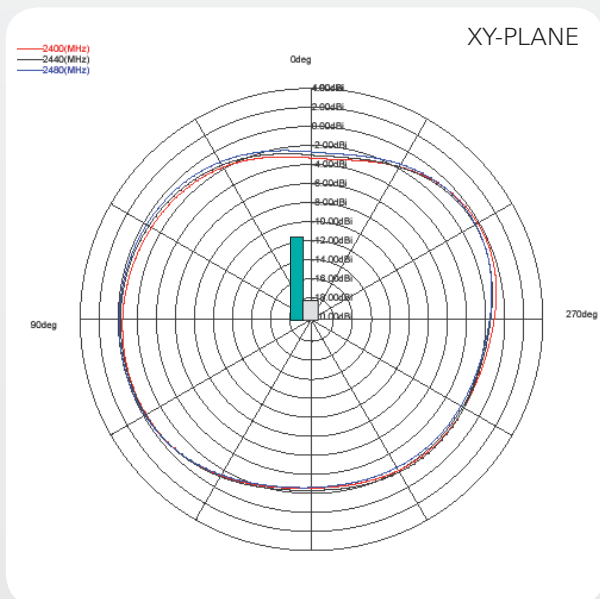
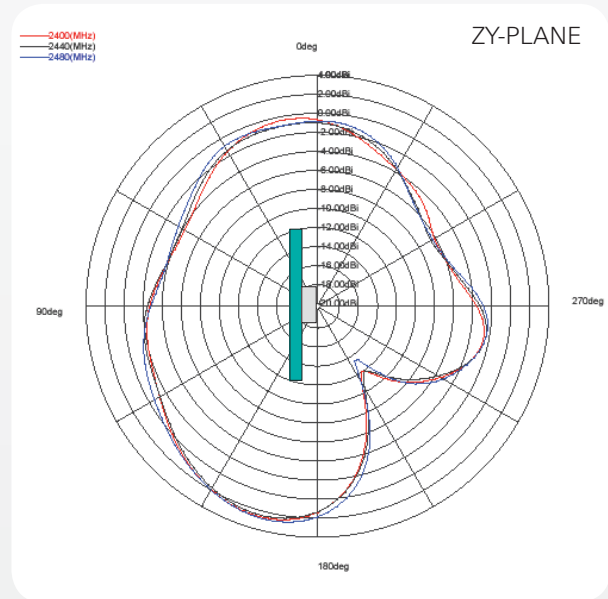
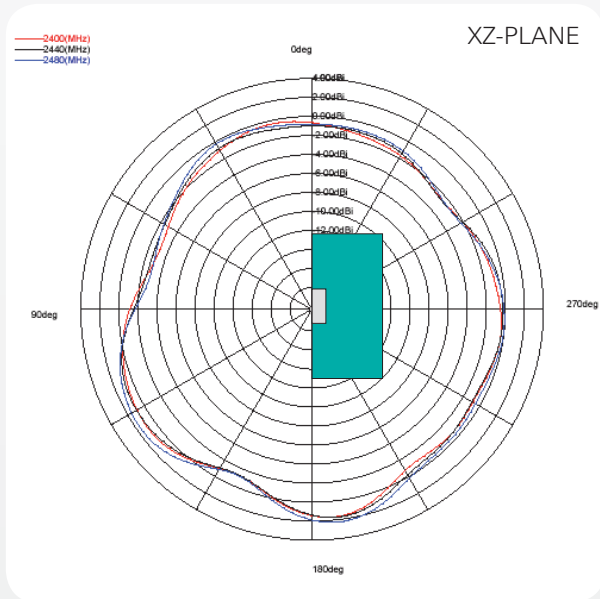

Pulse Finland Oy

Takatie 6
90440 Kempele, Finland
Tel: +358 207 935 500
Fax: +358 207 935 501

www.pulseeng.com/antennas



Dualband WLAN Ceramic Chip Antenna

Ground cleared under antenna 11.60 x 6.00 mm. Pulse Part Number: W3006

5 GHz Typical Free space Radiation Patterns

