

**FCC 47 CFR PART 15 SUBPART C**

**CERTIFICATION TEST REPORT**

*For*

TVB2 SUBWOOFER

Model No.: TVB2 SUBWOOFER

FCC ID: YKBTVB2-022

Trademark: CAMBRIDGE

REPORT NO.: ES150521226E2

ISSUE DATE: July 30, 2015

*Prepared for*

Audio Partnership PLC

Gallery Court, Hankey Place, London, SE1 4BB, United Kingdom.

*Prepared by*

SHENZHEN EMTEK CO., LTD.

Bldg 69, Majialong Industry Zone, Nanshan District, Shenzhen,

Guangdong, China

TEL: 86-755-26954280

FAX: 86-755-26954282

## Table of Contents

1	TEST RESULT CERTIFICATION .....	3
2	EUT TECHNICAL DESCRIPTION .....	4
3	SUMMARY OF TEST RESULT .....	6
4	TEST METHODOLOGY .....	7
4.1	GENERAL DESCRIPTION OF APPLIED STANDARDS .....	7
4.2	MEASUREMENT EQUIPMENT USED .....	7
4.3	DESCRIPTION OF TEST MODES .....	8
5	FACILITIES AND ACCREDITATIONS .....	9
5.1	FACILITIES .....	9
5.2	LABORATORY ACCREDITATIONS AND LISTINGS .....	9
6	TEST SYSTEM UNCERTAINTY .....	10
7	SETUP OF EQUIPMENT UNDER TEST .....	11
7.1	RADIO FREQUENCY TEST SETUP 1 .....	11
7.2	RADIO FREQUENCY TEST SETUP 2 .....	11
7.3	CONDUCTED EMISSION TEST SETUP .....	13
7.4	BLOCK DIAGRAM CONFIGURATION OF TEST SYSTEM .....	13
7.5	SUPPORT EQUIPMENT .....	13
8	FREQUENCY HOPPING SYSTEM REQUIREMENTS .....	14
8.1	STANDARD APPLICABLE .....	14
8.2	EUT PSEUDORANDOM FREQUENCY HOPPING SEQUENCE .....	14
8.3	EQUAL HOPPING FREQUENCY USE .....	15
8.4	FREQUENCY HOPPING SYSTEM .....	15
9	TEST REQUIREMENTS .....	16
9.1	20DB BANDWIDTH .....	16
9.2	CARRIER FREQUENCY SEPARATION .....	22
9.3	NUMBER OF HOPPING FREQUENCIES .....	28
9.4	AVERAGE TIME OF OCCUPANCY (DWELL TIME) .....	30
9.5	MAXIMUM PEAK CONDUCTED OUTPUT POWER .....	33
9.6	CONDUCTED SUPRIIOUS EMISSION .....	39
9.7	RADIATED SPURIOUS EMISSION .....	46
9.8	CONDUCTED EMISSION TEST .....	63
9.9	ANTENNA APPLICATION .....	68

**1 TEST RESULT CERTIFICATION**

Applicant:	Audio Partnership PLC Gallery Court, Hankey Place, London, SE1 4BB, United Kingdom.
Manufacturer:	SHENZHEN FENDA TECHNOLOGY CO., LTD. Fenda Hi-Tech Park, Zhoushi Road, Shiyan Town, Baoan District, Shenzhen City, Guangdong, China
Product Description:	TVB2 SUBWOOFER
Model Number:	TVB2 SUBWOOFER
File Number:	ES150521226E2
Date of Test:	May 22, 2015 to July 30, 2015

Measurement Procedure Used:

APPLICABLE STANDARDS	
STANDARD	TEST RESULT
FCC 47 CFR Part 2, Subpart J:2014 FCC 47 CFR Part 15, Subpart C:2014	PASS

The above equipment was tested by SHENZHEN EMTEK CO., LTD. The test data, data evaluation, test procedures, and equipment configurations shown in this report were made in accordance with the procedures given in ANSI C63.10 (2013) and the energy emitted by the sample EUT tested as described in this report is in compliance with the requirements of FCC Rules Part 2 and Part 15.247

The test results of this report relate only to the tested sample identified in this report

Date of Test : May 22, 2015 to July 30, 2015

Prepared by :   
Jack Li/Editor

Reviewer :   
Joe Xia/Supervisor

Approve & Authorized Signer :   
Lisa Wang/Manager

## 2 EUT TECHNICAL DESCRIPTION

Characteristics	Description
Device Type:	Fixed device
Data Rate	1Mbps for BT v2.0/v2.1/v3.0 BR GFSK modulation 2Mbps for BT v2.0/v2.1/v3.0 EDR pi/4-DQPSK modulation 3Mbps for BT v2.0/v2.1/v3.0 EDR 8DPSK modulation
Modulation:	GFSK modulation for BT v2.0/v2.1/v3.0 BR(1Mbps) pi/4-DQPSK modulation for BT v2.0/v2.1/v3.0 EDR(2Mbps) 8DPSK modulation for BT v2.0/v2.1/v3.0 EDR (3Mbps)
Operating Frequency Range(s):	2402-2480MHz for BT v2.0 BR /2.0+EDR; 2402-2480MHz for BT v2.1 BR /2.1+EDR; 2402-2480MHz for BT v3.0 BR /3.0+ EDR;
Number of Channels:	79 channels for BT v2.0/v2.1/v3.0 BR; 79 channels for BT v2.0/v2.1/v3.0 EDR;
Transmit Power Max:	3.735dBm for BT v2.0/v2.1/v3.0 EDR; 4.277dBm for BT v2.0/v2.1/v3.0 BR;
Antenna Type :	PCB Antenna
Antenna Gain:	1dBi
Power supply:	<input checked="" type="checkbox"/> AC supply: 100-240V AC~ 50/60Hz max power consumption 80W
	<input type="checkbox"/> Adapter supply:
Temperature Range	-10°C ~ +55°C
Product Software Version:	V3.0
Product Hardware Version:	TVB2-01-A0D-T3(150411)
Radio Software Version:	Bluetooth V3.0+HS
Radio Hardware Version:	RDA5876
RF power setting in TEST SW:	Maximum power

*Note: for more details, please refer to the User's manual of the EUT.*

**Modified Information**

Version.	Summary	Date of Rev.	Report No.
Ver.1.0	Original Report	2015-07-30	ES150521226E2

### 3 SUMMARY OF TEST RESULT

FCC Part Clause	Test Parameter	Verdict	Remark
15.247(a)(1)	20 dB Bandwidth	PASS	
15.247(a)(1)	Carrier Frequency Separation	PASS	
15.247(a)(1)	Number of Hopping Frequencies	PASS	
15.247(a)(1)	Average Time of Occupancy (Dwell Time)	PASS	
15.247(b)(1)	Maximum Peak Conducted Output Power	PASS	
15.247(c)	Conducted Spurious Emissions	PASS	
15.247(d) 15.209	Radiated Spurious Emissions	PASS	
15.207	Conducted Emission	PASS	
15.247(b)	Antenna Application	PASS	
NOTE1: N/A (Not Applicable)			

RELATED SUBMITTAL(S) / GRANT(S):

This submittal(s) (test report) is intended for FCC ID: YKBTVB2-022 filing to comply with Section 15.247 of the FCC Part 15, Subpart C Rules.

The FHSS system is compliance with Subpart B is authorized under a DOC procedure

## 4 TEST METHODOLOGY

### 4.1 GENERAL DESCRIPTION OF APPLIED STANDARDS

According to its specifications, the EUT must comply with the requirements of the following standards:  
 FCC 47 CFR Part 2, Subpart J  
 FCC 47 CFR Part 15, Subpart C  
 DA 00-705

### 4.2 MEASUREMENT EQUIPMENT USED

#### 4.2.1 Conducted Emission Test Equipment

EQUIPMENT TYPE	MFR	MODEL NUMBER	SERIAL NUMBER	LAST CAL.
Test Receiver	Rohde & Schwarz	ESCS30	828985/018	05/16/2015
L.I.S.N.	Schwarzbeck	NNLK8129	8129203	05/16/2015
50Ω Coaxial Switch	Anritsu	MP59B	M20531	N/A
Pulse Limiter	Rohde & Schwarz	ESH3-Z2	100006	05/16/2015
Voltage Probe	Rohde & Schwarz	TK9416	N/A	05/16/2015
I.S.N	Rohde & Schwarz	ENY22	1109.9508.02	05/16/2015

#### 4.2.2 Radiated Emission Test Equipment

EQUIPMENT TYPE	MFR	MODEL NUMBER	SERIAL NUMBER	LAST CAL.
EMI Test Receiver	Rohde & Schwarz	ESU	1302.6005.26	05/16/2015
Pre-Amplifier	HP	8447D	2944A07999	05/16/2015
Bilog Antenna	Schwarzbeck	VULB9163	142	05/16/2015
Loop Antenna	ARA	PLA-1030/B	1029	05/16/2015
Horn Antenna	Schwarzbeck	BBHA 9170	BBHA9170399	05/16/2015
Horn Antenna	Schwarzbeck	BBHA 9120	D143	05/16/2015
Cable	Schwarzbeck	AK9513	ACRX1	05/16/2015
Cable	Rosenberger	N/A	FP2RX2	05/16/2015
Cable	Schwarzbeck	AK9513	CRPX1	05/16/2015
Cable	Schwarzbeck	AK9513	CRRX2	05/16/2015

#### 4.2.3 Radio Frequency Test Equipment

EQUIPMENT TYPE	MFR	MODEL NUMBER	SERIAL NUMBER	LAST CAL.
Spectrum Analyzer	Agilent	E4407B	88156318	05/16/2015
Power meter	Anritsu	ML2495A	0824006	05/16/2015
Power sensor	Anritsu	MA2411B	0738172	05/16/2015
Signal Analyzer	Agilent	N9010A	My53470879	05/16/2015
EMI Test Receiver	Rohde & Schwarz	FSV30	103040	05/16/2015

*Remark: Each piece of equipment is scheduled for calibration once a year.*

### 4.3 DESCRIPTION OF TEST MODES

The EUT has been tested under its typical operating condition.

The EUT configuration for testing is installed on RF field strength measurement to meet the Commissions requirement and operating in a manner which intends to maximize its emission characteristics in a continuous normal application.

The Transmitter was operated in the normal operating mode. The TX frequency was fixed which was for the purpose of the measurements.

Test of channel included the lowest and middle and highest frequency to perform the test, then record on this report.

Those data rates (1Mbps for Bluetooth v2.0 /v2.1/v3.0 BR GFSK modulation; 2Mbps for Bluetooth v2.0/v2.1 /v3.0 EDR pi/4-DQPSK modulation; 3Mbps for Bluetooth v2.0/v2.1 /v3.0 EDR 8DPSK modulation ) were used for all test.

Pre-defined engineering program for regulatory testing used to control the EUT for staying in continuous transmitting and receiving mode is programmed.

The EUT was pretested with 3 orientations placed on the table for the radiated emission measurement –X, Y, and Z-plane. The Y-plane results were found as the worst case and were shown in this report.

Frequency and Channel list for Bluetooth v2.0 /v2.1/v3.0:

Channel	Frequency (MHz)	Channel	Frequency (MHz)	Channel	Frequency (MHz)
0	2402	39	2441	...	...
1	2403	40	2442	76	2478
2	2404	41	2443	77	2479
...	...	...	...	78	2480

Note:  $f_c = 2402\text{MHz} + k \times 1\text{MHz}$   $k=0$  to 78

Test Frequency and channel for Bluetooth v2.0 /v2.1/v3.0:

Lowest Frequency		Middle Frequency		Highest Frequency	
Channel	Frequency (MHz)	Channel	Frequency (MHz)	Channel	Frequency (MHz)
0	2402	39	2441	78	2480



## 5 FACILITIES AND ACCREDITATIONS

### 5.1 FACILITIES

All measurement facilities used to collect the measurement data are located at

Bldg 69, Majialong Industry Zone District, Nanshan District, Shenzhen, China

The sites are constructed in conformance with the requirements of ANSI C63.7, ANSI C63.10 and CISPR Publication 22.

### 5.2 LABORATORY ACCREDITATIONS AND LISTINGS

Site Description

- EMC Lab.
- : Accredited by CNAS, 2013.10.29  
The certificate is valid until 2016.10.28  
The Laboratory has been assessed and proved to be in compliance with CNAS-CL01: 2006(identical to ISO/IEC17025: 2005)  
The Certificate Registration Number is L2291
  - : Accredited by TUV Rheinland Shenzhen, 2010.5.25  
The Laboratory has been assessed according to the requirements ISO/IEC 17025.
  - : Accredited by FCC, October 28, 2010  
The Certificate Registration Number is 406365.
  - : Accredited by FCC, February 28, 2013  
The Certificate Registration Number is 709623.
  - : Accredited by Industry Canada, May 24, 2008  
The Certificate Registration Number is 4480A-2

## 6 TEST SYSTEM UNCERTAINTY

The following measurement uncertainty levels have been estimated for tests performed on the apparatus:

Parameter	Uncertainty
Radio Frequency	$\pm 1 \times 10^{-5}$
Maximum Peak Output Power Test	$\pm 1.0\text{dB}$
Conducted Emissions Test	$\pm 2.0\text{dB}$
Radiated Emission Test	$\pm 2.0\text{dB}$
Occupied Bandwidth Test	$\pm 1.0\text{dB}$
Band Edge Test	$\pm 3\text{dB}$
All emission, radiated	$\pm 3\text{dB}$
Antenna Port Emission	$\pm 3\text{dB}$
Temperature	$\pm 0.5^\circ\text{C}$
Humidity	$\pm 3\%$

Measurement Uncertainty for a level of Confidence of 95%

## 7 SETUP OF EQUIPMENT UNDER TEST

### 7.1 RADIO FREQUENCY TEST SETUP 1

The Bluetooth v2.0 /v2.1/v3.0 component's antenna ports(s) of the EUT are connected to the measurement instrument per an appropriate attenuator. The EUT is controlled by PC/software to emit the specified signals for the purpose of measurements.

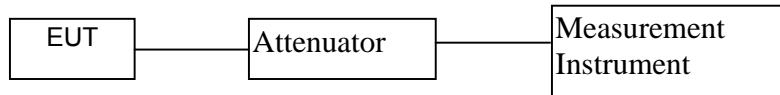

### 7.2 RADIO FREQUENCY TEST SETUP 2

The test site semi-anechoic chamber has met the requirement of NSA tolerance 4 dB according to the standards: ANSI C63.10-2013. The test distance is 3m. The setup is according to the requirements in Section 13.1.4.1 of ANSI C63.10-2013 and CAN/CSA-CEI/IEC CISPR 22.

The maximal emission value is acquired by adjusting the antenna height, polarisation and turntable azimuth. Normally, the height range of antenna is 1 m to 4 m, the azimuth range of turntable is 0° to 360°, and the receive antenna has two polarizations Vertical (V) and Horizontal (H).

Below 1000MHz:

The EUT is placed on a turntable 0.8 meters above the ground in the chamber, 3 meter away from the antenna (loop antenna). The Antenna should be positioned with its plane vertical at the specified distance from the EUT and rotated about its vertical axis for maximum response at each azimuth about the EUT. The center of the loop shall be 1 m above the ground. For certain applications, the loop antenna plane may also need to be positioned horizontally at the specified distance from the EUT.

Above 1000MHz:

The EUT is placed on a turntable 1.5 meters above the ground in the chamber, 3 meter away from the antenna. The maximal emission value is acquired by adjusting the antenna height, polarisation and turntable azimuth. Normally, the height range of antenna is 1 m to 4 m, the azimuth range of turntable is 0° to 360°, and the receive antenna has two polarizations Vertical (V) and Horizontal (H).

(a) Radiated Emission Test Set-Up, Frequency Below 30MHz

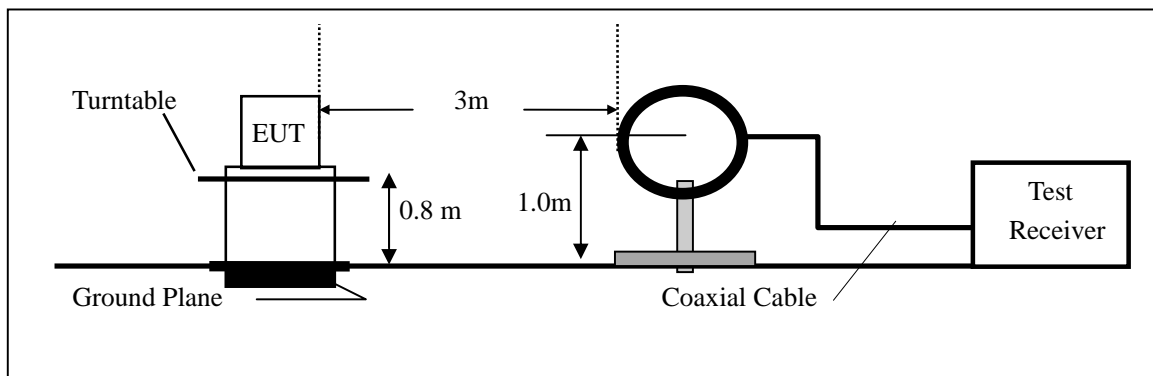

(b) Radiated Emission Test Set-Up, Frequency Below 1000MHz

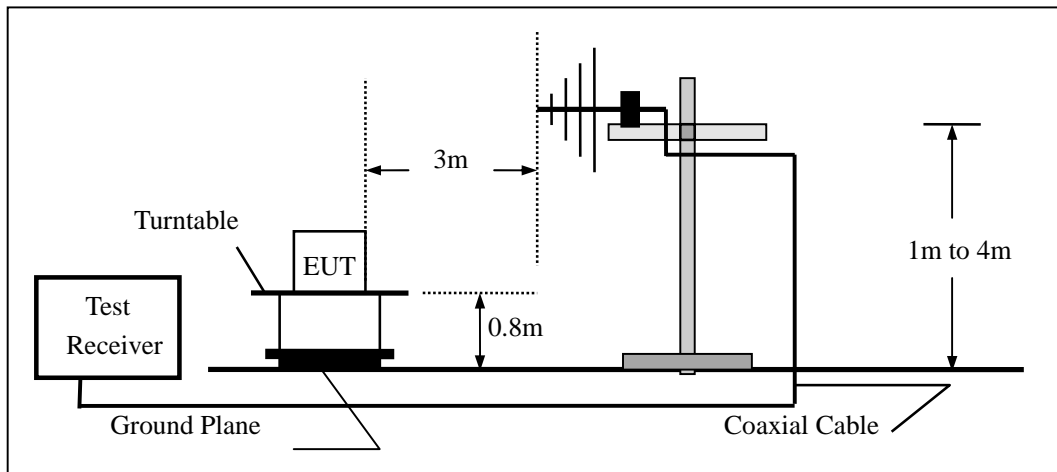

(c) Radiated Emission Test Set-Up, Frequency above 1000MHz

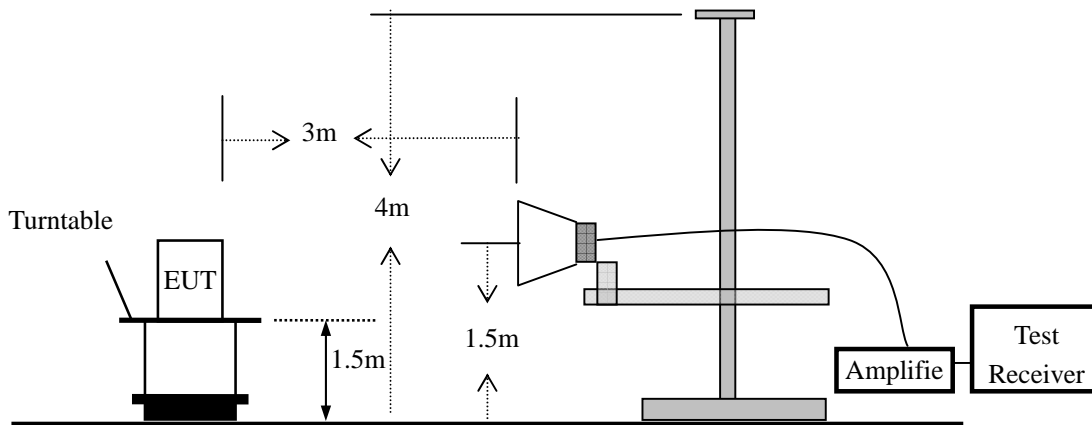

**7.3 CONDUCTED EMISSION TEST SETUP**

The mains cable of the EUT(TVB2 SUBWOOFER) must be connected to LISN. The LISN shall be placed 0.8 m from the boundary of EUT and bonded to a ground reference plane for LISN mounted on top of the ground reference plane. This distance is between the closest points of the LISN and the EUT. All other units of the EUT and associated equipment shall be at least 0.8m from the LISN.

Ground connections, where required for safety purposes, shall be connected to the reference ground point of the LISN and, where not otherwise provided or specified by the manufacturer, shall be of same length as the mains cable and run parallel to the mains connection at a separation distance of not more than 0.1 m.

According to the requirements in Section 13.1.4.1 of ANSI C63.10-2013 Conducted emissions from the EUT measured in the frequency range between 0.15 MHz and 30 MHz using CISPR Quasi-Peak and average detector mode.

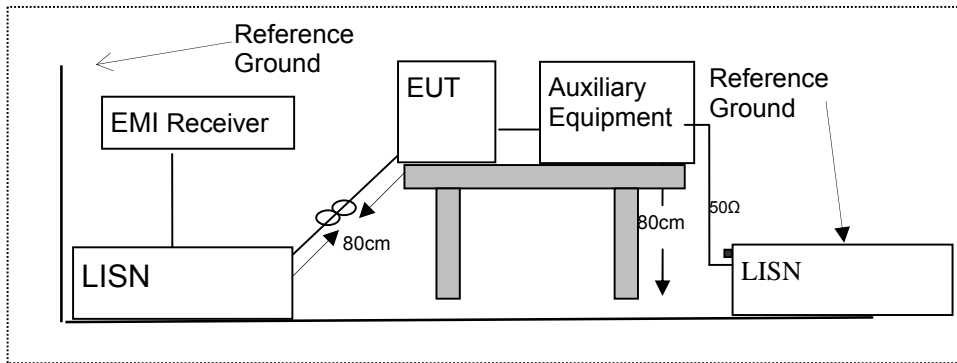

**7.4 BLOCK DIAGRAM CONFIGURATION OF TEST SYSTEM**

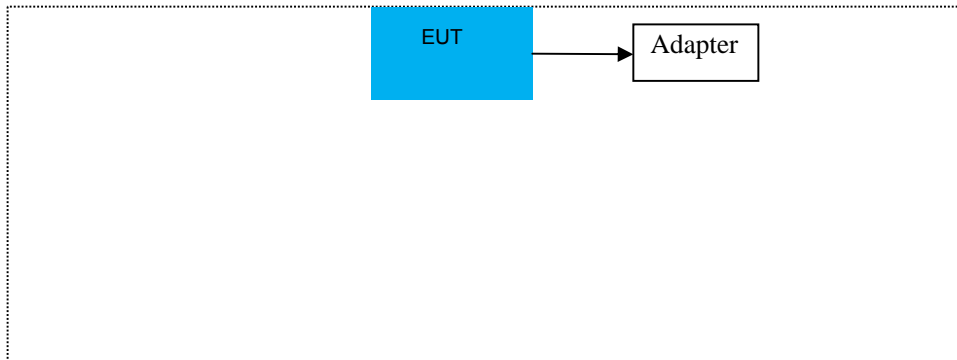

**7.5 SUPPORT EQUIPMENT**

Item	Equipment	Mfr/Brand	Model/Type No.	FCC ID	Note
1.	TVB2 SUBWOOFER	CAMBRIDGE	TVB2 SUBWOOFER	YKBTVB2-022	EUT

**Notes:**

1. All the equipment/cables were placed in the worst-case configuration to maximize the emission during the test.
2. Grounding was established in accordance with the manufacturer's requirements and conditions for the intended use.

## 8 FREQUENCY HOPPING SYSTEM REQUIREMENTS

### 8.1 Standard Applicable

According to FCC Part 15.247(a)(1), The system shall hop to channel frequencies that are selected at the system hopping rate from a pseudo randomly ordered list of hopping frequencies. Each frequency must be used equally on the average by each transmitter. The system receivers shall have input bandwidths that match the hopping channel bandwidths of their corresponding transmitters and shall shift frequencies in synchronization with the transmitted signals.

(g) Frequency hopping spread spectrum systems are not required to employ all available hopping channels during each transmission. However, the system, consisting of both the transmitter and the receiver, must be designed to comply with all of the regulations in this section should the transmitter be presented with a continuous data (or information) stream. In addition, a system employing short transmission bursts must comply with the definition of a frequency hopping system and must distribute its transmissions over the minimum number of hopping channels specified in this section.

(h) The incorporation of intelligence within a frequency hopping spread spectrum system that permits the system to recognize other users within the spectrum band so that it individually and independently chooses and adapts its hopsets to avoid hopping on occupied channels is permitted. The coordination of frequency hopping systems in any other manner for the express purpose of avoiding the simultaneous occupancy of individual hopping frequencies by multiple transmitters is not permitted.

### 8.2 EUT Pseudorandom Frequency Hopping Sequence

The pseudorandom sequence may be generated in a nine-stage shift register whose 5th and 9th stage outputs are added in a modulo-two addition stage, and the result is fed back to the input of the first stage. The sequence begins with the first ONE of 9 consecutive ONES; i.e. the shift register is initialized with nine ones. Number of shift register stages: 9  
Length of pseudo-random sequence:  $2^9 - 1 = 511$  bits  
Longest sequence of zeros: 8 (non-inverted signal)

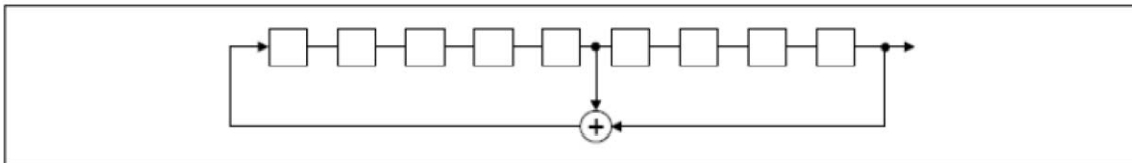

*Linear Feedback Shift Register for Generation of the PRBS sequence*

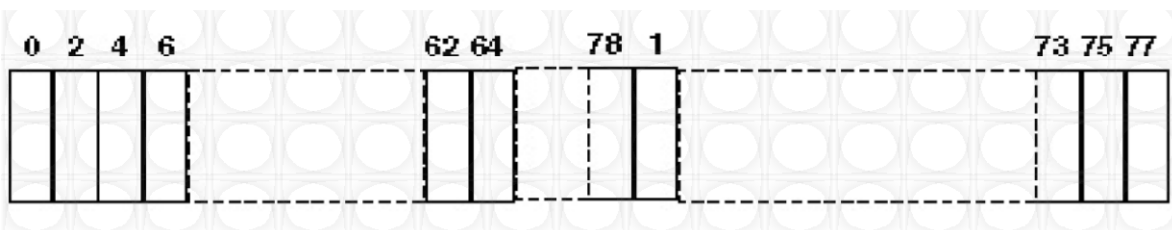

Each frequency used equally on the average by each transmitter. The system receiver have input bandwidths that match the hopping channel bandwidths of their corresponding transmitters and shift frequencies in synchronization with the transmitted signals.

### 8.3 Equal Hopping Frequency Use

All Bluetooth units participating in the piconet are time and hop-synchronized to the channel.

Example of a 79 hopping sequence in data mode:

40, 14, 44, 8, 27, 53, 46, 55, 48, 33, 63, 35, 50, 65, 54, 67, 56, 37, 60, 39, 58, 69, 62, 71, 64, 25, 68, 26, 66, 57, 70, 59, 72, 29, 76, 31, 74, 61, 78, 3, 1, 41, 5, 43, 2, 73, 7, 75, 09, 45, 13, 47, 11, 77, 15, 00, 4, 49, 56, 23, 18, 02, 7, 6, 10, 21, 32, 5, 12, 48, 34, 20, 28, 52, 38, 17, 22, 30, 42, 16, 51, 36, 21, 19, 24

Each Frequency used equally on the average by each transmitter

### 8.4 Frequency Hopping System

This transmitter device is frequency hopping device, and complies with FCC part 15.247 rule.

This device uses Bluetooth radio which operates in 2400-2483.5 MHz band. Bluetooth uses a radio technology called frequency-hopping spread spectrum, which chops up the data being sent and transmits chunks of it on up to 79 bands (1 MHz each; centred from 2402 to 2480 MHz) in the range 2,400-2,483.5 MHz. The transmitter switches hop frequencies 1,600 times per second to assure a high degree of data security. All Bluetooth devices participating in a given piconet are synchronized to the frequency-hopping channel for the piconet. The frequency hopping sequence is determined by the master's device address and the phase of the hopping sequence (the frequency to hop at a specific time) is determined by the master's internal clock. Therefore, all slaves in a piconet must know the master's device address and must synchronize their clocks with the master's clock.

Adaptive Frequency Hopping (AFH) was introduced in the Bluetooth specification to provide an effective way for a Bluetooth radio to counteract normal interference. AFH identifies "bad" channels, where either other wireless devices are interfering with the Bluetooth signal or the Bluetooth signal is interfering with another device. The AFH-enabled Bluetooth device will then communicate with other devices within its piconet to share details of any identified bad channels. The devices will then switch to alternative available "good" channels, away from the areas of interference, thus having no impact on the bandwidth used.

## 9 TEST REQUIREMENTS

### 9.1 20DB BANDWIDTH

#### 9.1.1 Applicable Standard

According to FCC Part 15.247(a)(1) and DA 00-705

#### 9.1.2 Conformance Limit

No limit requirement.

#### 9.1.3 Test Configuration

Test according to clause 7.1 radio frequency test setup 1

#### 9.1.4 Test Procedure

The EUT was operating in Bluetooth v2.0 /v2.1/v3.0 mode and controlled its channel. Printed out the test result from the spectrum by hard copy function.

The RF output of EUT was connected to the spectrum analyzer by RF cable and attenuator. The path loss was compensated to the results for each measurement.

Set to the maximum power setting and enable the EUT transmit continuously

Set RBW = 30 kHz.

Set the video bandwidth (VBW) =100 kHz.

Set Span= approximately 2 to 3 times the 20 dB bandwidth

Set Detector = Peak.

Set Trace mode = max hold.

Set Sweep = auto couple.

The EUT should be transmitting at its maximum data rate. Allow the trace to stabilize. Use the marker-to-peak function to set the marker to the peak of the emission. Use the marker-delta function to measure 20 dB down one side of the emission. Reset the markerdelta function, and move the marker to the other side of the emission, until it is (as close as possible to) even with the reference marker level. The marker-delta reading at this point is the 20 dB bandwidth of the emission.

If this value varies with different modes of operation (e.g., data rate, modulation format, etc.), repeat this test for each variation.

Measure and record the results in the test report.

### Test Results

Temperature: 24°C  
Humidity: 53 %

Test Date: June 11, 2015  
Test By: KING KONG

Modulation Mode	Channel Number	Channel Frequency (MHz)	Measurement Bandwidth (kHz)	Limit (kHz)	Verdict
GFSK	00	2402	899.4	N/A	PASS
	39	2441	900.8	N/A	PASS
	78	2480	895.9	N/A	PASS
pi/4-DQPSK	00	2402	1127.00	N/A	PASS
	39	2441	1129.00	N/A	PASS
	78	2480	1130.00	N/A	PASS
8DPSK	00	2402	1156.00	N/A	PASS
	39	2441	1157.00	N/A	PASS
	78	2480	1158.00	N/A	PASS

Note: N/A (Not Applicable)



Test Model	20dB Bandwidth	
	Bluetooth v2.0 /v2.1/v3.0	
	Channel 0: 2402MHz	GFSK Modulation

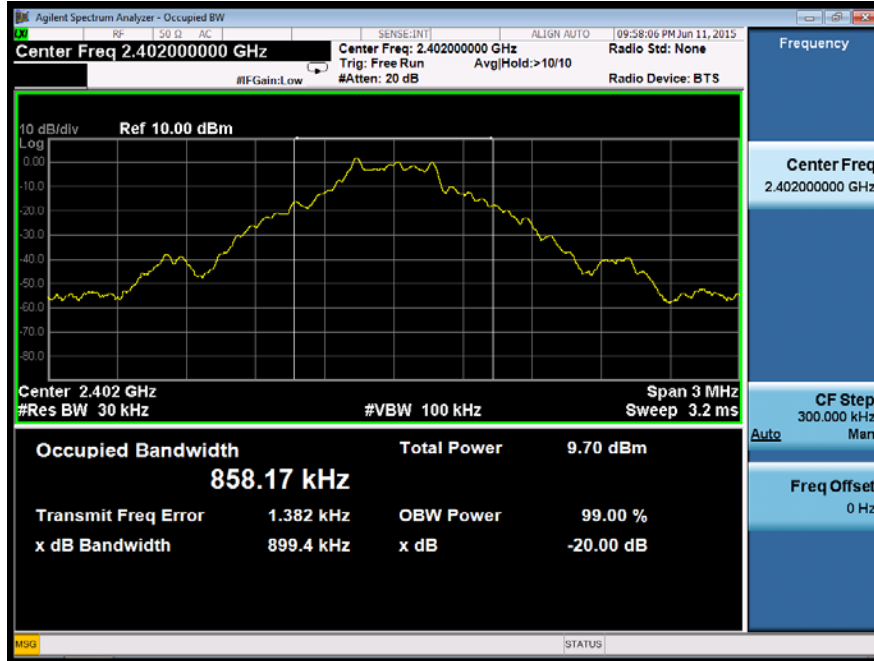

Test Model	20dB Bandwidth	
	Bluetooth v2.0 /v2.1/v3.0	
	Channel 39: 2441MHz	GFSK Modulation

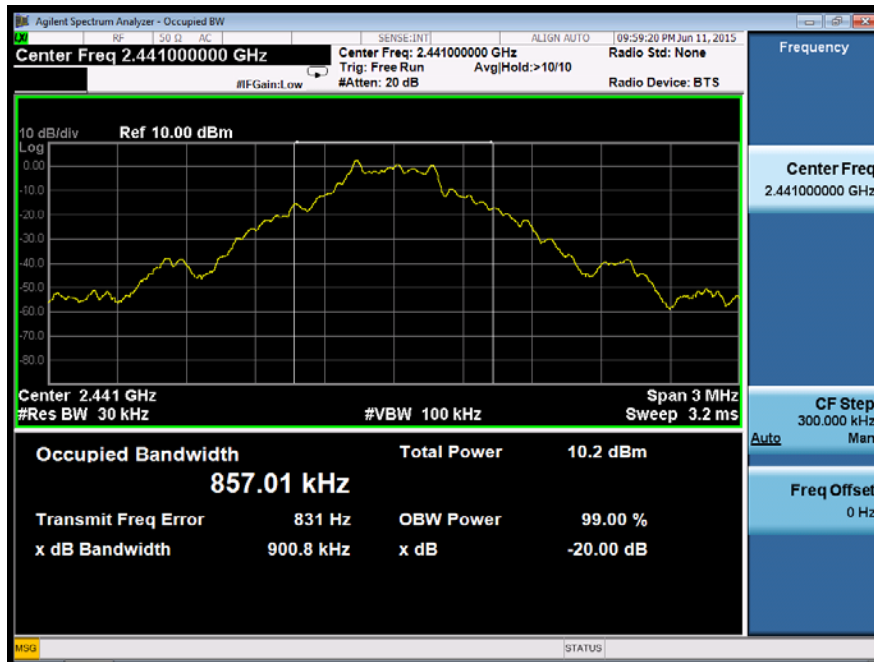

Test Model	20dB Bandwidth	
	Bluetooth v2.0 /v2.1/v3.0	
	Channel 78: 2480MHz	GFSK Modulation

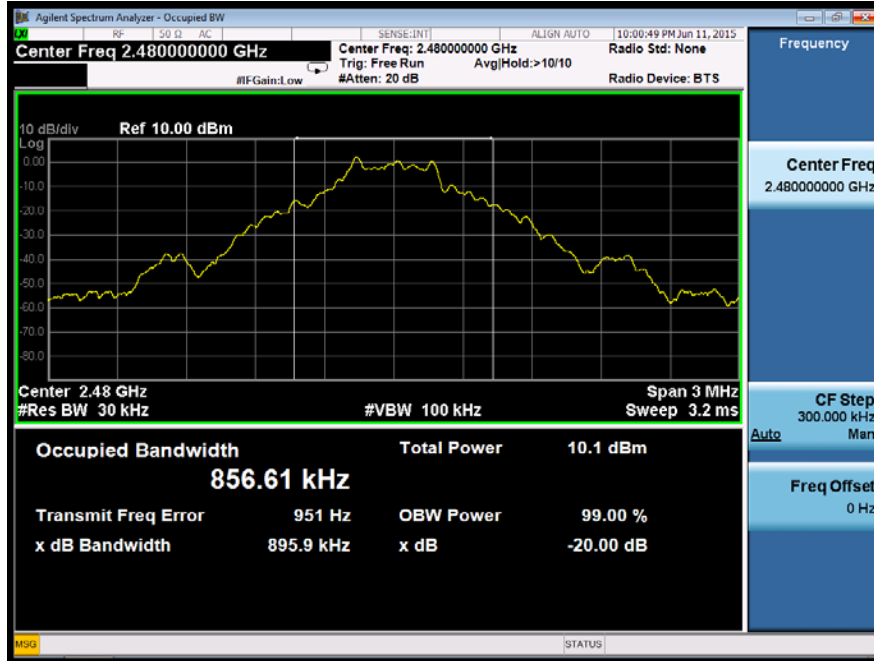

Test Model	20dB Bandwidth	
	Bluetooth v2.0 /v2.1/v3.0	
	Channel 0: 2402MHz	pi/4-DQPSK Modulation

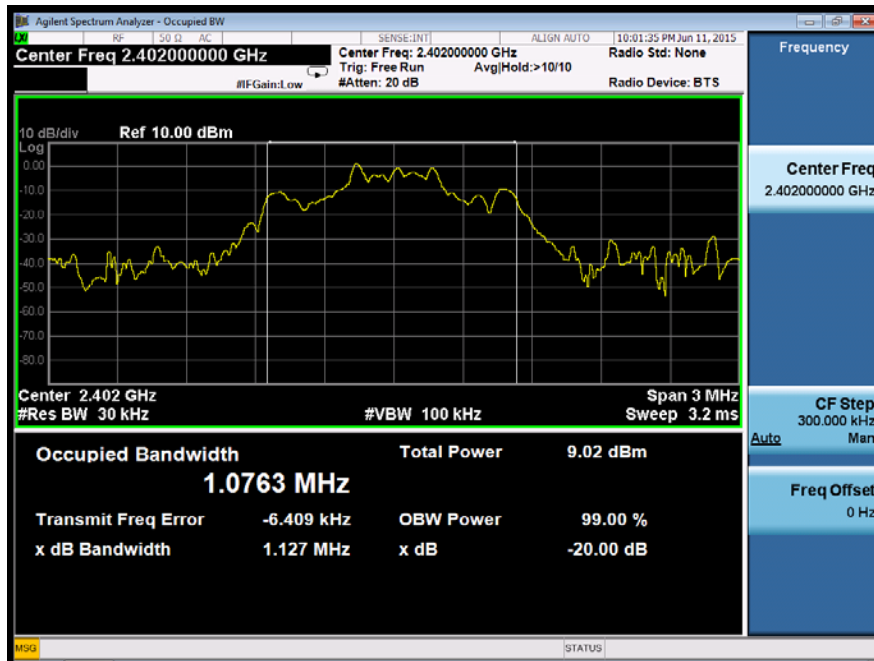

Test Model	20dB Bandwidth	
	Bluetooth v2.0 /v2.1/v3.0	
	Channel 39: 2441MHz	pi/4-DQPSK Modulation

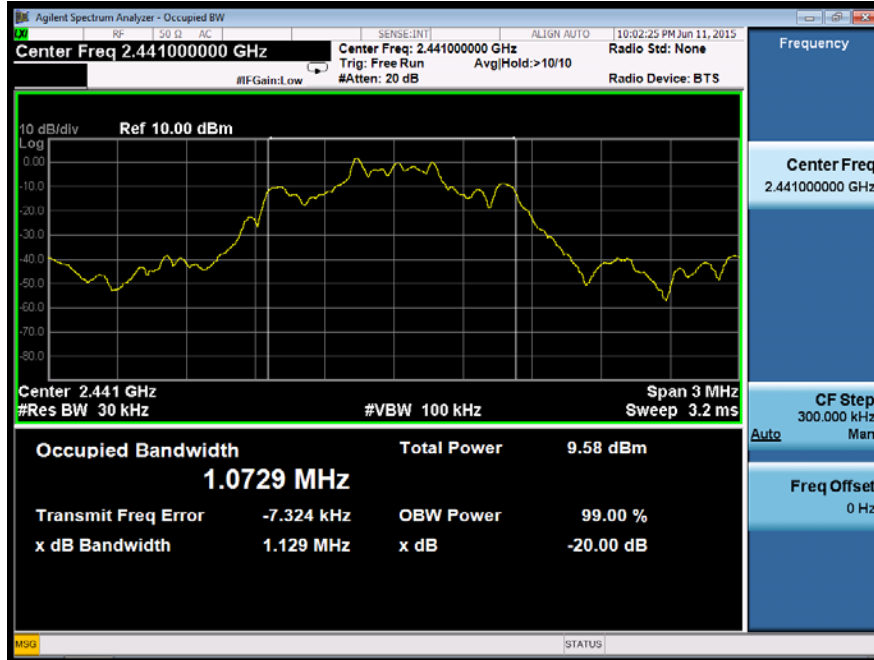

Test Model	20dB Bandwidth	
	Bluetooth v2.0 /v2.1/v3.0	
	Channel 78: 2480MHz	pi/4-DQPSK Modulation

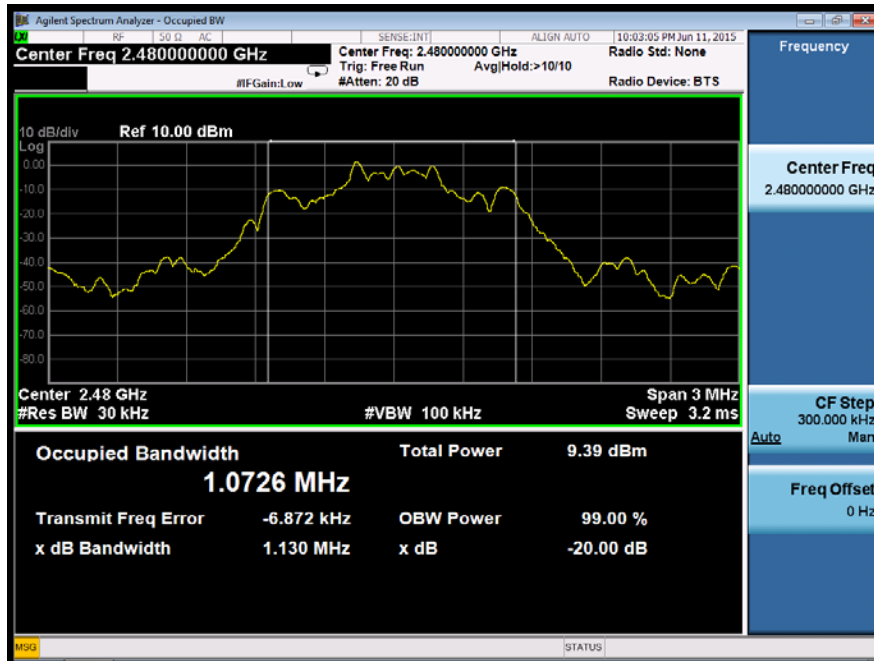

Test Model	20dB Bandwidth	
	Bluetooth v2.0 /v2.1/v3.0	
	Channel 0: 2402MHz	8DPSK Modulation

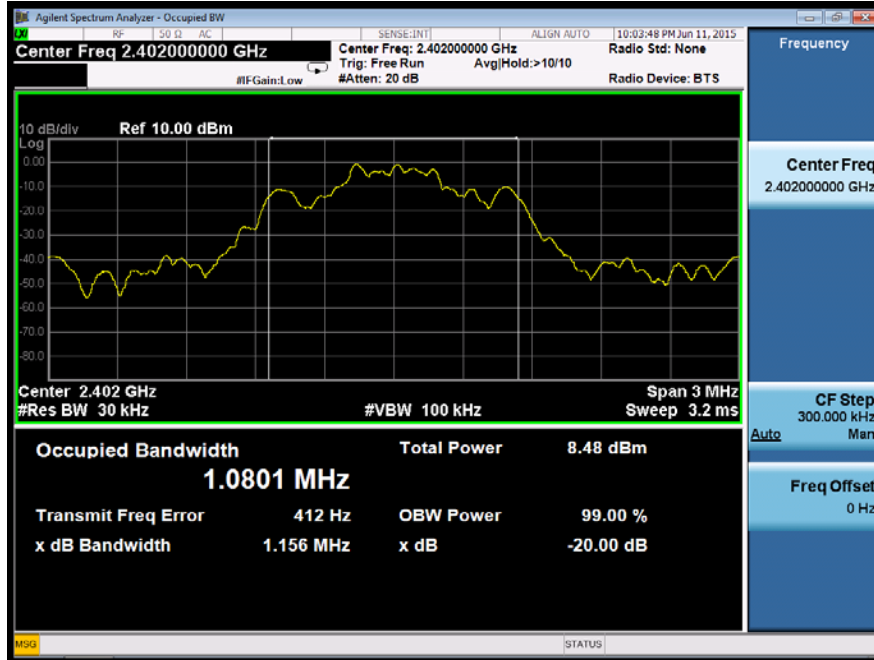

Test Model	20dB Bandwidth	
	Bluetooth v2.0 /v2.1/v3.0	
	Channel 39: 2441MHz	8DPSK Modulation

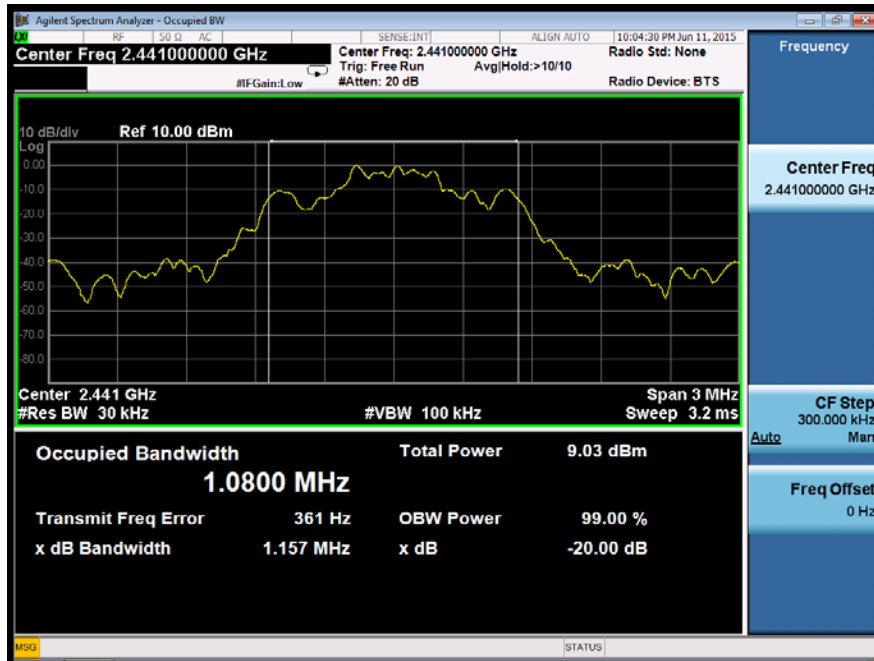

Test Model	20dB Bandwidth	
	Bluetooth v2.0 /v2.1/v3.0	
	Channel 78: 2480MHz	8DPSK Modulation



## 9.2 CARRIER FREQUENCY SEPARATION

### 9.2.1 Applicable Standard

According to FCC Part 15.247(a)(1) and DA 00-705

### 9.2.2 Conformance Limit

Frequency hopping systems operating in the 2400-2483.5MHz band shall have hopping channel carrier frequencies separated by a minimum of 25kHz or the 20dB bandwidth of the hopping channel, whichever is greater.

In case of an output power less than 125mW, the frequency hopping system may have channels separated by a minimum of 25kHz or two-thirds of the 20dB bandwidth of the hopping channel, whichever is greater.

### 9.2.3 Test Configuration

Test according to clause 7.1 radio frequency test setup 1

### 9.2.4 Test Procedure

■ According to FCC Part 15.247(a)(1)

The EUT must have its hopping function enabled. Use the following spectrum analyzer settings:

Set the RBW = 100kHz.

Set VBW = 300kHz.

Set the span = wide enough to capture the peaks of two adjacent channels

Set Sweep time = auto couple.

Set Detector = peak.

Set Trace mode = max hold.

Allow the trace to stabilize. Use the marker-delta function to determine the separation between the peaks of the adjacent channels. The limit is specified in one of the subparagraphs of this Section. Submit this plot.

### Test Results

Temperature: 24 °C  
Humidity: 53 %

Test Date: June 11, 2015  
Test By: KING KONG

Modulation Mode	Channel Number	Channel Frequency (MHz)	Measurement Bandwidth (kHz)	Limit (kHz)	Verdict
GFSK	0	2402	1000.00	>899.400	PASS
	39	2441	1000.00	>900.800	PASS
	78	2480	1000.00	>895.900	PASS
pi/4-DQPSK	0	2402	1000.00	>751.333	PASS
	39	2441	1000.00	>752.667	PASS
	78	2480	1000.00	>753.333	PASS
8DPSK	0	2402	1000.00	>770.667	PASS
	39	2441	1000.00	>771.333	PASS
	78	2480	1000.00	>772.000	PASS

Note: Limit = 20dB bandwidth for GFSK, Limit = 20dB bandwidth\*2/3 for pi/4-DQPSK & 8DPSK Modulation, if it is greater than 25kHz and the output power is less than 125mW (21dBm).

Test Model	Carrier Frequency Separation	
	Bluetooth v2.0 /v2.1/v3.0	
	Channel 0: 2402MHz	GFSK Modulation

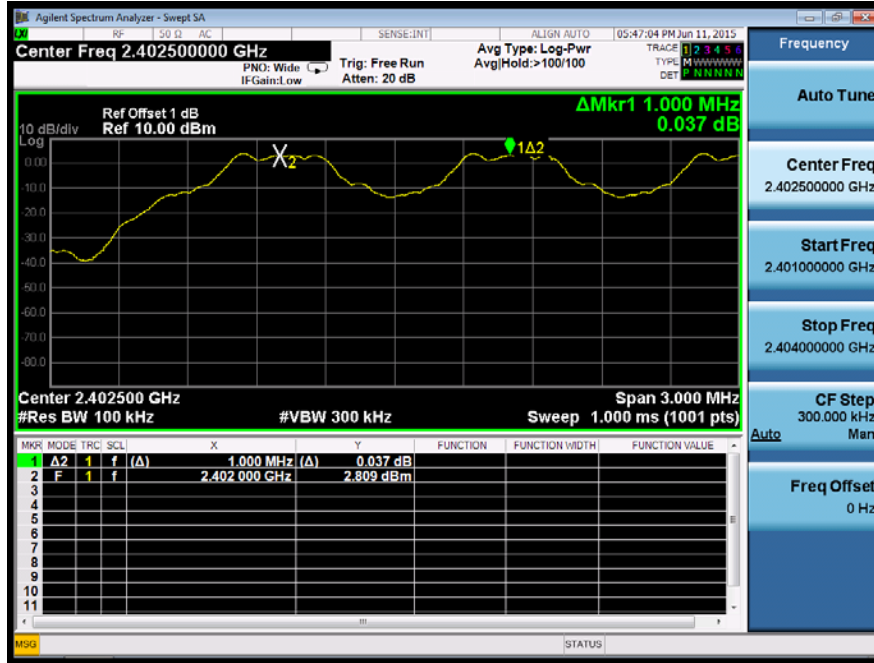

Test Model	Carrier Frequency Separation	
	Bluetooth v2.0 /v2.1/v3.0	
	Channel 39: 2441MHz	GFSK Modulation

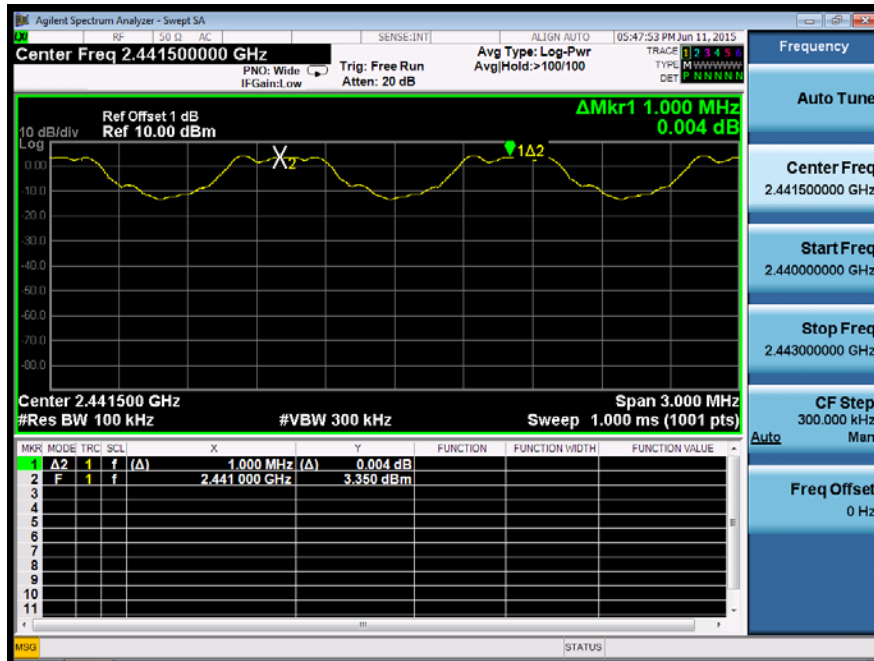



Test Model	Carrier Frequency Separation	
	Bluetooth v2.0 /v2.1/v3.0	
	Channel 78: 2480MHz	GFSK Modulation

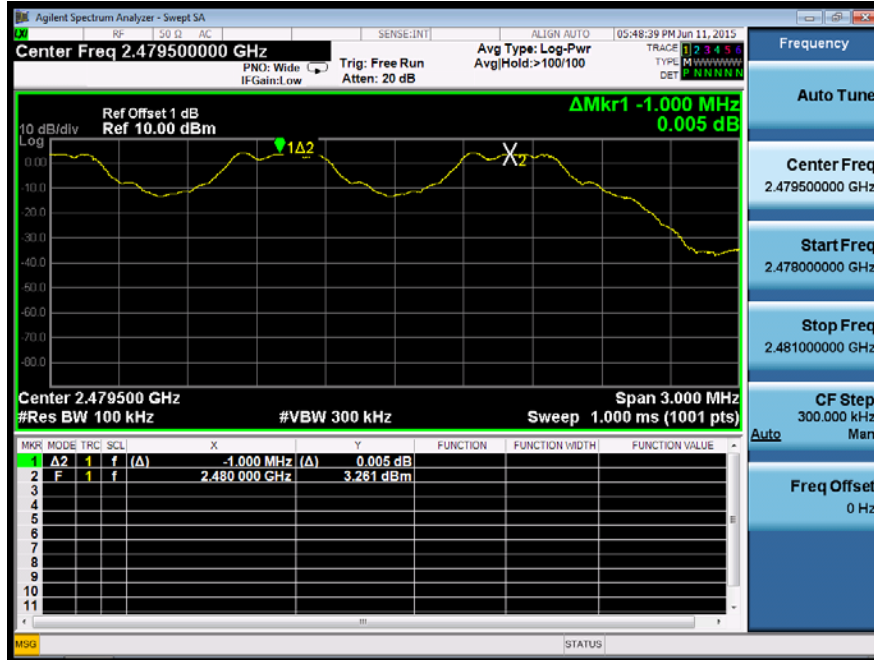

Test Model	Carrier Frequency Separation	
	Bluetooth v2.0 /v2.1/v3.0	
	Channel 0: 2402MHz	pi/4-DQPSK Modulation

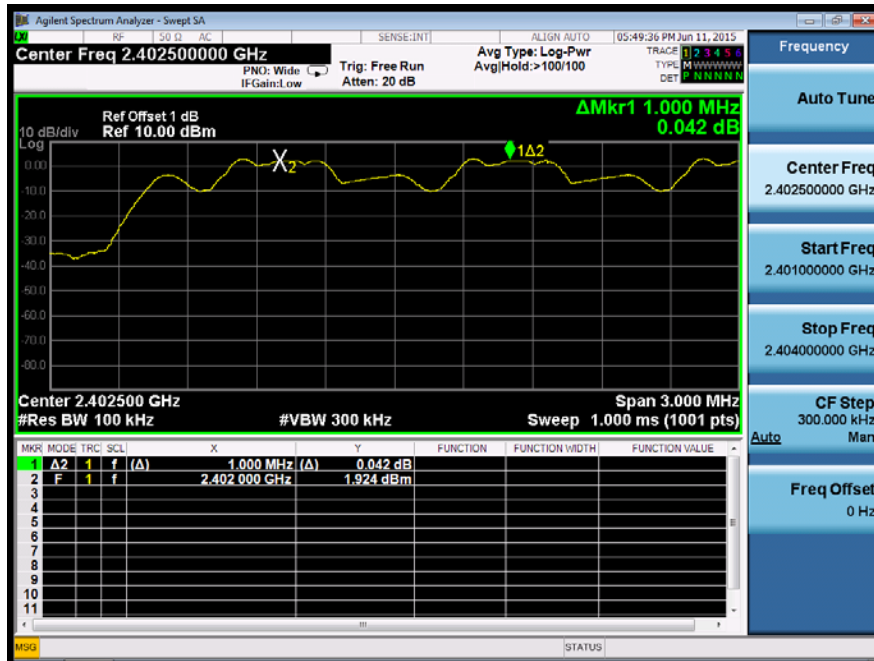



Test Model	Carrier Frequency Separation	
	Bluetooth v2.0 /v2.1/v3.0	
	Channel 39: 2441MHz	pi/4-DQPSK Modulation

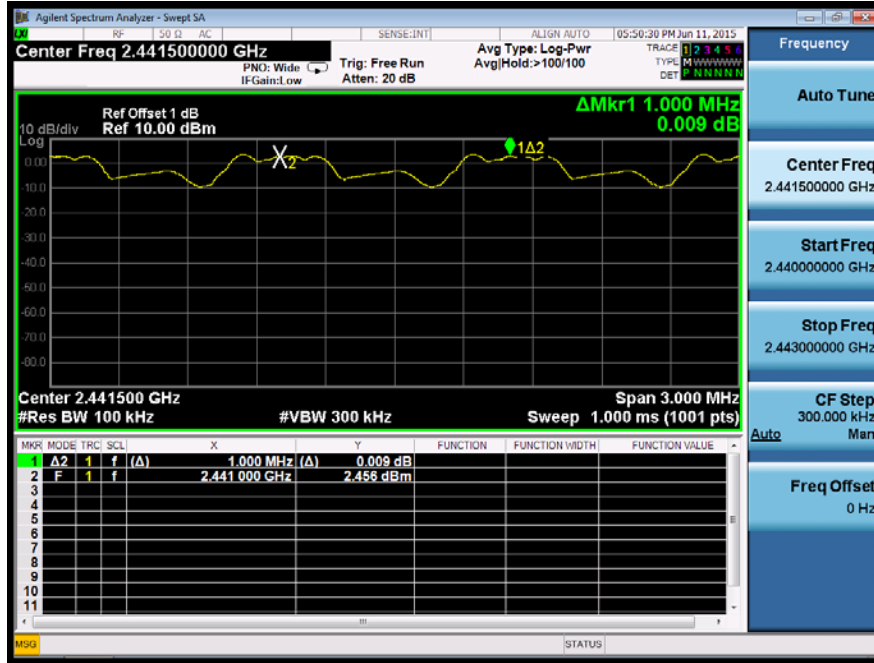

Test Model	Carrier Frequency Separation	
	Bluetooth v2.0 /v2.1/v3.0	
	Channel 78: 2480MHz	pi/4-DQPSK Modulation



Test Model	Carrier Frequency Separation	
	Bluetooth v2.0 /v2.1/v3.0	
	Channel 0: 2402MHz	8DPSK Modulation

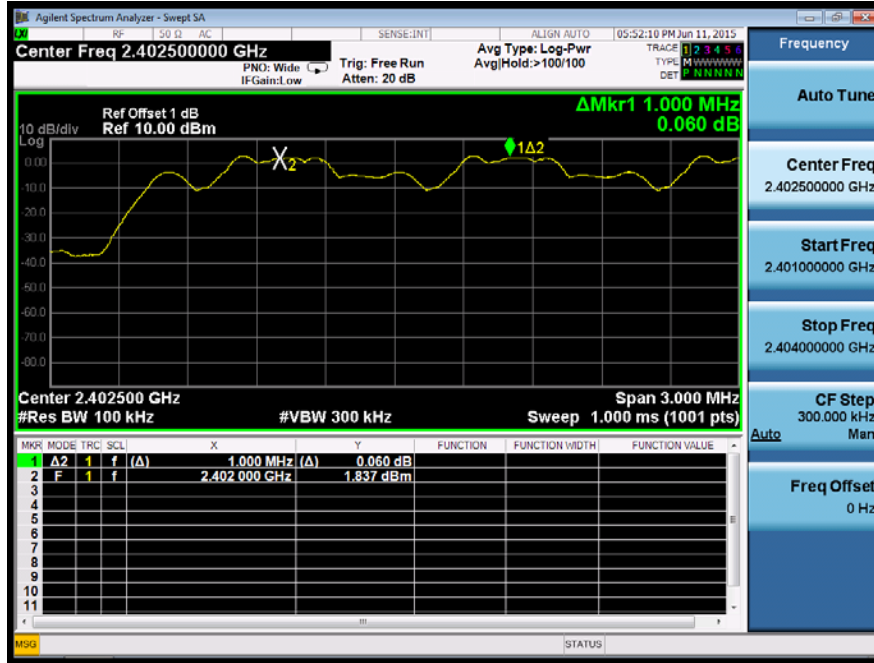

Test Model	Carrier Frequency Separation	
	Bluetooth v2.0 /v2.1/v3.0	
	Channel 39: 2441MHz	8DPSK Modulation



Test Model	Carrier Frequency Separation	
	Bluetooth v2.0 /v2.1/v3.0	
	Channel 78: 2480MHz	8DPSK Modulation

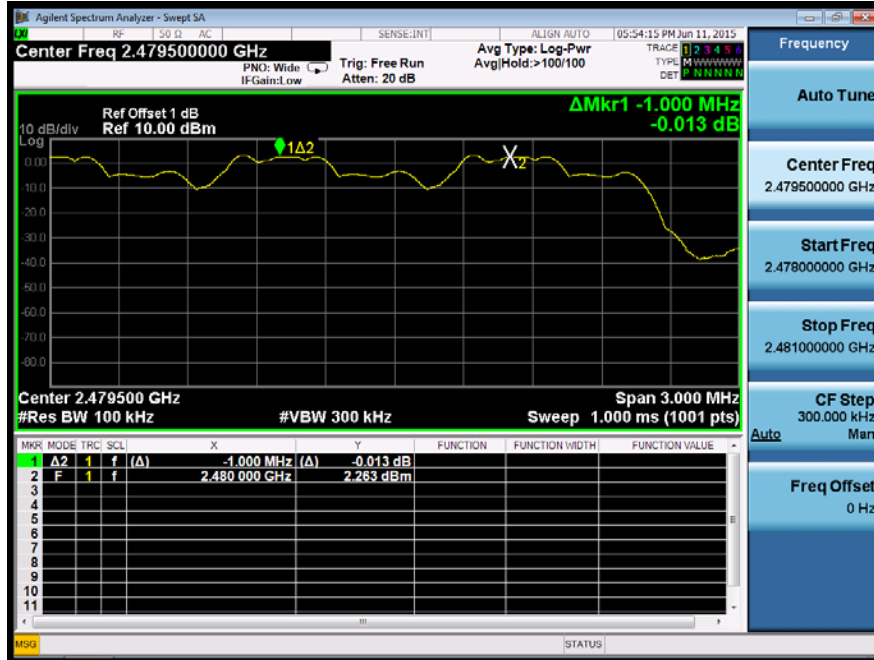

**9.3 NUMBER OF HOPPING FREQUENCIES**

**9.3.1 Applicable Standard**

According to FCC Part 15.247(a)(1) (iii) and DA 00-705

**9.3.2 Conformance Limit**

Frequency hopping systems operating in the 2400-2483.5MHz band shall use at least 15 channels.

**9.3.3 Test Configuration**

Test according to clause 7.1 radio frequency test setup 1

**9.3.4 Test Procedure**

- According to FCC Part 15.247(a)(1)(iii)

The EUT must have its hopping function enabled. Use the following spectrum analyzer settings:

Span = the frequency band of operation (2390-2440MHz) and (2440-2490MHz)

RBW  $\geq$  1% of the span

VBW  $\geq$  RBW

Sweep = auto

Detector function = peak

Trace = max hold

Allow the trace to stabilize. It may prove necessary to break the span up to sections, in order to clearly show all of the hopping frequencies.

**Test Results**

Spectrum Detector:	PK	Test Date :	June 11, 2015
Test By:	KING KONG	Temperature :	24°C
Test Result:	PASS	Humidity :	53 %

Hopping Channel Frequency Range (MHz)	Quantity of Hopping Channel	Quantity of Hopping Channel limit
2400-2483.5	79	$\geq 15$

Test Model	Number Of Hopping Frequencies	
	Bluetooth v2.0 /v2.1/v3.0	
	Span: 2390-2440MHz	

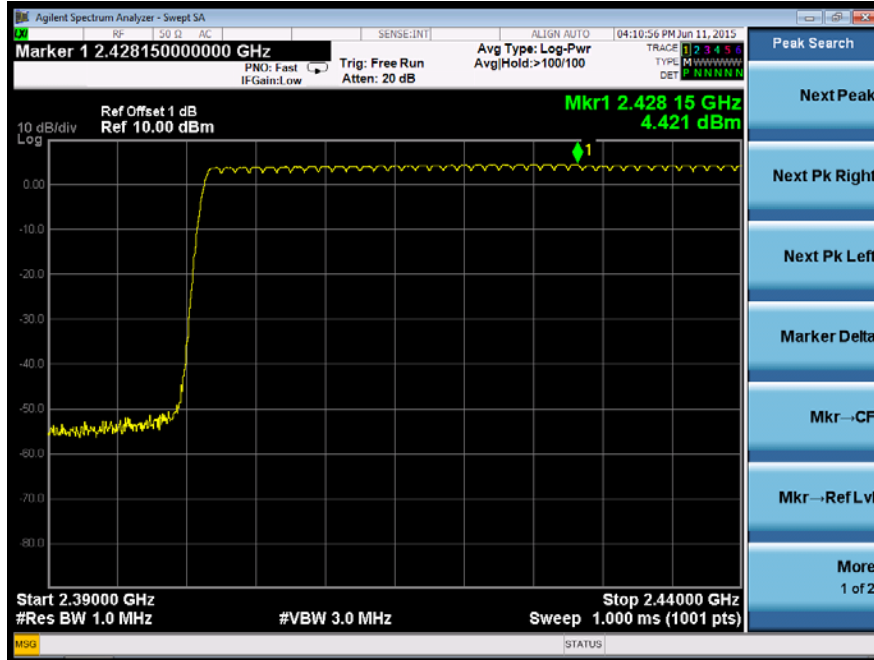

Test Model	Number Of Hopping Frequencies	
	Bluetooth v2.0 /v2.1/v3.0	
	Span: 2440-2490MHz	

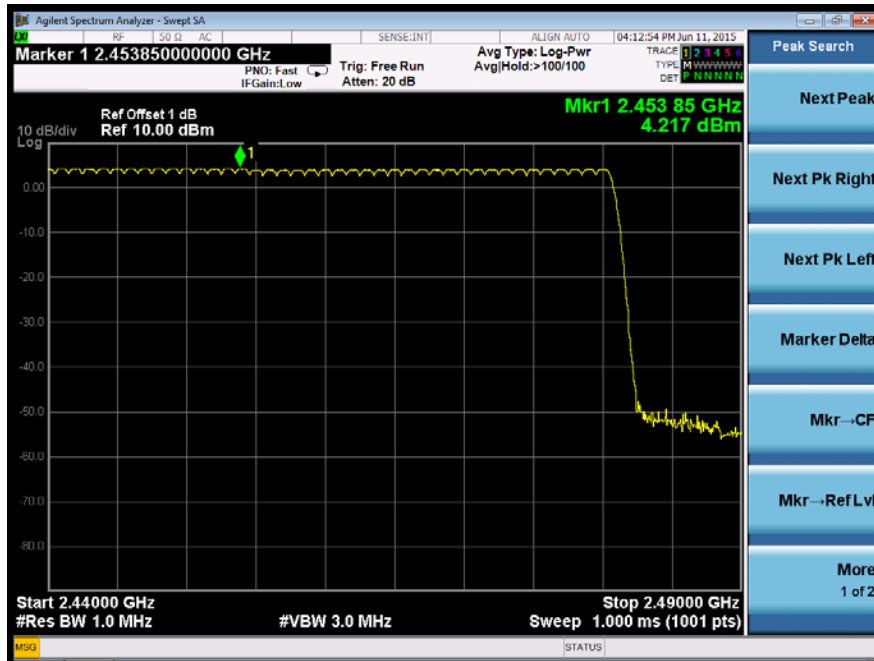

**9.4 AVERAGE TIME OF OCCUPANCY (DWELL TIME)**

**9.4.1 Applicable Standard**

According to FCC Part 15.247(a)(1)(iii) and DA 00-705

**9.4.2 Conformance Limit**

For frequency hopping systems operating in the 2400-2483.5MHz band, the average time of occupancy on any channel shall not be greater than 0.4s within a period of 0.4s multiplied by the number of hopping channels employed.

**9.4.3 Test Configuration**

Test according to clause 7.1 radio frequency test setup 1

**9.4.4 Test Procedure**

- According to FCC Part 15.247(a)(1)(iii)  
 The EUT must have its hopping function enabled. Use the following spectrum analyzer settings:  
 Span = zero span, centered on a hopping channel  
 RBW = 1 MHz  
 VBW ≥ RBW  
 Sweep = as necessary to capture the entire dwell time per hopping channel  
 Detector function = peak  
 Trace = max hold  
 If possible, use the marker-delta function to determine the dwell time. If this value varies with different modes of operation (e.g., data rate, modulation format, etc.), repeat this test for each variation. The limit is specified in one of the subparagraphs of this Section.

**9.4.5 Test Results**

Temperature: 24°C                      Test Date: June 11, 2015  
 Humidity: 53 %                        Test By: KING KONG

Modulation Mode	Channel Number	Packet type	Pulse width (ms)	Number per channel in 31.6s ( 79 Hopping*0.4)	dwell time (ms)	Limit (ms)	Verdict
GFSK	0	DH1	0.424	$1600/(2*79) \times 31.6 = 320$	135.680	<400	PASS
	0	DH3	1.680	$1600/(4*79) \times 31.6 = 160$	268.800	<400	PASS
	0	DH5	2.920	$1600/(6*79) \times 31.6 = 106.67$	311.476	<400	PASS
Note:							

Test Model	Average Time Of Occupancy (Dwell Time)	
	Bluetooth v2.0 /v2.1/v3.0	
	CH 0: 2402MHz	GFSK DH1

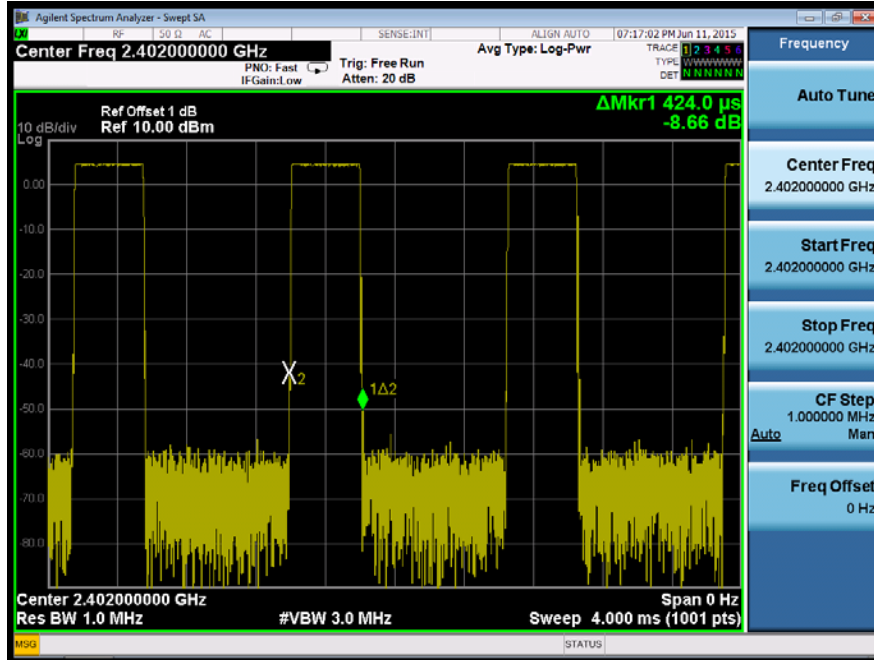

Test Model	Average Time Of Occupancy (Dwell Time)	
	Bluetooth v2.0 /v2.1/v3.0	
	CH 0: 2402MHz	GFSK DH3

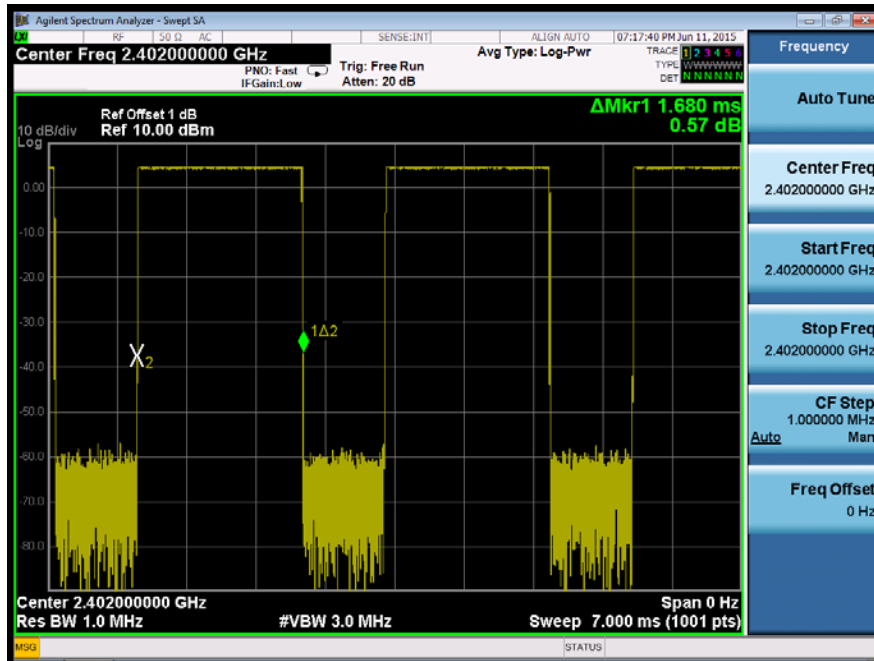

Test Model	Average Time Of Occupancy (Dwell Time)	
	Bluetooth v2.0 /v2.1/v3.0	
	CH 0: 2402MHz	GFSK DH5

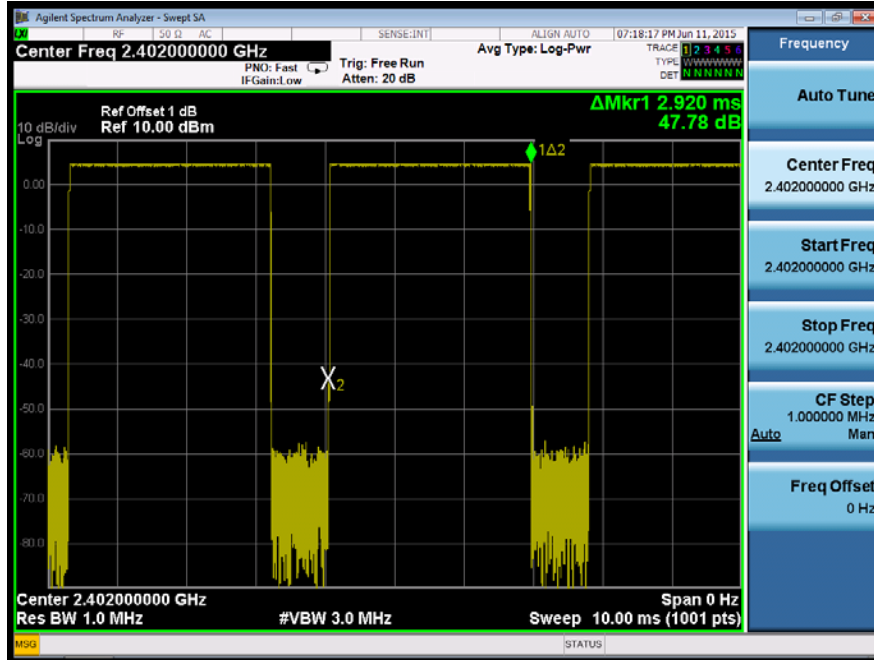





Test Model	Maximum Peak Conducted Output Power	
	Bluetooth v2.0 /v2.1/v3.0	
	Channel 0: 2402MHz	GFSK

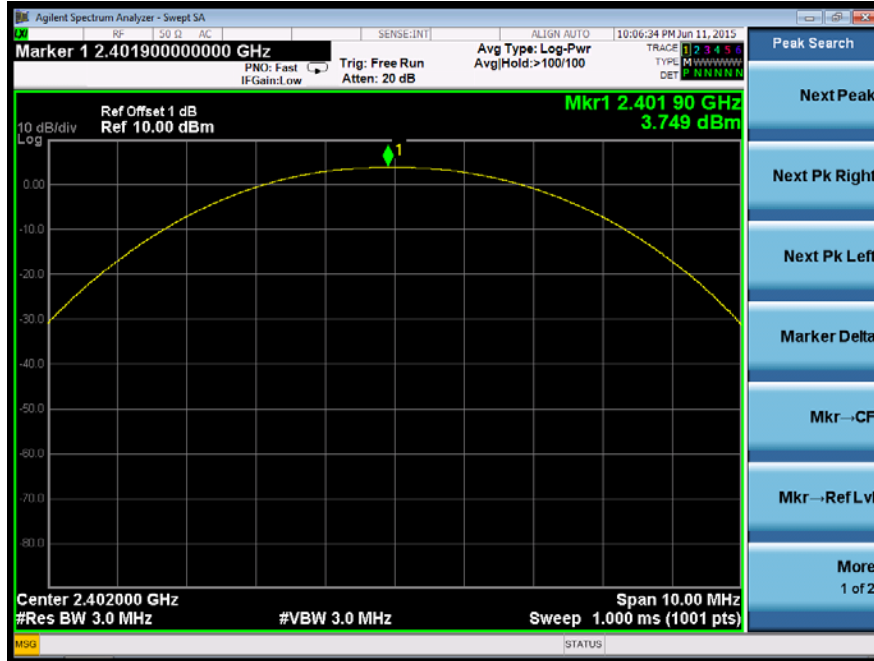

Test Model	Maximum Peak Conducted Output Power	
	Bluetooth v2.0 /v2.1/v3.0	
	Channel 39: 2441MHz	GFSK

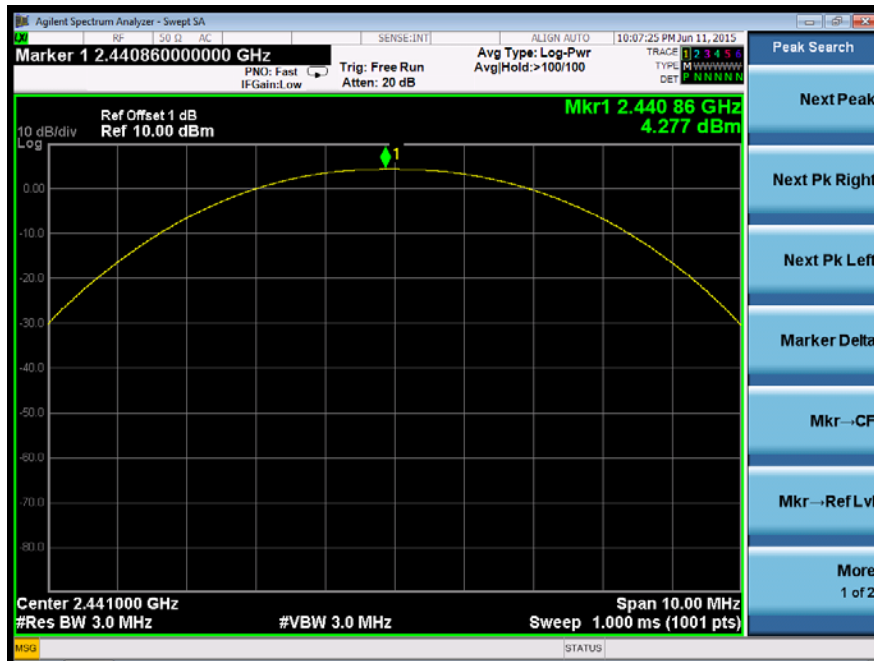

Test Model	Maximum Peak Conducted Output Power	
	Bluetooth v2.0 /v2.1/v3.0	
	Channel 78: 2480MHz	GFSK

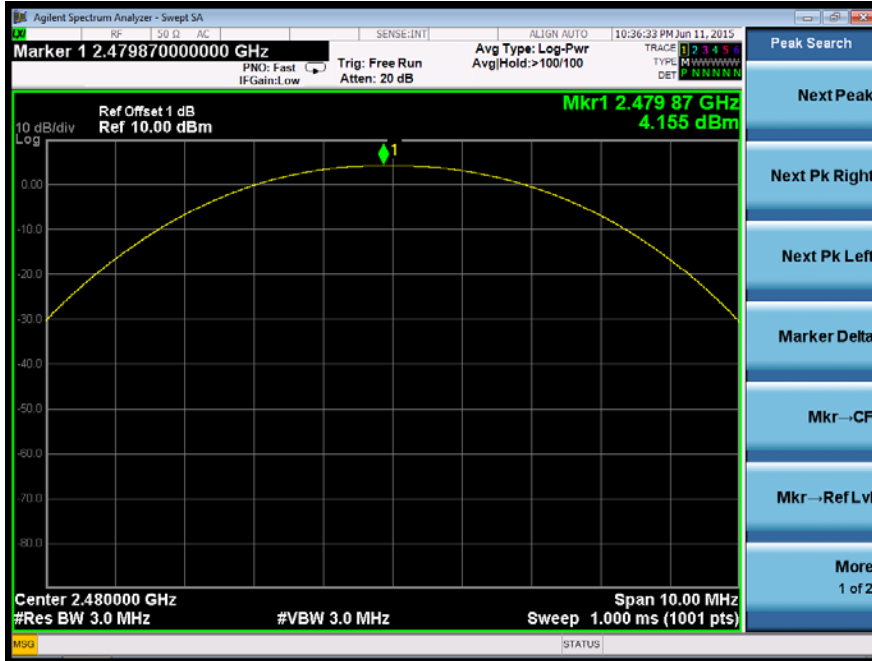

Test Model	Maximum Peak Conducted Output Power	
	Bluetooth v2.0 /v2.1/v3.0	
	Channel 0: 2402MHz	pi/4-DQPSK

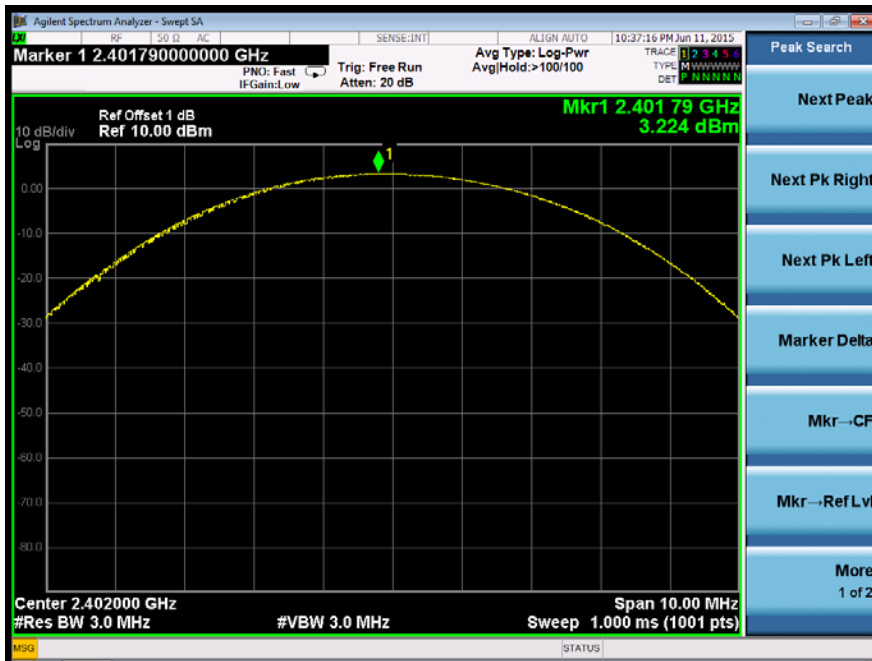

Test Model	Maximum Peak Conducted Output Power	
	Bluetooth v2.0 /v2.1/v3.0	
	Channel 39: 2441MHz	pi/4-DQPSK

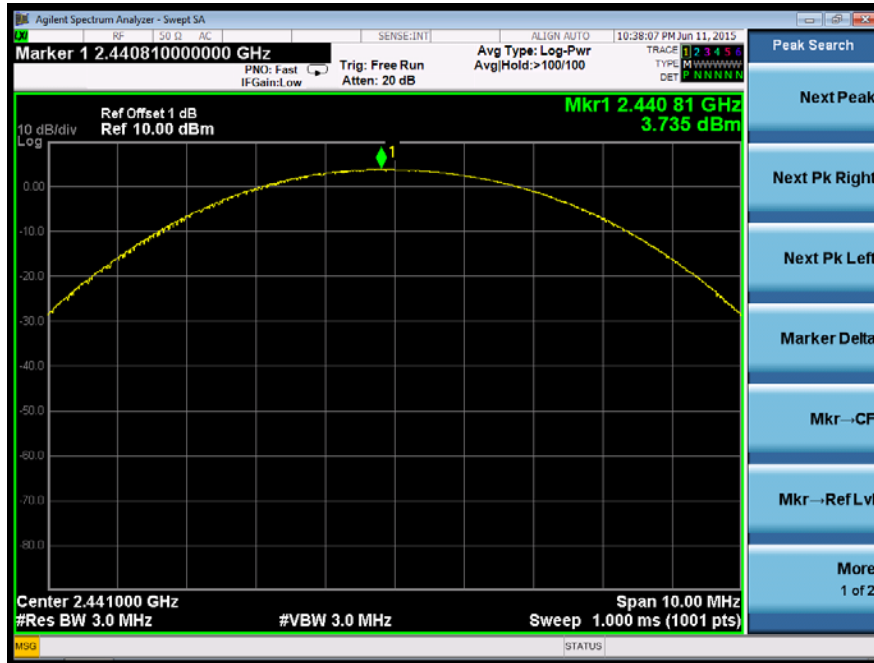

Test Model	Maximum Peak Conducted Output Power	
	Bluetooth v2.0 /v2.1/v3.0	
	Channel 78: 2480MHz	pi/4-DQPSK

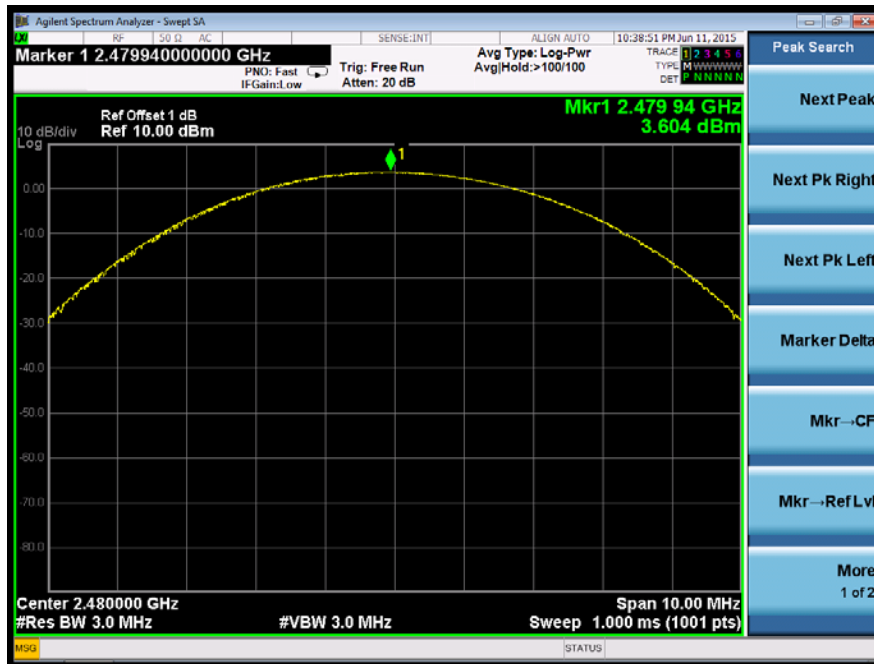

Test Model	Maximum Peak Conducted Output Power	
	Bluetooth v2.0 /v2.1/v3.0	
	Channel 0: 2402MHz	8DPSK

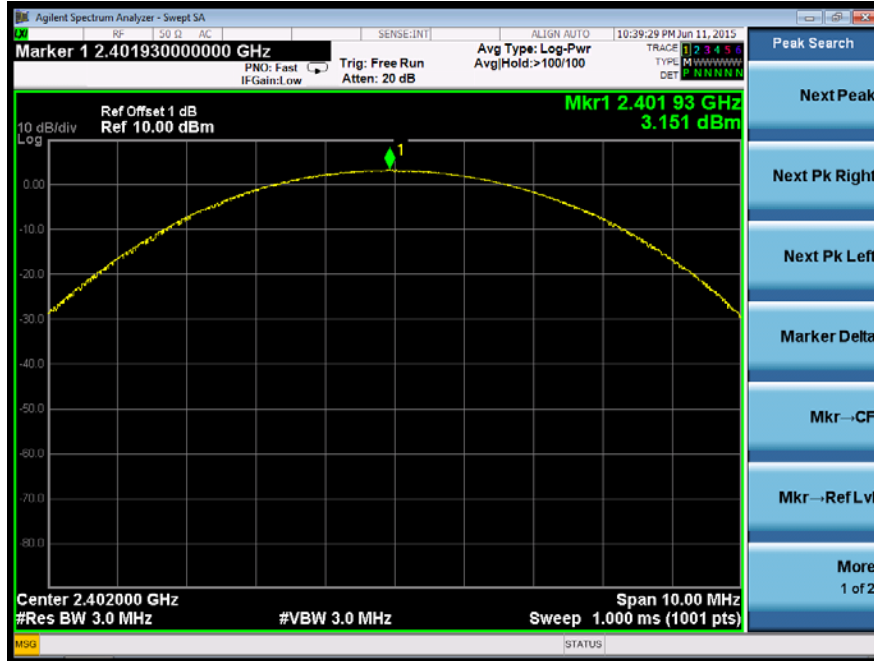

Test Model	Maximum Peak Conducted Output Power	
	Bluetooth v2.0 /v2.1/v3.0	
	Channel 39: 2441MHz	8DPSK

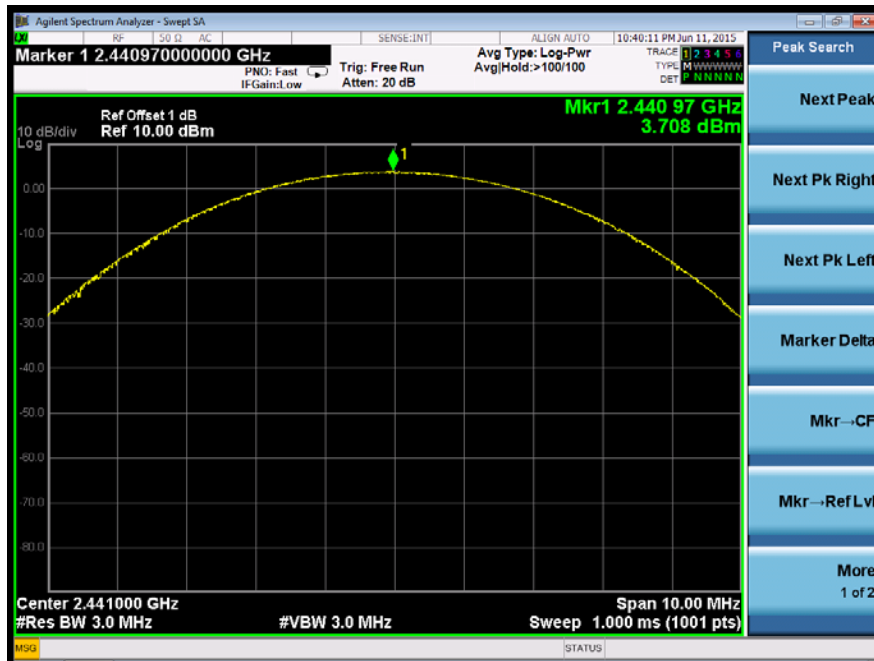

Test Model	Maximum Peak Conducted Output Power	
	Bluetooth v2.0 /v2.1/v3.0	
	Channel 78: 2480MHz	8DPSK

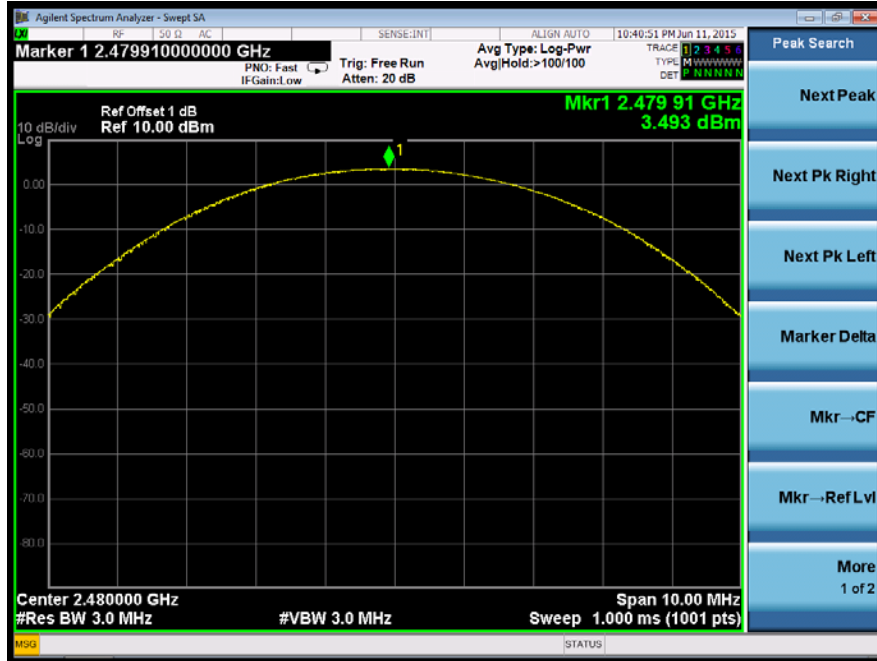

## 9.6 CONDUCTED SUPRIIOUS EMISSION

### 9.6.1 Applicable Standard

According to FCC Part 15.247(d) and DA 00-705

### 9.6.2 Conformance Limit

According to FCC Part 15.247(d):

In any 100 kHz bandwidth outside the frequency band in which the spread spectrum intentional radiator is operating, the radio frequency power that is produced by the intentional radiator shall be at least 20 dB below that in the 100 kHz bandwidth within the band that contains the highest level of the desired power, based on either an RF conducted, provided the transmitter demonstrates compliance with the peak conducted power limits.

### 9.6.3 Test Configuration

Test according to clause 7.1 radio frequency test setup 1

### 9.6.4 Test Procedure

The transmitter output (antenna port) was connected to the spectrum analyzer

#### ■ Reference level measurement

Establish a reference level by using the following procedure:

Set instrument center frequency to DSS channel center frequency.

Set Span = approximately 5 times the 20 dB bandwidth, centered on a hopping channel.

Set the RBW = 100 kHz. Set the VBW  $\geq 3 \times$  RBW.

Set Detector = peak. Set Sweep time = auto couple.

Set Trace mode = max hold. Allow trace to fully stabilize.

Use the peak marker function to determine the maximum Maximum conduceted level.

Note that the channel found to contain the maximum conduceted level can be used to establish the reference level.

#### ■ Band-edge Compliance of RF Conducted Emissions

Use the following spectrum analyzer settings:

Span = wide enough to capture the peak level of the emission operating on the channel closest to the band-edge, as well as any modulation products which fall outside of the authorized band of operation

Set RBW  $\geq 1\%$  of the span=100kHz Set VBW  $\geq$  RBW

Set Sweep = auto Set Detector function = peak Set Trace = max hold

Allow the trace to stabilize. Set the marker on the emission at the bandedge, or on the highest modulation product outside of the band, if this level is greater than that at the bandedge. Enable the marker-delta

function, then use the marker-to-peak function to move the marker to the peak of the in-band emission.

The marker-delta value now displayed must comply with the limit specified in this Section.

Now, using the same instrument settings, enable the hopping function of the EUT. Allow the trace to stabilize. Follow the same procedure listed above to determine if any spurious emissions caused by the hopping function also comply with the specified limit.

#### ■ Conduceted Spurious RF Conducted Emission

Use the following spectrum analyzer settings:

Span = wide enough to capture the peak level of the in-band emission and all spurious emissions (e.g., harmonics) from the lowest frequency generated in the EUT up through the 10th harmonic.(30MHz to 25GHz). Set RBW = 100 kHz Set VBW  $\geq$  RBW

Set Sweep = auto Set Detector function = peak Set Trace = max hold

Set Sweep = auto Set Detector function = peak Set Trace = max hold

Allow the trace to stabilize. Set the marker on the peak of any spurious emission recorded. The level displayed must comply with the limit specified in this Section.

### 9.6.5 Test Results

Bluetooth (GFSK, pi/4-DQPSK, 8DPSK) mode have been tested, and the worst result(GFSK) was report as below:

Test Model	Maximum Conduced Level RBW=100kHz	
	Bluetooth v2.0 /v2.1/v3.0	
	Channel 0: 2402MHz	GFSK

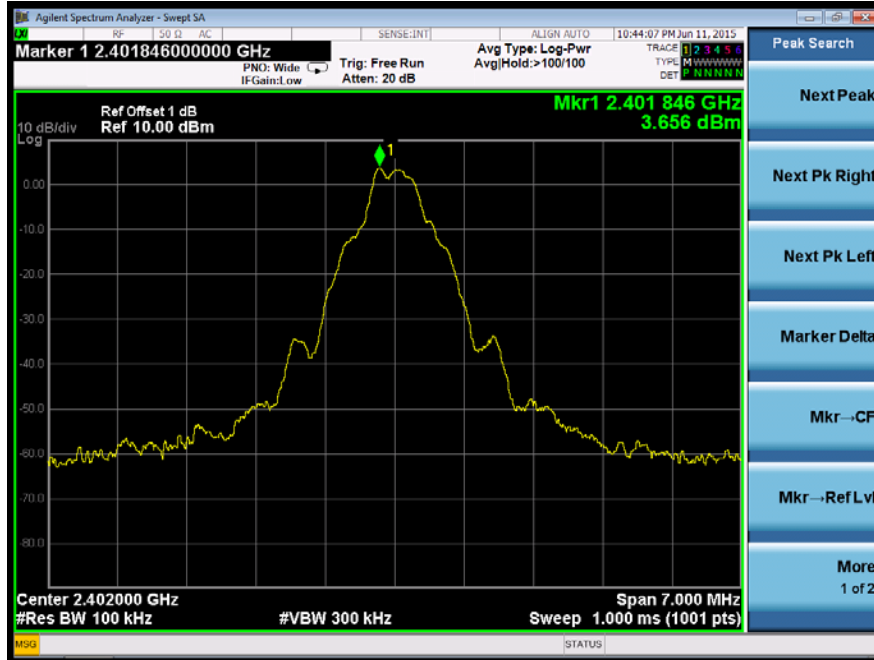

Test Model	Conduced Spurious RF Conducted Emission	
	Bluetooth v2.0 /v2.1/v3.0	
	Channel 0: 2402MHz	GFSK





Test Model	Maximum Conduced Level RBW=100kHz	
	Bluetooth v2.0 /v2.1/v3.0	
	Channel 39: 2441MHz	GFSK



Test Model	Conduced Spurious RF Conducted Emission	
	Bluetooth v2.0 /v2.1/v3.0	
	Channel 39: 2441MHz	GFSK



Test Model	Maximum Conduced Level RBW=100kHz	
	Bluetooth v2.0 /v2.1/v3.0	
	Channel 78: 2480MHz	GFSK



Test Model	Conduced Spurious RF Conducted Emission	
	Bluetooth v2.0 /v2.1/v3.0	
	Channel 78: 2480MHz	GFSK



Test Model	Band-edge Conducted Emissions	
	Bluetooth v2.0 /v2.1/v3.0	
	Channel 0: 2402MHz	GFSK



Test Model	Band-edge Conducted Emissions	
	Bluetooth v2.0 /v2.1/v3.0	
	Channel 78: 2480MHz	GFSK

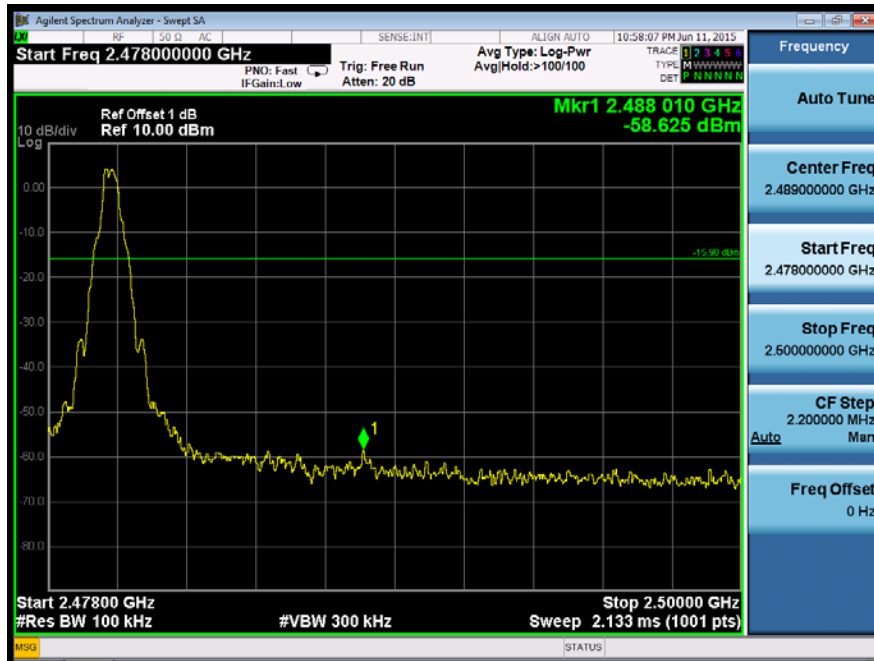

Test Model	Maximum Conduced Level RBW=100kHz	
	Bluetooth v2.0 /v2.1/v3.0	
	Hopping	GFSK

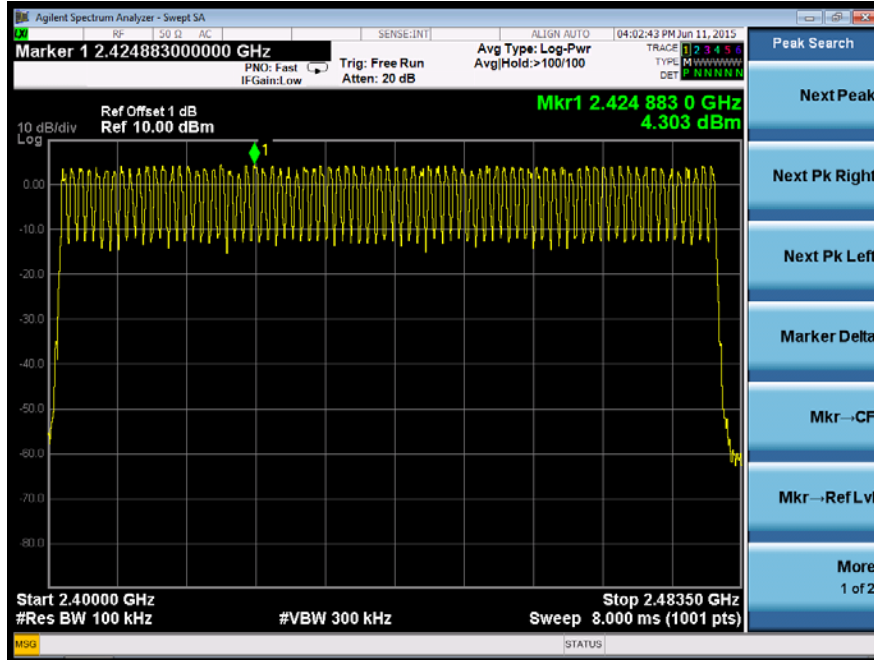

Test Model	Conduced Spurious RF Conducted Emission	
	Bluetooth v2.0 /v2.1/v3.0	
	Hopping	GFSK



Test Model	Band-edge Conducted Emissions	
	Bluetooth v2.0 /v2.1/v3.0	
	Hopping	GFSK

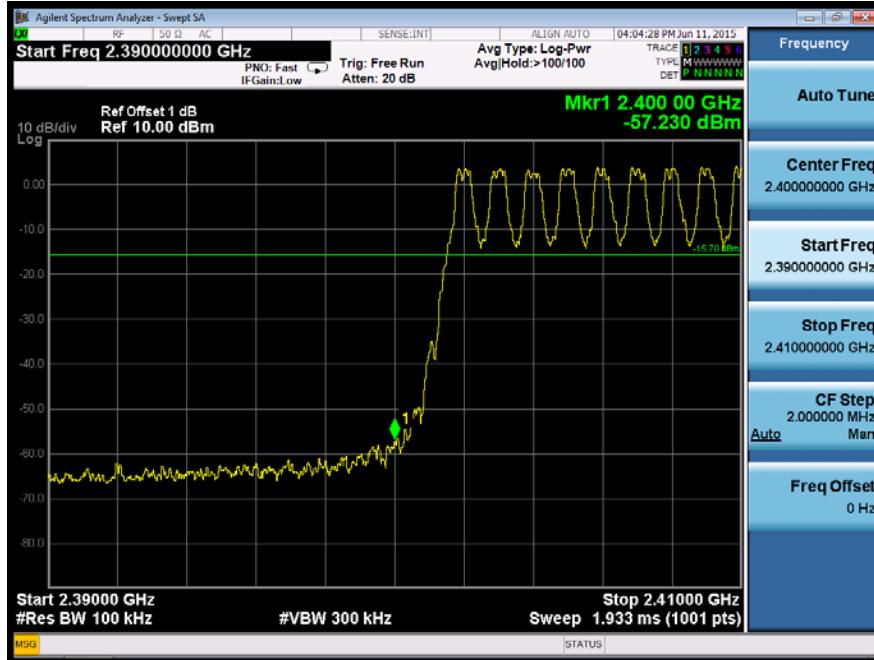

Test Model	Band-edge Conducted Emissions	
	Bluetooth v2.0 /v2.1/v3.0	
	Hopping	GFSK

