



# FCC Radio Test Report

## FCC ID: YJYUA204SA

This report concerns (check one) :  Original Grant  Class II Change

**Issued Date** : Dec. 28, 2011  
**Project No.** : 1110C169B  
**Equipment** : 150Mbps Wireless N USB Adapter  
**Model Name** : FWN-651ND; FWN-651N  
**Applicant** : Shanghai Feixun Communication Co., Ltd.  
**Address** : Wing B, 15/F, GDC Building, NO.9 Gaoxinzhong  
3rd Ave., Nanshan, Shenzhen, Guangdong, China

**Tested by:**

Neutron Engineering Inc. EMC Laboratory

**Date of Receipt:** Dec. 16, 2011

**Date of Test:**

Dec. 16, 2011 ~ Dec. 28, 2011

Testing Engineer :

*David Mao*

(David Mao)

Technical Manager :

*Leo Hung*

(Leo Hung)

Authorized Signatory :

*Steven Lu*

(Steven Lu)

### **Neutron Engineering Inc.**

**No.3, Jinshagang 1st Road, ShiXia, Dalang  
Town, Dong Guan, China.  
TEL : (0769) 8318-3000 FAX : (0769) 8319-6000**



### **Declaration**

**Neutron** represents to the client that testing is done in accordance with standard procedures as applicable and that test instruments used has been calibrated with the standards traceable to National Measurement Laboratory (**NML**) of **R.O.C.**, or National Institute of Standards and Technology (**NIST**) of **U.S.A.**

**Neutron's** reports apply only to the specific samples tested under conditions. It is manufacture's responsibility to ensure that additional production units of this model are manufactured with the identical electrical and mechanical components. **Neutron** shall have no liability for any declarations, inferences or generalizations drawn by the client or others from **Neutron** issued reports.

**Neutron's** reports must not be used by the client to claim product endorsement by the authorities or any agency of the Government.

This report is the confidential property of the client. As a mutual protection to the clients, the public and **Neutron-self**, extracts from the test report shall not be reproduced except in full with **Neutron's** authorized written approval.

**Neutron's** laboratory quality assurance procedures are in compliance with the **ISO Guide 17025** requirements, and accredited by the conformity assessment authorities listed in this test report.

### **Limitation**

For the use of the authority's logo is limited unless the Test Standard(s)/Scope(s)/Item(s) mentioned in this test report is (are) included in the conformity assessment authorities acceptance respective.



<b>Table of Contents</b>	<b>Page</b>
<b>1 . CERTIFICATION</b>	<b>5</b>
<b>2 . SUMMARY OF TEST RESULTS</b>	<b>6</b>
2.1 TEST FACILITY	7
2.2 MEASUREMENT UNCERTAINTY	7
<b>3 . GENERAL INFORMATION</b>	<b>8</b>
3.1 GENERAL DESCRIPTION OF EUT	8
3.2 DESCRIPTION OF TEST MODES	10
3.3 TABLE OF PARAMETERS OF TEXT SOFTWARE SETTING	11
3.4 BLOCK DIGRAM SHOWING THE CONFIGURATION OF SYSTEM TESTED	12
3.5 DESCRIPTION OF SUPPORT UNITS	13
<b>4 . EMC EMISSION TEST</b>	<b>14</b>
4.1 CONDUCTED EMISSION MEASUREMENT	14
4.1.1 POWER LINE CONDUCTED EMISSION LIMITS	14
4.1.2 MEASUREMENT INSTRUMENTS LIST AND SETTING	14
4.1.3 TEST PROCEDURE	15
4.1.4 DEVIATION FROM TEST STANDARD	15
4.1.5 TEST SETUP	15
4.1.6 EUT OPERATING CONDITIONS	15
4.1.7 TEST RESULTS	16
4.2 RADIATED EMISSION MEASUREMENT	20
4.2.1 RADIATED EMISSION LIMITS	20
4.2.2 MEASUREMENT INSTRUMENTS LIST ANS SETTING	21
4.2.3 TEST PROCEDURE	22
4.2.4 DEVIATION FROM TEST STANDARD	22
4.2.5 TEST SETUP	23
4.2.6 EUT OPERATING CONDITIONS	23
4.2.7 TEST RESULTS (BETWEEN 30 – 1000 MHZ)	24
4.2.8 TEST RESULTS (ABOVE 1000 MHZ)- FWN-651ND	28
4.2.9 TEST RESULTS (ABOVE 1000 MHZ)- FWN-651N	76
<b>5 . BANDWIDTH TEST</b>	<b>124</b>
5.1 APPLIED PROCEDURES / LIMIT	124
5.1.1 MEASUREMENT INSTRUMENTS LIST	124
5.1.2 TEST PROCEDURE	124
5.1.3 DEVIATION FROM STANDARD	124
5.1.4 TEST SETUP	124
5.1.5 EUT OPERATION CONDITIONS	124



<b>Table of Contents</b>	<b>Page</b>
5.1.6 TEST RESULTS	125
<b>6 . MAXIMUM OUTPUT POWER TEST</b>	<b>133</b>
6.1 APPLIED PROCEDURES / LIMIT	133
6.1.1 MEASUREMENT INSTRUMENTS LIST	133
6.1.2 TEST PROCEDURE	133
6.1.3 DEVIATION FROM STANDARD	133
6.1.4 TEST SETUP	133
6.1.5 EUT OPERATION CONDITIONS	133
6.1.6 TEST RESULTS	134
<b>7 . ANTENNA CONDUCTED SPURIOUS EMISSION</b>	<b>142</b>
7.1 APPLIED PROCEDURES / LIMIT	142
7.1.1 MEASUREMENT INSTRUMENTS LIST	142
7.1.2 TEST PROCEDURE	142
7.1.3 DEVIATION FROM STANDARD	142
7.1.4 TEST SETUP	142
7.1.5 EUT OPERATION CONDITIONS	142
7.1.6 TEST RESULTS	143
<b>8 . POWER SPECTRAL DENSITY TEST</b>	<b>163</b>
8.1 APPLIED PROCEDURES / LIMIT	163
8.1.1 MEASUREMENT INSTRUMENTS LIST	163
8.1.2 TEST PROCEDURE	163
8.1.3 DEVIATION FROM STANDARD	163
8.1.4 TEST SETUP	163
8.1.5 EUT OPERATION CONDITIONS	163
8.1.6 TEST RESULTS	164
<b>9 . EUT TEST PHOTO</b>	<b>172</b>



## 1. CERTIFICATION

Equipment : 150Mbps Wireless N USB Adapter  
Brand Name : PHICOMM  
Model Name : FWN-651ND; FWN-651N  
Applicant : Shanghai Feixun Communication Co., Ltd.  
Factory : Shanghai WDK Technology Co., Ltd.  
Address : No.1-10, Lane 2100, Songzheng Road, Shi hudang Town, Songjiang,  
Shanghai  
Date of Test : Dec. 16, 2011 ~ Dec. 28, 2011  
Test Item : ENGINEERING SAMPLE  
Standards : FCC Part15, Subpart C(15.247) / ANSI C63.4 : 2003

The above equipment has been tested and found compliance with the requirement of the relative standards by Neutron Engineering Inc. EMC Laboratory.

The test data, data evaluation, and equipment configuration contained in our test report (Ref No. NEI-FCCP-1-1110C169B) were obtained utilizing the test procedures, test instruments, test sites that has been accredited by the Authority of NVLAP and TAF according to the ISO-17025 quality assessment standard and technical standard(s).



## 2. SUMMARY OF TEST RESULTS

Test procedures according to the technical standards:

<b>FCC Part15 (15.247) , Subpart C</b>				
Standard	Section	Test Item	Judgment	Remark
	15.207	Conducted Emission	PASS	
	15.247(d)	Antenna conducted Spurious Emission	PASS	
	15.247(a)(2)	6dB Bandwidth	PASS	
	15.247(b)(3)	Peak Output Power	PASS	
	15.209/15.205	Radiated Spurious Emission	PASS	
	15.247(e)	Power Spectral Density	PASS	
	15.203	Antenna Requirement	PASS	

**NOTE:**

(1) "N/A" denotes test is not applicable in this Test Report



**2.1 TEST FACILITY**

The test facilities used to collect the test data in this report is **DG-CB03/DG-C02** at the location of No.3,Jinshagang 1st Road, ShiXia, Dalang Town, Dong Guan, China.523792  
 Neutron's test firm number is 319330

**2.2 MEASUREMENT UNCERTAINTY**

Where relevant, the following measurement uncertainty levels have been estimated for tests performed on the EUT as specified in CISPR 16-4-2:

The reported uncertainty of measurement  $y \pm U$ , where expanded uncertainty U is based on a standard uncertainty multiplied by a coverage factor of  $k=2$ , providing a level of confidence of approximately 95 %.

**A. Conducted Measurement :**

Test Site	Method	Measurement Frequency Range	U , (dB)	NOTE
DG-C02	CISPR	150 KHz ~ 30MHz	1.94	

**B. Radiated Measurement :**

Test Site	Method	Measurement Frequency Range	Ant. H / V	U , (dB)	NOTE
DG-CB03	CISPR	30MHz ~ 200MHz	V	3.82	
		30MHz ~ 200MHz	H	3.60	
		200MHz ~ 1,000MHz	V	3.86	
		200MHz ~ 1,000MHz	H	3.94	



**3. GENERAL INFORMATION**

**3.1 GENERAL DESCRIPTION OF EUT**

Equipment	150Mbps Wireless N USB Adapter	
Brand Name	PHICOMM	
Model Name	FWN-651ND; FWN-651N	
OEM Brand/Model Name	N/A	
Model Difference	Differences are appearance and antenna, model FWN-651ND is Dipole ANT, model FWN-651N is PCB ANT (RF Modular is the same)	
Product Description	The EUT is a 150Mbps Wireless N USB Adapter.	
	Operation Frequency:	2412~2462 MHz
	Modulation Type:	802.11b:CCK, DQPSK, DBPSK 802.11g:OFDM 802.11n:OFDM
	Bit Rate of Transmitter	802.11b:11/5.5/2/1 Mbps 802.11g:54/48/36/24/18/12/9/6 Mbps Draft 802.11n:up to 150Mbps
	Number of Channel	11 CH, Please see Note 2. (please see page 9)
	Antenna Designation:	Please see Note 3.
	Antenna Gain(Peak)	(please see page 9)
	Output Power:	802.11b: 11.21dBm 802.11g: 11.23dBm 802.11n(20MHz): 11.22 dBm 802.11n(40MHz): 11.23 dBm
	Based on the application, features, or specification exhibited in User's Manual, the EUT is considered as an ITE/Computing Device. More details of EUT technical specification, please refer to the User's Manual.	
	Power Source	DC Voltage supplied from Host System.
Power Rating	I/P: 120V/60Hz O/P: DC 5V	
Co necting I/O Port(s)	Please refer to the User's Manual	
Products Covered	N/A	
Products Covered	N/A	

**Note:**

1. For a more detailed features description, please refer to the manufacturer's specifications or the User's Manual.





2. CH 01 – CH 11 for 802.11b, 802.11g, 802.11n(20MHz)  
 CH 03 – CH 09 for 802.11n(40MHz)

**Channel List**

Channel	Frequency (MHz)	Channel	Frequency (MHz)	Channel	Frequency (MHz)	Channel	Frequency (MHz)
01	2412	04	2427	07	2442	10	2457
02	2417	05	2432	08	2447	11	2462
03	2422	06	2437	09	2452		

3. Table for Filed Antenna

Model	Brand	Model Name	Antenna Type	Connector	Gain (dBi)
FWN-651ND	wutong	K601-250023-A	Dipole Antenna	R-SMA	2.56
FWN-651N	N/A	N/A	PCB Antenna	N/A	0

The printed antenna of FWN-651ND can not transmit when using dipole antenna even if it has two antennas. Obviously, the antenna of FWN-651ND is the same as that of FWN-651N when using printed antenna only.



**3.2 DESCRIPTION OF TEST MODES**

To investigate the maximum EMI emission characteristics generates from EUT, the test system was pre-scanning tested base on the consideration of following EUT operation mode or test configuration mode which possible have effect on EMI emission level. Each of these EUT operation mode(s) or test configuration mode(s) mentioned above was evaluated respectively.

Pretest Mode	Description
Mode 1	TX B MODE CHANNEL 01/06/11
Mode 2	TX G MODE CHANNEL 01/06/11
Mode 3	TX N-20MHZ MODE CHANNEL 01/06/11
Mode 4	TX N-40MHZ MODE CHANNEL 03/06/09
Mode 5	TX MODE

The EUT system operated these modes were found to be the worst case during the pre-scanning test as Following:

<b>For Conducted Test</b>	
Final Test Mode	Description
Mode 5	TX MODE

<b>For Radiated Test</b>	
Final Test Mode	Description
Mode 1	TX B MODE CHANNEL 01/06/11
Mode 2	TX G MODE CHANNEL 01/06/11
Mode 3	TX N-20MHZ MODE CHANNEL 01/06/11
Mode 4	TX N-40MHZ MODE CHANNEL 03/06/09

Note:

- (1) The measurements are performed at the highest, middle, lowest available channels.
- (2) During the output power test, all data rates have been investigated and the highest output powers were recorded are as follows:  
 802.11b mode: DBPSK (1Mbps)  
 802.11g mode: OFDM (6Mbps)  
 802.11n HT20/HT40 mode : MCS0 (6.5Mbps)  
 For radiated emission tests, the highest output powers were set for final test.
- (3) Worst-case mode and channel used for 30-1000 MHz radiated and power line conducted emissions was the mode and channel with the highest output power, that was determined to be 11B Channel 06



**3.3 TABLE OF PARAMETERS OF TEXT SOFTWARE SETTING**

During testing channel & power controlling software provided by the customer was used to control the operating channel as well as the output power level. The RF output power selection is for the setting of RF output power expected by the customer and is going to be fixed on the firmware of the final end product power parameters of WLAN

Test software Version	RT5x7xQA		
<b>Frequency</b>	<b>2412 MHz</b>	<b>2437 MHz</b>	<b>2462 MHz</b>
IEEE 802.11b DSSS	8	8	9
IEEE 802.11g OFDM	9	9	0D

Test software Version	RT5x7xQA		
<b>Frequency (MHz)</b>	<b>2412 MHz</b>	<b>2437 MHz</b>	<b>2462 MHz</b>
IEEE 802.11n (20MHz)	8	8	0C
<b>Frequency (MHz)</b>	<b>2422 MHz</b>	<b>2437 MHz</b>	<b>2452 MHz</b>
IEEE 802.11n (40MHz)	7	7	0A

**3.4 BLOCK DIGRAM SHOWING THE CONFIGURATION OF SYSTEM TESTED**

**Conducted Mode:**

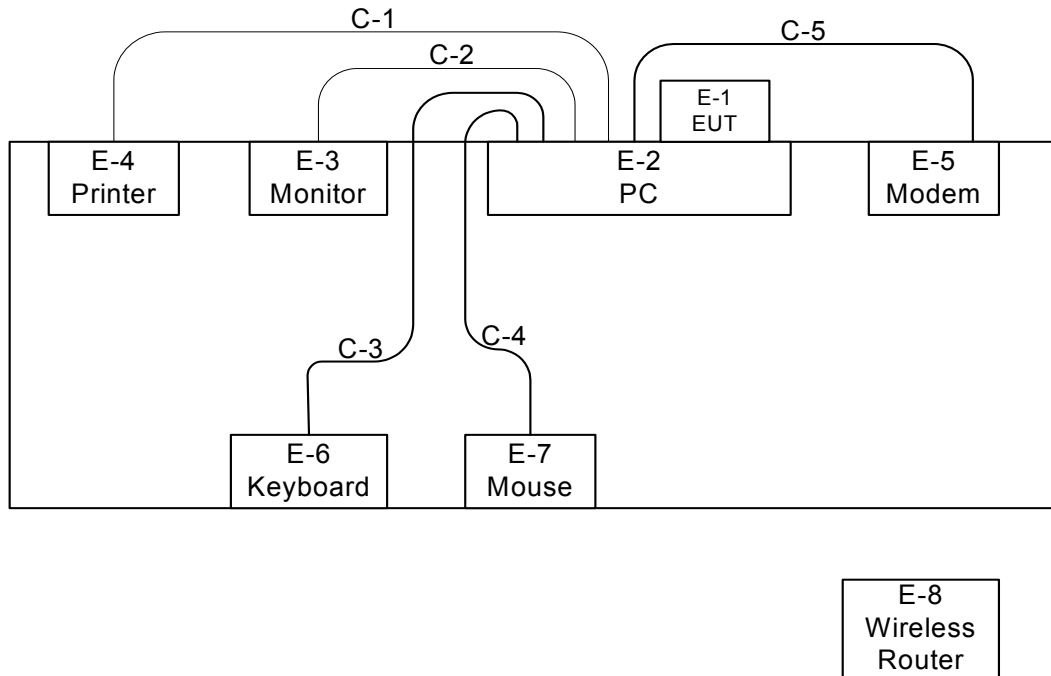

- C-1: Parallel Cable
- C-2: D-Sub Cable
- C-3: USB Cable
- C-4: USB Cable
- C-5: RS232 Cable

**Radiated TX Mode:**

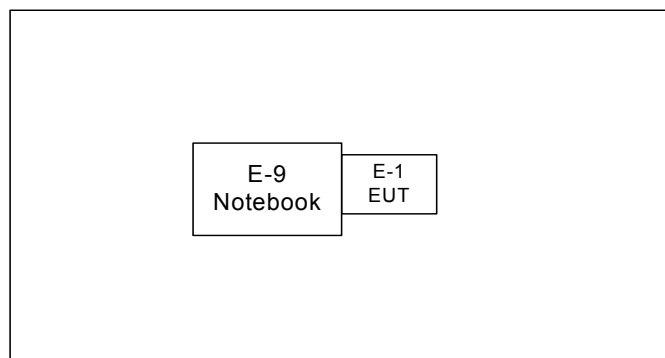



**3.5 DESCRIPTION OF SUPPORT UNITS**

The EUT has been tested as an independent unit together with other necessary accessories or support units. The following support units or accessories were used to form a representative test configuration during the tests.

Item	Equipment	Mfr/Brand	Model/Type No.	FCC ID	Series No.	Note
E-1	150Mbps Wireless N USB Adapter	PHICOMM	FWN-651ND; FWN-651N	YJYUA204SA	N/A	EUT
E-2	PC	Dell 745	DCSM	DOC	G7K832X	
E-3	LCD monitor	Dell	E177FPc	DOC	CNOFJ179-64 180-6AG-1WN S	
E-4	Printer	SII	DPU-414	DOC	3018507 B	
E-5	Modem	ACEEX	DM-1414V	IFAXDm1414	0603002131	
E-6	USB Keyboard	Dell	L100	DOC	CNORH65965 89071T08NE	
E-7	USB Mouse	Dell	MO56UOA	DOC	FQJ000BS	
E-8	Router	Tenda	W300A	DOC	N/A	
E-9	NOTEBOOK	HP	HSTNN-I69C-3	DOC	CNUO2203XG	

Item	Shielded Type	Ferrite Core	Length	Note
C-1	YES	NO	1.8M	
C-2	YES	YES	1.8M	
C-3	YES	YES	1.8M	
C-4	YES	NO	1.8M	
C-5	NO	NO	1.8M	

Note:

- (1) The support equipment was authorized by Declaration of Confirmation.
- (2) For detachable type I/O cable should be specified the length in cm in 『Length』 column.



**4. EMC EMISSION TEST**

**4.1 CONDUCTED EMISSION MEASUREMENT**

**4.1.1 POWER LINE CONDUCTED EMISSION Limits (Frequency Range 150KHz-30MHz)**

FREQUENCY (MHz)	Class A (dBuV)		Class B (dBuV)		Standard
	Quasi-peak	Average	Quasi-peak	Average	
0.15 -0.5	79.00	66.00	66 - 56 *	56 - 46 *	CISPR
0.50 -5.0	73.00	60.00	56.00	46.00	CISPR
5.0 -30.0	73.00	60.00	60.00	50.00	CISPR

0.15 -0.5	79.00	66.00	66 - 56 *	56 - 46 *	FCC
0.50 -5.0	73.00	60.00	56.00	46.00	FCC
5.0 -30.0	73.00	60.00	60.00	50.00	FCC

Note:

- (1) The tighter limit applies at the band edges.
- (2) The limit of " \* " marked band means the limitation decreases linearly with the logarithm of the frequency in the range.

**4.1.2 MEASUREMENT INSTRUMENTS LIST AND SETTING**

Item	Kind of Equipment	Manufacturer	Type No.	Serial No.	Calibrated until
1	LISN	EMCO	3816/2	00052765	May.26.2012
2	LISN	R&S	ENV216	100087	May.26.2012
3	Test Cable	N/A	C_17	N/A	Mar.30.2012
4	EMI TEST RECEIVER	R&S	ESCS30	826547/022	May.26.2012
5	50Ω Terminator	SHX	TF2-3G-A	08122902	May.26.2012

Remark: " N/A" denotes No Model Name. , Serial No. or No Calibration specified.

The following table is the setting of the receiver

Receiver Parameters	Setting
Attenuation	10 dB
Start Frequency	0.15 MHz
Stop Frequency	30 MHz
IF Bandwidth	9 kHz

#### 4.1.3 TEST PROCEDURE

- The EUT was placed 0.8 meters from the horizontal ground plane with EUT being connected to the power mains through a line impedance stabilization network (LISN). All other support equipments powered from additional LISN(s). The LISN provide 50 Ohm/ 50uH of coupling impedance for the measuring instrument.
- Interconnecting cables that hang closer than 40 cm to the ground plane shall be folded back and forth in the center forming a bundle 30 to 40 cm long.
- I/O cables that are not connected to a peripheral shall be bundled in the center. The end of the cable may be terminated, if required, using the correct terminating impedance. The overall length shall not exceed 1 m.
- LISN at least 80 cm from nearest part of EUT chassis.
- For the actual test configuration, please refer to the related Item –EUT Test Photos.

#### 4.1.4 DEVIATION FROM TEST STANDARD

No deviation

#### 4.1.5 TEST SETUP

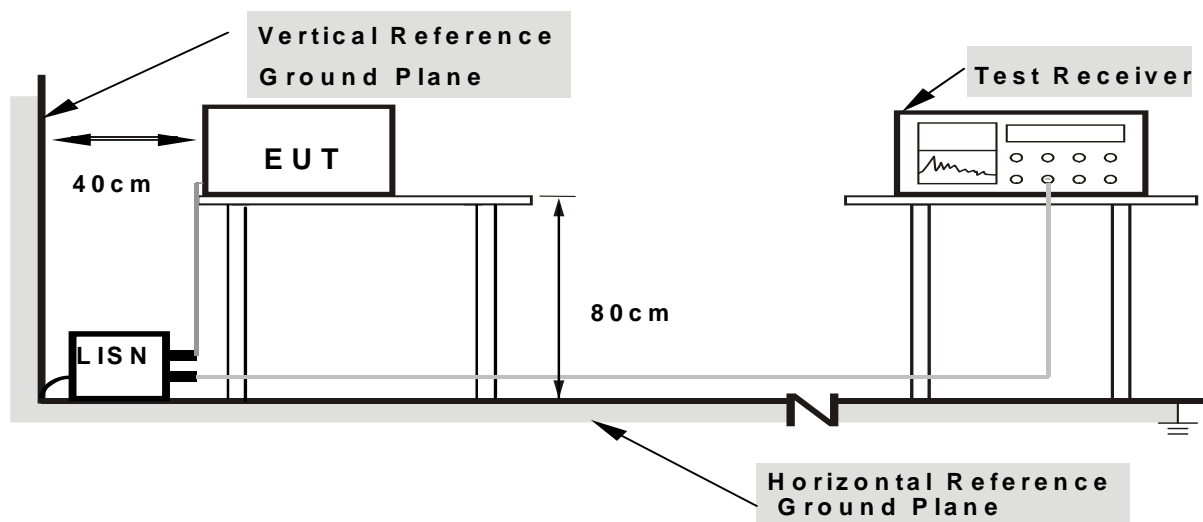

**Note: 1. Support units were connected to second LISN.**

**2. Both of LISNs (AMN) are 80 cm from EUT and at least 80 cm from other units and other metal planes**

#### 4.1.6 EUT OPERATING CONDITIONS

The EUT was configured for testing in a typical fashion (as a customer would normally use it). The EUT has been programmed to continuously transmit during test. This operating condition was tested and used to collect the included data.

The EUT was programmed to be in continuously transmitting mode.



**4.1.7 TEST RESULTS**

EUT :	150Mbps Wireless N USB Adapter	Model Name :	FWN-651ND
Temperature :	25 °C	Relative Humidity :	58%
Pressure :	1010hPa	Test Power :	AC 120V/60Hz
Test Mode :	TX MODE		

Freq. (MHz)	Terminal L/N	Measured(dBuV)		Limits(dBuV)		Margin (dB)	Note
		QP-Mode	AV-Mode	QP-Mode	AV-Mode		
0.34	Line	36.94	*	59.14	49.14	-22.20	(QP)
0.40	Line	38.27	*	57.85	47.85	-19.58	(QP)
0.70	Line	38.35	*	56.00	46.00	-17.65	(QP)
1.66	Line	35.86	*	56.00	46.00	-20.14	(QP)
2.39	Line	39.14	*	56.00	46.00	-16.86	(QP)
3.82	Line	40.63	*	56.00	46.00	-15.37	(QP)

**Remark**

- (1) All readings are QP Mode value unless otherwise stated AVG in column of Note. If the QP Mode Measured value compliance with the QP Limits and lower than AVG Limits, the EUT shall be deemed to meet both QP & AVG Limits and then only QP Mode was measured, but AVG Mode didn't perform. In this case, a "\*" marked in AVG Mode column of Interference Voltage Measured.
- (2) Measuring frequency range from 150KHz to 30MHz.

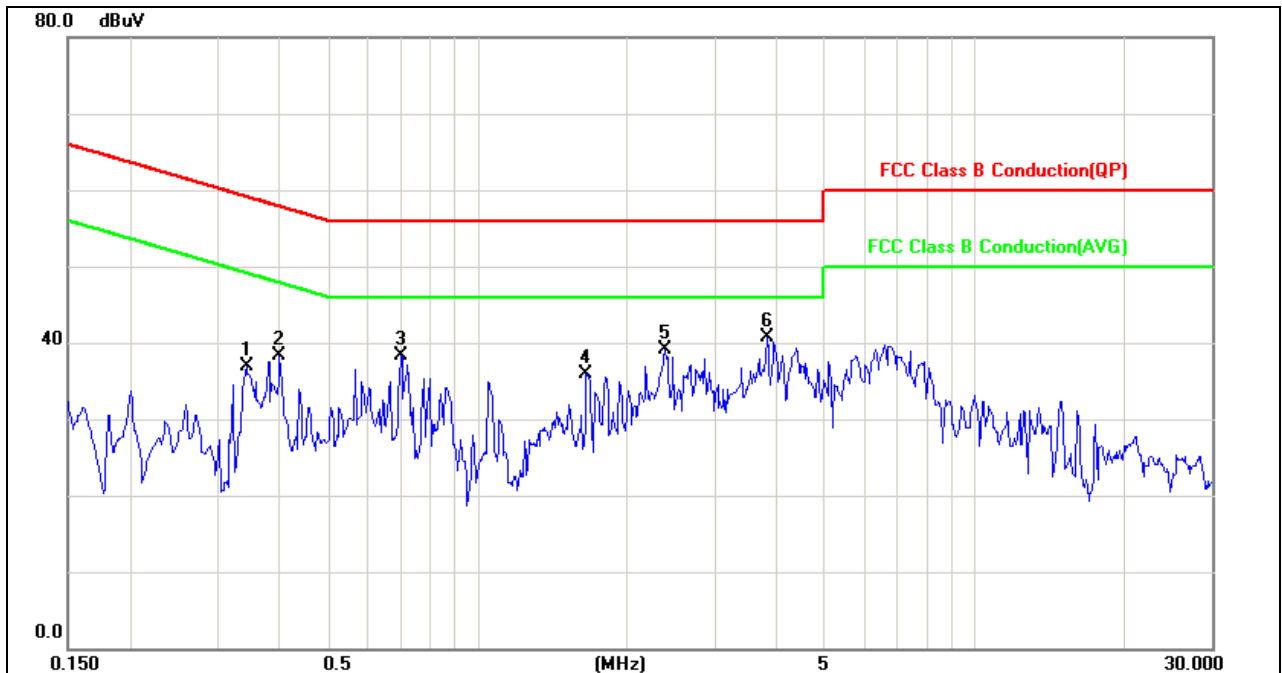





EUT :	150Mbps Wireless N USB Adapter	Model Name :	FWN-651ND
Temperature :	25 °C	Relative Humidity :	58%
Pressure :	1010hPa	Test Power :	AC 120V/60Hz
Test Mode :	TX MODE		

Freq. (MHz)	Terminal L/N	Measured(dBuV)		Limits(dBuV)		Margin (dB)	Note
		QP-Mode	AV-Mode	QP-Mode	AV-Mode		
0.34	Neutral	38.01	*	59.31	49.31	-21.30	(QP)
0.39	Neutral	37.83	*	57.99	47.99	-20.16	(QP)
0.60	Neutral	37.53	*	56.00	46.00	-18.47	(QP)
2.76	Neutral	38.15	*	56.00	46.00	-17.85	(QP)
6.55	Neutral	40.94	*	60.00	50.00	-19.06	(QP)
13.29	Neutral	33.13	*	60.00	50.00	-26.87	(QP)

**Remark**

- (1) All readings are QP Mode value unless otherwise stated AVG in column of Note. If the QP Mode Measured value compliance with the QP Limits and lower than AVG Limits, the EUT shall be deemed to meet both QP & AVG Limits and then only QP Mode was measured, but AVG Mode didn't perform. In this case, a " \* " marked in AVG Mode column of Interference Voltage Measured.
- (2) Measuring frequency range from 150KHz to 30MHz.

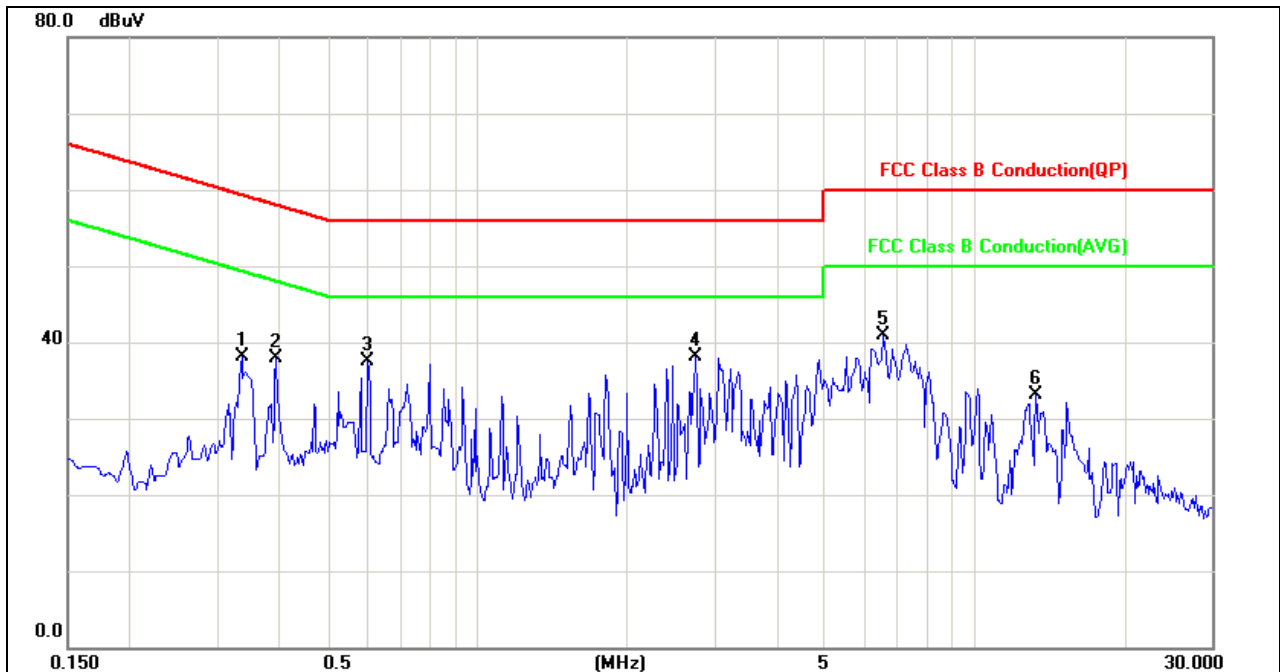



EUT :	150Mbps Wireless N USB Adapter	Model Name :	FWN-651N
Temperature :	25 °C	Relative Humidity :	58%
Pressure :	1010hPa	Test Power :	AC 120V/60Hz
Test Mode :	TX MODE		

Freq. (MHz)	Terminal L/N	Measured(dBuV)		Limits(dBuV)		Margin (dB)	Note
		QP-Mode	AV-Mode	QP-Mode	AV-Mode		
0.26	Line	38.80	*	61.46	51.46	-22.66	(QP)
0.38	Line	37.49	*	58.26	48.26	-20.77	(QP)
0.57	Line	38.08	*	56.00	46.00	-17.92	(QP)
2.39	Line	37.64	*	56.00	46.00	-18.36	(QP)
4.39	Line	41.38	*	56.00	46.00	-14.62	(QP)
10.00	Line	38.11	*	60.00	50.00	-21.89	(QP)

**Remark**

- (1) All readings are QP Mode value unless otherwise stated AVG in column of Note. If the QP Mode Measured value compliance with the QP Limits and lower than AVG Limits, the EUT shall be deemed to meet both QP & AVG Limits and then only QP Mode was measured, but AVG Mode didn't perform. In this case, a " \* " marked in AVG Mode column of Interference Voltage Measured.
- (2) Measuring frequency range from 150KHz to 30MHz.

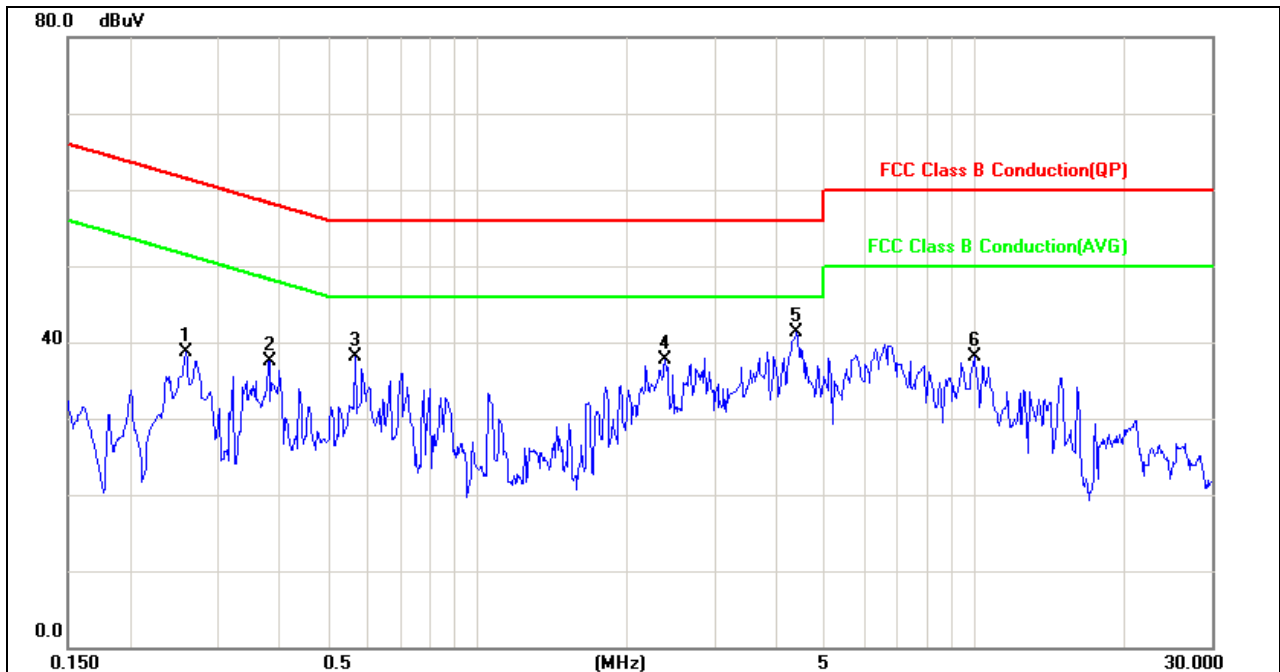



EUT :	150Mbps Wireless N USB Adapter	Model Name :	FWN-651N
Temperature :	25 °C	Relative Humidity :	58%
Pressure :	1010hPa	Test Power :	AC 120V/60Hz
Test Mode :	TX MODE		

Freq. (MHz)	Terminal L/N	Measured(dBuV)		Limits(dBuV)		Margin (dB)	Note
		QP-Mode	AV-Mode	QP-Mode	AV-Mode		
0.32	Neutral	36.88	*	59.84	49.84	-22.96	(QP)
0.58	Neutral	35.37	*	56.00	46.00	-20.63	(QP)
0.94	Neutral	37.56	*	56.00	46.00	-18.44	(QP)
2.76	Neutral	38.15	*	56.00	46.00	-17.85	(QP)
4.85	Neutral	40.30	*	56.00	46.00	-15.70	(QP)
10.15	Neutral	37.37	*	60.00	50.00	-22.63	(QP)

**Remark**

- (1) All readings are QP Mode value unless otherwise stated AVG in column of Note. If the QP Mode Measured value compliance with the QP Limits and lower than AVG Limits, the EUT shall be deemed to meet both QP & AVG Limits and then only QP Mode was measured, but AVG Mode didn't perform. In this case, a "\*" marked in AVG Mode column of Interference Voltage Measured.
- (2) Measuring frequency range from 150KHz to 30MHz.

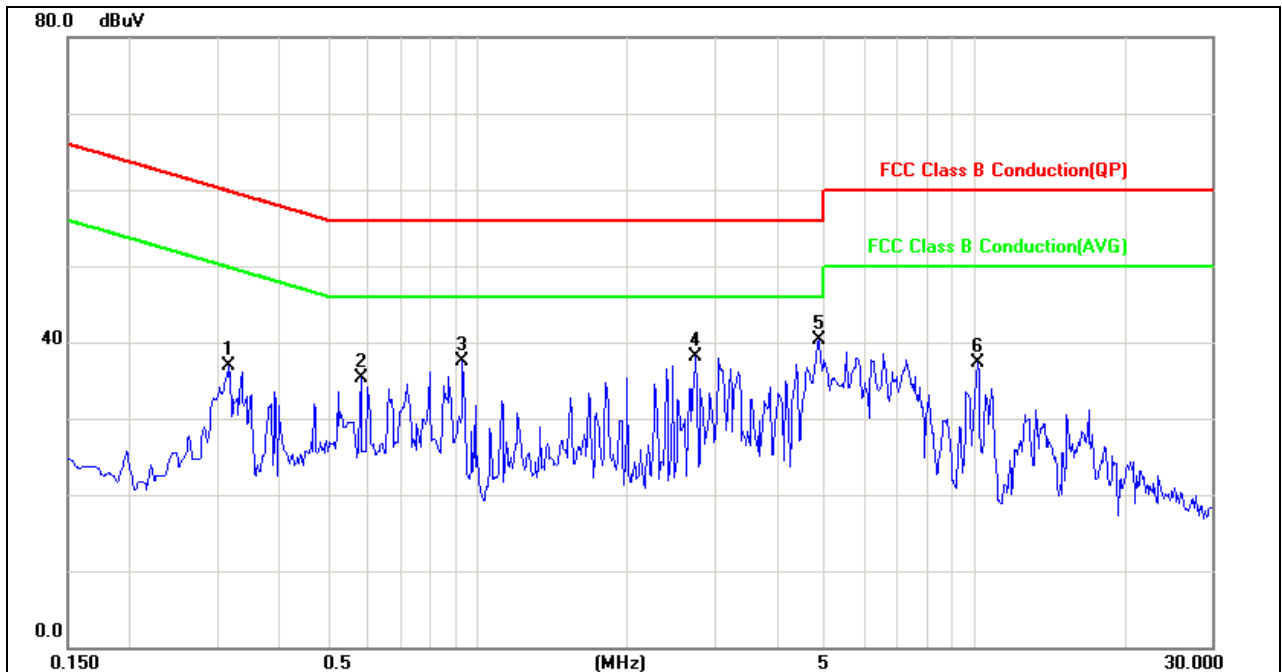



**4.2 RADIATED EMISSION MEASUREMENT**

**4.2.1 RADIATED EMISSION LIMITS (Frequency Range 9KHz-1000MHz)**

20dBc in any 100 kHz bandwidth outside the operating frequency band. In case the emission fall within the restricted band specified on 15.205(a), then the 15.209(a) limit in the table below has to be followed.

Frequencies (MHz)	Field Strength (micorvolts/meter)	Measurement Distance (meters)
0.009~0.490	2400/F(KHz)	300
0.490~1.705	24000/F(KHz)	30
1.705~30.0	30	30
30~88	100	3
88~216	150	3
216~960	200	3
Above 960	500	3

**LIMITS OF RADIATED EMISSION MEASUREMENT (Above 1000MHz)**

FREQUENCY (MHz)	(dBuV/m) (at 3m)	
	PEAK	AVERAGE
Above 1000	74	54

Notes:

- (1) The limit for radiated test was performed according to FCC PART 15C.
- (2) The tighter limit applies at the band edges.
- (3) Emission level (dBuV/m)=20log Emission level (uV/m).

**FREQUENCY RANGE OF RADIATED MEASUREMENT (For unintentional radiators)**

Highest frequency generated or Upper frequency of measurement used in the device or on which the device operates or tunes (MHz)	Range (MHz)
Below 1.705	30
1.705 – 108	1000
108 – 500	2000
500 – 1000	5000
Above 1000	5 <sup>th</sup> harmonic of the highest frequency or 40 GHz, whichever is lower



**4.2.2 MEASUREMENT INSTRUMENTS LIST AND SETTING**

Item	Kind of Equipment	Manufacturer	Type No.	Serial No.	Calibrated until
1	Antenna	Schwarzbeck	VULB9160	9160-3232	Jun .04.2012
2	Amplifier	HP	8447D	2944A09673	May.26.2012
3	Test Receiver	R&S	ESCI	100382	May.26.2012
4	Test Cable	N/A	C-01_CB03	N/A	Jul.01.2012
5	Antenna	ETS	3115	00075789	May.26.2012
6	Amplifier	Agilent	8449B	3008A02274	May.26.2012
7	Spectrum	Agilent	E4408B	US39240143	Nov.25.2012
8	Test Cable	HUBER+SUHNER	C-45	N/A	May.04.2012
9	Controller	CT	SC100	N/A	N/A
10	Active Loop Antenna	R&S	HFH2-Z2	830749/020	May.26.2012
11	Broad-Band Horn Antenna	Schwarzbeck	BBHA 9170	9170319	Oct.13.2012

Remark: " N/A" denotes No Model Name / Serial No. and No Calibration specified.

Spectrum Parameter	Setting
Attenuation	Auto
Start Frequency	1000 MHz
Stop Frequency	10th carrier harmonic
RB / VB (Emission in restricted band)	1MHz / 1MHz for Peak, 1 MHz / 10Hz for Average

Receiver Parameter	Setting
Attenuation	Auto
Start ~ Stop Frequency	9kHz~150kHz / RB 200Hz for QP
Start ~ Stop Frequency	150kHz~30MHz / RB 9kHz for QP
Start ~ Stop Frequency	30MHz~1000MHz / RB 120kHz for QP



#### **4.2.3 TEST PROCEDURE**

- a. The measuring distance of at 3 m shall be used for measurements at frequency up to 1GHz. For frequencies above 1GHz, any suitable measuring distance may be used.
- b. The EUT was placed on the top of a rotating table 0.8 meters above the ground at a 3 meter semi-anechoic chamber. The table was rotated 360 degrees to determine the position of the highest radiation.
- c. The height of the equipment or of the substitution antenna shall be 0.8 m; the height of the test antenna shall vary between 1 m to 4 m. Both horizontal and vertical polarizations of the antenna are set to make the measurement.
- d. The initial step in collecting conducted emission data is a spectrum analyzer peak detector mode pre-scanning the measurement frequency range. Significant peaks are then marked and then Quasi Peak detector mode re-measured.
- e. If the Peak Mode measured value compliance with and lower than Quasi Peak Mode Limit, the EUT shall be deemed to meet QP Limits and then no additional QP Mode measurement performed.
- f. For the actual test configuration, please refer to the related Item –EUT Test Photos.

#### **4.2.4 DEVIATION FROM TEST STANDARD**

No deviation

**4.2.5 TEST SETUP**

(A) Radiated Emission Test Set-Up Frequency Below 1 GHz

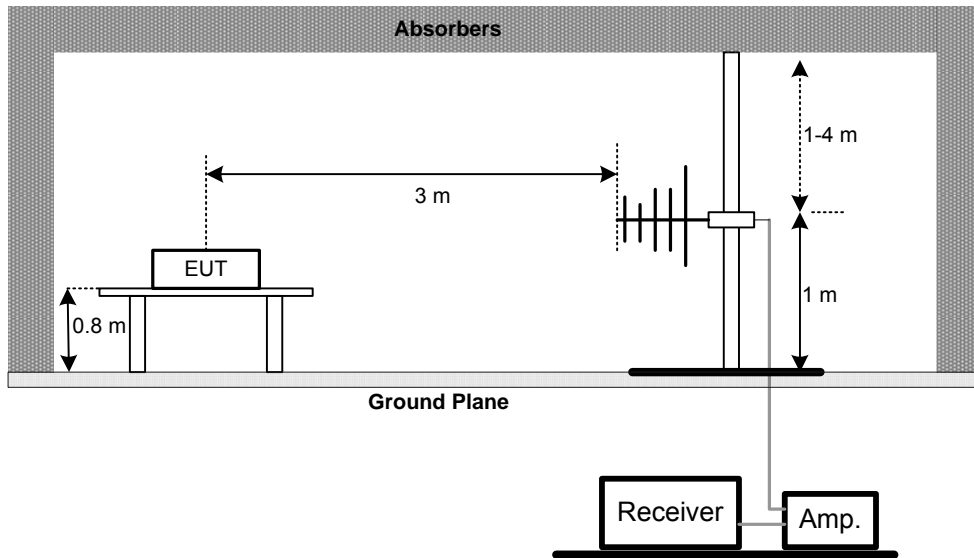

(B) Radiated Emission Test Set-Up Frequency Above 1 GHz

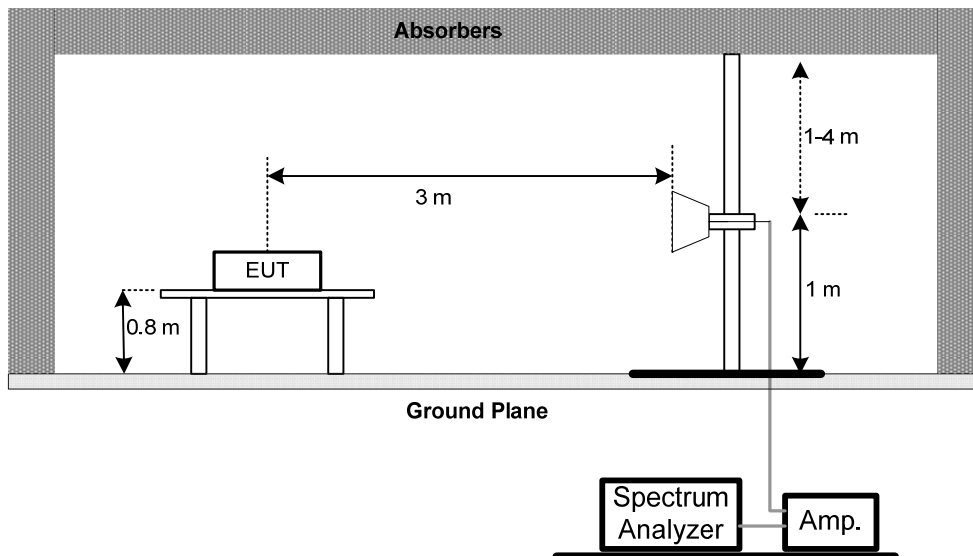

**4.2.6 EUT OPERATING CONDITIONS**

The EUT tested system was configured as the statements of 4.1.6 Unless otherwise a special operating condition is specified in the follows during the testing.



**4.2.7 TEST RESULTS (BETWEEN 30 – 1000 MHZ)**

EUT :	150Mbps Wireless N USB Adapter	Model Name :	FWN-651ND
Temperature :	25 °C	Relative Humidity :	58 %
Pressure :	1010 hPa	Test Voltage :	AC 120V/60Hz
Test Mode :	TX B MODE 2412MHZ		

Freq. (MHz)	Ant. HV	Reading(RA) (dBuV)	Corr.Factor(CF) (dB)	Measured(FS) (dBuV/m)	Limits(QP) (dBuV/m)	Margin (dB)	Note
86.26	V	43.80	-19.10	24.70	40.00	- 15.30	
136.65	V	42.36	-17.86	24.50	43.50	- 19.00	
189.67	V	45.64	-16.73	28.91	43.50	- 14.59	
213.60	V	43.82	-16.15	27.67	43.50	- 15.83	
287.69	V	42.65	-12.19	30.46	46.00	- 15.54	
401.33	V	40.93	-8.99	31.94	46.00	- 14.06	

Remark :

- (1) Reading in which marked as QP or Peak means measurements by using are Quasi-Peak Mode or Peak Mode with Detector BW=120KHz ; SPA setting in RBW=120KHz, VBW =120KHz, Swp. Time = 0.3 sec./MHz ◦
- (2) All readings are Peak unless otherwise stated QP in column of 『 Note 』 . Peak denotes that the Peak reading compliance with the QP Limits and then QP Mode measurement didn't perform ◦
- (3) Measuring frequency range from 30MHz to 1000MHz ◦
- (4) If the peak scan value lower limit more than 20dB, then this signal data does not show in table ◦

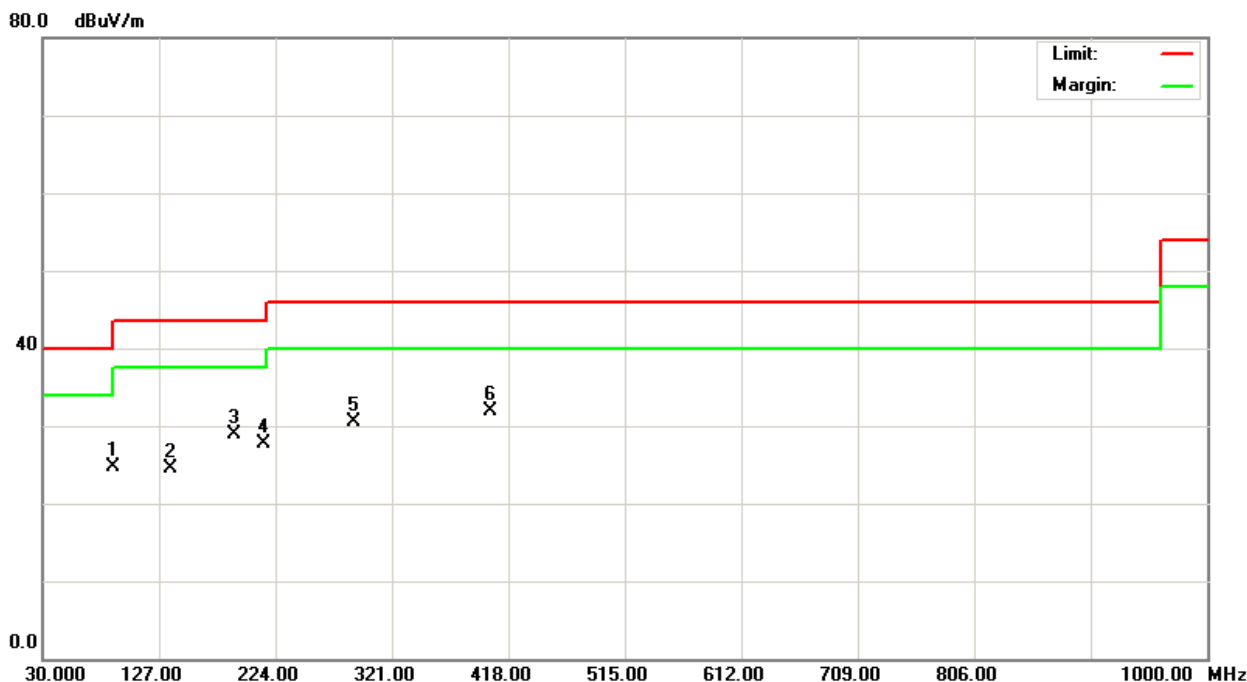





EUT :	150Mbps Wireless N USB Adapter	Model Name :	FWN-651ND
Temperature :	25 °C	Relative Humidity :	58 %
Pressure :	1010 hPa	Test Voltage :	AC 120V/60Hz
Test Mode :	TX B MODE 2412MHz		

Freq. (MHz)	Ant. H/V	Reading(RA) (dBuV)	Corr.Factor(CF) (dB)	Measured(FS) (dBuV/m)	Limits(QP) (dBuV/m)	Margin (dB)	Note
104.23	H	43.29	-18.39	24.90	43.50	- 18.60	
162.38	H	39.96	-17.57	22.39	43.50	- 21.11	
213.66	H	39.65	-16.13	23.52	43.50	- 19.98	
286.30	H	38.60	-12.27	26.33	46.00	- 19.67	
329.50	H	41.55	-11.34	30.21	46.00	- 15.79	
418.40	H	37.23	-8.69	28.54	46.00	- 17.46	

**Remark :**

- (1) Reading in which marked as QP or Peak means measurements by using are Quasi-Peak Mode or Peak Mode with Detector BW=120KHz ; SPA setting in RBW=120KHz, VBW =120KHz, Swp. Time = 0.3 sec./MHz .
- (2) All readings are Peak unless otherwise stated QP in column of 『 Note 』 . Peak denotes that the Peak reading compliance with the QP Limits and then QP Mode measurement didn't perform .
- (3) Measuring frequency range from 30MHz to 1000MHz .
- (4) If the peak scan value lower limit more than 20dB, then this signal data does not show in table .

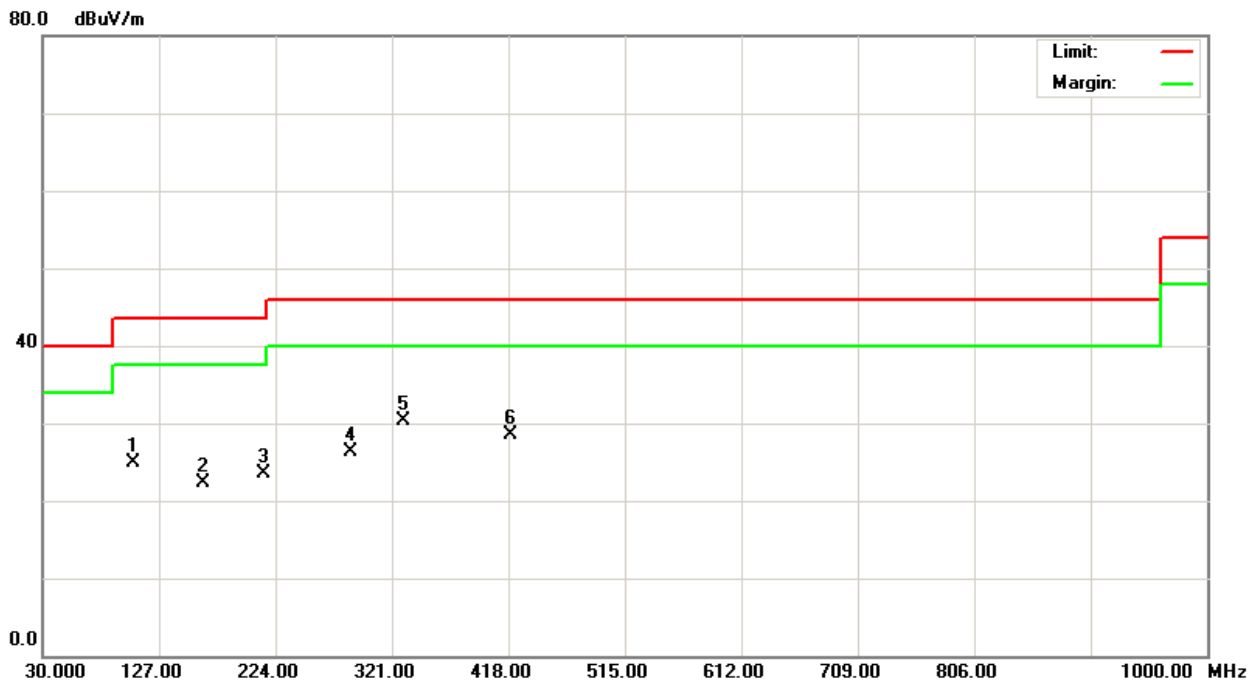



EUT :	150Mbps Wireless N USB Adapter	Model Name :	FWN-651N
Temperature :	25 °C	Relative Humidity :	58 %
Pressure :	1010 hPa	Test Voltage :	AC 120V/60Hz
Test Mode :	TX B MODE 2412MHz		

Freq. (MHz)	Ant. H/V	Reading(RA) (dBuV)	Corr.Factor(CF) (dB)	Measured(FS) (dBuV/m)	Limits(QP) (dBuV/m)	Margin (dB)	Note
82.66	V	42.29	-19.09	23.20	40.00	- 16.80	
157.26	V	41.89	-17.63	24.26	43.50	- 19.24	
242.25	V	44.27	-15.04	29.23	46.00	- 16.77	
289.49	V	37.74	-12.08	25.66	46.00	- 20.34	
341.32	V	38.80	-11.05	27.75	46.00	- 18.25	
432.63	V	40.87	-8.43	32.44	46.00	- 13.56	

**Remark :**

- (1) Reading in which marked as QP or Peak means measurements by using are Quasi-Peak Mode or Peak Mode with Detector BW=120KHz ; SPA setting in RBW=120KHz, VBW =120KHz, Swp. Time = 0.3 sec./MHz ◦
- (2) All readings are Peak unless otherwise stated QP in column of 『Note』 . Peak denotes that the Peak reading compliance with the QP Limits and then QP Mode measurement didn't perform ◦
- (3) Measuring frequency range from 30MHz to 1000MHz ◦
- (4) If the peak scan value lower limit more than 20dB, then this signal data does not show in table ◦

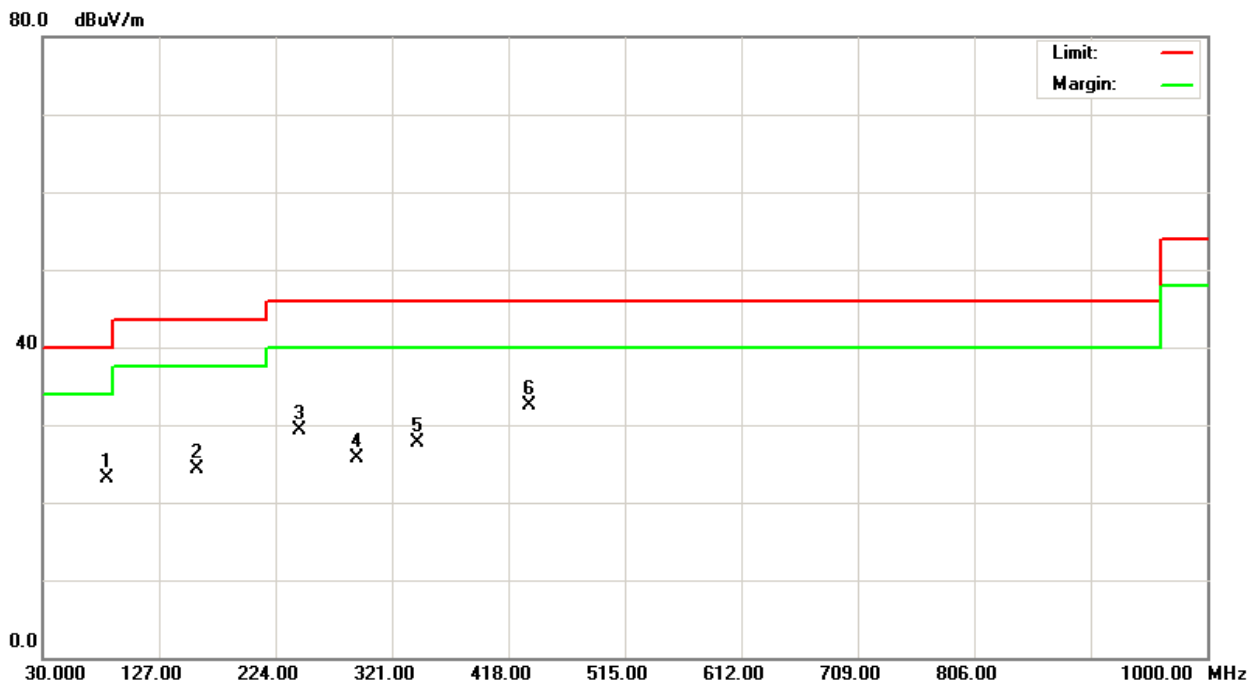



EUT :	150Mbps Wireless N USB Adapter	Model Name :	FWN-651N
Temperature :	25 °C	Relative Humidity :	58 %
Pressure :	1010 hPa	Test Voltage :	AC 120V/60Hz
Test Mode :	TX B MODE 2412MHz		

Freq. (MHz)	Ant. H/V	Reading(RA) (dBuV)	Corr.Factor(CF) (dB)	Measured(FS) (dBuV/m)	Limits(QP) (dBuV/m)	Margin (dB)	Note
51.69	H	40.60	-17.50	23.10	40.00	- 16.90	
92.35	H	38.66	-18.80	19.86	43.50	- 23.64	
153.60	H	39.68	-17.58	22.10	43.50	- 21.40	
226.85	H	41.68	-15.68	26.00	46.00	- 20.00	
276.19	H	42.76	-12.89	29.87	46.00	- 16.13	
314.20	H	43.86	-11.72	32.14	46.00	- 13.86	

Remark :

- (1) Reading in which marked as QP or Peak means measurements by using are Quasi-Peak Mode or Peak Mode with Detector BW=120KHz ; SPA setting in RBW=120KHz, VBW =120KHz, Swp. Time = 0.3 sec./MHz .
- (2) All readings are Peak unless otherwise stated QP in column of 『Note 』 . Peak denotes that the Peak reading compliance with the QP Limits and then QP Mode measurement didn't perform .
- (3) Measuring frequency range from 30MHz to 1000MHz .
- (4) If the peak scan value lower limit more than 20dB, then this signal data does not show in table .

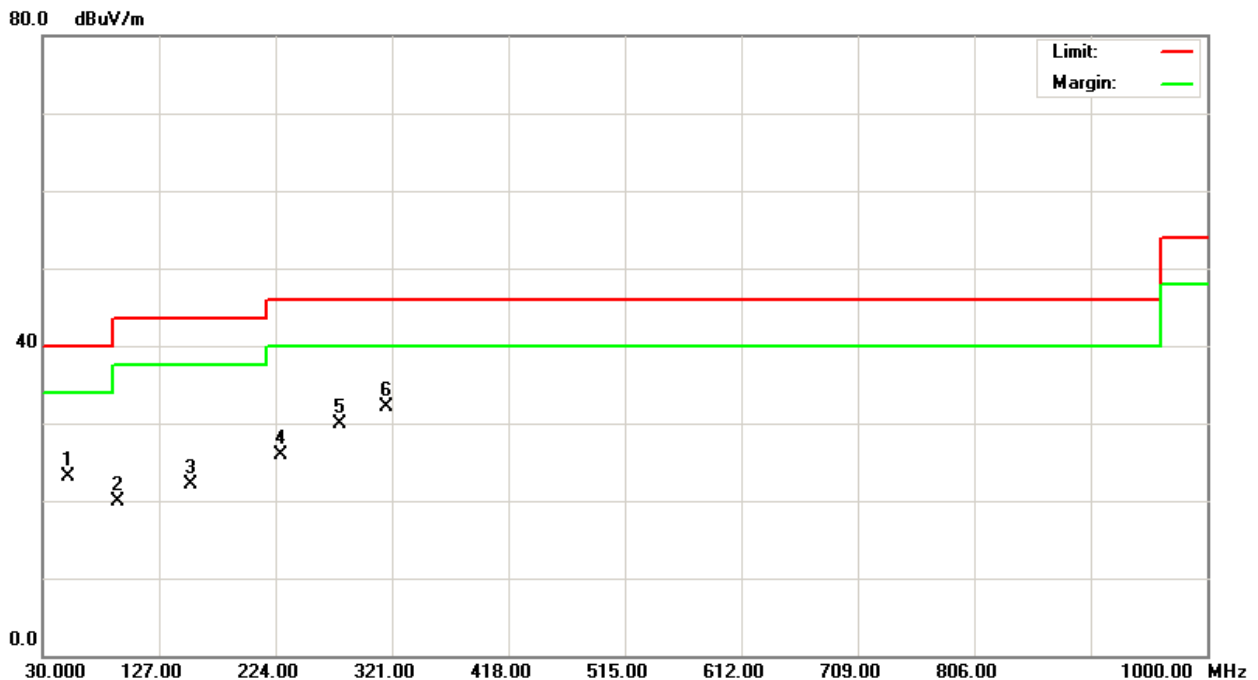



**4.2.8 TEST RESULTS (ABOVE 1000 MHZ)- FWN-651ND**

EUT :	150Mbps Wireless N USB Adapter	Model Name :	FWN-651ND
Temperature :	25 °C	Relative Humidity :	58 %
Pressure :	1010 hPa	Test Voltage :	AC 120V/60Hz
Test Mode :	TX B MODE 2412MHz		

Freq. (MHz)	Ant.Pol. H/V	Reading		Ant./CF CF(dB)	Act.		Limit		Note
		Peak (dBuV)	AV (dBuV)		Peak (dBuV/m)	AV (dBuV/m)	Peak (dBuV/m)	AV (dBuV/m)	
2390.00	V	21.28	12.68	31.91	53.19	44.59	74.00	54.00	X/E
<b>2411.00</b>	<b>V</b>	<b>71.28</b>	<b>67.89</b>	<b>31.89</b>	<b>103.17</b>	<b>99.78</b>			<b>X/F</b>
4824.17	V	45.21	34.96	5.29	50.50	40.25	74.00	54.00	X/H

Remark :

- (1) All readings are Peak unless otherwise stated QP in column of 『Note』 . Peak denotes that the Peak reading compliance with the QP Limits and then QP Mode measurement didn't perform .
- (2) Measuring frequency range from 30MHz to 1000MHz or the 10th harmonic of highest fundamental frequency . "F" denotes fundamental frequency; "H" denotes spurious frequency. "E" denotes band edge frequency. (This judgment method includes the Band Edge Requirement.)
- (3) Radiated emissions measured in frequency range above 1000MHz were made with an instrument using Peak detector mode and AV detector mode of the emission .
- (4) Data of measurement within this frequency range shown " \* " in the table above means the reading of emissions are attenuated more than 20dB below the permissible limits or the field strength is too small to be measured.
- (5) A preamp and high pass filter were used for this test in order to provide sufficient measurement sensitivity.
- (6) EUT Orthogonal Axis :  
"X" - denotes Laid on Table ; "Y" - denotes Vertical Stand ; "Z" - denotes Side Stand
- (7) During the measurements above 1 GHz it is taken care of that the EUT is always within the 3 dB cone of radiation BW of the used antenna



TX CH01 (Above 1000 MHz, Vertical)

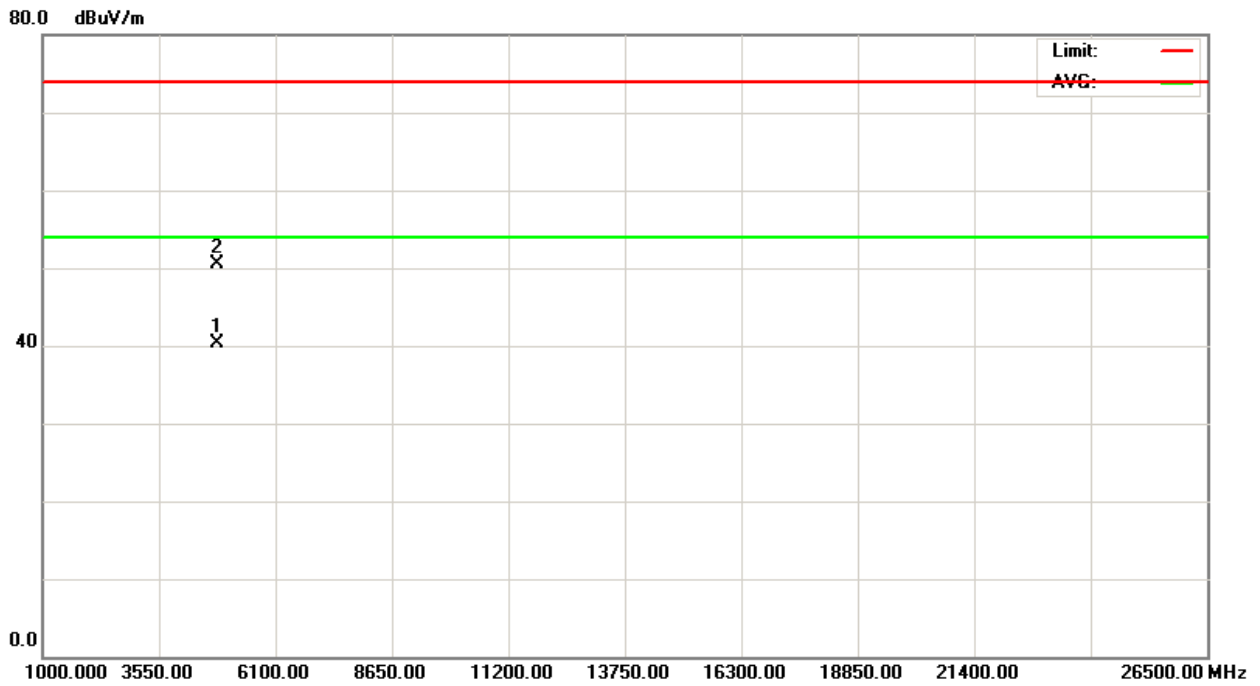
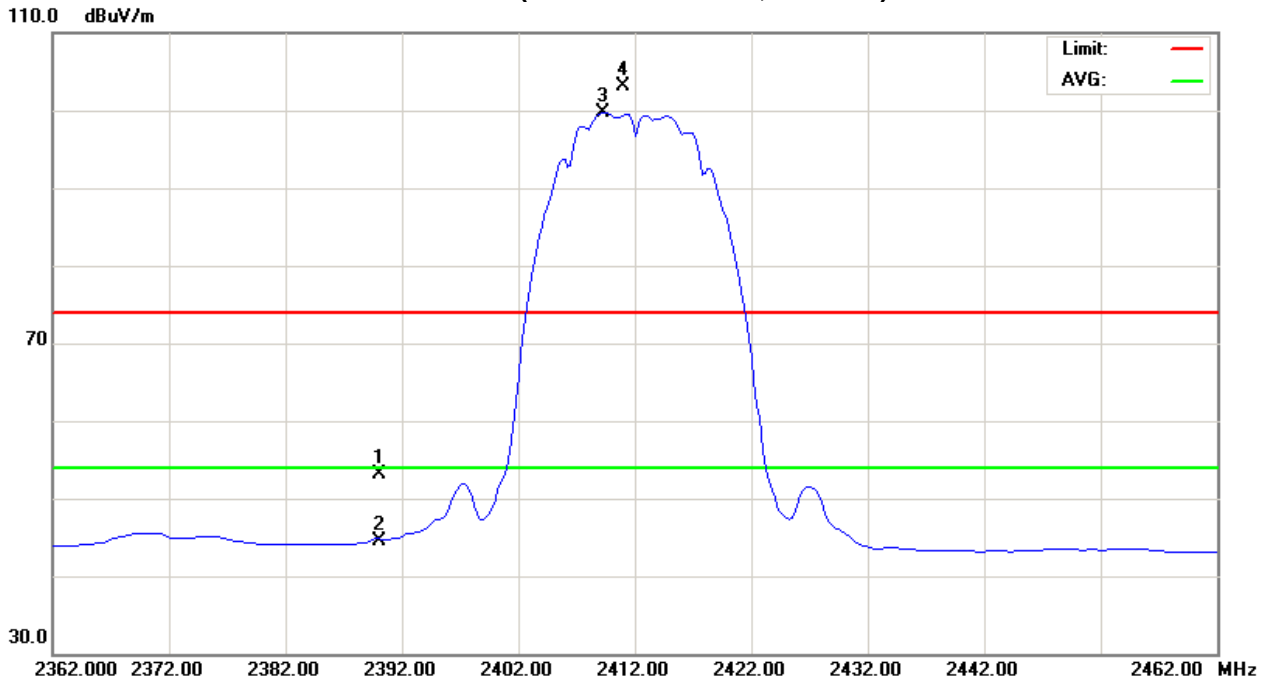



EUT :	150Mbps Wireless N USB Adapter	Model Name :	FWN-651ND
Temperature :	25 °C	Relative Humidity :	58 %
Pressure :	1010 hPa	Test Voltage :	AC 120V/60Hz
Test Mode :	TX B MODE 2412MHz		

Freq. (MHz)	Ant.Pol. H/V	Reading		Ant./CF CF(dB)	Act.		Limit		Note
		Peak (dBuV)	AV (dBuV)		Peak (dBuV/m)	AV (dBuV/m)	Peak (dBuV/m)	AV (dBuV/m)	
2390.00	H	19.40	11.36	31.91	51.31	43.27	74.00	54.00	X/E
<b>2413.00</b>	<b>H</b>	<b>59.80</b>	<b>56.47</b>	<b>31.88</b>	<b>91.68</b>	<b>88.35</b>			<b>X/F</b>
4824.10	H	43.88	33.13	5.29	49.17	38.42	74.00	54.00	X/H

Remark :

- (1) All readings are Peak unless otherwise stated QP in column of 『Note』 . Peak denotes that the Peak reading compliance with the QP Limits and then QP Mode measurement didn't perform .
- (2) Measuring frequency range from 30MHz to 1000MHz or the 10th harmonic of highest fundamental frequency . "F" denotes fundamental frequency; "H" denotes spurious frequency. "E" denotes band edge frequency. (This judgment method includes the Band Edge Requirement.)
- (3) Radiated emissions measured in frequency range above 1000MHz were made with an instrument using Peak detector mode and AV detector mode of the emission .
- (4) Data of measurement within this frequency range shown " \* " in the table above means the reading of emissions are attenuated more than 20dB below the permissible limits or the field strength is too small to be measured.
- (5) A preamp and high pass filter were used for this test in order to provide sufficient measurement sensitivity.
- (6) EUT Orthogonal Axis :  
"X" - denotes Laid on Table ; "Y" - denotes Vertical Stand ; "Z" - denotes Side Stand
- (7) During the measurements above 1 GHz it is taken care of that the EUT is always within the 3 dB cone of radiation BW of the used antenna



TX CH01 (Above 1000 MHz, Horizontal)

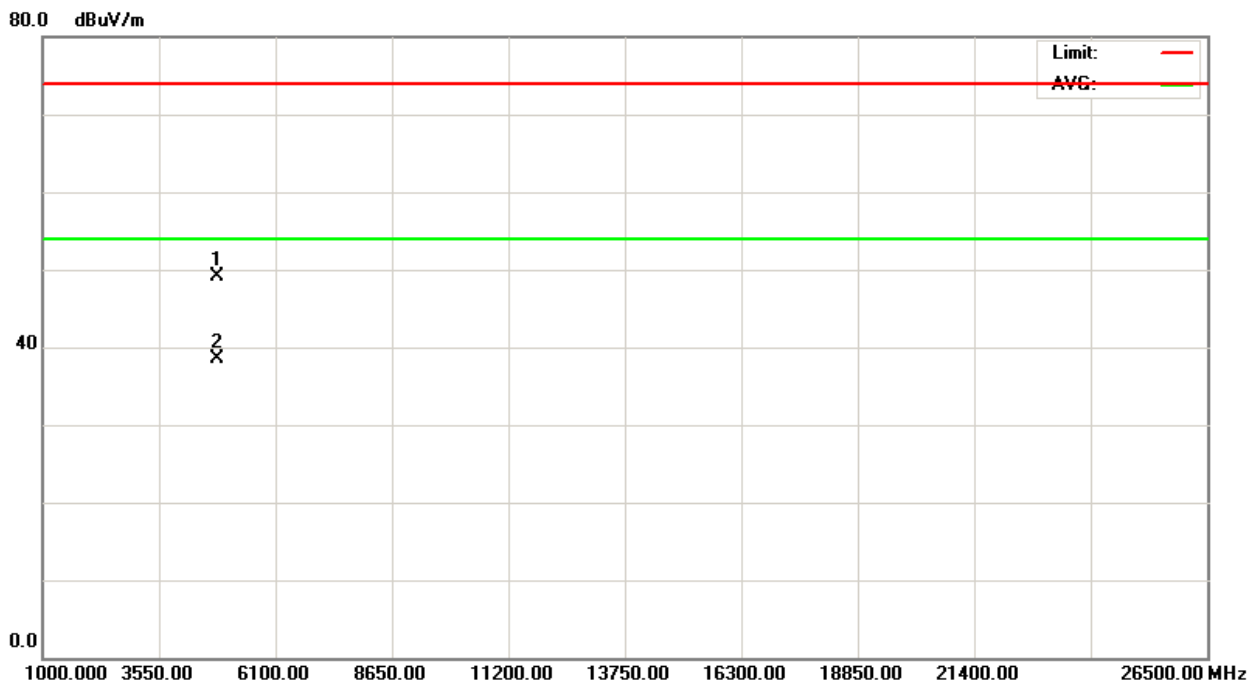
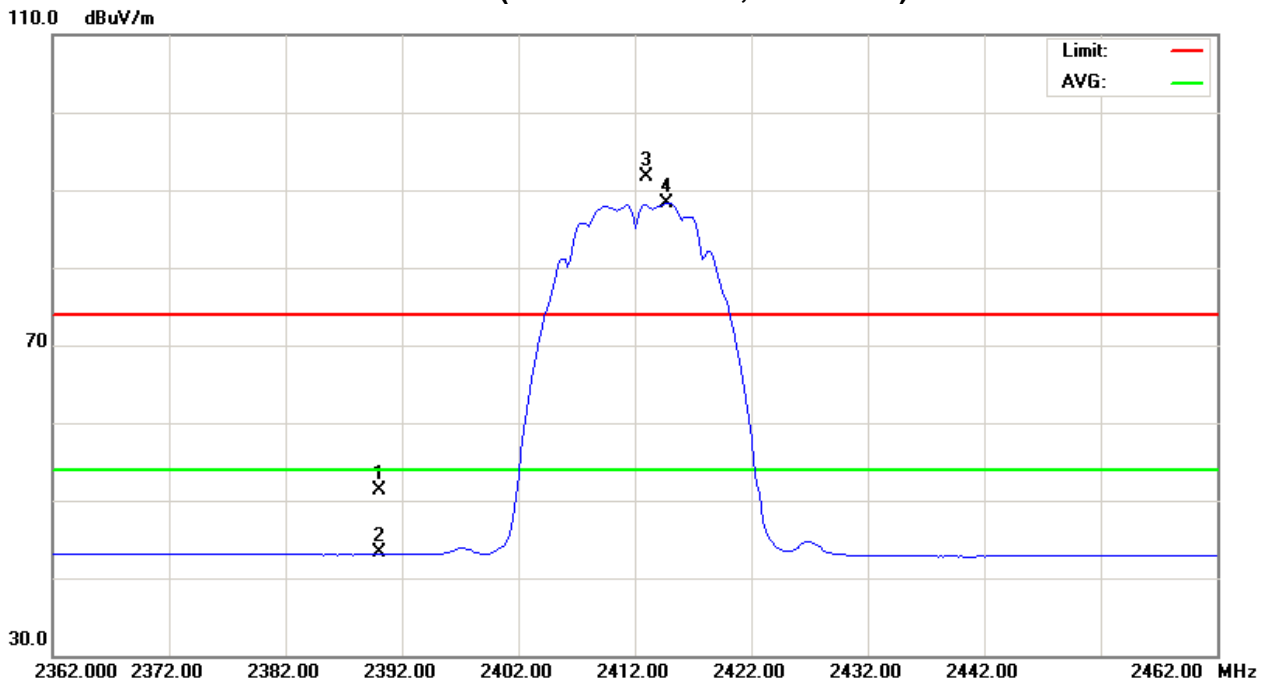



EUT :	150Mbps Wireless N USB Adapter	Model Name :	FWN-651ND
Temperature :	25 °C	Relative Humidity :	58 %
Pressure :	1010 hPa	Test Voltage :	AC 120V/60Hz
Test Mode :	TX B MODE 2437MHz		

Freq.	Ant.Pol.	Reading		Ant./CF	Act.		Limit		Note
		Peak	AV		Peak	AV	Peak	AV	
(MHz)	H/V	(dBuV)	(dBuV)	CF(dB)	(dBuV/m)	(dBuV/m)	(dBuV/m)	(dBuV/m)	
<b>2434.25</b>	<b>V</b>	<b>66.81</b>	<b>63.49</b>	<b>31.86</b>	<b>98.67</b>	<b>95.35</b>			<b>X/F</b>
4874.23	V	44.37	33.65	5.47	49.84	39.12	74.00	54.00	X/H

Remark :

- (1) All readings are Peak unless otherwise stated QP in column of 『 Note 』 . Peak denotes that the Peak reading compliance with the QP Limits and then QP Mode measurement didn't perform ◦
- (2) Measuring frequency range from 30MHz to 1000MHz or the 10th harmonic of highest fundamental frequency ◦ “F” denotes fundamental frequency; “H” denotes spurious frequency. “E” denotes band edge frequency. (This judgment method includes the Band Edge Requirement.)
- (3) Radiated emissions measured in frequency range above 1000MHz were made with an instrument using Peak detector mode and AV detector mode of the emission ◦
- (4) Data of measurement within this frequency range shown “ \* ” in the table above means the reading of emissions are attenuated more than 20dB below the permissible limits or the field strength is too small to be measured.
- (5) A preamp and high pass filter were used for this test in order to provide sufficient measurement sensitivity.
- (6) EUT Orthogonal Axis :  
 “X” - denotes Laid on Table ; “Y” - denotes Vertical Stand ; “Z” - denotes Side Stand
- (7) During the measurements above 1 GHz it is taken care of that the EUT is always within the 3 dB cone of radiation BW of the used antenna





TX CH06 (Above 1000 MHz, Vertical)

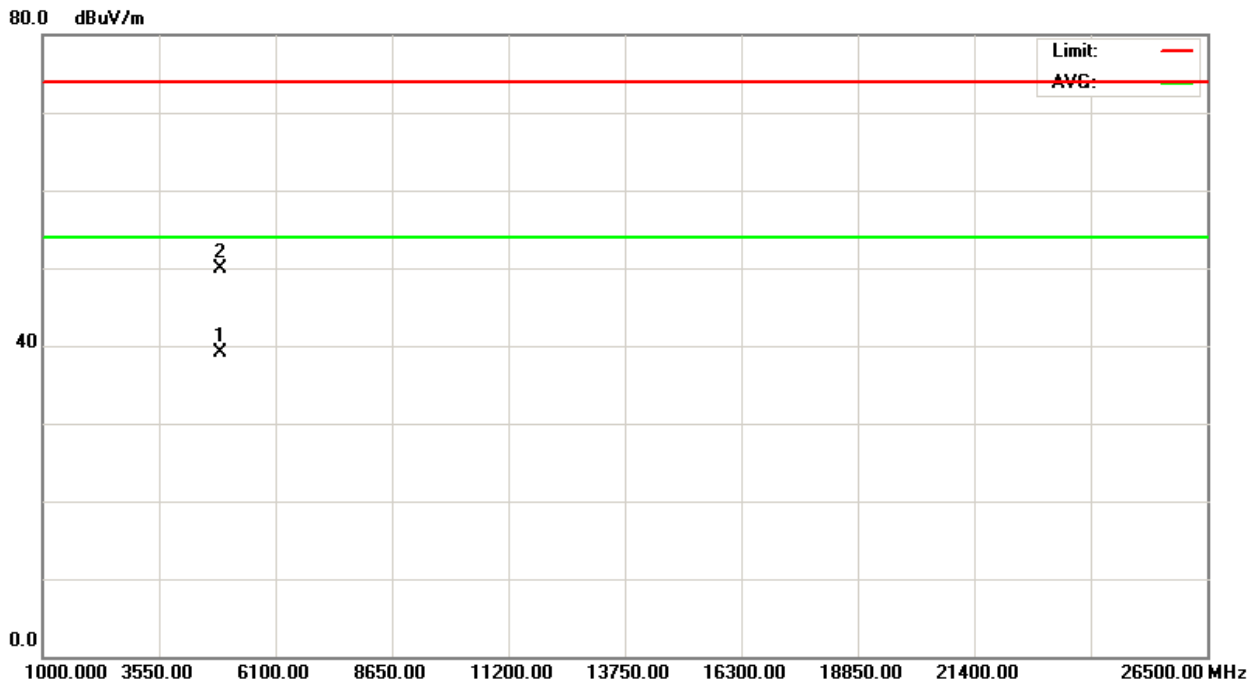
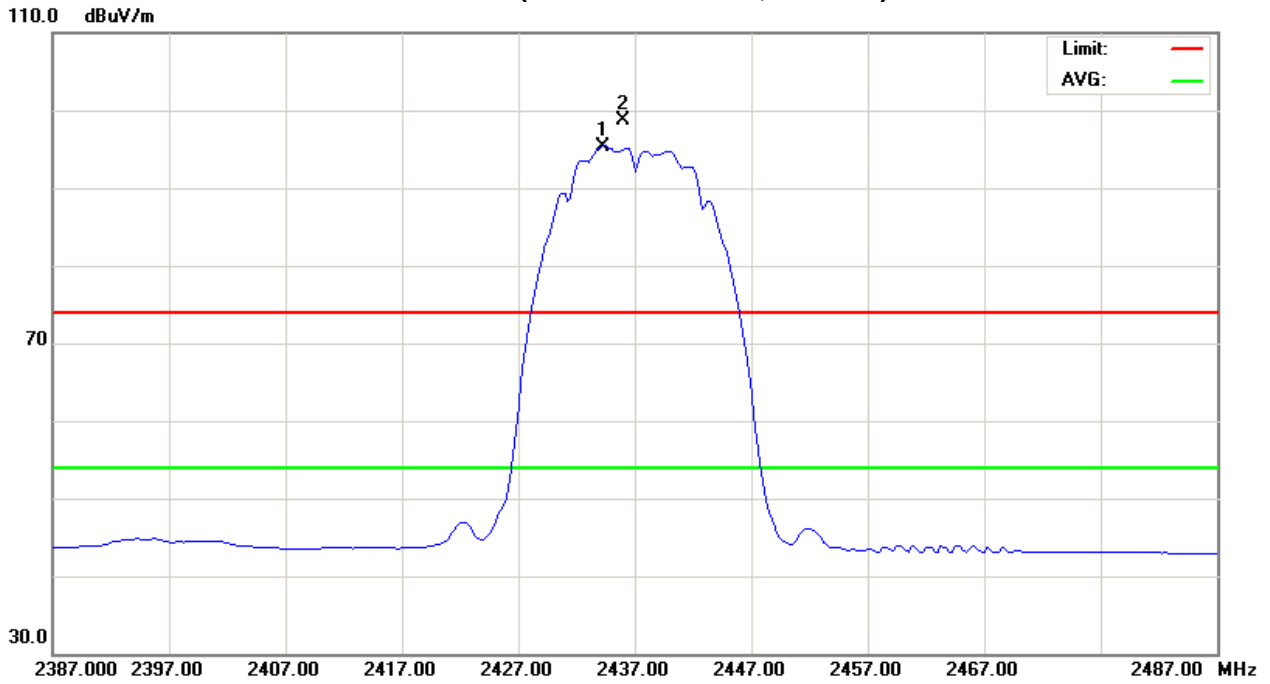



EUT :	150Mbps Wireless N USB Adapter	Model Name :	FWN-651ND
Temperature :	25 °C	Relative Humidity :	58 %
Pressure :	1010 hPa	Test Voltage :	AC 120V/60Hz
Test Mode :	TX B MODE 2437MHz		

Freq.	Ant.Pol.	Reading		Ant./CF	Act.		Limit		Note
		Peak	AV		Peak	AV	Peak	AV	
(MHz)	H/V	(dBuV)	(dBuV)	CF(dB)	(dBuV/m)	(dBuV/m)	(dBuV/m)	(dBuV/m)	
<b>2435.25</b>	<b>H</b>	<b>56.13</b>	<b>52.72</b>	<b>31.86</b>	<b>87.99</b>	<b>84.58</b>			<b>X/F</b>
4874.14	H	44.15	33.50	5.47	49.62	38.97	74.00	54.00	X/H

Remark :

- (1) All readings are Peak unless otherwise stated QP in column of 『Note』 . Peak denotes that the Peak reading compliance with the QP Limits and then QP Mode measurement didn't perform .
- (2) Measuring frequency range from 30MHz to 1000MHz or the 10th harmonic of highest fundamental frequency . "F" denotes fundamental frequency; "H" denotes spurious frequency. "E" denotes band edge frequency. (This judgment method includes the Band Edge Requirement.)
- (3) Radiated emissions measured in frequency range above 1000MHz were made with an instrument using Peak detector mode and AV detector mode of the emission .
- (4) Data of measurement within this frequency range shown " \* " in the table above means the reading of emissions are attenuated more than 20dB below the permissible limits or the field strength is too small to be measured.
- (5) A preamp and high pass filter were used for this test in order to provide sufficient measurement sensitivity.
- (6) EUT Orthogonal Axis :  
 "X" - denotes Laid on Table ; "Y" - denotes Vertical Stand ; "Z" - denotes Side Stand
- (7) During the measurements above 1 GHz it is taken care of that the EUT is always within the 3 dB cone of radiation BW of the used antenna



TX CH06 (Above 1000 MHz, Horizontal)

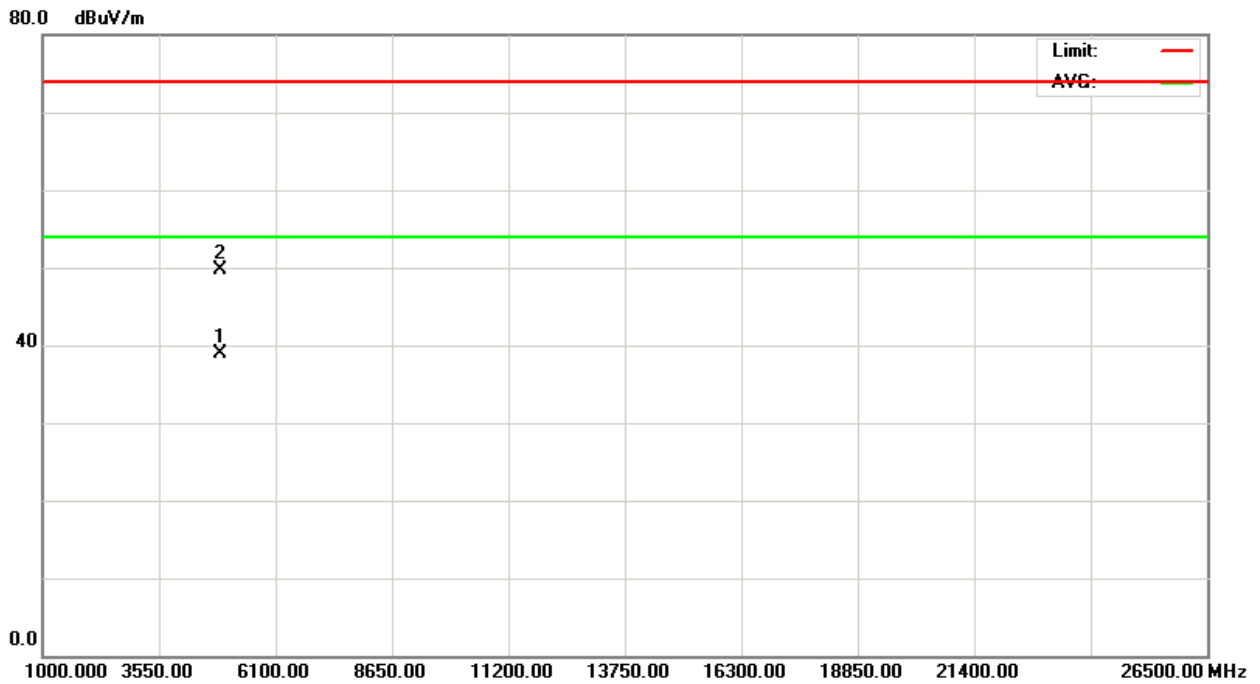
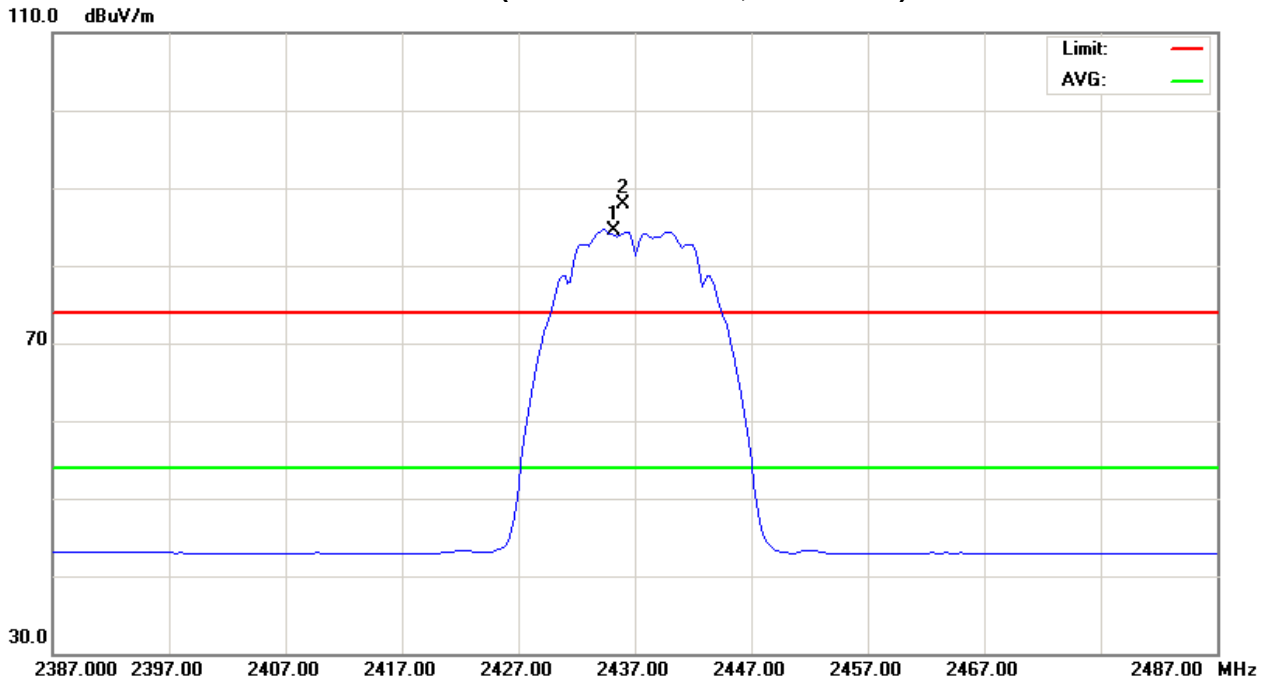



EUT :	150Mbps Wireless N USB Adapter	Model Name :	FWN-651ND
Temperature :	25 °C	Relative Humidity :	58 %
Pressure :	1010 hPa	Test Voltage :	AC 120V/60Hz
Test Mode :	TX B MODE 2462MHz		

Freq.	Ant.Pol.	Reading		Ant./CF	Act.		Limit		Note
		Peak	AV		Peak	AV	Peak	AV	
(MHz)	H/V	(dBuV)	(dBuV)	CF(dB)	(dBuV/m)	(dBuV/m)	(dBuV/m)	(dBuV/m)	
<b>2459.25</b>	<b>V</b>	<b>66.34</b>	<b>62.91</b>	<b>31.83</b>	<b>98.17</b>	<b>94.74</b>			<b>X/F</b>
2483.50	V	22.53	11.30	31.80	54.33	43.10	74.00	54.00	X/E
4924.10	V	49.64	46.29	5.65	55.29	51.94	74.00	54.00	X/H

Remark :

- (1) All readings are Peak unless otherwise stated QP in column of 『Note』 . Peak denotes that the Peak reading compliance with the QP Limits and then QP Mode measurement didn't perform .
- (2) Measuring frequency range from 30MHz to 1000MHz or the 10th harmonic of highest fundamental frequency . "F" denotes fundamental frequency; "H" denotes spurious frequency. "E" denotes band edge frequency. (This judgment method includes the Band Edge Requirement.)
- (3) Radiated emissions measured in frequency range above 1000MHz were made with an instrument using Peak detector mode and AV detector mode of the emission .
- (4) Data of measurement within this frequency range shown " \* " in the table above means the reading of emissions are attenuated more than 20dB below the permissible limits or the field strength is too small to be measured.
- (5) A preamp and high pass filter were used for this test in order to provide sufficient measurement sensitivity.
- (6) EUT Orthogonal Axis :  
 "X" - denotes Laid on Table ; "Y" - denotes Vertical Stand ; "Z" - denotes Side Stand
- (7) During the measurements above 1 GHz it is taken care of that the EUT is always within the 3 dB cone of radiation BW of the used antenna



TX CH11 (Above 1000 MHz, Vertical)

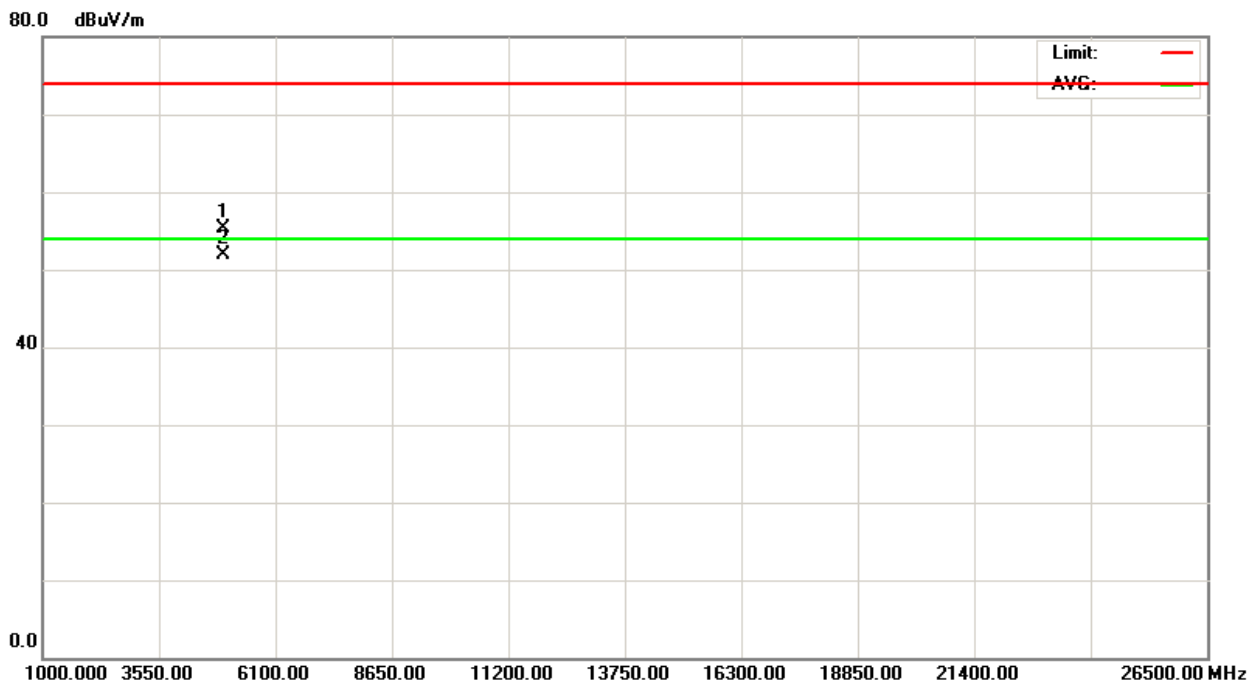
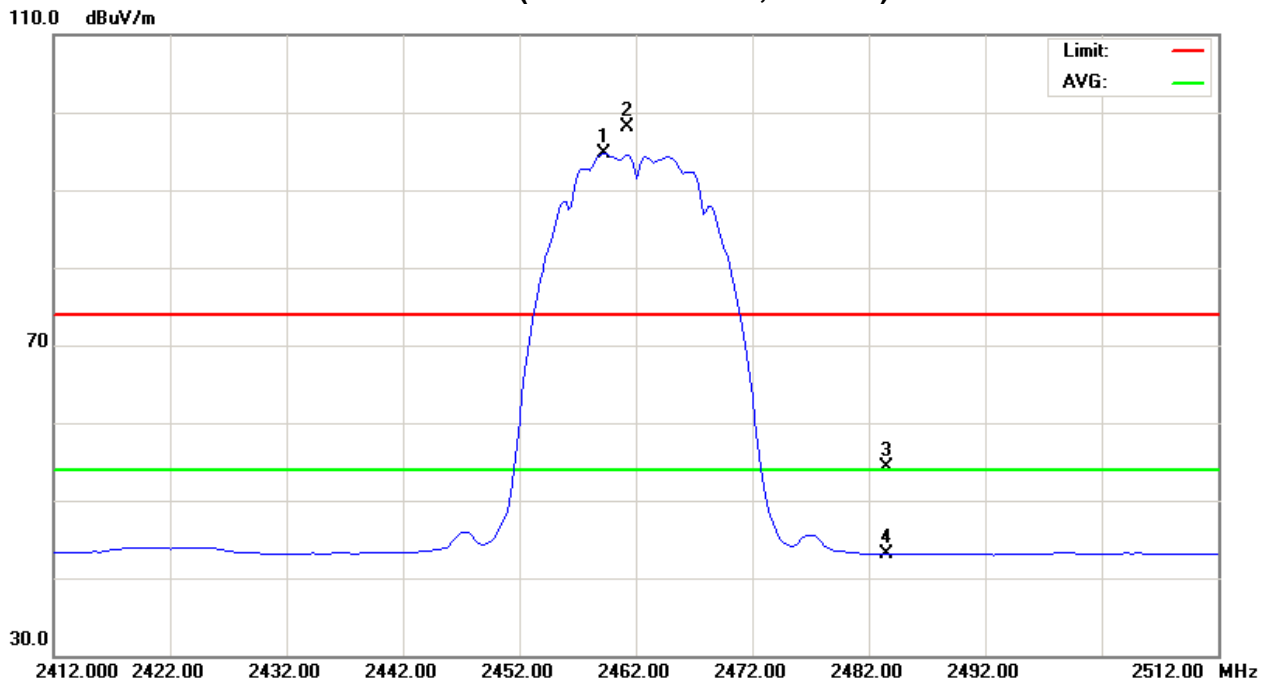



EUT :	150Mbps Wireless N USB Adapter	Model Name :	FWN-651ND
Temperature :	25 °C	Relative Humidity :	58 %
Pressure :	1010 hPa	Test Voltage :	AC 120V/60Hz
Test Mode :	TX B MODE 2462MHz		

Freq.	Ant.Pol.	Reading		Ant./CF	Act.		Limit		Note
		Peak	AV		Peak	AV	Peak	AV	
(MHz)	H/V	(dBuV)	(dBuV)	CF(dB)	(dBuV/m)	(dBuV/m)	(dBuV/m)	(dBuV/m)	
<b>2459.25</b>	<b>H</b>	<b>55.22</b>	<b>51.65</b>	<b>31.83</b>	<b>87.05</b>	<b>83.48</b>			<b>X/F</b>
2483.50	H	21.77	11.03	31.80	53.57	42.83	74.00	54.00	X/E
4924.10	H	43.98	31.46	5.65	49.63	37.11	74.00	54.00	X/H

Remark :

- (1) All readings are Peak unless otherwise stated QP in column of 『Note』 . Peak denotes that the Peak reading compliance with the QP Limits and then QP Mode measurement didn't perform .
- (2) Measuring frequency range from 30MHz to 1000MHz or the 10th harmonic of highest fundamental frequency . "F" denotes fundamental frequency; "H" denotes spurious frequency. "E" denotes band edge frequency. (This judgment method includes the Band Edge Requirement.)
- (3) Radiated emissions measured in frequency range above 1000MHz were made with an instrument using Peak detector mode and AV detector mode of the emission .
- (4) Data of measurement within this frequency range shown " \* " in the table above means the reading of emissions are attenuated more than 20dB below the permissible limits or the field strength is too small to be measured.
- (5) A preamp and high pass filter were used for this test in order to provide sufficient measurement sensitivity.
- (6) EUT Orthogonal Axis :  
 "X" - denotes Laid on Table ; "Y" - denotes Vertical Stand ; "Z" - denotes Side Stand
- (7) During the measurements above 1 GHz it is taken care of that the EUT is always within the 3 dB cone of radiation BW of the used antenna



TX CH11 (Above 1000 MHz, Horizontal)

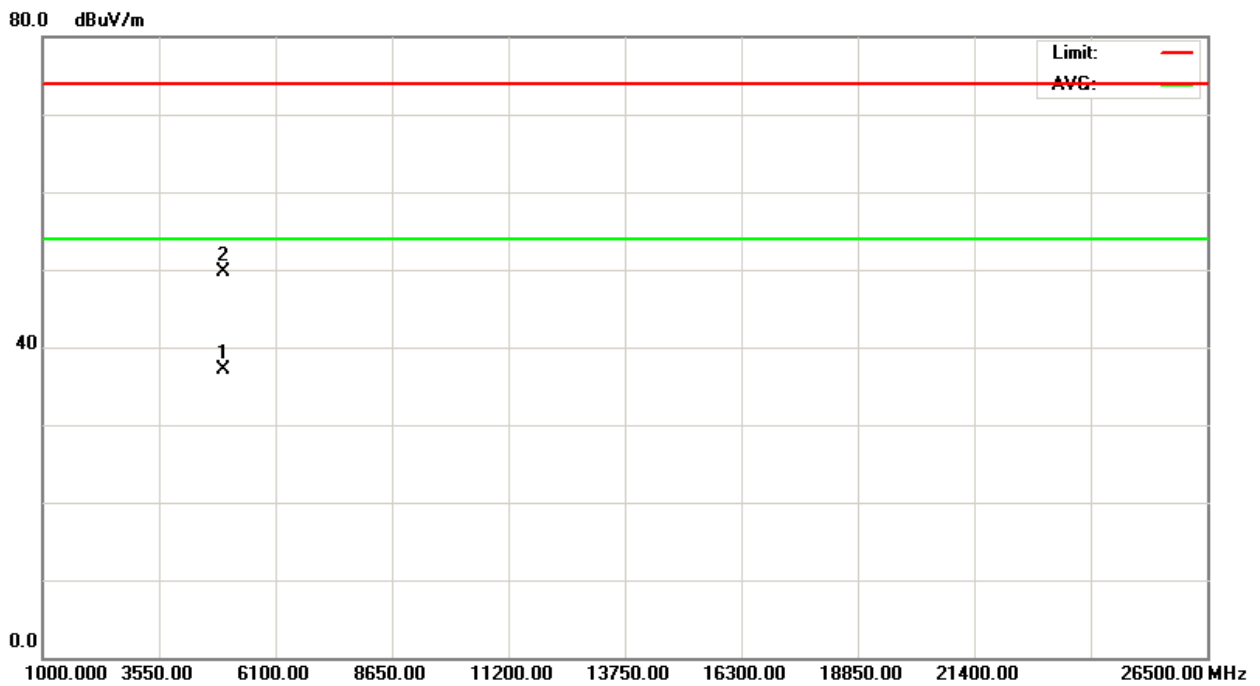
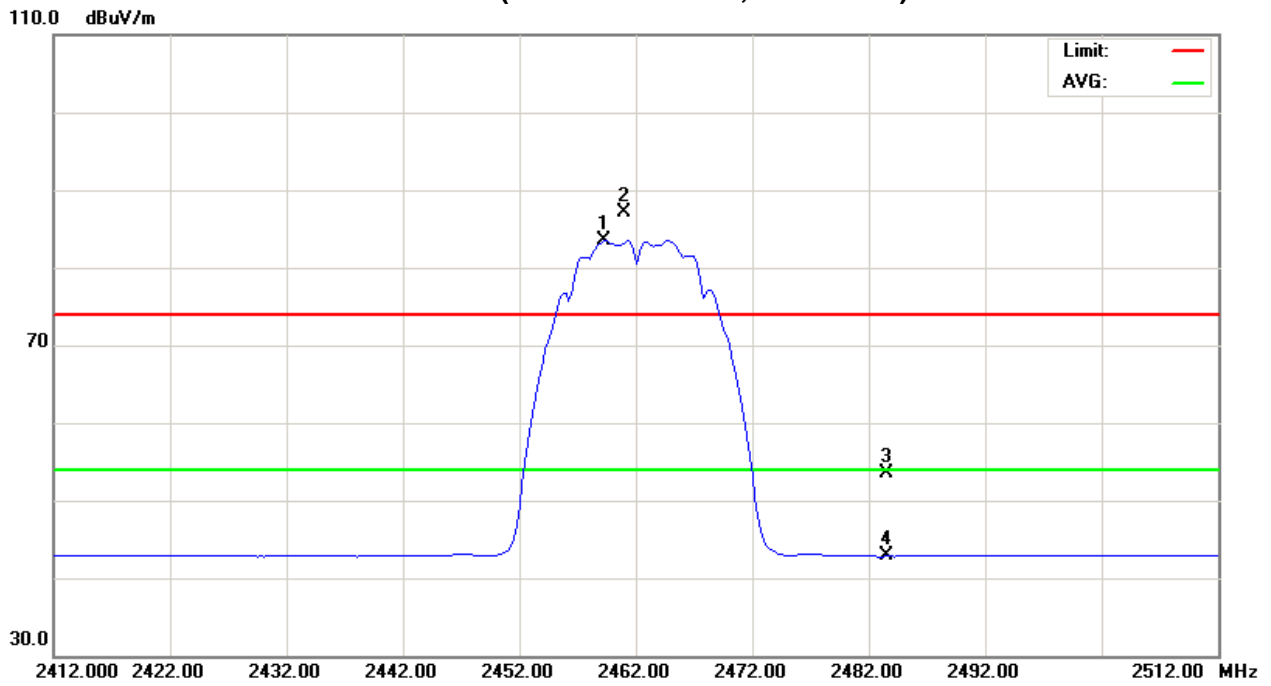



EUT :	150Mbps Wireless N USB Adapter	Model Name :	FWN-651ND
Temperature :	25 °C	Relative Humidity :	58 %
Pressure :	1010 hPa	Test Voltage :	AC 120V/60Hz
Test Mode :	TX G MODE 2412MHz		

Freq. (MHz)	Ant.Pol. H/V	Reading		Ant./CF CF(dB)	Act.		Limit		Note
		Peak (dBuV)	AV (dBuV)		Peak (dBuV/m)	AV (dBuV/m)	Peak (dBuV/m)	AV (dBuV/m)	
2390.00	V	24.10	11.97	31.91	56.01	43.88	74.00	54.00	X/E
<b>2414.50</b>	<b>V</b>	<b>68.82</b>	<b>59.71</b>	<b>31.88</b>	<b>100.70</b>	<b>91.59</b>			<b>X/F</b>
4824.62	V	47.59	38.52	5.29	52.88	43.81	74.00	54.00	X/H

Remark :

- (1) All readings are Peak unless otherwise stated QP in column of 『Note』 . Peak denotes that the Peak reading compliance with the QP Limits and then QP Mode measurement didn't perform .
- (2) Measuring frequency range from 30MHz to 1000MHz or the 10th harmonic of highest fundamental frequency . "F" denotes fundamental frequency; "H" denotes spurious frequency. "E" denotes band edge frequency. (This judgment method includes the Band Edge Requirement.)
- (3) Radiated emissions measured in frequency range above 1000MHz were made with an instrument using Peak detector mode and AV detector mode of the emission .
- (4) Data of measurement within this frequency range shown " \* " in the table above means the reading of emissions are attenuated more than 20dB below the permissible limits or the field strength is too small to be measured.
- (5) A preamp and high pass filter were used for this test in order to provide sufficient measurement sensitivity.
- (6) EUT Orthogonal Axis :  
"X" - denotes Laid on Table ; "Y" - denotes Vertical Stand ; "Z" - denotes Side Stand
- (7) During the measurements above 1 GHz it is taken care of that the EUT is always within the 3 dB cone of radiation BW of the used antenna





TX CH01 (Above 1000 MHz, Vertical)

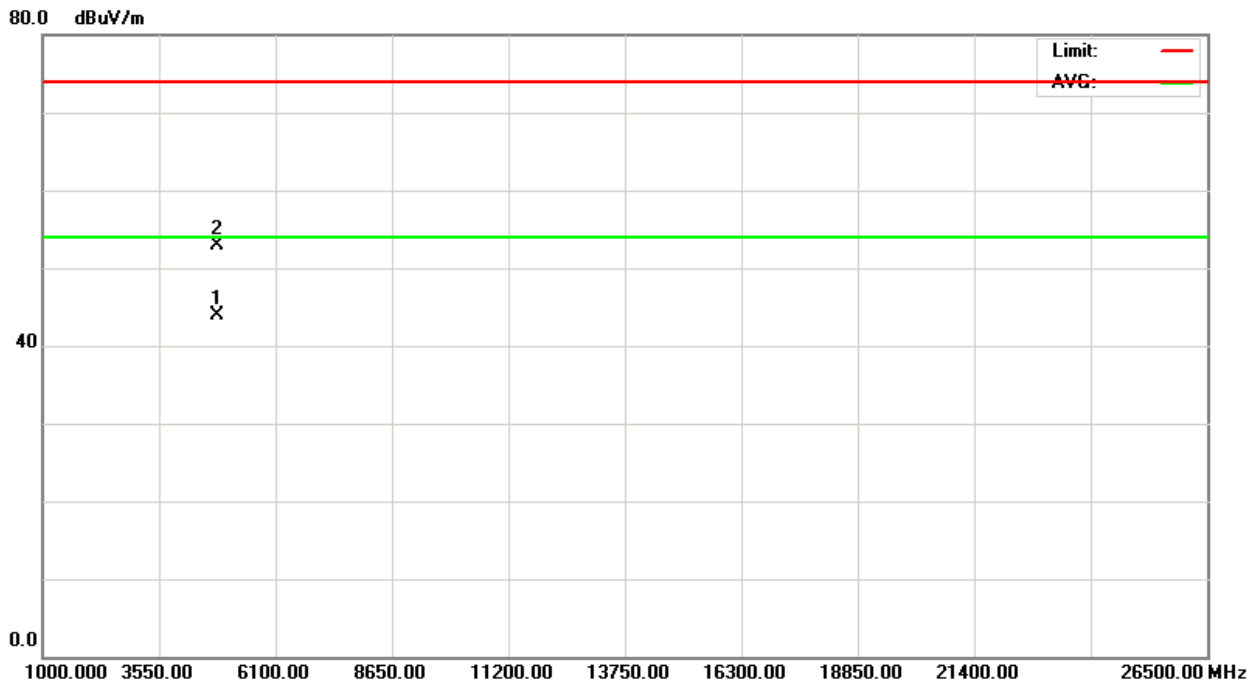
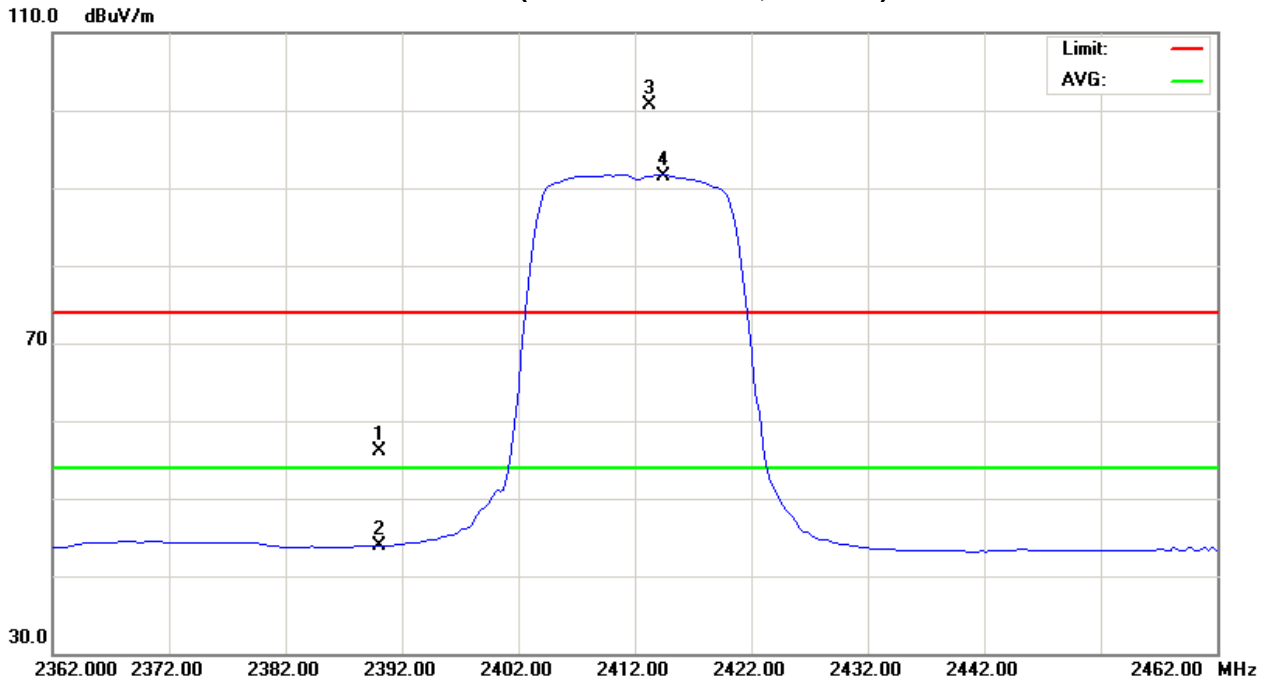



EUT :	150Mbps Wireless N USB Adapter	Model Name :	FWN-651ND
Temperature :	25 °C	Relative Humidity :	58 %
Pressure :	1010 hPa	Test Voltage :	AC 120V/60Hz
Test Mode :	TX G MODE 2412MHz		

Freq. (MHz)	Ant.Pol. H/V	Reading		Ant./CF CF(dB)	Act.		Limit		Note
		Peak (dBuV)	AV (dBuV)		Peak (dBuV/m)	AV (dBuV/m)	Peak (dBuV/m)	AV (dBuV/m)	
2390.00	H	21.94	11.17	31.91	53.85	43.08	74.00	54.00	X/E
<b>2414.50</b>	<b>H</b>	<b>57.53</b>	<b>48.59</b>	<b>31.88</b>	<b>89.41</b>	<b>80.47</b>			<b>X/F</b>
4824.15	H	45.27	33.24	5.29	50.56	38.53	74.00	54.00	X/H

Remark :

- (1) All readings are Peak unless otherwise stated QP in column of 『Note』 . Peak denotes that the Peak reading compliance with the QP Limits and then QP Mode measurement didn't perform .
- (2) Measuring frequency range from 30MHz to 1000MHz or the 10th harmonic of highest fundamental frequency . "F" denotes fundamental frequency; "H" denotes spurious frequency. "E" denotes band edge frequency. (This judgment method includes the Band Edge Requirement.)
- (3) Radiated emissions measured in frequency range above 1000MHz were made with an instrument using Peak detector mode and AV detector mode of the emission .
- (4) Data of measurement within this frequency range shown " \* " in the table above means the reading of emissions are attenuated more than 20dB below the permissible limits or the field strength is too small to be measured.
- (5) A preamp and high pass filter were used for this test in order to provide sufficient measurement sensitivity.
- (6) EUT Orthogonal Axis :  
"X" - denotes Laid on Table ; "Y" - denotes Vertical Stand ; "Z" - denotes Side Stand
- (7) During the measurements above 1 GHz it is taken care of that the EUT is always within the 3 dB cone of radiation BW of the used antenna



TX CH01 (Above 1000 MHz, Horizontal)

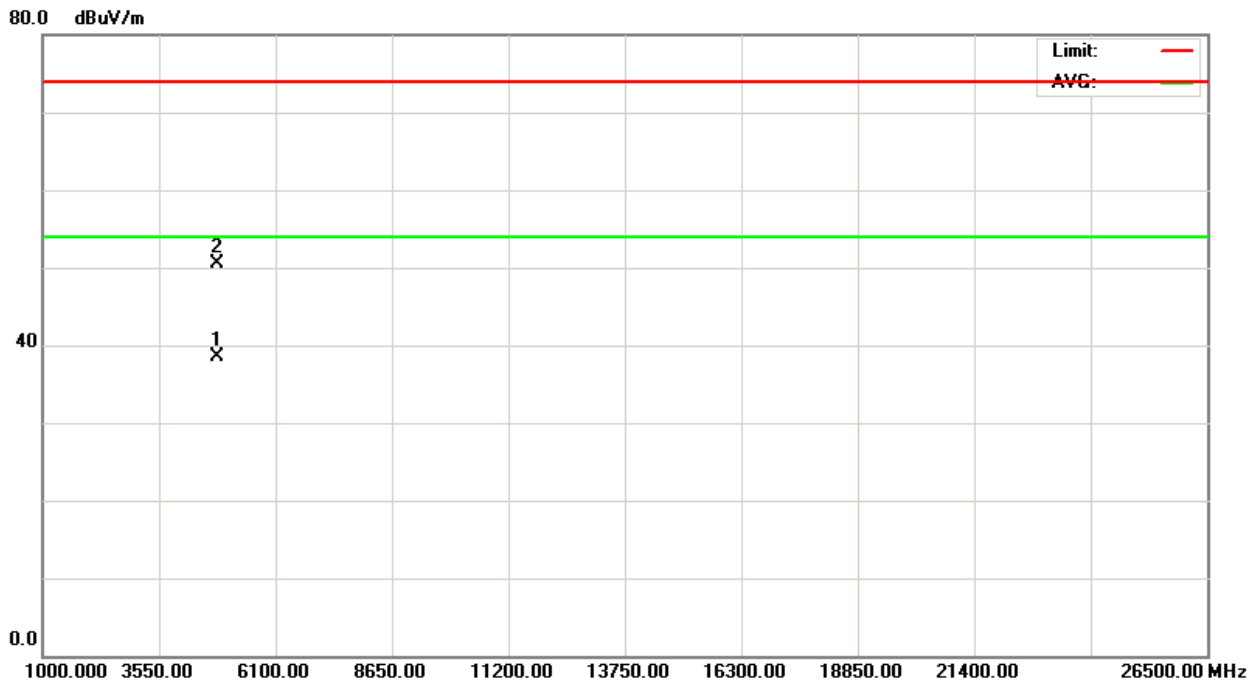
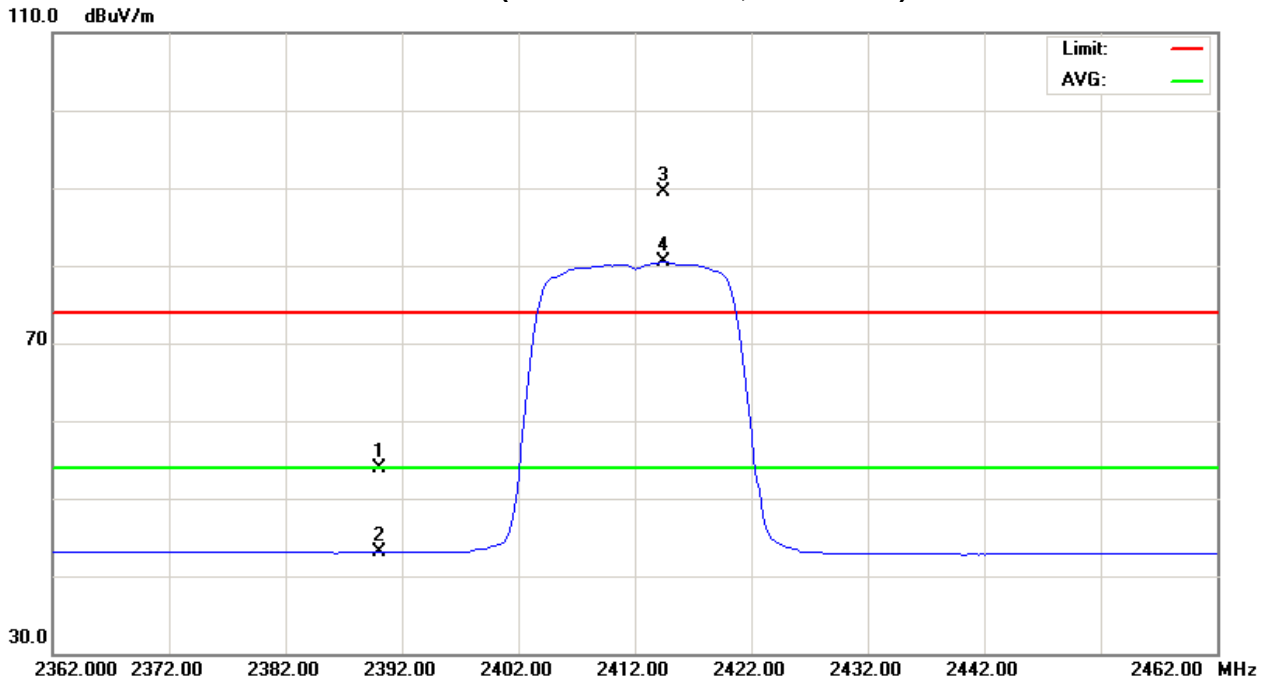



EUT :	150Mbps Wireless N USB Adapter	Model Name :	FWN-651ND
Temperature :	25 °C	Relative Humidity :	58 %
Pressure :	1010 hPa	Test Voltage :	AC 120V/60Hz
Test Mode :	TX G MODE 2437MHz		

Freq. (MHz)	Ant.Pol. H/V	Reading		Ant./CF CF(dB)	Act.		Limit		Note
		Peak (dBuV)	AV (dBuV)		Peak (dBuV/m)	AV (dBuV/m)	Peak (dBuV/m)	AV (dBuV/m)	
<b>2433.75</b>	<b>V</b>	<b>66.62</b>	<b>57.51</b>	<b>31.86</b>	<b>98.48</b>	<b>89.37</b>			<b>X/F</b>
4874.02	V	46.74	37.71	5.47	52.21	43.18	74.00	54.00	X/H

Remark :

- (1) All readings are Peak unless otherwise stated QP in column of 『 Note 』 . Peak denotes that the Peak reading compliance with the QP Limits and then QP Mode measurement didn't perform .
- (2) Measuring frequency range from 30MHz to 1000MHz or the 10th harmonic of highest fundamental frequency . "F" denotes fundamental frequency; "H" denotes spurious frequency. "E" denotes band edge frequency. (This judgment method includes the Band Edge Requirement.)
- (3) Radiated emissions measured in frequency range above 1000MHz were made with an instrument using Peak detector mode and AV detector mode of the emission .
- (4) Data of measurement within this frequency range shown " \* " in the table above means the reading of emissions are attenuated more than 20dB below the permissible limits or the field strength is too small to be measured.
- (5) A preamp and high pass filter were used for this test in order to provide sufficient measurement sensitivity.
- (6) EUT Orthogonal Axis :  
"X" - denotes Laid on Table ; "Y" - denotes Vertical Stand ; "Z" - denotes Side Stand
- (7) During the measurements above 1 GHz it is taken care of that the EUT is always within the 3 dB cone of radiation BW of the used antenna



TX CH06 (Above 1000 MHz, Vertical)

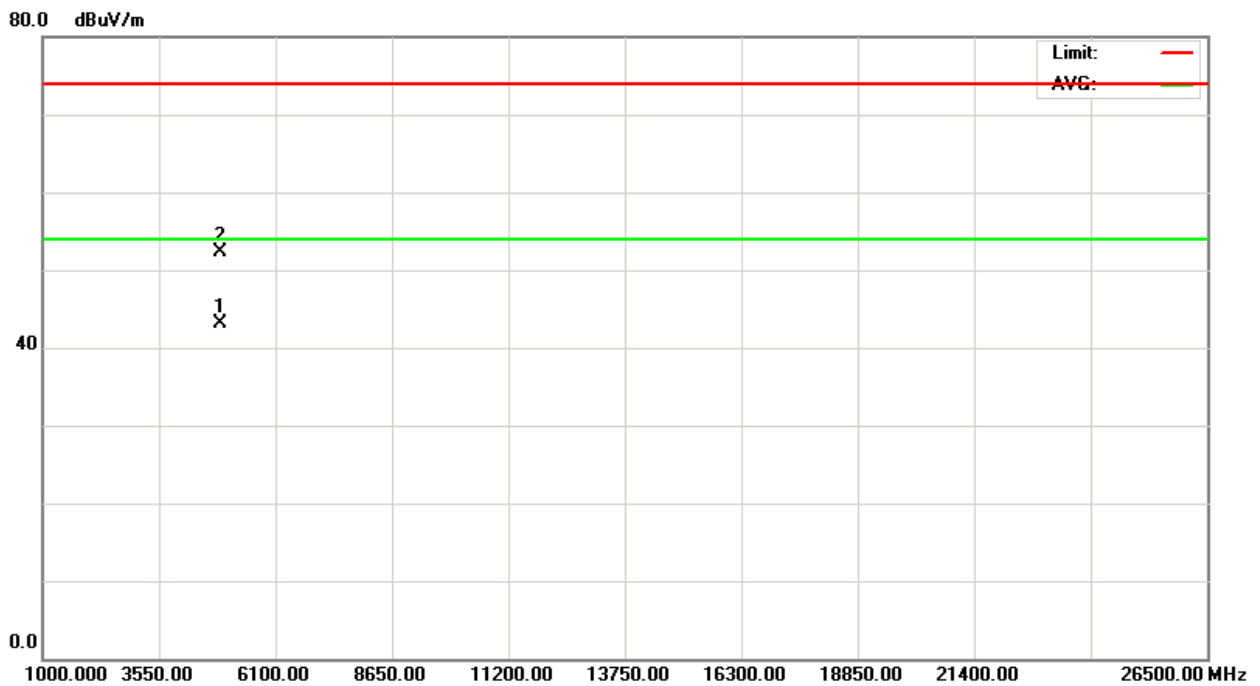
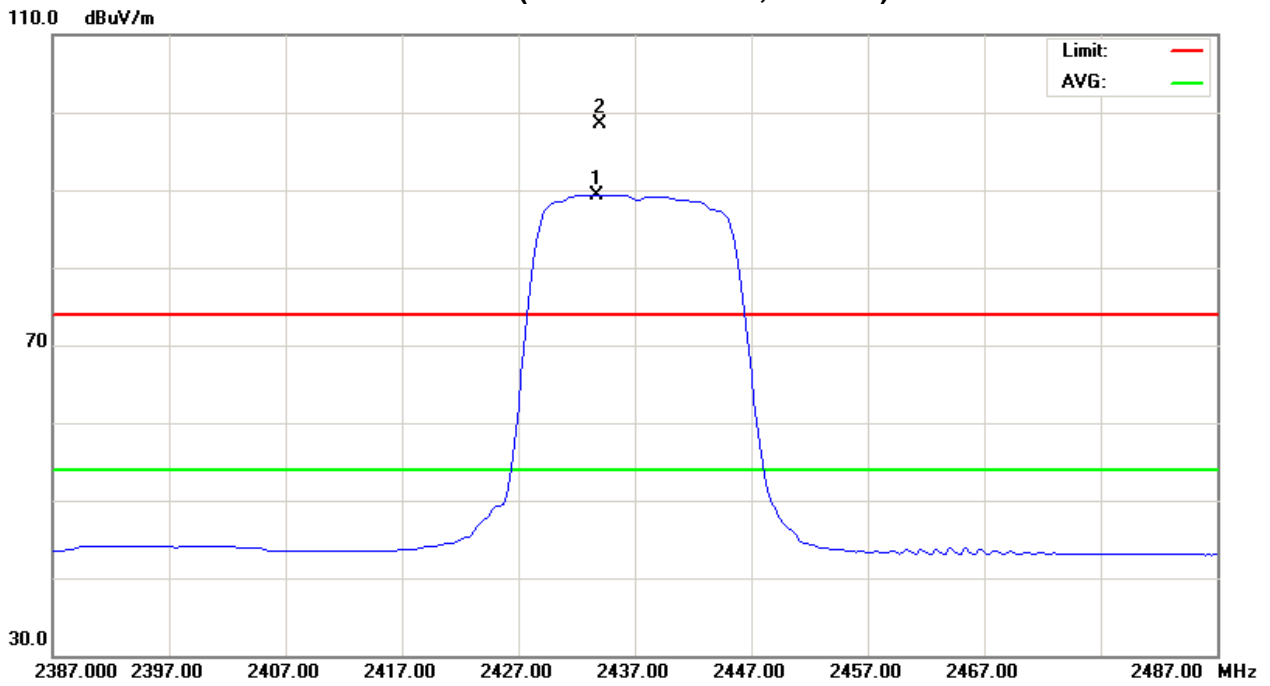



EUT :	150Mbps Wireless N USB Adapter	Model Name :	FWN-651ND
Temperature :	25 °C	Relative Humidity :	58 %
Pressure :	1010 hPa	Test Voltage :	AC 120V/60Hz
Test Mode :	TX G MODE 2437MHz		

Freq.	Ant.Pol.	Reading		Ant./CF	Act.		Limit		Note
		Peak	AV		Peak	AV	Peak	AV	
(MHz)	H/V	(dBuV)	(dBuV)	CF(dB)	(dBuV/m)	(dBuV/m)	(dBuV/m)	(dBuV/m)	
<b>2432.25</b>	<b>H</b>	<b>55.79</b>	<b>46.88</b>	<b>31.87</b>	<b>87.66</b>	<b>78.75</b>			<b>X/F</b>
4874.02	H	42.74	31.05	5.47	48.21	36.52	74.00	54.00	X/H

Remark :

- (1) All readings are Peak unless otherwise stated QP in column of 『Note』 . Peak denotes that the Peak reading compliance with the QP Limits and then QP Mode measurement didn't perform .
- (2) Measuring frequency range from 30MHz to 1000MHz or the 10th harmonic of highest fundamental frequency . "F" denotes fundamental frequency; "H" denotes spurious frequency. "E" denotes band edge frequency. (This judgment method includes the Band Edge Requirement.)
- (3) Radiated emissions measured in frequency range above 1000MHz were made with an instrument using Peak detector mode and AV detector mode of the emission .
- (4) Data of measurement within this frequency range shown " \* " in the table above means the reading of emissions are attenuated more than 20dB below the permissible limits or the field strength is too small to be measured.
- (5) A preamp and high pass filter were used for this test in order to provide sufficient measurement sensitivity.
- (6) EUT Orthogonal Axis :  
 "X" - denotes Laid on Table ; "Y" - denotes Vertical Stand ; "Z" - denotes Side Stand
- (7) During the measurements above 1 GHz it is taken care of that the EUT is always within the 3 dB cone of radiation BW of the used antenna



TX CH06 (Above 1000 MHz, Horizontal)

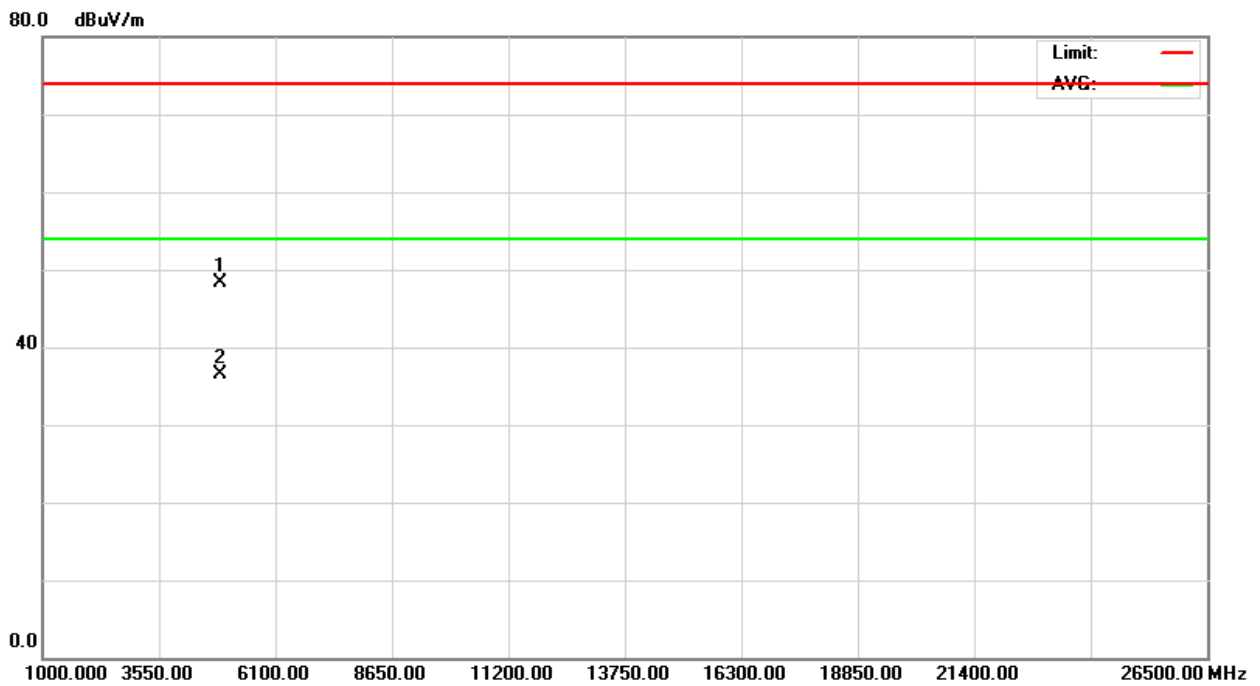
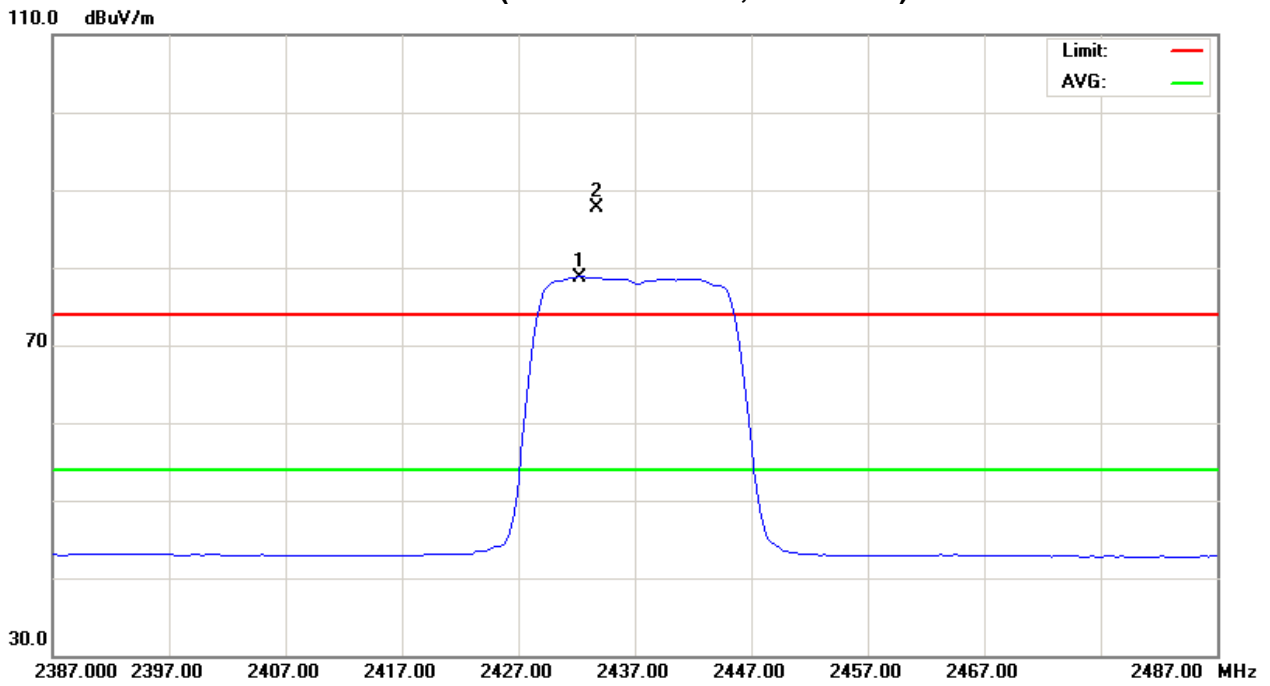



EUT :	150Mbps Wireless N USB Adapter	Model Name :	FWN-651ND
Temperature :	25 °C	Relative Humidity :	58 %
Pressure :	1010 hPa	Test Voltage :	AC 120V/60Hz
Test Mode :	TX G MODE 2462MHz		

Freq.	Ant.Pol.	Reading		Ant./CF	Act.		Limit		Note
		Peak	AV		Peak	AV	Peak	AV	
(MHz)	H/V	(dBuV)	(dBuV)	CF(dB)	(dBuV/m)	(dBuV/m)	(dBuV/m)	(dBuV/m)	
<b>2459.00</b>	<b>V</b>	<b>68.02</b>	<b>59.02</b>	<b>31.83</b>	<b>99.85</b>	<b>90.85</b>			<b>X/F</b>
2483.50	V	22.37	11.62	31.80	54.17	43.42	74.00	54.00	X/E
4924.12	V	46.32	34.35	5.65	51.97	40.00	74.00	54.00	X/H

Remark :

- (1) All readings are Peak unless otherwise stated QP in column of 『Note』 . Peak denotes that the Peak reading compliance with the QP Limits and then QP Mode measurement didn't perform .
- (2) Measuring frequency range from 30MHz to 1000MHz or the 10th harmonic of highest fundamental frequency . "F" denotes fundamental frequency; "H" denotes spurious frequency. "E" denotes band edge frequency. (This judgment method includes the Band Edge Requirement.)
- (3) Radiated emissions measured in frequency range above 1000MHz were made with an instrument using Peak detector mode and AV detector mode of the emission .
- (4) Data of measurement within this frequency range shown " \* " in the table above means the reading of emissions are attenuated more than 20dB below the permissible limits or the field strength is too small to be measured.
- (5) A preamp and high pass filter were used for this test in order to provide sufficient measurement sensitivity.
- (6) EUT Orthogonal Axis :  
 "X" - denotes Laid on Table ; "Y" - denotes Vertical Stand ; "Z" - denotes Side Stand
- (7) During the measurements above 1 GHz it is taken care of that the EUT is always within the 3 dB cone of radiation BW of the used antenna





TX CH11 (Above 1000 MHz, Vertical)

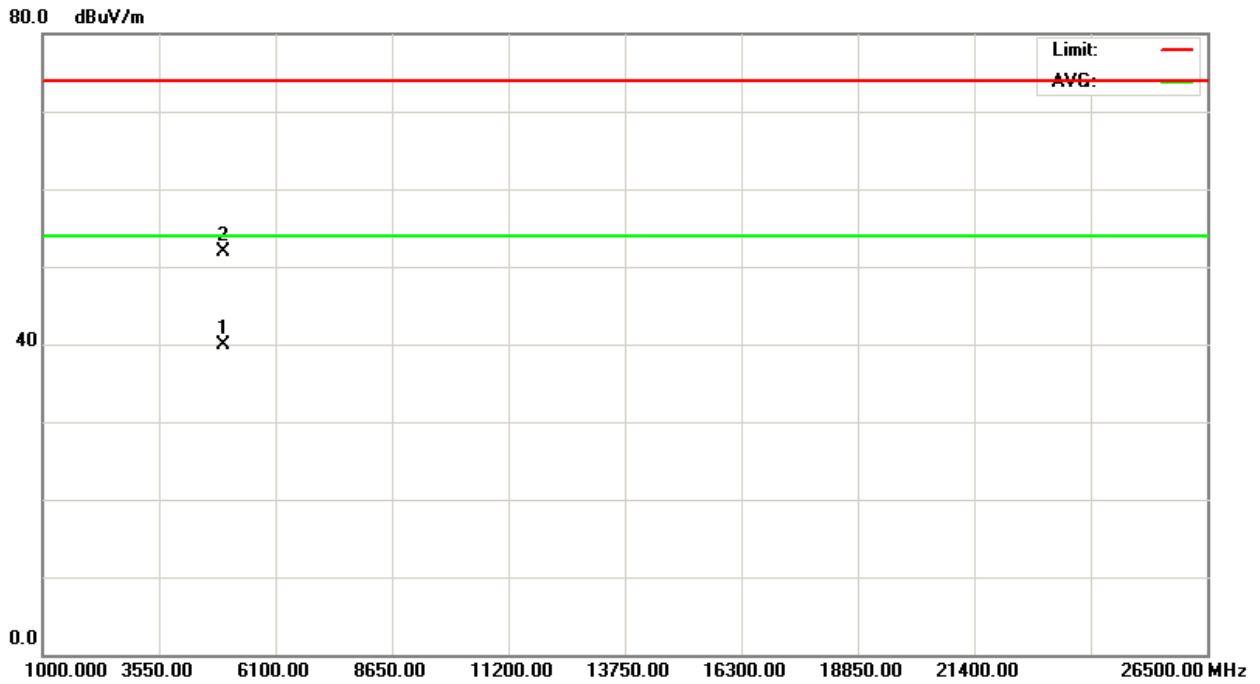
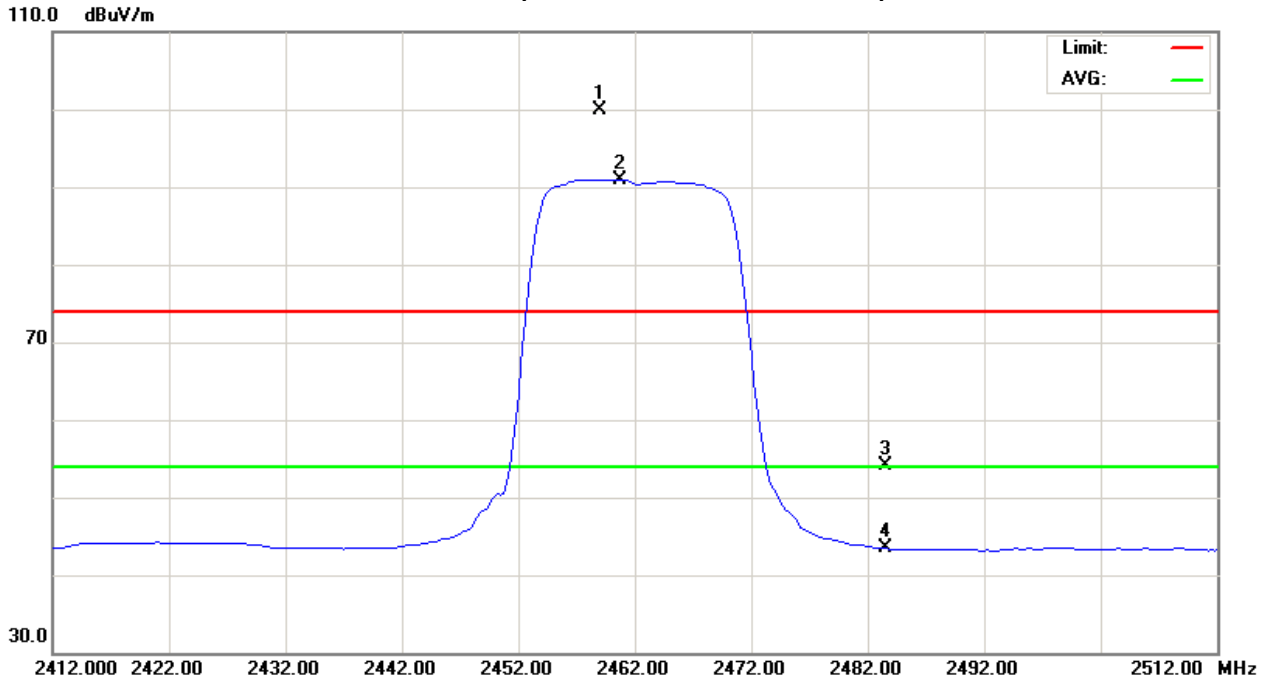



EUT :	150Mbps Wireless N USB Adapter	Model Name :	FWN-651ND
Temperature :	25 °C	Relative Humidity :	58 %
Pressure :	1010 hPa	Test Voltage :	AC 120V/60Hz
Test Mode :	TX G MODE 2462MHz		

Freq.	Ant.Pol.	Reading		Ant./CF	Act.		Limit		Note
		Peak	AV		Peak	AV	Peak	AV	
(MHz)	H/V	(dBuV)	(dBuV)	CF(dB)	(dBuV/m)	(dBuV/m)	(dBuV/m)	(dBuV/m)	
<b>2457.25</b>	<b>H</b>	<b>57.04</b>	<b>48.18</b>	<b>31.83</b>	<b>88.87</b>	<b>80.01</b>			<b>X/F</b>
2483.50	H	22.26	10.99	31.80	54.06	42.79	74.00	54.00	X/E
4924.31	H	45.75	34.14	5.65	51.40	39.79	74.00	54.00	X/H

Remark :

- (1) All readings are Peak unless otherwise stated QP in column of 『Note』 . Peak denotes that the Peak reading compliance with the QP Limits and then QP Mode measurement didn't perform .
- (2) Measuring frequency range from 30MHz to 1000MHz or the 10th harmonic of highest fundamental frequency . "F" denotes fundamental frequency; "H" denotes spurious frequency. "E" denotes band edge frequency. (This judgment method includes the Band Edge Requirement.)
- (3) Radiated emissions measured in frequency range above 1000MHz were made with an instrument using Peak detector mode and AV detector mode of the emission .
- (4) Data of measurement within this frequency range shown " \* " in the table above means the reading of emissions are attenuated more than 20dB below the permissible limits or the field strength is too small to be measured.
- (5) A preamp and high pass filter were used for this test in order to provide sufficient measurement sensitivity.
- (6) EUT Orthogonal Axis :  
 "X" - denotes Laid on Table ; "Y" - denotes Vertical Stand ; "Z" - denotes Side Stand
- (7) During the measurements above 1 GHz it is taken care of that the EUT is always within the 3 dB cone of radiation BW of the used antenna



TX CH11 (Above 1000 MHz, Horizontal)

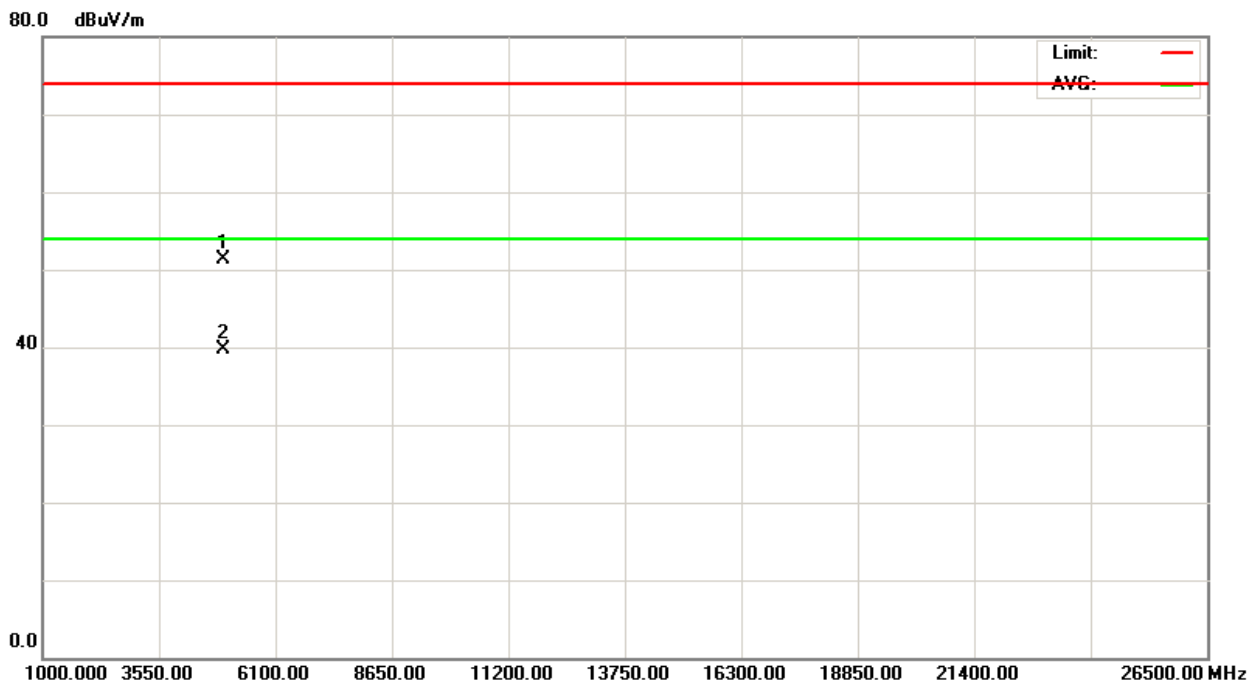
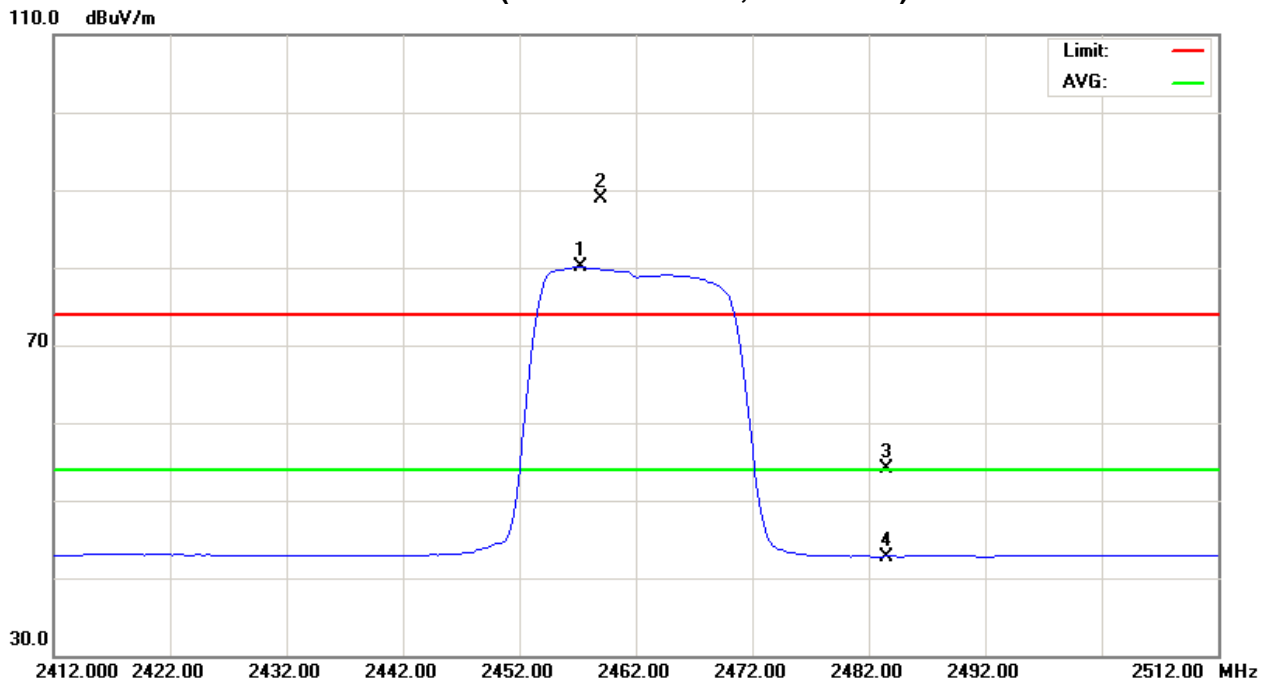



EUT :	150Mbps Wireless N USB Adapter	Model Name :	FWN-651ND
Temperature :	25 °C	Relative Humidity :	58 %
Pressure :	1010 hPa	Test Voltage :	AC 120V/60Hz
Test Mode :	TX N-20M MODE 2412MHz		

Freq. (MHz)	Ant.Pol. H/V	Reading		Ant./CF CF(dB)	Act.		Limit		Note
		Peak (dBuV)	AV (dBuV)		Peak (dBuV/m)	AV (dBuV/m)	Peak (dBuV/m)	AV (dBuV/m)	
2390.00	V	23.83	12.00	31.91	55.74	43.91	74.00	54.00	X/E
<b>2409.00</b>	<b>V</b>	<b>68.79</b>	<b>58.87</b>	<b>31.89</b>	<b>100.68</b>	<b>90.76</b>			<b>X/F</b>
4823.96	V	49.97	38.47	5.29	55.26	43.76	74.00	54.00	X/H

Remark :

- (1) All readings are Peak unless otherwise stated QP in column of 『 Note 』 . Peak denotes that the Peak reading compliance with the QP Limits and then QP Mode measurement didn't perform .
- (2) Measuring frequency range from 30MHz to 1000MHz or the 10th harmonic of highest fundamental frequency . "F" denotes fundamental frequency; "H" denotes spurious frequency. "E" denotes band edge frequency. (This judgment method includes the Band Edge Requirement.)
- (3) Radiated emissions measured in frequency range above 1000MHz were made with an instrument using Peak detector mode and AV detector mode of the emission .
- (4) Data of measurement within this frequency range shown " \* " in the table above means the reading of emissions are attenuated more than 20dB below the permissible limits or the field strength is too small to be measured.
- (5) A preamp and high pass filter were used for this test in order to provide sufficient measurement sensitivity.
- (6) EUT Orthogonal Axis :  
"X" - denotes Laid on Table ; "Y" - denotes Vertical Stand ; "Z" - denotes Side Stand
- (7) During the measurements above 1 GHz it is taken care of that the EUT is always within the 3 dB cone of radiation BW of the used antenna



TX CH01 (Above 1000 MHz, Vertical)

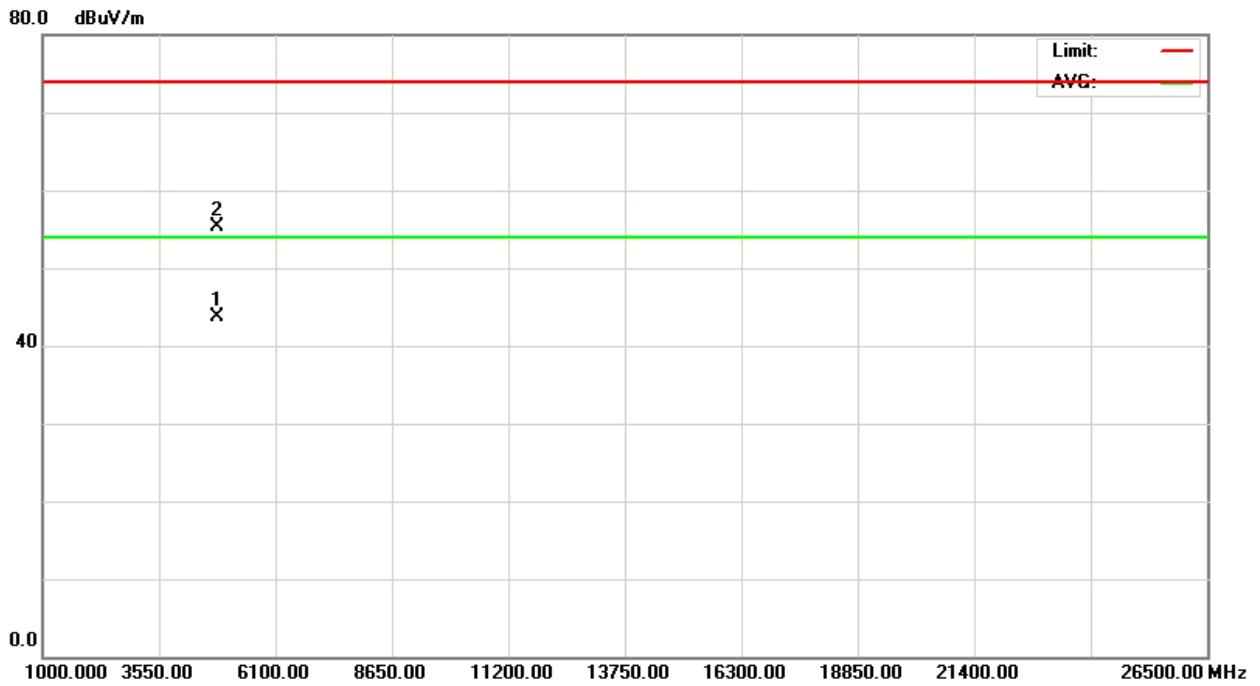
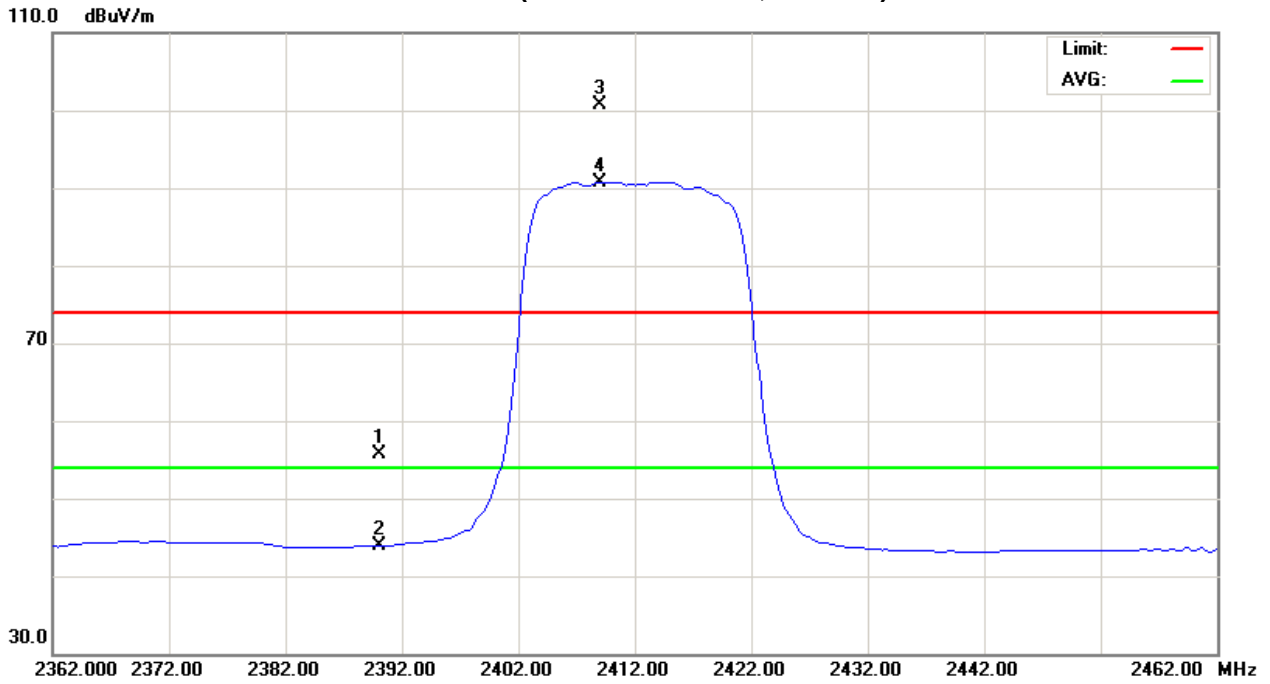



EUT :	150Mbps Wireless N USB Adapter	Model Name :	FWN-651ND
Temperature :	25 °C	Relative Humidity :	58 %
Pressure :	1010 hPa	Test Voltage :	AC 120V/60Hz
Test Mode :	TX N-20M MODE 2412MHz		

Freq.	Ant.Pol.	Reading		Ant./CF	Act.		Limit		Note
		Peak	AV		Peak	AV	Peak	AV	
(MHz)	H/V	(dBuV)	(dBuV)	CF(dB)	(dBuV/m)	(dBuV/m)	(dBuV/m)	(dBuV/m)	
2390.00	H	21.94	11.11	31.91	53.85	43.02	74.00	54.00	X/E
<b>2415.25</b>	<b>H</b>	<b>56.93</b>	<b>47.62</b>	<b>31.88</b>	<b>88.81</b>	<b>79.50</b>			<b>X/F</b>
4824.26	H	45.54	34.49	5.29	50.83	39.78	74.00	54.00	X/H

Remark :

- (1) All readings are Peak unless otherwise stated QP in column of 『Note』 . Peak denotes that the Peak reading compliance with the QP Limits and then QP Mode measurement didn't perform .
- (2) Measuring frequency range from 30MHz to 1000MHz or the 10th harmonic of highest fundamental frequency . "F" denotes fundamental frequency; "H" denotes spurious frequency. "E" denotes band edge frequency. (This judgment method includes the Band Edge Requirement.)
- (3) Radiated emissions measured in frequency range above 1000MHz were made with an instrument using Peak detector mode and AV detector mode of the emission .
- (4) Data of measurement within this frequency range shown " \* " in the table above means the reading of emissions are attenuated more than 20dB below the permissible limits or the field strength is too small to be measured.
- (5) A preamp and high pass filter were used for this test in order to provide sufficient measurement sensitivity.
- (6) EUT Orthogonal Axis :  
 "X" - denotes Laid on Table ; "Y" - denotes Vertical Stand ; "Z" - denotes Side Stand
- (7) During the measurements above 1 GHz it is taken care of that the EUT is always within the 3 dB cone of radiation BW of the used antenna



TX CH01 (Above 1000 MHz, Horizontal)

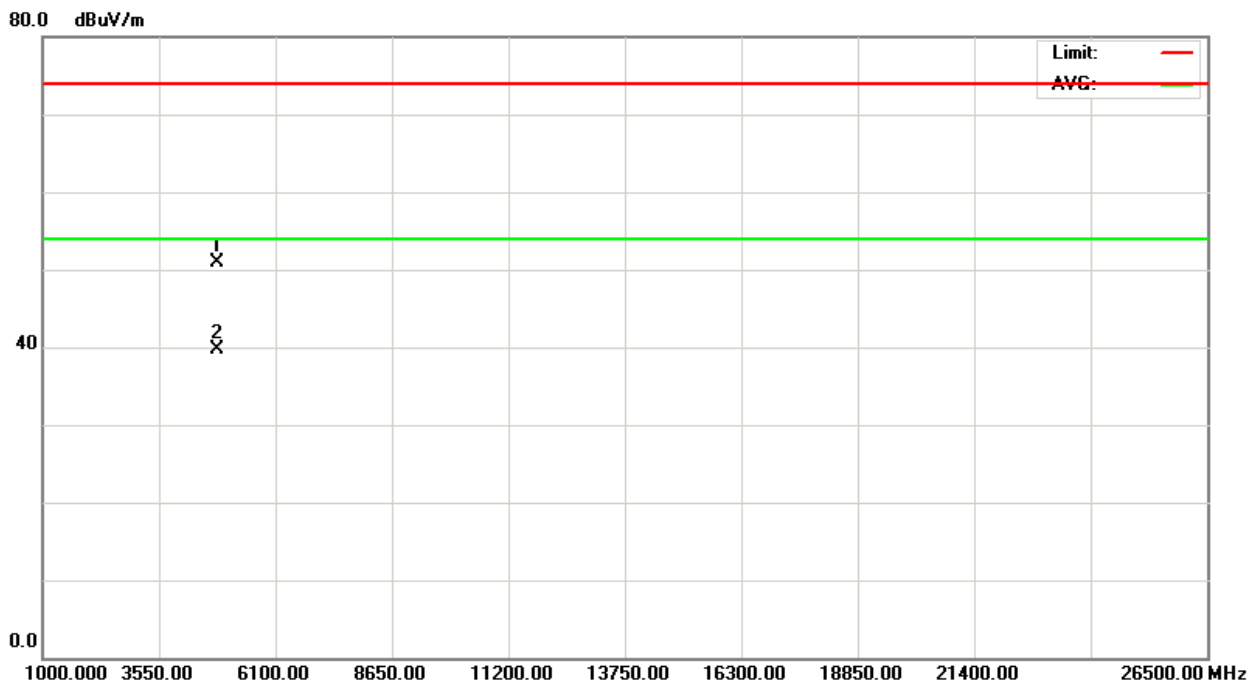
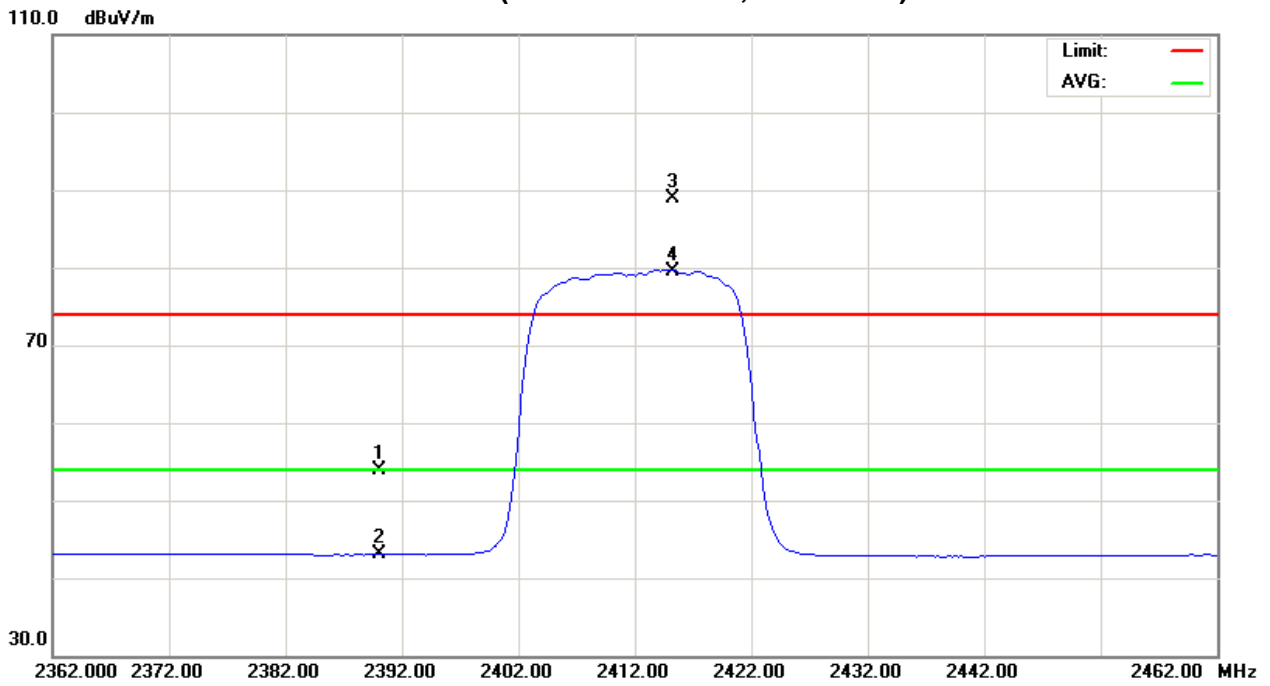



EUT :	150Mbps Wireless N USB Adapter	Model Name :	FWN-651ND
Temperature :	25 °C	Relative Humidity :	58 %
Pressure :	1010 hPa	Test Voltage :	AC 120V/60Hz
Test Mode :	TX N-20M MODE 2437MHZ		

Freq. (MHz)	Ant.Pol. H/V	Reading		Ant./CF CF(dB)	Act.		Limit		Note
		Peak (dBuV)	AV (dBuV)		Peak (dBuV/m)	AV (dBuV/m)	Peak (dBuV/m)	AV (dBuV/m)	
<b>2434.00</b>	<b>V</b>	<b>66.51</b>	<b>56.85</b>	<b>31.86</b>	<b>98.37</b>	<b>88.71</b>			<b>X/F</b>
4873.85	V	48.44	37.85	5.47	53.91	43.32	74.00	54.00	X/H

Remark :

- (1) All readings are Peak unless otherwise stated QP in column of 『 Note 』 . Peak denotes that the Peak reading compliance with the QP Limits and then QP Mode measurement didn't perform ◦
- (2) Measuring frequency range from 30MHz to 1000MHz or the 10th harmonic of highest fundamental frequency ◦ "F" denotes fundamental frequency; "H" denotes spurious frequency. "E" denotes band edge frequency. (This judgment method includes the Band Edge Requirement.)
- (3) Radiated emissions measured in frequency range above 1000MHz were made with an instrument using Peak detector mode and AV detector mode of the emission ◦
- (4) Data of measurement within this frequency range shown " \* " in the table above means the reading of emissions are attenuated more than 20dB below the permissible limits or the field strength is too small to be measured.
- (5) A preamp and high pass filter were used for this test in order to provide sufficient measurement sensitivity.
- (6) EUT Orthogonal Axis :  
"X" - denotes Laid on Table ; "Y" - denotes Vertical Stand ; "Z" - denotes Side Stand
- (7) During the measurements above 1 GHz it is taken care of that the EUT is always within the 3 dB cone of radiation BW of the used antenna





TX CH06 (Above 1000 MHz, Vertical)

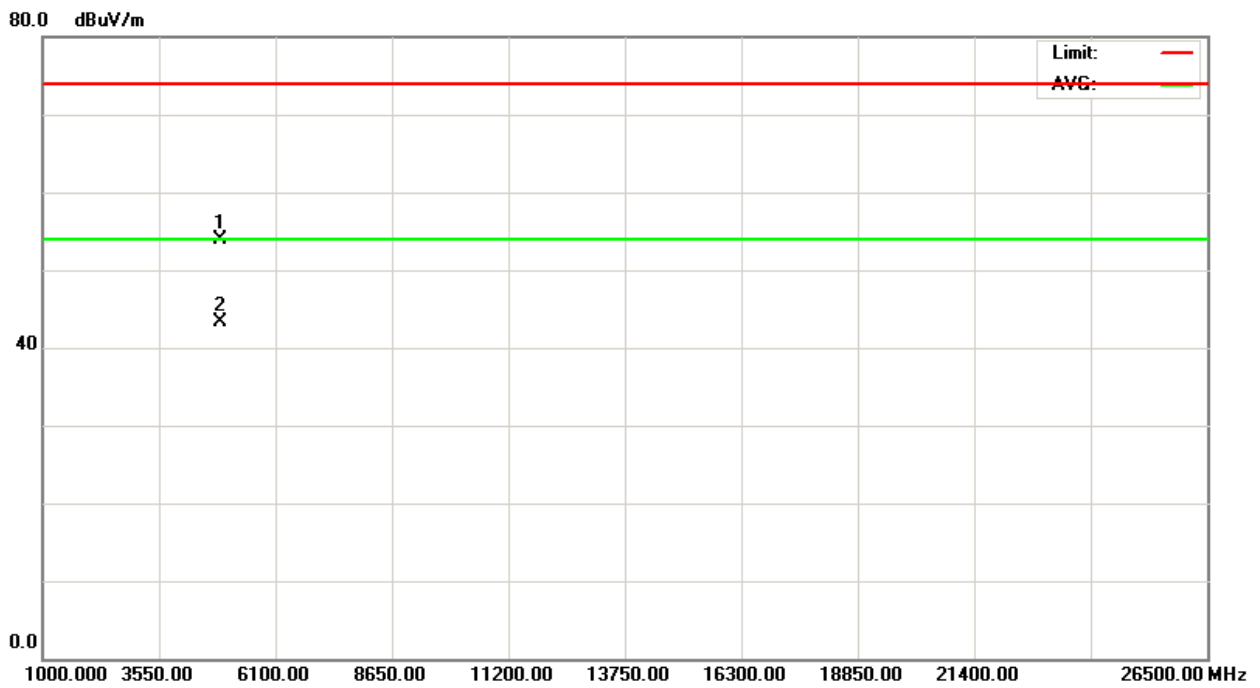
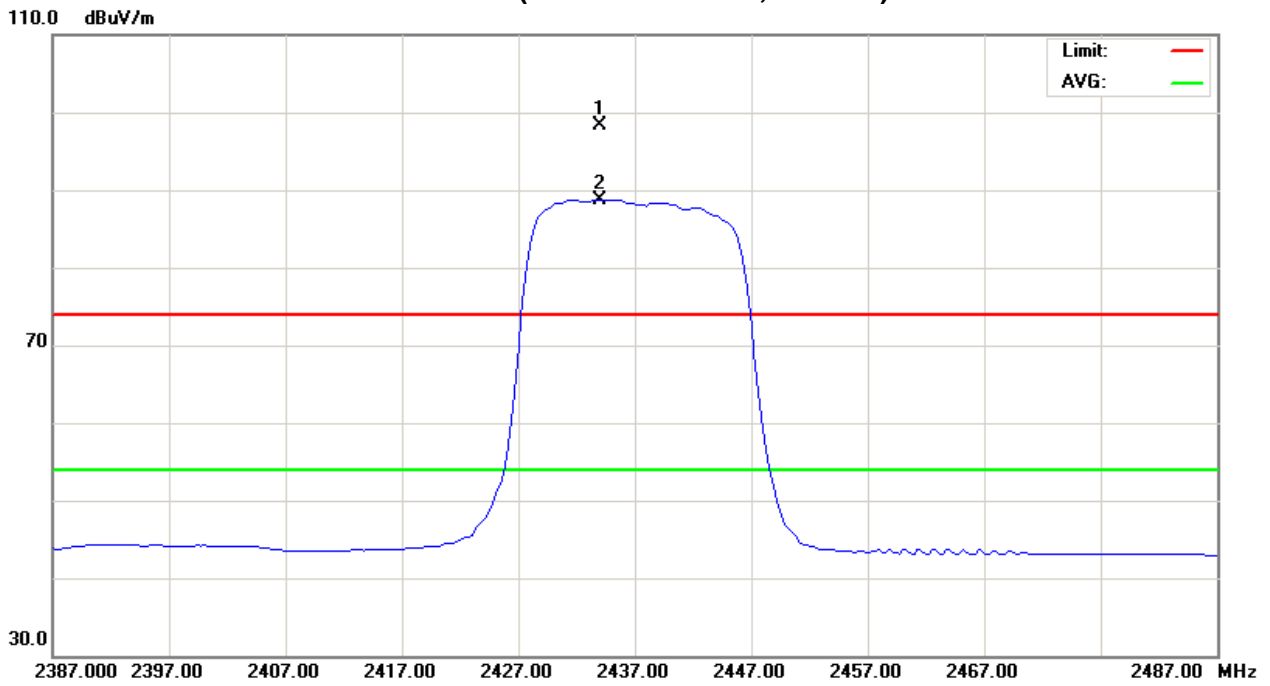



EUT :	150Mbps Wireless N USB Adapter	Model Name :	FWN-651ND
Temperature :	25 °C	Relative Humidity :	58 %
Pressure :	1010 hPa	Test Voltage :	AC 120V/60Hz
Test Mode :	TX N-20M MODE 2437MHZ		

Freq.	Ant.Pol.	Reading		Ant./CF	Act.		Limit		Note
		Peak	AV		Peak	AV	Peak	AV	
(MHz)	H/V	(dBuV)	(dBuV)	CF(dB)	(dBuV/m)	(dBuV/m)	(dBuV/m)	(dBuV/m)	
<b>2431.75</b>	<b>H</b>	<b>54.71</b>	<b>45.19</b>	<b>31.87</b>	<b>86.58</b>	<b>77.06</b>			<b>X/F</b>
4873.85	H	44.26	33.56	5.47	49.73	39.03	74.00	54.00	X/H

Remark :

- (1) All readings are Peak unless otherwise stated QP in column of 『Note』 . Peak denotes that the Peak reading compliance with the QP Limits and then QP Mode measurement didn't perform .
- (2) Measuring frequency range from 30MHz to 1000MHz or the 10th harmonic of highest fundamental frequency .“F” denotes fundamental frequency; “H” denotes spurious frequency. “E” denotes band edge frequency. (This judgment method includes the Band Edge Requirement.)
- (3) Radiated emissions measured in frequency range above 1000MHz were made with an instrument using Peak detector mode and AV detector mode of the emission .
- (4) Data of measurement within this frequency range shown “ \* ” in the table above means the reading of emissions are attenuated more than 20dB below the permissible limits or the field strength is too small to be measured.
- (5) A preamp and high pass filter were used for this test in order to provide sufficient measurement sensitivity.
- (6) EUT Orthogonal Axis :  
“X” - denotes Laid on Table ; “Y” - denotes Vertical Stand ; “Z” - denotes Side Stand
- (7) During the measurements above 1 GHz it is taken care of that the EUT is always within the 3 dB cone of radiation BW of the used antenna



TX CH06 (Above 1000 MHz, Horizontal)

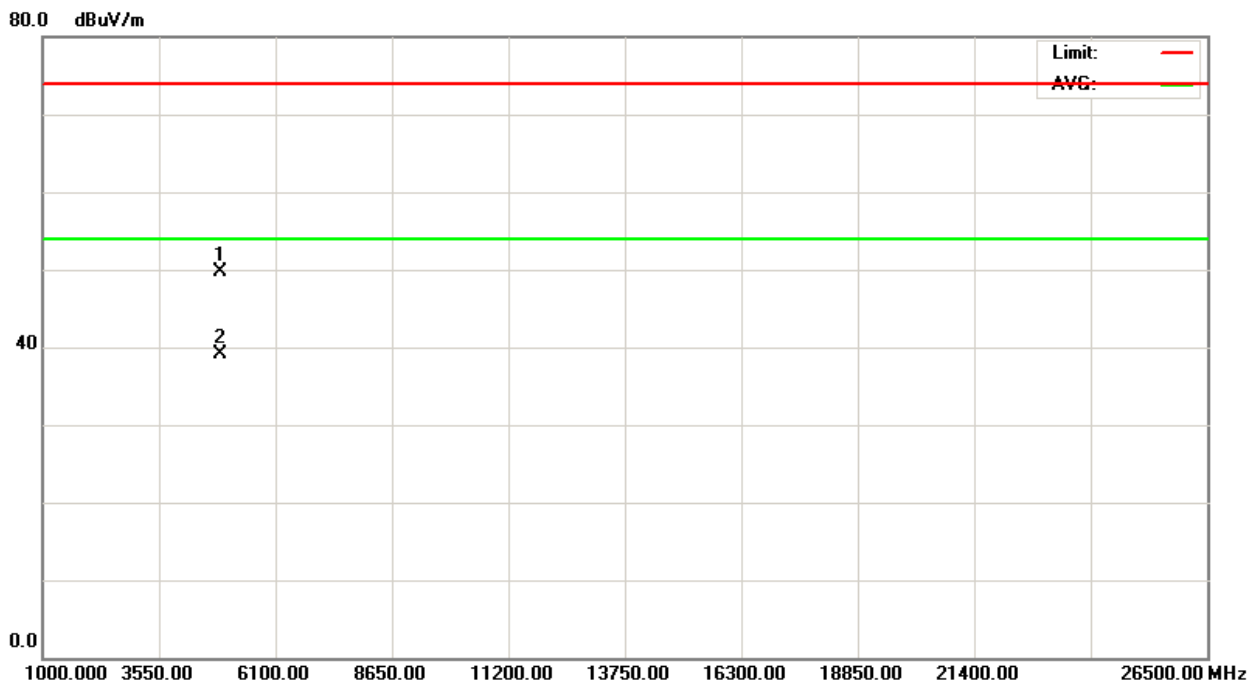
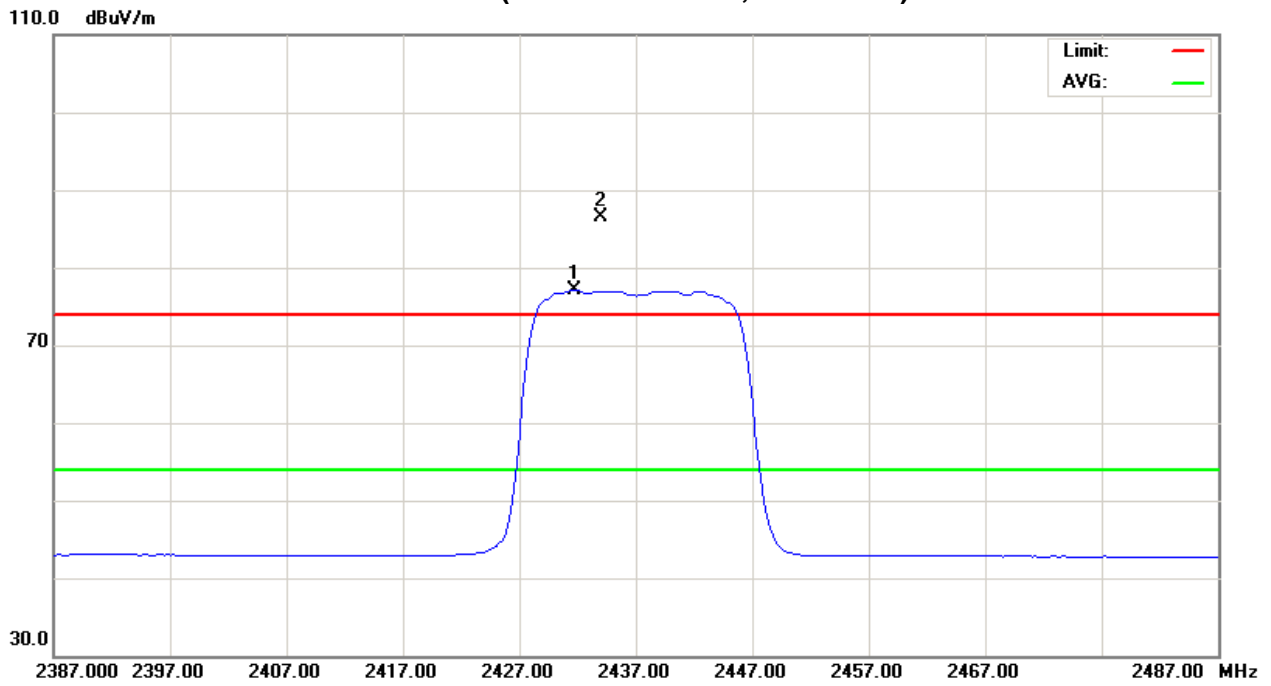



EUT :	150Mbps Wireless N USB Adapter	Model Name :	FWN-651ND
Temperature :	25 °C	Relative Humidity :	58 %
Pressure :	1010 hPa	Test Voltage :	AC 120V/60Hz
Test Mode :	TX N-20M MODE 2462MHz		

Freq.	Ant.Pol.	Reading		Ant./CF	Act.		Limit		Note
		Peak	AV		Peak	AV	Peak	AV	
(MHz)	H/V	(dBuV)	(dBuV)	CF(dB)	(dBuV/m)	(dBuV/m)	(dBuV/m)	(dBuV/m)	
<b>2459.00</b>	<b>V</b>	<b>67.66</b>	<b>57.86</b>	<b>31.83</b>	<b>99.49</b>	<b>89.69</b>			<b>X/F</b>
2483.50	V	22.03	11.53	31.80	53.83	43.33	74.00	54.00	X/E
4924.22	V	48.38	36.38	5.65	54.03	42.03	74.00	54.00	X/H

Remark :

- (1) All readings are Peak unless otherwise stated QP in column of 『Note』 . Peak denotes that the Peak reading compliance with the QP Limits and then QP Mode measurement didn't perform .
- (2) Measuring frequency range from 30MHz to 1000MHz or the 10th harmonic of highest fundamental frequency . "F" denotes fundamental frequency; "H" denotes spurious frequency. "E" denotes band edge frequency. (This judgment method includes the Band Edge Requirement.)
- (3) Radiated emissions measured in frequency range above 1000MHz were made with an instrument using Peak detector mode and AV detector mode of the emission .
- (4) Data of measurement within this frequency range shown " \* " in the table above means the reading of emissions are attenuated more than 20dB below the permissible limits or the field strength is too small to be measured.
- (5) A preamp and high pass filter were used for this test in order to provide sufficient measurement sensitivity.
- (6) EUT Orthogonal Axis :  
 "X" - denotes Laid on Table ; "Y" - denotes Vertical Stand ; "Z" - denotes Side Stand
- (7) During the measurements above 1 GHz it is taken care of that the EUT is always within the 3 dB cone of radiation BW of the used antenna



TX CH11 (Above 1000 MHz, Vertical)

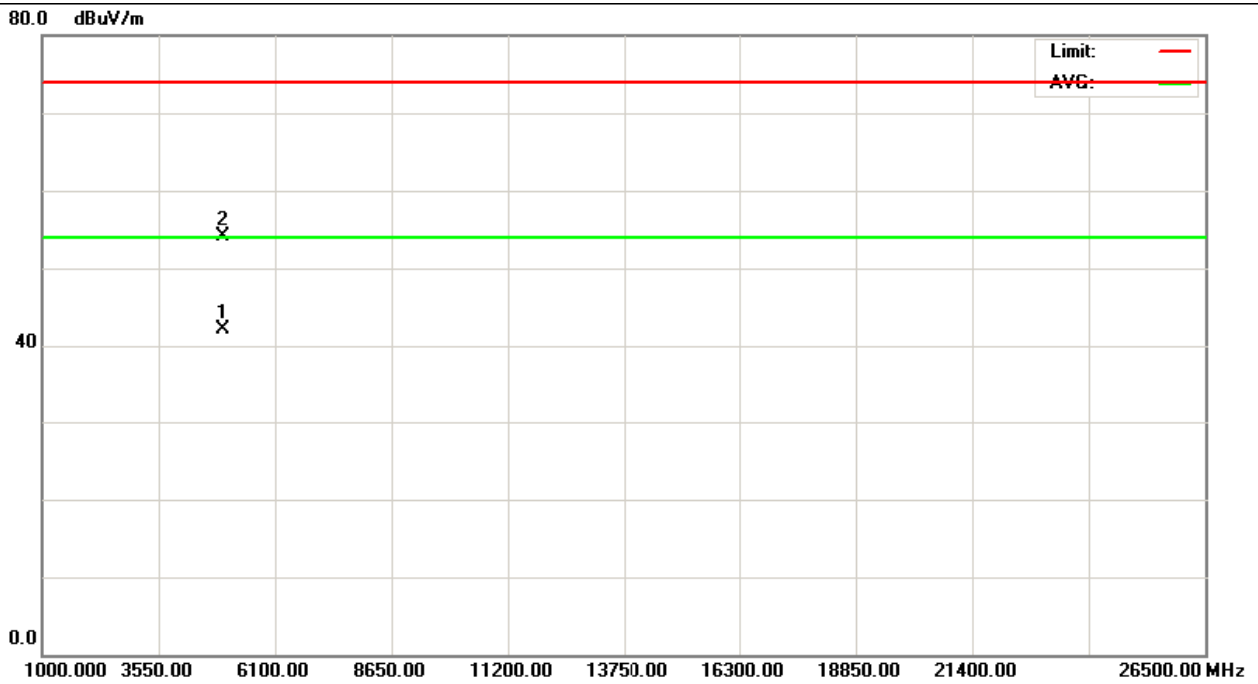
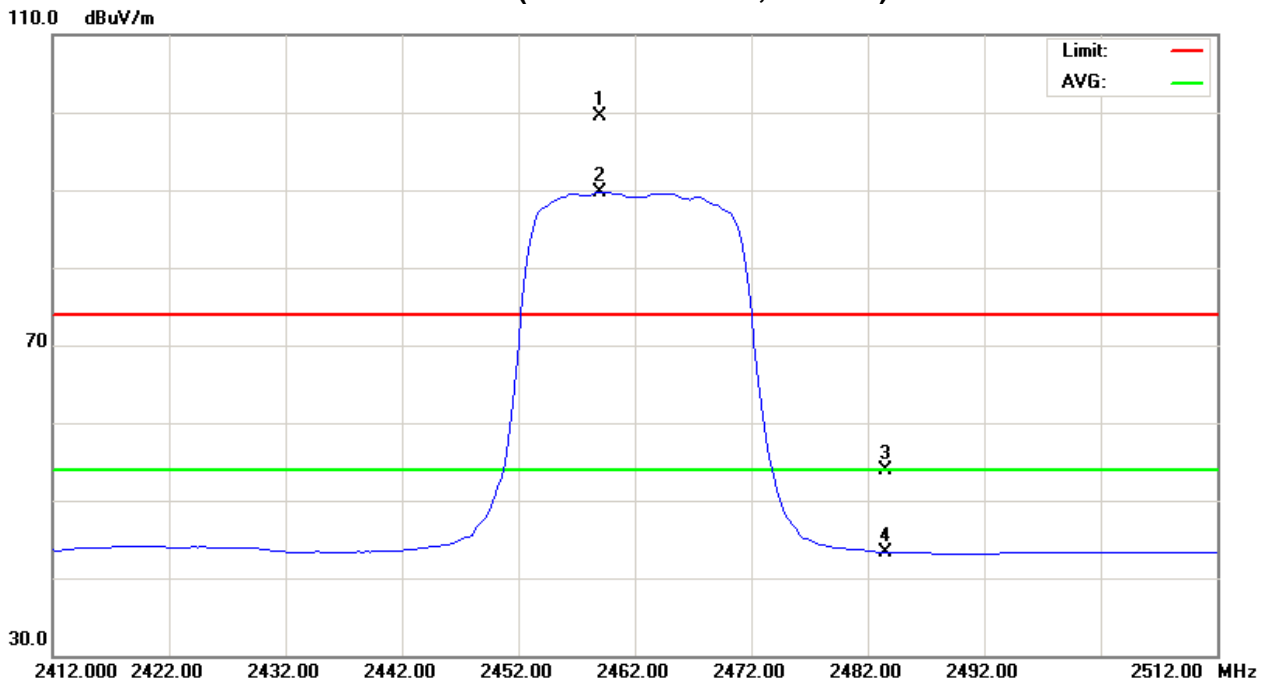



EUT :	150Mbps Wireless N USB Adapter	Model Name :	FWN-651ND
Temperature :	25 °C	Relative Humidity :	58 %
Pressure :	1010 hPa	Test Voltage :	AC 120V/60Hz
Test Mode :	TX N-20M MODE 2462MHz		

Freq.	Ant.Pol.	Reading		Ant./CF	Act.		Limit		Note
		Peak	AV		Peak	AV	Peak	AV	
(MHz)	H/V	(dBuV)	(dBuV)	CF(dB)	(dBuV/m)	(dBuV/m)	(dBuV/m)	(dBuV/m)	
<b>2456.75</b>	<b>H</b>	<b>56.92</b>	<b>45.99</b>	<b>31.84</b>	<b>88.76</b>	<b>77.83</b>			<b>X/F</b>
2483.50	H	23.20	10.97	31.80	55.00	42.77	74.00	54.00	X/E
4924.31	H	43.27	33.02	5.65	48.92	38.67	74.00	54.00	X/H

Remark :

- (1) All readings are Peak unless otherwise stated QP in column of 『Note』 . Peak denotes that the Peak reading compliance with the QP Limits and then QP Mode measurement didn't perform .
- (2) Measuring frequency range from 30MHz to 1000MHz or the 10th harmonic of highest fundamental frequency . "F" denotes fundamental frequency; "H" denotes spurious frequency. "E" denotes band edge frequency. (This judgment method includes the Band Edge Requirement.)
- (3) Radiated emissions measured in frequency range above 1000MHz were made with an instrument using Peak detector mode and AV detector mode of the emission .
- (4) Data of measurement within this frequency range shown " \* " in the table above means the reading of emissions are attenuated more than 20dB below the permissible limits or the field strength is too small to be measured.
- (5) A preamp and high pass filter were used for this test in order to provide sufficient measurement sensitivity.
- (6) EUT Orthogonal Axis :  
 "X" - denotes Laid on Table ; "Y" - denotes Vertical Stand ; "Z" - denotes Side Stand
- (7) During the measurements above 1 GHz it is taken care of that the EUT is always within the 3 dB cone of radiation BW of the used antenna



TX CH11 (Above 1000 MHz, Horizontal)

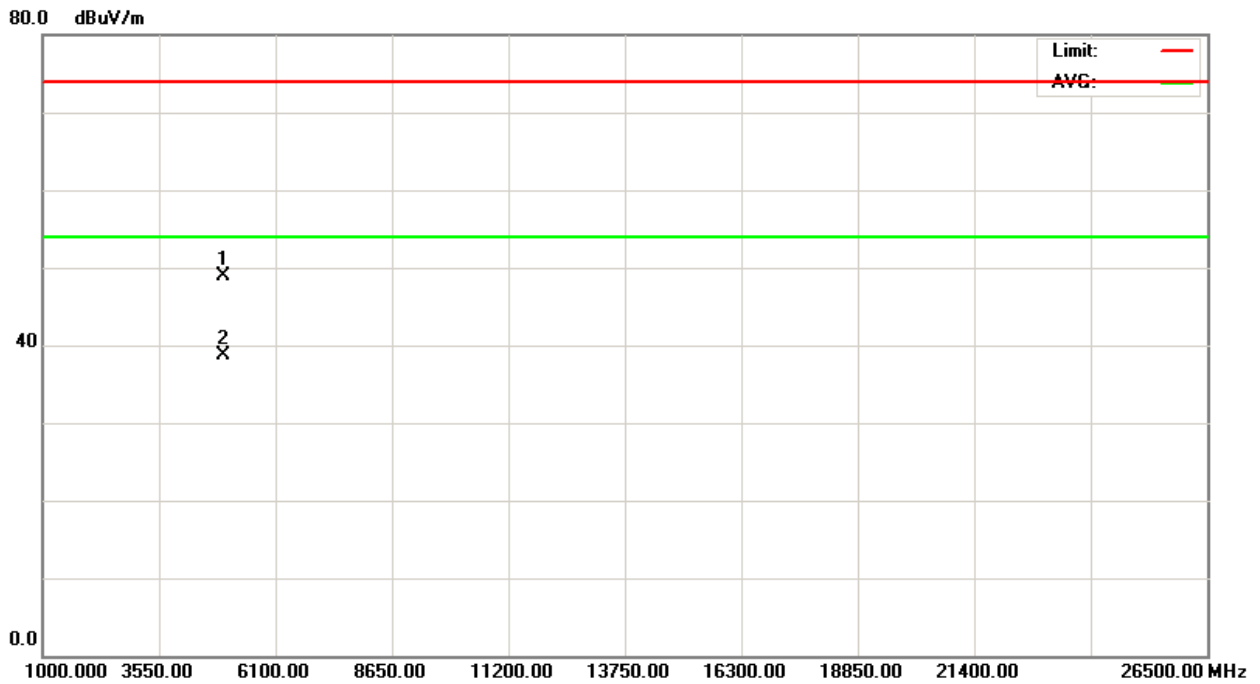
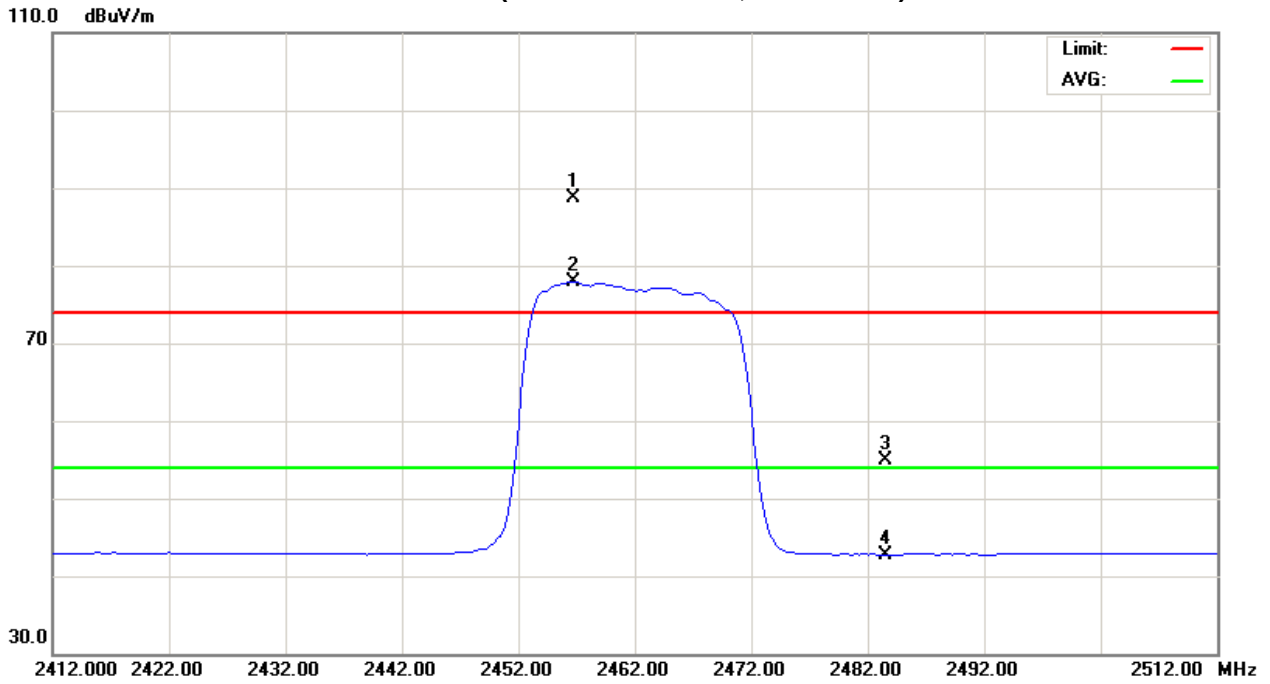



EUT :	150Mbps Wireless N USB Adapter	Model Name :	FWN-651ND
Temperature :	25 °C	Relative Humidity :	58 %
Pressure :	1010 hPa	Test Voltage :	AC 120V/60Hz
Test Mode :	TX N-40M MODE 2422MHz		

Freq. (MHz)	Ant.Pol. H/V	Reading		Ant./CF CF(dB)	Act.		Limit		Note
		Peak (dBuV)	AV (dBuV)		Peak (dBuV/m)	AV (dBuV/m)	Peak (dBuV/m)	AV (dBuV/m)	
2390.00	V	26.74	14.39	31.91	58.65	46.30	74.00	54.00	X/E
<b>2412.25</b>	<b>V</b>	<b>66.41</b>	<b>57.22</b>	<b>31.89</b>	<b>98.30</b>	<b>89.11</b>			<b>X/F</b>
4844.34	V	47.21	35.55	5.36	52.57	40.91	74.00	54.00	X/H

Remark :

- (1) All readings are Peak unless otherwise stated QP in column of 『Note』 . Peak denotes that the Peak reading compliance with the QP Limits and then QP Mode measurement didn't perform .
- (2) Measuring frequency range from 30MHz to 1000MHz or the 10th harmonic of highest fundamental frequency "F" denotes fundamental frequency; "H" denotes spurious frequency. "E" denotes band edge frequency. (This judgment method includes the Band Edge Requirement.)
- (3) Radiated emissions measured in frequency range above 1000MHz were made with an instrument using Peak detector mode and AV detector mode of the emission .
- (4) Data of measurement within this frequency range shown " \* " in the table above means the reading of emissions are attenuated more than 20dB below the permissible limits or the field strength is too small to be measured.
- (5) A preamp and high pass filter were used for this test in order to provide sufficient measurement sensitivity.
- (6) EUT Orthogonal Axis :  
"X" - denotes Laid on Table ; "Y" - denotes Vertical Stand ; "Z" - denotes Side Stand
- (7) During the measurements above 1 GHz it is taken care of that the EUT is always within the 3 dB cone of radiation BW of the used antenna





TX CH03 (Above 1000 MHz, Vertical)

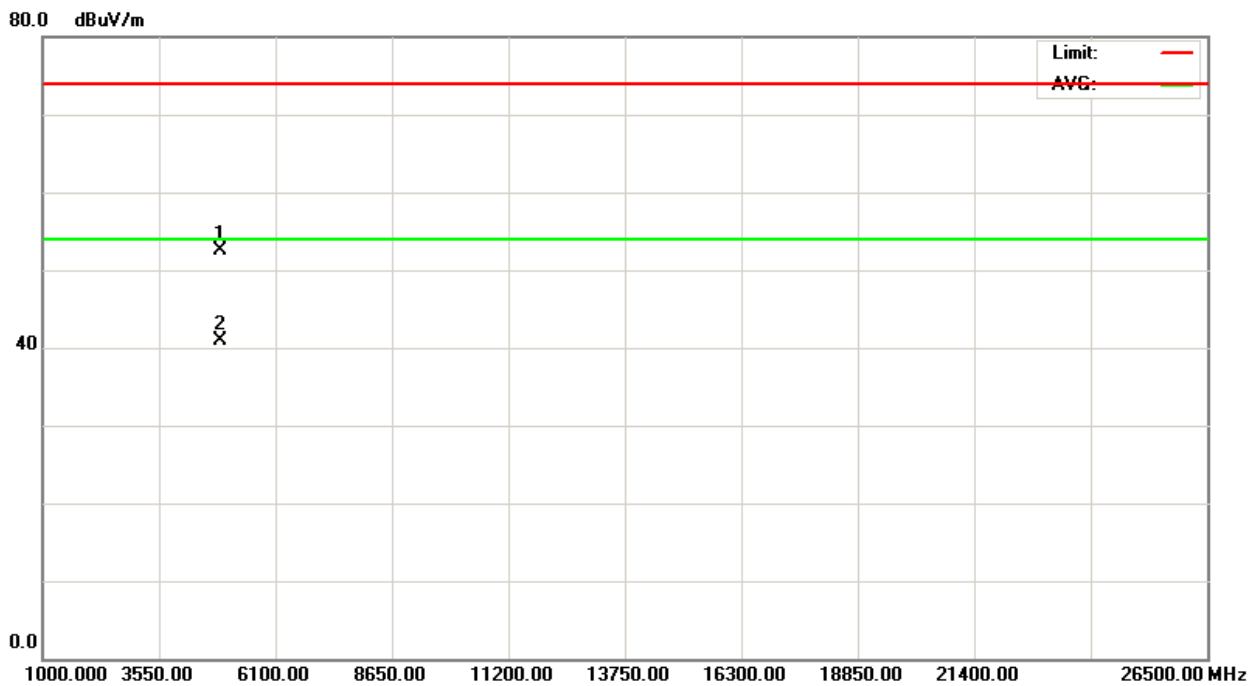
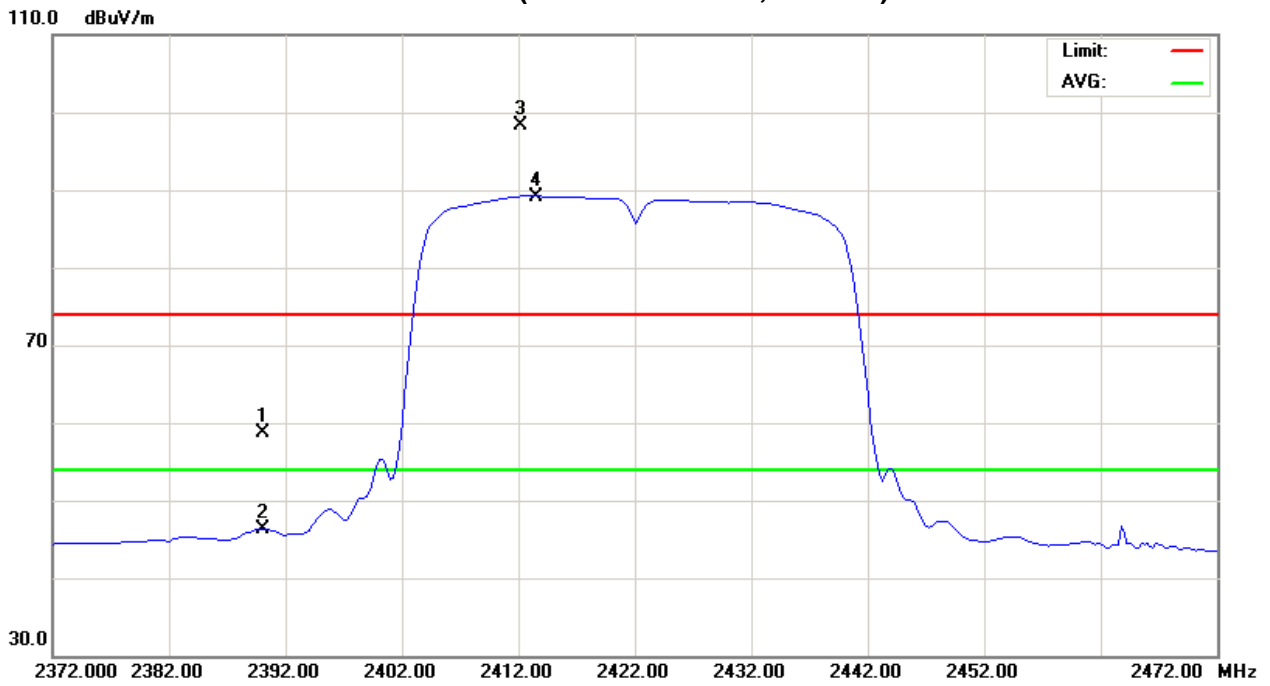



EUT :	150Mbps Wireless N USB Adapter	Model Name :	FWN-651ND
Temperature :	25 °C	Relative Humidity :	58 %
Pressure :	1010 hPa	Test Voltage :	AC 120V/60Hz
Test Mode :	TX N-40M MODE 2422MHz		

Freq.	Ant.Pol.	Reading		Ant./CF	Act.		Limit		Note
		Peak	AV		Peak	AV	Peak	AV	
(MHz)	H/V	(dBuV)	(dBuV)	CF(dB)	(dBuV/m)	(dBuV/m)	(dBuV/m)	(dBuV/m)	
2390.00	H	22.31	11.32	31.91	54.22	43.23	74.00	54.00	X/E
<b>2413.50</b>	<b>H</b>	<b>54.47</b>	<b>45.24</b>	<b>31.88</b>	<b>86.35</b>	<b>77.12</b>			<b>X/F</b>
4844.12	H	45.75	33.27	5.36	51.11	38.63	74.00	54.00	X/H

Remark :

- (1) All readings are Peak unless otherwise stated QP in column of 『Note』 . Peak denotes that the Peak reading compliance with the QP Limits and then QP Mode measurement didn't perform .
- (2) Measuring frequency range from 30MHz to 1000MHz or the 10th harmonic of highest fundamental frequency . "F" denotes fundamental frequency; "H" denotes spurious frequency. "E" denotes band edge frequency. (This judgment method includes the Band Edge Requirement.)
- (3) Radiated emissions measured in frequency range above 1000MHz were made with an instrument using Peak detector mode and AV detector mode of the emission .
- (4) Data of measurement within this frequency range shown " \* " in the table above means the reading of emissions are attenuated more than 20dB below the permissible limits or the field strength is too small to be measured.
- (5) A preamp and high pass filter were used for this test in order to provide sufficient measurement sensitivity.
- (6) EUT Orthogonal Axis :  
 "X" - denotes Laid on Table ; "Y" - denotes Vertical Stand ; "Z" - denotes Side Stand
- (7) During the measurements above 1 GHz it is taken care of that the EUT is always within the 3 dB cone of radiation BW of the used antenna



TX CH03 (Above 1000 MHz, Horizontal)

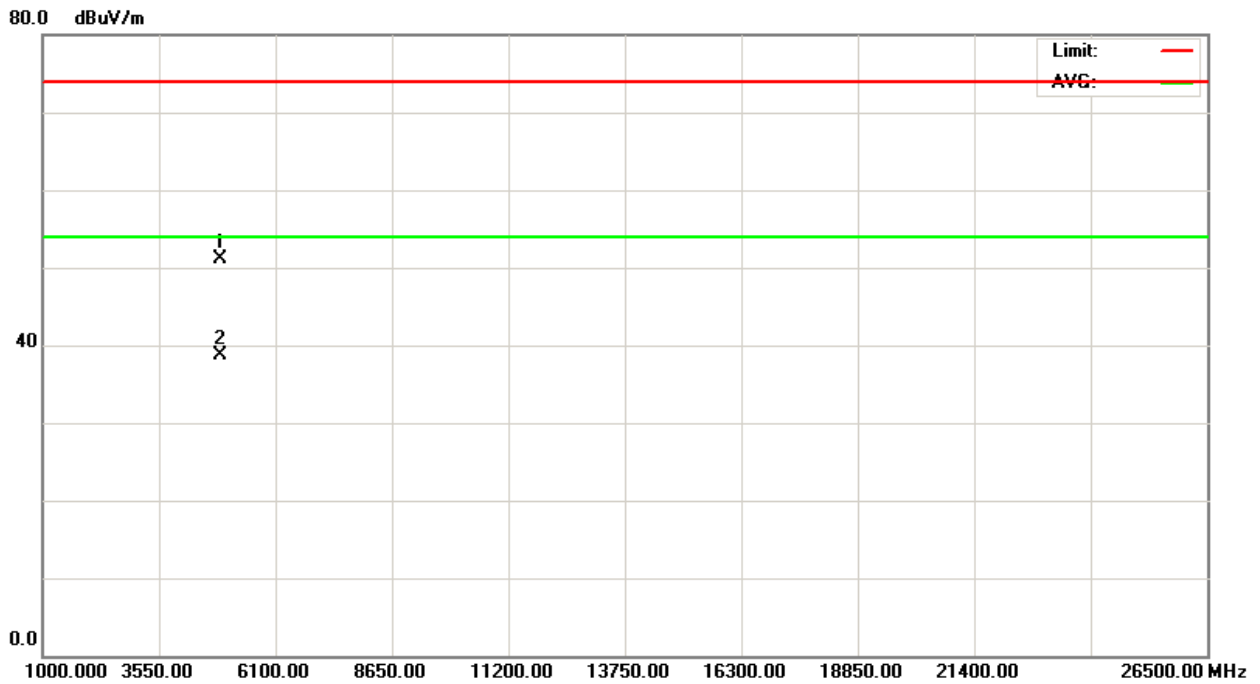
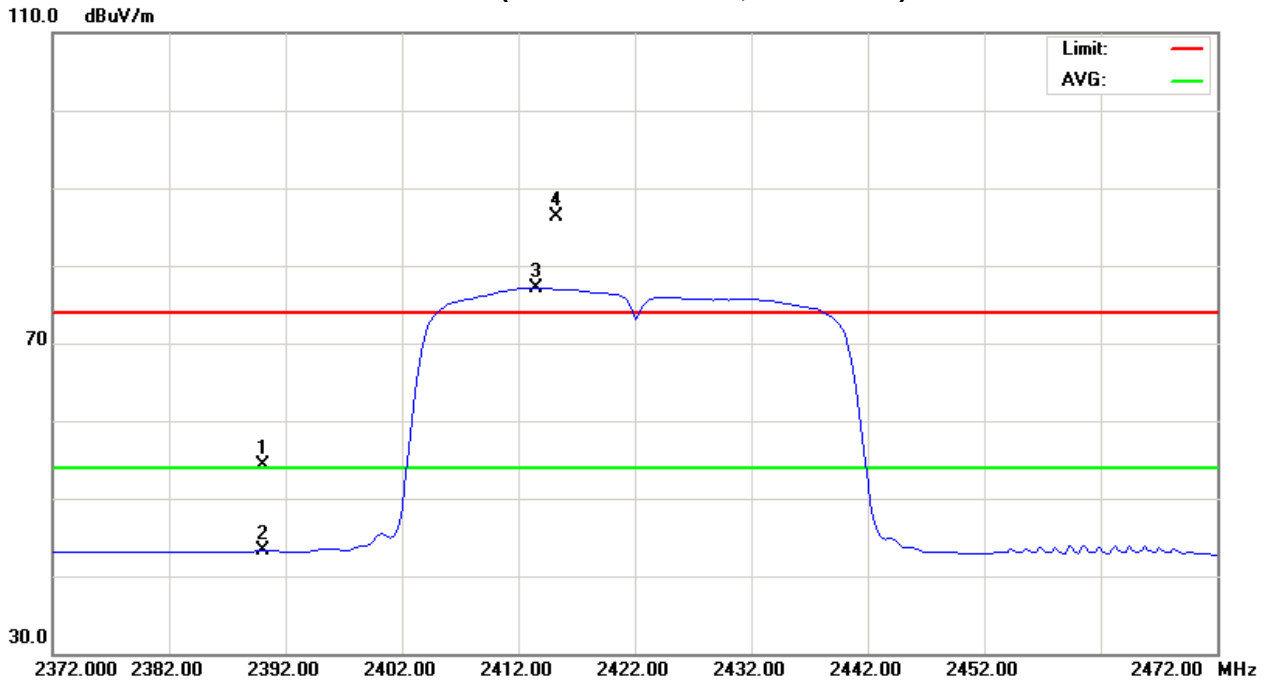



EUT :	150Mbps Wireless N USB Adapter	Model Name :	FWN-651ND
Temperature :	25 °C	Relative Humidity :	58 %
Pressure :	1010 hPa	Test Voltage :	AC 120V/60Hz
Test Mode :	TX N-40M MODE 2437MHz		

Freq. (MHz)	Ant.Pol. H/V	Reading		Ant./CF CF(dB)	Act.		Limit		Note
		Peak (dBuV)	AV (dBuV)		Peak (dBuV/m)	AV (dBuV/m)	Peak (dBuV/m)	AV (dBuV/m)	
<b>2427.25</b>	<b>V</b>	<b>64.66</b>	<b>55.49</b>	<b>31.87</b>	<b>96.53</b>	<b>87.36</b>			<b>X/F</b>
4874.05	V	47.50	36.53	5.47	52.97	42.00	74.00	54.00	X/H

Remark :

- (1) All readings are Peak unless otherwise stated QP in column of 『Note』 . Peak denotes that the Peak reading compliance with the QP Limits and then QP Mode measurement didn't perform ◦
- (2) Measuring frequency range from 30MHz to 1000MHz or the 10th harmonic of highest fundamental frequency ◦ "F" denotes fundamental frequency; "H" denotes spurious frequency. "E" denotes band edge frequency. (This judgment method includes the Band Edge Requirement.)
- (3) Radiated emissions measured in frequency range above 1000MHz were made with an instrument using Peak detector mode and AV detector mode of the emission ◦
- (4) Data of measurement within this frequency range shown " \* " in the table above means the reading of emissions are attenuated more than 20dB below the permissible limits or the field strength is too small to be measured.
- (5) A preamp and high pass filter were used for this test in order to provide sufficient measurement sensitivity.
- (6) EUT Orthogonal Axis :  
"X" - denotes Laid on Table ; "Y" - denotes Vertical Stand ; "Z" - denotes Side Stand
- (7) During the measurements above 1 GHz it is taken care of that the EUT is always within the 3 dB cone of radiation BW of the used antenna



TX CH06 (Above 1000 MHz, Vertical)

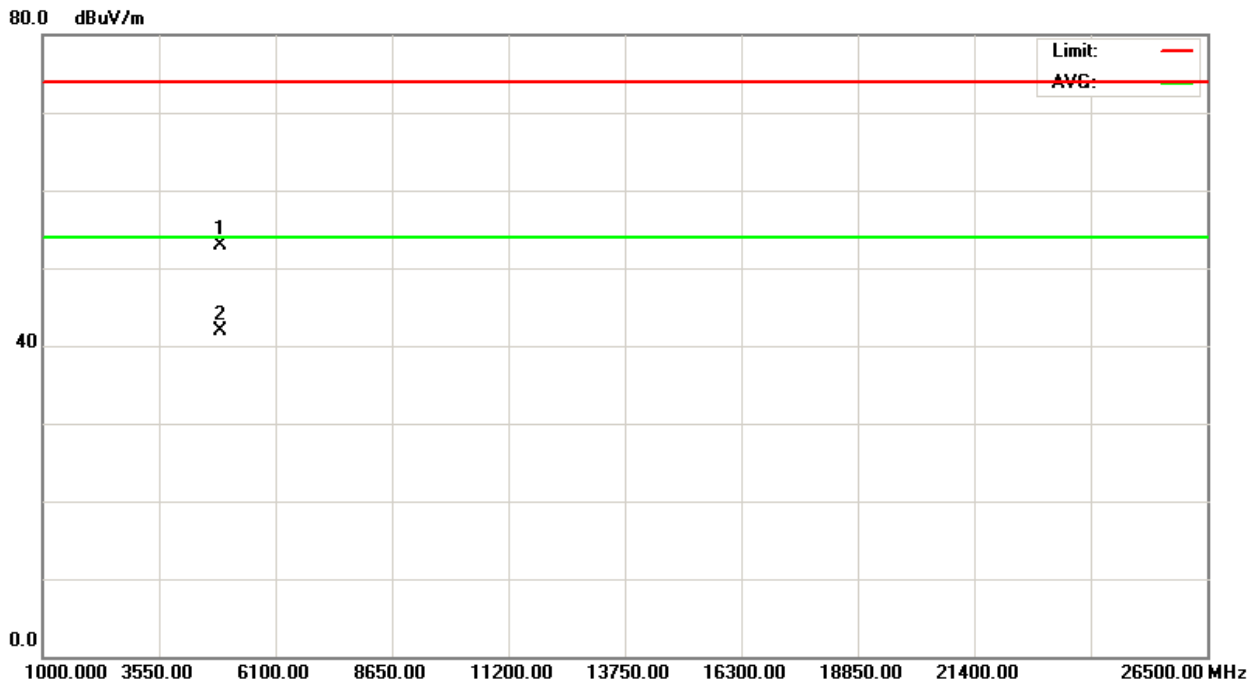
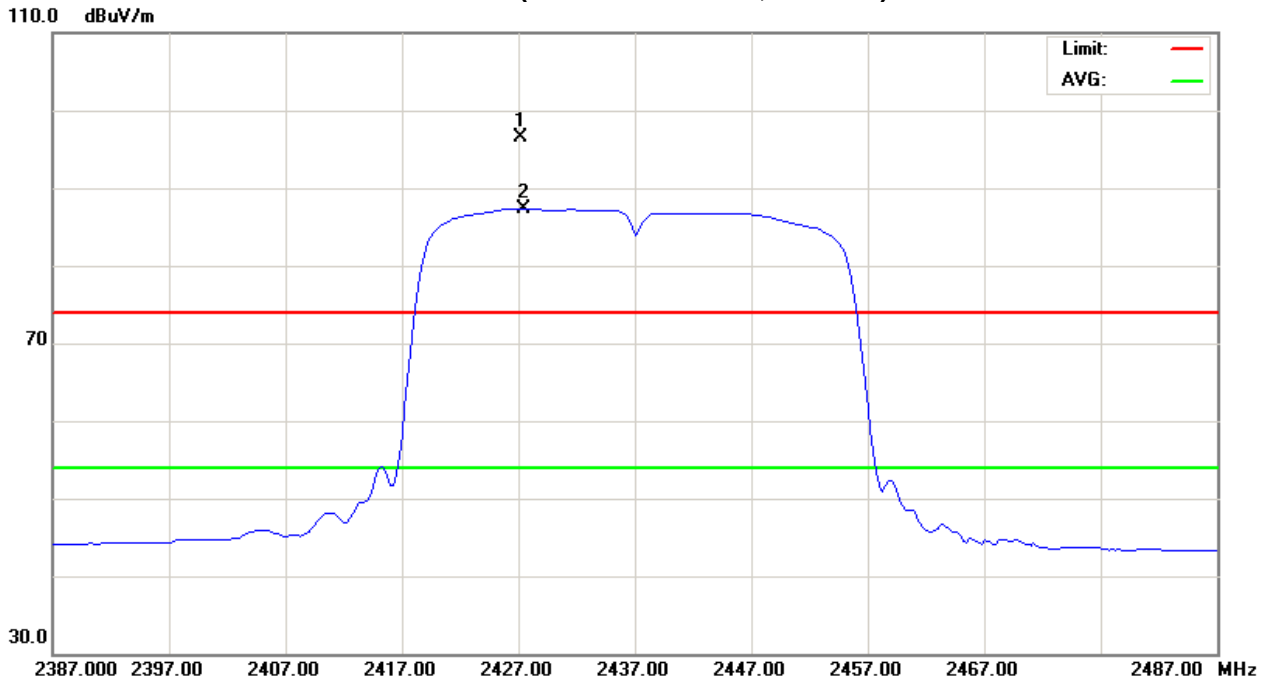



EUT :	150Mbps Wireless N USB Adapter	Model Name :	FWN-651ND
Temperature :	25 °C	Relative Humidity :	58 %
Pressure :	1010 hPa	Test Voltage :	AC 120V/60Hz
Test Mode :	TX N-40M MODE 2437MHZ		

Freq.	Ant.Pol.	Reading		Ant./CF	Act.		Limit		Note
		Peak	AV		Peak	AV	Peak	AV	
(MHz)	H/V	(dBuV)	(dBuV)	CF(dB)	(dBuV/m)	(dBuV/m)	(dBuV/m)	(dBuV/m)	
<b>2427.50</b>	<b>H</b>	<b>53.52</b>	<b>44.07</b>	<b>31.87</b>	<b>85.39</b>	<b>75.94</b>			<b>X/F</b>
4874.31	H	45.12	34.22	5.47	50.59	39.69	74.00	54.00	X/H

Remark :

- (1) All readings are Peak unless otherwise stated QP in column of 『Note』 . Peak denotes that the Peak reading compliance with the QP Limits and then QP Mode measurement didn't perform .
- (2) Measuring frequency range from 30MHz to 1000MHz or the 10th harmonic of highest fundamental frequency .“F” denotes fundamental frequency; “H” denotes spurious frequency. “E” denotes band edge frequency. (This judgment method includes the Band Edge Requirement.)
- (3) Radiated emissions measured in frequency range above 1000MHz were made with an instrument using Peak detector mode and AV detector mode of the emission .
- (4) Data of measurement within this frequency range shown “ \* ” in the table above means the reading of emissions are attenuated more than 20dB below the permissible limits or the field strength is too small to be measured.
- (5) A preamp and high pass filter were used for this test in order to provide sufficient measurement sensitivity.
- (6) EUT Orthogonal Axis :  
“X” - denotes Laid on Table ; “Y” - denotes Vertical Stand ; “Z” - denotes Side Stand
- (7) During the measurements above 1 GHz it is taken care of that the EUT is always within the 3 dB cone of radiation BW of the used antenna



TX CH06 (Above 1000 MHz, Horizontal)

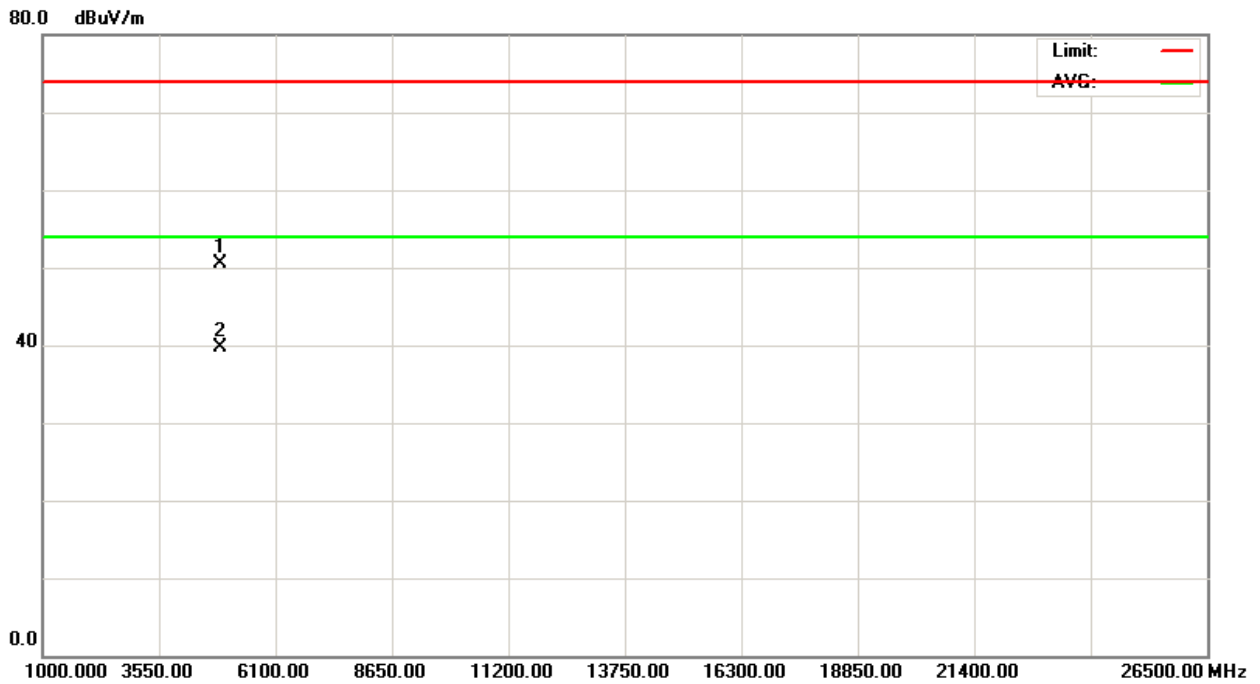
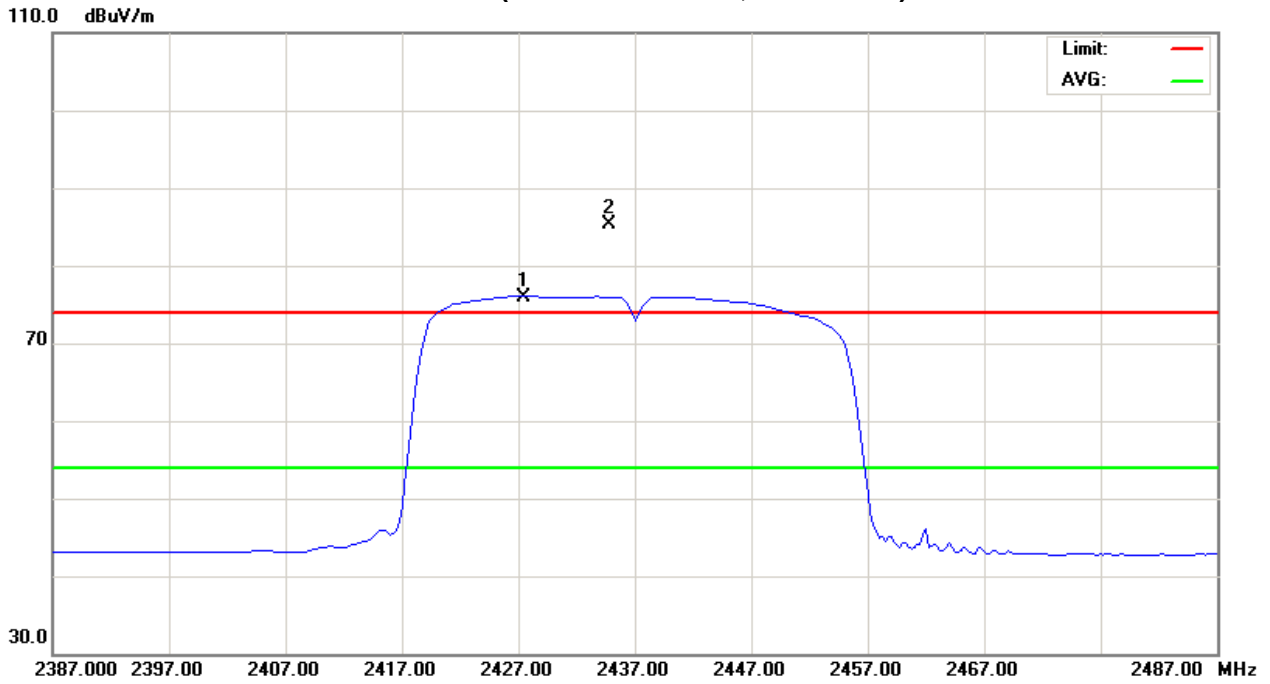



EUT :	150Mbps Wireless N USB Adapter	Model Name :	FWN-651ND
Temperature :	25 °C	Relative Humidity :	58 %
Pressure :	1010 hPa	Test Voltage :	AC 120V/60Hz
Test Mode :	TX N-40M MODE 2452MHz		

Freq.	Ant.Pol.	Reading		Ant./CF	Act.		Limit		Note
		Peak	AV		Peak	AV	Peak	AV	
(MHz)	H/V	(dBuV)	(dBuV)	CF(dB)	(dBuV/m)	(dBuV/m)	(dBuV/m)	(dBuV/m)	
<b>2442.25</b>	<b>V</b>	<b>66.04</b>	<b>56.75</b>	<b>31.85</b>	<b>97.89</b>	<b>88.60</b>			<b>X/F</b>
2483.50	V	24.05	12.83	31.80	55.85	44.63	74.00	54.00	X/E
4904.45	V	46.14	36.64	5.58	51.72	42.22	74.00	54.00	X/H

Remark :

- (1) All readings are Peak unless otherwise stated QP in column of 『Note』 . Peak denotes that the Peak reading compliance with the QP Limits and then QP Mode measurement didn't perform .
- (2) Measuring frequency range from 30MHz to 1000MHz or the 10th harmonic of highest fundamental frequency . "F" denotes fundamental frequency; "H" denotes spurious frequency. "E" denotes band edge frequency. (This judgment method includes the Band Edge Requirement.)
- (3) Radiated emissions measured in frequency range above 1000MHz were made with an instrument using Peak detector mode and AV detector mode of the emission .
- (4) Data of measurement within this frequency range shown " \* " in the table above means the reading of emissions are attenuated more than 20dB below the permissible limits or the field strength is too small to be measured.
- (5) A preamp and high pass filter were used for this test in order to provide sufficient measurement sensitivity.
- (6) EUT Orthogonal Axis :  
 "X" - denotes Laid on Table ; "Y" - denotes Vertical Stand ; "Z" - denotes Side Stand
- (7) During the measurements above 1 GHz it is taken care of that the EUT is always within the 3 dB cone of radiation BW of the used antenna





TX CH09 (Above 1000 MHz, Vertical)

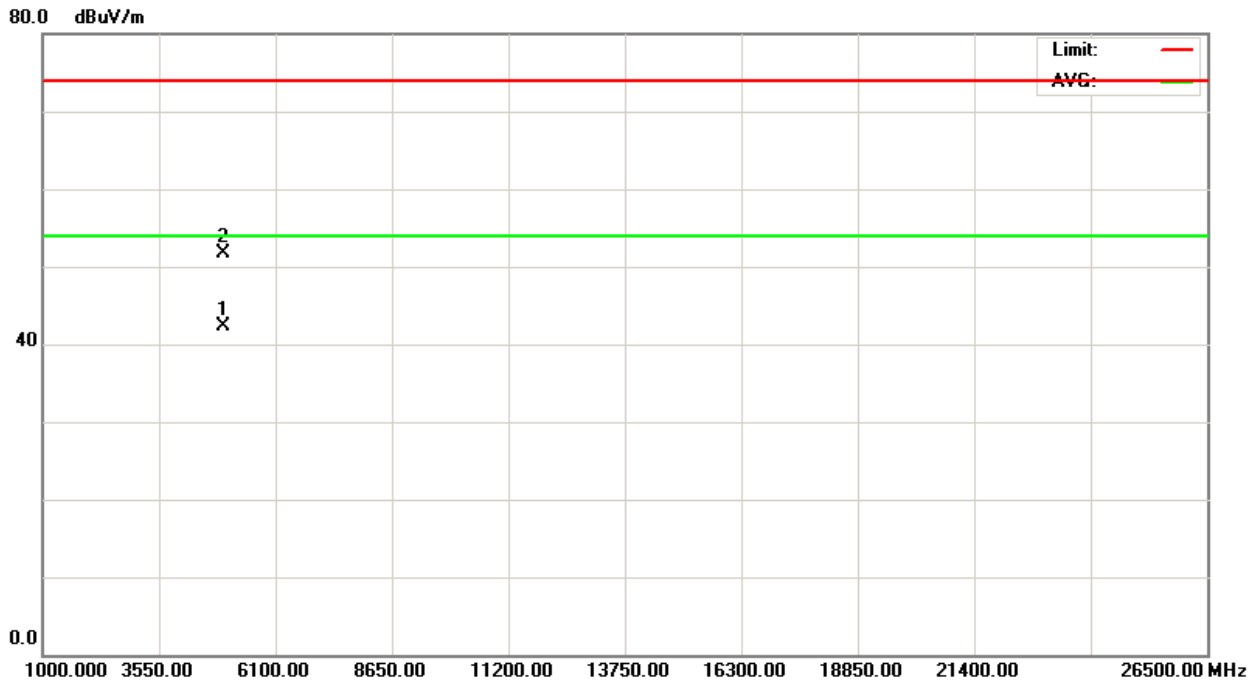
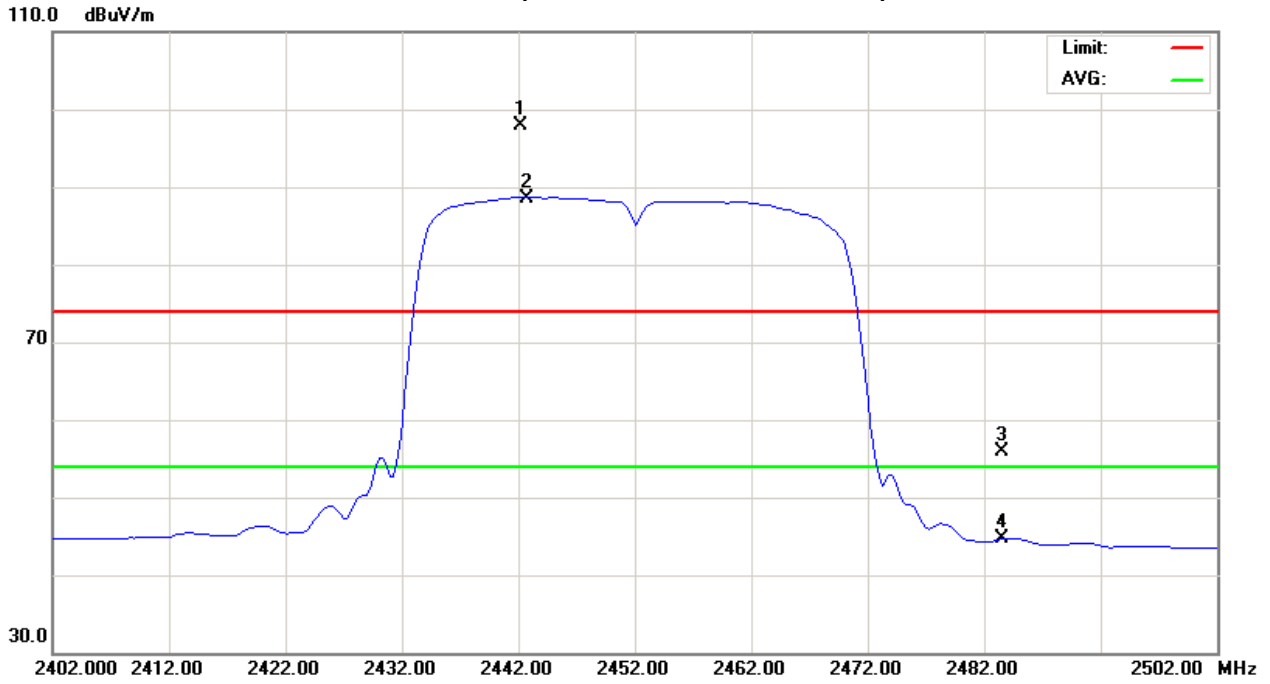



EUT :	150Mbps Wireless N USB Adapter	Model Name :	FWN-651ND
Temperature :	25 °C	Relative Humidity :	58 %
Pressure :	1010 hPa	Test Voltage :	AC 120V/60Hz
Test Mode :	TX N-40M MODE 2452MHz		

Freq.	Ant.Pol.	Reading		Ant./CF	Act.		Limit		Note
		Peak	AV		Peak	AV	Peak	AV	
(MHz)	H/V	(dBuV)	(dBuV)	CF(dB)	(dBuV/m)	(dBuV/m)	(dBuV/m)	(dBuV/m)	
<b>2442.75</b>	<b>H</b>	<b>55.29</b>	<b>45.68</b>	<b>31.85</b>	<b>87.14</b>	<b>77.53</b>			<b>X/F</b>
2483.50	H	22.90	11.29	31.80	54.70	43.09	74.00	54.00	X/E
4904.10	H	44.57	33.41	5.58	50.15	38.99	74.00	54.00	X/H

Remark :

- (1) All readings are Peak unless otherwise stated QP in column of 『Note』 . Peak denotes that the Peak reading compliance with the QP Limits and then QP Mode measurement didn't perform .
- (2) Measuring frequency range from 30MHz to 1000MHz or the 10th harmonic of highest fundamental frequency . "F" denotes fundamental frequency; "H" denotes spurious frequency. "E" denotes band edge frequency. (This judgment method includes the Band Edge Requirement.)
- (3) Radiated emissions measured in frequency range above 1000MHz were made with an instrument using Peak detector mode and AV detector mode of the emission .
- (4) Data of measurement within this frequency range shown " \* " in the table above means the reading of emissions are attenuated more than 20dB below the permissible limits or the field strength is too small to be measured.
- (5) A preamp and high pass filter were used for this test in order to provide sufficient measurement sensitivity.
- (6) EUT Orthogonal Axis :  
 "X" - denotes Laid on Table ; "Y" - denotes Vertical Stand ; "Z" - denotes Side Stand
- (7) During the measurements above 1 GHz it is taken care of that the EUT is always within the 3 dB cone of radiation BW of the used antenna



TX CH09 (Above 1000 MHz, Horizontal)

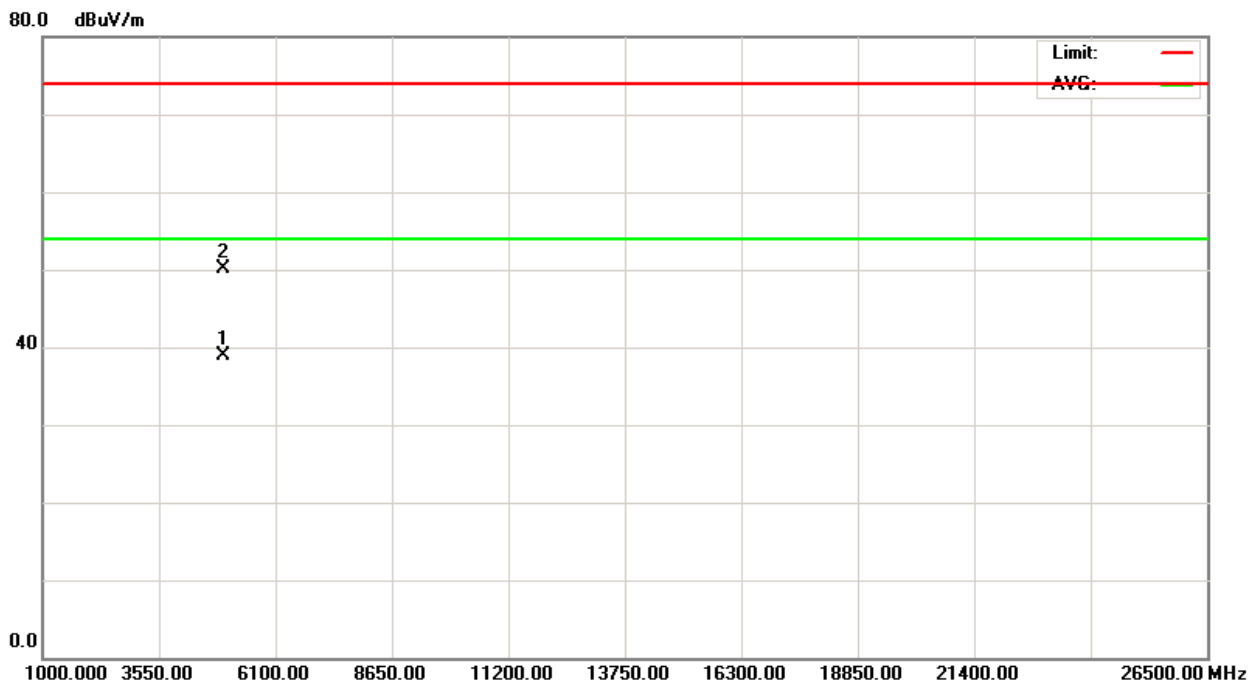
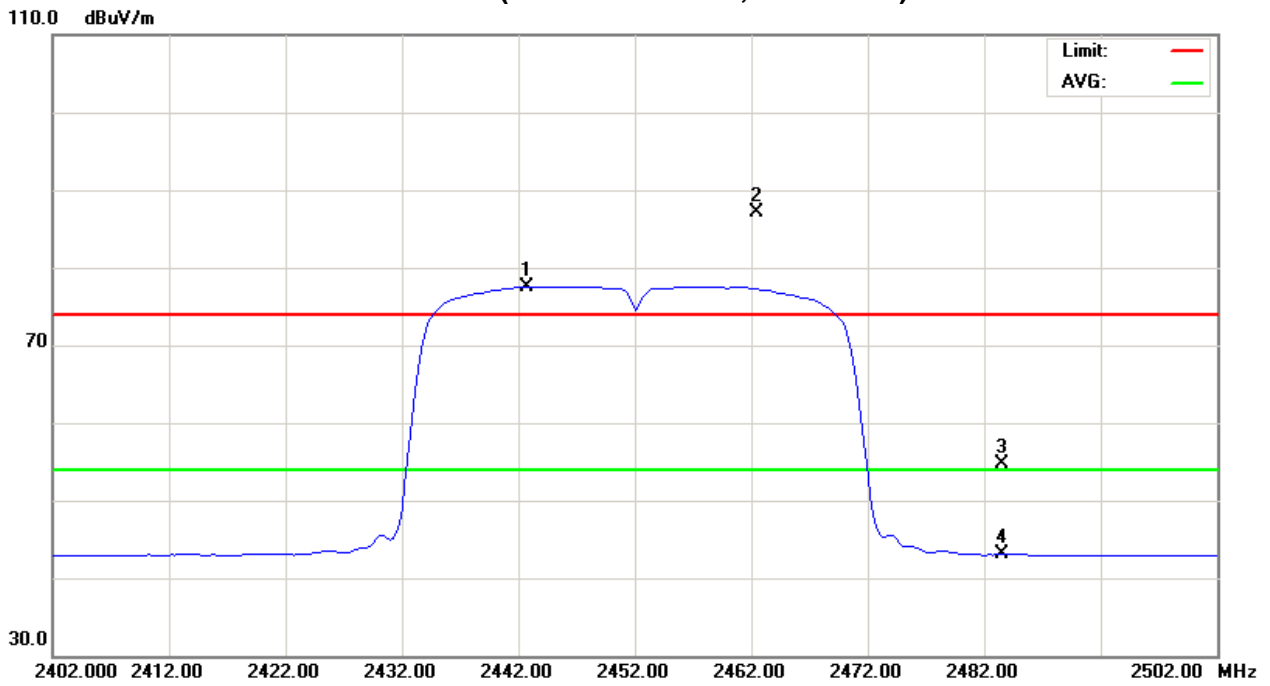



**4.2.9 TEST RESULTS (ABOVE 1000 MHZ)- FWN-651N**

EUT :	150Mbps Wireless N USB Adapter	Model Name :	FWN-651N
Temperature :	25 °C	Relative Humidity :	58 %
Pressure :	1010 hPa	Test Voltage :	AC 120V/60Hz
Test Mode :	TX B MODE 2412MHz		

Freq. (MHz)	Ant.Pol. H/V	Reading		Ant./CF CF(dB)	Act.		Limit		Note
		Peak (dBuV)	AV (dBuV)		Peak (dBuV/m)	AV (dBuV/m)	Peak (dBuV/m)	AV (dBuV/m)	
2390.00	V	21.28	12.68	31.91	53.19	44.59	74.00	54.00	X/E
<b>2411.00</b>	<b>V</b>	<b>65.28</b>	<b>58.90</b>	<b>31.89</b>	<b>97.17</b>	<b>90.79</b>			<b>X/F</b>
4824.23	V	46.74	34.91	5.29	52.03	40.20	74.00	54.00	X/H

Remark :

- (1) All readings are Peak unless otherwise stated QP in column of 『 Note 』 . Peak denotes that the Peak reading compliance with the QP Limits and then QP Mode measurement didn't perform .
- (2) Measuring frequency range from 30MHz to 1000MHz or the 10th harmonic of highest fundamental frequency .“F” denotes fundamental frequency; “H” denotes spurious frequency. “E” denotes band edge frequency. (This judgment method includes the Band Edge Requirement.)
- (3) Radiated emissions measured in frequency range above 1000MHz were made with an instrument using Peak detector mode and AV detector mode of the emission .
- (4) Data of measurement within this frequency range shown “ \* ” in the table above means the reading of emissions are attenuated more than 20dB below the permissible limits or the field strength is too small to be measured.
- (5) A preamp and high pass filter were used for this test in order to provide sufficient measurement sensitivity.
- (6) EUT Orthogonal Axis :  
“X” - denotes Laid on Table ; “Y” - denotes Vertical Stand ; “Z” - denotes Side Stand
- (7) During the measurements above 1 GHz it is taken care of that the EUT is always within the 3 dB cone of radiation BW of the used antenna



TX CH01 (Above 1000 MHz, Vertical)

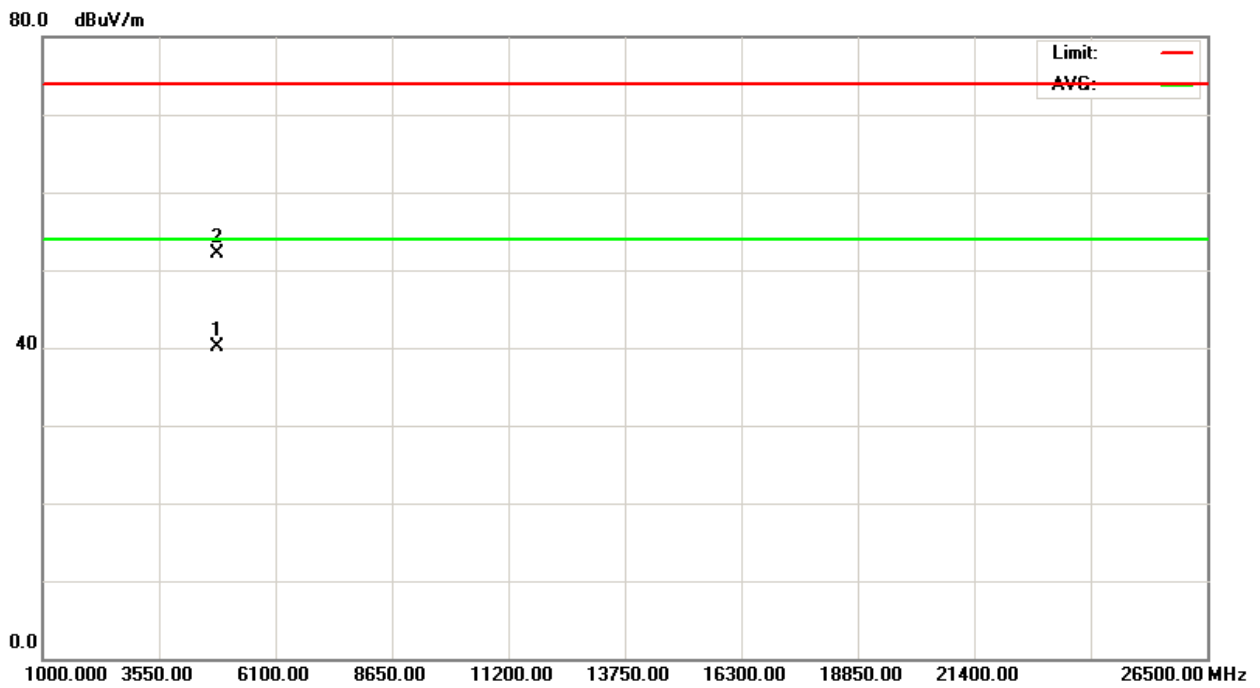
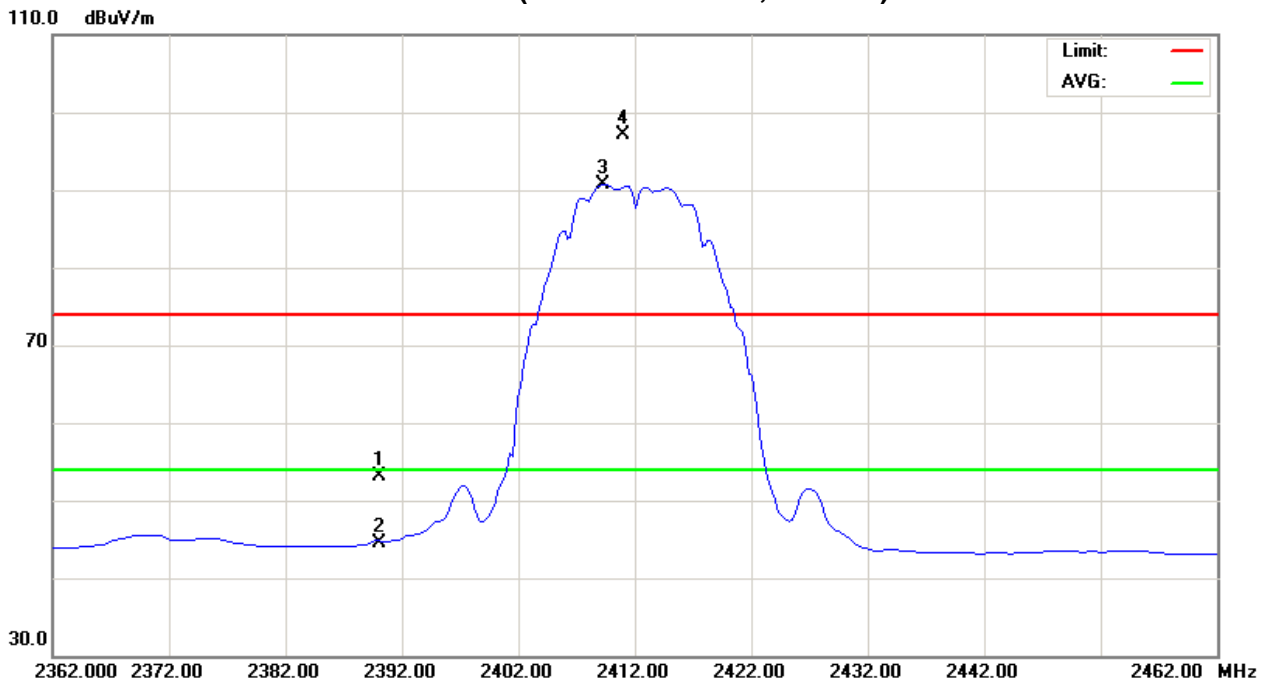



EUT :	150Mbps Wireless N USB Adapter	Model Name :	FWN-651N
Temperature :	25 °C	Relative Humidity :	58 %
Pressure :	1010 hPa	Test Voltage :	AC 120V/60Hz
Test Mode :	TX B MODE 2412MHz		

Freq. (MHz)	Ant.Pol. H/V	Reading		Ant./CF CF(dB)	Act.		Limit		Note
		Peak (dBuV)	AV (dBuV)		Peak (dBuV/m)	AV (dBuV/m)	Peak (dBuV/m)	AV (dBuV/m)	
2390.00	H	19.41	11.36	31.91	51.32	43.27	74.00	54.00	X/E
<b>2413.04</b>	<b>H</b>	<b>67.00</b>	<b>59.97</b>	<b>31.88</b>	<b>98.88</b>	<b>91.85</b>			<b>X/F</b>
4824.11	H	45.08	34.34	5.29	50.37	39.63	74.00	54.00	X/H

Remark :

- (1) All readings are Peak unless otherwise stated QP in column of 『Note』 . Peak denotes that the Peak reading compliance with the QP Limits and then QP Mode measurement didn't perform .
- (2) Measuring frequency range from 30MHz to 1000MHz or the 10th harmonic of highest fundamental frequency . "F" denotes fundamental frequency; "H" denotes spurious frequency. "E" denotes band edge frequency. (This judgment method includes the Band Edge Requirement.)
- (3) Radiated emissions measured in frequency range above 1000MHz were made with an instrument using Peak detector mode and AV detector mode of the emission .
- (4) Data of measurement within this frequency range shown " \* " in the table above means the reading of emissions are attenuated more than 20dB below the permissible limits or the field strength is too small to be measured.
- (5) A preamp and high pass filter were used for this test in order to provide sufficient measurement sensitivity.
- (6) EUT Orthogonal Axis :  
"X" - denotes Laid on Table ; "Y" - denotes Vertical Stand ; "Z" - denotes Side Stand
- (7) During the measurements above 1 GHz it is taken care of that the EUT is always within the 3 dB cone of radiation BW of the used antenna



TX CH01 (Above 1000 MHz, Horizontal)

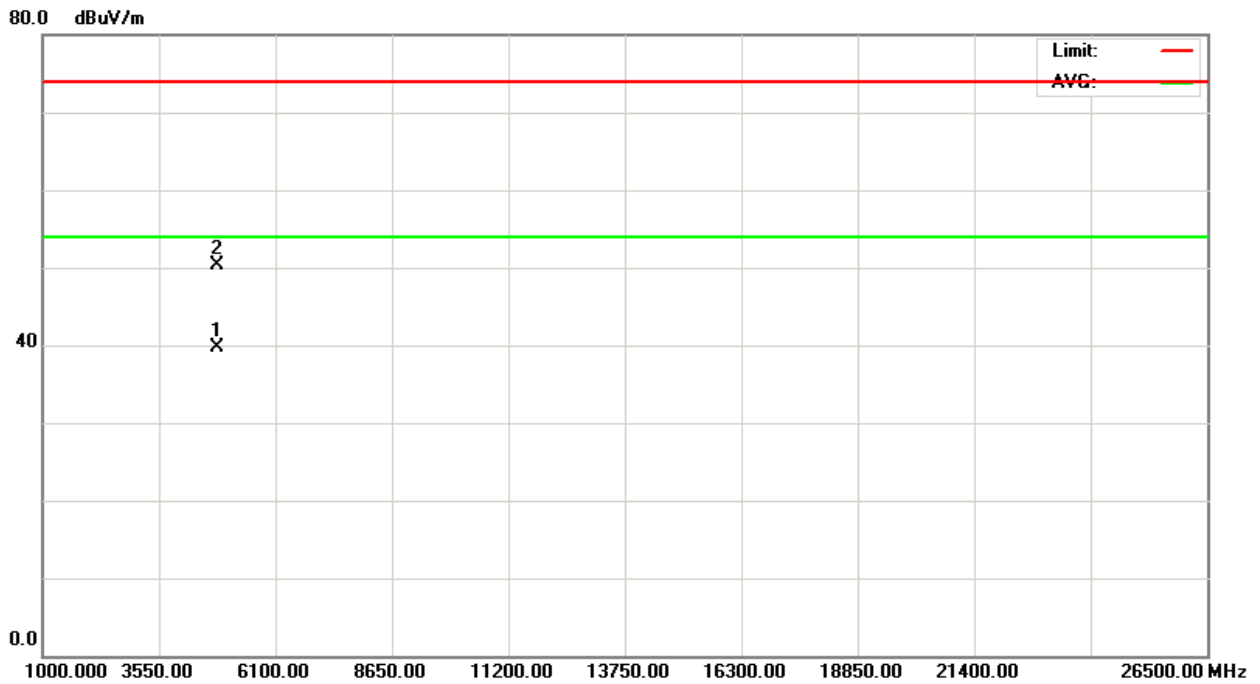
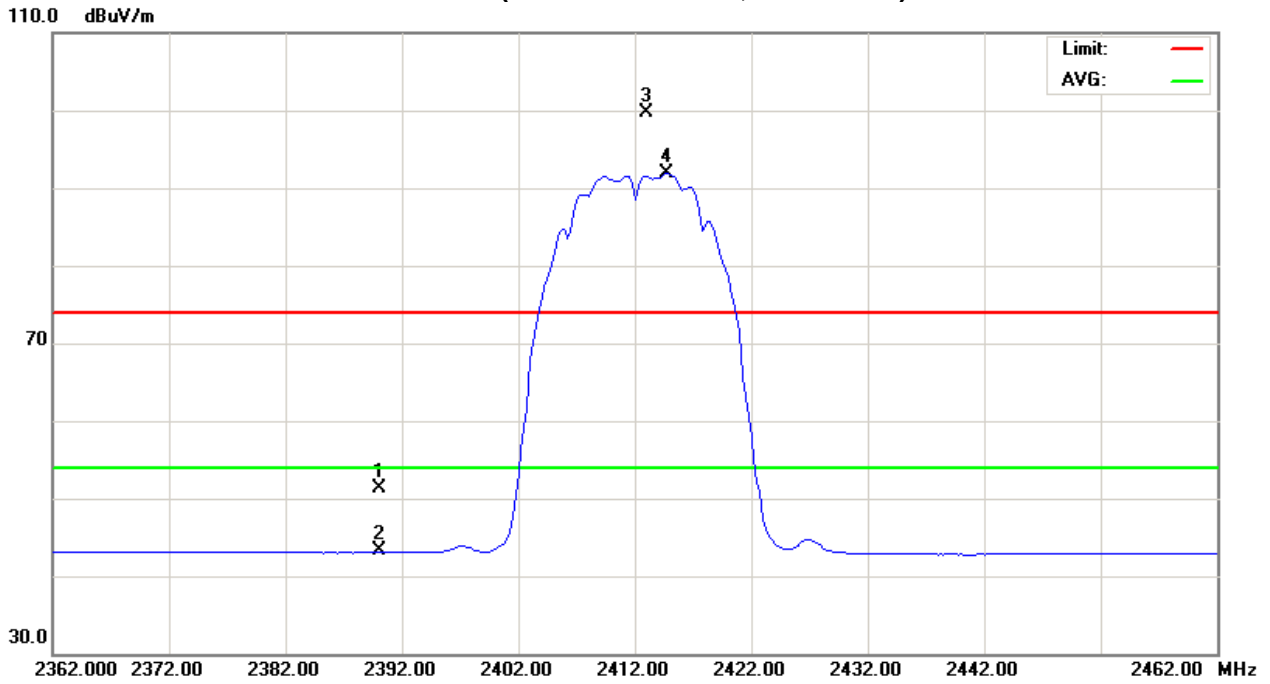



EUT :	150Mbps Wireless N USB Adapter	Model Name :	FWN-651N
Temperature :	25 °C	Relative Humidity :	58 %
Pressure :	1010 hPa	Test Voltage :	AC 120V/60Hz
Test Mode :	TX B MODE 2437MHz		

Freq.	Ant.Pol.	Reading		Ant./CF	Act.		Limit		Note
		Peak	AV		Peak	AV	Peak	AV	
(MHz)	H/V	(dBuV)	(dBuV)	CF(dB)	(dBuV/m)	(dBuV/m)	(dBuV/m)	(dBuV/m)	
<b>2434.25</b>	<b>V</b>	<b>64.57</b>	<b>62.07</b>	<b>31.86</b>	<b>96.43</b>	<b>93.93</b>			<b>X/F</b>
4874.29	V	45.41	33.31	5.47	50.88	38.78	74.00	54.00	X/H

Remark :

- (1) All readings are Peak unless otherwise stated QP in column of 『 Note 』 . Peak denotes that the Peak reading compliance with the QP Limits and then QP Mode measurement didn't perform .
- (2) Measuring frequency range from 30MHz to 1000MHz or the 10th harmonic of highest fundamental frequency .“F” denotes fundamental frequency; “H” denotes spurious frequency. “E” denotes band edge frequency. (This judgment method includes the Band Edge Requirement.)
- (3) Radiated emissions measured in frequency range above 1000MHz were made with an instrument using Peak detector mode and AV detector mode of the emission .
- (4) Data of measurement within this frequency range shown “ \* ” in the table above means the reading of emissions are attenuated more than 20dB below the permissible limits or the field strength is too small to be measured.
- (5) A preamp and high pass filter were used for this test in order to provide sufficient measurement sensitivity.
- (6) EUT Orthogonal Axis :  
“X” - denotes Laid on Table ; “Y” - denotes Vertical Stand ; “Z” - denotes Side Stand
- (7) During the measurements above 1 GHz it is taken care of that the EUT is always within the 3 dB cone of radiation BW of the used antenna





TX CH06 (Above 1000 MHz, Vertical)

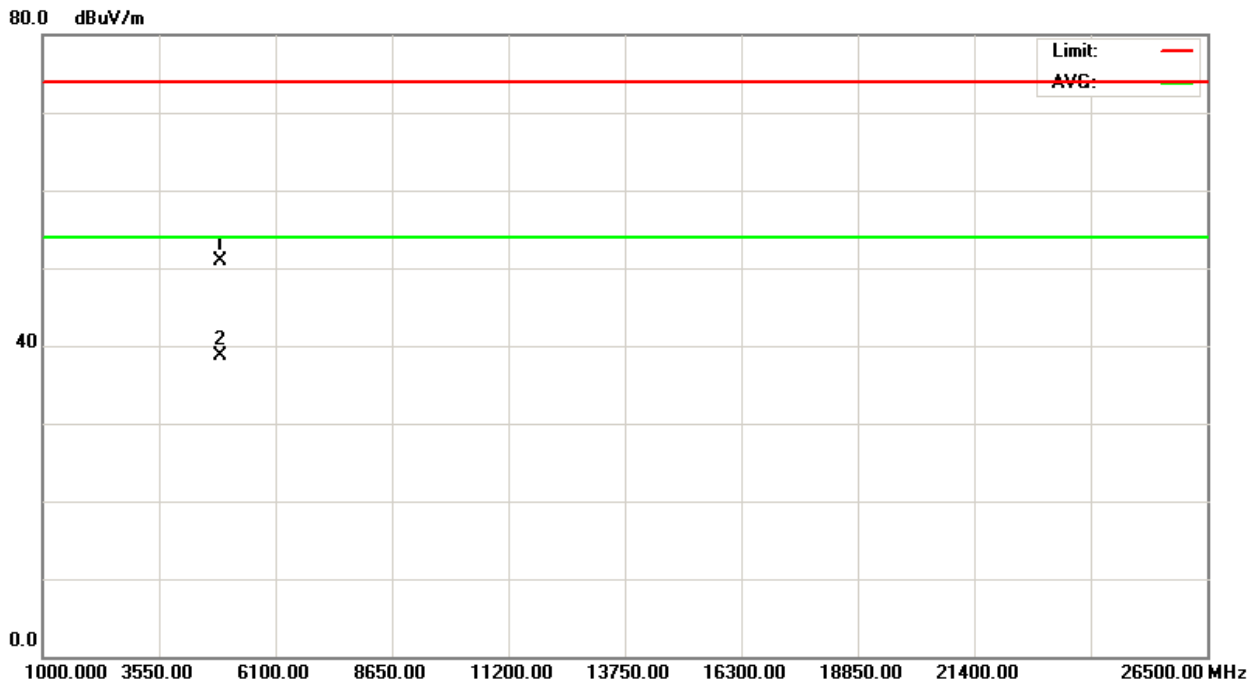
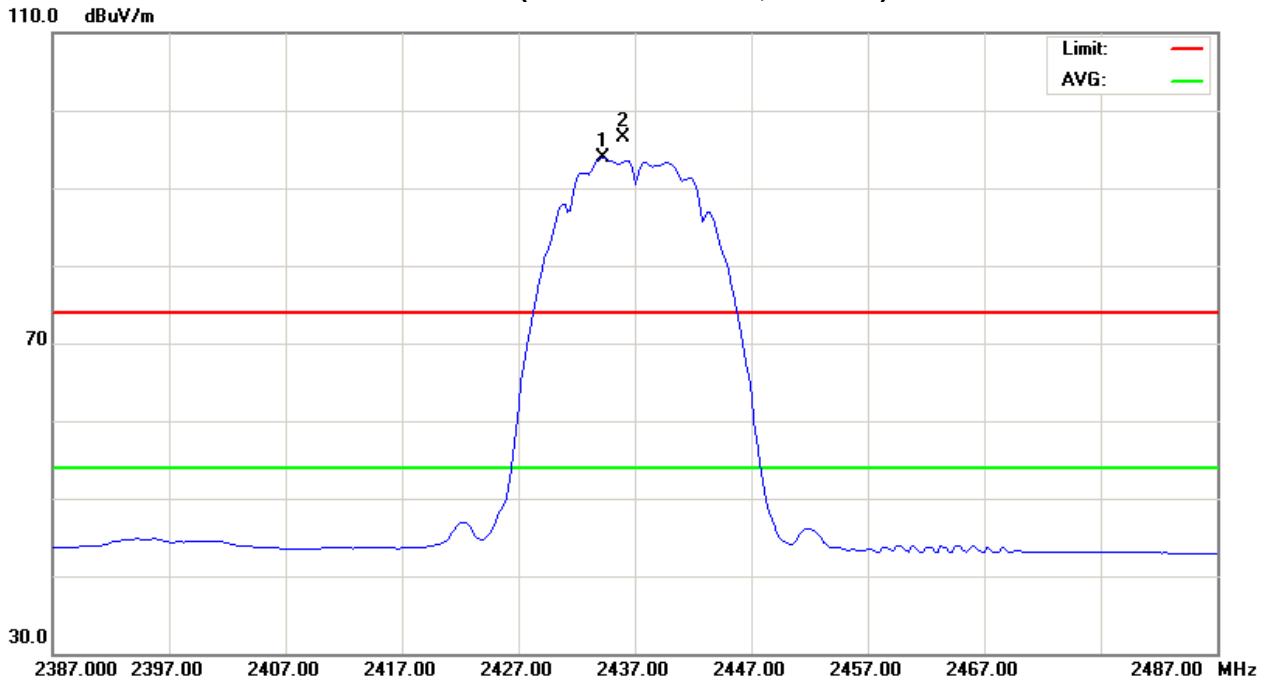



EUT :	150Mbps Wireless N USB Adapter	Model Name :	FWN-651N
Temperature :	25 °C	Relative Humidity :	58 %
Pressure :	1010 hPa	Test Voltage :	AC 120V/60Hz
Test Mode :	TX B MODE 2437MHz		

Freq. (MHz)	Ant.Pol. H/V	Reading		Ant./CF CF(dB)	Act.		Limit		Note
		Peak (dBuV)	AV (dBuV)		Peak (dBuV/m)	AV (dBuV/m)	Peak (dBuV/m)	AV (dBuV/m)	
<b>2434.25</b>	<b>H</b>	<b>64.52</b>	<b>60.25</b>	<b>31.86</b>	<b>96.38</b>	<b>92.11</b>			<b>X/F</b>
4874.10	H	44.72	33.30	5.47	50.19	38.77	74.00	54.00	X/H

Remark :

- (1) All readings are Peak unless otherwise stated QP in column of 『 Note 』 . Peak denotes that the Peak reading compliance with the QP Limits and then QP Mode measurement didn't perform .
- (2) Measuring frequency range from 30MHz to 1000MHz or the 10th harmonic of highest fundamental frequency "F" denotes fundamental frequency; "H" denotes spurious frequency. "E" denotes band edge frequency. (This judgment method includes the Band Edge Requirement.)
- (3) Radiated emissions measured in frequency range above 1000MHz were made with an instrument using Peak detector mode and AV detector mode of the emission .
- (4) Data of measurement within this frequency range shown " \* " in the table above means the reading of emissions are attenuated more than 20dB below the permissible limits or the field strength is too small to be measured.
- (5) A preamp and high pass filter were used for this test in order to provide sufficient measurement sensitivity.
- (6) EUT Orthogonal Axis :  
"X" - denotes Laid on Table ; "Y" - denotes Vertical Stand ; "Z" - denotes Side Stand
- (7) During the measurements above 1 GHz it is taken care of that the EUT is always within the 3 dB cone of radiation BW of the used antenna



TX CH06 (Above 1000 MHz, Horizontal)

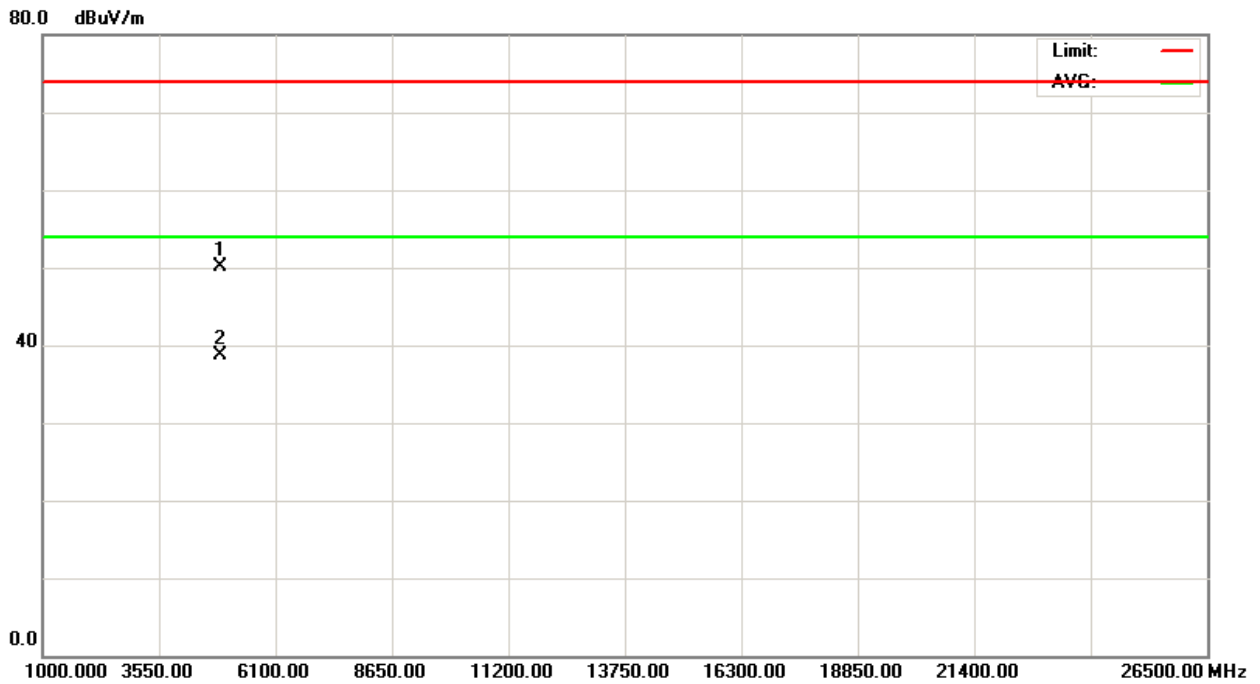
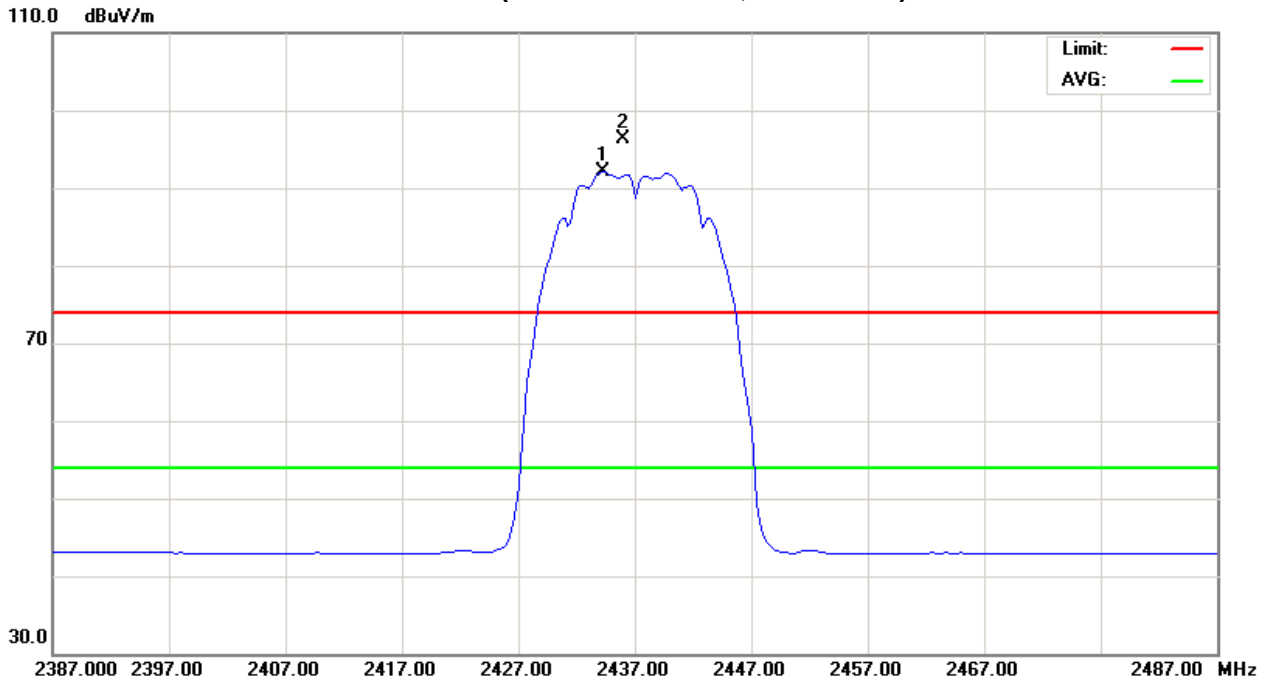



EUT :	150Mbps Wireless N USB Adapter	Model Name :	FWN-651N
Temperature :	25 °C	Relative Humidity :	58 %
Pressure :	1010 hPa	Test Voltage :	AC 120V/60Hz
Test Mode :	TX B MODE 2462MHz		

Freq.	Ant.Pol.	Reading		Ant./CF	Act.		Limit		Note
		Peak	AV		Peak	AV	Peak	AV	
(MHz)	H/V	(dBuV)	(dBuV)	CF(dB)	(dBuV/m)	(dBuV/m)	(dBuV/m)	(dBuV/m)	
<b>2459.25</b>	<b>V</b>	<b>59.34</b>	<b>56.90</b>	<b>31.83</b>	<b>91.17</b>	<b>88.73</b>			<b>X/F</b>
2483.50	V	22.53	11.30	31.80	54.33	43.10	74.00	54.00	X/E
4924.15	V	47.25	36.25	5.65	52.90	41.90	74.00	54.00	X/H

Remark :

- (1) All readings are Peak unless otherwise stated QP in column of 『Note』 . Peak denotes that the Peak reading compliance with the QP Limits and then QP Mode measurement didn't perform .
- (2) Measuring frequency range from 30MHz to 1000MHz or the 10th harmonic of highest fundamental frequency . "F" denotes fundamental frequency; "H" denotes spurious frequency. "E" denotes band edge frequency. (This judgment method includes the Band Edge Requirement.)
- (3) Radiated emissions measured in frequency range above 1000MHz were made with an instrument using Peak detector mode and AV detector mode of the emission .
- (4) Data of measurement within this frequency range shown " \* " in the table above means the reading of emissions are attenuated more than 20dB below the permissible limits or the field strength is too small to be measured.
- (5) A preamp and high pass filter were used for this test in order to provide sufficient measurement sensitivity.
- (6) EUT Orthogonal Axis :  
 "X" - denotes Laid on Table ; "Y" - denotes Vertical Stand ; "Z" - denotes Side Stand
- (7) During the measurements above 1 GHz it is taken care of that the EUT is always within the 3 dB cone of radiation BW of the used antenna



TX CH11 (Above 1000 MHz, Vertical)

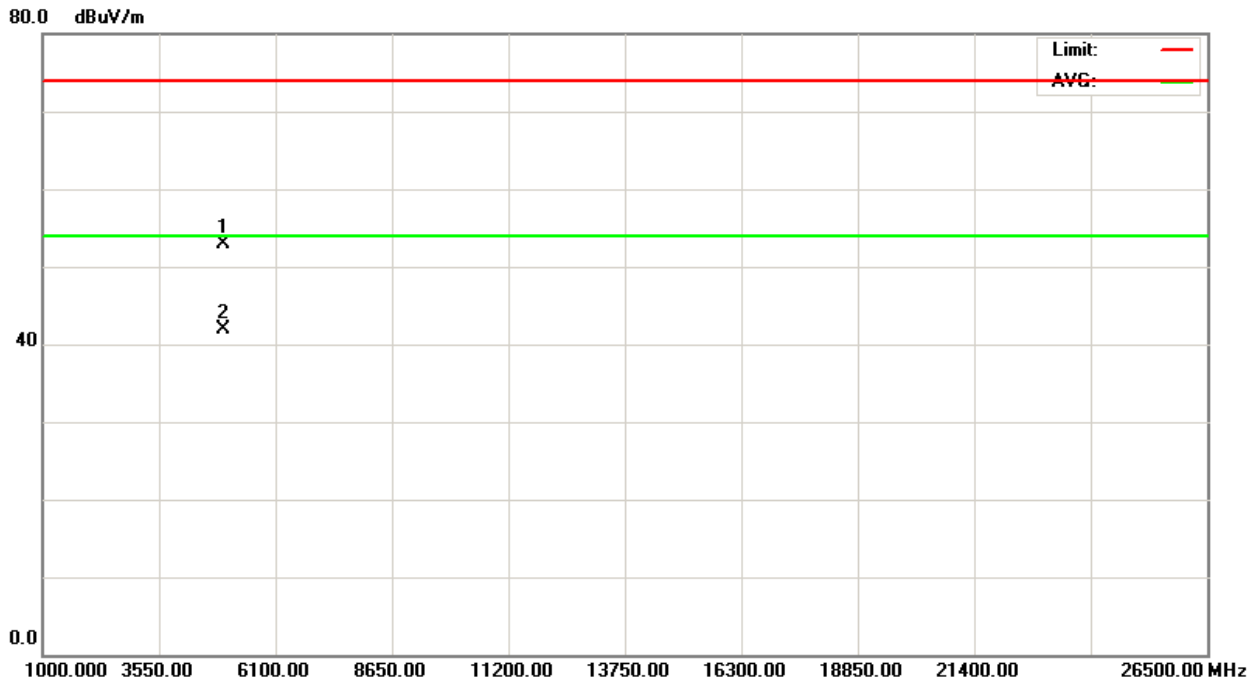
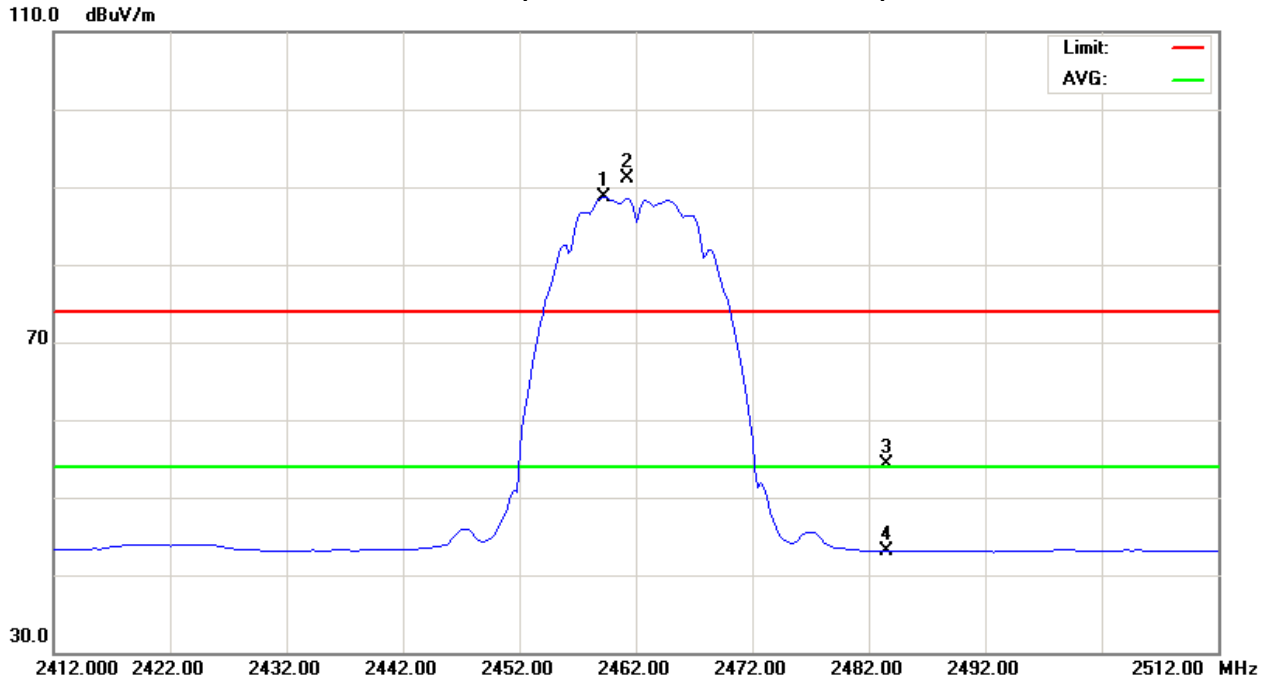



EUT :	150Mbps Wireless N USB Adapter	Model Name :	FWN-651N
Temperature :	25 °C	Relative Humidity :	58 %
Pressure :	1010 hPa	Test Voltage :	AC 120V/60Hz
Test Mode :	TX B MODE 2462MHz		

Freq.	Ant.Pol.	Reading		Ant./CF	Act.		Limit		Note
		Peak	AV		Peak	AV	Peak	AV	
(MHz)	H/V	(dBuV)	(dBuV)	CF(dB)	(dBuV/m)	(dBuV/m)	(dBuV/m)	(dBuV/m)	
<b>2459.25</b>	<b>H</b>	<b>60.32</b>	<b>55.67</b>	<b>31.83</b>	<b>92.15</b>	<b>87.50</b>			<b>X/F</b>
2483.50	H	21.77	11.03	31.80	53.57	42.83	74.00	54.00	X/E
4924.32	H	45.25	35.76	5.65	50.90	41.41	74.00	54.00	X/H

Remark :

- (1) All readings are Peak unless otherwise stated QP in column of 『Note』 . Peak denotes that the Peak reading compliance with the QP Limits and then QP Mode measurement didn't perform .
- (2) Measuring frequency range from 30MHz to 1000MHz or the 10th harmonic of highest fundamental frequency . "F" denotes fundamental frequency; "H" denotes spurious frequency. "E" denotes band edge frequency. (This judgment method includes the Band Edge Requirement.)
- (3) Radiated emissions measured in frequency range above 1000MHz were made with an instrument using Peak detector mode and AV detector mode of the emission .
- (4) Data of measurement within this frequency range shown " \* " in the table above means the reading of emissions are attenuated more than 20dB below the permissible limits or the field strength is too small to be measured.
- (5) A preamp and high pass filter were used for this test in order to provide sufficient measurement sensitivity.
- (6) EUT Orthogonal Axis :  
 "X" - denotes Laid on Table ; "Y" - denotes Vertical Stand ; "Z" - denotes Side Stand
- (7) During the measurements above 1 GHz it is taken care of that the EUT is always within the 3 dB cone of radiation BW of the used antenna



TX CH11 (Above 1000 MHz, Horizontal)

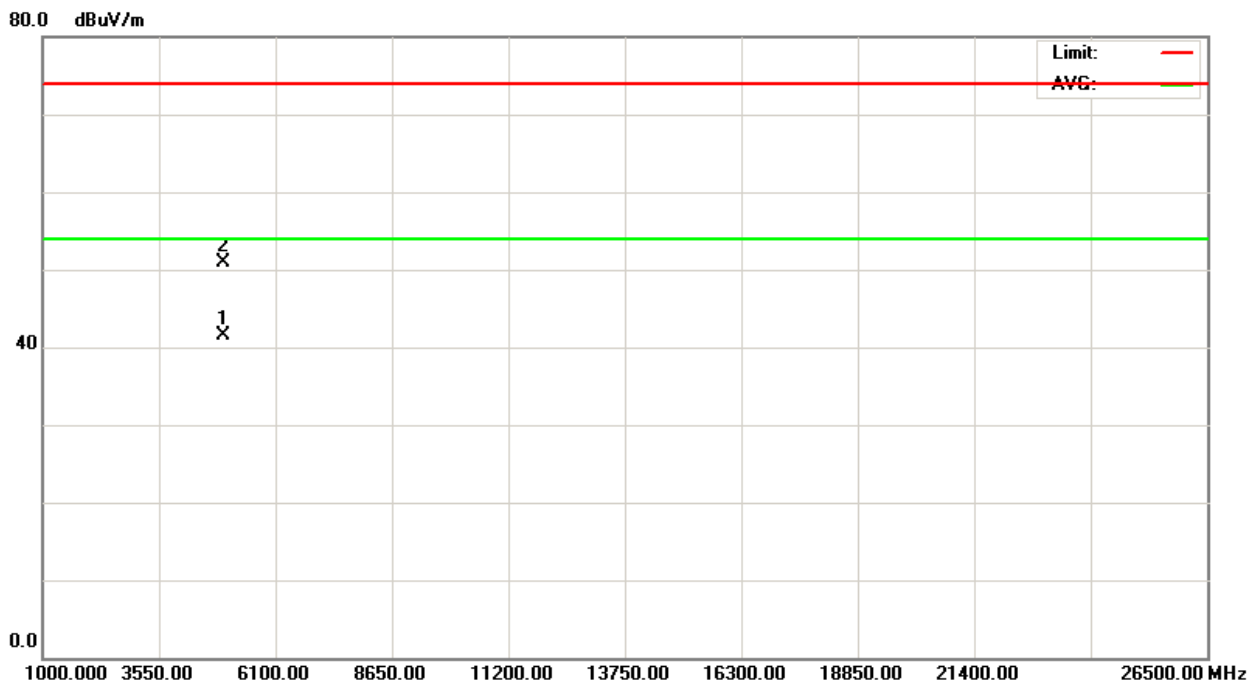
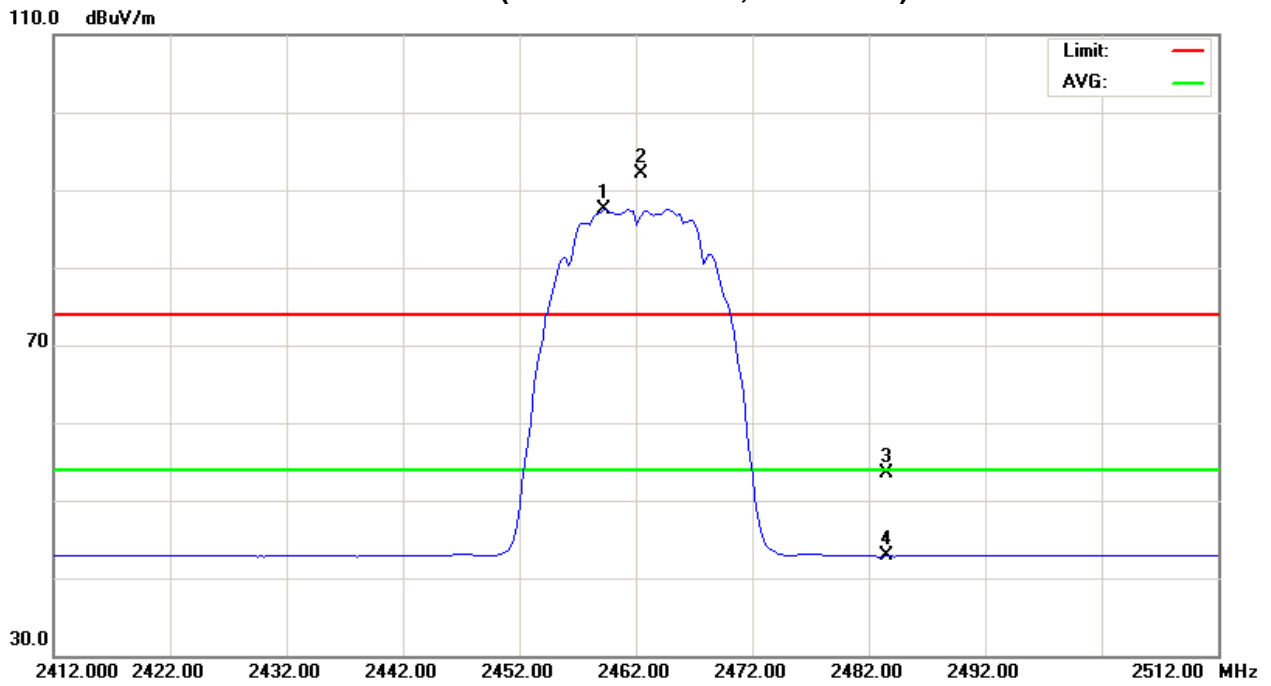



EUT :	150Mbps Wireless N USB Adapter	Model Name :	FWN-651N
Temperature :	25 °C	Relative Humidity :	58 %
Pressure :	1010 hPa	Test Voltage :	AC 120V/60Hz
Test Mode :	TX G MODE 2412MHz		

Freq. (MHz)	Ant.Pol. H/V	Reading		Ant./CF CF(dB)	Act.		Limit		Note
		Peak (dBuV)	AV (dBuV)		Peak (dBuV/m)	AV (dBuV/m)	Peak (dBuV/m)	AV (dBuV/m)	
2390.00	V	24.11	11.97	31.91	56.02	43.88	74.00	54.00	X/E
<b>2413.25</b>	<b>V</b>	<b>61.14</b>	<b>55.31</b>	<b>31.88</b>	<b>93.02</b>	<b>87.19</b>			<b>X/F</b>
4824.62	V	44.59	34.52	5.29	49.88	39.81	74.00	54.00	X/H

Remark :

- (1) All readings are Peak unless otherwise stated QP in column of 『Note』 . Peak denotes that the Peak reading compliance with the QP Limits and then QP Mode measurement didn't perform .
- (2) Measuring frequency range from 30MHz to 1000MHz or the 10th harmonic of highest fundamental frequency . "F" denotes fundamental frequency; "H" denotes spurious frequency. "E" denotes band edge frequency. (This judgment method includes the Band Edge Requirement.)
- (3) Radiated emissions measured in frequency range above 1000MHz were made with an instrument using Peak detector mode and AV detector mode of the emission .
- (4) Data of measurement within this frequency range shown " \* " in the table above means the reading of emissions are attenuated more than 20dB below the permissible limits or the field strength is too small to be measured.
- (5) A preamp and high pass filter were used for this test in order to provide sufficient measurement sensitivity.
- (6) EUT Orthogonal Axis :  
 "X" - denotes Laid on Table ; "Y" - denotes Vertical Stand ; "Z" - denotes Side Stand
- (7) During the measurements above 1 GHz it is taken care of that the EUT is always within the 3 dB cone of radiation BW of the used antenna





TX CH01 (Above 1000 MHz, Vertical)

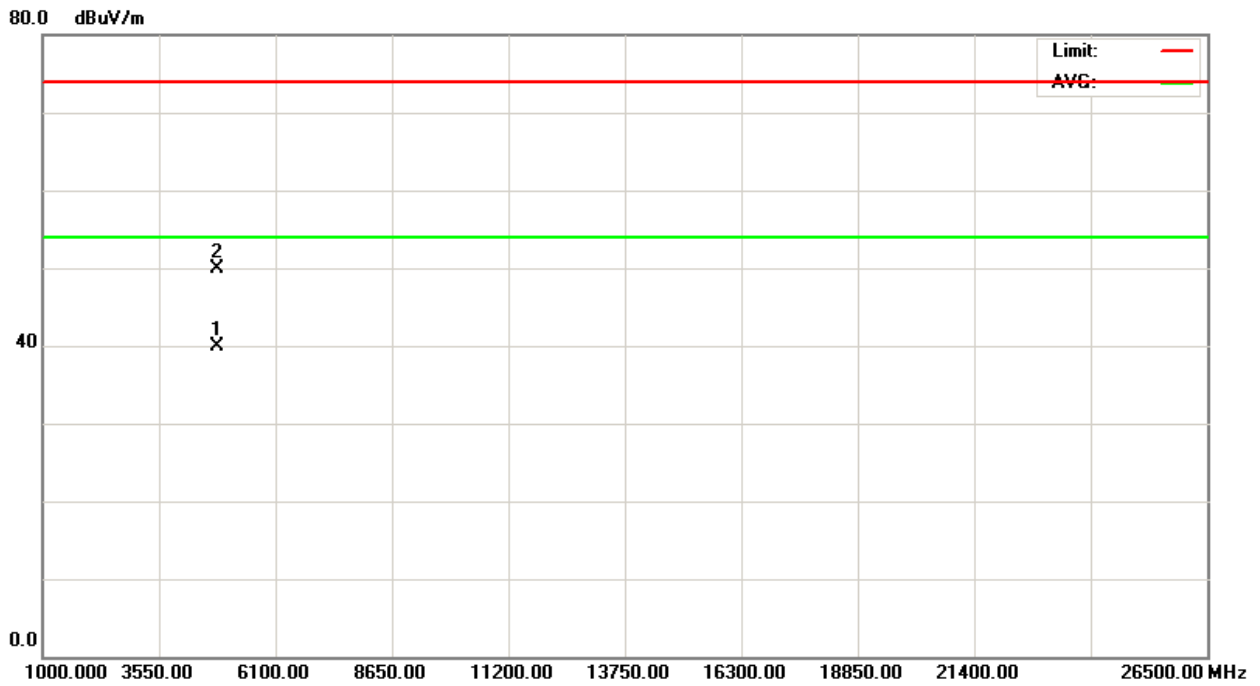
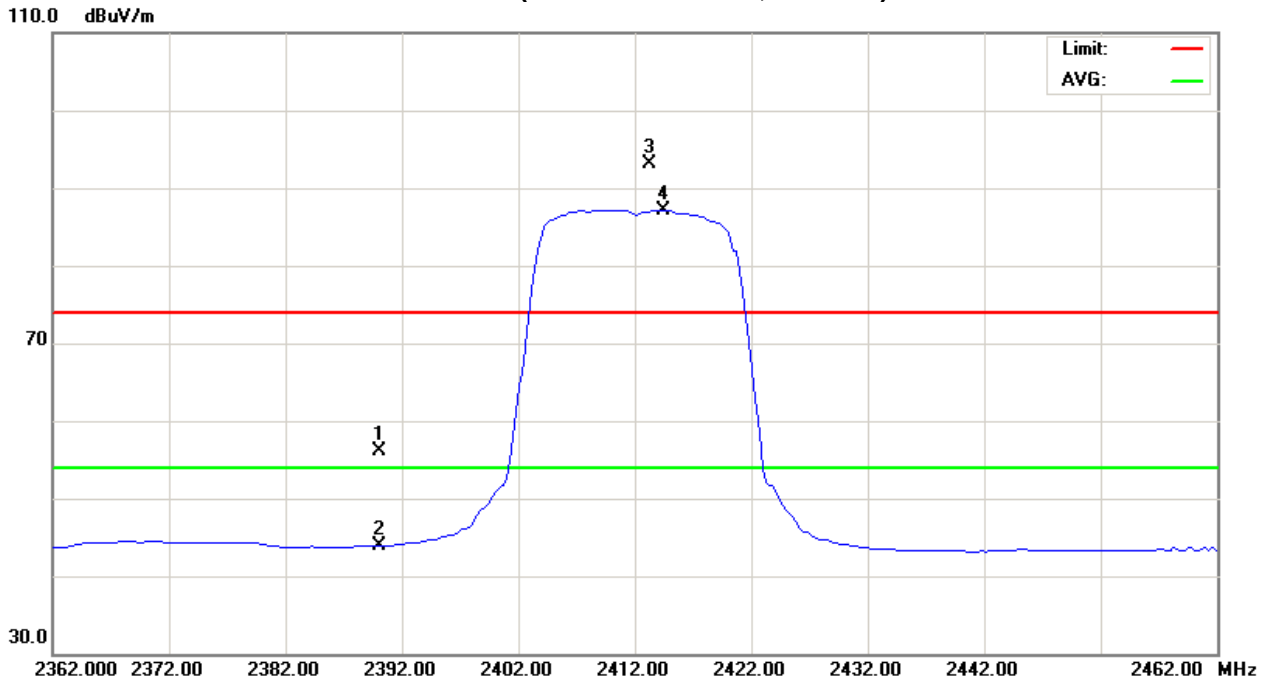



EUT :	150Mbps Wireless N USB Adapter	Model Name :	FWN-651N
Temperature :	25 °C	Relative Humidity :	58 %
Pressure :	1010 hPa	Test Voltage :	AC 120V/60Hz
Test Mode :	TX G MODE 2412MHz		

Freq. (MHz)	Ant.Pol. H/V	Reading		Ant./CF CF(dB)	Act.		Limit		Note
		Peak (dBuV)	AV (dBuV)		Peak (dBuV/m)	AV (dBuV/m)	Peak (dBuV/m)	AV (dBuV/m)	
2390.00	H	21.94	11.17	31.91	53.85	43.08	74.00	54.00	X/E
<b>2414.75</b>	<b>H</b>	<b>62.53</b>	<b>56.89</b>	<b>31.88</b>	<b>94.41</b>	<b>88.77</b>			<b>X/F</b>
4824.21	H	46.31	34.30	5.29	51.60	39.59	74.00	54.00	X/H

Remark :

- (1) All readings are Peak unless otherwise stated QP in column of 『Note』 . Peak denotes that the Peak reading compliance with the QP Limits and then QP Mode measurement didn't perform .
- (2) Measuring frequency range from 30MHz to 1000MHz or the 10th harmonic of highest fundamental frequency . "F" denotes fundamental frequency; "H" denotes spurious frequency. "E" denotes band edge frequency. (This judgment method includes the Band Edge Requirement.)
- (3) Radiated emissions measured in frequency range above 1000MHz were made with an instrument using Peak detector mode and AV detector mode of the emission .
- (4) Data of measurement within this frequency range shown " \* " in the table above means the reading of emissions are attenuated more than 20dB below the permissible limits or the field strength is too small to be measured.
- (5) A preamp and high pass filter were used for this test in order to provide sufficient measurement sensitivity.
- (6) EUT Orthogonal Axis :  
 "X" - denotes Laid on Table ; "Y" - denotes Vertical Stand ; "Z" - denotes Side Stand
- (7) During the measurements above 1 GHz it is taken care of that the EUT is always within the 3 dB cone of radiation BW of the used antenna



TX CH01 (Above 1000 MHz, Horizontal)

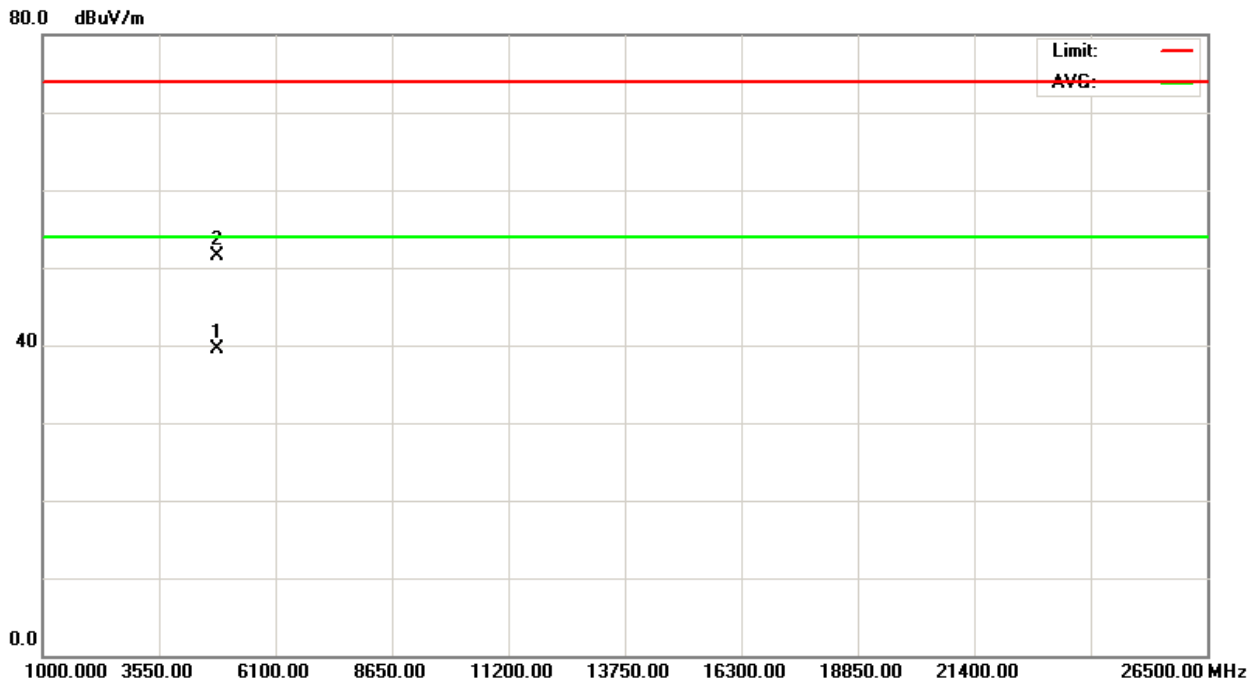
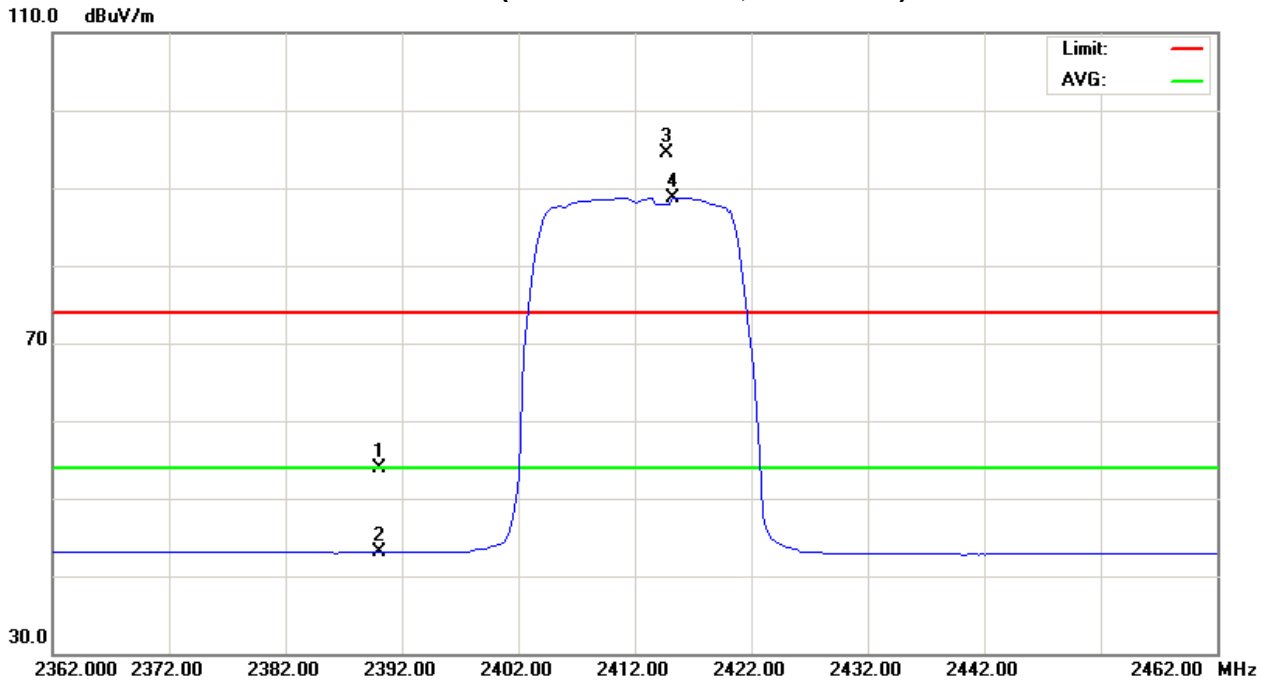



EUT :	150Mbps Wireless N USB Adapter	Model Name :	FWN-651N
Temperature :	25 °C	Relative Humidity :	58 %
Pressure :	1010 hPa	Test Voltage :	AC 120V/60Hz
Test Mode :	TX G MODE 2437MHz		

Freq. (MHz)	Ant.Pol. H/V	Reading		Ant./CF CF(dB)	Act.		Limit		Note
		Peak (dBuV)	AV (dBuV)		Peak (dBuV/m)	AV (dBuV/m)	Peak (dBuV/m)	AV (dBuV/m)	
<b>2433.25</b>	<b>V</b>	<b>61.62</b>	<b>54.01</b>	<b>31.86</b>	<b>93.48</b>	<b>85.87</b>			<b>X/F</b>
4874.12	V	44.21	33.25	5.47	49.68	38.72	74.00	54.00	X/H

Remark :

- (1) All readings are Peak unless otherwise stated QP in column of 『 Note 』 . Peak denotes that the Peak reading compliance with the QP Limits and then QP Mode measurement didn't perform ◦
- (2) Measuring frequency range from 30MHz to 1000MHz or the 10th harmonic of highest fundamental frequency ◦ "F" denotes fundamental frequency; "H" denotes spurious frequency. "E" denotes band edge frequency. (This judgment method includes the Band Edge Requirement.)
- (3) Radiated emissions measured in frequency range above 1000MHz were made with an instrument using Peak detector mode and AV detector mode of the emission ◦
- (4) Data of measurement within this frequency range shown " \* " in the table above means the reading of emissions are attenuated more than 20dB below the permissible limits or the field strength is too small to be measured.
- (5) A preamp and high pass filter were used for this test in order to provide sufficient measurement sensitivity.
- (6) EUT Orthogonal Axis :  
"X" - denotes Laid on Table ; "Y" - denotes Vertical Stand ; "Z" - denotes Side Stand
- (7) During the measurements above 1 GHz it is taken care of that the EUT is always within the 3 dB cone of radiation BW of the used antenna



TX CH06 (Above 1000 MHz, Vertical)

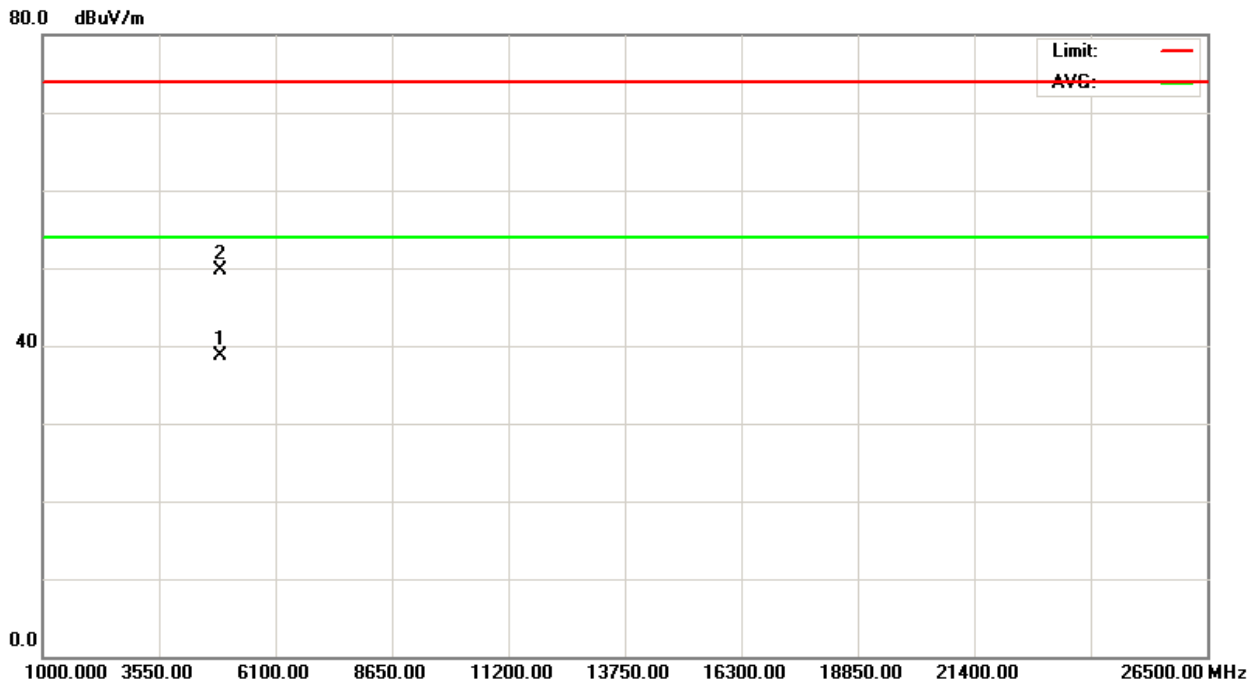
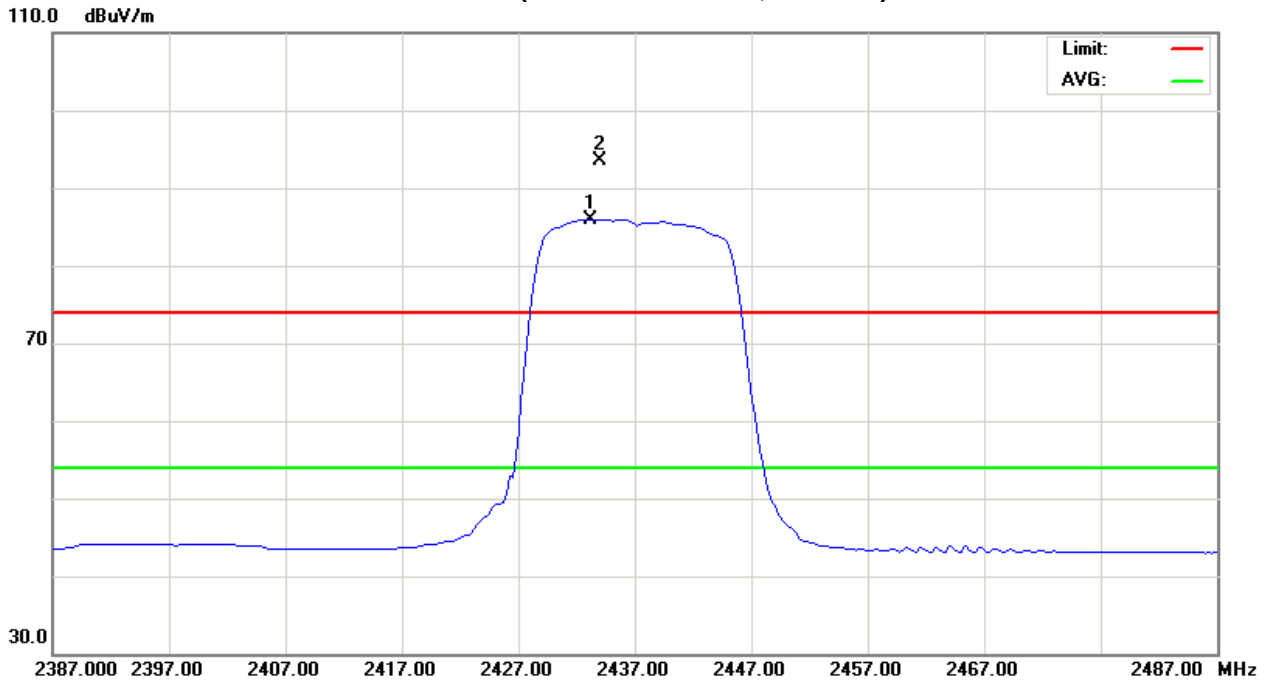



EUT :	150Mbps Wireless N USB Adapter	Model Name :	FWN-651N
Temperature :	25 °C	Relative Humidity :	58 %
Pressure :	1010 hPa	Test Voltage :	AC 120V/60Hz
Test Mode :	TX G MODE 2437MHz		

Freq.	Ant.Pol.	Reading		Ant./CF	Act.		Limit		Note
		Peak	AV		Peak	AV	Peak	AV	
(MHz)	H/V	(dBuV)	(dBuV)	CF(dB)	(dBuV/m)	(dBuV/m)	(dBuV/m)	(dBuV/m)	
<b>2432.50</b>	<b>H</b>	<b>63.79</b>	<b>58.44</b>	<b>31.87</b>	<b>95.66</b>	<b>90.31</b>			<b>X/F</b>
4874.02	H	46.74	34.55	5.47	52.21	40.02	74.00	54.00	X/H

Remark :

- (1) All readings are Peak unless otherwise stated QP in column of 『Note』 . Peak denotes that the Peak reading compliance with the QP Limits and then QP Mode measurement didn't perform .
- (2) Measuring frequency range from 30MHz to 1000MHz or the 10th harmonic of highest fundamental frequency .“F” denotes fundamental frequency; “H” denotes spurious frequency. “E” denotes band edge frequency. (This judgment method includes the Band Edge Requirement.)
- (3) Radiated emissions measured in frequency range above 1000MHz were made with an instrument using Peak detector mode and AV detector mode of the emission .
- (4) Data of measurement within this frequency range shown “ \* ” in the table above means the reading of emissions are attenuated more than 20dB below the permissible limits or the field strength is too small to be measured.
- (5) A preamp and high pass filter were used for this test in order to provide sufficient measurement sensitivity.
- (6) EUT Orthogonal Axis :  
 “X” - denotes Laid on Table ; “Y” - denotes Vertical Stand ; “Z” - denotes Side Stand
- (7) During the measurements above 1 GHz it is taken care of that the EUT is always within the 3 dB cone of radiation BW of the used antenna



TX CH06 (Above 1000 MHz, Horizontal)

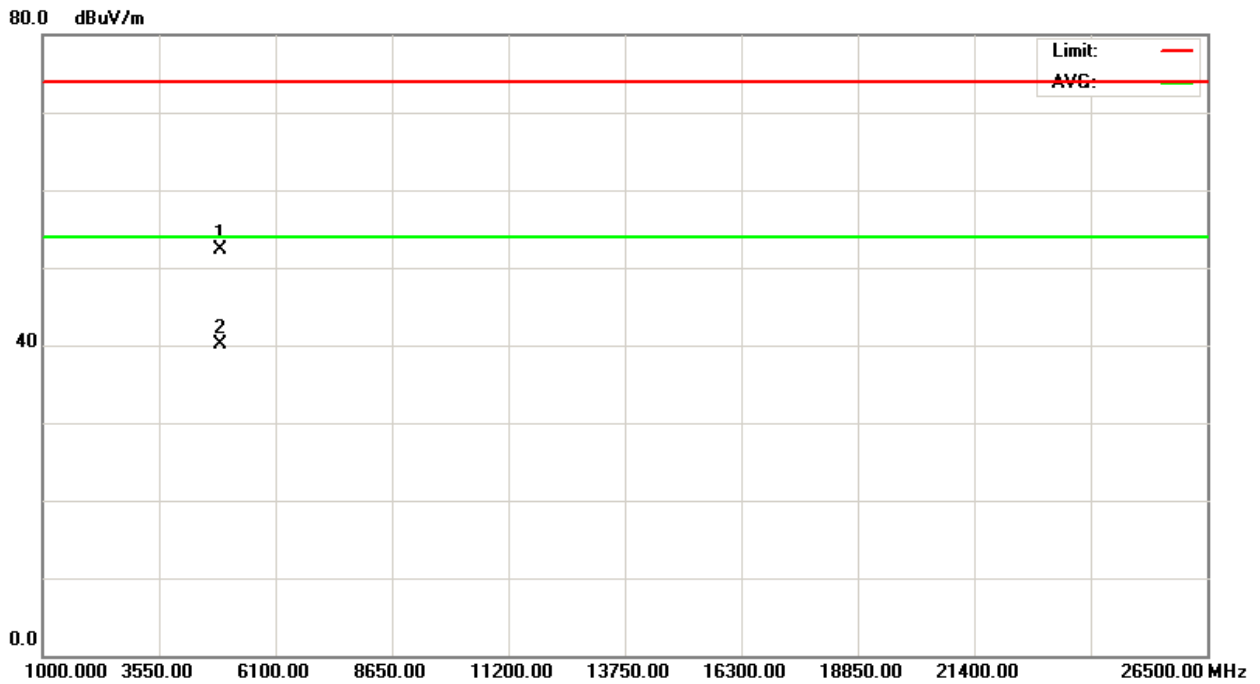
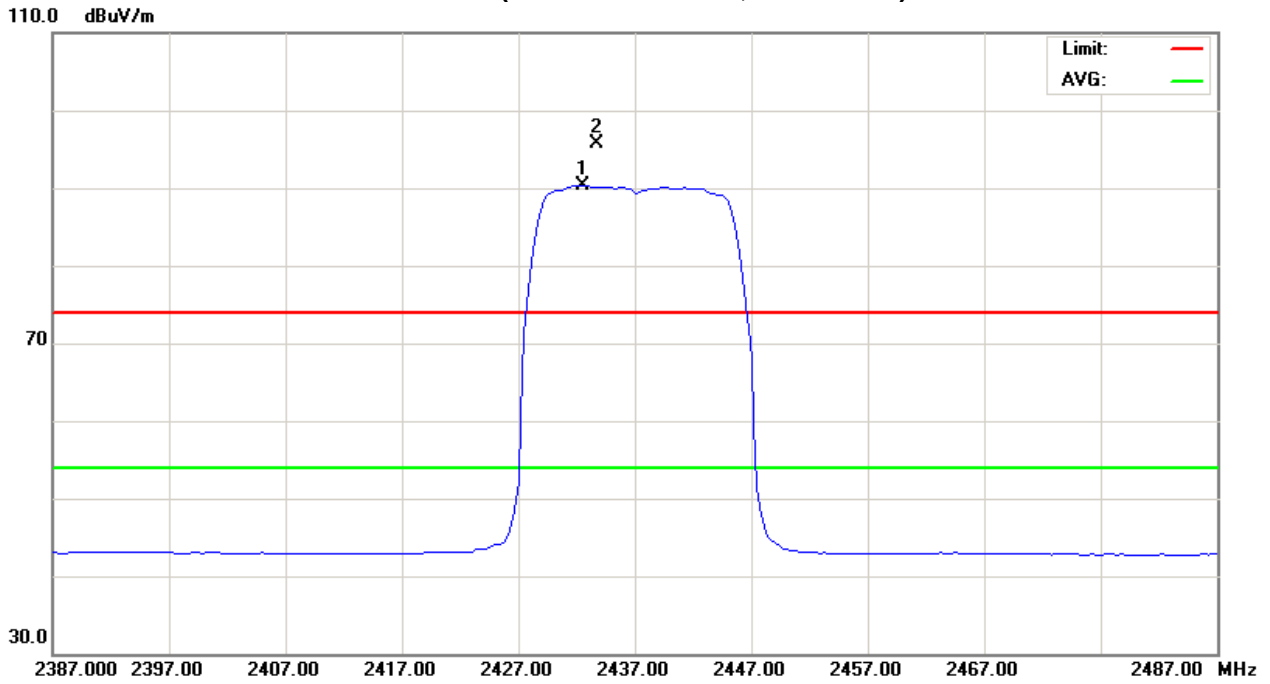



EUT :	150Mbps Wireless N USB Adapter	Model Name :	FWN-651N
Temperature :	25 °C	Relative Humidity :	58 %
Pressure :	1010 hPa	Test Voltage :	AC 120V/60Hz
Test Mode :	TX G MODE 2462MHz		

Freq.	Ant.Pol.	Reading		Ant./CF	Act.		Limit		Note
		Peak	AV		Peak	AV	Peak	AV	
(MHz)	H/V	(dBuV)	(dBuV)	CF(dB)	(dBuV/m)	(dBuV/m)	(dBuV/m)	(dBuV/m)	
<b>2459.00</b>	<b>V</b>	<b>63.02</b>	<b>55.59</b>	<b>31.83</b>	<b>94.85</b>	<b>87.42</b>			<b>X/F</b>
2483.50	V	22.37	11.62	31.80	54.17	43.42	74.00	54.00	X/E
4924.12	V	43.21	32.75	5.65	48.86	38.40	74.00	54.00	X/H

Remark :

- (1) All readings are Peak unless otherwise stated QP in column of 『Note』 . Peak denotes that the Peak reading compliance with the QP Limits and then QP Mode measurement didn't perform .
- (2) Measuring frequency range from 30MHz to 1000MHz or the 10th harmonic of highest fundamental frequency . "F" denotes fundamental frequency; "H" denotes spurious frequency. "E" denotes band edge frequency. (This judgment method includes the Band Edge Requirement.)
- (3) Radiated emissions measured in frequency range above 1000MHz were made with an instrument using Peak detector mode and AV detector mode of the emission .
- (4) Data of measurement within this frequency range shown " \* " in the table above means the reading of emissions are attenuated more than 20dB below the permissible limits or the field strength is too small to be measured.
- (5) A preamp and high pass filter were used for this test in order to provide sufficient measurement sensitivity.
- (6) EUT Orthogonal Axis :  
 "X" - denotes Laid on Table ; "Y" - denotes Vertical Stand ; "Z" - denotes Side Stand
- (7) During the measurements above 1 GHz it is taken care of that the EUT is always within the 3 dB cone of radiation BW of the used antenna





TX CH11 (Above 1000 MHz, Vertical)

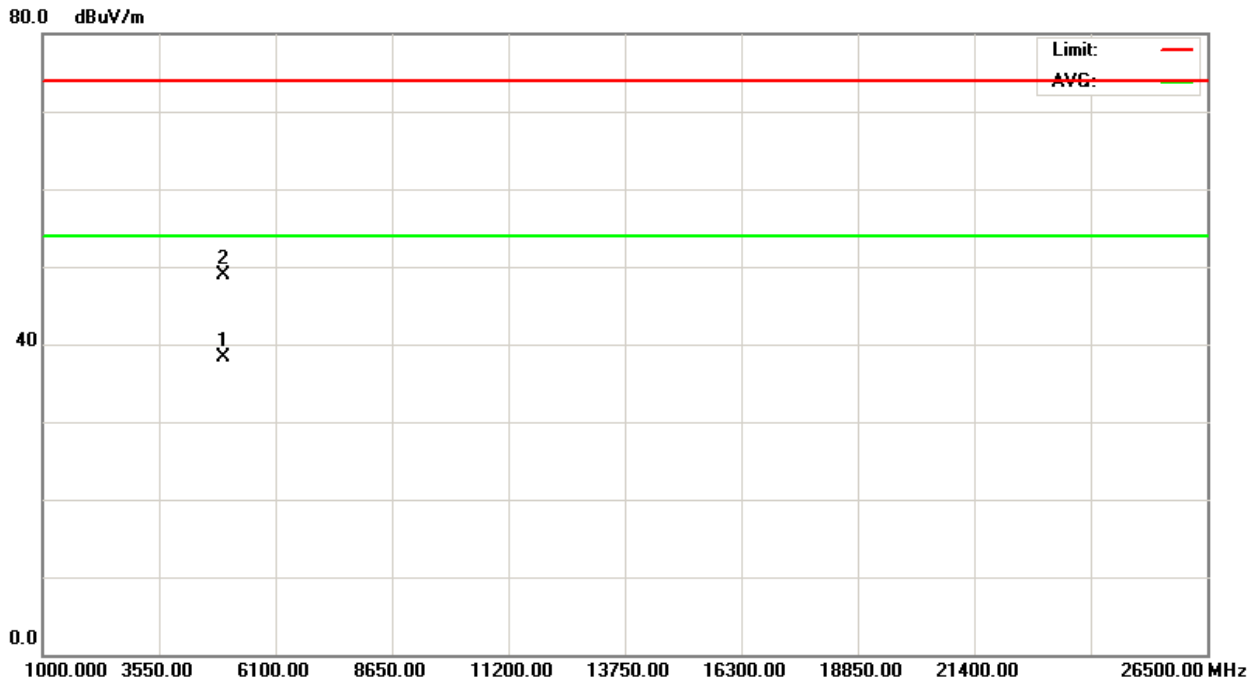
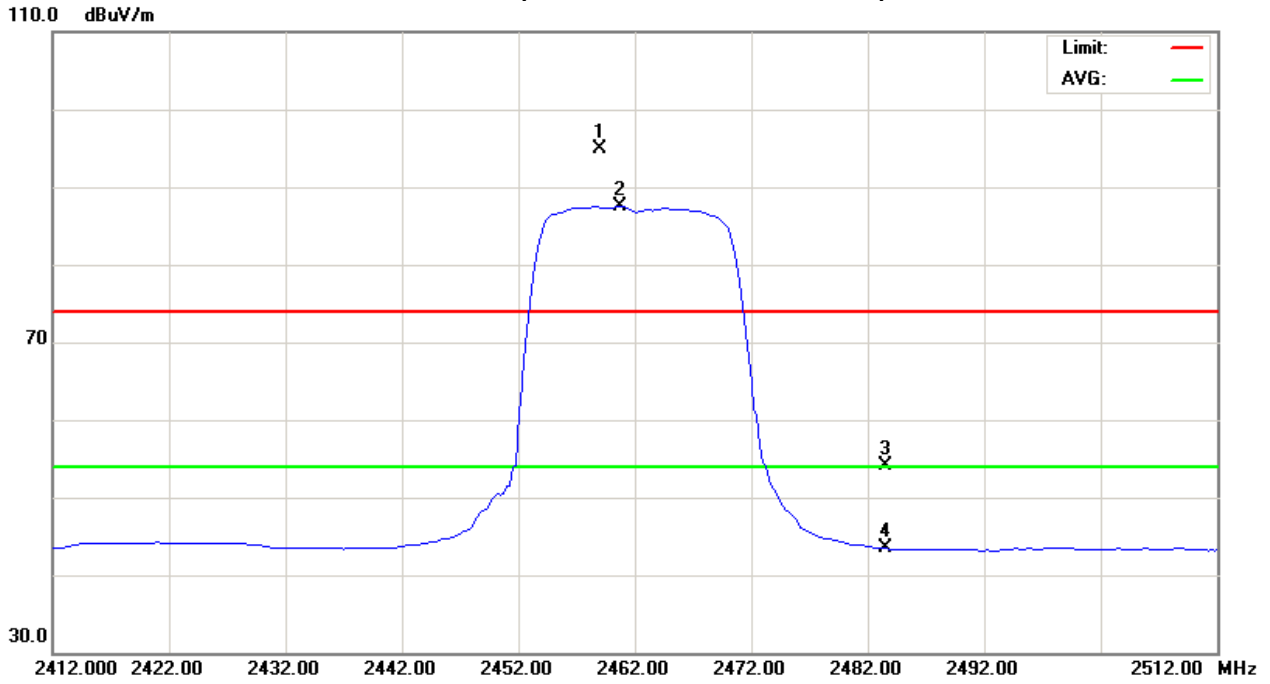



EUT :	150Mbps Wireless N USB Adapter	Model Name :	FWN-651N
Temperature :	25 °C	Relative Humidity :	58 %
Pressure :	1010 hPa	Test Voltage :	AC 120V/60Hz
Test Mode :	TX G MODE 2462MHz		

Freq. (MHz)	Ant.Pol. H/V	Reading		Ant./CF CF(dB)	Act.		Limit		Note
		Peak (dBuV)	AV (dBuV)		Peak (dBuV/m)	AV (dBuV/m)	Peak (dBuV/m)	AV (dBuV/m)	
<b>2457.25</b>	<b>H</b>	<b>61.04</b>	<b>56.70</b>	<b>31.84</b>	<b>92.88</b>	<b>88.54</b>			<b>X/F</b>
2483.50	H	22.26	10.99	31.80	54.06	42.79	74.00	54.00	X/E
4923.85	H	45.87	35.32	5.65	51.52	40.97	74.00	54.00	X/H

Remark :

- (1) All readings are Peak unless otherwise stated QP in column of 『Note』 . Peak denotes that the Peak reading compliance with the QP Limits and then QP Mode measurement didn't perform .
- (2) Measuring frequency range from 30MHz to 1000MHz or the 10th harmonic of highest fundamental frequency . "F" denotes fundamental frequency; "H" denotes spurious frequency. "E" denotes band edge frequency. (This judgment method includes the Band Edge Requirement.)
- (3) Radiated emissions measured in frequency range above 1000MHz were made with an instrument using Peak detector mode and AV detector mode of the emission .
- (4) Data of measurement within this frequency range shown " \* " in the table above means the reading of emissions are attenuated more than 20dB below the permissible limits or the field strength is too small to be measured.
- (5) A preamp and high pass filter were used for this test in order to provide sufficient measurement sensitivity.
- (6) EUT Orthogonal Axis :  
"X" - denotes Laid on Table ; "Y" - denotes Vertical Stand ; "Z" - denotes Side Stand
- (7) During the measurements above 1 GHz it is taken care of that the EUT is always within the 3 dB cone of radiation BW of the used antenna



TX CH11 (Above 1000 MHz, Horizontal)

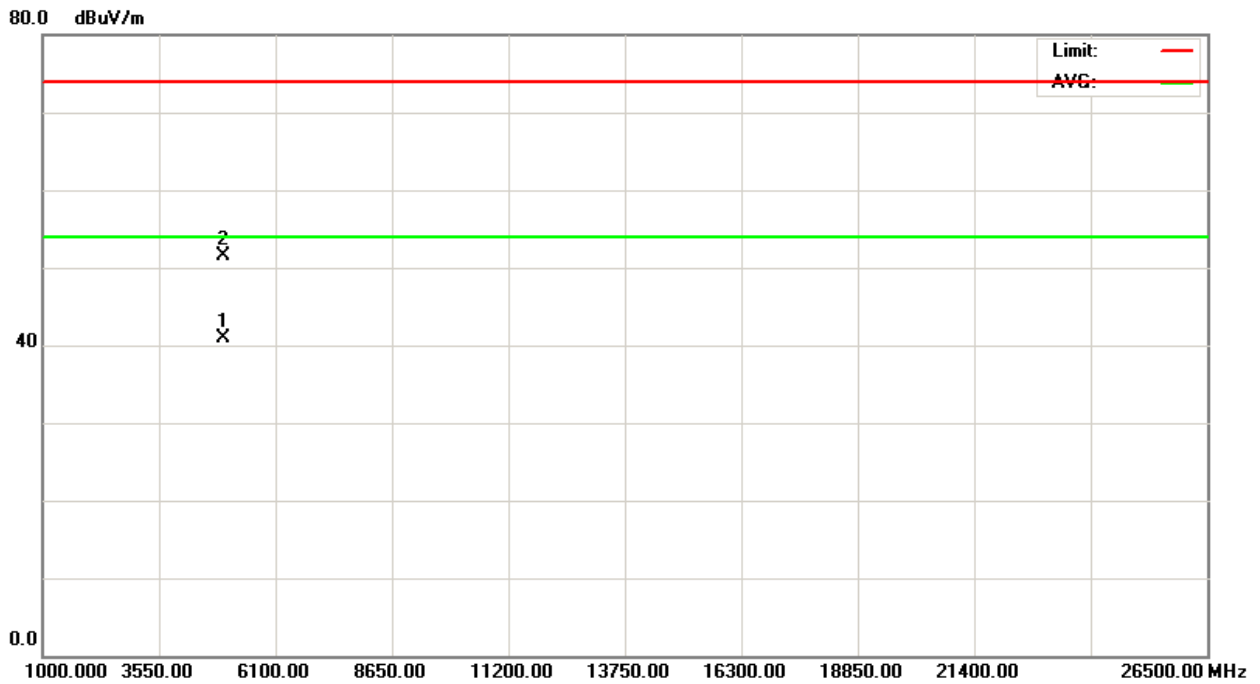
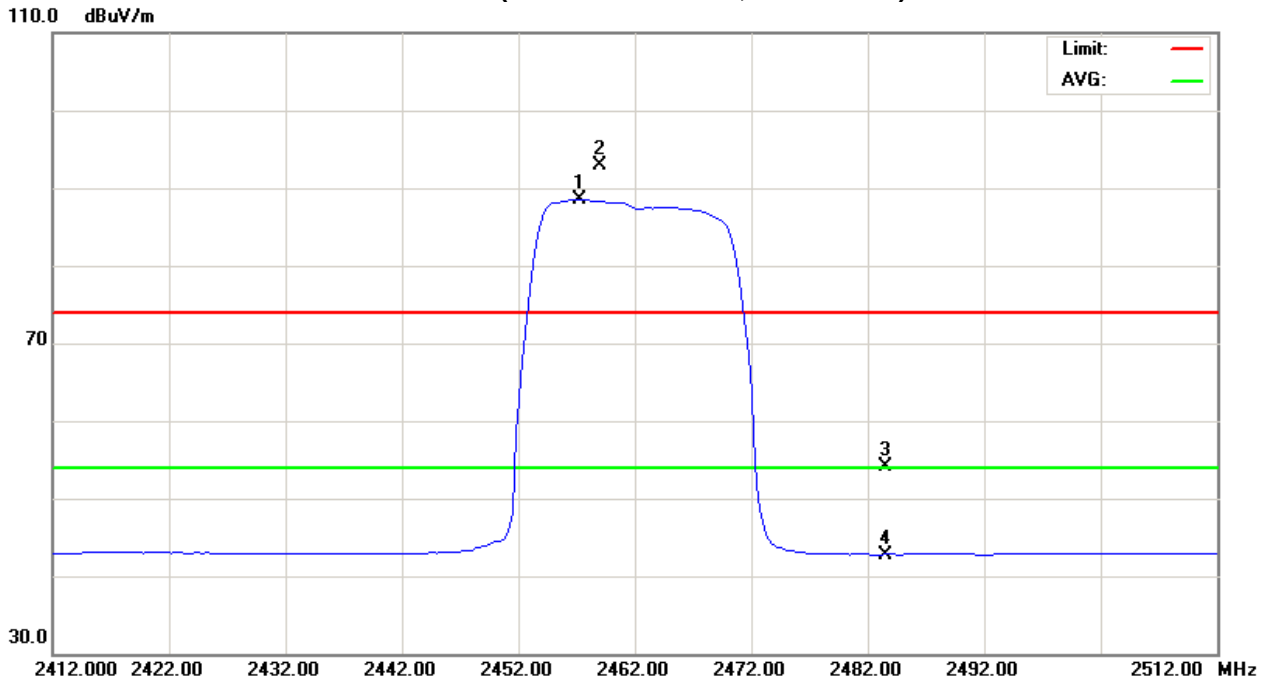



EUT :	150Mbps Wireless N USB Adapter	Model Name :	FWN-651N
Temperature :	25 °C	Relative Humidity :	58 %
Pressure :	1010 hPa	Test Voltage :	AC 120V/60Hz
Test Mode :	TX N-20M MODE 2412MHz		

Freq.	Ant.Pol.	Reading		Ant./CF	Act.		Limit		Note
		Peak	AV		Peak	AV	Peak	AV	
(MHz)	H/V	(dBuV)	(dBuV)	CF(dB)	(dBuV/m)	(dBuV/m)	(dBuV/m)	(dBuV/m)	
2390.00	V	23.83	12.00	31.91	55.74	43.91	74.00	54.00	X/E
<b>2408.41</b>	<b>V</b>	<b>59.54</b>	<b>55.37</b>	<b>31.89</b>	<b>91.43</b>	<b>87.26</b>			<b>X/F</b>
4823.97	V	46.92	34.40	5.29	52.21	39.69	74.00	54.00	X/H

Remark :

- (1) All readings are Peak unless otherwise stated QP in column of 『Note』 . Peak denotes that the Peak reading compliance with the QP Limits and then QP Mode measurement didn't perform .
- (2) Measuring frequency range from 30MHz to 1000MHz or the 10th harmonic of highest fundamental frequency . "F" denotes fundamental frequency; "H" denotes spurious frequency. "E" denotes band edge frequency. (This judgment method includes the Band Edge Requirement.)
- (3) Radiated emissions measured in frequency range above 1000MHz were made with an instrument using Peak detector mode and AV detector mode of the emission .
- (4) Data of measurement within this frequency range shown " \* " in the table above means the reading of emissions are attenuated more than 20dB below the permissible limits or the field strength is too small to be measured.
- (5) A preamp and high pass filter were used for this test in order to provide sufficient measurement sensitivity.
- (6) EUT Orthogonal Axis :  
"X" - denotes Laid on Table ; "Y" - denotes Vertical Stand ; "Z" - denotes Side Stand
- (7) During the measurements above 1 GHz it is taken care of that the EUT is always within the 3 dB cone of radiation BW of the used antenna



TX CH01 (Above 1000 MHz, Vertical)

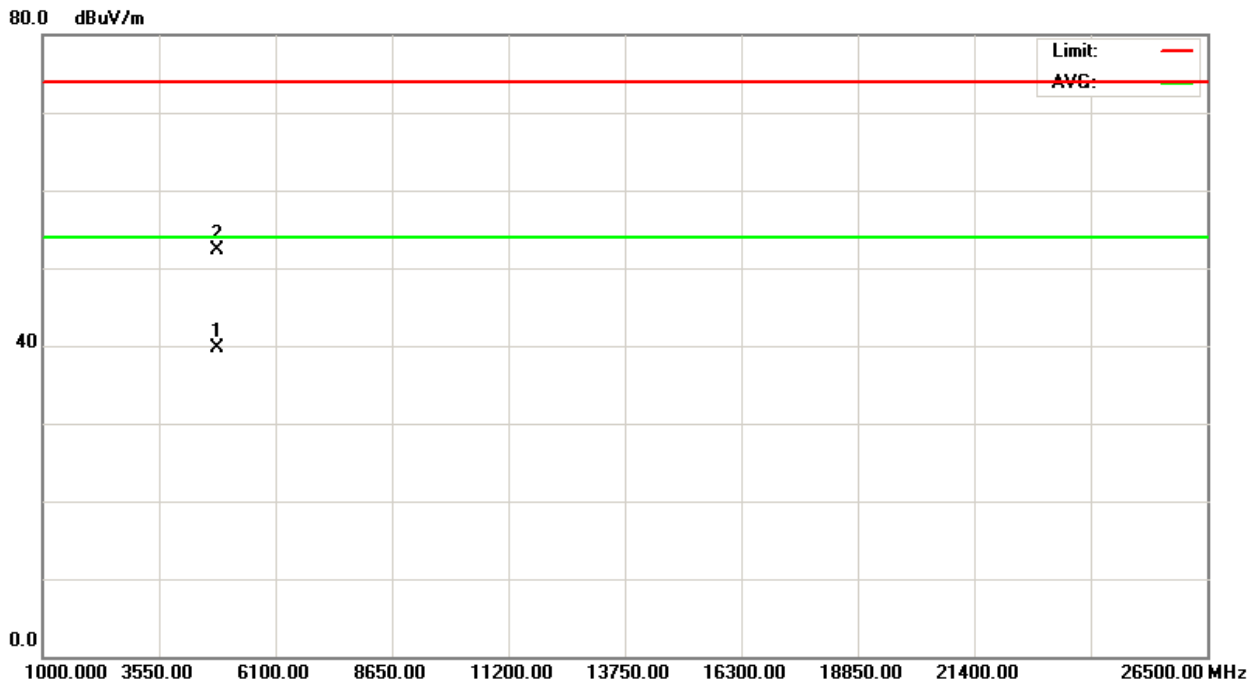
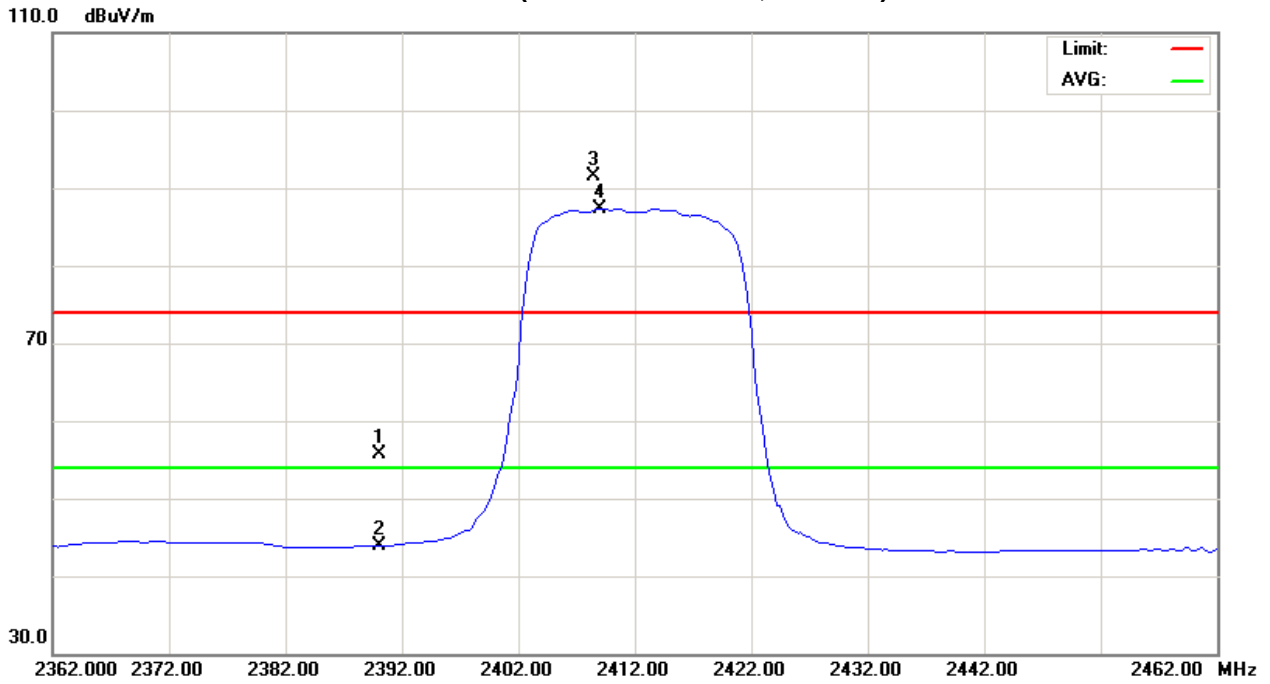



EUT :	150Mbps Wireless N USB Adapter	Model Name :	FWN-651N
Temperature :	25 °C	Relative Humidity :	58 %
Pressure :	1010 hPa	Test Voltage :	AC 120V/60Hz
Test Mode :	TX N-20M MODE 2412MHz		

Freq.	Ant.Pol.	Reading		Ant./CF	Act.		Limit		Note
		Peak	AV		Peak	AV	Peak	AV	
(MHz)	H/V	(dBuV)	(dBuV)	CF(dB)	(dBuV/m)	(dBuV/m)	(dBuV/m)	(dBuV/m)	
2390.00	H	21.94	11.11	31.91	53.85	43.02	74.00	54.00	X/E
<b>2414.38</b>	<b>H</b>	<b>67.73</b>	<b>62.84</b>	<b>31.88</b>	<b>99.61</b>	<b>94.72</b>			<b>X/F</b>
4824.13	H	49.51	37.50	5.29	54.80	42.79	74.00	54.00	X/H

Remark :

- (1) All readings are Peak unless otherwise stated QP in column of 『Note』 . Peak denotes that the Peak reading compliance with the QP Limits and then QP Mode measurement didn't perform .
- (2) Measuring frequency range from 30MHz to 1000MHz or the 10th harmonic of highest fundamental frequency . "F" denotes fundamental frequency; "H" denotes spurious frequency. "E" denotes band edge frequency. (This judgment method includes the Band Edge Requirement.)
- (3) Radiated emissions measured in frequency range above 1000MHz were made with an instrument using Peak detector mode and AV detector mode of the emission .
- (4) Data of measurement within this frequency range shown " \* " in the table above means the reading of emissions are attenuated more than 20dB below the permissible limits or the field strength is too small to be measured.
- (5) A preamp and high pass filter were used for this test in order to provide sufficient measurement sensitivity.
- (6) EUT Orthogonal Axis :  
 "X" - denotes Laid on Table ; "Y" - denotes Vertical Stand ; "Z" - denotes Side Stand
- (7) During the measurements above 1 GHz it is taken care of that the EUT is always within the 3 dB cone of radiation BW of the used antenna



TX CH01 (Above 1000 MHz, Horizontal)

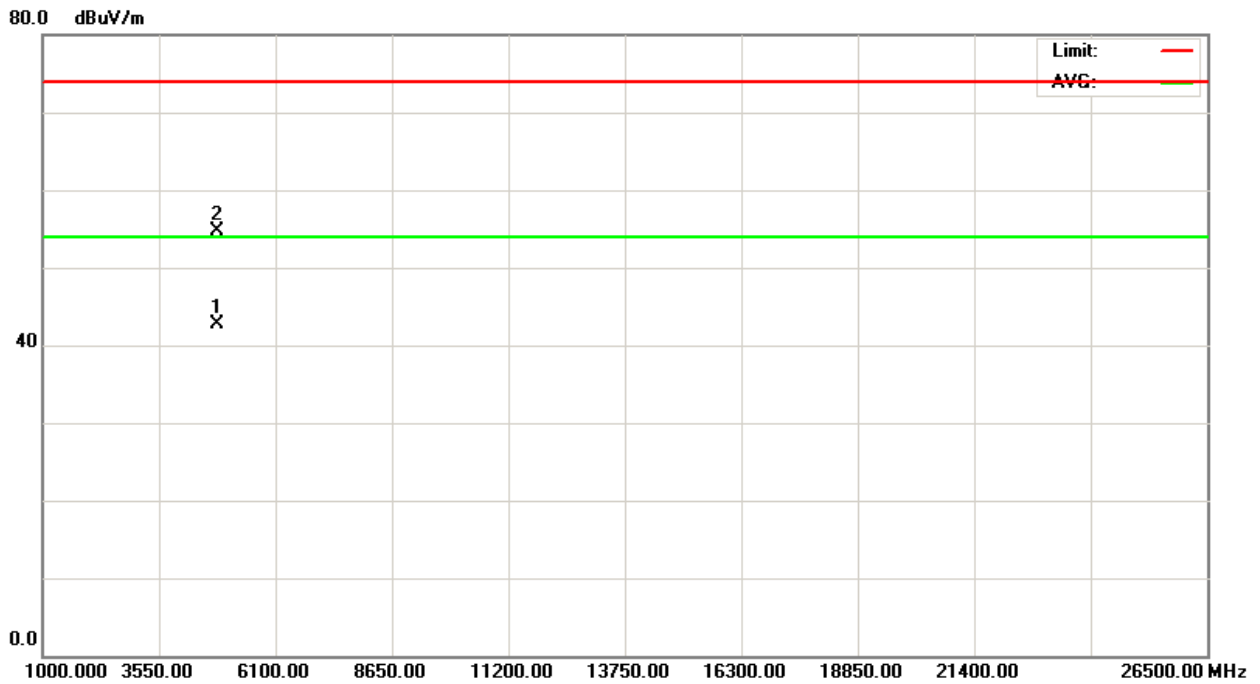
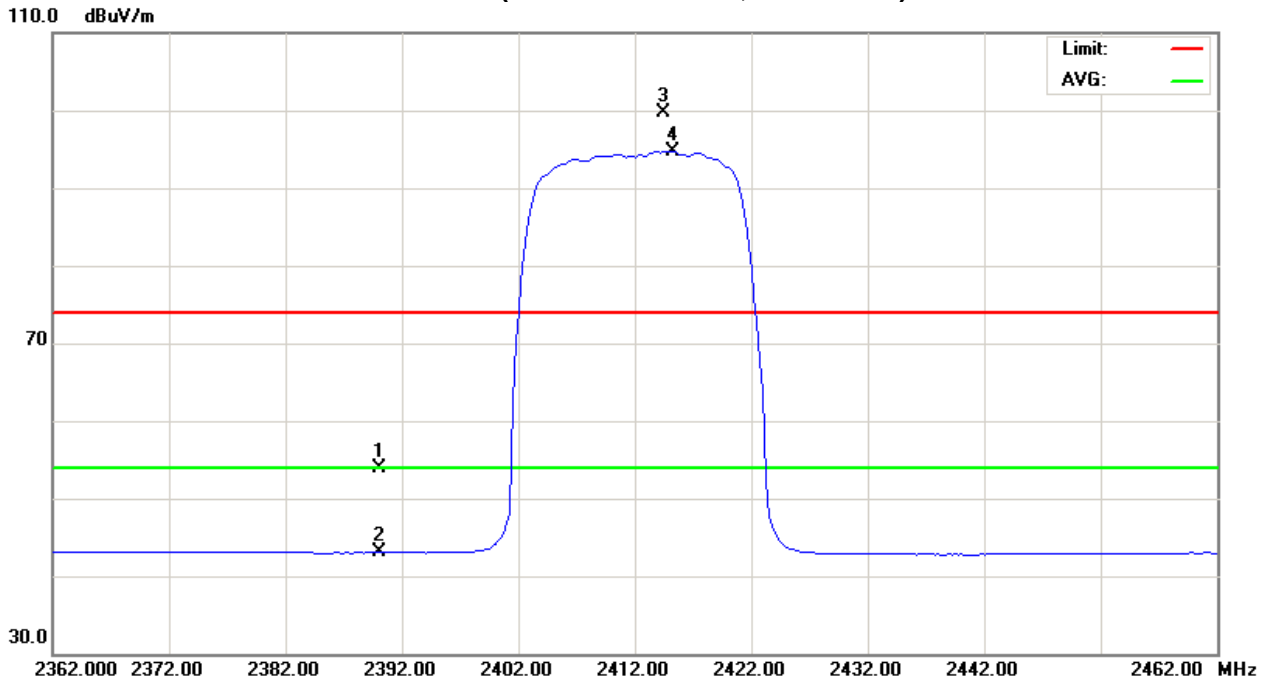



EUT :	150Mbps Wireless N USB Adapter	Model Name :	FWN-651N
Temperature :	25 °C	Relative Humidity :	58 %
Pressure :	1010 hPa	Test Voltage :	AC 120V/60Hz
Test Mode :	TX N-20M MODE 2437MHz		

Freq. (MHz)	Ant.Pol. H/V	Reading		Ant./CF CF(dB)	Act.		Limit		Note
		Peak (dBuV)	AV (dBuV)		Peak (dBuV/m)	AV (dBuV/m)	Peak (dBuV/m)	AV (dBuV/m)	
<b>2434.00</b>	<b>V</b>	<b>58.51</b>	<b>52.43</b>	<b>31.86</b>	<b>90.37</b>	<b>84.29</b>			<b>X/F</b>
4873.75	V	44.44	33.82	5.47	49.91	39.29	74.00	54.00	X/H

Remark :

- (1) All readings are Peak unless otherwise stated QP in column of 『Note』 . Peak denotes that the Peak reading compliance with the QP Limits and then QP Mode measurement didn't perform ◦
- (2) Measuring frequency range from 30MHz to 1000MHz or the 10th harmonic of highest fundamental frequency ◦ "F" denotes fundamental frequency; "H" denotes spurious frequency. "E" denotes band edge frequency. (This judgment method includes the Band Edge Requirement.)
- (3) Radiated emissions measured in frequency range above 1000MHz were made with an instrument using Peak detector mode and AV detector mode of the emission ◦
- (4) Data of measurement within this frequency range shown " \* " in the table above means the reading of emissions are attenuated more than 20dB below the permissible limits or the field strength is too small to be measured.
- (5) A preamp and high pass filter were used for this test in order to provide sufficient measurement sensitivity.
- (6) EUT Orthogonal Axis :  
"X" - denotes Laid on Table ; "Y" - denotes Vertical Stand ; "Z" - denotes Side Stand
- (7) During the measurements above 1 GHz it is taken care of that the EUT is always within the 3 dB cone of radiation BW of the used antenna





TX CH06 (Above 1000 MHz, Vertical)

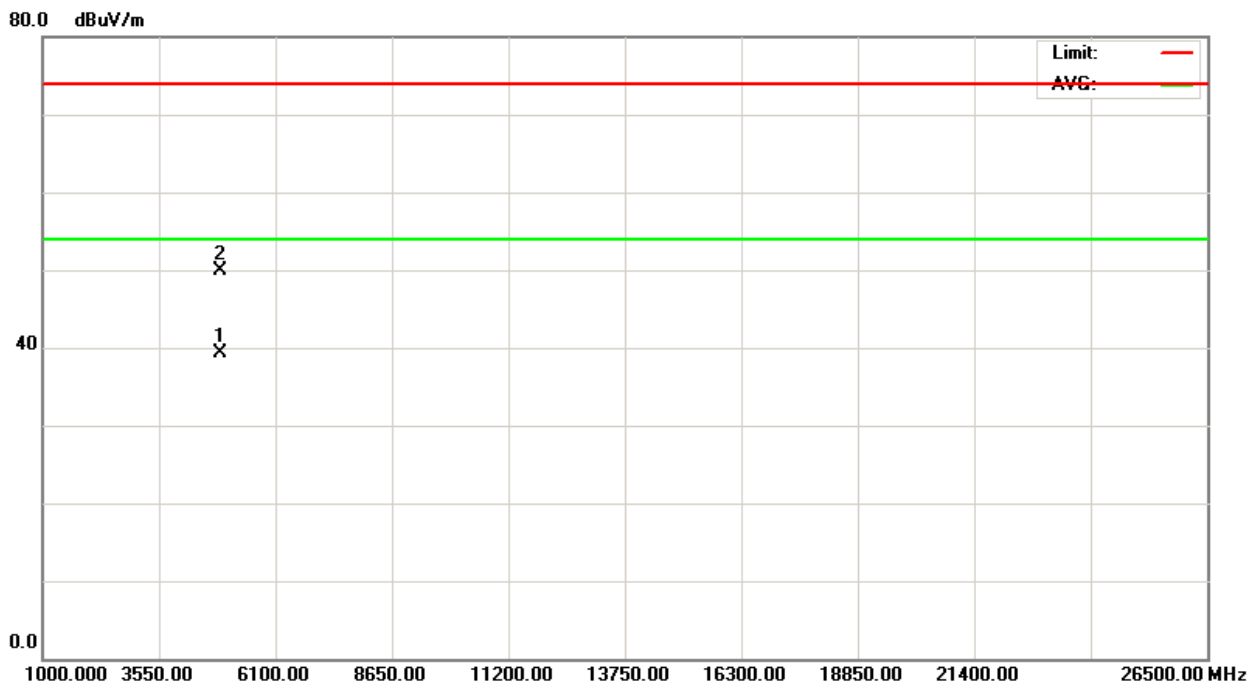
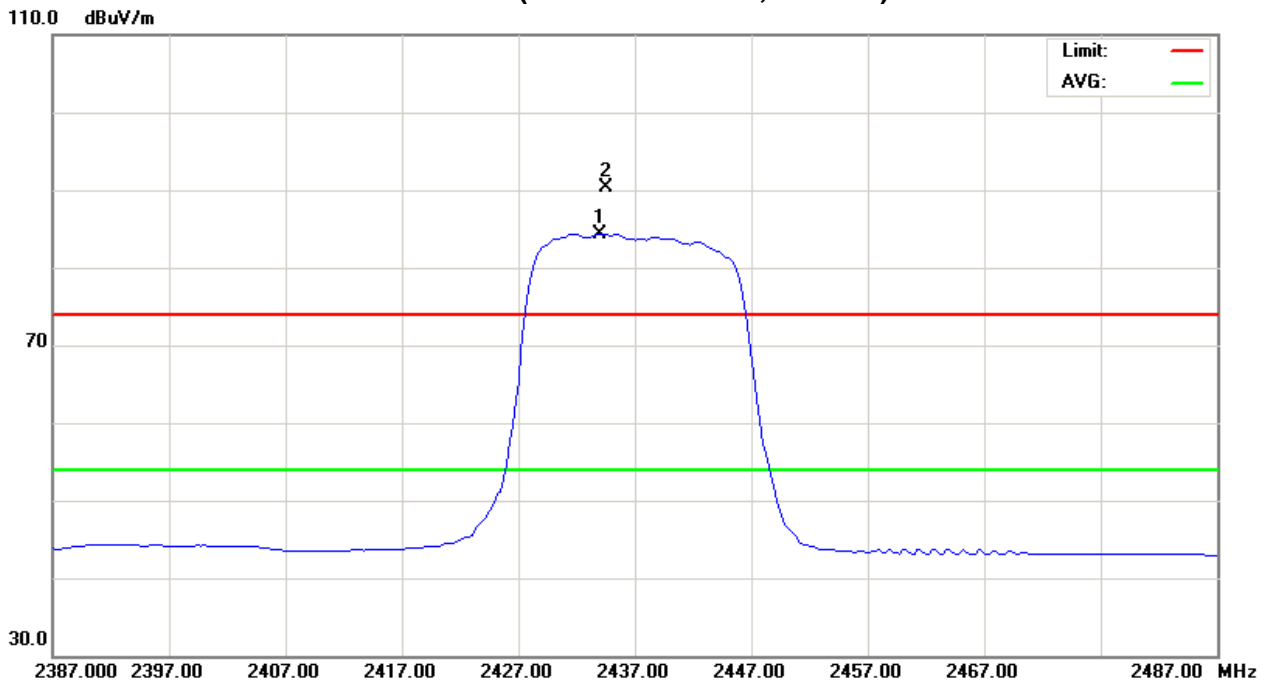



EUT :	150Mbps Wireless N USB Adapter	Model Name :	FWN-651N
Temperature :	25 °C	Relative Humidity :	58 %
Pressure :	1010 hPa	Test Voltage :	AC 120V/60Hz
Test Mode :	TX N-20M MODE 2437MHZ		

Freq.	Ant.Pol.	Reading		Ant./CF	Act.		Limit		Note
		Peak	AV		Peak	AV	Peak	AV	
(MHz)	H/V	(dBuV)	(dBuV)	CF(dB)	(dBuV/m)	(dBuV/m)	(dBuV/m)	(dBuV/m)	
<b>2431.75</b>	<b>H</b>	<b>66.75</b>	<b>60.72</b>	<b>31.87</b>	<b>98.62</b>	<b>92.59</b>			<b>X/F</b>
4873.87	H	48.34	35.76	5.47	53.81	41.23	74.00	54.00	X/H

Remark :

- (1) All readings are Peak unless otherwise stated QP in column of 『Note』 . Peak denotes that the Peak reading compliance with the QP Limits and then QP Mode measurement didn't perform .
- (2) Measuring frequency range from 30MHz to 1000MHz or the 10th harmonic of highest fundamental frequency .“F” denotes fundamental frequency; “H” denotes spurious frequency. “E” denotes band edge frequency. (This judgment method includes the Band Edge Requirement.)
- (3) Radiated emissions measured in frequency range above 1000MHz were made with an instrument using Peak detector mode and AV detector mode of the emission .
- (4) Data of measurement within this frequency range shown “ \* ” in the table above means the reading of emissions are attenuated more than 20dB below the permissible limits or the field strength is too small to be measured.
- (5) A preamp and high pass filter were used for this test in order to provide sufficient measurement sensitivity.
- (6) EUT Orthogonal Axis :  
“X” - denotes Laid on Table ; “Y” - denotes Vertical Stand ; “Z” - denotes Side Stand
- (7) During the measurements above 1 GHz it is taken care of that the EUT is always within the 3 dB cone of radiation BW of the used antenna



TX CH06 (Above 1000 MHz, Horizontal)

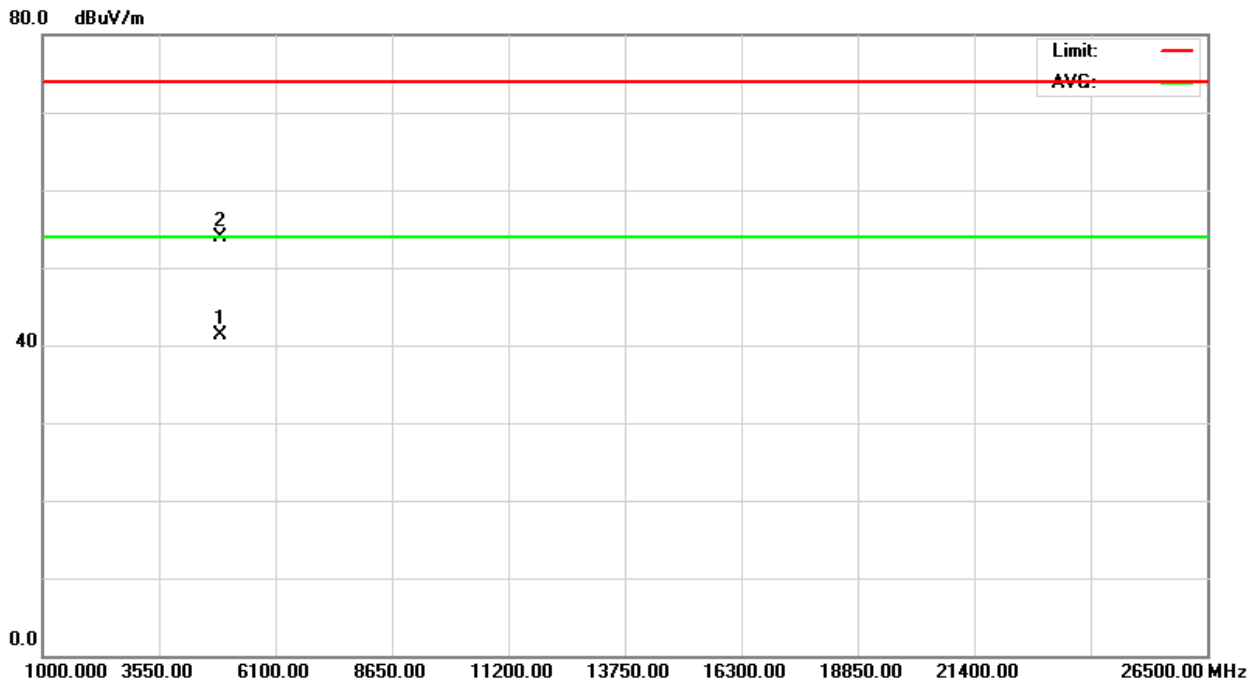
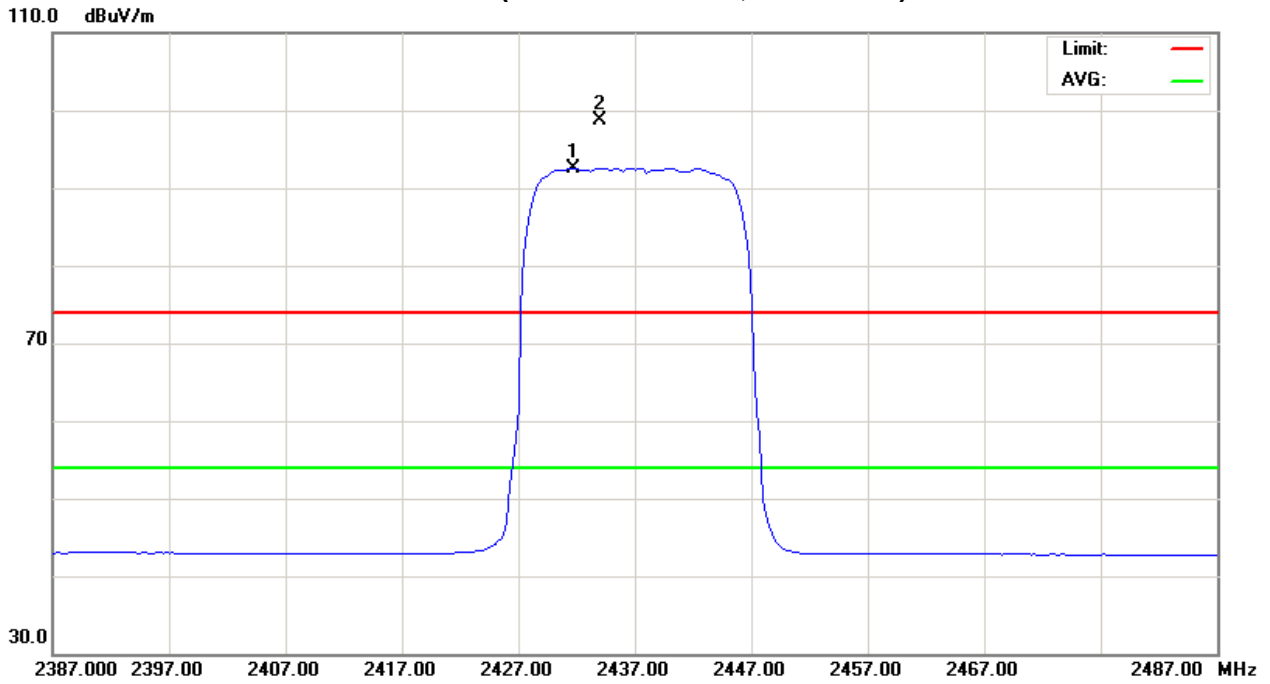



EUT :	150Mbps Wireless N USB Adapter	Model Name :	FWN-651N
Temperature :	25 °C	Relative Humidity :	58 %
Pressure :	1010 hPa	Test Voltage :	AC 120V/60Hz
Test Mode :	TX N-20M MODE 2462MHz		

Freq.	Ant.Pol.	Reading		Ant./CF	Act.		Limit		Note
		Peak	AV		Peak	AV	Peak	AV	
(MHz)	H/V	(dBuV)	(dBuV)	CF(dB)	(dBuV/m)	(dBuV/m)	(dBuV/m)	(dBuV/m)	
<b>2458.56</b>	<b>V</b>	<b>58.66</b>	<b>51.36</b>	<b>31.83</b>	<b>90.49</b>	<b>83.19</b>			<b>X/F</b>
2483.50	V	22.03	11.53	31.80	53.83	43.33	74.00	54.00	X/E
4924.31	V	45.58	34.34	5.65	51.23	39.99	74.00	54.00	X/H

Remark :

- (1) All readings are Peak unless otherwise stated QP in column of 『Note』 . Peak denotes that the Peak reading compliance with the QP Limits and then QP Mode measurement didn't perform .
- (2) Measuring frequency range from 30MHz to 1000MHz or the 10th harmonic of highest fundamental frequency . "F" denotes fundamental frequency; "H" denotes spurious frequency. "E" denotes band edge frequency. (This judgment method includes the Band Edge Requirement.)
- (3) Radiated emissions measured in frequency range above 1000MHz were made with an instrument using Peak detector mode and AV detector mode of the emission .
- (4) Data of measurement within this frequency range shown " \* " in the table above means the reading of emissions are attenuated more than 20dB below the permissible limits or the field strength is too small to be measured.
- (5) A preamp and high pass filter were used for this test in order to provide sufficient measurement sensitivity.
- (6) EUT Orthogonal Axis :  
 "X" - denotes Laid on Table ; "Y" - denotes Vertical Stand ; "Z" - denotes Side Stand
- (7) During the measurements above 1 GHz it is taken care of that the EUT is always within the 3 dB cone of radiation BW of the used antenna



TX CH11 (Above 1000 MHz, Vertical)

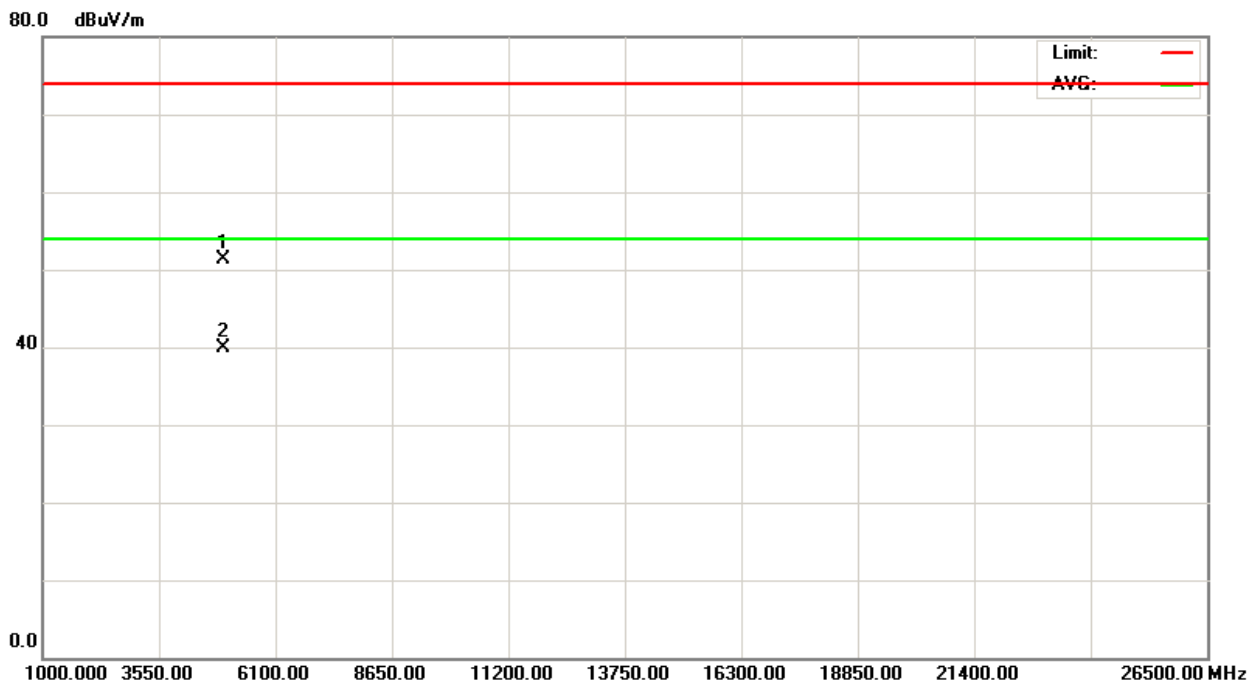
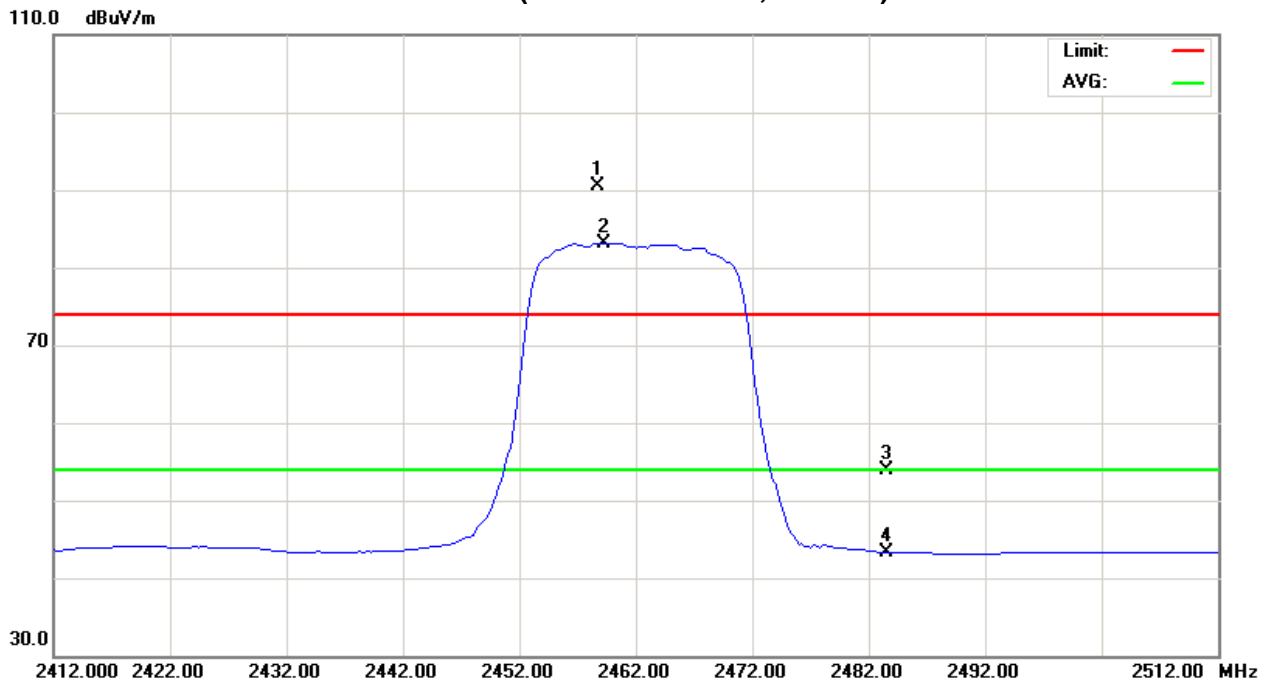



EUT :	150Mbps Wireless N USB Adapter	Model Name :	FWN-651N
Temperature :	25 °C	Relative Humidity :	58 %
Pressure :	1010 hPa	Test Voltage :	AC 120V/60Hz
Test Mode :	TX N-20M MODE 2462MHz		

Freq.	Ant.Pol.	Reading		Ant./CF	Act.		Limit		Note
		Peak	AV		Peak	AV	Peak	AV	
(MHz)	H/V	(dBuV)	(dBuV)	CF(dB)	(dBuV/m)	(dBuV/m)	(dBuV/m)	(dBuV/m)	
<b>2456.75</b>	<b>H</b>	<b>66.89</b>	<b>62.05</b>	<b>31.84</b>	<b>98.73</b>	<b>93.89</b>			<b>X/F</b>
2483.50	H	23.20	10.97	31.80	55.00	42.77	74.00	54.00	X/E
4924.54	H	49.25	37.24	5.65	54.90	42.89	74.00	54.00	X/H

Remark :

- (1) All readings are Peak unless otherwise stated QP in column of 『Note』 . Peak denotes that the Peak reading compliance with the QP Limits and then QP Mode measurement didn't perform .
- (2) Measuring frequency range from 30MHz to 1000MHz or the 10th harmonic of highest fundamental frequency . "F" denotes fundamental frequency; "H" denotes spurious frequency. "E" denotes band edge frequency. (This judgment method includes the Band Edge Requirement.)
- (3) Radiated emissions measured in frequency range above 1000MHz were made with an instrument using Peak detector mode and AV detector mode of the emission .
- (4) Data of measurement within this frequency range shown " \* " in the table above means the reading of emissions are attenuated more than 20dB below the permissible limits or the field strength is too small to be measured.
- (5) A preamp and high pass filter were used for this test in order to provide sufficient measurement sensitivity.
- (6) EUT Orthogonal Axis :  
 "X" - denotes Laid on Table ; "Y" - denotes Vertical Stand ; "Z" - denotes Side Stand
- (7) During the measurements above 1 GHz it is taken care of that the EUT is always within the 3 dB cone of radiation BW of the used antenna



TX CH11 (Above 1000 MHz, Horizontal)

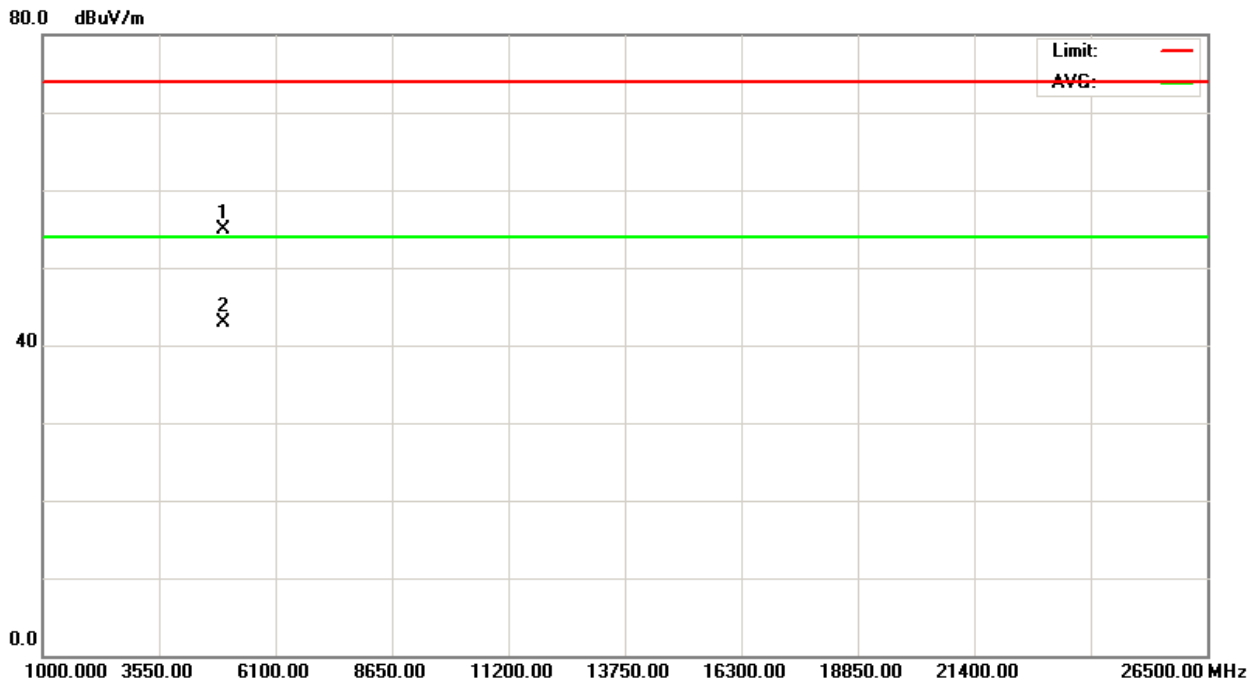
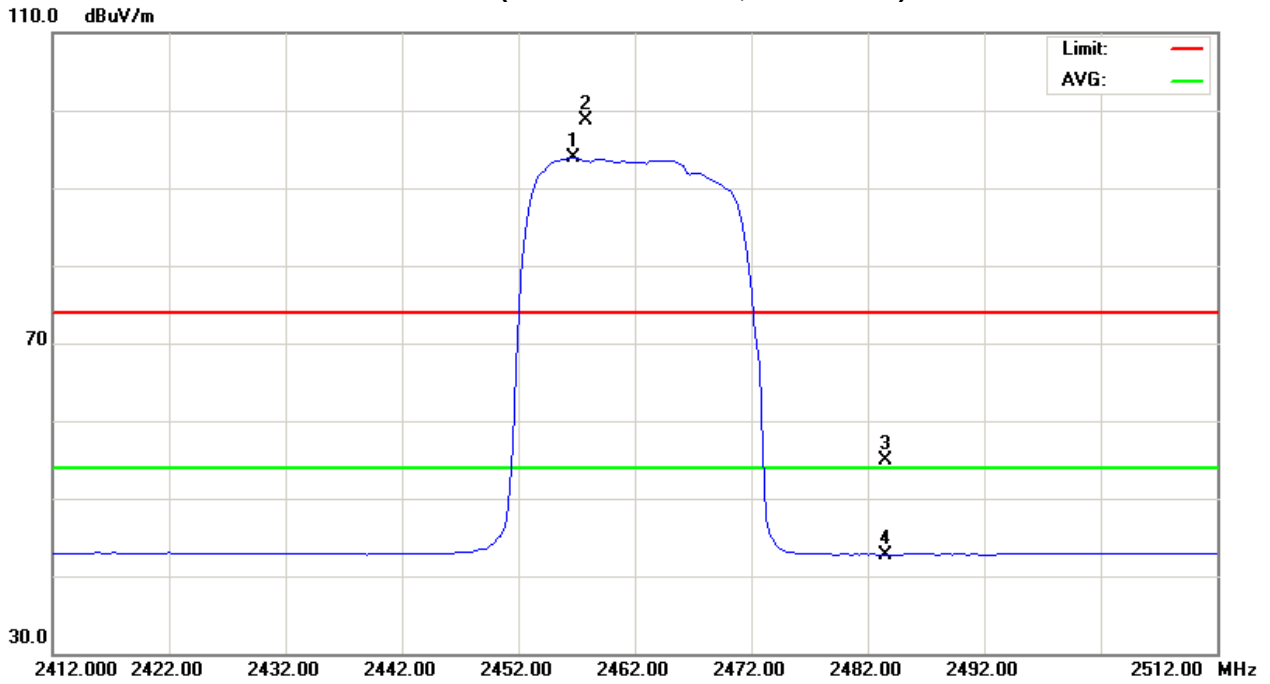



EUT :	150Mbps Wireless N USB Adapter	Model Name :	FWN-651N
Temperature :	25 °C	Relative Humidity :	58 %
Pressure :	1010 hPa	Test Voltage :	AC 120V/60Hz
Test Mode :	TX N-40M MODE 2422MHz		

Freq. (MHz)	Ant.Pol. H/V	Reading		Ant./CF CF(dB)	Act.		Limit		Note
		Peak (dBuV)	AV (dBuV)		Peak (dBuV/m)	AV (dBuV/m)	Peak (dBuV/m)	AV (dBuV/m)	
2390.00	V	26.82	14.40	31.91	58.73	46.31	74.00	54.00	X/E
<b>2412.25</b>	<b>V</b>	<b>59.41</b>	<b>53.40</b>	<b>31.89</b>	<b>91.30</b>	<b>85.29</b>			<b>X/F</b>
4844.34	v	42.21	32.55	5.36	47.57	37.91	74.00	54.00	X/H

Remark :

- (1) All readings are Peak unless otherwise stated QP in column of 『 Note 』 . Peak denotes that the Peak reading compliance with the QP Limits and then QP Mode measurement didn't perform .
- (2) Measuring frequency range from 30MHz to 1000MHz or the 10th harmonic of highest fundamental frequency . "F" denotes fundamental frequency; "H" denotes spurious frequency. "E" denotes band edge frequency. (This judgment method includes the Band Edge Requirement.)
- (3) Radiated emissions measured in frequency range above 1000MHz were made with an instrument using Peak detector mode and AV detector mode of the emission .
- (4) Data of measurement within this frequency range shown " \* " in the table above means the reading of emissions are attenuated more than 20dB below the permissible limits or the field strength is too small to be measured.
- (5) A preamp and high pass filter were used for this test in order to provide sufficient measurement sensitivity.
- (6) EUT Orthogonal Axis :  
"X" - denotes Laid on Table ; "Y" - denotes Vertical Stand ; "Z" - denotes Side Stand
- (7) During the measurements above 1 GHz it is taken care of that the EUT is always within the 3 dB cone of radiation BW of the used antenna





TX CH03 (Above 1000 MHz, Vertical)

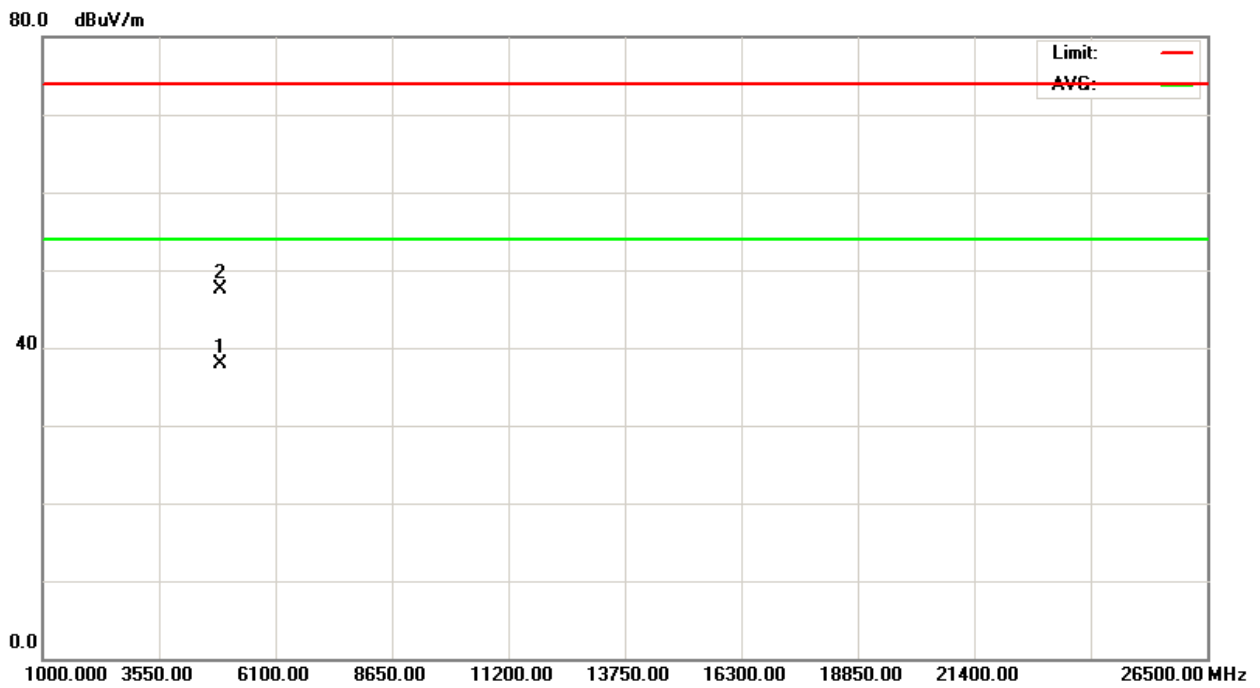
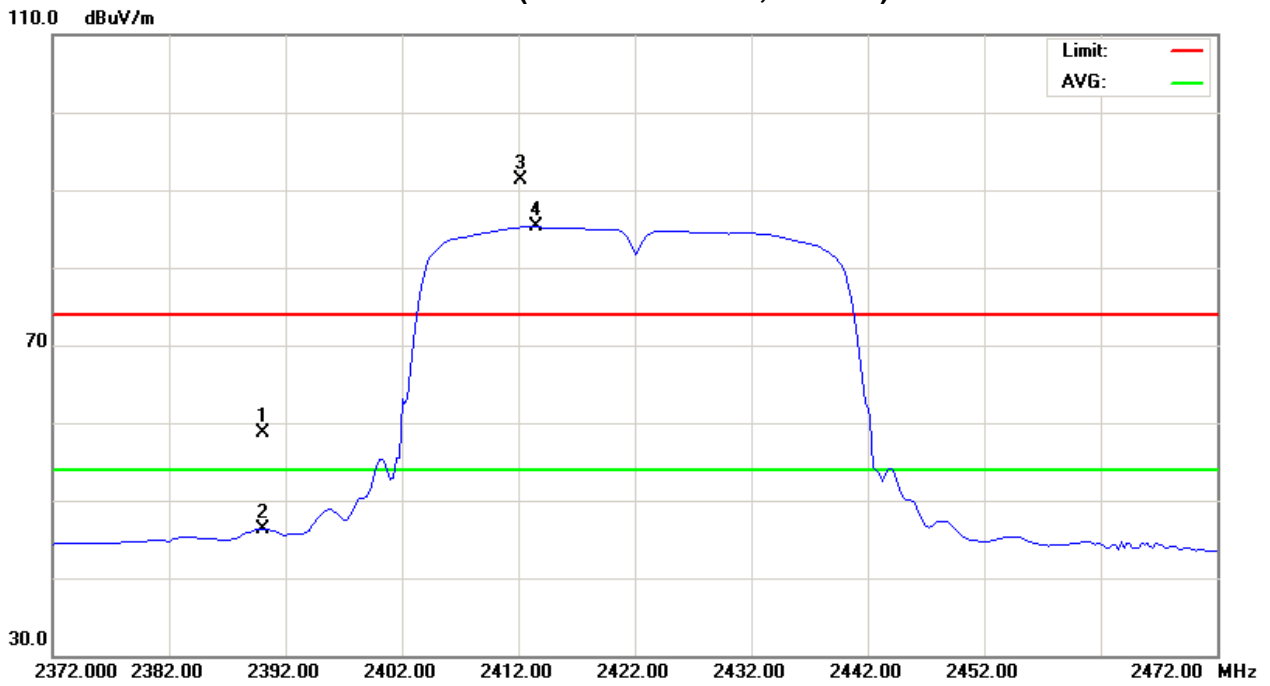



EUT :	150Mbps Wireless N USB Adapter	Model Name :	FWN-651N
Temperature :	25 °C	Relative Humidity :	58 %
Pressure :	1010 hPa	Test Voltage :	AC 120V/60Hz
Test Mode :	TX N-40M MODE 2422MHz		

Freq.	Ant.Pol.	Reading		Ant./CF	Act.		Limit		Note
		Peak	AV		Peak	AV	Peak	AV	
(MHz)	H/V	(dBuV)	(dBuV)	CF(dB)	(dBuV/m)	(dBuV/m)	(dBuV/m)	(dBuV/m)	
2390.00	H	22.46	11.32	31.91	54.37	43.23	74.00	54.00	X/E
<b>2413.50</b>	<b>H</b>	<b>62.56</b>	<b>56.28</b>	<b>31.88</b>	<b>94.44</b>	<b>88.16</b>			<b>X/F</b>
4844.32	H	47.79	35.36	5.36	53.15	40.72	74.00	54.00	X/H

Remark :

- (1) All readings are Peak unless otherwise stated QP in column of 『Note』 . Peak denotes that the Peak reading compliance with the QP Limits and then QP Mode measurement didn't perform .
- (2) Measuring frequency range from 30MHz to 1000MHz or the 10th harmonic of highest fundamental frequency . "F" denotes fundamental frequency; "H" denotes spurious frequency. "E" denotes band edge frequency. (This judgment method includes the Band Edge Requirement.)
- (3) Radiated emissions measured in frequency range above 1000MHz were made with an instrument using Peak detector mode and AV detector mode of the emission .
- (4) Data of measurement within this frequency range shown " \* " in the table above means the reading of emissions are attenuated more than 20dB below the permissible limits or the field strength is too small to be measured.
- (5) A preamp and high pass filter were used for this test in order to provide sufficient measurement sensitivity.
- (6) EUT Orthogonal Axis :  
 "X" - denotes Laid on Table ; "Y" - denotes Vertical Stand ; "Z" - denotes Side Stand
- (7) During the measurements above 1 GHz it is taken care of that the EUT is always within the 3 dB cone of radiation BW of the used antenna



TX CH03 (Above 1000 MHz, Horizontal)

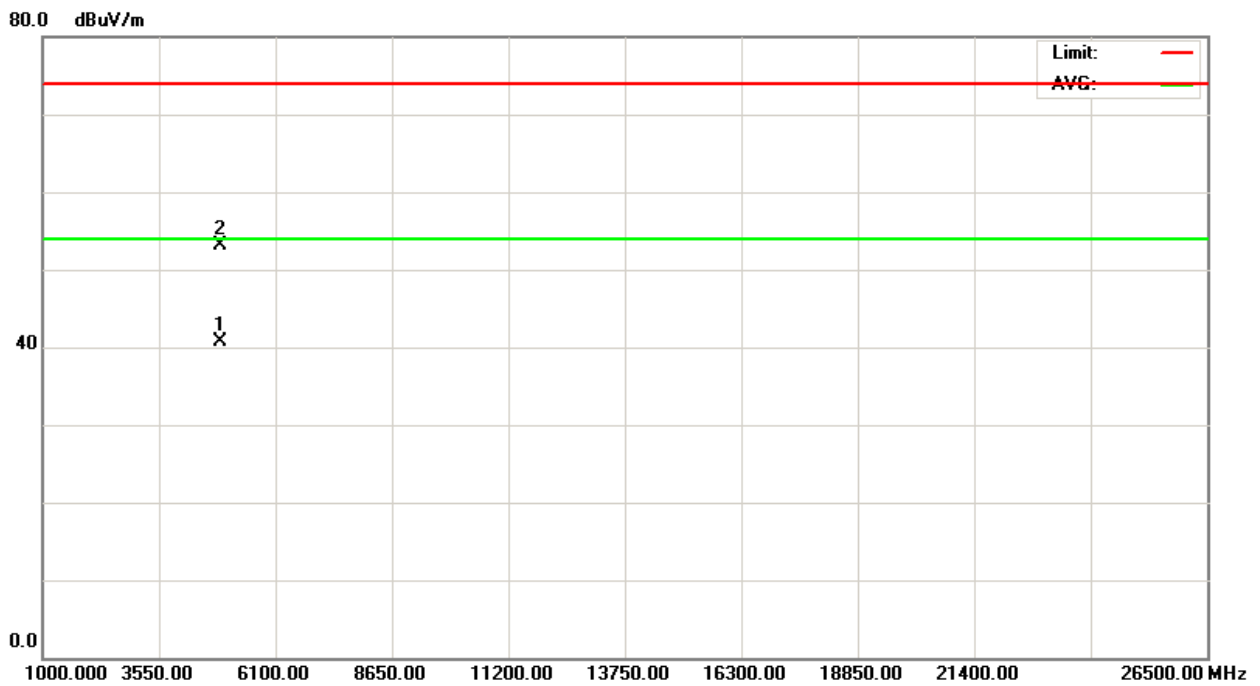
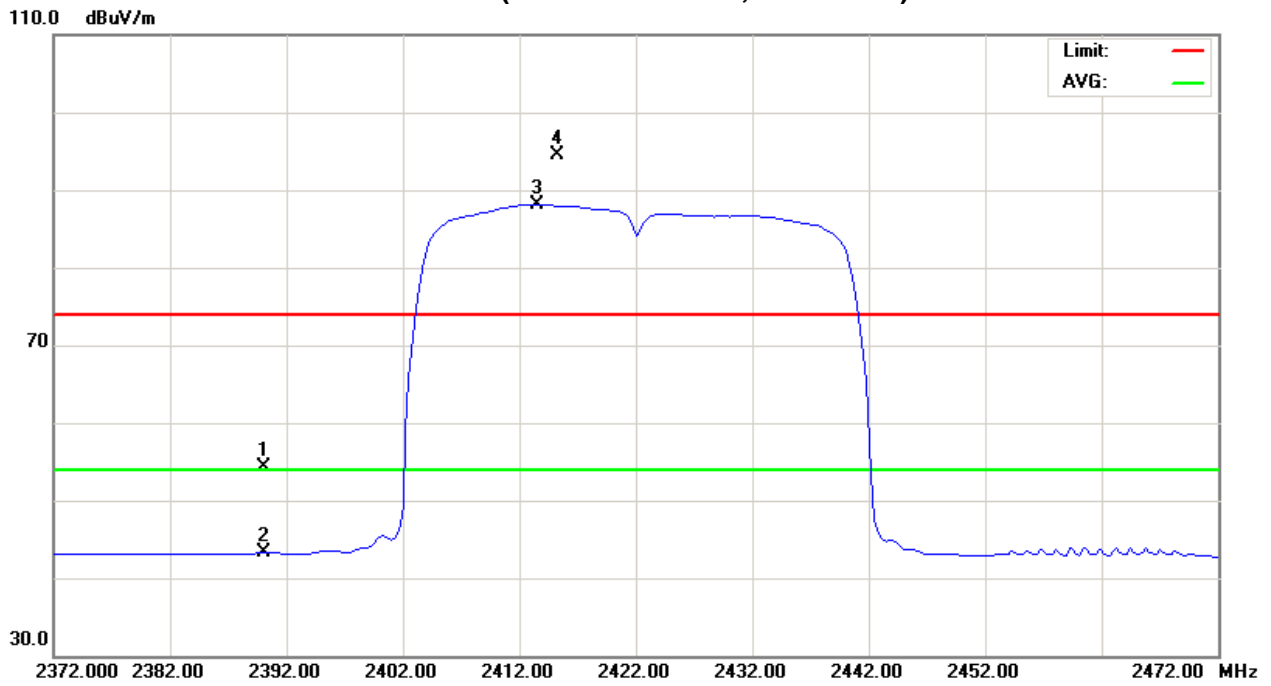



EUT :	150Mbps Wireless N USB Adapter	Model Name :	FWN-651N
Temperature :	25 °C	Relative Humidity :	58 %
Pressure :	1010 hPa	Test Voltage :	AC 120V/60Hz
Test Mode :	TX N-40M MODE 2437MHz		

Freq. (MHz)	Ant.Pol. H/V	Reading		Ant./CF CF(dB)	Act.		Limit		Note
		Peak (dBuV)	AV (dBuV)		Peak (dBuV/m)	AV (dBuV/m)	Peak (dBuV/m)	AV (dBuV/m)	
<b>2427.36</b>	<b>V</b>	<b>60.66</b>	<b>53.00</b>	<b>31.87</b>	<b>92.53</b>	<b>84.87</b>			<b>X/F</b>
4874.05	V	42.02	33.34	5.47	47.49	38.81	74.00	54.00	X/H

Remark :

- (1) All readings are Peak unless otherwise stated QP in column of 『Note』 . Peak denotes that the Peak reading compliance with the QP Limits and then QP Mode measurement didn't perform ◦
- (2) Measuring frequency range from 30MHz to 1000MHz or the 10th harmonic of highest fundamental frequency ◦ "F" denotes fundamental frequency; "H" denotes spurious frequency. "E" denotes band edge frequency. (This judgment method includes the Band Edge Requirement.)
- (3) Radiated emissions measured in frequency range above 1000MHz were made with an instrument using Peak detector mode and AV detector mode of the emission ◦
- (4) Data of measurement within this frequency range shown " \* " in the table above means the reading of emissions are attenuated more than 20dB below the permissible limits or the field strength is too small to be measured.
- (5) A preamp and high pass filter were used for this test in order to provide sufficient measurement sensitivity.
- (6) EUT Orthogonal Axis :  
"X" - denotes Laid on Table ; "Y" - denotes Vertical Stand ; "Z" - denotes Side Stand
- (7) During the measurements above 1 GHz it is taken care of that the EUT is always within the 3 dB cone of radiation BW of the used antenna



TX CH06 (Above 1000 MHz, Vertical)

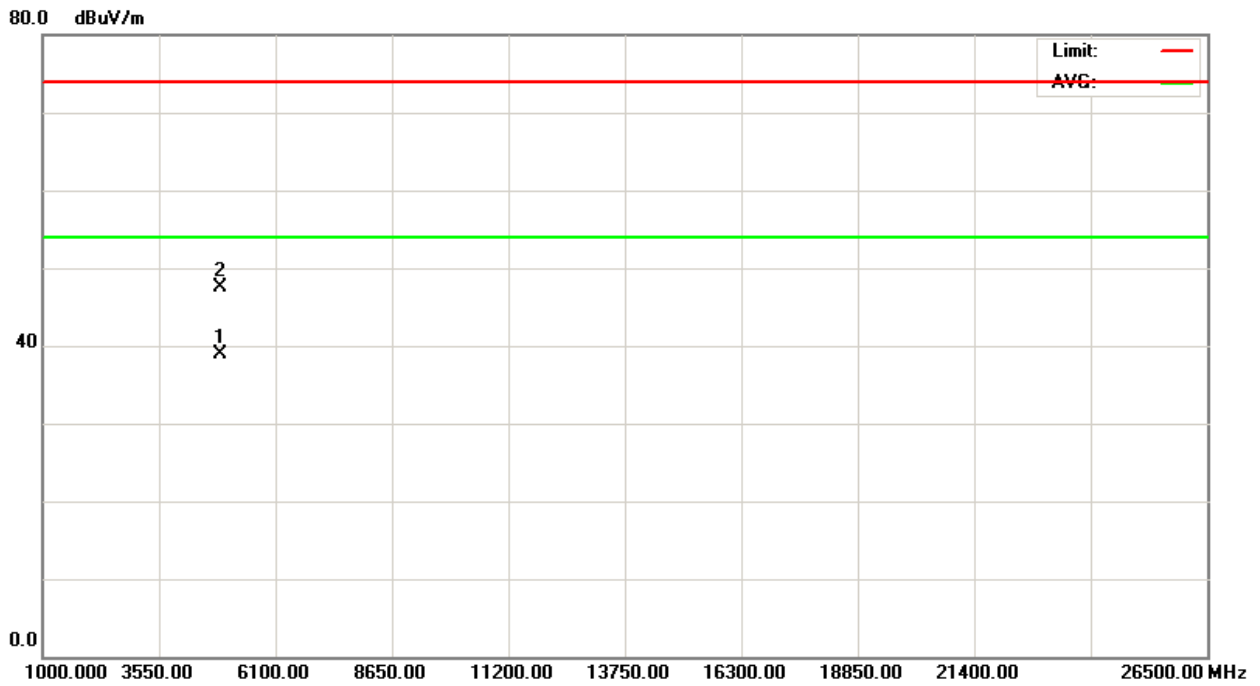
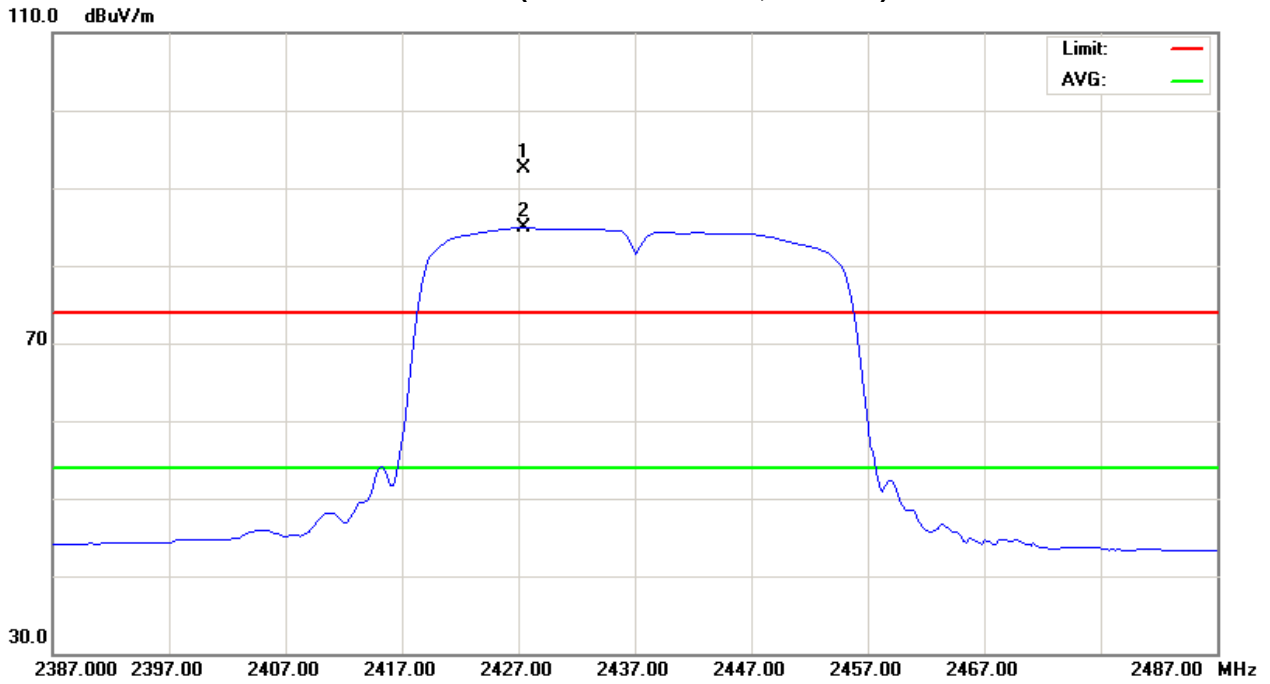



EUT :	150Mbps Wireless N USB Adapter	Model Name :	FWN-651N
Temperature :	25 °C	Relative Humidity :	58 %
Pressure :	1010 hPa	Test Voltage :	AC 120V/60Hz
Test Mode :	TX N-40M MODE 2437MHZ		

Freq.	Ant.Pol.	Reading		Ant./CF	Act.		Limit		Note
		Peak	AV		Peak	AV	Peak	AV	
(MHz)	H/V	(dBuV)	(dBuV)	CF(dB)	(dBuV/m)	(dBuV/m)	(dBuV/m)	(dBuV/m)	
<b>2427.40</b>	<b>H</b>	<b>65.43</b>	<b>59.23</b>	<b>31.87</b>	<b>97.30</b>	<b>91.10</b>			<b>X/F</b>
4874.17	H	48.61	35.72	5.47	54.08	41.19	74.00	54.00	X/H

Remark :

- (1) All readings are Peak unless otherwise stated QP in column of 『Note』 . Peak denotes that the Peak reading compliance with the QP Limits and then QP Mode measurement didn't perform ◦
- (2) Measuring frequency range from 30MHz to 1000MHz or the 10th harmonic of highest fundamental frequency ◦ "F" denotes fundamental frequency; "H" denotes spurious frequency. "E" denotes band edge frequency. (This judgment method includes the Band Edge Requirement.)
- (3) Radiated emissions measured in frequency range above 1000MHz were made with an instrument using Peak detector mode and AV detector mode of the emission ◦
- (4) Data of measurement within this frequency range shown " \* " in the table above means the reading of emissions are attenuated more than 20dB below the permissible limits or the field strength is too small to be measured.
- (5) A preamp and high pass filter were used for this test in order to provide sufficient measurement sensitivity.
- (6) EUT Orthogonal Axis :  
"X" - denotes Laid on Table ; "Y" - denotes Vertical Stand ; "Z" - denotes Side Stand
- (7) During the measurements above 1 GHz it is taken care of that the EUT is always within the 3 dB cone of radiation BW of the used antenna



TX CH06 (Above 1000 MHz, Horizontal)

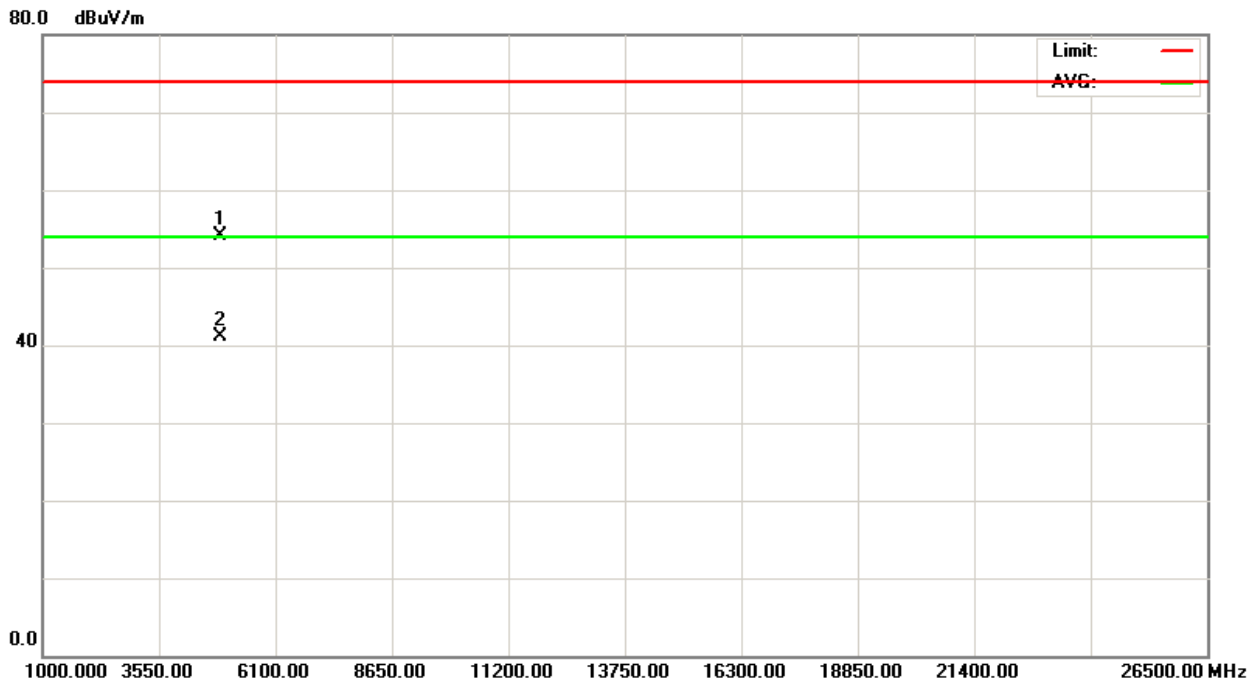
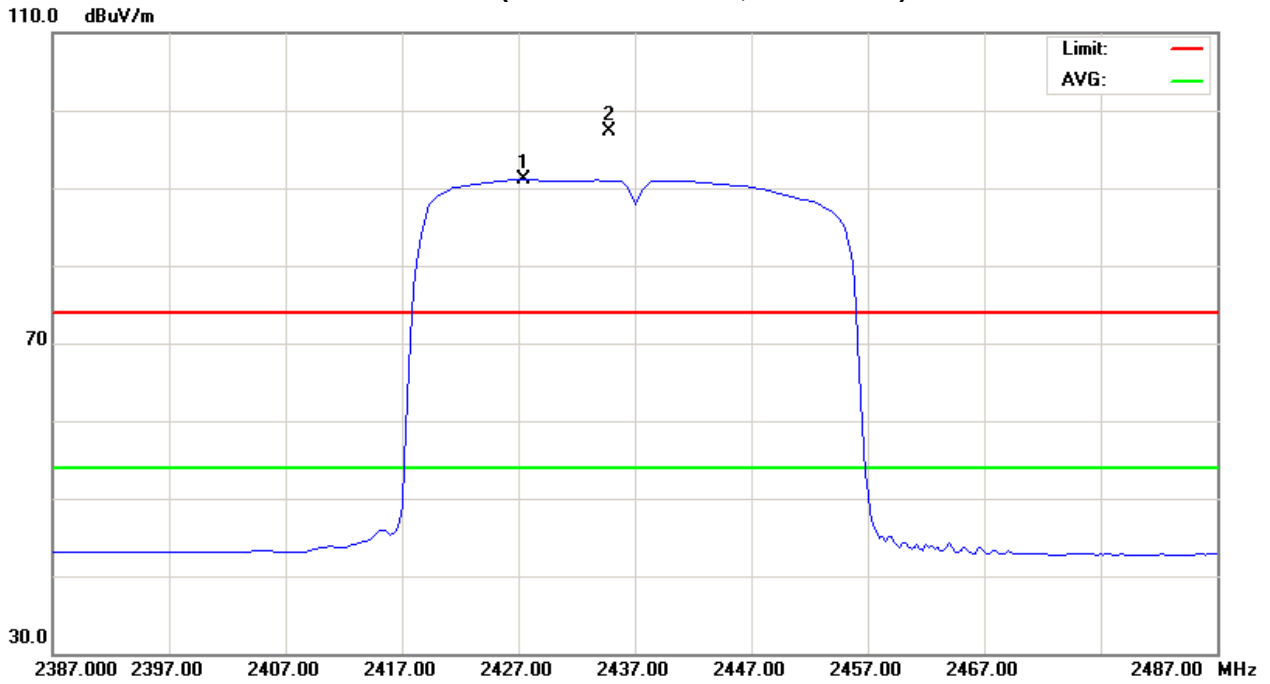



EUT :	150Mbps Wireless N USB Adapter	Model Name :	FWN-651N
Temperature :	25 °C	Relative Humidity :	58 %
Pressure :	1010 hPa	Test Voltage :	AC 120V/60Hz
Test Mode :	TX N-40M MODE 2452MHz		

Freq.	Ant.Pol.	Reading		Ant./CF	Act.		Limit		Note
		Peak	AV		Peak	AV	Peak	AV	
(MHz)	H/V	(dBuV)	(dBuV)	CF(dB)	(dBuV/m)	(dBuV/m)	(dBuV/m)	(dBuV/m)	
<b>2442.12</b>	<b>V</b>	<b>59.12</b>	<b>52.89</b>	<b>31.85</b>	<b>90.97</b>	<b>84.74</b>			<b>X/F</b>
2483.50	V	24.05	12.83	31.80	55.85	44.63	74.00	54.00	X/E
4904.01	V	42.10	33.24	5.58	47.68	38.82	74.00	54.00	X/H

Remark :

- (1) All readings are Peak unless otherwise stated QP in column of 『Note』 . Peak denotes that the Peak reading compliance with the QP Limits and then QP Mode measurement didn't perform .
- (2) Measuring frequency range from 30MHz to 1000MHz or the 10th harmonic of highest fundamental frequency . "F" denotes fundamental frequency; "H" denotes spurious frequency. "E" denotes band edge frequency. (This judgment method includes the Band Edge Requirement.)
- (3) Radiated emissions measured in frequency range above 1000MHz were made with an instrument using Peak detector mode and AV detector mode of the emission .
- (4) Data of measurement within this frequency range shown " \* " in the table above means the reading of emissions are attenuated more than 20dB below the permissible limits or the field strength is too small to be measured.
- (5) A preamp and high pass filter were used for this test in order to provide sufficient measurement sensitivity.
- (6) EUT Orthogonal Axis :  
 "X" - denotes Laid on Table ; "Y" - denotes Vertical Stand ; "Z" - denotes Side Stand
- (7) During the measurements above 1 GHz it is taken care of that the EUT is always within the 3 dB cone of radiation BW of the used antenna





TX CH09 (Above 1000 MHz, Vertical)

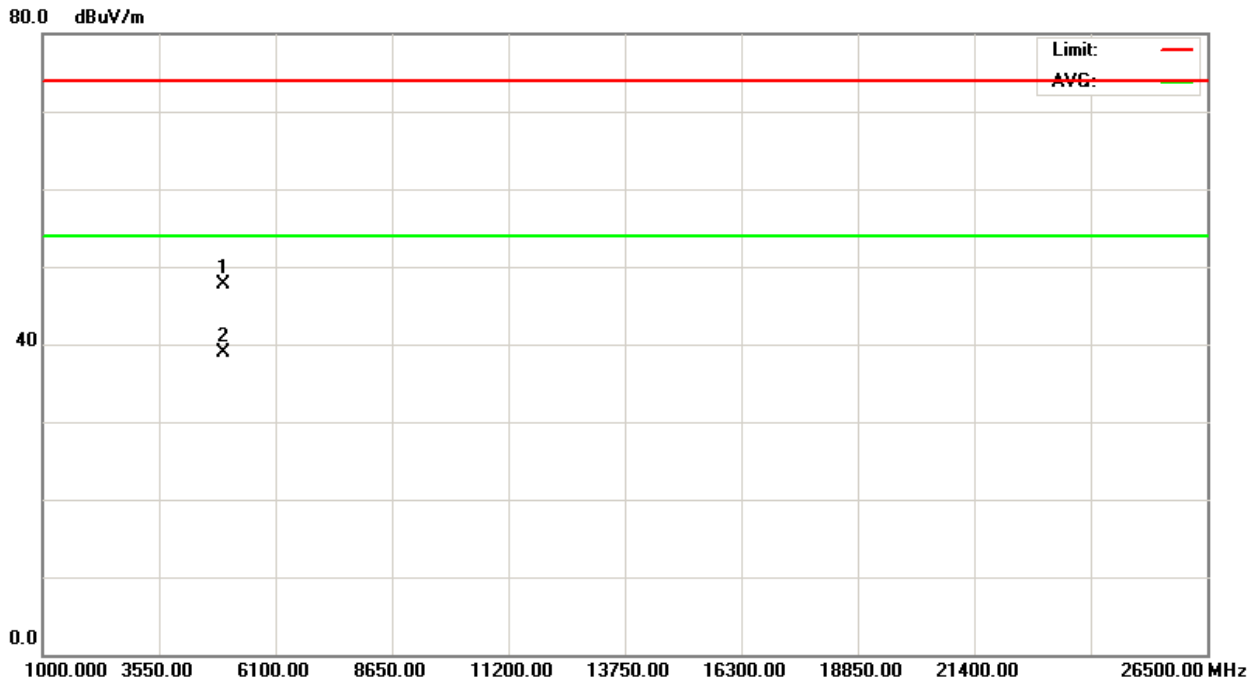
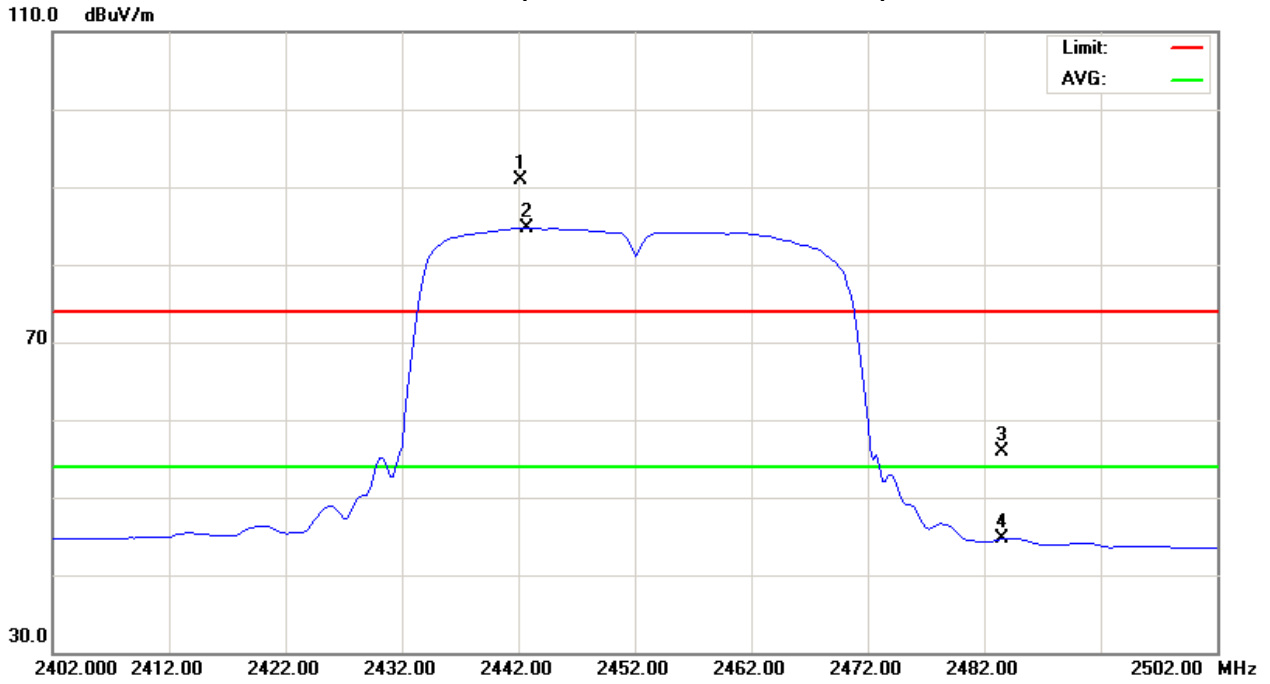



EUT :	150Mbps Wireless N USB Adapter	Model Name :	FWN-651N
Temperature :	25 °C	Relative Humidity :	58 %
Pressure :	1010 hPa	Test Voltage :	AC 120V/60Hz
Test Mode :	TX N-40M MODE 2452MHz		

Freq.	Ant.Pol.	Reading		Ant./CF	Act.		Limit		Note
		Peak	AV		Peak	AV	Peak	AV	
(MHz)	H/V	(dBuV)	(dBuV)	CF(dB)	(dBuV/m)	(dBuV/m)	(dBuV/m)	(dBuV/m)	
<b>2446.50</b>	<b>H</b>	<b>65.29</b>	<b>58.18</b>	<b>31.85</b>	<b>97.14</b>	<b>90.03</b>			<b>X/F</b>
2483.50	H	22.90	11.29	31.80	54.70	43.09	74.00	54.00	X/E
4904.23	H	48.69	36.57	5.58	54.27	42.15	74.00	54.00	X/H

Remark :

- (1) All readings are Peak unless otherwise stated QP in column of 『Note』 . Peak denotes that the Peak reading compliance with the QP Limits and then QP Mode measurement didn't perform .
- (2) Measuring frequency range from 30MHz to 1000MHz or the 10th harmonic of highest fundamental frequency . "F" denotes fundamental frequency; "H" denotes spurious frequency. "E" denotes band edge frequency. (This judgment method includes the Band Edge Requirement.)
- (3) Radiated emissions measured in frequency range above 1000MHz were made with an instrument using Peak detector mode and AV detector mode of the emission .
- (4) Data of measurement within this frequency range shown " \* " in the table above means the reading of emissions are attenuated more than 20dB below the permissible limits or the field strength is too small to be measured.
- (5) A preamp and high pass filter were used for this test in order to provide sufficient measurement sensitivity.
- (6) EUT Orthogonal Axis :  
 "X" - denotes Laid on Table ; "Y" - denotes Vertical Stand ; "Z" - denotes Side Stand
- (7) During the measurements above 1 GHz it is taken care of that the EUT is always within the 3 dB cone of radiation BW of the used antenna



TX CH09 (Above 1000 MHz, Horizontal)

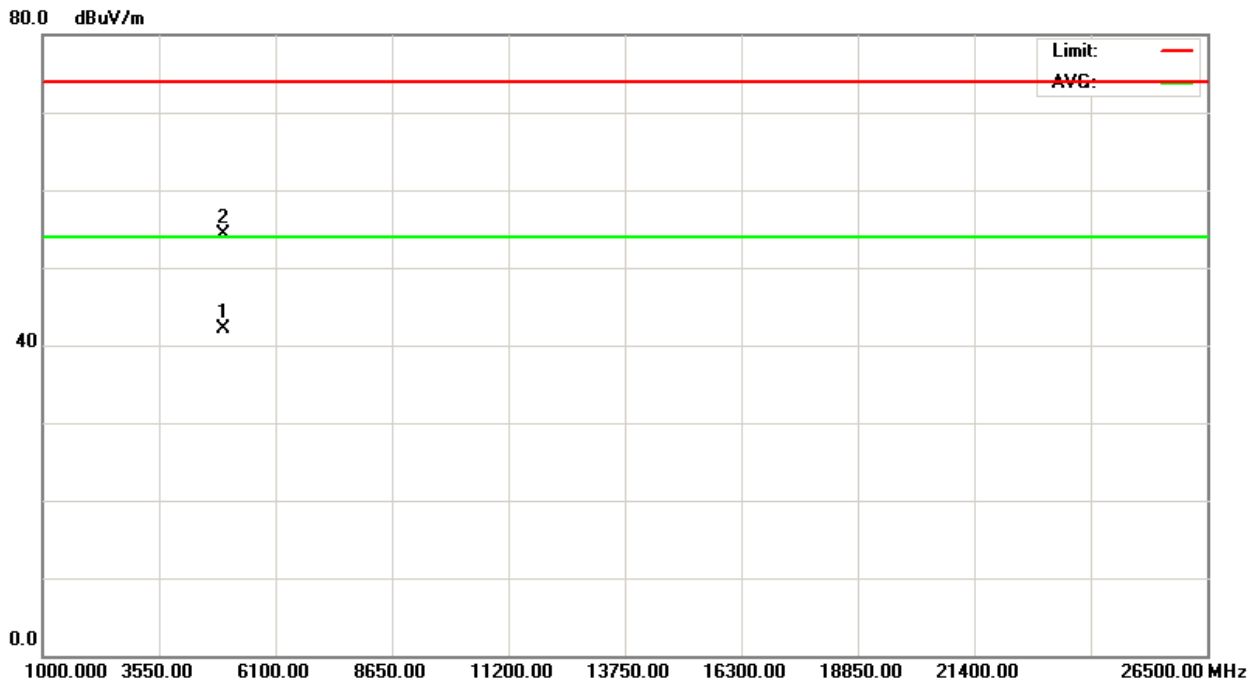
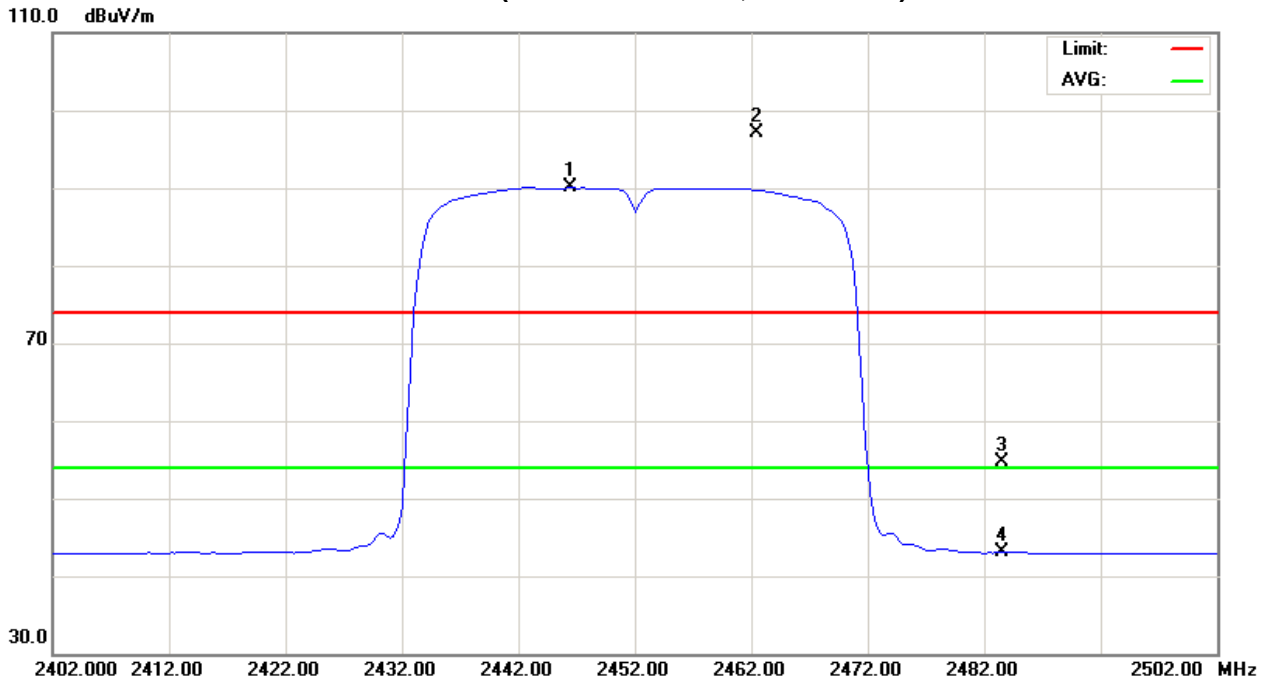



## 5. BANDWIDTH TEST

### 5.1 Applied procedures / limit

FCC Part15 (15.247) , Subpart C				
Section	Test Item	Limit	Frequency Range (MHz)	Result
15.247(a)(2)	Bandwidth	$\geq 500\text{KHz}$ (6dB bandwidth)	2400-2483.5	PASS

### 5.1.1 MEASUREMENT INSTRUMENTS LIST

Item	Kind of Equipment	Manufacturer	Type No.	Serial No.	Calibrated until
1	Spectrum Analyzer	R&S	FSP 40	100185	Nov.25.2012

Remark: " N/A" denotes No Model Name. , Serial No. or No Calibration specified.

### 5.1.2 TEST PROCEDURE

- The EUT was directly connected to the spectrum analyzer and antenna output port as show in the block diagram below,
- Spectrum Setting : RBW= 100KHz, VBW=100KHz, Sweep time = 5 ms.

### 5.1.3 DEVIATION FROM STANDARD

No deviation.

### 5.1.4 TEST SETUP

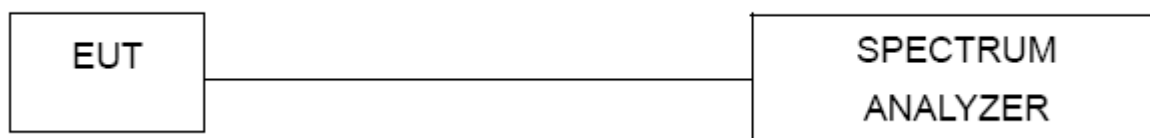

### 5.1.5 EUT OPERATION CONDITIONS

The EUT tested system was configured as the statements of 4.1.6 Unless otherwise a special operating condition is specified in the follows during the testing.



5.1.6 TEST RESULTS

EUT :	150Mbps Wireless N USB Adapter	Model Name. :	FWN-651ND; FWN-651N
Temperature :	24 °C	Relative Humidity :	60 %
Pressure :	1016 hPa	Test Voltage :	AC 120V/60Hz
Test Mode :	TX B MODE /CH01, CH06, CH11		

Test Channel	Frequency (MHz)	Bandwidth (MHz)	LIMIT (MHz)
CH01	2412	12.08	>=500KHz
CH06	2437	12.08	>=500KHz
CH11	2462	11.98	>=500KHz

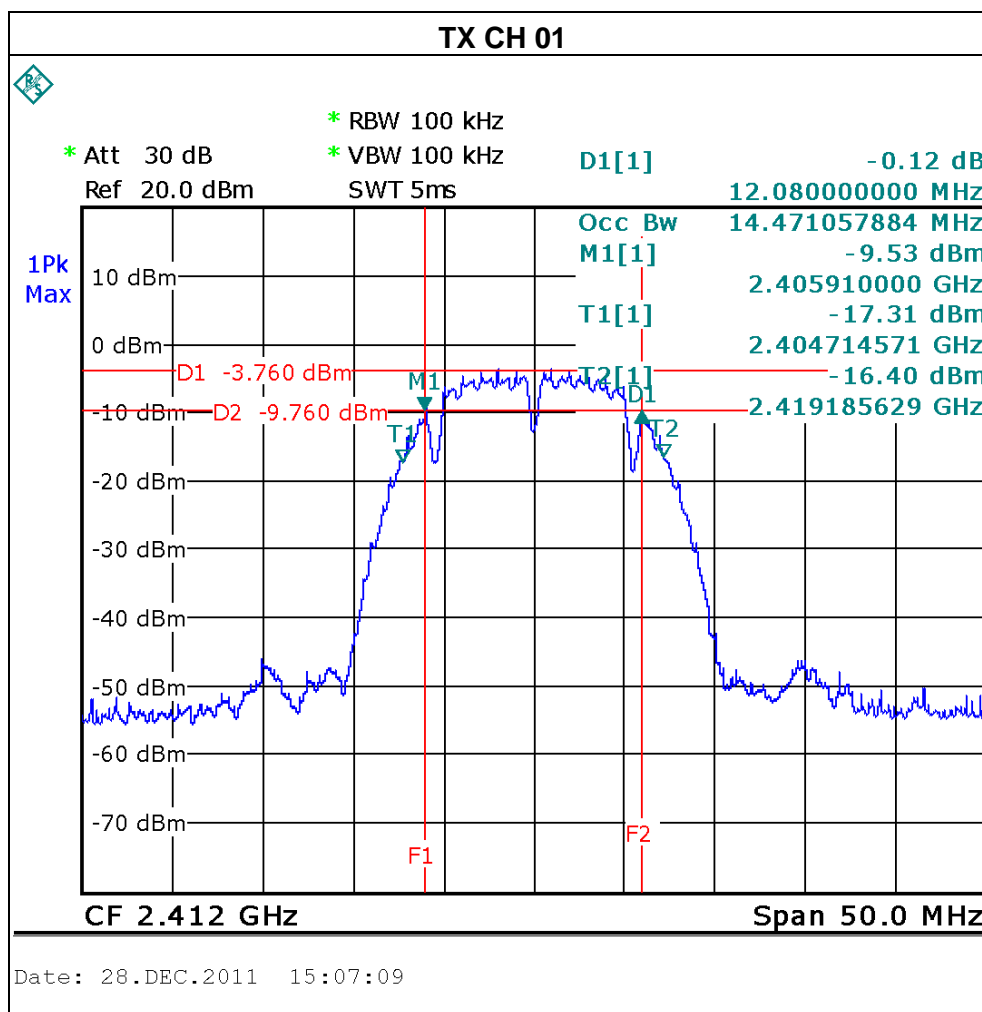





EUT :	150Mbps Wireless N USB Adapter	Model Name. :	FWN-651ND; FWN-651N
Temperature :	24 °C	Relative Humidity :	60 %
Pressure :	1016 hPa	Test Voltage :	AC 120V/60Hz
Test Mode :	TX G MODE /CH01, CH06, CH11		

Test Channel	Frequency (MHz)	Bandwidth (MHz)	LIMIT (MHz)
CH01	2412	16.47	>=500KHz
CH06	2437	16.51	>=500KHz
CH11	2462	16.47	>=500KHz

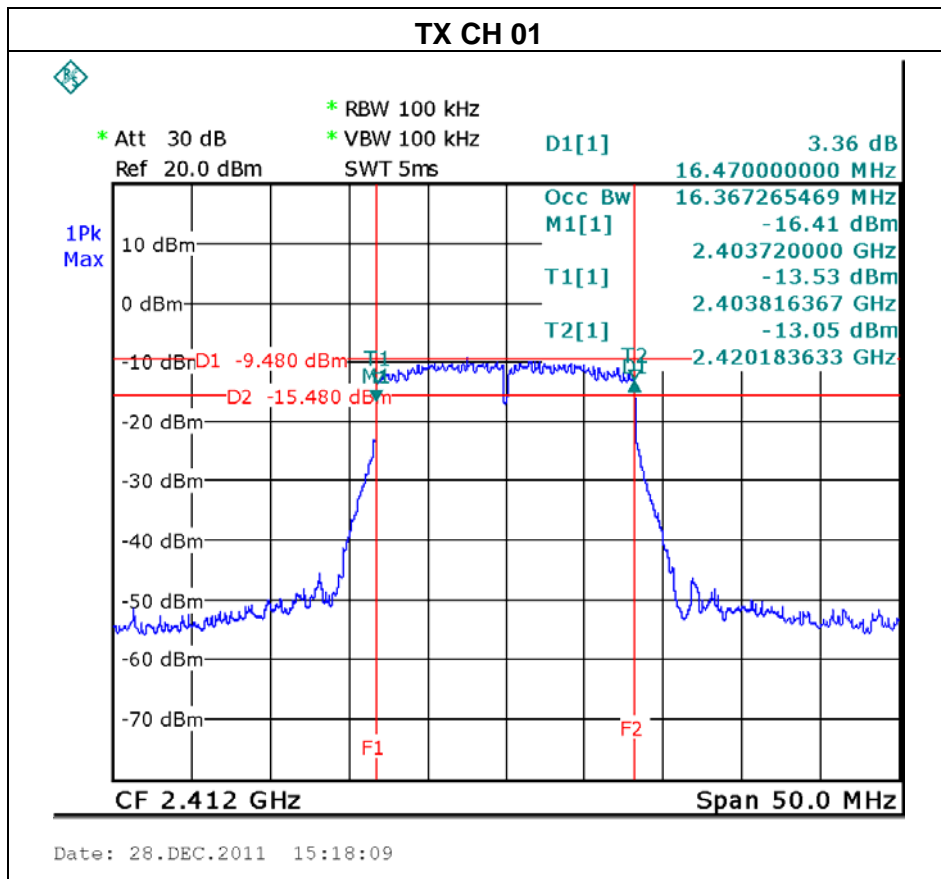

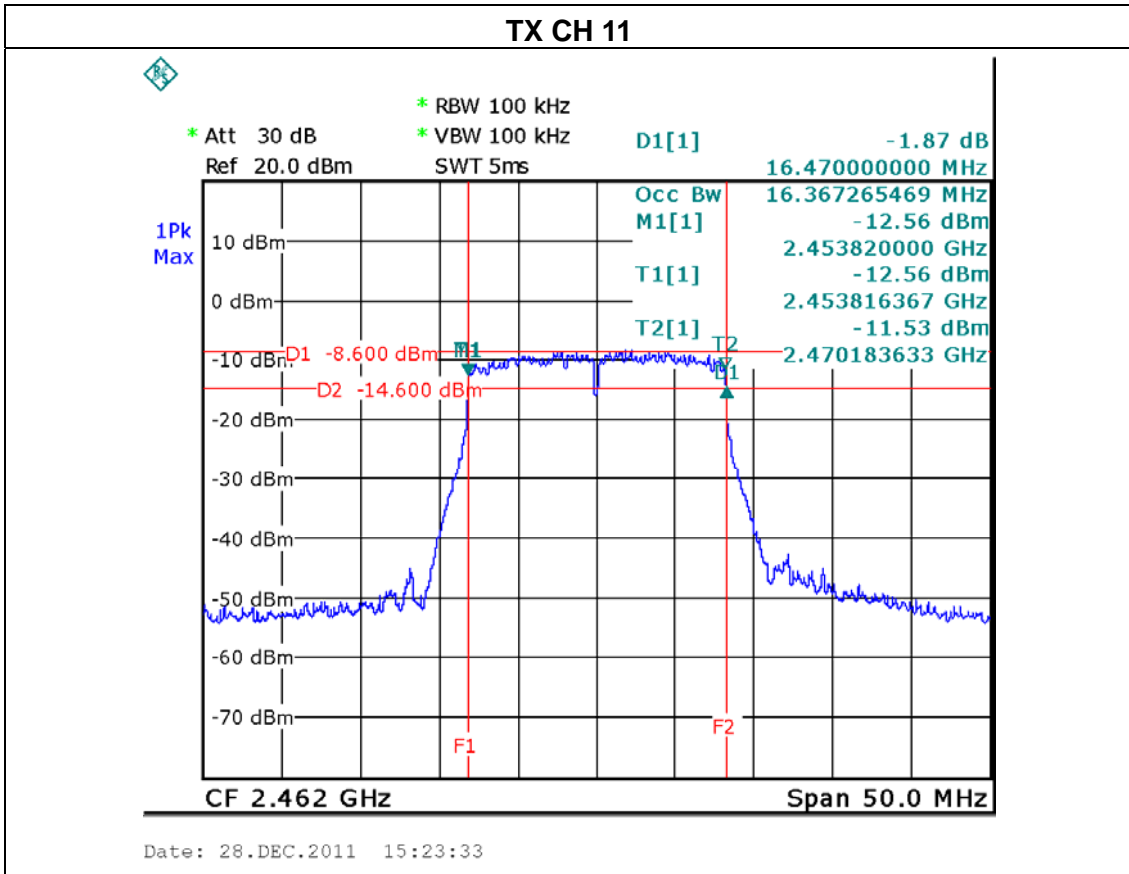
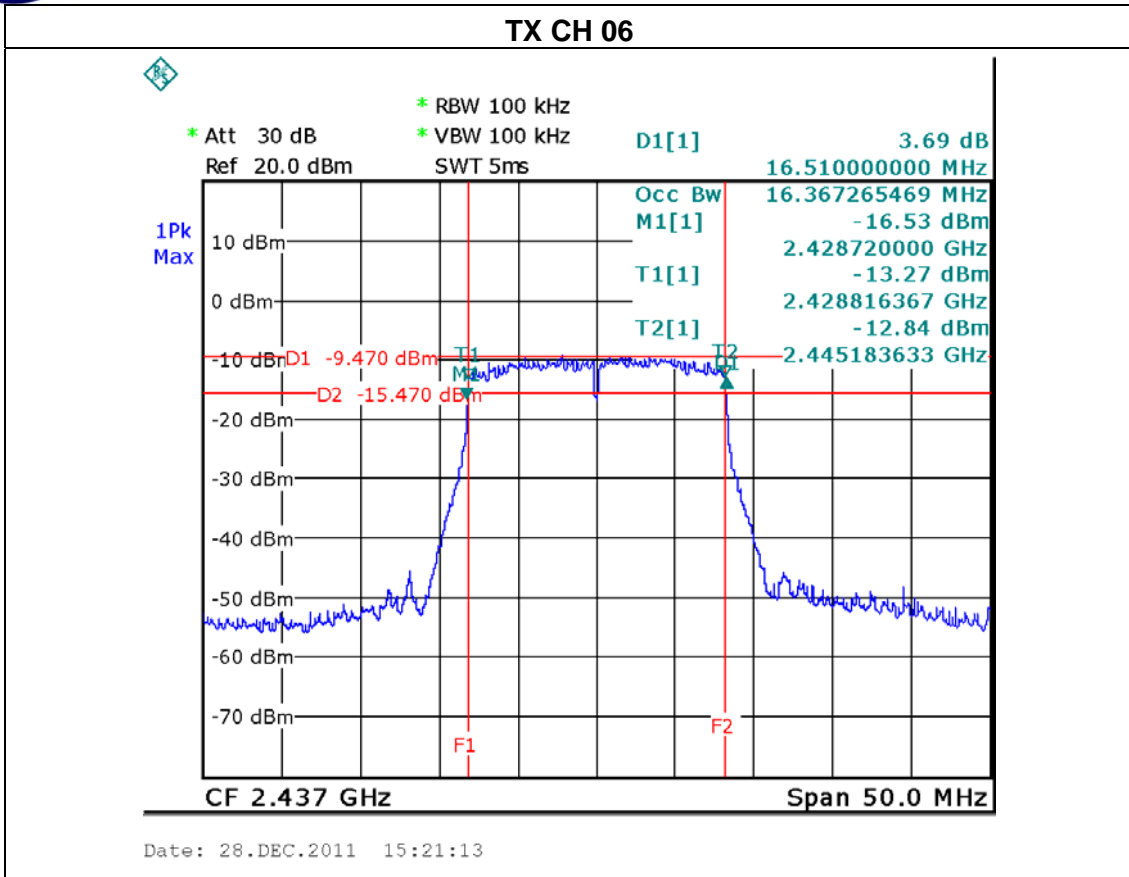





EUT :	150Mbps Wireless N USB Adapter	Model Name. :	FWN-651ND; FWN-651N
Temperature :	24 °C	Relative Humidity :	60 %
Pressure :	1016 hPa	Test Voltage :	AC 120V/60Hz
Test Mode :	TX N MODE -20MHz/ CH01, CH06, CH11		

Test Channel	Frequency (MHz)	Bandwidth (MHz)	LIMIT (MHz)
CH01	2412	17.66	>=500KHz
CH06	2437	17.62	>=500KHz
CH11	2462	17.66	>=500KHz

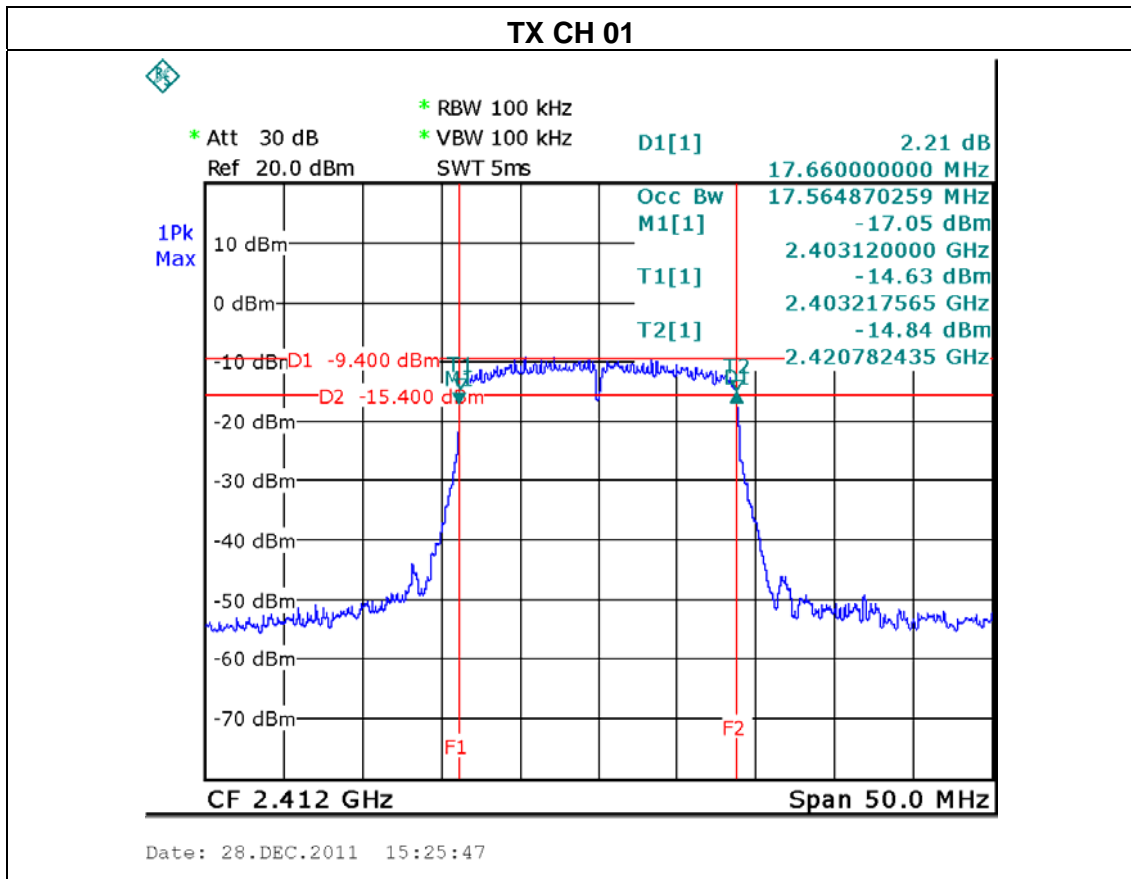

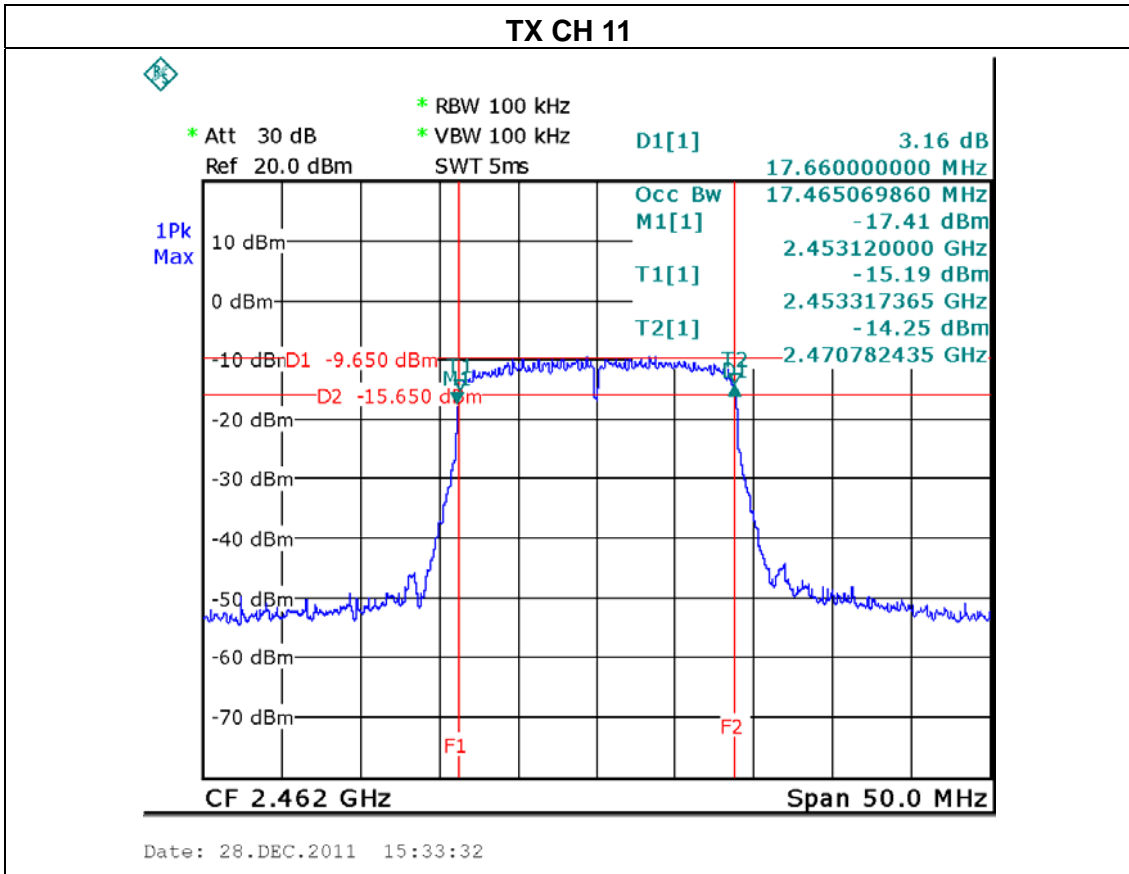
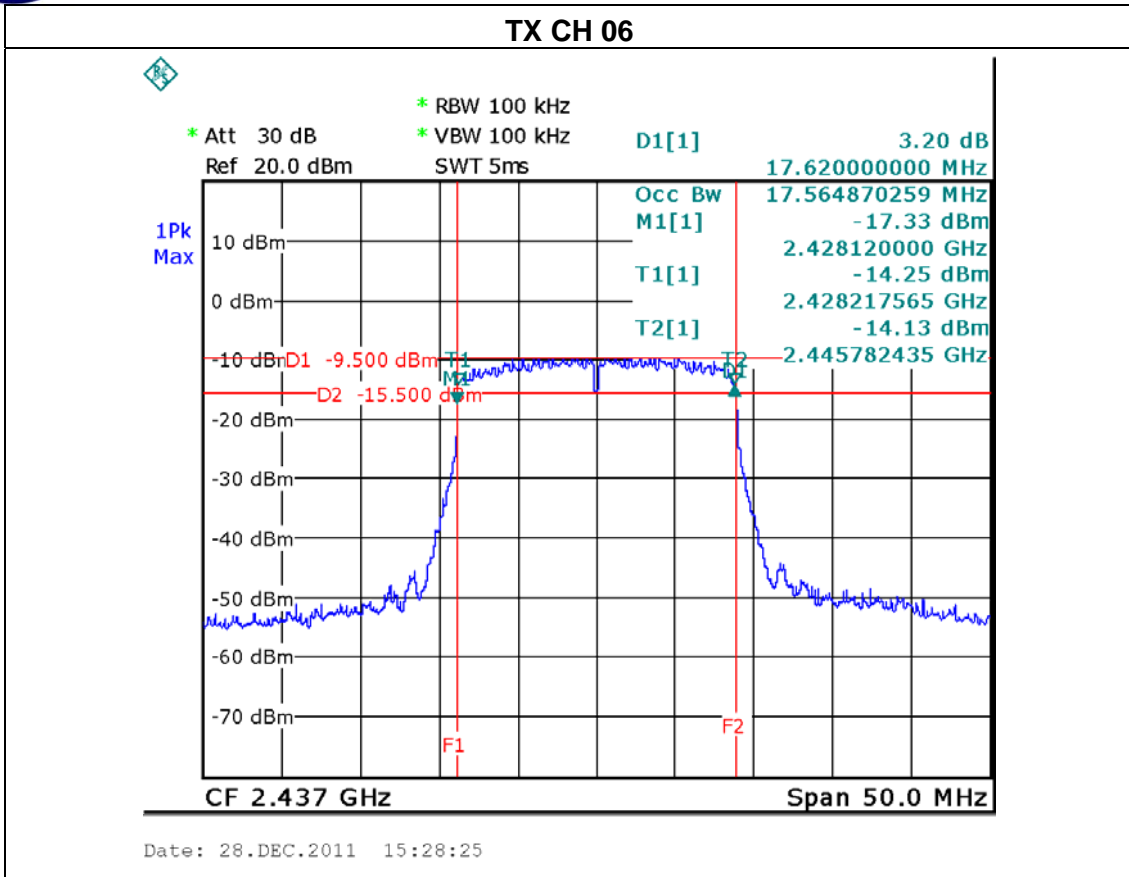



EUT :	150Mbps Wireless N USB Adapter	Model Name. :	FWN-651ND; FWN-651N
Temperature :	24 °C	Relative Humidity :	60 %
Pressure :	1016 hPa	Test Voltage :	AC 120V/60Hz
Test Mode :	TX N MODE -40MHz/ CH03, CH06, CH09		

Test Channel	Frequency (MHz)	Bandwidth (MHz)	LIMIT (MHz)
CH03	2422	36.13	>=500KHz
CH06	2437	36.13	>=500KHz
CH09	2452	35.90	>=500KHz

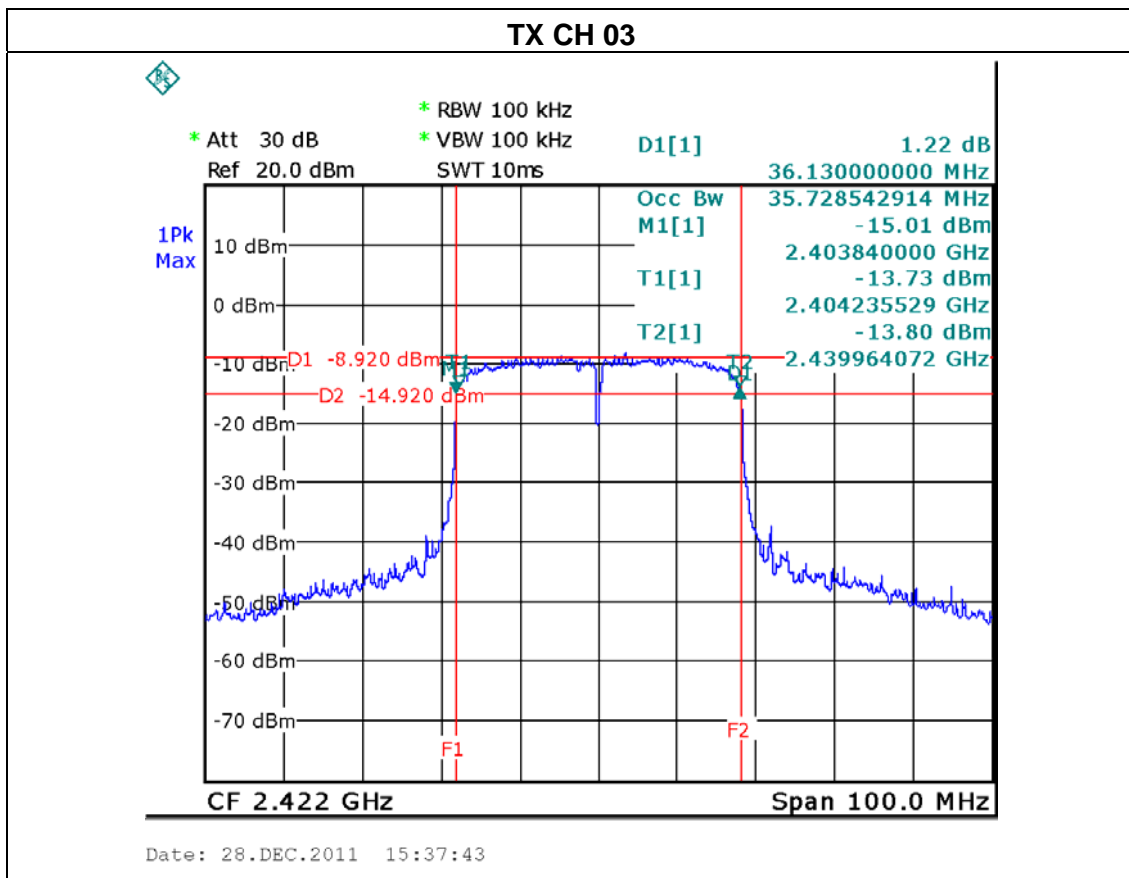

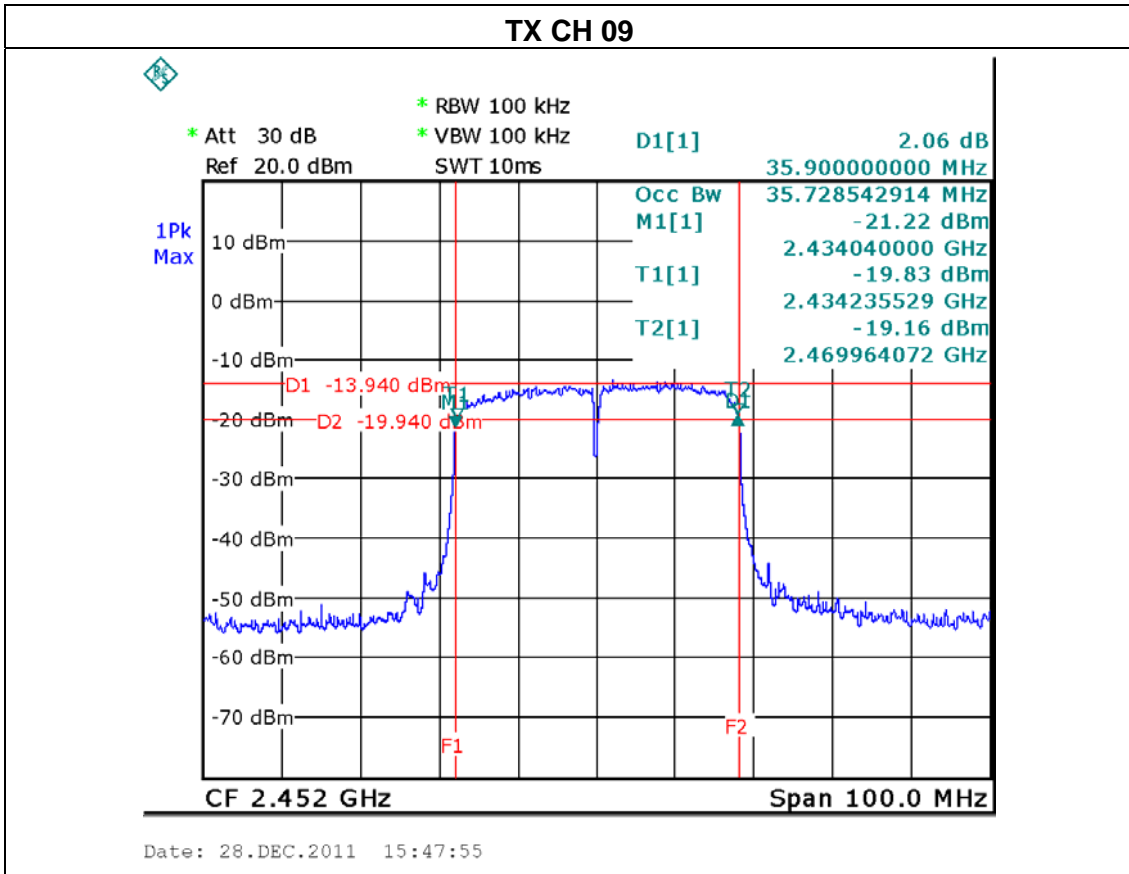
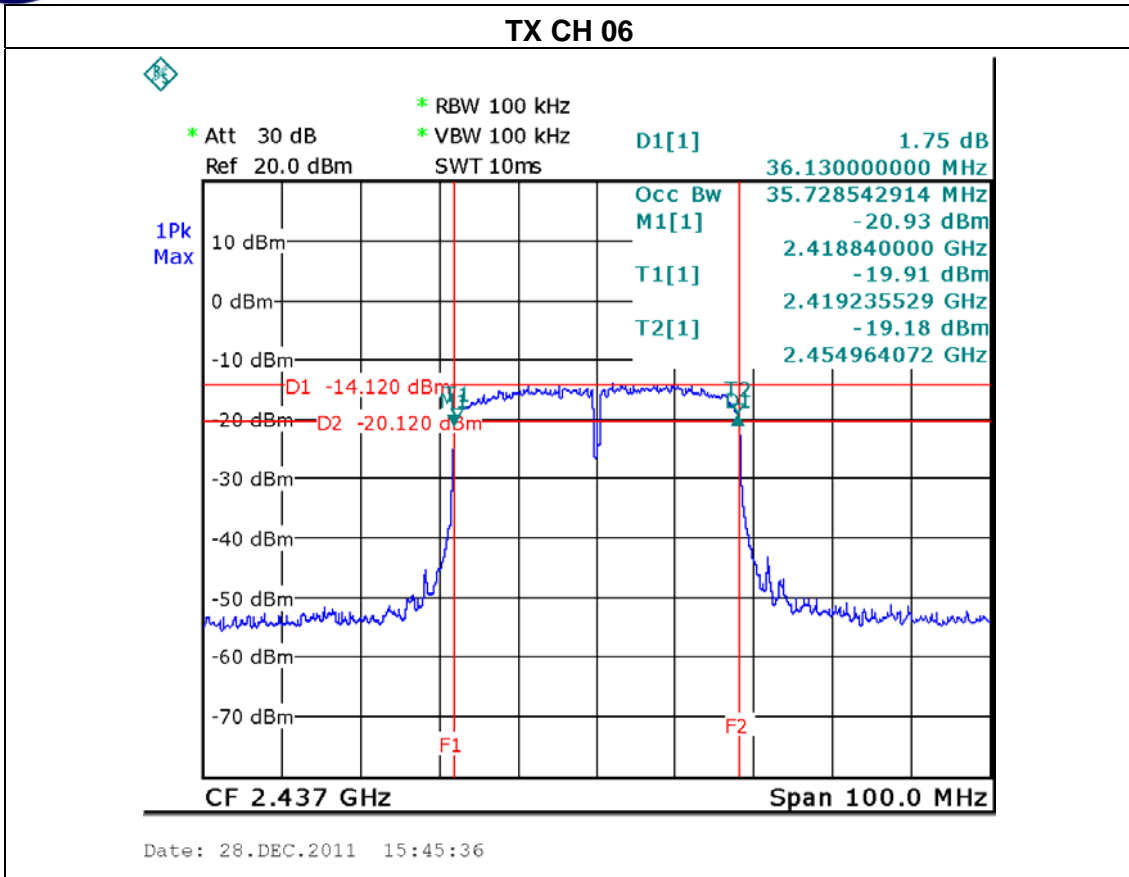



**6. MAXIMUM OUTPUT POWER TEST**

**6.1 Applied procedures / limit**

FCC Part15 (15.247) , Subpart C				
Section	Test Item	Limit	Frequency Range (MHz)	Result
15.247(b)(3)	Maximum Output Power	1 watt or 30dBm	2400-2483.5	PASS

**6.1.1 MEASUREMENT INSTRUMENTS LIST**

Item	Kind of Equipment	Manufacturer	Type No.	Serial No.	Calibrated until
1	Spectrum Analyzer	R&S	FSP 40	100185	Nov.25.2012

Remark: " N/A" denotes No Model Name. , Serial No. or No Calibration specified.

**6.1.2 TEST PROCEDURE**

- a. The EUT was directly connected to the spectrum analyzer and antenna output port as show in the block diagram below,
- b. Spectrum Setting : RBW= 1MHz, VBW=3MHz, Sample detector,Sweep time = Auto.

**6.1.3 DEVIATION FROM STANDARD**

No deviation.

**6.1.4 TEST SETUP**



**6.1.5 EUT OPERATION CONDITIONS**

The EUT tested system was configured as the statements of 4.1.6 Unless otherwise a special operating condition is specified in the follows during the testing. Transmit output power was measured while the host equipment supply voltage was varied from 85 % to 115 % of the nominal rated supply voltage. No change in transmit output power was observed.



**6.1.6 TEST RESULTS**

EUT :	150Mbps Wireless N USB Adapter	Model Name :	FWN-651ND; FWN-651N
Temperature :	24 °C	Relative Humidity :	60 %
Pressure :	1016 hPa	Test Voltage :	AC 120V/60Hz
Test Mode :	TX B MODE /CH01, CH06, CH11		

**Maximum Output Power**

Test Channel	Frequency (MHz)	Output Power (dBm)	LIMIT (dBm)	LIMIT (W)
CH01	2412 MHz	11.16	30	1
CH06	2437 MHz	11.16	30	1
CH11	2462 MHz	11.21	30	1

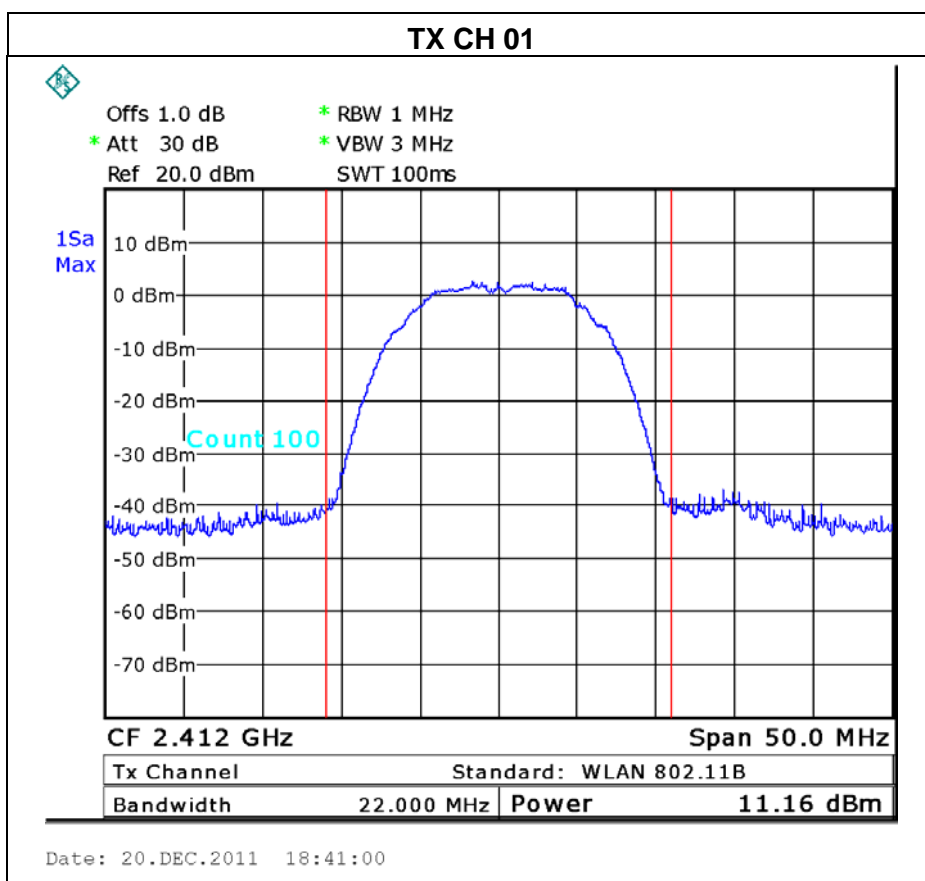

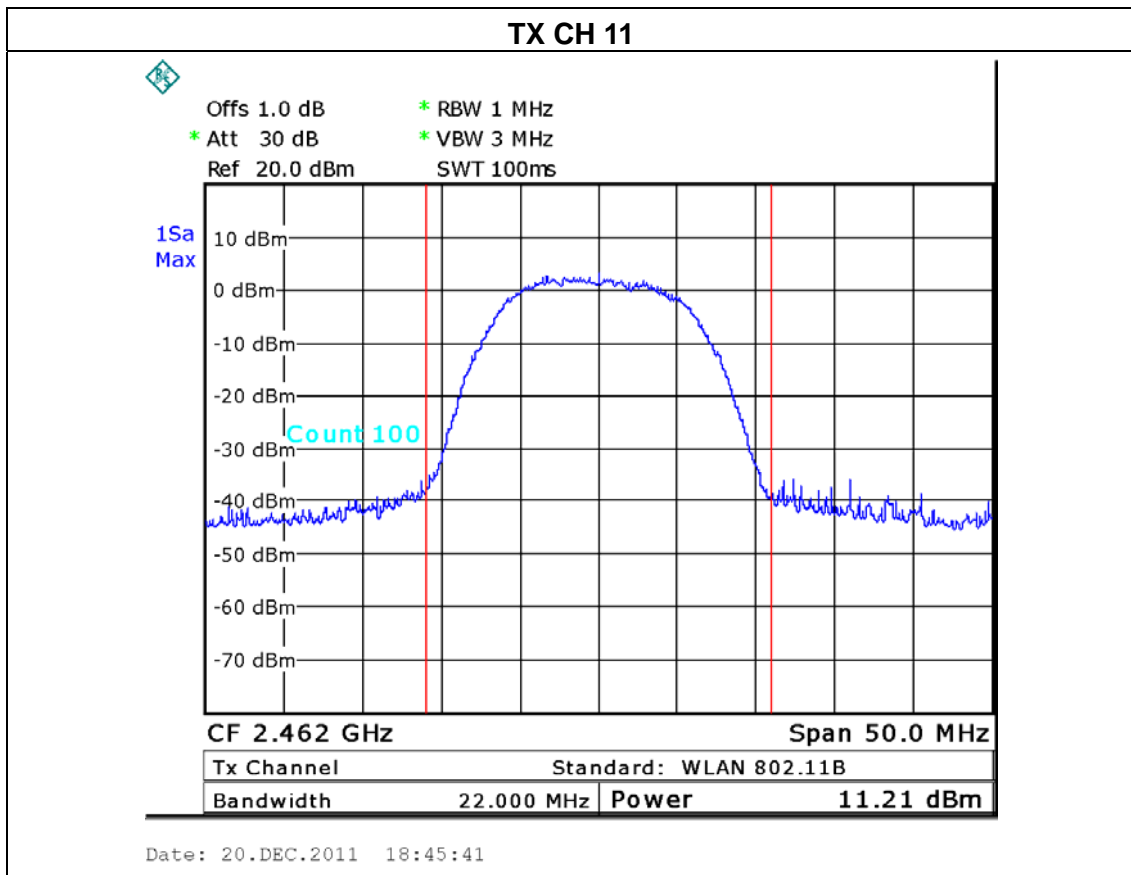
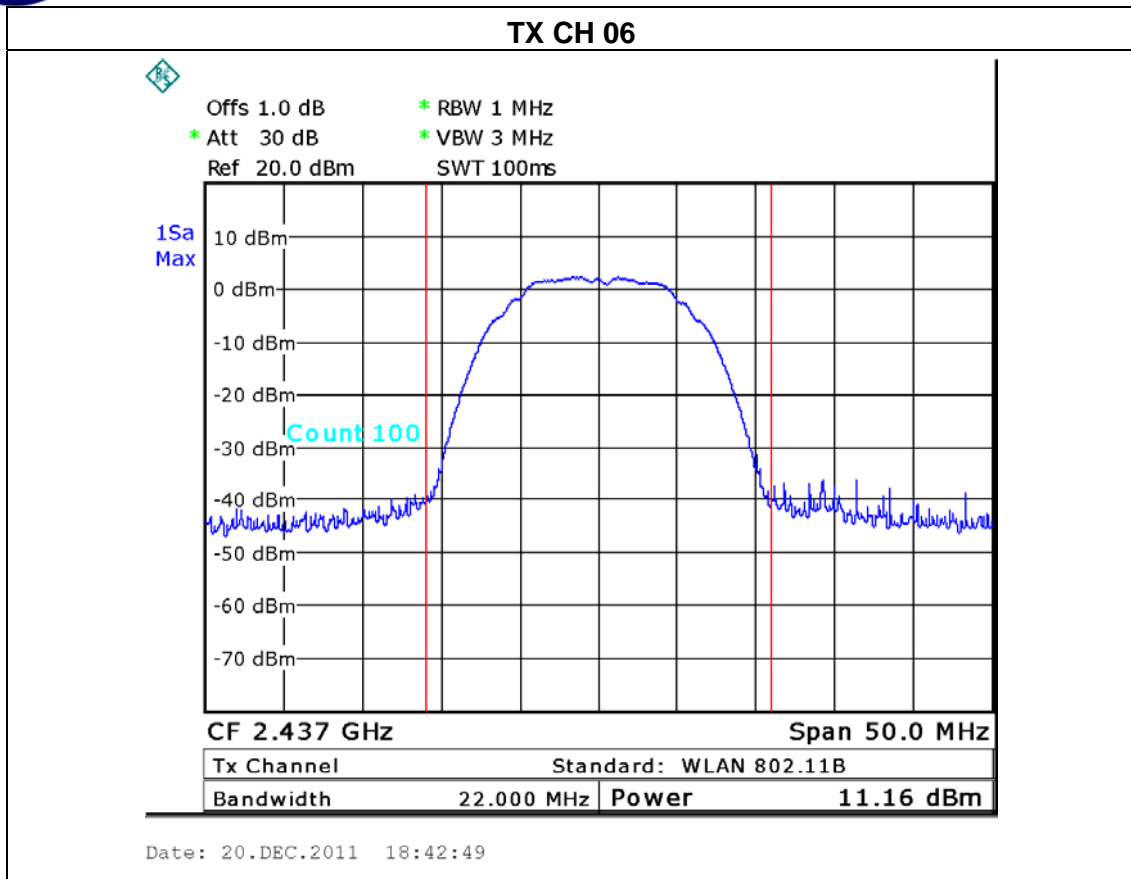



EUT :	150Mbps Wireless N USB Adapter	Model Name :	FWN-651ND; FWN-651N
Temperature :	24 °C	Relative Humidity :	60 %
Pressure :	1016 hPa	Test Voltage :	AC 120V/60Hz
Test Mode :	TX G MODE /CH01, CH06, CH11		

**Maximum Output Power**

Test Channel	Frequency (MHz)	Output Power (dBm)	LIMIT (dBm)	LIMIT (W)
CH01	2412 MHz	11.12	30	1
CH06	2437 MHz	11.23	30	1
CH11	2462 MHz	10.92	30	1

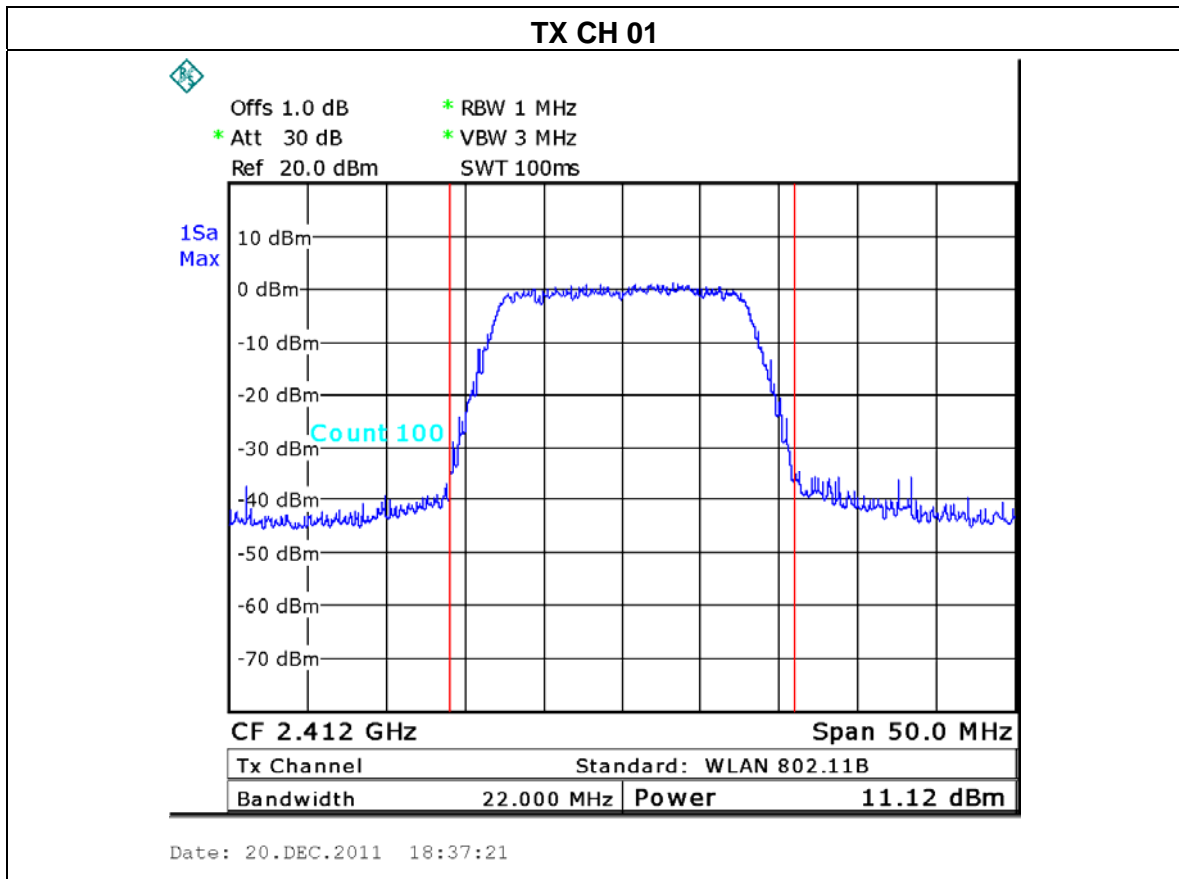



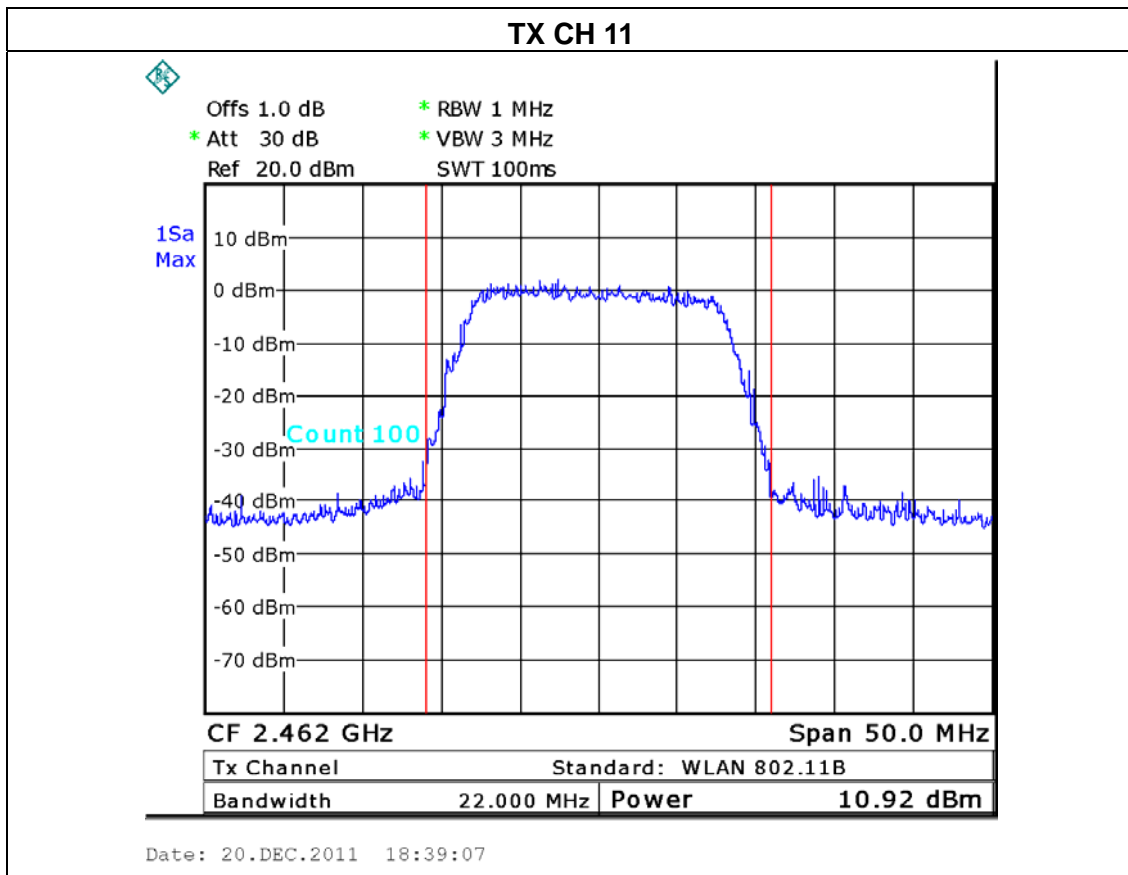
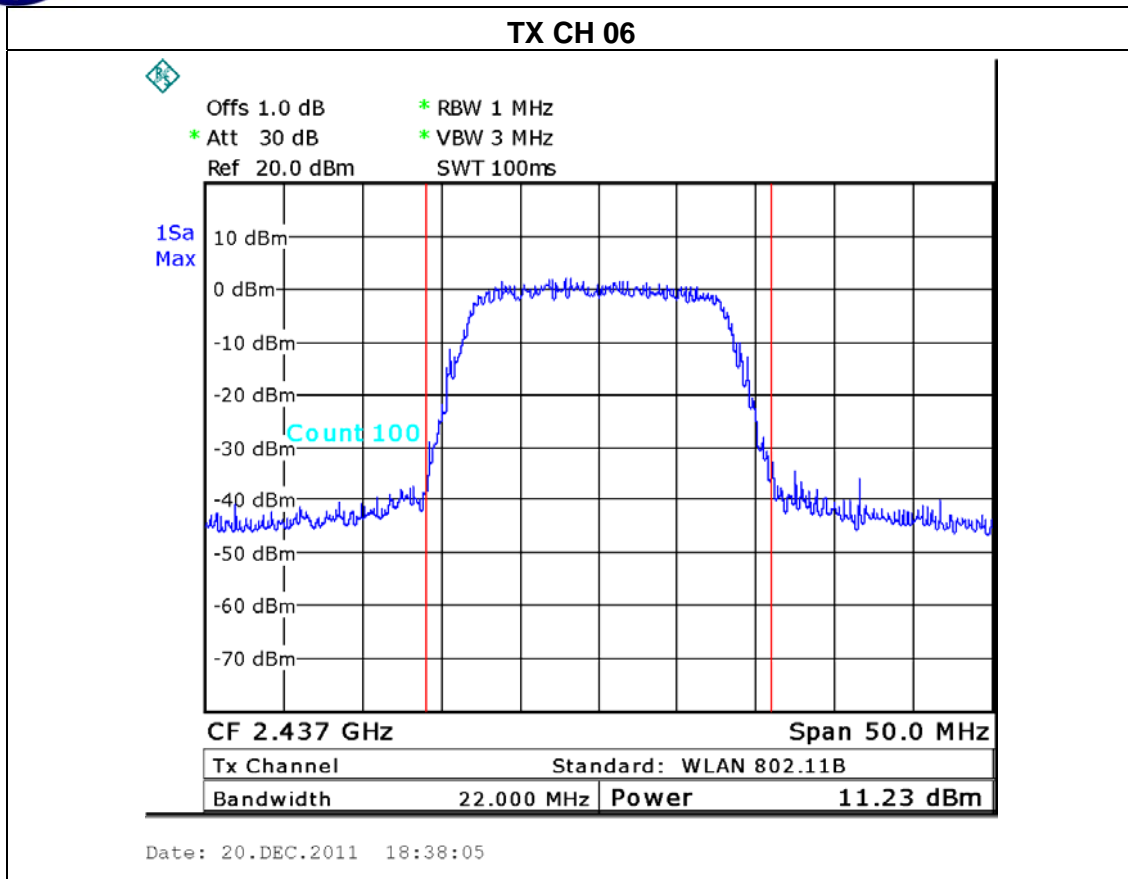



EUT :	150Mbps Wireless N USB Adapter	Model Name :	FWN-651ND; FWN-651N
Temperature :	24 °C	Relative Humidity :	60 %
Pressure :	1016 hPa	Test Voltage :	AC 120V/60Hz
Test Mode :	TX N-20M MODE /CH01, CH06, CH11		

**Maximum Output Power**

Test Channel	Frequency (MHz)	Output Power (dBm)	LIMIT (dBm)	LIMIT (W)
CH01	2412 MHz	11.22	30	1
CH06	2437 MHz	11.15	30	1
CH11	2462 MHz	11.11	30	1

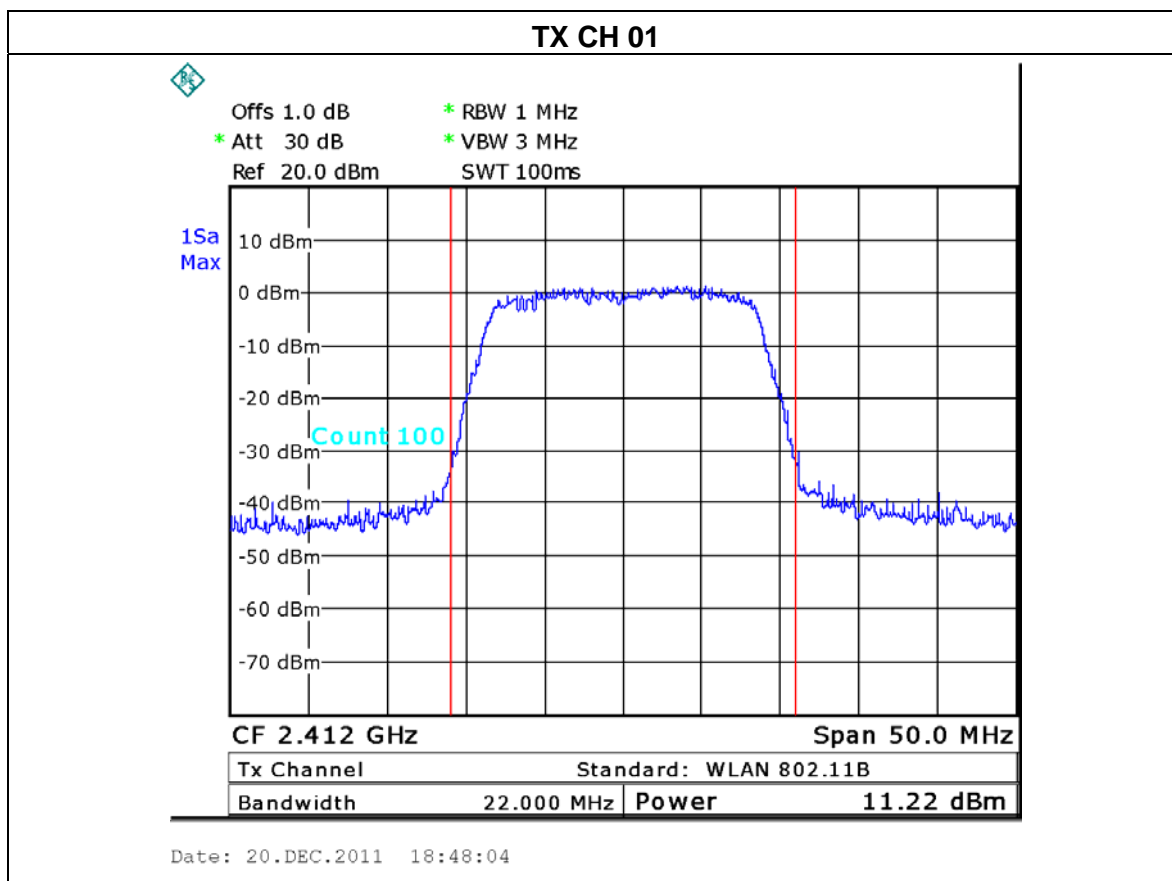

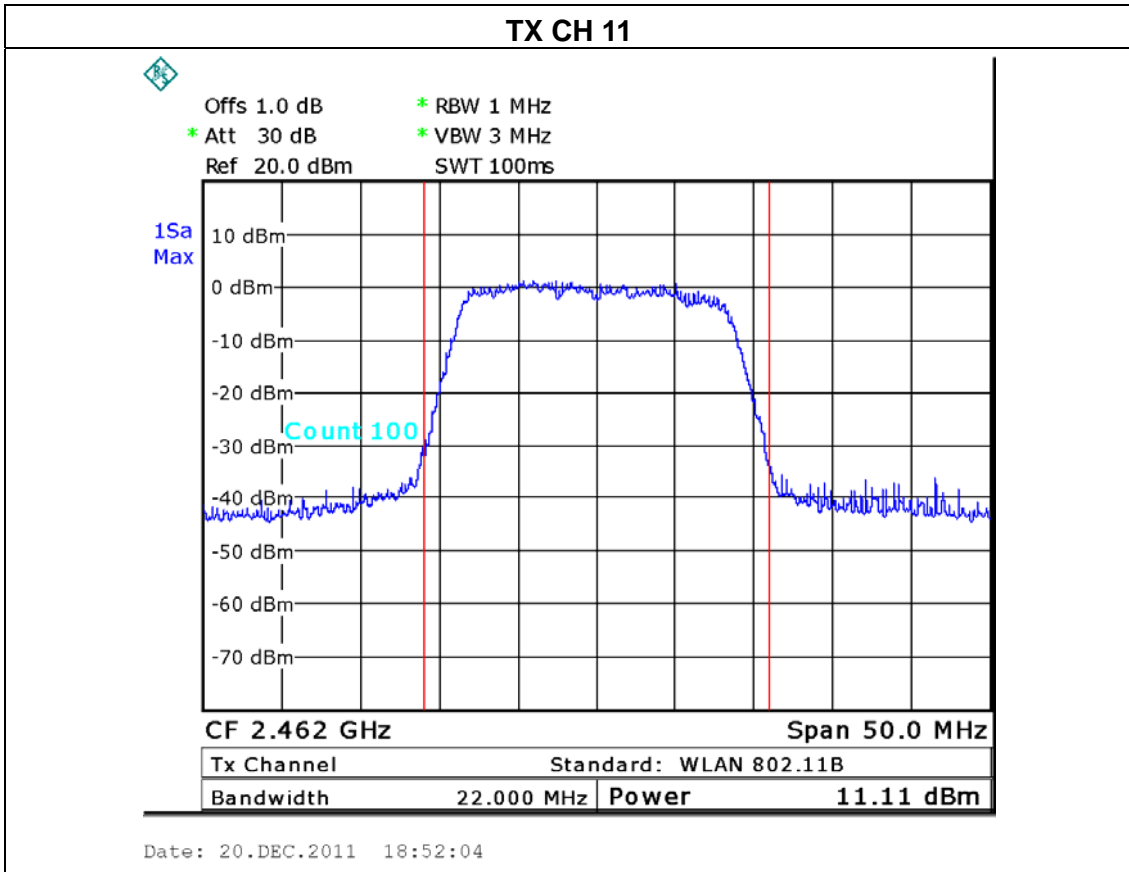
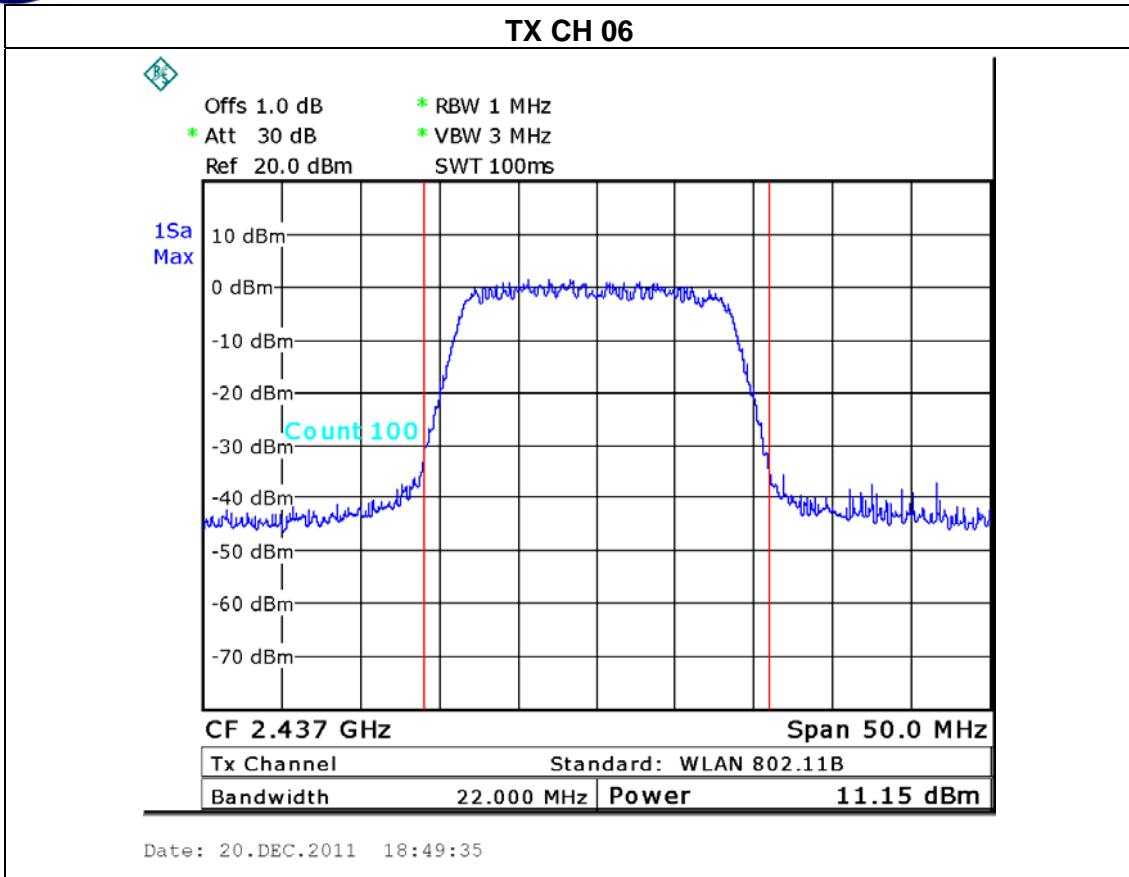



EUT :	150Mbps Wireless N USB Adapter	Model Name :	FWN-651ND; FWN-651N
Temperature :	24 °C	Relative Humidity :	60 %
Pressure :	1016 hPa	Test Voltage :	AC 120V/60Hz
Test Mode :	TX N-40M MODE /CH03, CH06, CH09		

**Maximum Output Power**

Test Channel	Frequency (MHz)	Output Power (dBm)	LIMIT (dBm)	LIMIT (W)
CH03	2422 MHz	11.08	30	1
CH06	2437 MHz	10.89	30	1
CH09	2452 MHz	11.23	30	1

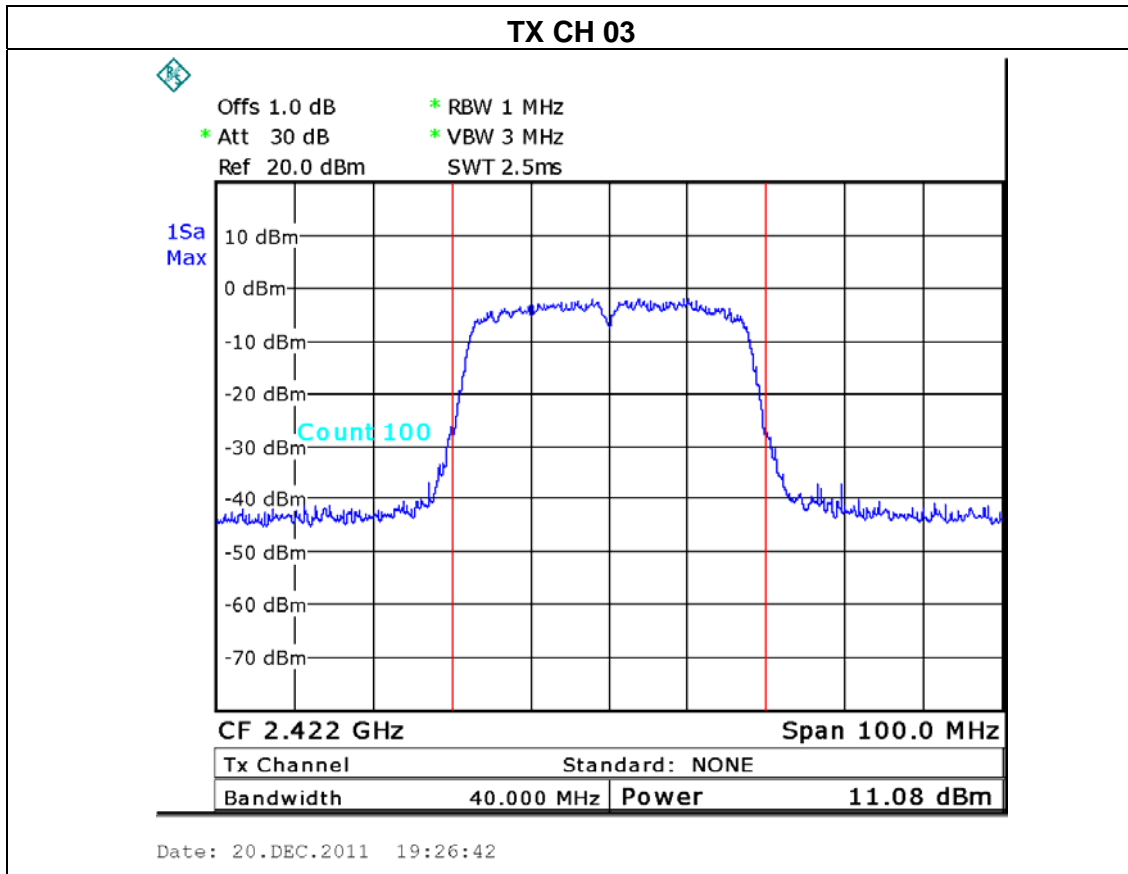

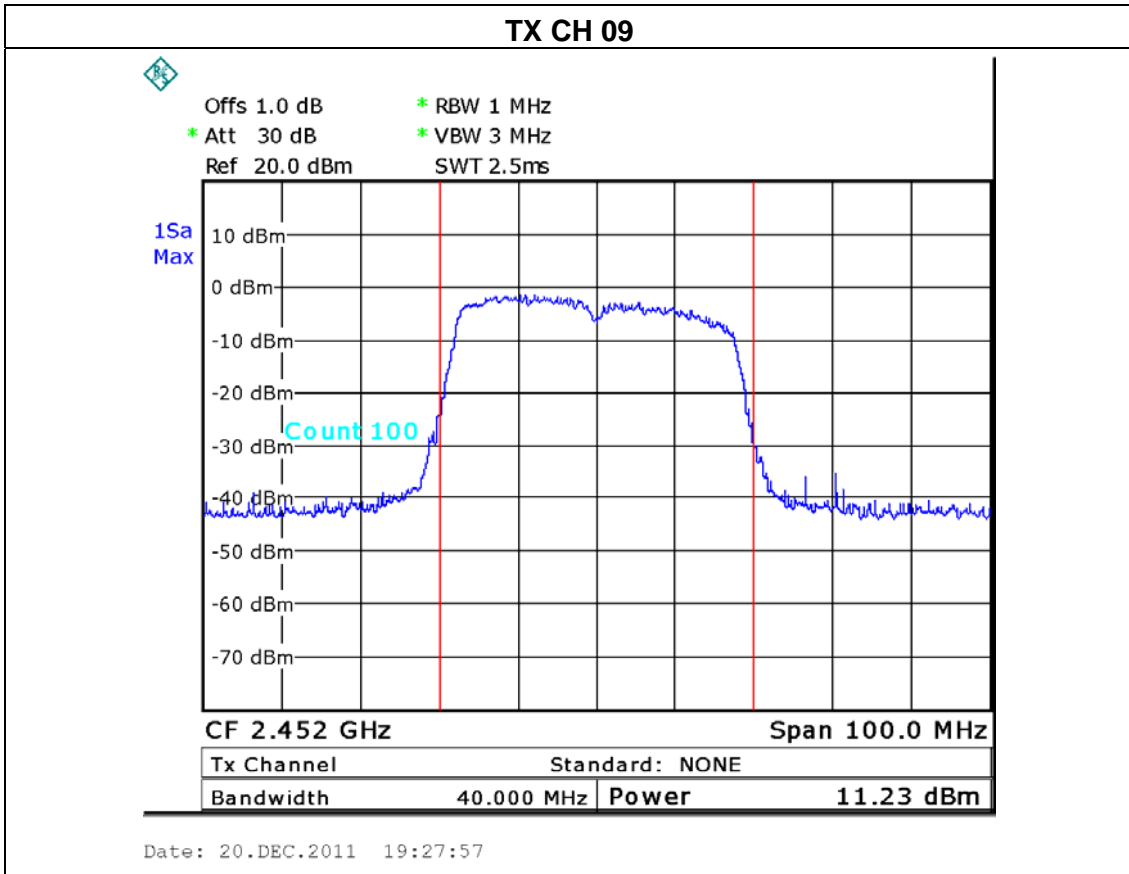
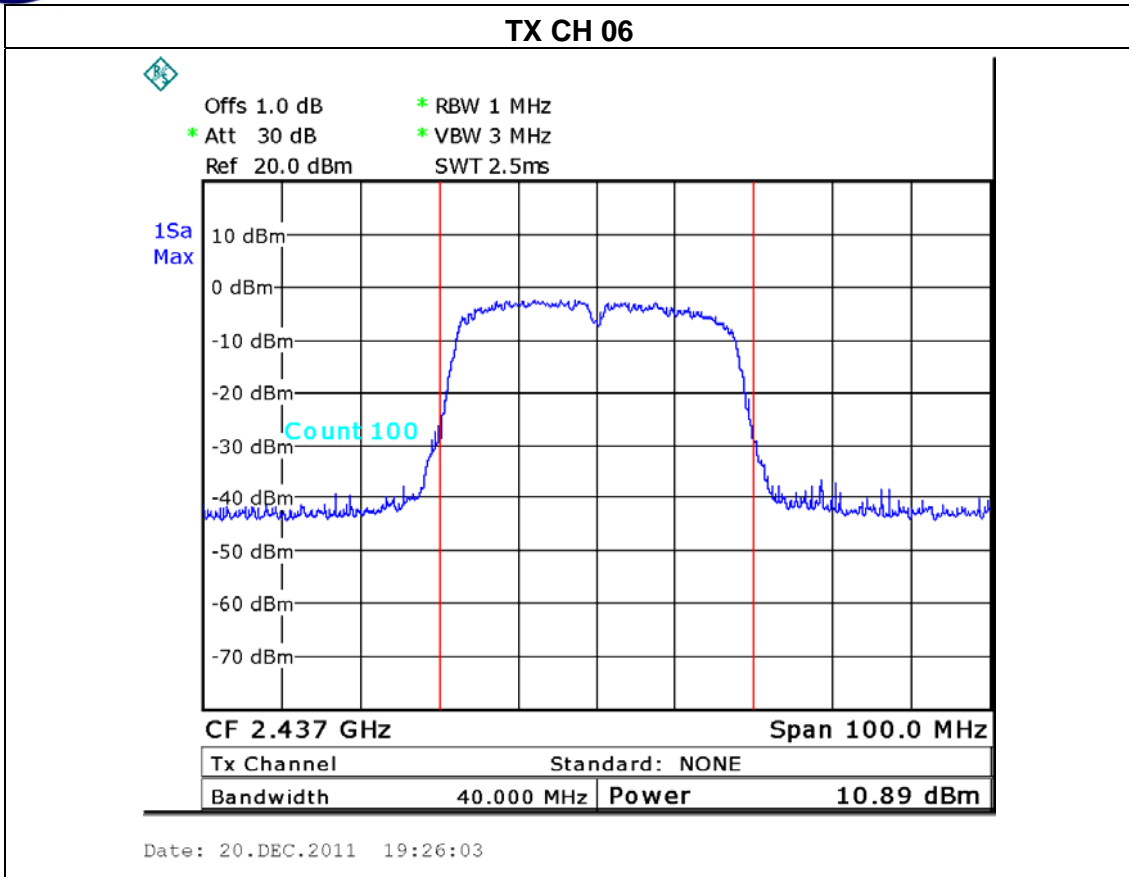



**7. ANTENNA CONDUCTED SPURIOUS EMISSION**

**7.1 Applied procedures / limit**

30dBc in any 100 kHz bandwidth outside the operating frequency band. In case the emission fall within the restricted band specified on 15.205(a), then the 15.209(a) limit in the table below has to be followed.

Frequencies (MHz)	Field Strength (micorvolts/meter)	Measurement Distance (meters)
0.009~0.490	2400/F(KHz)	300
0.490~1.705	24000/F(KHz)	30
1.705~30.0	30	30
30~88	100	3
88~216	150	3
216~960	200	3
Above 960	500	3

**7.1.1 MEASUREMENT INSTRUMENTS LIST**

Item	Kind of Equipment	Manufacturer	Type No.	Serial No.	Calibrated until
1	Spectrum Analyzer	R&S	FSP 40	100185	Nov.25.2012

Remark: " N/A" denotes No Model Name. , Serial No. or No Calibration specified.

**7.1.2 TEST PROCEDURE**

- a. The EUT was directly connected to the spectrum analyzer and antenna output port as show in the block diagram below,
- b. Spectrum Setting : RBW= 100KHz, VBW=100KHz, Sweep time = 10 ms.

**7.1.3 DEVIATION FROM STANDARD**

No deviation.

**7.1.4 TEST SETUP**

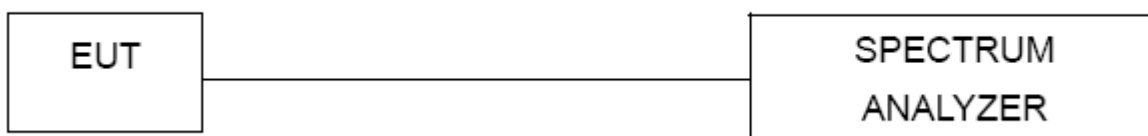

**7.1.5 EUT OPERATION CONDITIONS**

The EUT tested system was configured as the statements of 4.1.6 Unless otherwise a special operating condition is specified in the follows during the testing.



**7.1.6 TEST RESULTS**

EUT :	150Mbps Wireless N USB Adapter	Model Name :	FWN-651ND; FWN-651N
Temperature :	24 °C	Relative Humidity :	60 %
Pressure :	1016 hPa	Test Voltage :	AC 120V/60Hz
Test Mode :	TX B MODE /CH01, CH06 , CH11		

Channel of Worst Data: CH01			
The max. radio frequency power in any 100kHz bandwidth outside the frequency band		The max. radio frequency power in any 100 kHz bandwidth outside the frequency band.	
FREQUENCY(MHz)	POWER(dBm)	FREQUENCY(MHz)	POWER(dBm)
2350.20	-47.86	2497.00	-48.36
Result			
In any 100kHz bandwidth outside the frequency band, the radio frequency power is at least 30dB below that in the 100kHz bandwidth within the band that contains the highest level of the desired power.			

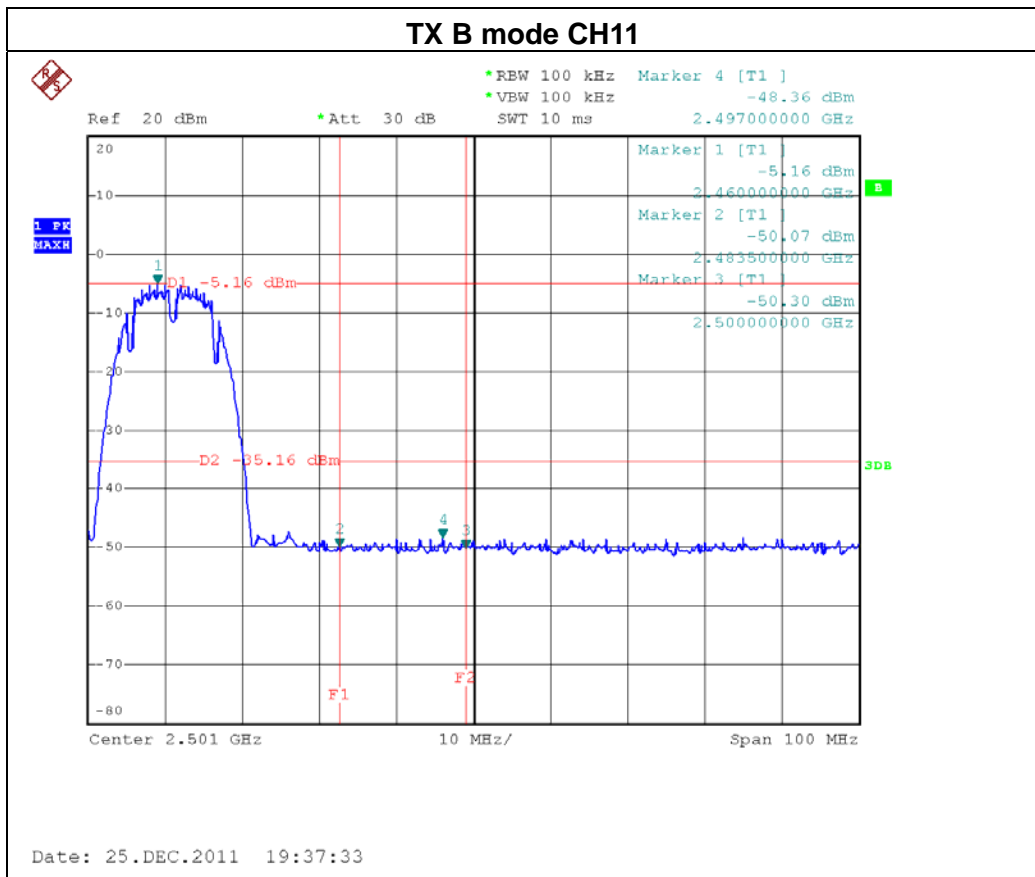
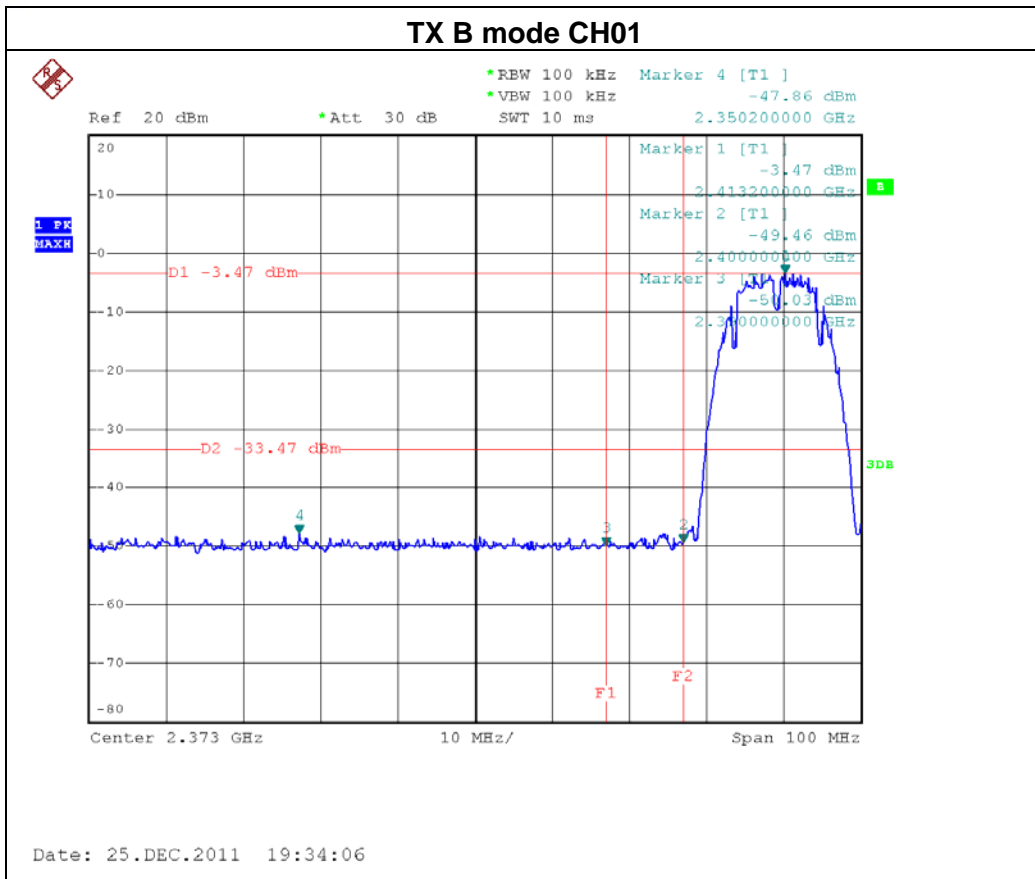



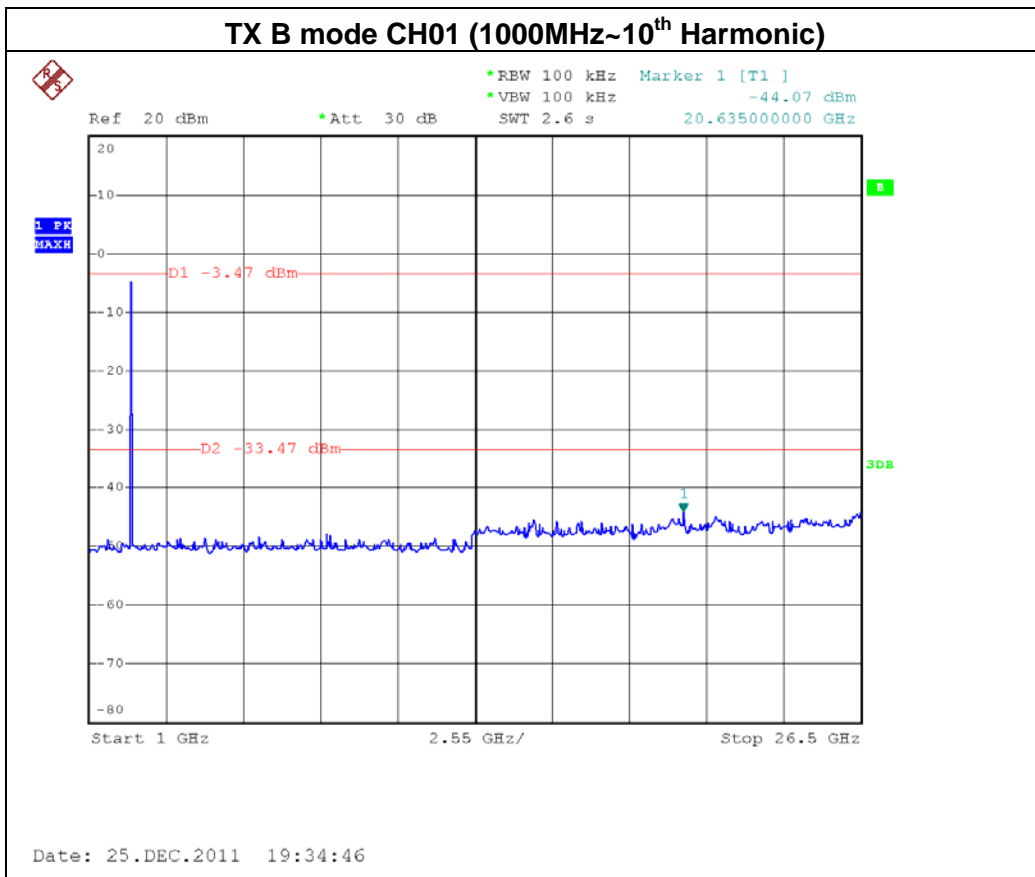
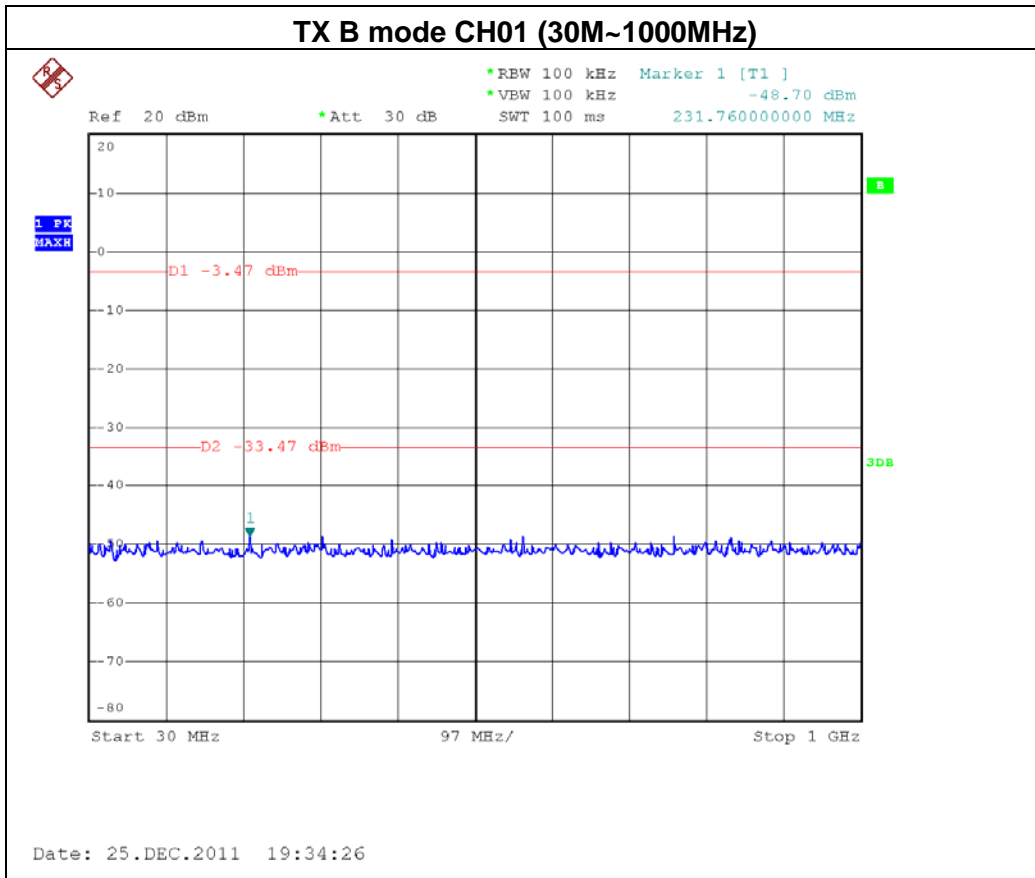

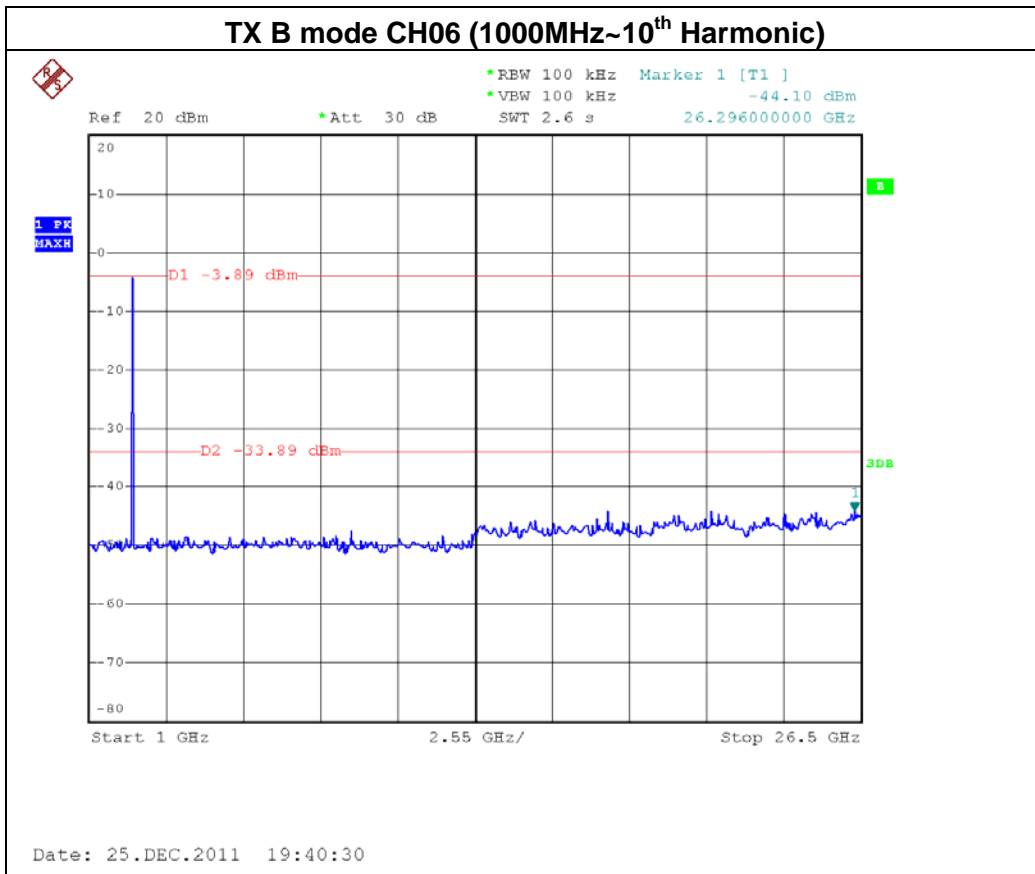
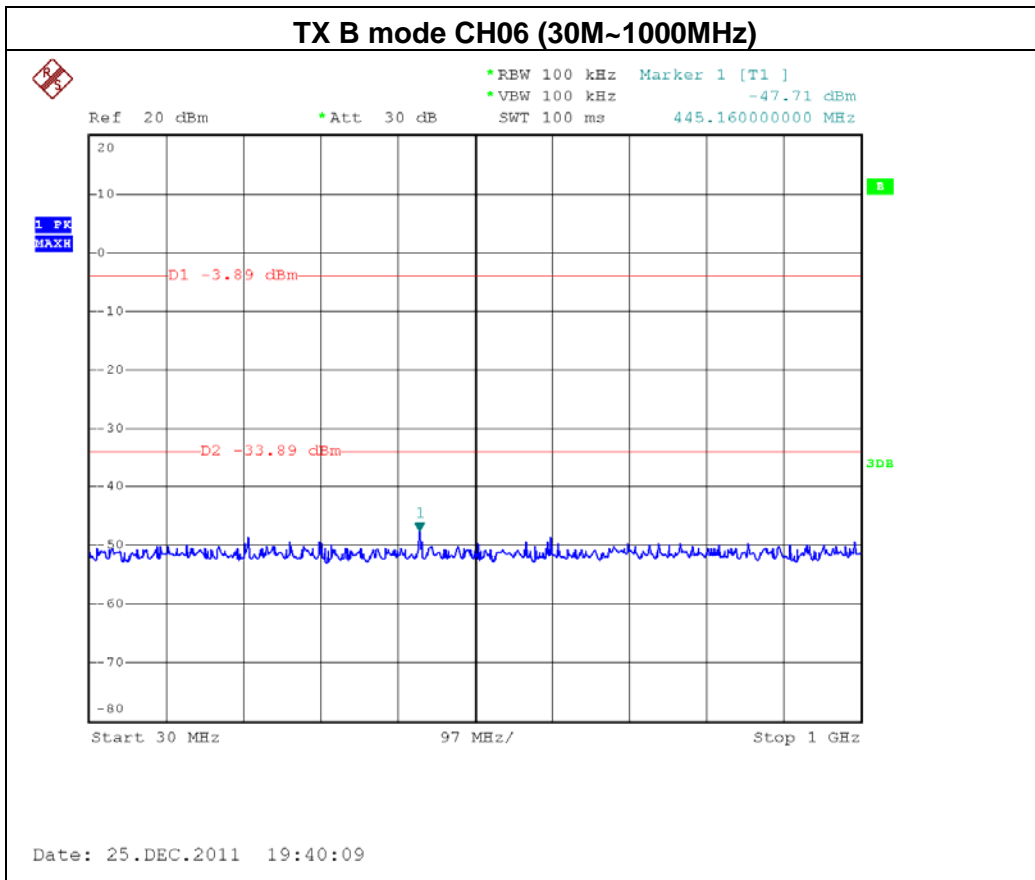

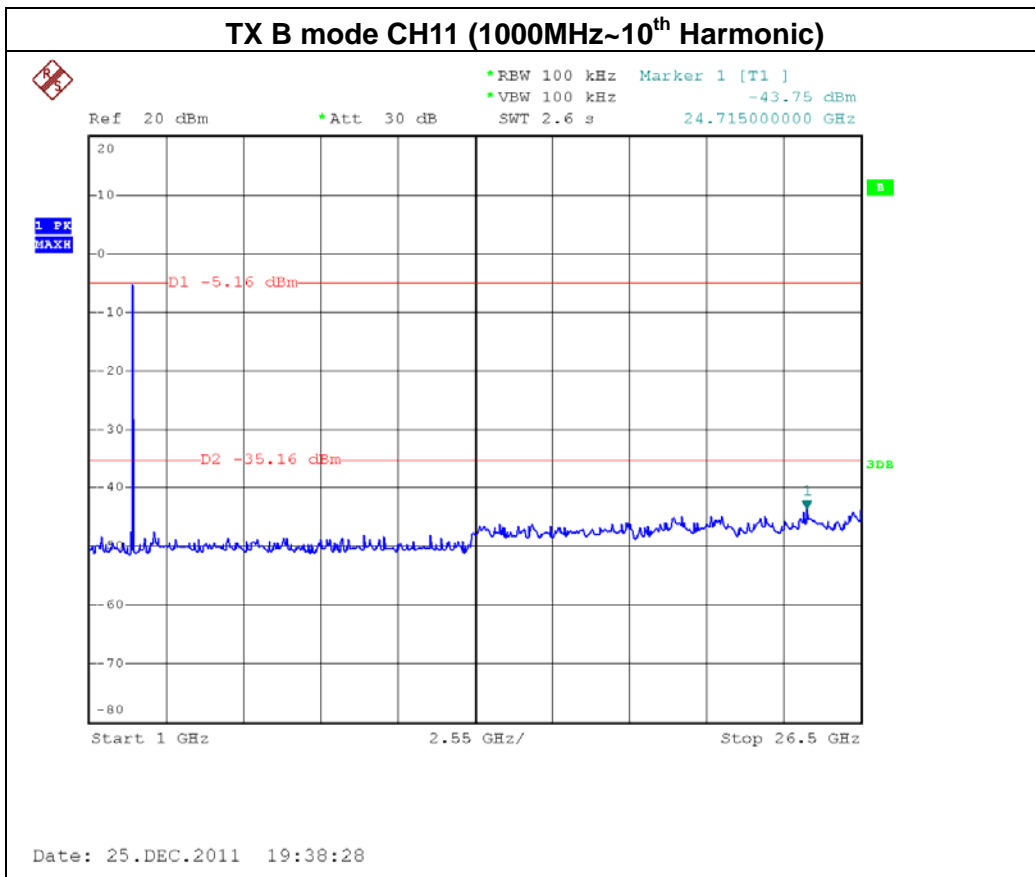
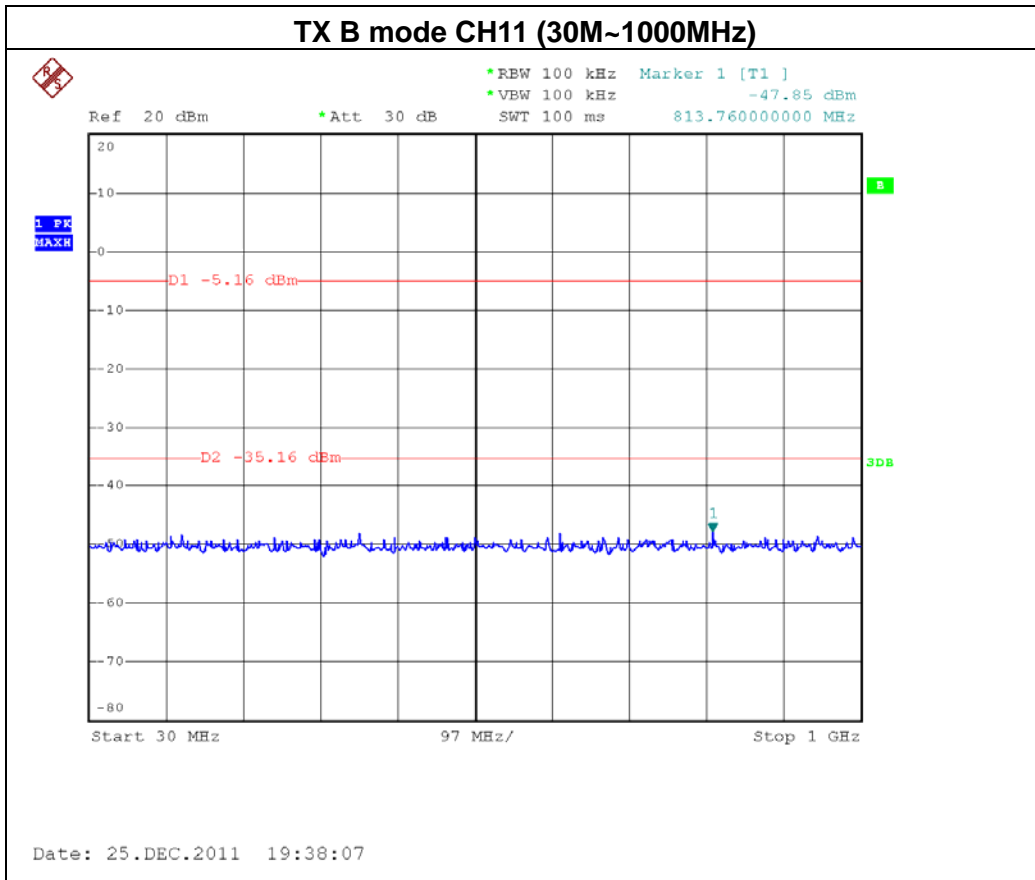



EUT :	150Mbps Wireless N USB Adapter	Model Name :	FWN-651ND; FWN-651N
Temperature :	24 °C	Relative Humidity :	60 %
Pressure :	1016 hPa	Test Voltage :	AC 120V/60Hz
Test Mode :	TX G MODE / CH01, CH06 , CH11		

Channel of Worst Data: CH01

The max. radio frequency power in any 100kHz bandwidth within the frequency band	The max. radio frequency power in any 100 kHz bandwidth outside the frequency band.
--	---

FREQUENCY(MHz)	POWER(dBm)	FREQUENCY(MHz)	POWER(dBm)
2400.00	-47.37	2484.90	-47.88

Result

In any 100kHz bandwidth outside the frequency band, the radio frequency power is at least 30dB below that in the 100kHz bandwidth within the band that contains the highest level of the desired power.

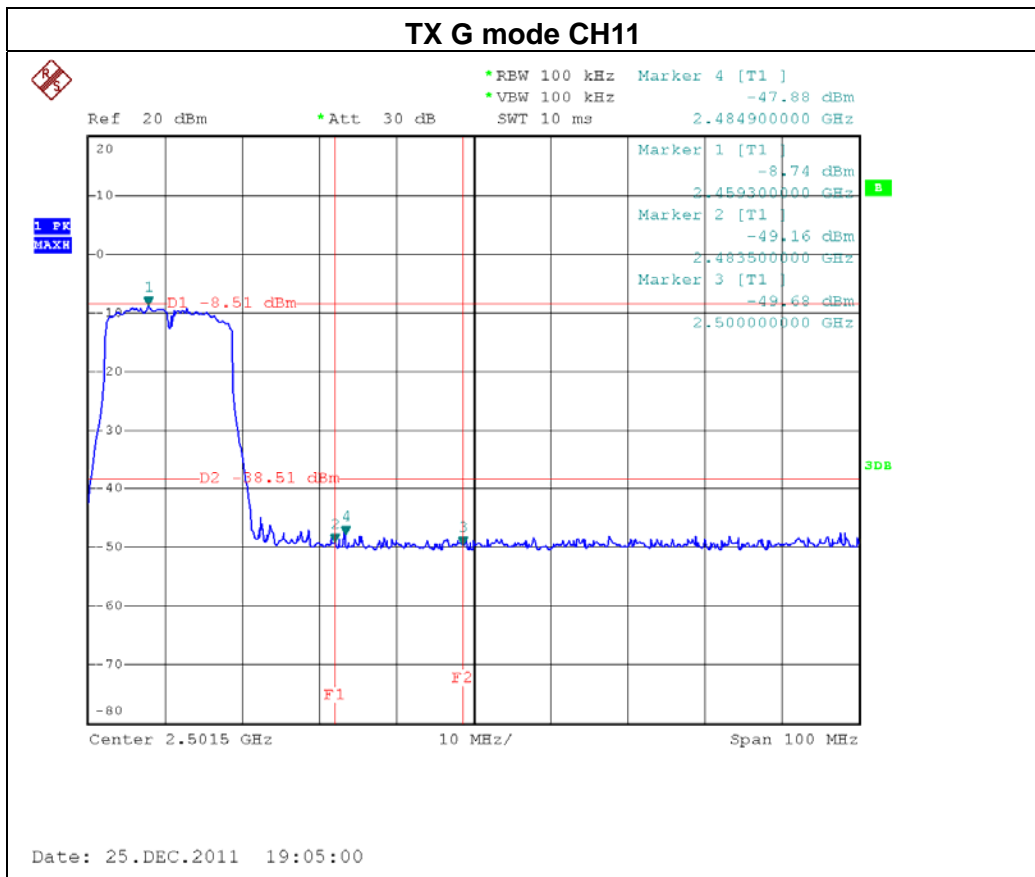
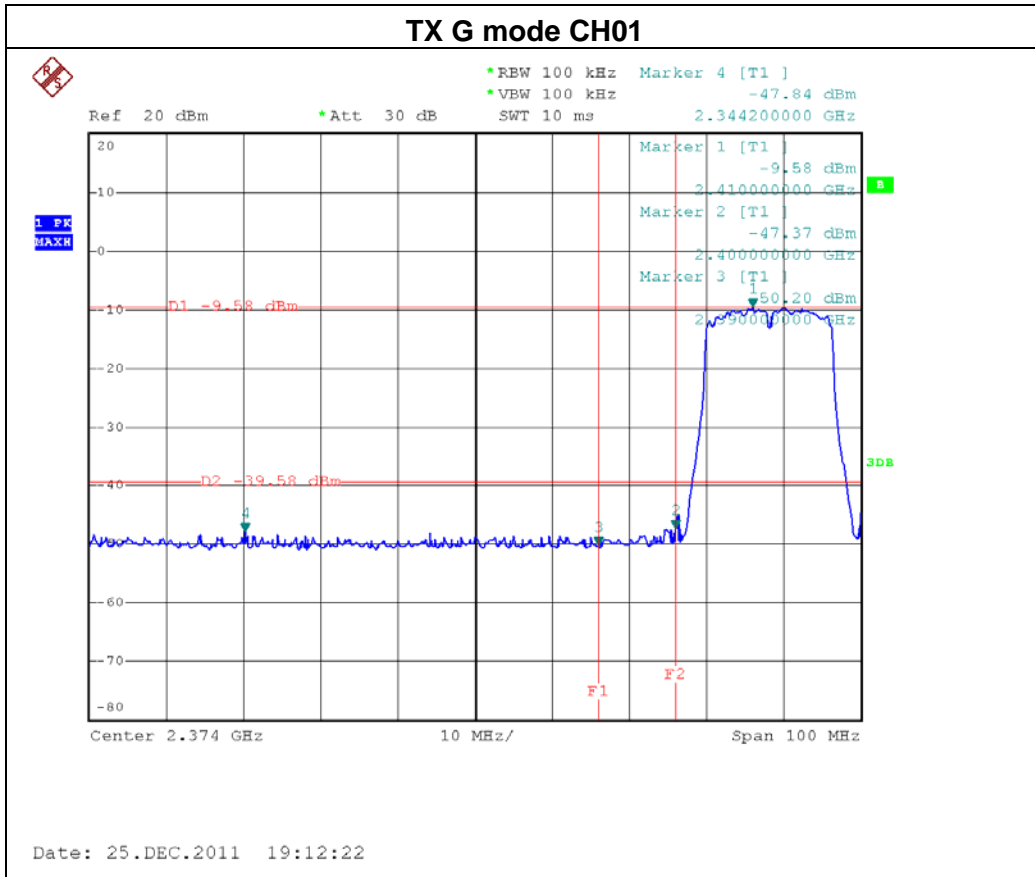

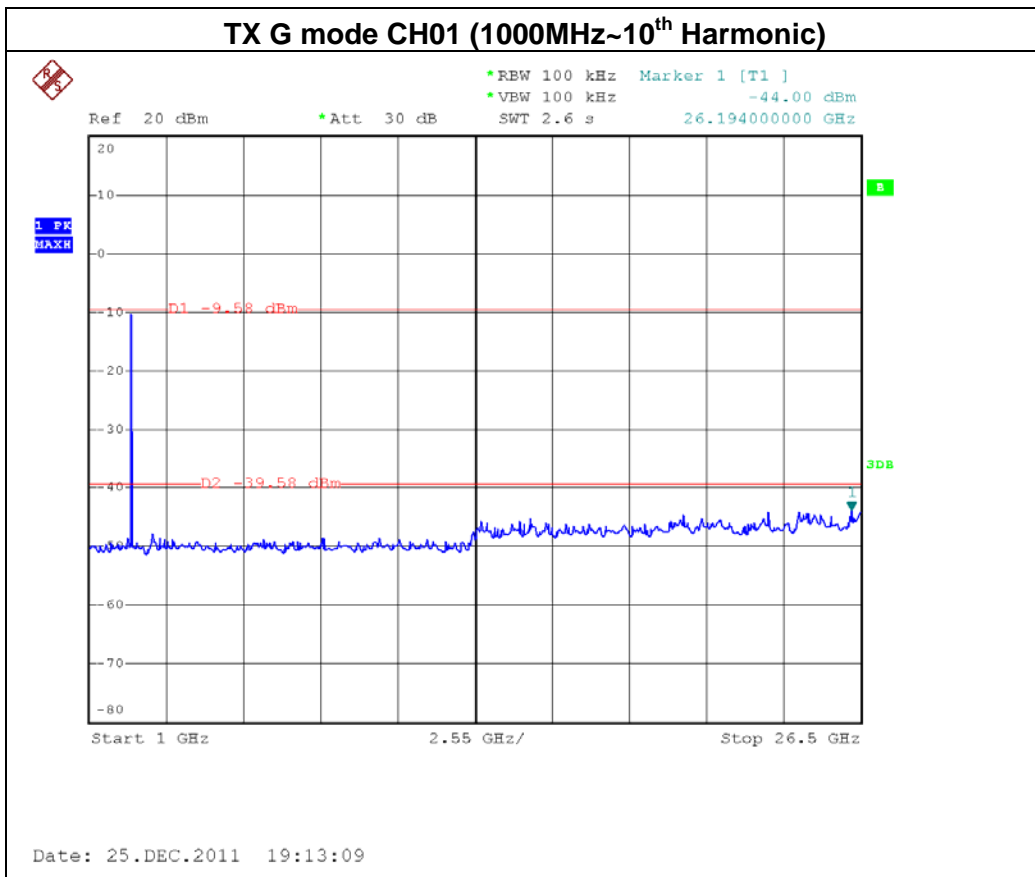
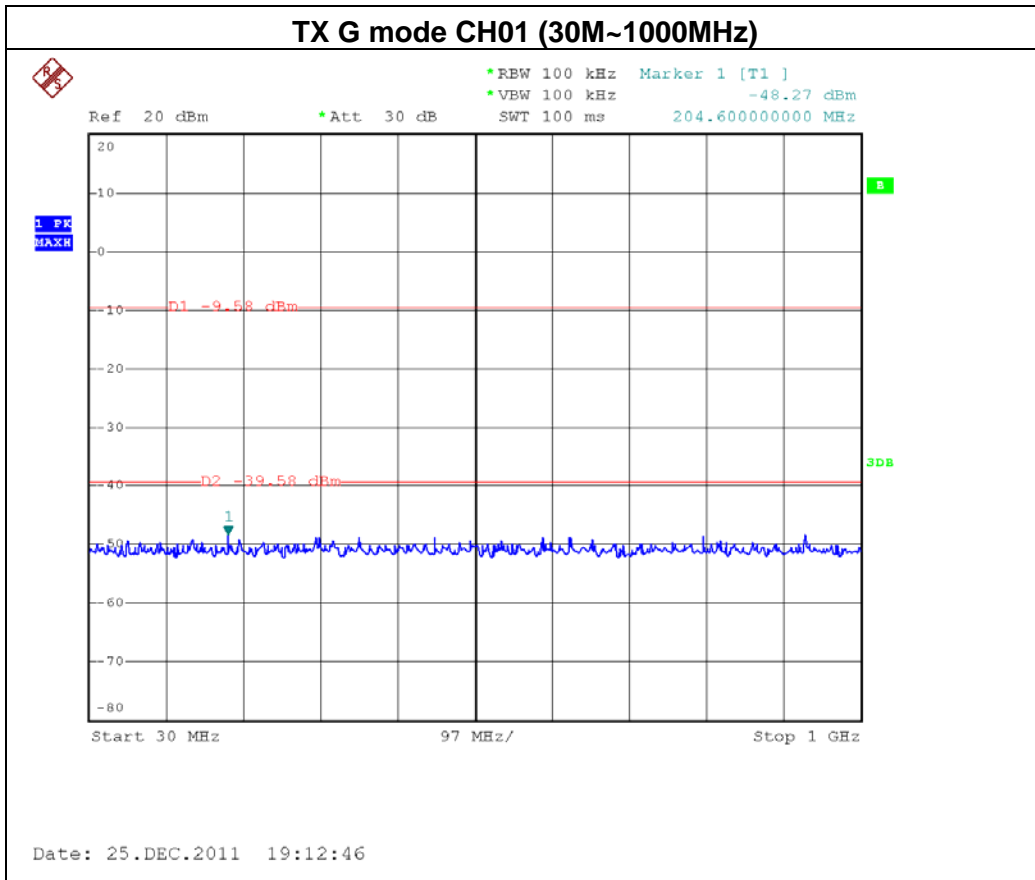

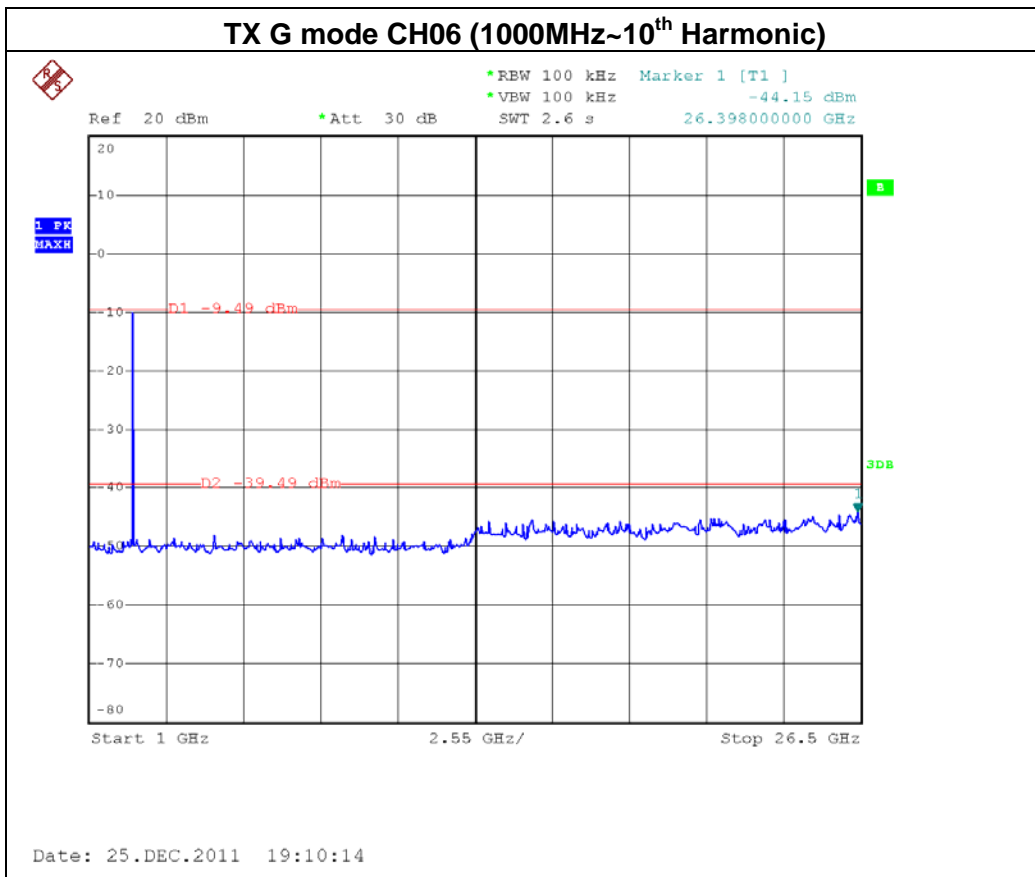
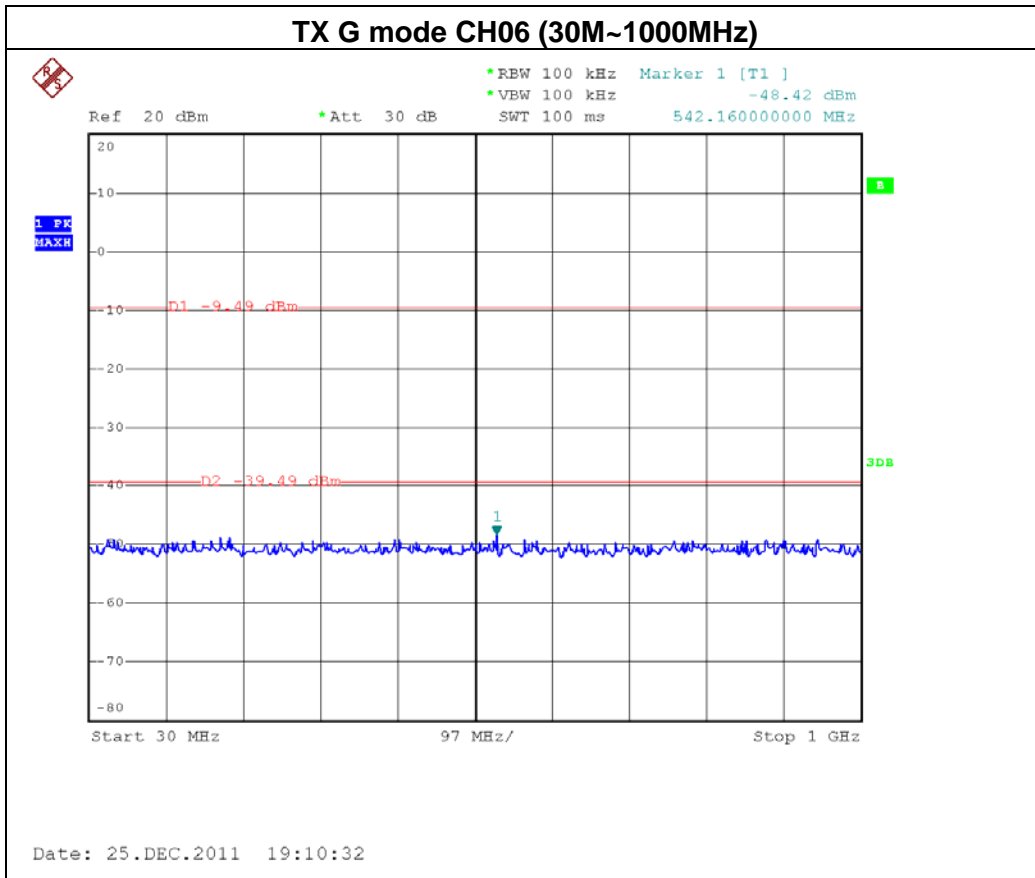

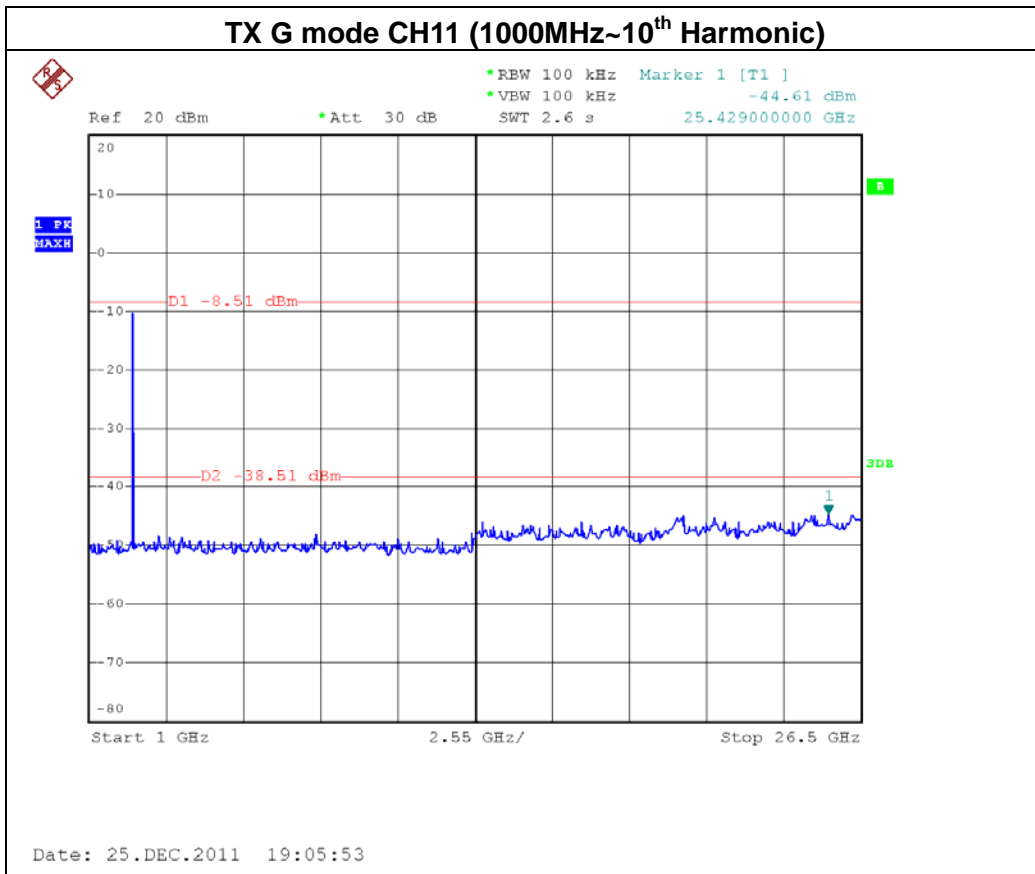
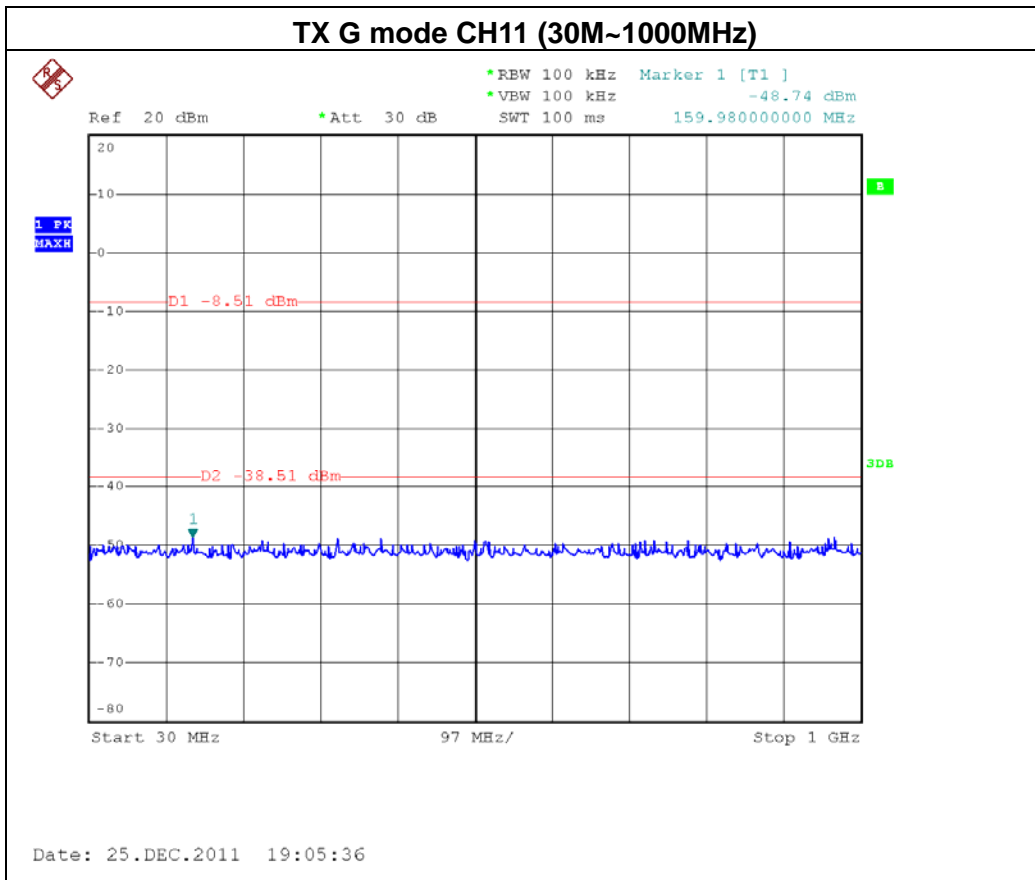





EUT :	150Mbps Wireless N USB Adapter	Model Name :	FWN-651ND; FWN-651N
Temperature :	24 °C	Relative Humidity :	60 %
Pressure :	1016 hPa	Test Voltage :	AC 120V/60Hz
Test Mode :	TX N-20M MODE / CH01, CH06 , CH11		

Channel of Worst Data: CH01			
The max. radio frequency power in any 100kHz bandwidth within the frequency band		The max. radio frequency power in any 100 kHz bandwidth outside the frequency band.	
FREQUENCY(MHz)	POWER(dBm)	FREQUENCY(MHz)	POWER(dBm)
2400.00	-47.43	2496.60	-47.75
Result			
In any 100kHz bandwidth outside the frequency band, the radio frequency power is at least 30dB below that in the 100kHz bandwidth within the band that contains the highest level of the desired power.			

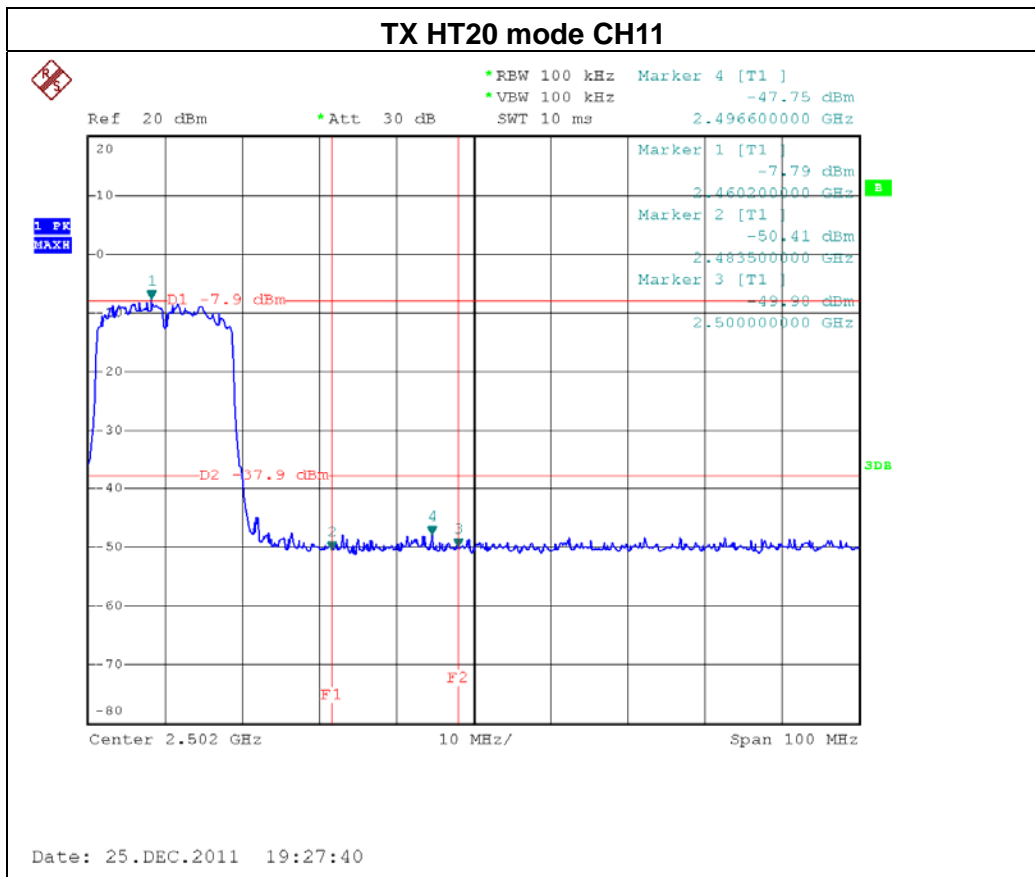
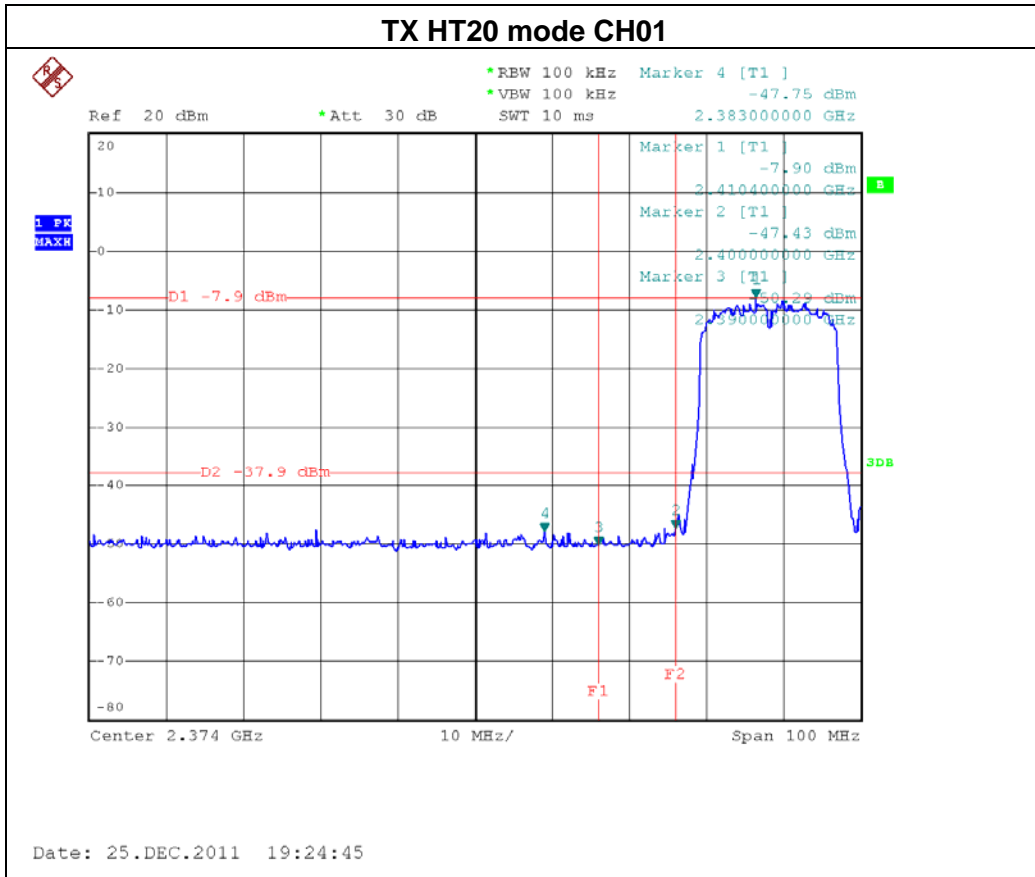

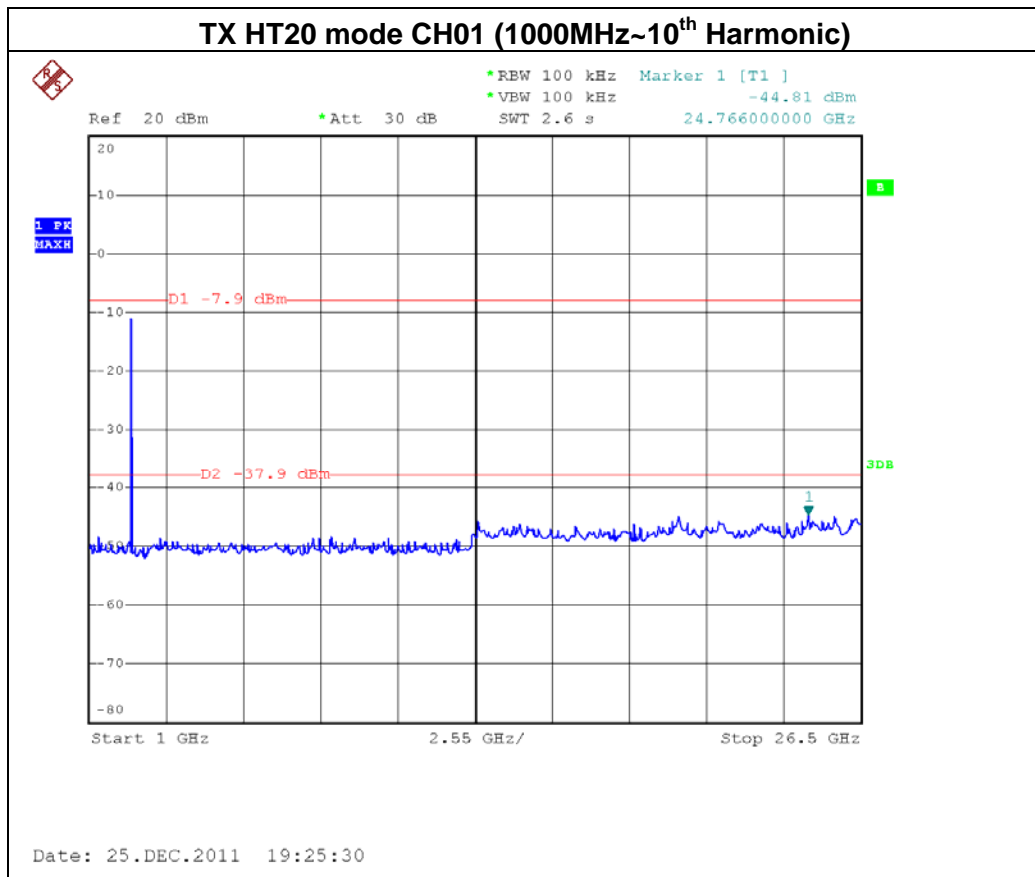
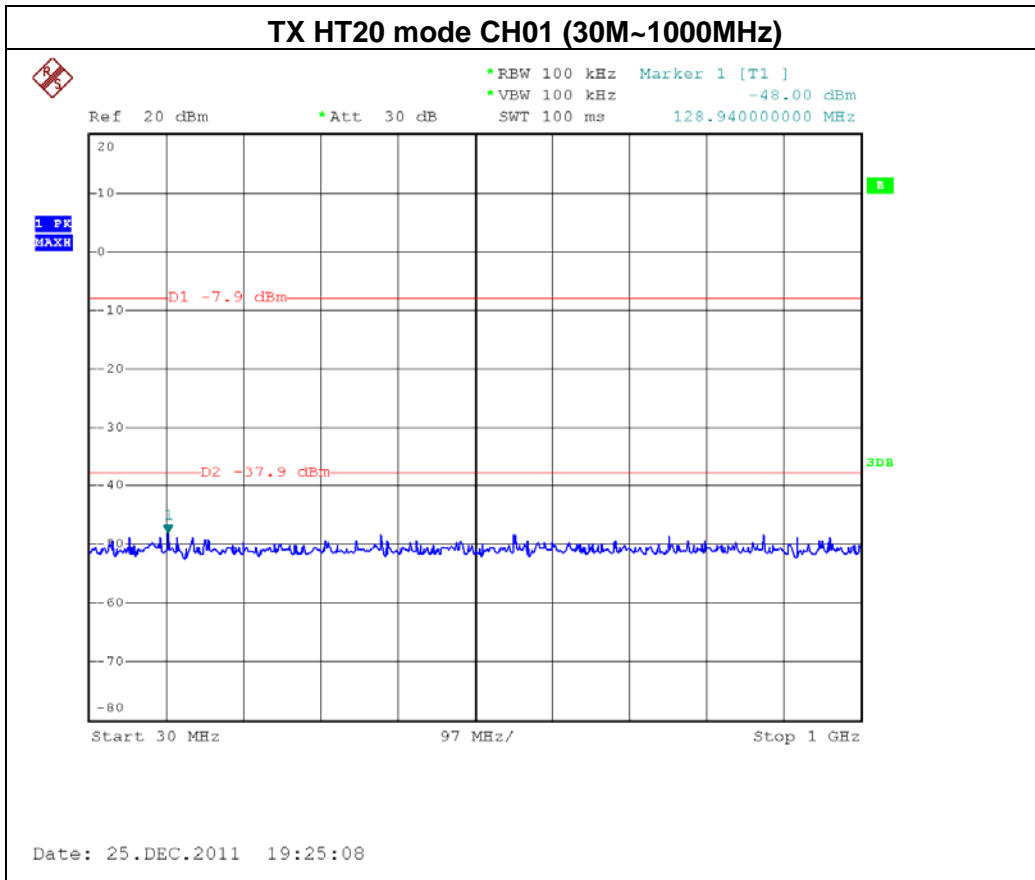

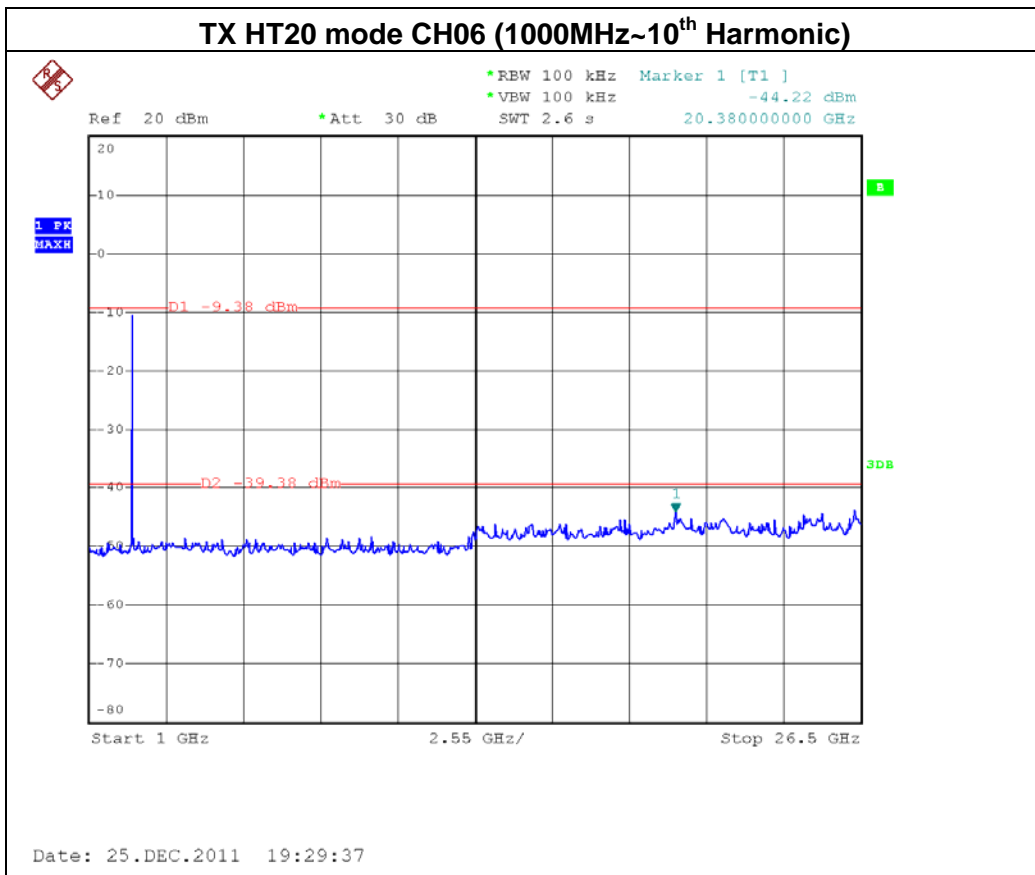
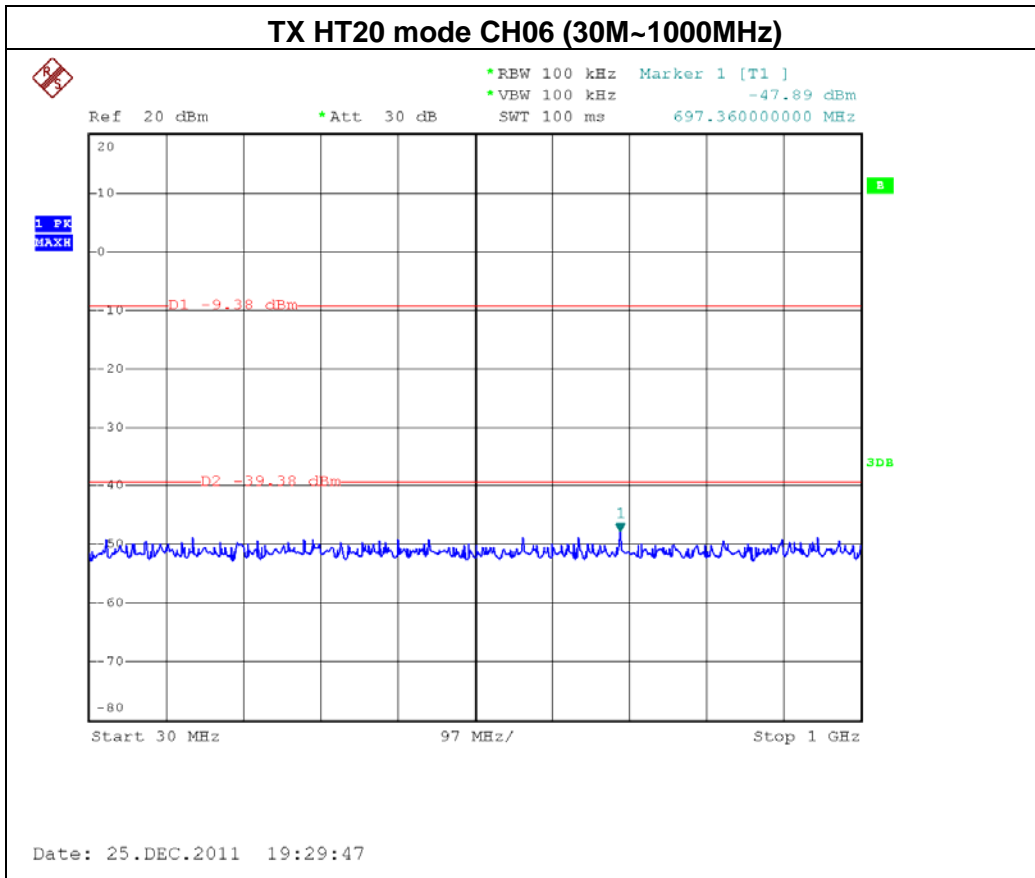

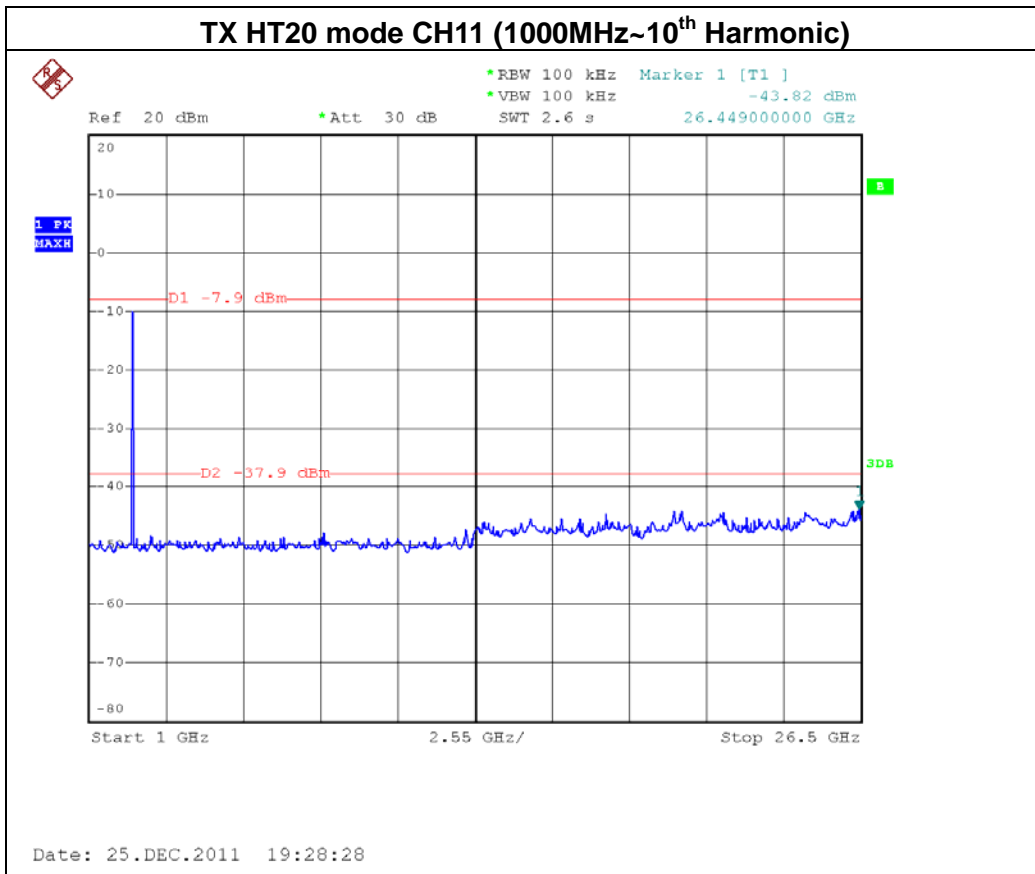
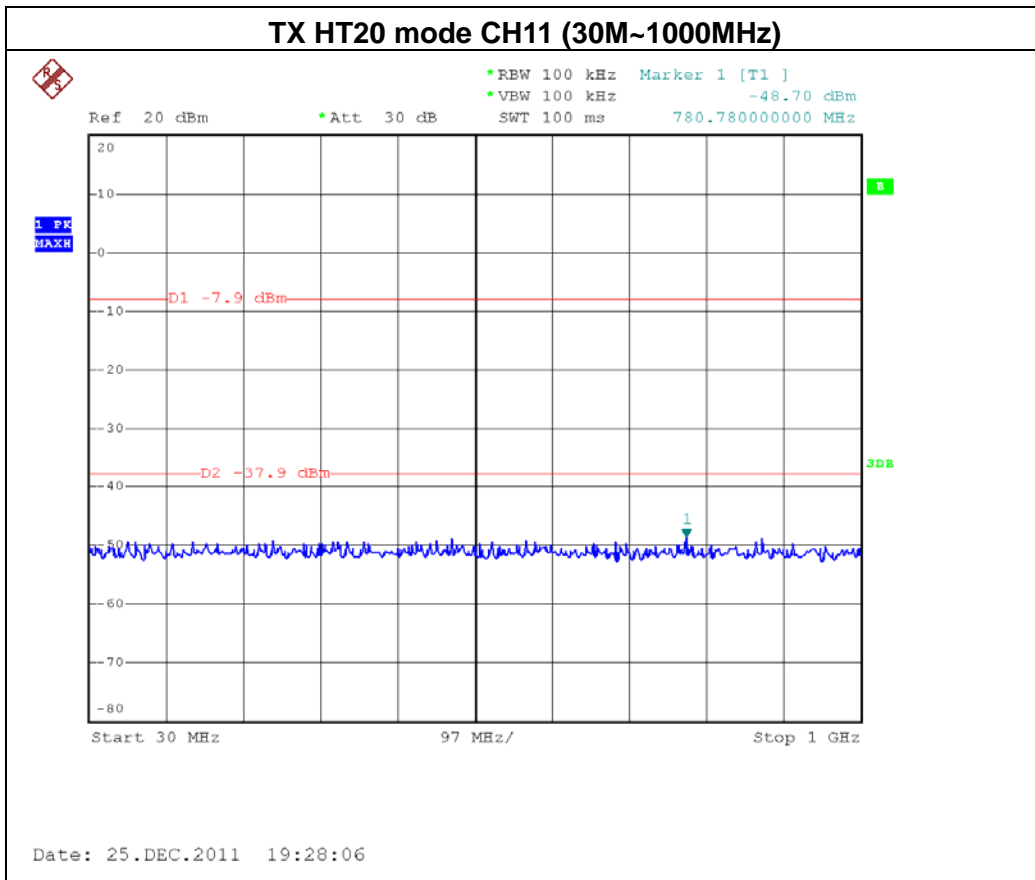



EUT :	150Mbps Wireless N USB Adapter	Model Name :	FWN-651ND; FWN-651N
Temperature :	24 °C	Relative Humidity :	60 %
Pressure :	1016 hPa	Test Voltage :	AC 120V/60Hz
Test Mode :	TX N-40M MODE /CH03, CH06, CH09		

Channel of Worst Data: CH03

The max. radio frequency power in any 100kHz bandwidth within the frequency band	The max. radio frequency power in any 100 kHz bandwidth outside the frequency band.
--	---

FREQUENCY(MHz)	POWER(dBm)	FREQUENCY(MHz)	POWER(dBm)
2400.00	-43.36	2491.60	-48.08

Result

In any 100kHz bandwidth outside the frequency band, the radio frequency power is at least 30dB below that in the 100kHz bandwidth within the band that contains the highest level of the desired power.

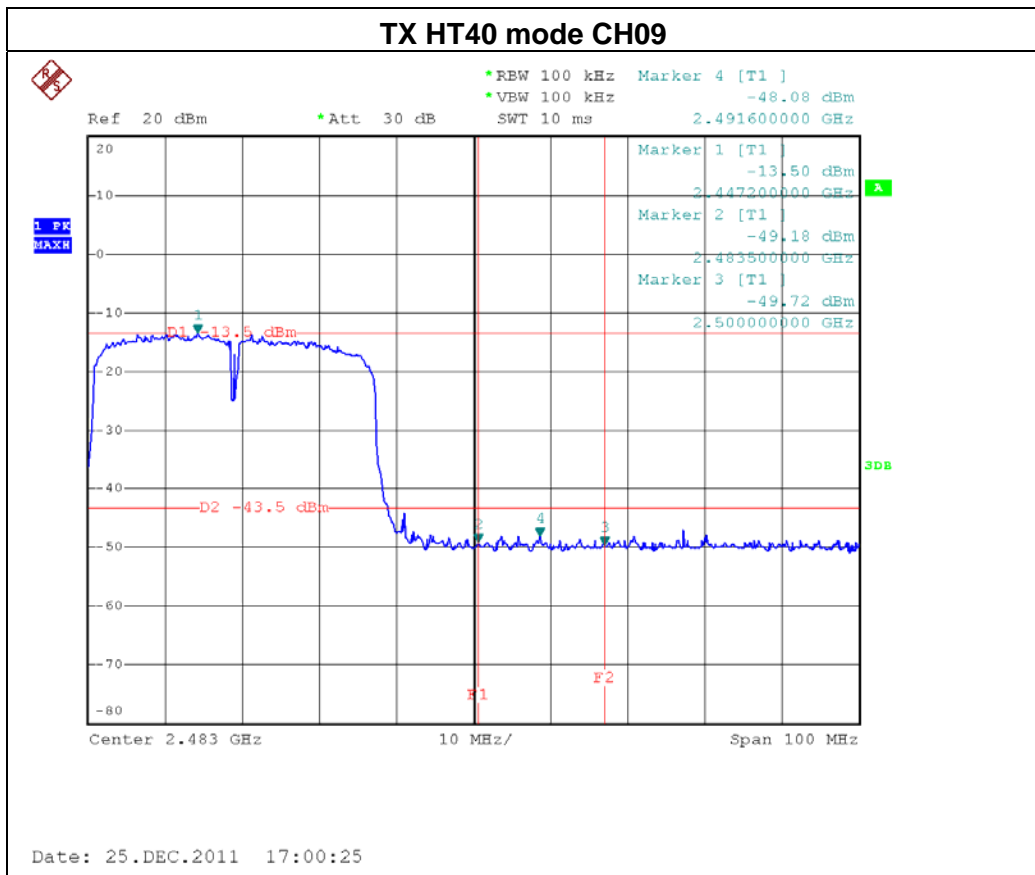
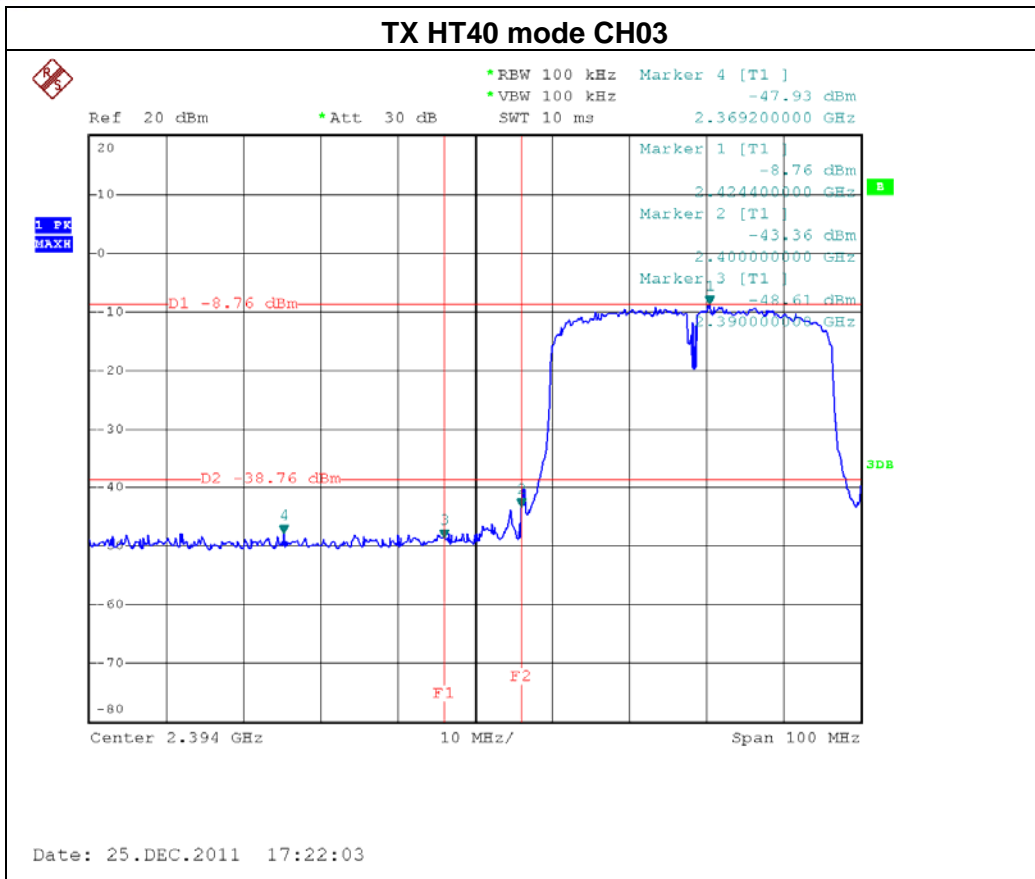

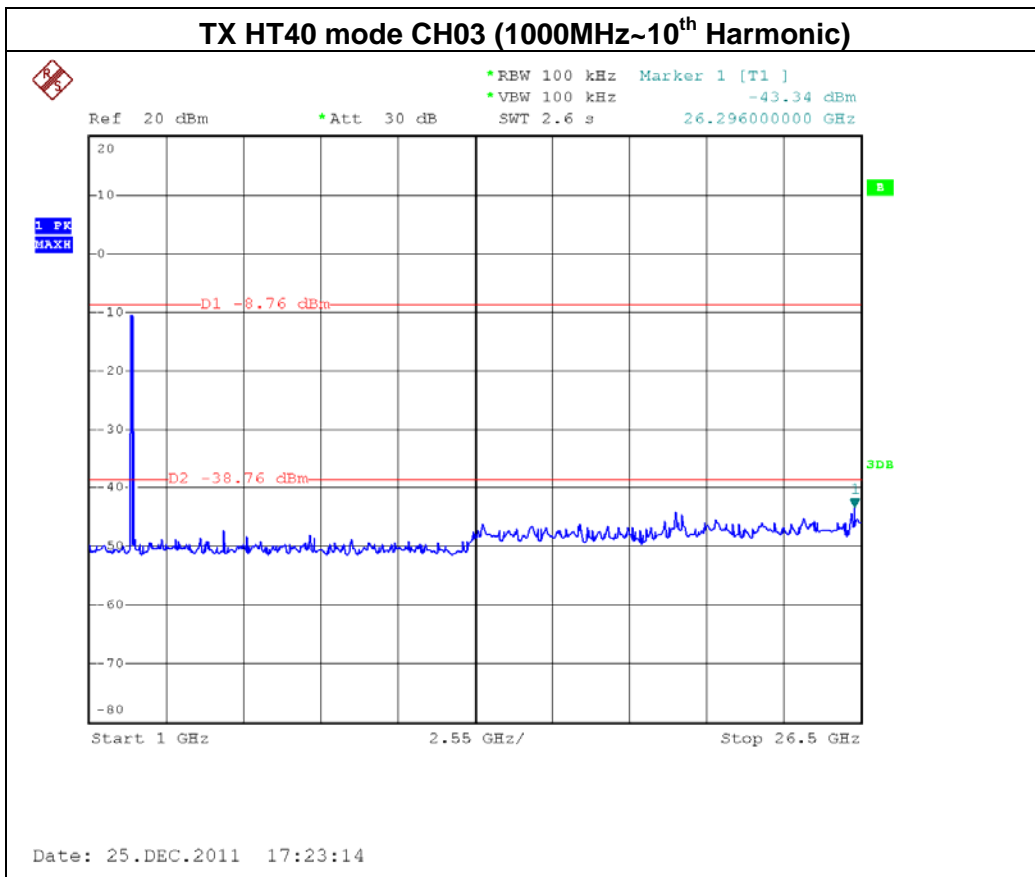
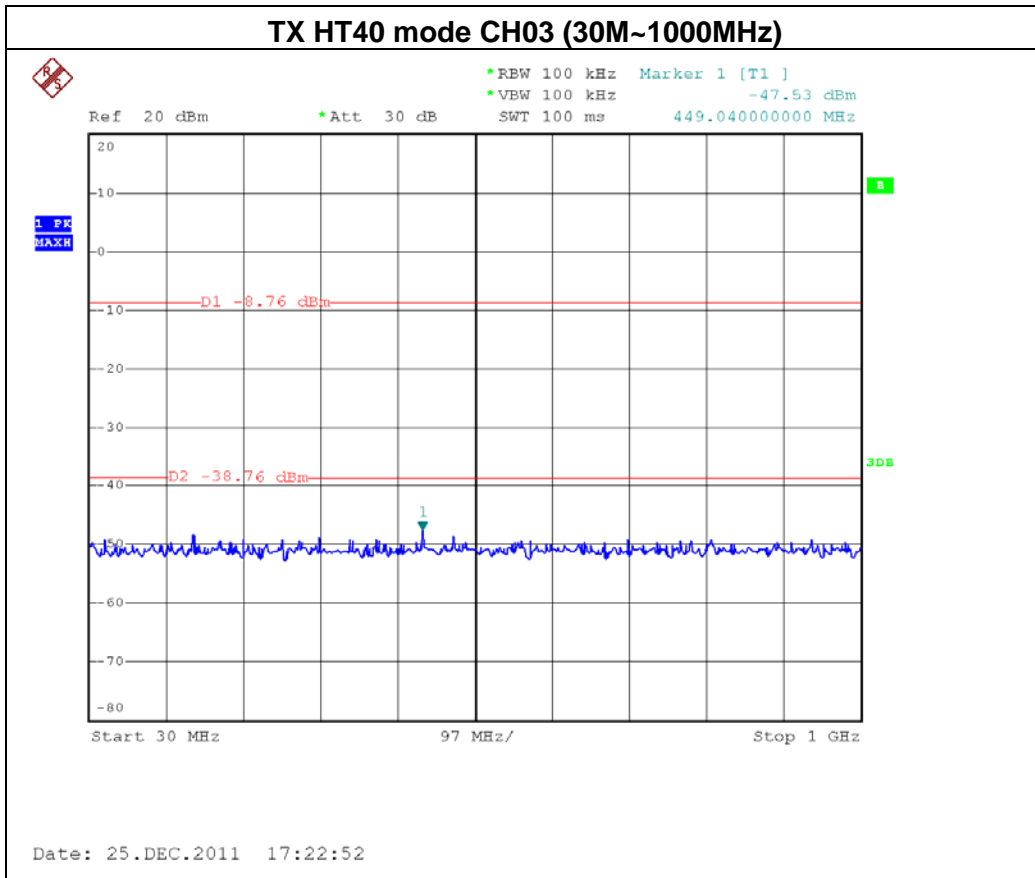



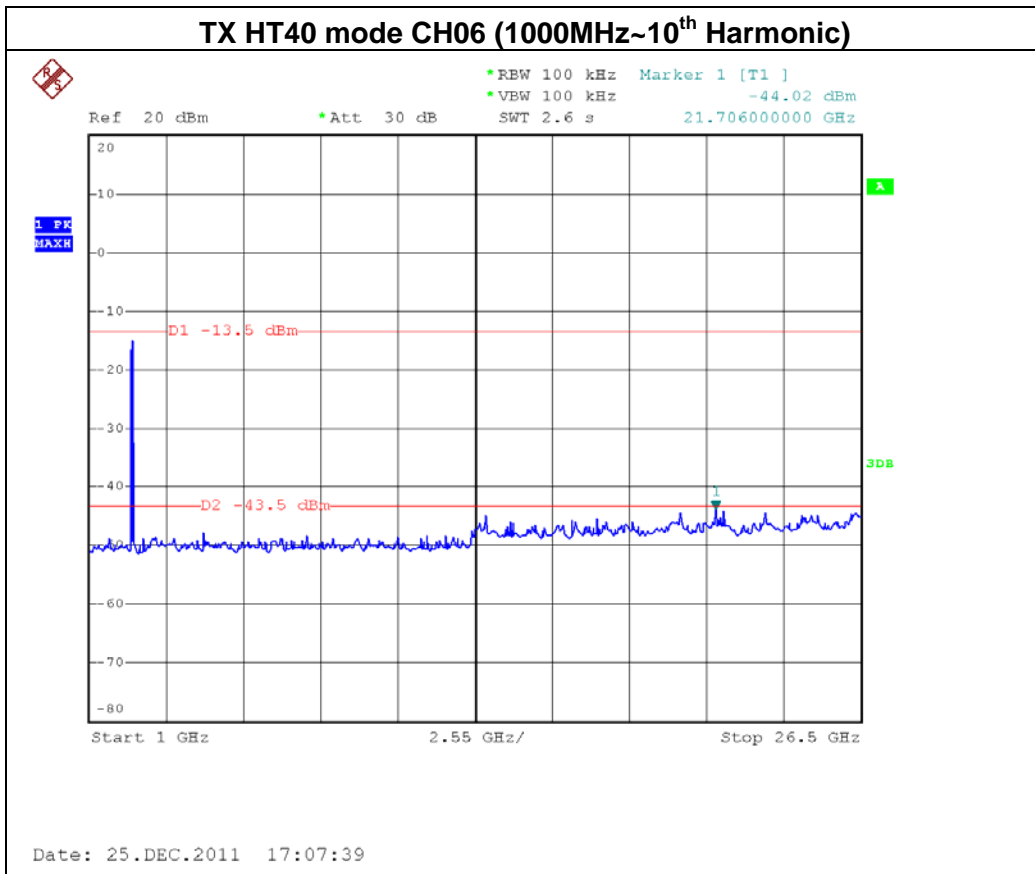
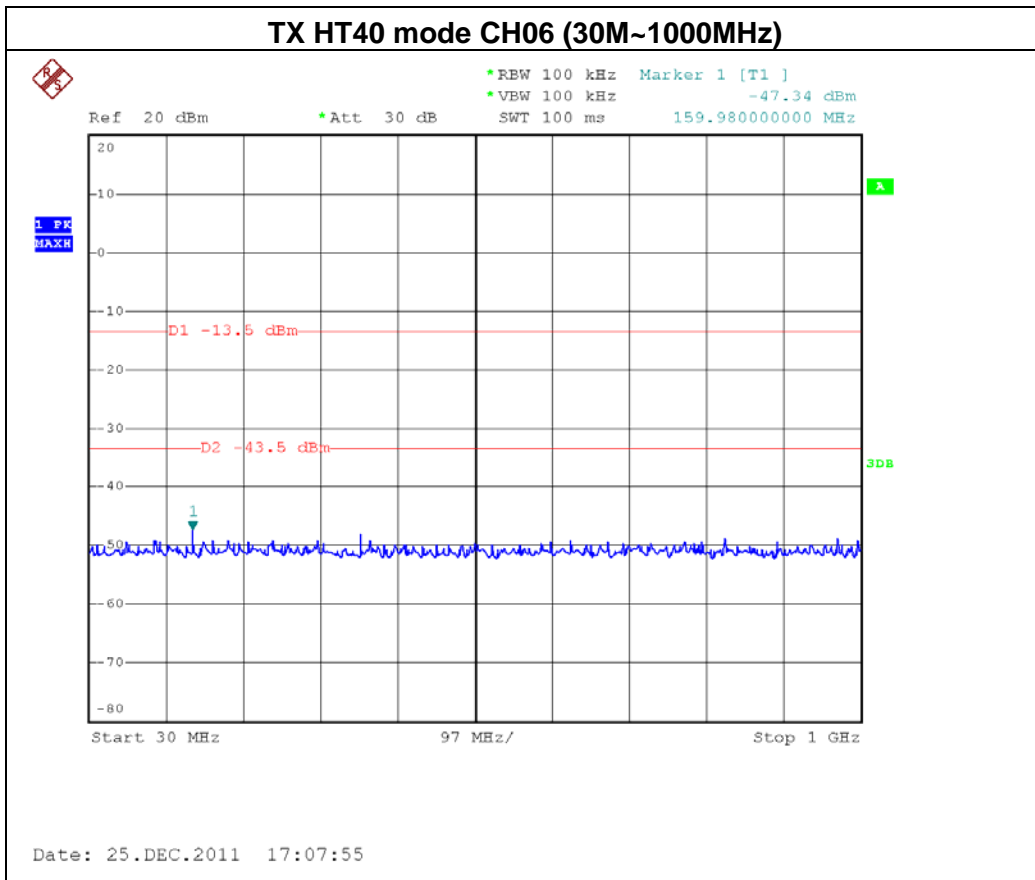

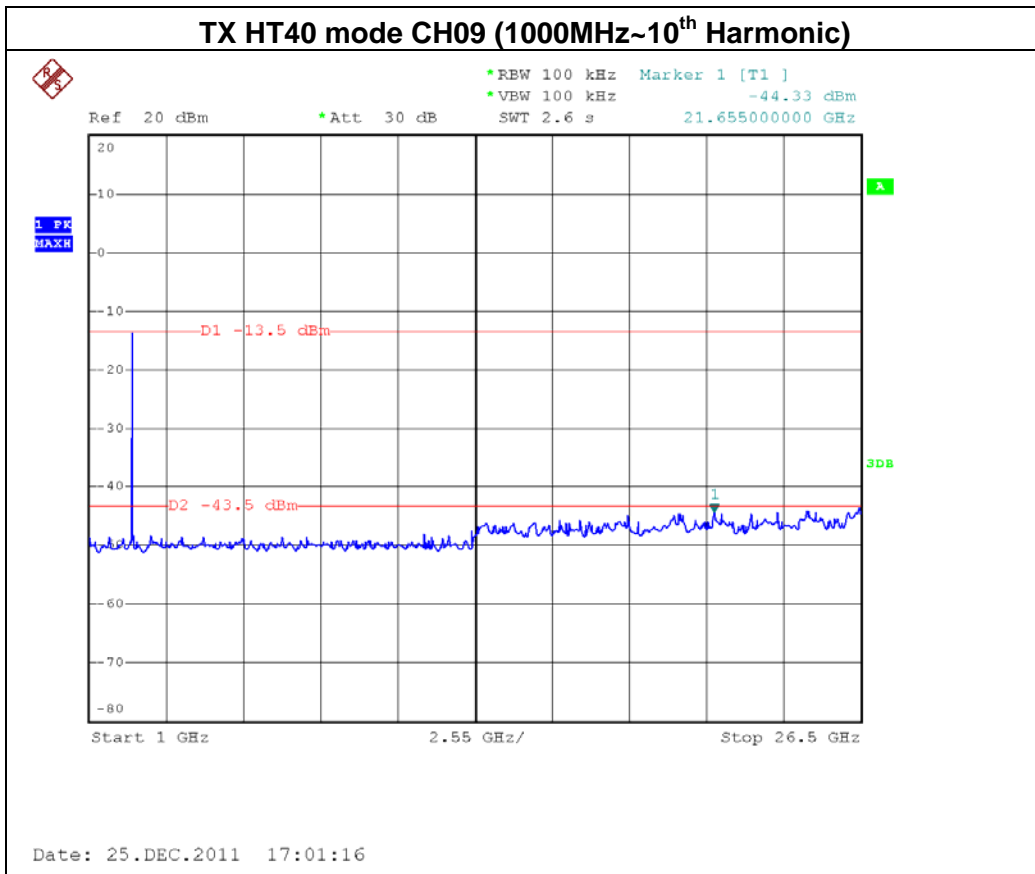
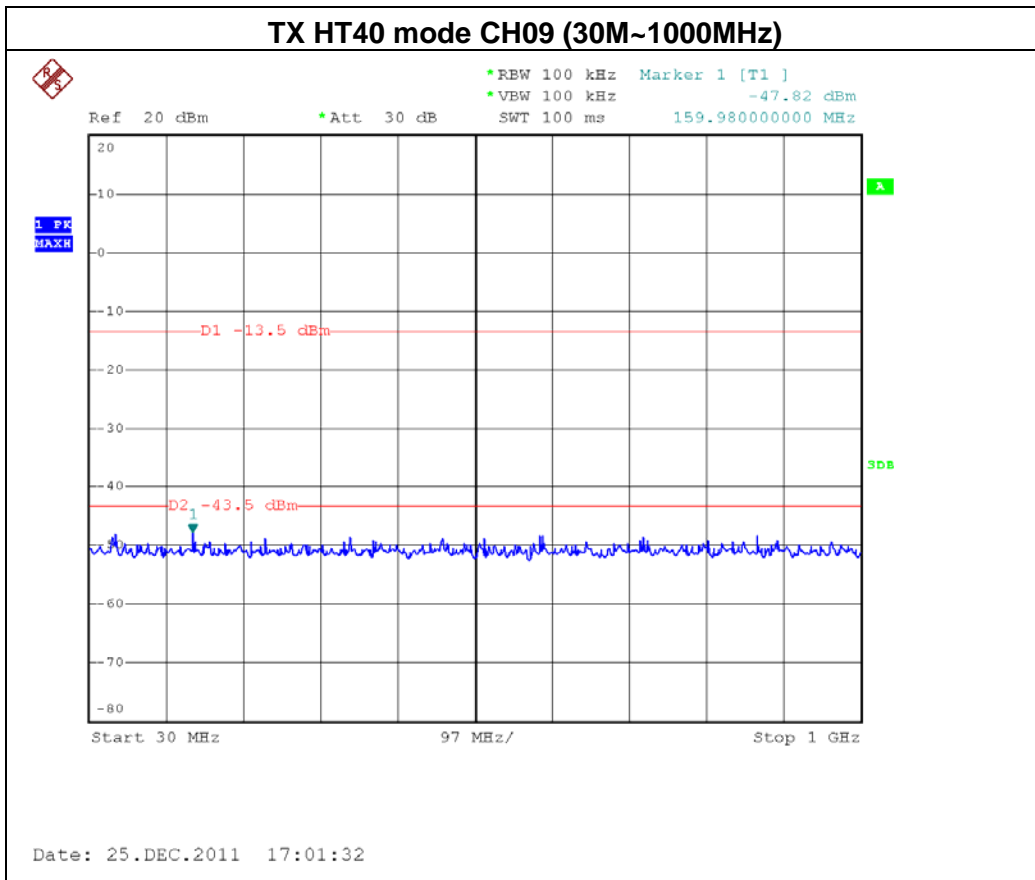



**8. POWER SPECTRAL DENSITY TEST**

**8.1 Applied procedures / limit**

FCC Part15 (15.247) , Subpart C				
Section	Test Item	Limit	Frequency Range (MHz)	Result
15.247(e)	Power Spectral Density	8 dBm (in any 3KHz)	2400-2483.5	PASS

**8.1.1 MEASUREMENT INSTRUMENTS LIST**

Item	Kind of Equipment	Manufacturer	Type No.	Serial No.	Calibrated until
1	Spectrum Analyzer	R&S	FSP 40	100185	Nov.25.2012

Remark: " N/A" denotes No Model Name. , Serial No. or No Calibration specified.

**8.1.2 TEST PROCEDURE**

- a. The EUT was directly connected to the spectrum analyzer and antenna output port as show in the block diagram below,
- b. Spectrum Setting : RBW=3KHz, VBW=30 KHz, Sweep time = 500s.

**8.1.3 DEVIATION FROM STANDARD**

No deviation.

**8.1.4 TEST SETUP**



**8.1.5 EUT OPERATION CONDITIONS**

The EUT tested system was configured as the statements of 4.1.6 Unless otherwise a special operating condition is specified in the follows during the testing.



**8.1.6 TEST RESULTS**

EUT :	150Mbps Wireless N USB Adapter	Model Name :	FWN-651ND; FWN-651N
Temperature :	24 °C	Relative Humidity :	60 %
Pressure :	1016 hPa	Test Voltage :	AC 120V/60Hz
Test Mode :	TX B MODE /CH01, CH06, CH11		

Test Channel	Frequency (MHz)	Power Density (dBm)	LIMIT (dBm)
CH01	2412 MHz	-17.04	8
CH06	2437 MHz	-9.92	8
CH11	2462 MHz	-19.30	8

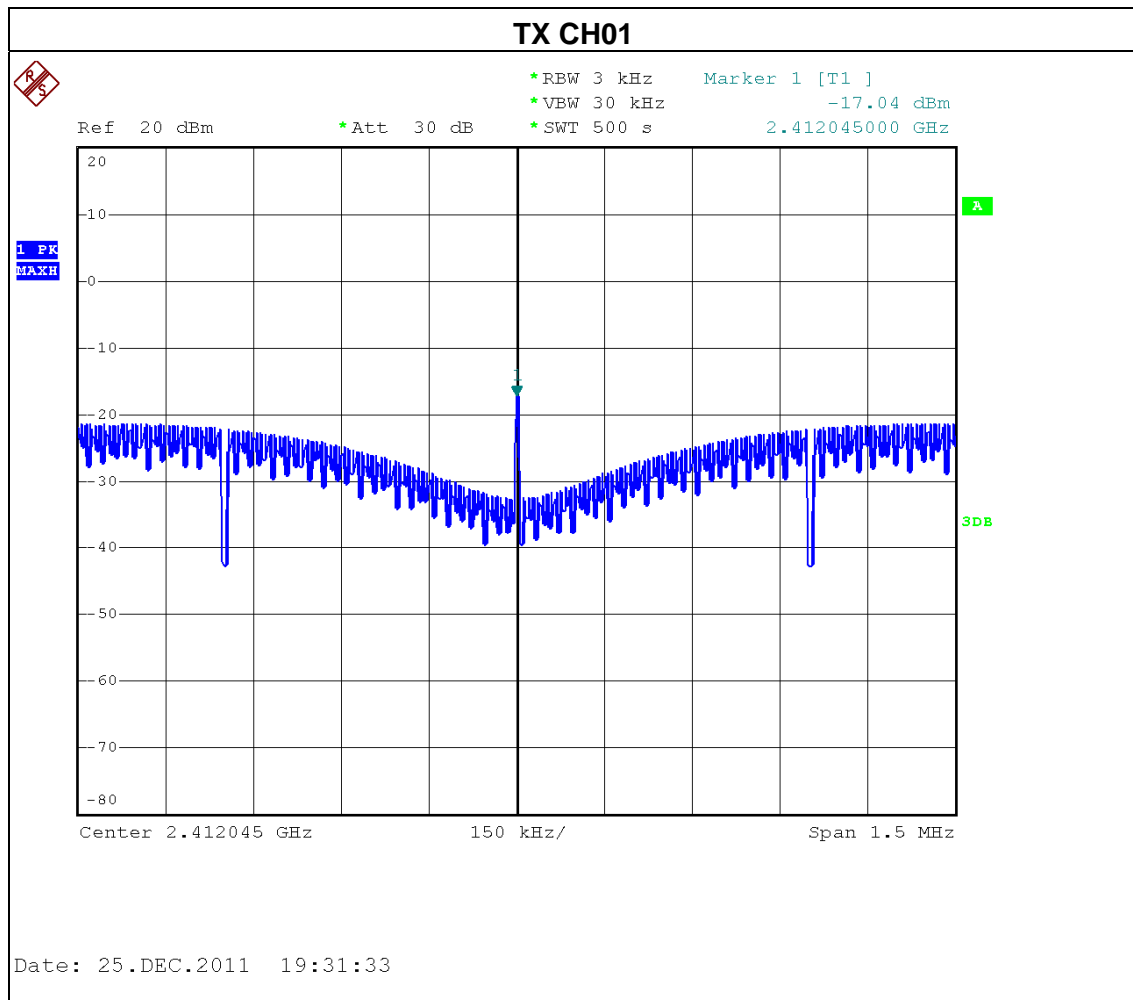

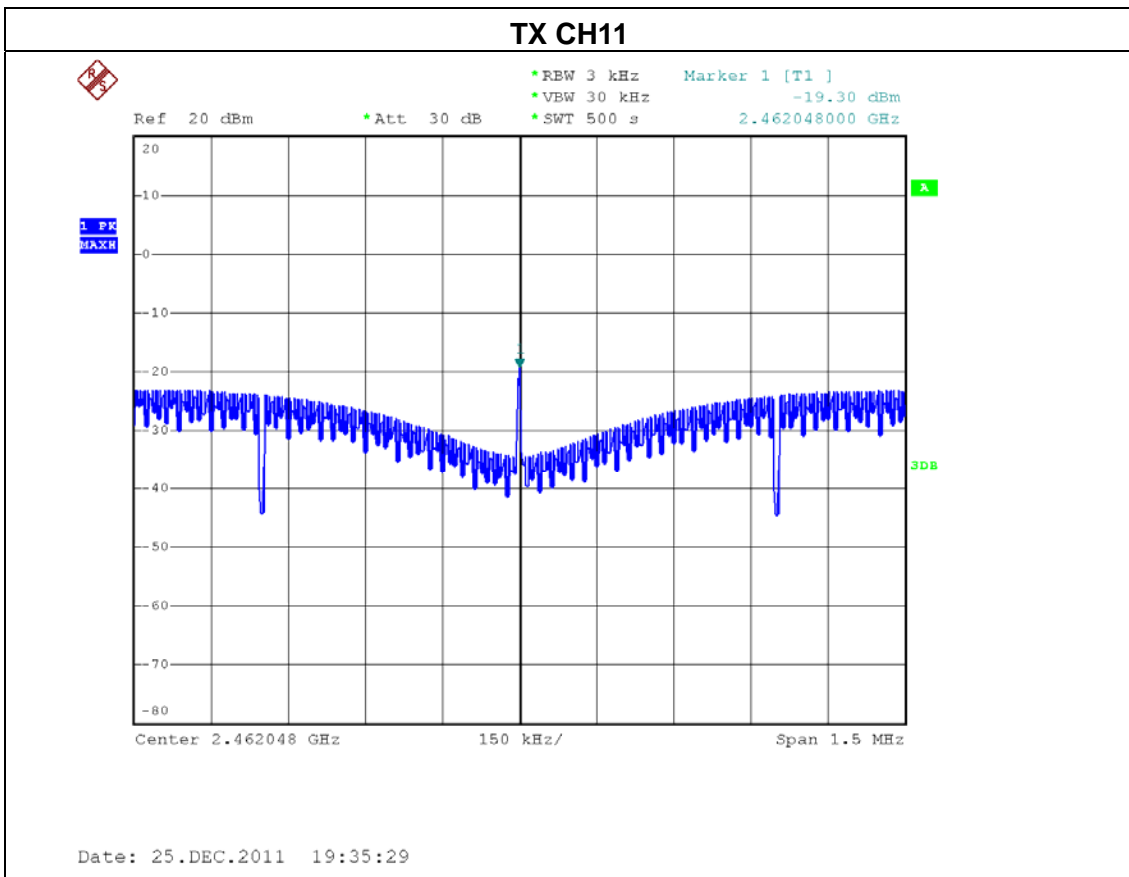
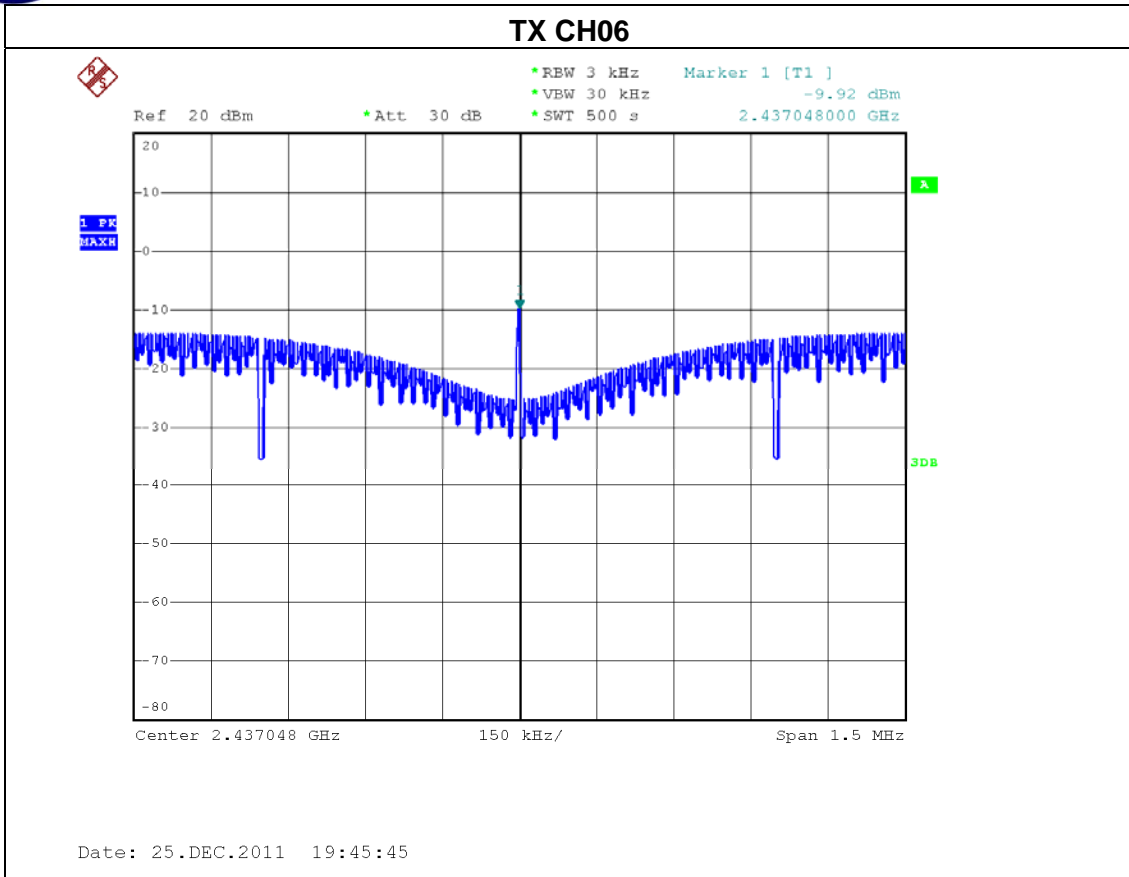



EUT :	150Mbps Wireless N USB Adapter	Model Name :	FWN-651ND; FWN-651N
Temperature :	24 °C	Relative Humidity :	60 %
Pressure :	1016 hPa	Test Voltage :	AC 120V/60Hz
Test Mode :	TX G MODE /CH01, CH06, CH11		

Test Channel	Frequency (MHz)	Power Density (dBm)	LIMIT (dBm)
CH01	2412 MHz	-17.47	8
CH06	2437 MHz	-17.49	8
CH11	2462 MHz	-16.30	8

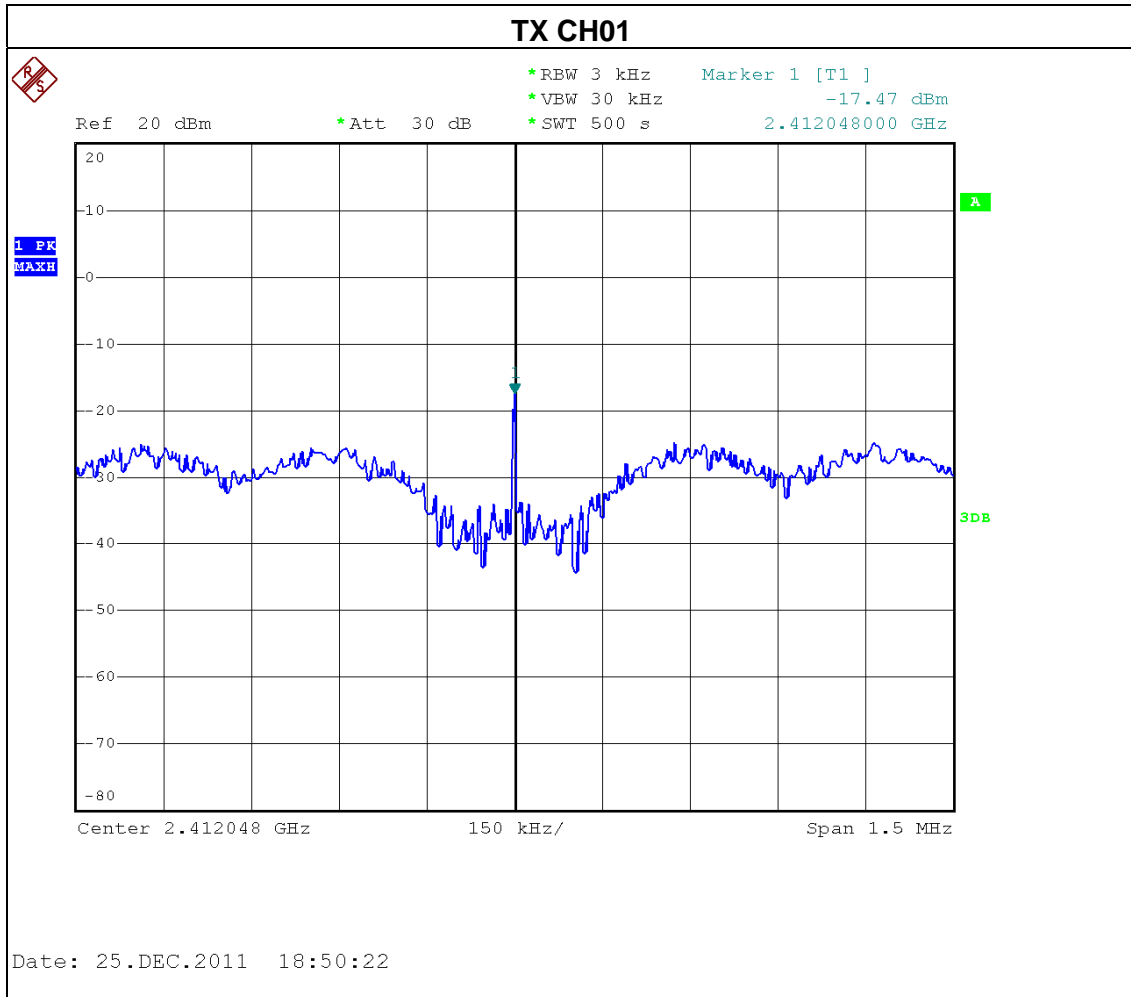

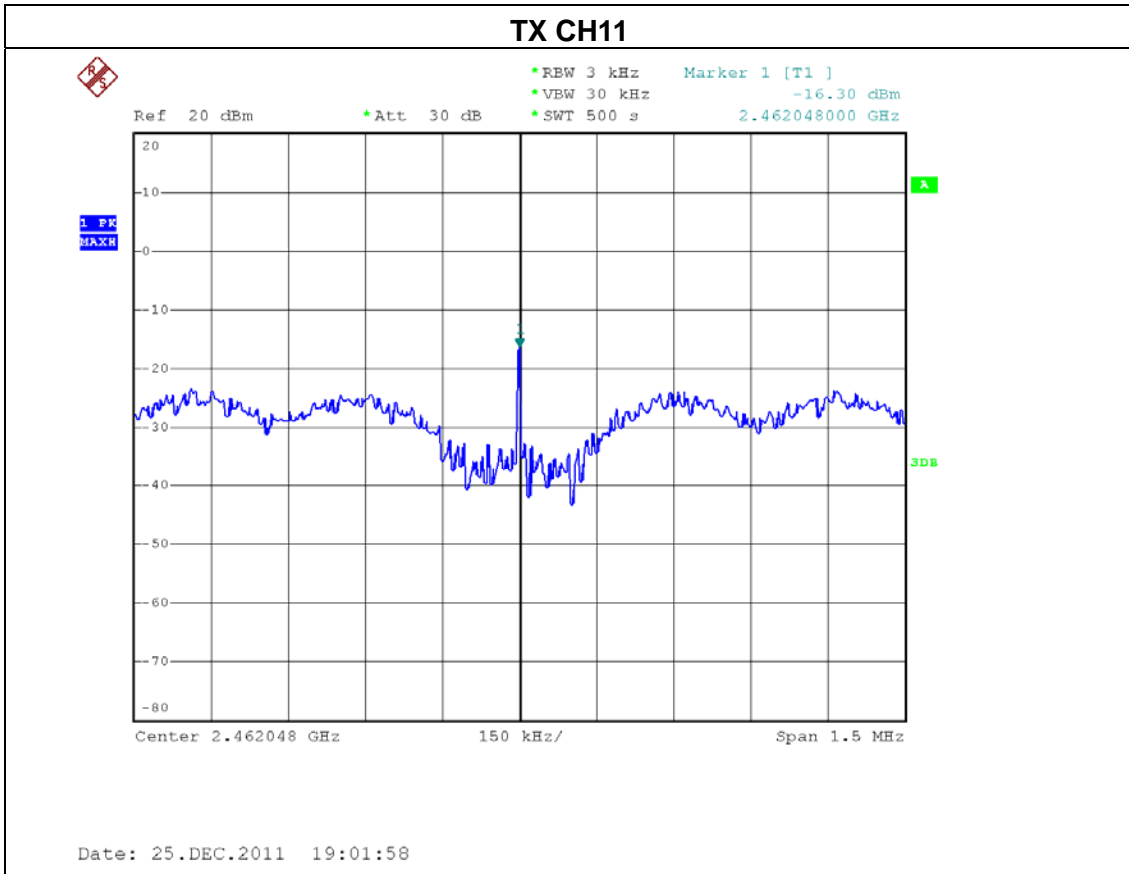
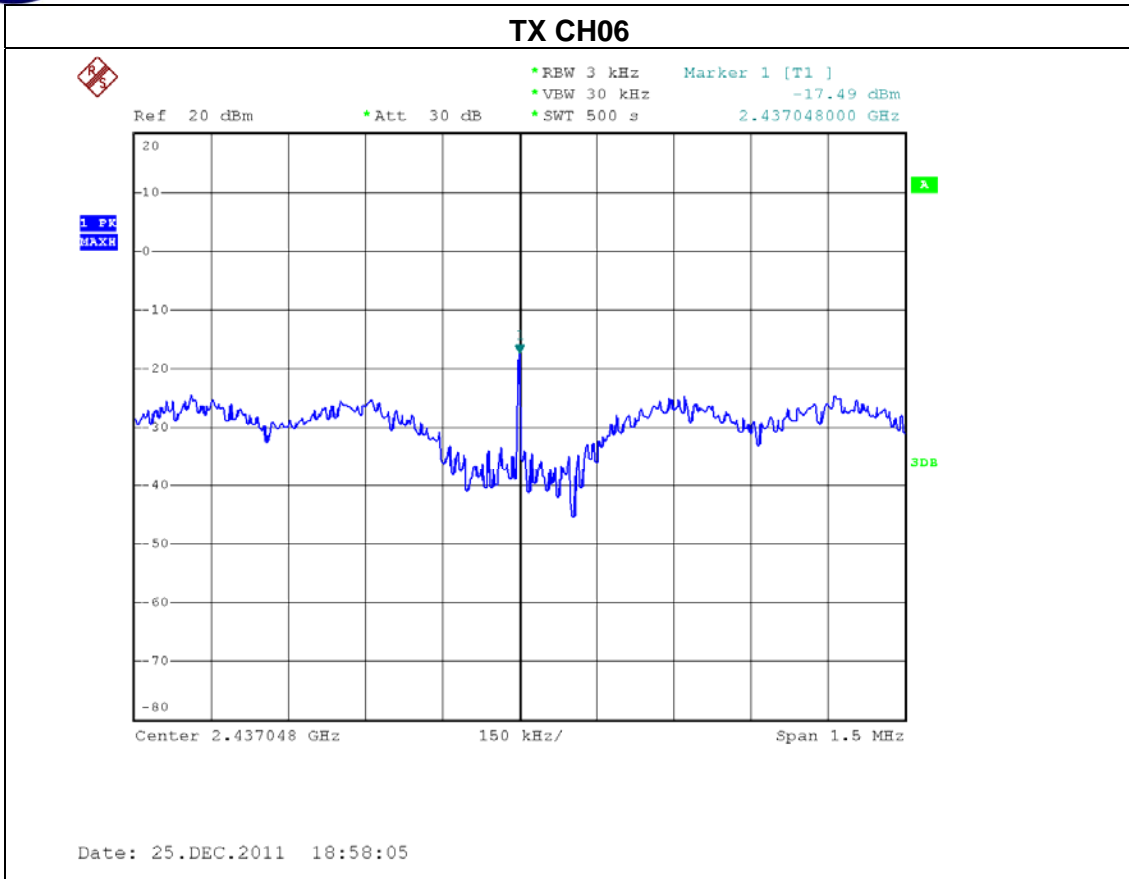





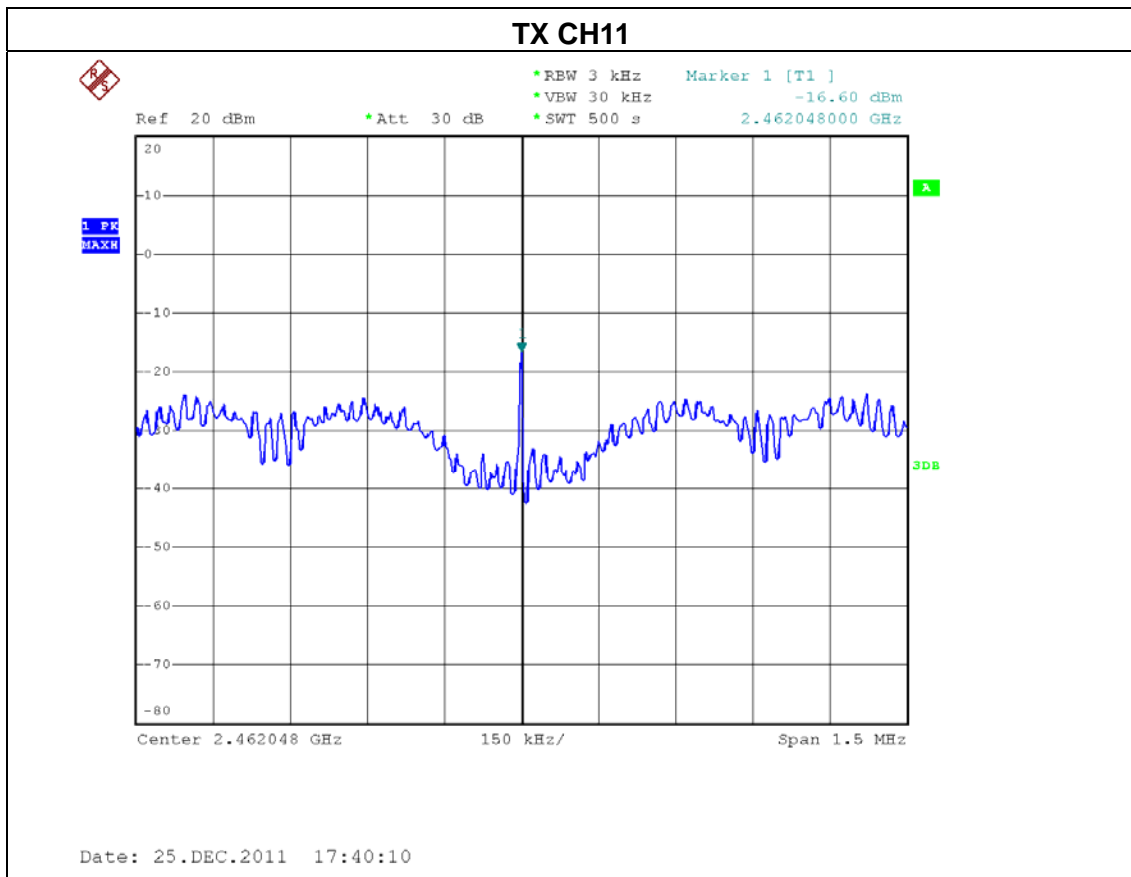
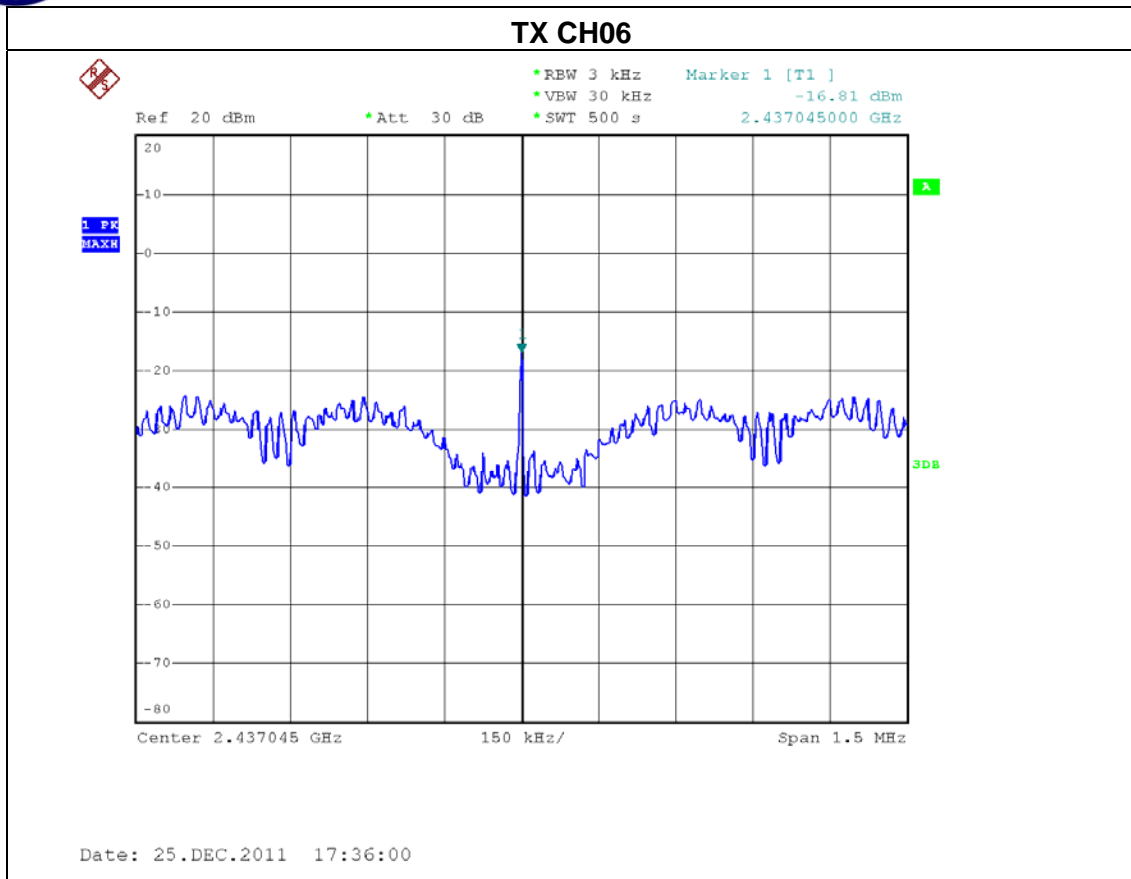



EUT :	150Mbps Wireless N USB Adapter	Model Name :	FWN-651ND; FWN-651N
Temperature :	24 °C	Relative Humidity :	60 %
Pressure :	1016 hPa	Test Voltage :	AC 120V/60Hz
Test Mode :	TX N MODE-40MHz /CH03, CH06, CH09		

Test Channel	Frequency (MHz)	Power Density (dBm)	LIMIT (dBm)
CH01	2412 MHz	-13.71	8
CH06	2437 MHz	-20.60	8
CH11	2462 MHz	-19.33	8

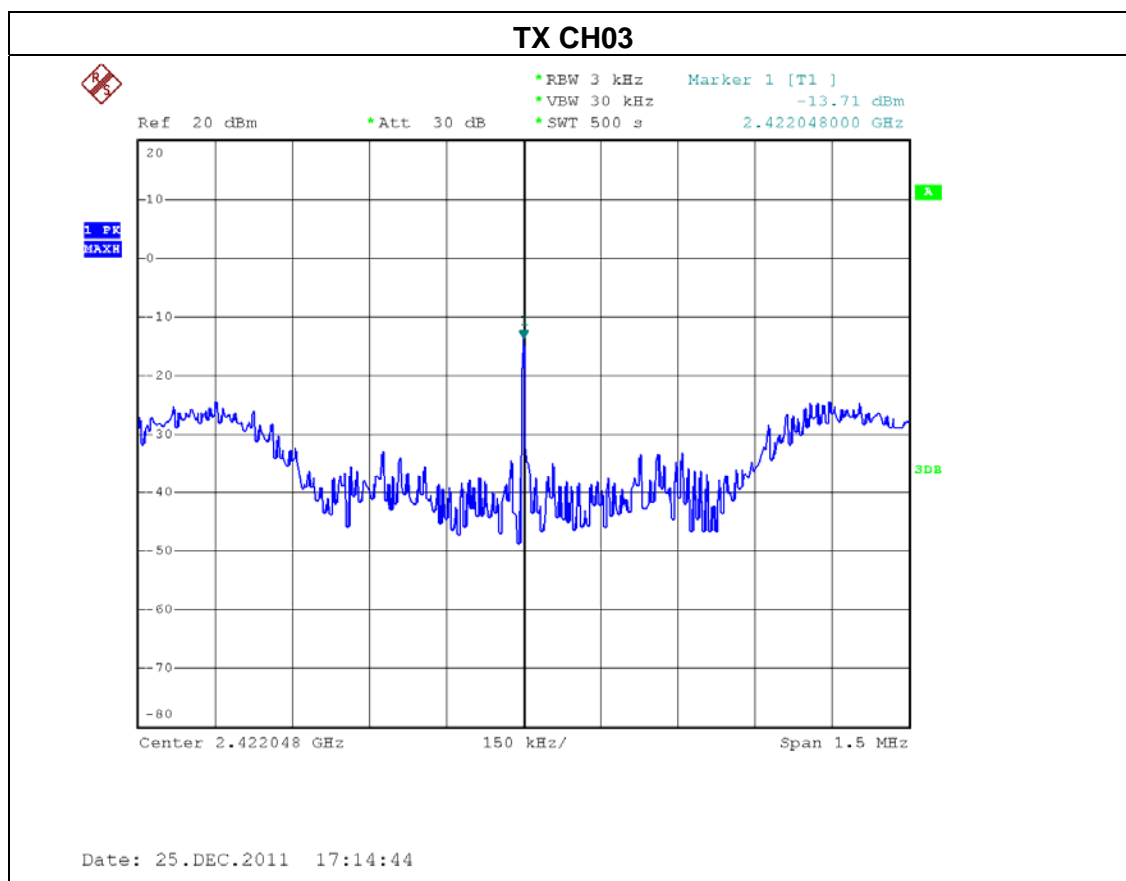

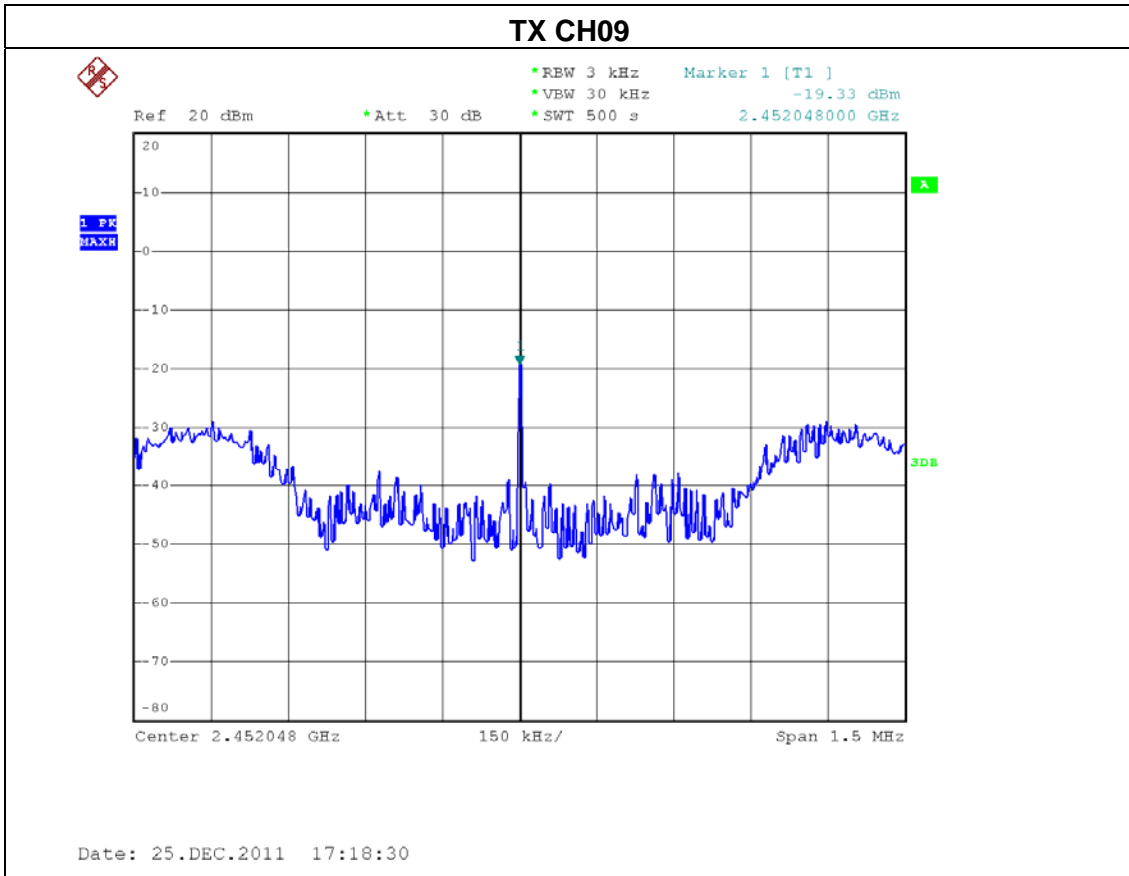
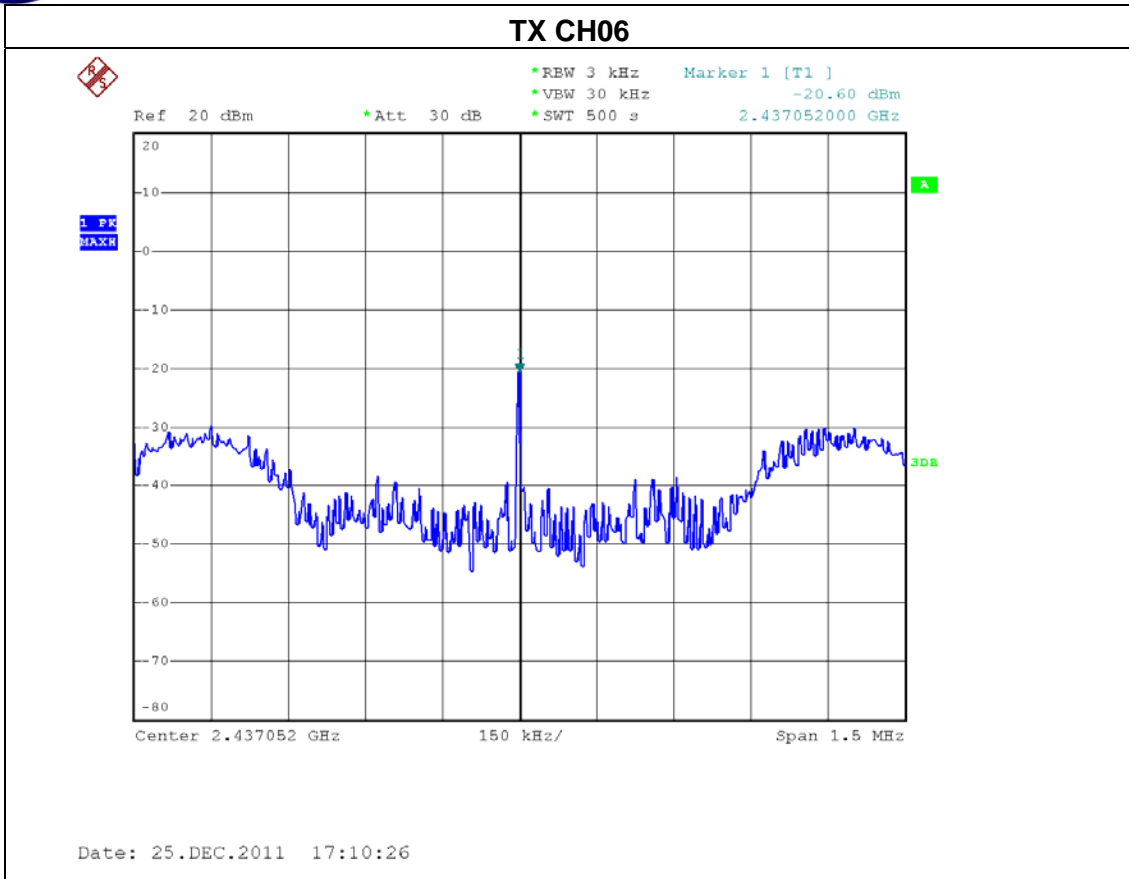



**9. EUT TEST PHOTO**

**Conducted Measurement Photos  
Model : FWN-651ND**

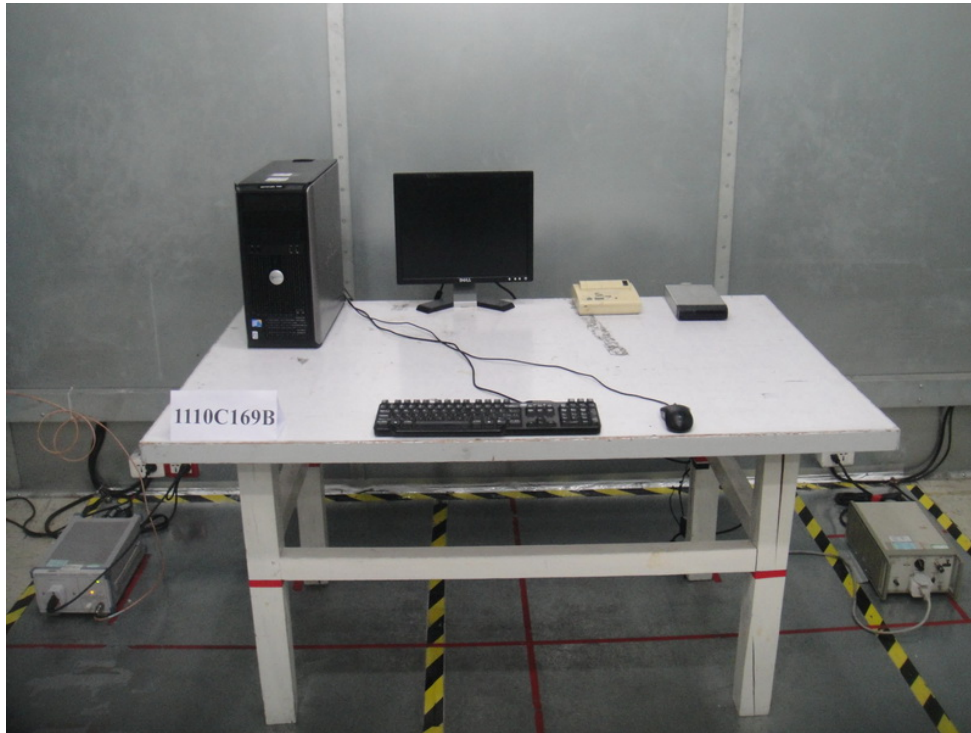

**Conducted Measurement Photos  
Model : FWN-651N**





**Radiated Measurement Photos  
Between 30MHz-1000MHz  
(Model : FWN-651ND)**

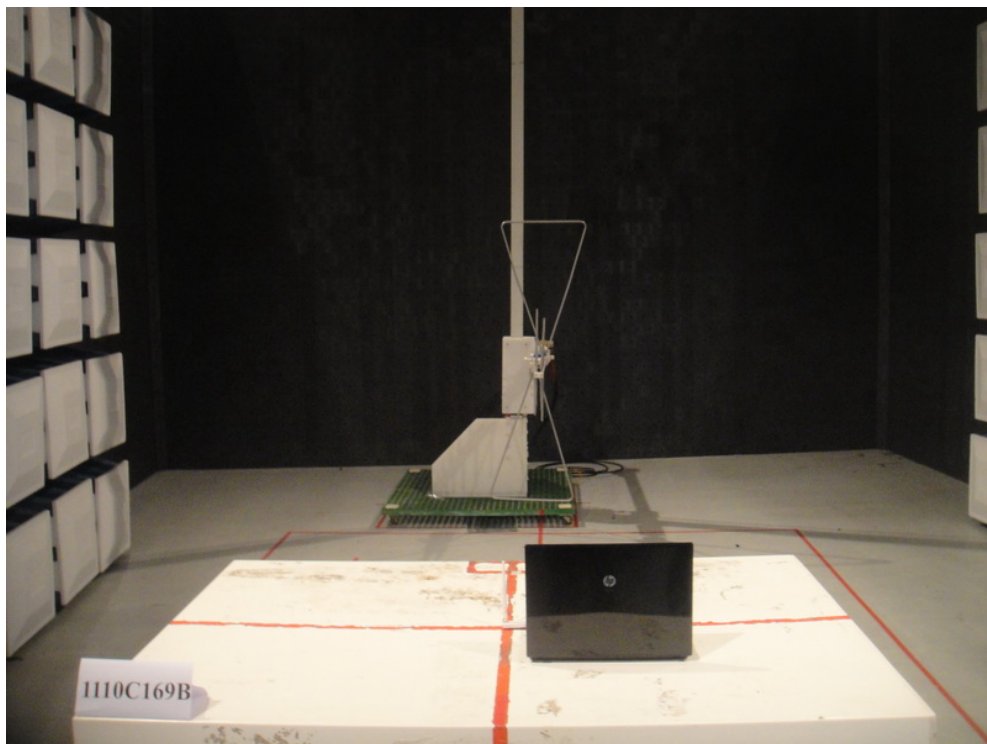
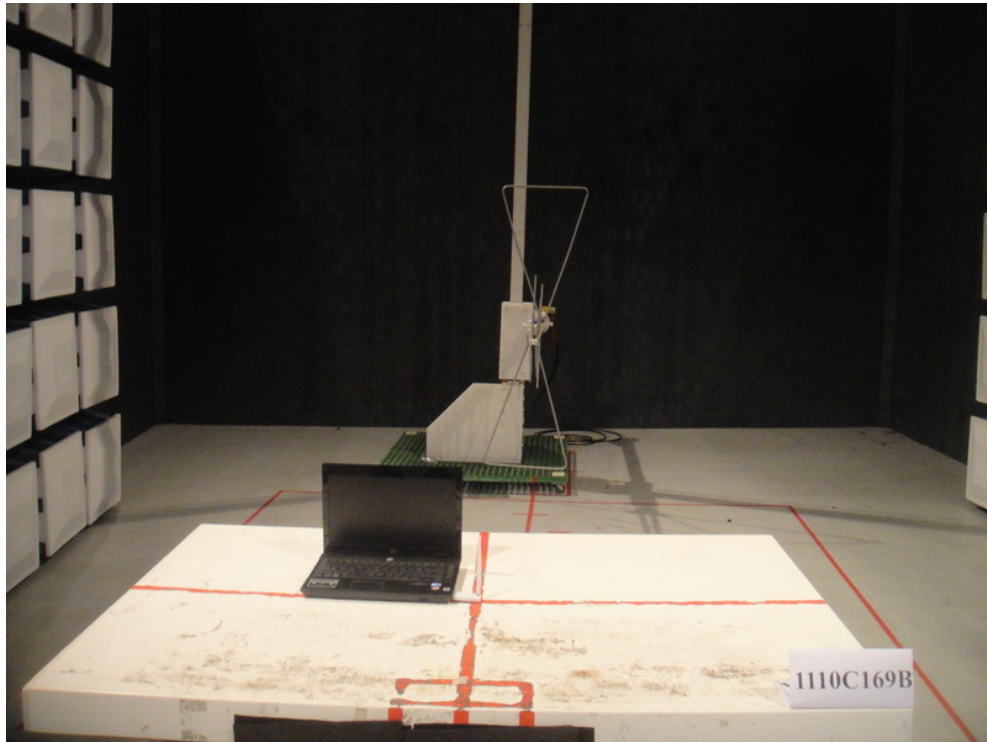

**Radiated Measurement Photos  
Above 1000MHz  
(Model : FWN-651ND)**

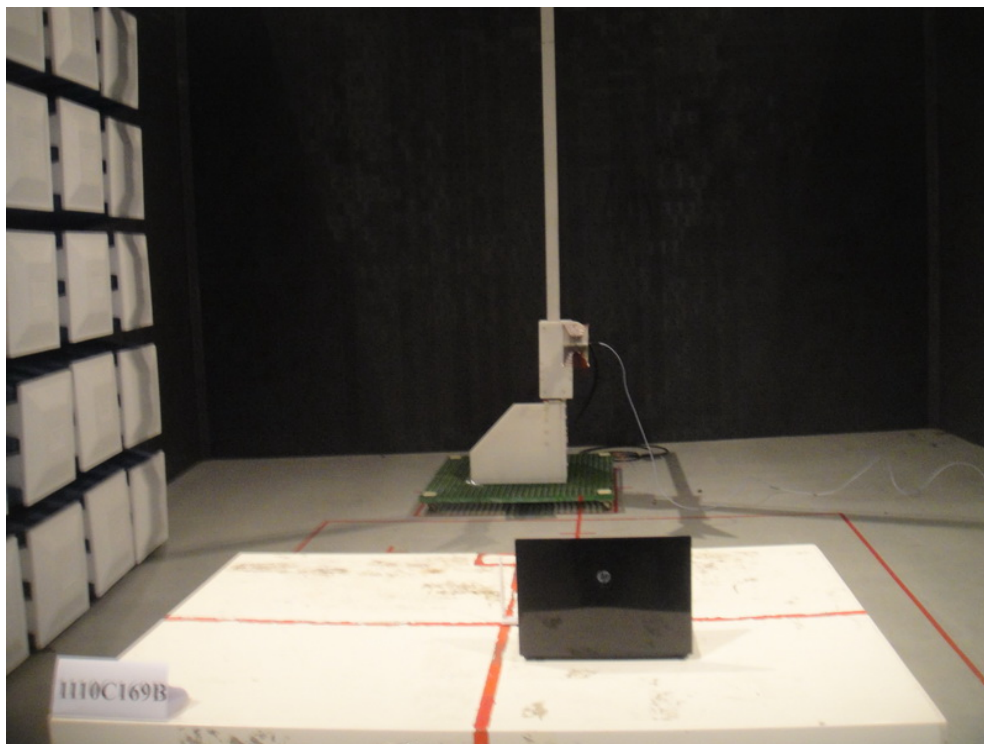
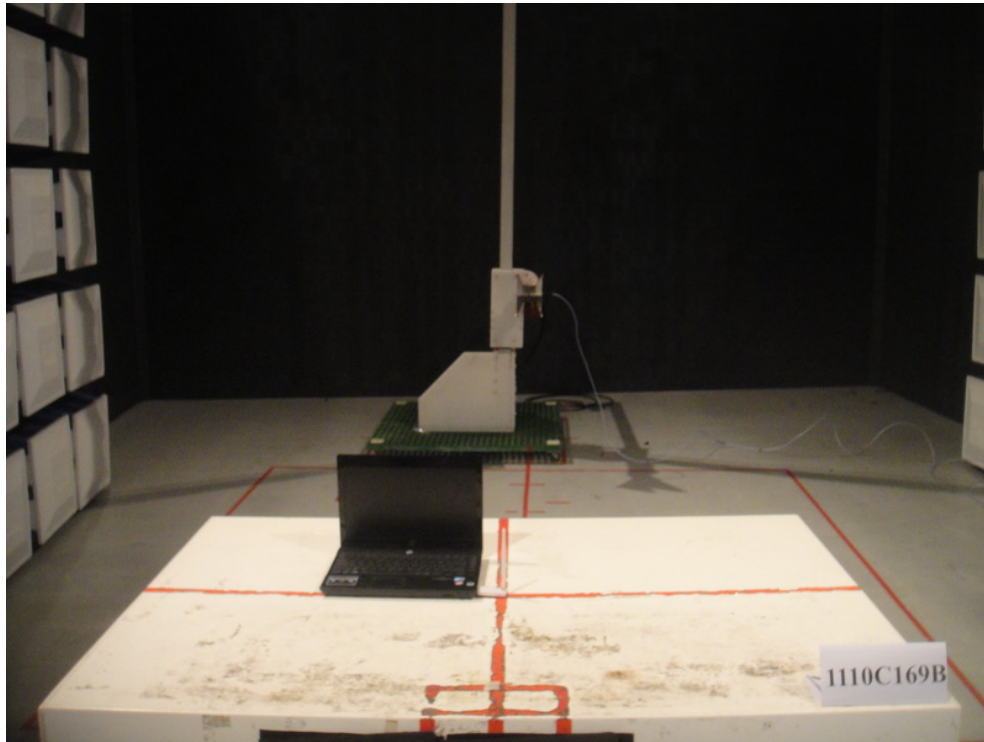

**Radiated Measurement Photos  
Between 30MHz-1000MHz  
(Model : FWN-651N)**

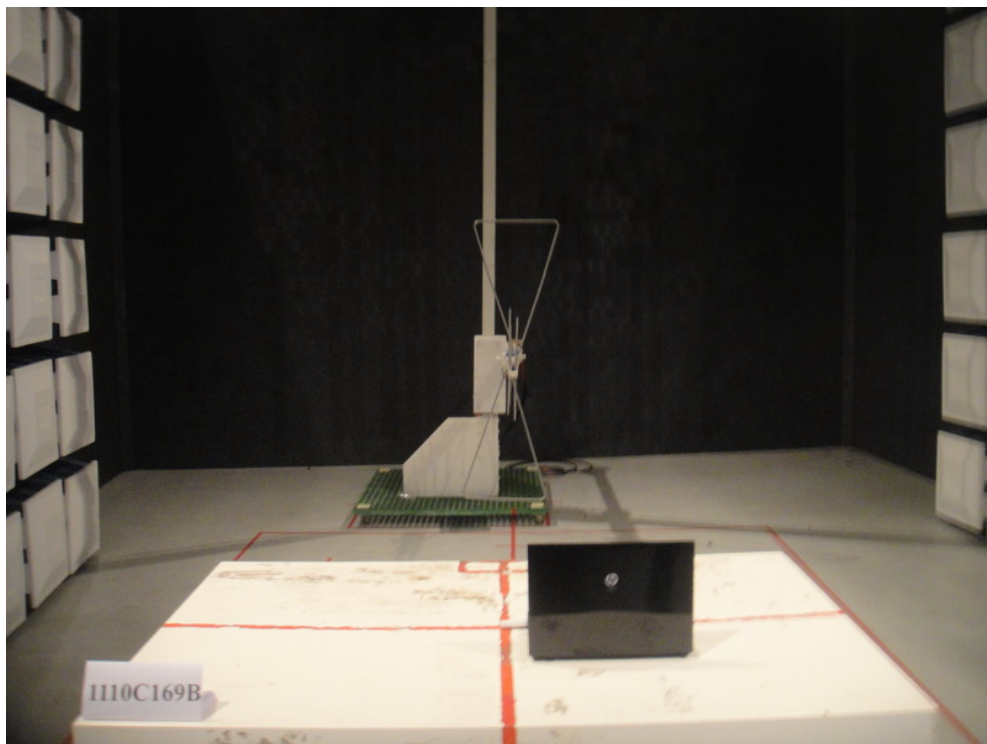
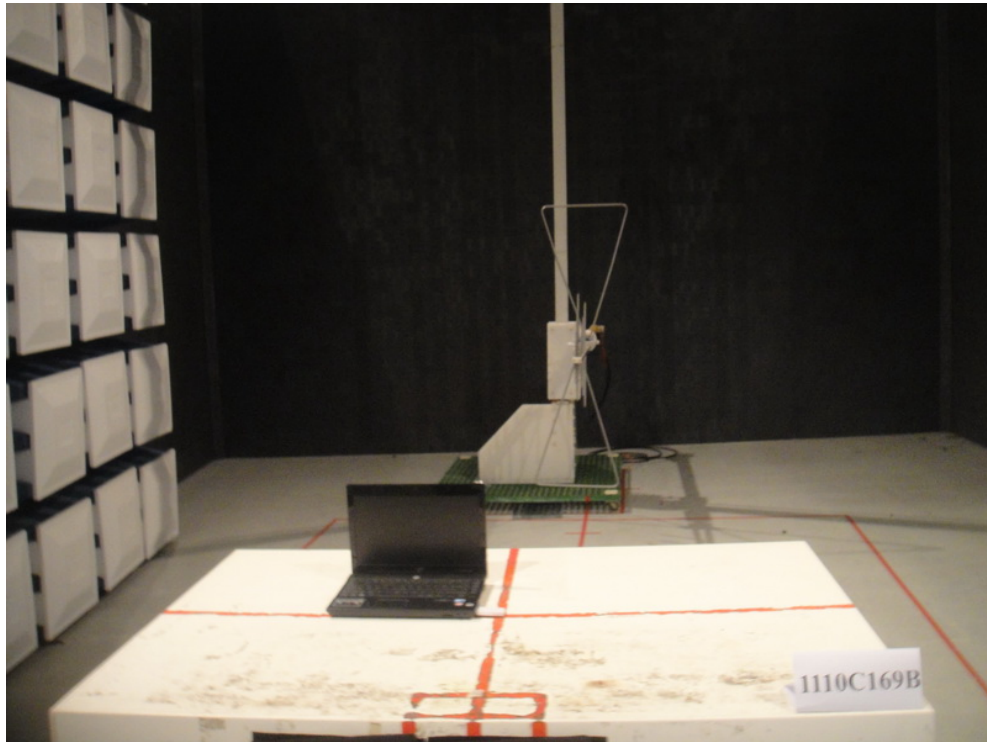





**Radiated Measurement Photos  
Above 1000MHz  
(Model : FWN-651N)**

