



中国认可
国际互认
检测
TESTING
CNAS L5313



Test Report

FCC Part15 Subpart C

Product Name : AC1900 Smart Wi-Fi Router

Model No. : K3C

FCC ID : YJYK3C

Applicant : Phicomm (Shanghai) Co., Ltd.

Address : NO.3666,Sixian Rd.,Songjiang District, Shanghai,
P.R.China

Date of Receipt : Feb. 21st, 2017

Test Date : Feb. 21st, 2017~ Apr. 07th, 2017

Issued Date : July. 07th, 2017

Report No. : 1722077R-RF-US-P06V01

Report Version : V1.0

The test results relate only to the samples tested.

The test results shown in the test report are traceable to the national/international standard through the calibration of the equipment and evaluated measurement uncertainty herein.

This report must not be used to claim product endorsement by TAF,CNAS any agency of the government.

The test report shall not be reproduced without the written approval of DEKRA Testing & Certification (Suzhou) Co., Ltd.

Test Report Certification

Issued Date : July. 07th, 2017
Report No. : 1722077R-RF-US-P06V01



Product Name : AC1900 Smart Wi-Fi Router
 Applicant : Phicomm (Shanghai) Co., Ltd.
 Address : NO.3666,Sixian Rd.,Songjiang District, Shanghai, P.R.China
 Manufacturer : Phicomm (Shanghai) Co., Ltd.
 Address : NO.3666,Sixian Rd.,Songjiang District, Shanghai, P.R.China
 Factory : Phicomm (Shanghai) Co., Ltd.
 Address : NO.3666,Sixian Rd.,Songjiang District, Shanghai, P.R.China
 Model No. : K3C
 FCC ID : YJYK3C
 EUT Voltage : DC 12V
 Test Voltage : AC 120V/60Hz
 Brand Name : PHICOMM
 Applicable Standard : FCC CFR Title 47 Part 15 Subpart C: 2015
 ANSI C63.4:2014; ANSI C63.10:2013;
 KDB 558074 D01v04
 Test Result : Complied
 Performed Location : DEKRA Testing & Certification (Suzhou) Co., Ltd.
 No.99 Hongye Rd., Suzhou Industrial Park, Suzhou, 215006,
 Jiangsu, China
 TEL: +86-512-6251-5088 / FAX: +86-512-6251-5098
 FCC Registration Number: 800392; IC Lab Code: 4075B

Documented By : Kathy Feng
 (Adm. Specialist: Kathy Feng)
 Reviewed By : Jack Zhang
 (Senior Engineer: Jack Zhang)
 Approved By : Harry Zhao
 (Engineering Manager: Harry Zhao)

TABLE OF CONTENTS

Description	Page
1. General Information.....	6
1.1. EUT Description	6
1.2. Working Frequency of Each Channel:	6
1.3. Antenna information	7
1.4. Mode of Operation.....	8
1.5. Tested System Details	8
1.6. Configuration of Tested System.....	9
2. Technical Test.....	11
2.1. Summary of Test Result.....	11
2.2. Test Frequency configuration:.....	12
2.3. Power vs Data Rate.....	13
2.4. Test Environment.....	14
2.5. Measurement Uncertainty.....	14
3. AC Power Line Conducted Emission.....	15
3.1. Test Equipment.....	15
3.2. Test Setup	15
3.3. Limit.....	16
3.4. Test Procedure	16
3.5. Test Result.....	17
4. Emissions in restricted frequency bands	21
4.1. Test Equipment.....	21
4.2. Test Setup	22
4.3. Limit.....	23
4.4. Test Procedure	25
4.5. EUT test Axis definition.....	26
4.6. Test Result.....	27
6. Emissions in non-restricted frequency bands	36
6.1. Test Equipment.....	36
6.2. Test Setup	36
6.3. Limit.....	37
6.4. Test Procedure	38
6.5. EUT test Axis definition.....	39
6.6. Test Result.....	40
7. Radiated Emission Band Edge	42
7.1. Test Equipment.....	42
7.2. Test Setup	43
7.3. Limit.....	43

- 7.4. Test Procedure44
- 7.5. EUT test definition45
- 7.6. Duty Cycle46
- 7.7. Test Result.....47
- 8. Occupied Bandwidth79
- 8.1. Test Equipment.....79
- 8.2. Test Setup79
- 8.3. Limit.....80
- 8.4. Test Procedure80
- 8.5. EUT test definition81
- 8.6. Test Result.....82
- 9. Fundamental emission output power83
- 9.1. Test Equipment.....83
- 9.2. Test Setup83
- 9.3. Limit.....84
- 9.4. Test Procedure85
- 9.5. EUT test definition86
- 9.6. Test Result.....87
- 10. Power Spectral Density88
- 10.1. Test Equipment.....88
- 10.2. Test Setup88
- 10.3. Limit.....88
- 10.4. Test Procedure89
- 10.5. EUT test definition90
- 10.6. Test Result.....91
- 11. Antenna Requirement.....92
- 11.1. Limit.....92
- 11.2. Antenna Connector Construction.....92

History of This Test Report

REPORT NO.	VERSION	DESCRIPTION	ISSUED DATE
1722077R-RF-US-P06V01	V1.0	Initial Issued Report	July. 07th, 2017

1. General Information

1.1. EUT Description

Product Name	AC1900 Smart Wi-Fi Router
Model No.	K3C
EUT Voltage	DC 12V
Test Voltage	AC 120V / 60Hz
Frequency Range	For 2.4GHz Band 802.11b/g/n(20MHz): 2412~2462MHz 802.11n(40MHz): 2422~2452MHz
Channel Number	For 2.4GHz Band 802.11b/g/n(20MHz): 11 802.11n(40MHz): 7
Type of Modulation	802.11b: DSSS 802.11g: OFDM
Data Rate	802.11g: 6/9/12/18/24/36/48/54 Mbps 802.11b: 1/2/5.5/11 Mbps 802.11n: up to 600 Mbps
Channel Control	Auto

1.2. Working Frequency of Each Channel:

802.11b/g/n(20MHz) Working Frequency of Each Channel:							
Channel	Frequency	Channel	Frequency	Channel	Frequency	Channel	Frequency
01	2412 MHz	02	2417 MHz	03	2422 MHz	04	2427 MHz
05	2432 MHz	06	2437 MHz	07	2442 MHz	08	2447 MHz
09	2452 MHz	10	2457 MHz	11	2462 MHz	N/A	N/A
802.11n(40MHz) Working Frequency of Each Channel:							
Channel	Frequency	Channel	Frequency	Channel	Frequency	Channel	Frequency
03	2422 MHz	04	2427 MHz	05	2432 MHz	06	2437 MHz
07	2442 MHz	08	2447 MHz	09	2452 MHz	N/A	N/A

1.3. Antenna information

Antenna manufacturer	VICTORY GIANT TECHNOLOGY (HUI ZHOU) CO. , LTD.					
Antenna Delivery	<input checked="" type="checkbox"/>	1*TX+1*RX	<input type="checkbox"/>	2*TX+2*RX	<input checked="" type="checkbox"/>	3*TX+3*RX
Antenna technology	<input checked="" type="checkbox"/>	SISO for 802.11b/g				
	<input checked="" type="checkbox"/>	MIMO for 802.11n	<input type="checkbox"/>	Basic		
			<input checked="" type="checkbox"/>	CDD		
			<input type="checkbox"/>	Beam-forming		
Antenna Type	<input type="checkbox"/>	External	<input type="checkbox"/>	Dipole		
	<input checked="" type="checkbox"/>	Internal	<input type="checkbox"/>	PIFA		
			<input checked="" type="checkbox"/>	PCB		
			<input type="checkbox"/>	Ceramic Chip Antenna		
			<input type="checkbox"/>	Metal plate type F antenna		
Antenna Gain #1	4dBi					
Antenna Gain #2	4dBi					
Antenna Gain #3	4dBi					
Directional Gain	Power : 4dBi					
	PSD : 8.77dBi					

1.4. Mode of Operation

Test Modes List
Mode 1: Transmit by 802.11b
Mode 2: Transmit by 802.11g
Mode 3: Transmit by 802.11n(20MHz)
Mode 4: Transmit by 802.11n(40MHz)

1.5. Tested System Details

The types for all equipments, plus descriptions of all cables used in the tested system (including inserted cards) are:

No.	Product	Manufacturer	Model No.	Serial No.	Power Cord
1	Notebook	Lenovo	Think pad x220	SUA0600195	Non-shielded

1.6. Configuration of Tested System

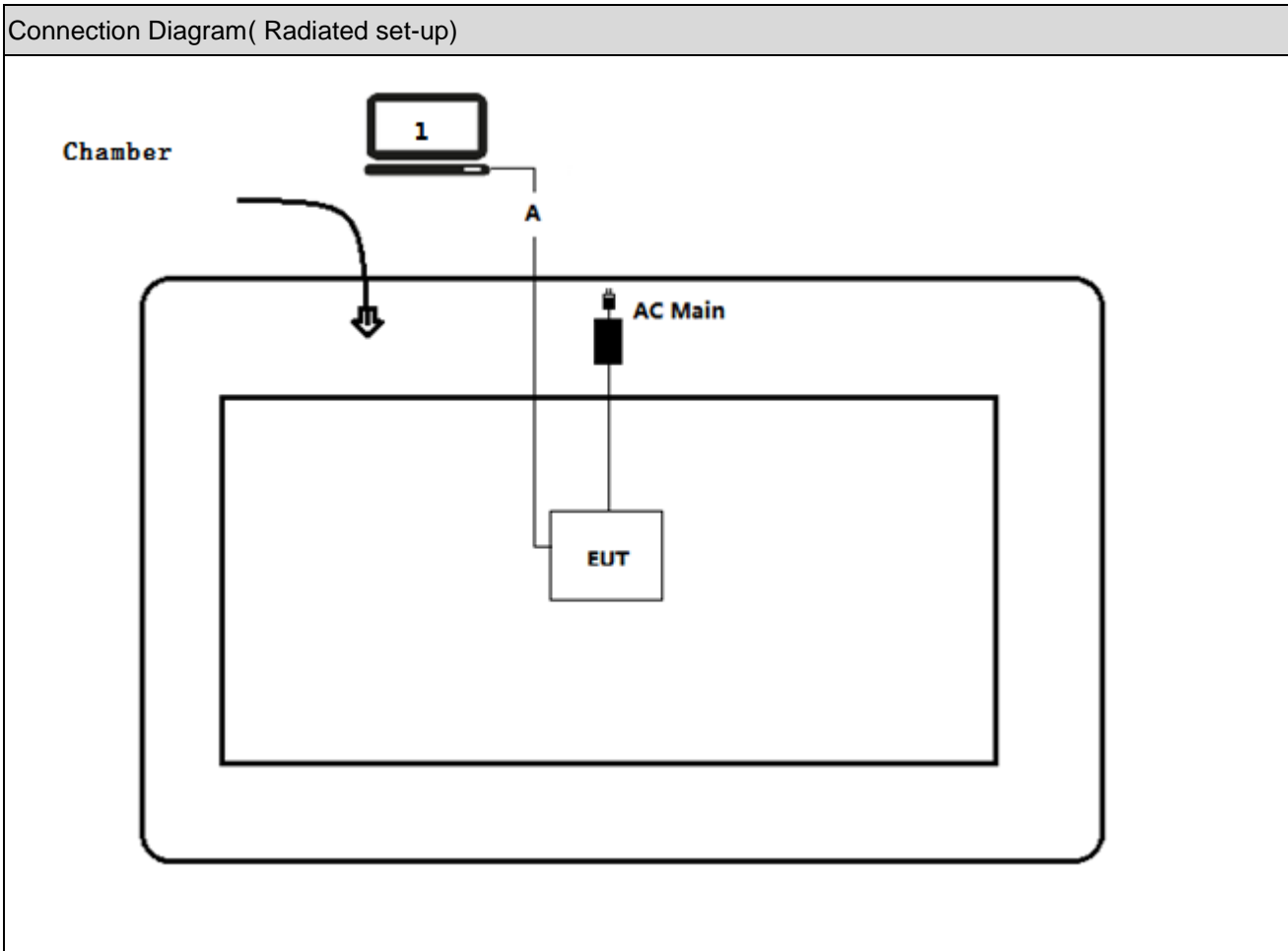

Connection Diagram(Conducted set-up)

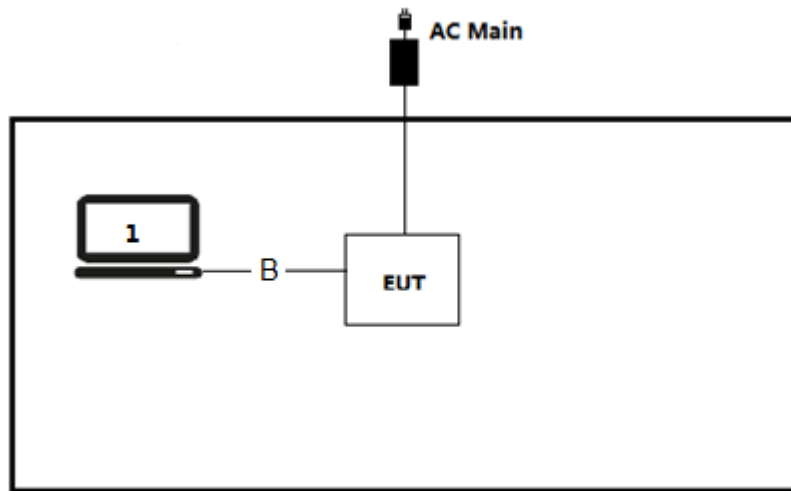

Connection Diagram

A	LAN Cable	Shielded >15m
B	LAN Cable	Shielded >1.5m

2. Technical Test

2.1. Summary of Test Result

Performed Test Item	Normative References	Worst case mode	Limit	Result
AC Power Line Conducted Emission	FCC CFR Title 47 Part 15 Subpart C: 2015 Section 15.207	Mode 1	FCC 15.207	PASS
Emissions in restricted frequency bands	FCC CFR Title 47 Part 15 Subpart C: 2015 Section 15.209	Mode 1	FCC 15.209	PASS
Emissions in non-restricted frequency bands	FCC CFR Title 47 Part 15 Subpart C: 2015 Section 15.247(d)	Mode 1	$\geq 20\text{dBc}$	PASS
Radiated Emission Band Edge	FCC CFR Title 47 Part 15 Subpart C: 2015 15.247(d)	Mode 1	FCC 15.209	PASS
Occupied Bandwidth	FCC CFR Title 47 Part 15 Subpart C: 2015 Section 15.247(a)(2)	Mode 1	$\geq 500\text{kHz}$	PASS
Fundamental emission output power	FCC CFR Title 47 Part 15 Subpart C: 2015 Section 15.247(b)(3)	Mode 1	$\leq 30\text{dBm}$	PASS
Power Spectral Density	FCC CFR Title 47 Part 15 Subpart C: 2015 Section 15.247(e)	Mode 1	$\leq 8\text{dBm}/3\text{kHz}$	PASS
Antenna Requirement	FCC CFR Title 47 Part 15 Subpart C: 2015 Section 15.203	N/A	FCC 15.203	PASS

2.2. Power setting parameter

Test Software	Lantiq DUT				
Modulation Mode	Test Frequency	Ant 1	Ant 2	Ant 3	Ant 1+2+3
802.11b	2412	20	-	-	-
	2437	20	-	-	-
	2462	20	-	-	-
802.11g	2412	13	13	13	-
	2437	19	19	19	-
	2462	13	13	13	-
802.11n(20MHz)	2412	-	-		11.5
	2437	-	-		18.5
	2462	-	-		12
802.11n(40MHz)	2422	-	-		10.5
	2437	-	-		15
	2452	-	-		12

2.3. Transmit description

Modulation Mode	Ant 1	Ant 2	Ant 3	Ant 1+2+3
802.11b	√	×	×	×
802.11g	√	√	√	×
802.11n(20MHz)	×	×	×	√
802.11n(40MHz)	×	×	×	√

2.4. Test Frequency configuration:

Modulation Mode	Channel	Frequency	Channel	Frequency	Channel	Frequency
802.11b	01	2412 MHz	06	2437 MHz	11	2462MHz
802.11g	01	2412 MHz	06	2437 MHz	11	2462MHz
802.11n(20MHz)	01	2412 MHz	06	2437 MHz	11	2462MHz
802.11n(40MHz)	03	2422 MHz	06	2437 MHz	09	2452MHz

2.5. Power vs Data Rate

MCS Index for 802.11n	Spatial Streams	Data Rate (Mbps)						
		802.11b	802.11g		20MHz Bandwidth		40MHz Bandwidth	
					800ns GI	400ns GI	800ns GI	400ns GI
0	1	1	6	---	6.5	7.2	13.5	15.0
1	1	2	9	---	13.0	14.4	27.0	30.0
2	1	5.5	12	---	19.5	21.7	40.5	45.0
3	1	11	18	---	26.0	28.9	54.0	60.0
4	1	---	24	---	39.0	43.3	81.0	90.0
5	1	---	36	---	52.0	57.8	108.0	120.0
6	1	---	48	---	58.5	65.0	121.5	135.0
7	1	---	54	---	65.0	72.2	135.0	200.0
8	2	---	---	---	13.0	14.4	27.0	30.0
9	2	---	---	---	26.0	28.9	54.0	60.0
10	2	---	---	---	39.0	43.3	81.0	90.0
11	2	---	---	---	52.0	57.8	108.0	120.0
12	2	---	---	---	78.0	86.7	162.0	180.0
13	2	---	---	---	104.0	115.6	216.0	240.0
14	2	---	---	---	117.0	130.0	243.0	270.0
15	2	---	---	---	130.0	144.0	270.0	400.0
16	3	---	---	---	19.5	21.6	40.5	45
17	3	---	---	---	39	43.2	108	90
18	3	---	---	---	58.5	65.1	162	135
19	3	---	---	---	78	86.7	216	180
20	3	---	---	---	117	129.9	324	270
21	3	---	---	---	156	173.4	432	360
22	3	---	---	---	175.5	195	486	405
23	3	---	---	---	195	216.6	540	800

Note 1 : The blue form is the maximum power data rate

Note 2 : The EUT has two spatial Streams

2.6. Test Environment

Items	Required (IEC 68-1)	Actual
Temperature (°C)	15-35	21
Humidity (%RH)	25-75	50
Barometric pressure (mbar)	860-1060	950-1000

2.7. Measurement Uncertainty

Test Items	Uncertainty
AC Power Line Conducted Emission	$\pm 2.02\text{dB}$
Radiated Emission	Below 1GHz $\pm 3.8\text{ dB}$
	Above 1GHz $\pm 3.9\text{ dB}$
RF Antenna Port Conducted Emission	$\pm 1.27\text{dB}$
Radiated Emission Band Edge	$\pm 3.9\text{dB}$
Occupied Bandwidth	$\pm 1\text{kHz}$
Power Spectral Density	$\pm 1.27\text{dB}$

3. AC Power Line Conducted Emission

3.1. Test Equipment

AC Power Line Conducted Emission / TR-1					
Instrument	Manufacturer	Type No.	Serial No.	Cal. Date	Cal. Due Date
EMI Test Receiver	R&S	ESCI	100906	2017.03.05	2018.03.05
Two-Line V-Network	R&S	ENV 216	101189	2016.07.16	2017.07.16
Two-Line V-Network	R&S	ENV 216	101044	2016.09.16	2017.09.16
50ohm Coaxial Switch	Anritsu	MP59B	6200464462	N/A	N/A
50ohm Termination	SHX	TF2	07081402	2016.09.16	2017.09.16
Temperature/Humidity Meter	Zhichen	ZC1-2	TR1-TH	2017.01.05	2018.01.05

Note: All equipments are calibrated with traceable calibrations. Each calibration is traceable to the national or international standards.

3.2. Test Setup

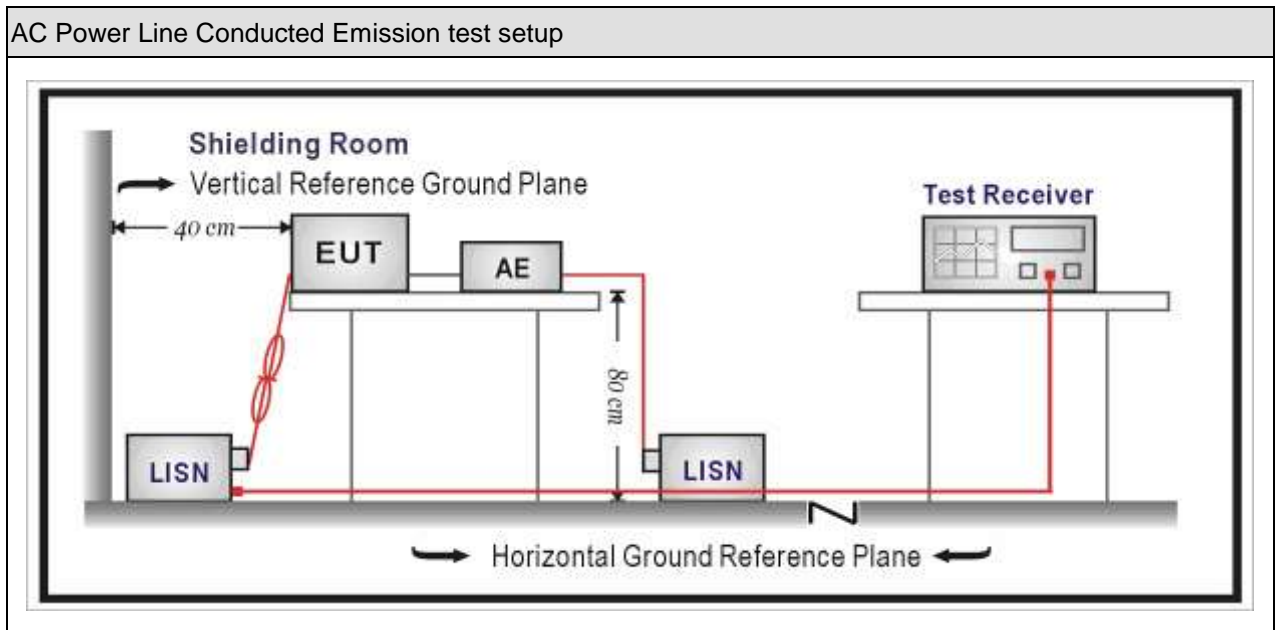

3.3. Limit

Frequency of Emission (MHz)	Conducted Limit	
	Quasi-peak (dB μ V)	Average (dB μ V)
0.15-0.5	66 to 56	56 to 46
0.5-5	56	46
5-30	60	50

Note 1: The lower limit shall apply at the transition frequencies.
 Note 2: The limit decreases linearly with the logarithm of the frequency in the range 0.15 MHz to 0.5 MHz.

3.4. Test Procedure

Test Method			
	References Rule	Chapter	Item
<input checked="" type="checkbox"/>	ANSI C63.10-2013	6.2	Standard test method for ac power-line conducted emissions from unlicensed wireless devices
<input checked="" type="checkbox"/>	ANSI C63.4-2014	7	AC power-line conducted emission measurements

3.5. Test Result

Site: TR1	Time: 2017/05/26
Limit: FCC_Part15.207_CE_AC Power_ClassB	Margin: 0
Probe: ENV216-L1	Polarity: Line
EUT: AC1900 Dual Band Gigabit WiFi Router	Power: AC 120V/60Hz
Note: Mode 1: Transmit at channel 2412MHz by 802.11b with Adapter #1	

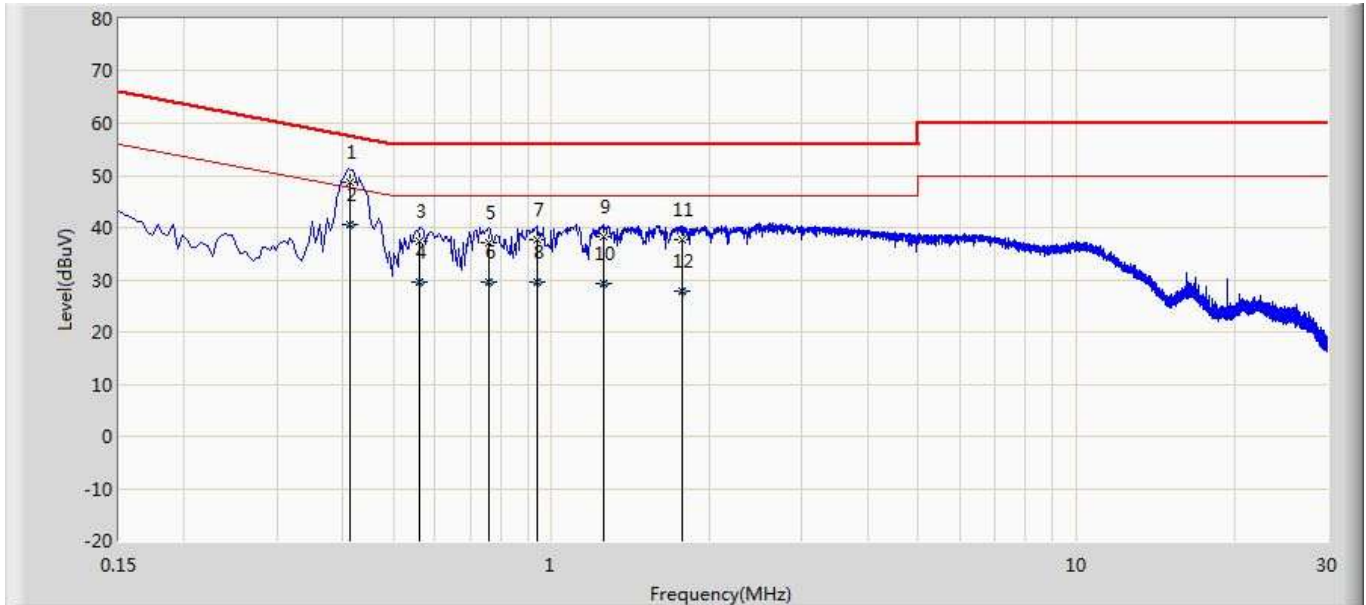

No	Mark	Frequency (MHz)	Measure Level (dBuV)	Reading Level (dBuV)	Over Limit (dB)	Limit (dBuV)	Probe (dB)	Cable (dB)	Amp (dB)	Type
1		0.414	48.577	38.938	-8.991	57.568	9.600	0.039	0.000	QP
2	*	0.414	40.718	31.079	-6.850	47.568	9.600	0.039	0.000	AV
3		0.562	37.517	27.871	-18.483	56.000	9.600	0.045	0.000	QP
4		0.562	29.468	19.823	-16.532	46.000	9.600	0.045	0.000	AV
5		0.762	37.237	27.583	-18.763	56.000	9.602	0.052	0.000	QP
6		0.762	29.458	19.804	-16.542	46.000	9.602	0.052	0.000	AV
7		0.938	37.581	27.916	-18.419	56.000	9.608	0.056	0.000	QP
8		0.938	29.655	19.990	-16.345	46.000	9.608	0.056	0.000	AV
9		1.258	38.247	28.573	-17.753	56.000	9.610	0.064	0.000	QP
10		1.258	29.355	19.681	-16.645	46.000	9.610	0.064	0.000	AV
11		1.774	37.791	28.097	-18.209	56.000	9.610	0.084	0.000	QP
12		1.774	27.860	18.166	-18.140	46.000	9.610	0.084	0.000	AV

Note:

1. " * ", means this data is the worst emission level.
2. Measurement Level = Reading Level + Factor(Probe+Cable-Amp).

Site: TR1	Time: 2017/05/26
Limit: FCC_Part15.107_CE_AC Power_ClassB	Margin: 0
Probe: ENV216-N	Polarity: Neutral
EUT: AC1900 Dual Band Gigabit WiFi Router	Power: AC 120V/60Hz
Note: Mode 1: Transmit at channel 2412MHz by 802.11b with Adapter #1	

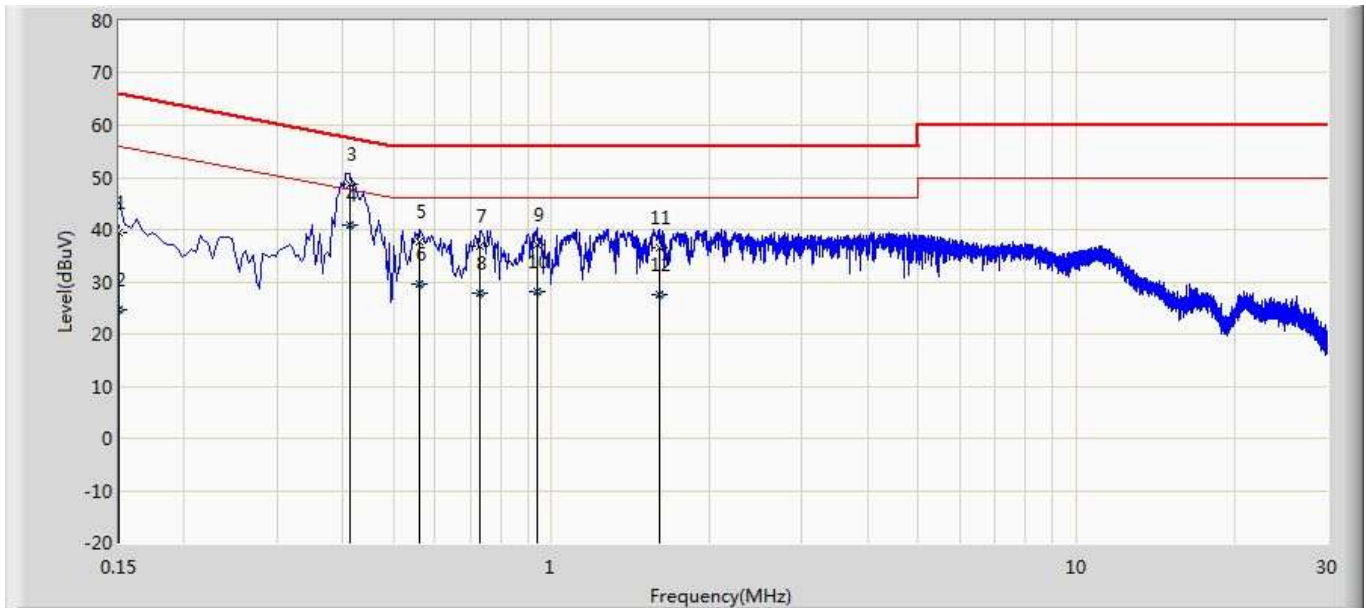

No	Mark	Frequency (MHz)	Measure Level (dBuV)	Reading Level (dBuV)	Over Limit (dB)	Limit (dBuV)	Probe (dB)	Cable (dB)	Amp (dB)	Type
1		0.150	39.490	29.876	-26.510	66.000	9.594	0.021	0.000	QP
2		0.150	24.749	15.135	-31.251	56.000	9.594	0.021	0.000	AV
3		0.414	48.790	39.158	-8.778	57.568	9.592	0.039	0.000	QP
4	*	0.414	40.927	31.296	-6.640	47.568	9.592	0.039	0.000	AV
5		0.562	37.629	27.994	-18.371	56.000	9.590	0.045	0.000	QP
6		0.562	29.690	20.055	-16.310	46.000	9.590	0.045	0.000	AV
7		0.730	36.777	27.135	-19.223	56.000	9.590	0.052	0.000	QP
8		0.730	27.720	18.078	-18.280	46.000	9.590	0.052	0.000	AV
9		0.942	37.229	27.581	-18.771	56.000	9.590	0.058	0.000	QP
10		0.942	28.260	18.612	-17.740	46.000	9.590	0.058	0.000	AV
11		1.602	36.525	26.842	-19.475	56.000	9.602	0.080	0.000	QP
12		1.602	27.554	17.872	-18.446	46.000	9.602	0.080	0.000	AV

Note:

1. " * ", means this data is the worst emission level.
2. Measurement Level = Reading Level + Factor(Probe+Cable-Amp).

Site: TR1	Time: 2017/05/22
Limit: FCC_Part15.107_CE_AC Power_ClassB	Margin: 0
Probe: ENV216-L1	Polarity: Line
EUT: AC1900 Dual Band Gigabit WiFi Router	Power: AC 120V/60Hz
Note: Mode 1: Transmit at channel 2412MHz by 802.11b with Adapter #2	

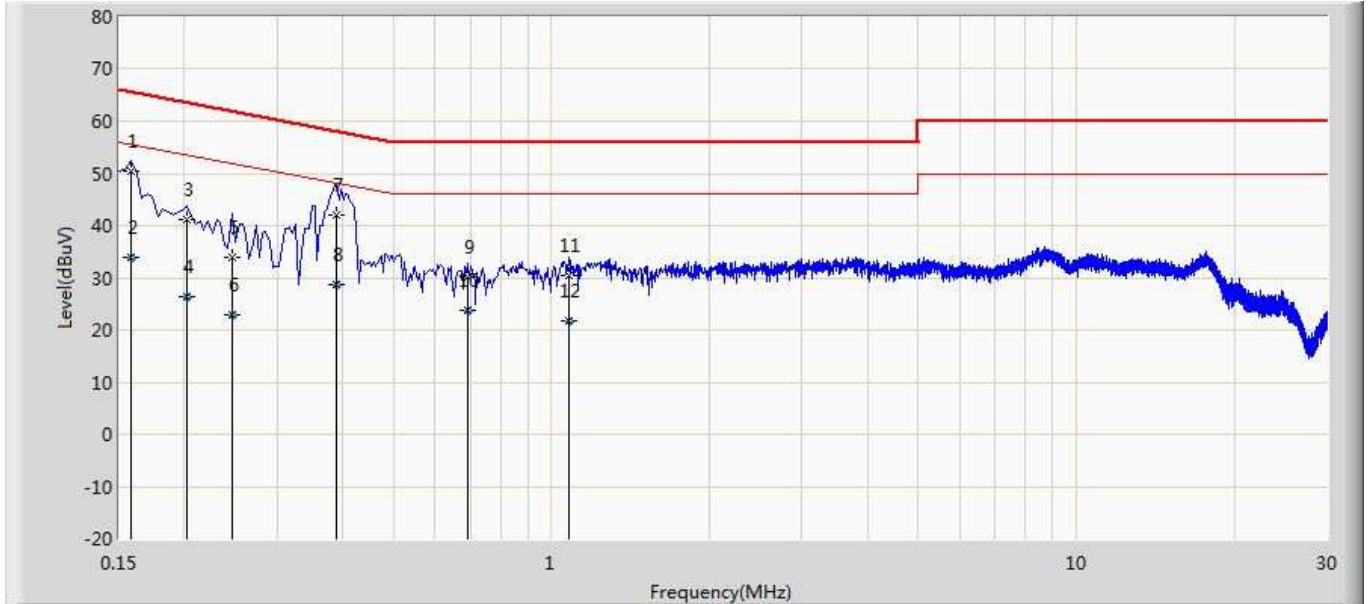

No	Mark	Frequency (MHz)	Measure Level (dBuV)	Reading Level (dBuV)	Over Limit (dB)	Limit (dBuV)	Probe (dB)	Cable (dB)	Amp (dB)	Type
1	*	0.158	50.345	40.614	-15.223	65.568	9.671	0.060	0.000	QP
2		0.158	33.946	24.215	-21.622	55.568	9.671	0.060	0.000	AV
3		0.202	41.168	31.458	-22.360	63.528	9.650	0.060	0.000	QP
4		0.202	26.278	16.568	-27.250	53.528	9.650	0.060	0.000	AV
5		0.246	33.891	24.181	-28.000	61.891	9.650	0.060	0.000	QP
6		0.246	22.863	13.153	-29.028	51.891	9.650	0.060	0.000	AV
7		0.390	42.110	32.410	-15.954	58.064	9.640	0.060	0.000	QP
8		0.390	28.740	19.040	-19.324	48.064	9.640	0.060	0.000	AV
9		0.694	30.025	20.335	-25.975	56.000	9.620	0.070	0.000	QP
10		0.694	23.739	14.049	-22.261	46.000	9.620	0.070	0.000	AV
11		1.082	30.491	20.781	-25.509	56.000	9.630	0.080	0.000	QP
12		1.082	21.629	11.919	-24.371	46.000	9.630	0.080	0.000	AV

Note:

1. " * ", means this data is the worst emission level.
2. Measurement Level = Reading Level + Factor(Probe+Cable-Amp).

Site: TR1	Time: 2017/05/22
Limit: FCC_Part15.107_CE_AC Power_ClassB	Margin: 0
Probe: ENV216-N	Polarity: Neutral
EUT: AC1900 Dual Band Gigabit WiFi Router	Power: AC 120V/60Hz
Note: Mode 1: Transmit at channel 2412MHz by 802.11b with Adapter #2	

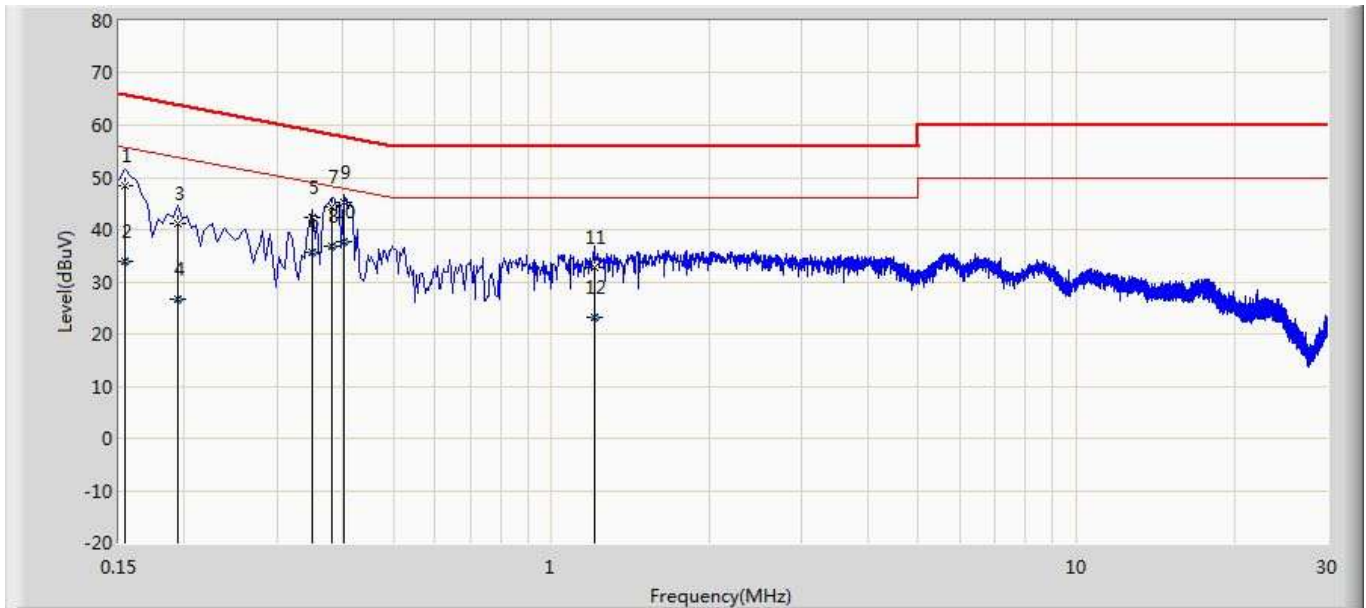

No	Mark	Frequency (MHz)	Measure Level (dBuV)	Reading Level (dBuV)	Over Limit (dB)	Limit (dBuV)	Probe (dB)	Cable (dB)	Amp (dB)	Type
1		0.154	48.432	38.699	-17.349	65.781	9.673	0.060	0.000	QP
2		0.154	33.875	24.142	-21.906	55.781	9.673	0.060	0.000	AV
3		0.194	41.055	31.335	-22.809	63.864	9.660	0.060	0.000	QP
4		0.194	26.660	16.940	-27.204	53.864	9.660	0.060	0.000	AV
5		0.350	42.190	32.484	-16.772	58.962	9.646	0.060	0.000	QP
6		0.350	35.691	25.985	-13.271	48.962	9.646	0.060	0.000	AV
7		0.382	44.385	34.685	-13.851	58.236	9.640	0.060	0.000	QP
8		0.382	36.839	27.139	-11.397	48.236	9.640	0.060	0.000	AV
9		0.402	45.354	35.650	-12.458	57.812	9.640	0.064	0.000	QP
10	*	0.402	37.814	28.110	-9.998	47.812	9.640	0.064	0.000	AV
11		1.206	32.737	23.027	-23.263	56.000	9.630	0.080	0.000	QP
12		1.206	23.086	13.376	-22.914	46.000	9.630	0.080	0.000	AV

Note:

1. " * ", means this data is the worst emission level.
2. Measurement Level = Reading Level + Factor(Probe+Cable-Amp).

4. Emissions in restricted frequency bands

4.1. Test Equipment

Radiated Emission(Below 1GHz) / AC-2					
Instrument	Manufacturer	Type No.	Serial No.	Cal. Date	Cal. Due Date
EMI Test Receiver	R&S	ESCI	100573	2017.03.29	2018.03.28
Loop Antenna	R&S	HFH2-Z2	833799/003	2016.11.16	2017.11.17
Bilog Antenna	Teseq GmbH	CBL6112D	27611	2016.10.16	2017.10.15
Coaxial Cable	Huber+Suhner	SUCOFLEX 106	AC2-C	2017.03.02	2018.03.01
Temperature/Humidity Meter	Zhichen	ZC1-2	AC2-TH	2017.01.04	2018.01.03

Note: All equipments are calibrated with traceable calibrations. Each calibration is traceable to the national or international standards.

Radiated Emission(Above 1GHz) / AC-5					
Instrument	Manufacturer	Type No.	Serial No.	Cal. Date	Cal. Due Date
Spectrum Analyzer	Agilent	E4446A	MY45300103	2017.01.04	2018.01.03
Preamplifier	Miteq	NSP1800-25	1364185	2017.05.06	2018.05.05
Preamplifier	QuieTek	AP-040G	CHM-0906001	2017.05.06	2018.05.05
DRG Horn	ETS-Lindgren	3117	00123988	2017.01.22	2018.01.21
Broad-Band Horn Antenna	Schwarzbeck	BBHA9170	294	2016.11.25	2017.11.24
Coaxial Cable	Huber+Suhner	SUCOFLEX 106	AC5-C1	2017.03.02	2018.03.01
Coaxial Cable	Huber+Suhner	SUCOFLEX 106	AC5-C2	2017.03.02	2018.03.01
Coaxial Cable	Huber+Suhner	SUCOFLEX 102	AC5-C3	2017.03.02	2018.03.01
EMI Receiver	Agilent	N9038A	MY51210196	2017.06.10	2018.06.09
Temperature/Humidity Meter	Zhichen	ZC1-2	AC5-TH	2017.01.04	2018.01.03

Note: All equipments are calibrated with traceable calibrations. Each calibration is traceable to the national or international standards.

4.2. Test Setup

Below 30MHz Test Setup:

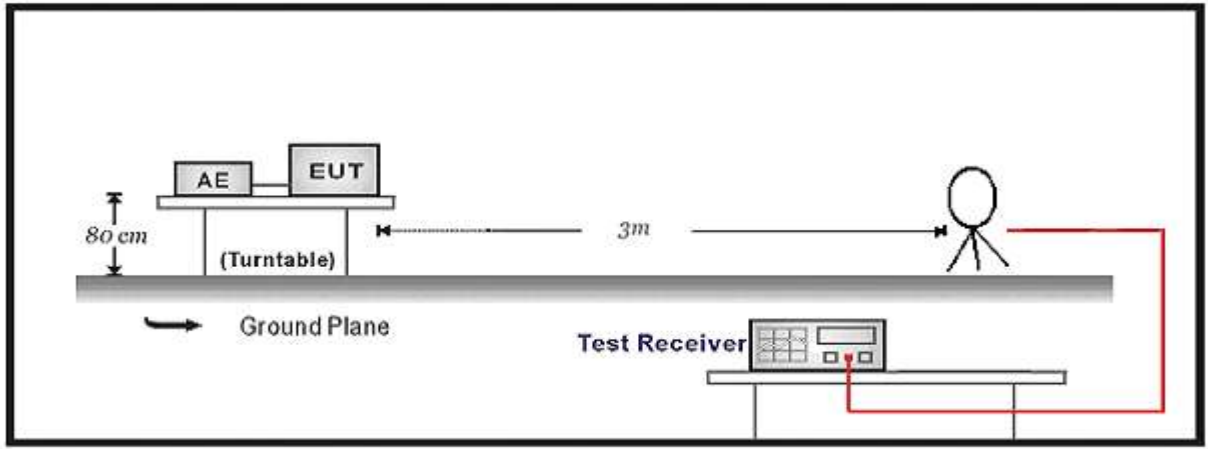

30MHz-1GHz Test Setup:

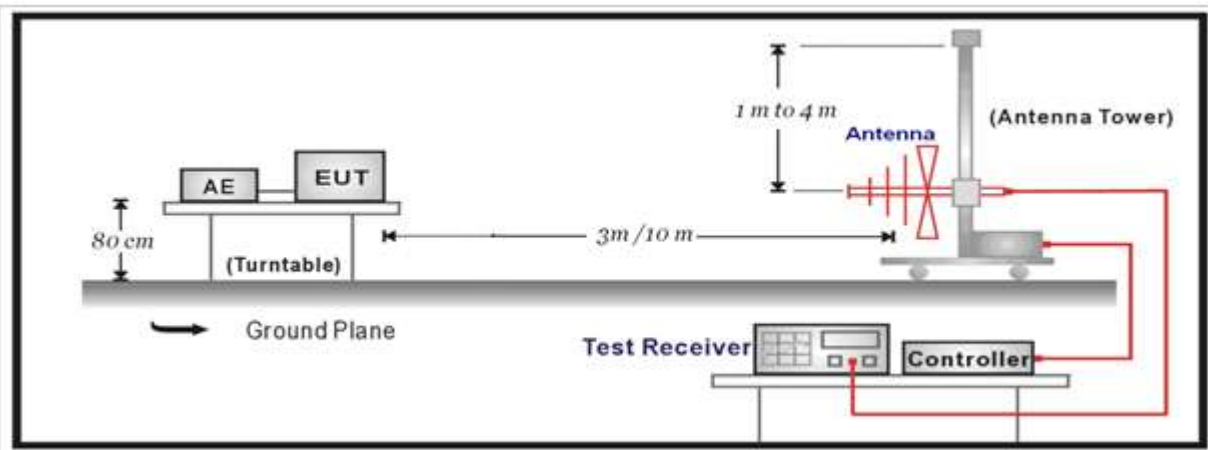

Above 1GHz Test Setup:

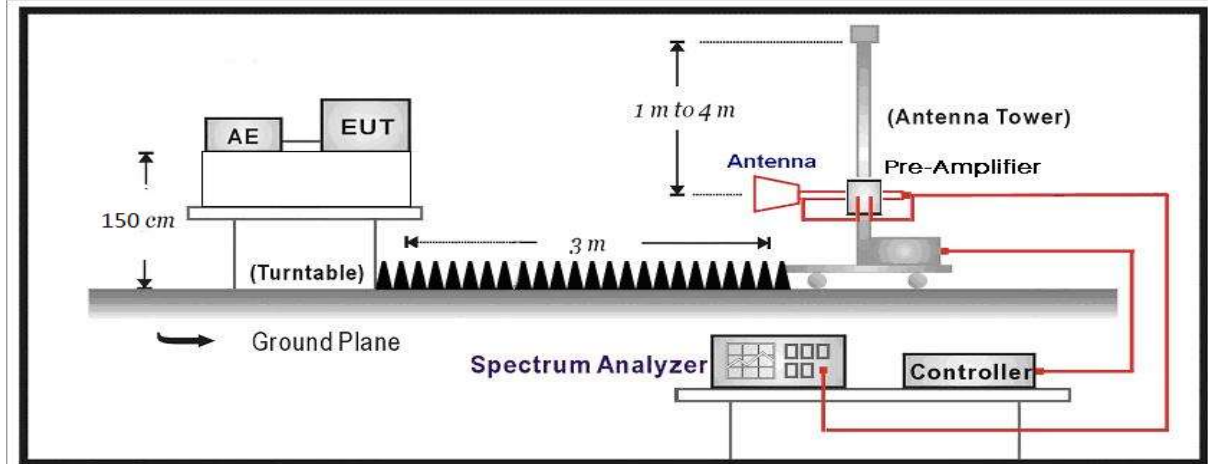

4.3. Limit

Restricted Bands of operation			
Frequency (MHz)	Frequency (MHz)	Frequency (MHz)	Frequency (GHz)
0.090 – 0.110	16.42 – 16.423	399.9 – 410	4.5 – 5.15
0.495 – 0.505	16.69475 – 16.69525	608 – 614	5.35 – 5.46
2.1735 – 2.1905	16.80425 – 16.80475	960 – 1240	7.25 – 7.75
4.125 – 4.128	25.5 – 25.67	1300 – 1427	8.025 – 8.5
4.17725 – 4.17775	37.5 – 38.25	1435 – 1626.5	9.0 – 9.2
4.20725 – 4.20775	73 – 74.6	1645.5 – 1646.5	9.3 – 9.5
6.215 – 6.218	74.8 – 75.2	1660 – 1710	10.6 – 12.7
6.26775 – 6.26825	108 – 121.94	1718.8 – 1722.2	13.25 – 13.4
6.31175 – 6.31225	123 – 138	2200 – 2300	14.47 – 14.5
8.291 – 8.294	149.9 – 150.05	2310 – 2390	15.35 – 16.2
8.362 – 8.366	156.52475 – 156.52525	2483.5 – 2500	17.7 – 21.4
8.37625 – 8.38675	156.7 – 156.9	2690 – 2900	22.01 – 23.12
8.81425 – 8.81475	162.0125 – 167.17	3260 – 3267	23.6 – 24.0
12.29 – 12.293	167.72 – 173.2	3332 – 3339	31.2 – 31.8
12.51975 – 12.52025	240 – 285	3345.8 – 3358	36.43 – 36.5
12.57675 – 12.57725	322 – 335.4	3600 – 4400	
13.36 – 13.41			

Restricted Band Emissions Limit			
Frequency (MHz)	Field strength (μ V/m)	Field strength (dB μ V/m)	Measurement distance (m)
0.009 - 0.49	2400/F(kHz)	48.5 – 13.8	300 _(Note 1)
0.49 - 1.705	24000/F(kHz)	33.8 - 23	30 _(Note 1)
1.705 - 30	30	29.5	30 _(Note 1)
30 - 88	100	40	3 _(Note 2)
88 - 216	150	43.5	3 _(Note 2)
216 - 960	200	46	3 _(Note 2)
Above 960	500	54	3 _(Note 2)



Note 1: At frequencies below 30 MHz, measurements may be performed at a distance closer than that specified in the regulations; however, an attempt should be made to avoid making measurements in the near field. Pending the development of an appropriate measurement procedure for measurements performed below 30 MHz, when performing measurements at a closer distance than specified, the results shall be extrapolated to the specified distance by either making measurements at a minimum of two distances on at least one radial to determine the proper extrapolation factor or by using the square of an inverse linear distance extrapolation factor (40 dB/decade).

Note 2: At frequencies at or above 30 MHz, measurements may be performed at a distance other than what is specified provided: measurements are not made in the near field except where it can be shown that near field measurements are appropriate due to the characteristics of the device; and it can be demonstrated that the signal levels needed to be measured at the distance employed can be detected by the measurement equipment. Measurements shall not be performed at a distance greater than 30 meters unless it can be further demonstrated that measurements at a distance of 30 meters or less are impractical. When performing measurements at a distance other than that specified, the results shall be extrapolated to the specified distance using an extrapolation factor of 20 dB/decade (inverse linear-distance for field strength measurements; inverse-linear-distance-squared for power density measurements).

4.4. Test Procedure

Test Method			
	References Rule	Chapter	Description
<input type="checkbox"/>	ANSI C63.10	11.11	Emissions in non-restricted frequency bands
	<input type="checkbox"/> ANSI C63.10	11.11.2	Reference level measurement
	<input type="checkbox"/> ANSI C63.10	11.11.3	Emission level measurement
<input checked="" type="checkbox"/>	ANSI C63.10	11.12	Emissions in restricted frequency bands
	<input checked="" type="checkbox"/> ANSI C63.10	11.12.1	Radiated emission measurements
	<input checked="" type="checkbox"/> ANSI C63.10	11.12.2.7	Radiated spurious emission test
	<input checked="" type="checkbox"/> ANSI C63.10	6.4	Radiated emissions from unlicensed wireless devices below 30 MHz
	<input checked="" type="checkbox"/> ANSI C63.10	6.5	Radiated emissions from unlicensed wireless devices in the frequency range of 30 MHz to 1000 MHz
	<input checked="" type="checkbox"/> ANSI C63.10	6.6	Radiated emissions from unlicensed wireless devices above 1 GHz
	<input type="checkbox"/> ANSI C63.10	11.12.2.3	Quasi-peak measurement procedure
	<input checked="" type="checkbox"/> ANSI C63.10	11.12.2.4	Peak power measurement procedure
	<input checked="" type="checkbox"/> ANSI C63.10	11.12.2.5	Average power measurement procedures
	<input type="checkbox"/> ANSI C63.10	11.12.2.5.1	Trace averaging with continuous EUT transmission at full power
	<input type="checkbox"/> ANSI C63.10	11.12.2.5.2	Trace averaging across ON and OFF times of the EUT transmissions followed by duty cycle correction
	<input checked="" type="checkbox"/> ANSI C63.10	11.12.2.5.3	Reduced VBW averaging across ON and OFF times of the EUT transmissions with max hold

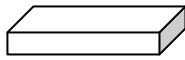
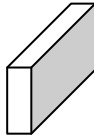
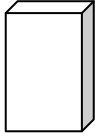
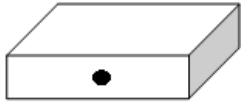
4.5. EUT test Axis definition

Item	Emissions in restricted frequency bands			
Device Category	<input checked="" type="checkbox"/>	Fixed position use		
	<input type="checkbox"/>	Mobile position use		
Test mode	Mode 1~4			
Test method	<input checked="" type="checkbox"/>	Radiated		
		X Axis	Y Axis	Z Axis
				
		Worst Axis <input checked="" type="checkbox"/>	Worst Axis <input type="checkbox"/>	Worst Axis <input type="checkbox"/>
	<input type="checkbox"/>	Conducted		
	<input type="checkbox"/>	Chain 1		
				
	<input type="checkbox"/>	Chain 1	Chain 2	
				
	<input type="checkbox"/>	Chain 1	Chain 2	Chain 3
				

4.6. Test Result

Product Name	: AC1900 Smart Wi-Fi Router	Power	: AC 120V/60Hz
Test Mode	: Mode 1	Test Site	: AC-5
Test Date	: 2017.04.28		

Chain	CH	Antenna Polarity	Frequency (MHz)	Reading Level (dB μV)	Factor (dB)	Measured Level (dB μV/m)	Limit (dB μV/m)	Over Limt (dB)	Detector
Ant 1+2+3	1	H	4825.00	46.47	4.96	51.43	54(note3)	-2.57	PK
		H	7236.00	38.05	9.15	47.20	54(note3)	-6.80	PK
		H	9648.00	36.19	11.39	47.58	54(note3)	-6.42	PK
		V	4825.00	47.66	4.96	52.62	54(note3)	-1.38	PK
		V	7236.00	36.05	9.15	45.20	54(note3)	-8.80	PK
		V	9648.00	36.58	11.39	47.97	54(note3)	-6.03	PK
	6	H	4876.00	45.27	5.22	50.49	54(note3)	-3.51	PK
		H	7311.00	36.61	8.96	45.57	54(note3)	-8.43	PK
		H	9748.00	37.31	11.56	48.87	54(note3)	-5.13	PK
		V	4874.00	43.56	5.18	48.74	54	-5.26	AV
		V	4876.00	50.60	5.22	55.82	74	-18.18	PK
		V	7311.00	36.70	8.96	45.66	54(note3)	-8.34	PK
	11	V	9748.00	37.11	11.56	48.67	54(note3)	-5.33	PK
		H	4927.00	42.44	5.27	47.71	54(note3)	-6.29	PK
		H	7386.00	36.07	8.77	44.84	54(note3)	-9.16	PK
		H	9848.00	33.85	11.94	45.79	54(note3)	-8.21	PK
		V	4924.00	43.11	5.27	48.38	54	-5.62	AV
		V	4927.00	49.01	5.27	54.28	74	-19.72	PK
		V	7386.00	36.26	8.76	45.02	54(note3)	-8.98	PK
	V	9848.00	33.94	11.94	45.88	54(note3)	-8.12	PK	

Note: 1. Measure Level = Reading Level + Factor.

Note: 2. The test frequency range, 9kHz~30MHz, 18GHz~25GHz, both of the worst case are at least 6dB below the limits, therefore no data appear in the report.

Note: 3. This limit applies for using average detector, if the test result on peak is lower than average limit, then average measurement needn't be performed.

Note: 4. The RBW setting, see Clause 6.6.

Product Name	: AC1900 Smart Wi-Fi Router	Power	: AC 120V/60Hz
Test Mode	: Mode 2	Test Site	: AC-5
Test Date	: 2017.04.28		

Chain	CH	Antenna Polarity	Frequency (MHz)	Reading Level (dB μ V)	Factor (dB)	Measured Level (dB μ V/m)	Limit (dB μ V/m)	Over Limt (dB)	Detector
Ant 1+2+3	1	H	4816.50	56.78	4.94	61.72	54(note3)	-12.28	PK
		H	4821.21	47.48	4.95	52.43	54(note3)	-1.57	PK
		H	7239.00	44.26	9.15	53.41	54(note3)	-0.59	PK
		H	9648.00	36.24	11.39	47.63	54(note3)	-6.37	PK
		V	4821.00	41.68	4.95	46.63	54	-7.37	AV
		V	4825.00	51.64	4.96	56.60	74	-17.40	PK
		V	7230.50	45.78	9.15	54.93	74	-19.07	PK
		V	7235.76	33.48	9.15	42.63	54	-11.37	AV
		V	9648.00	36.61	11.38	47.99	54(note3)	-6.01	PK
	6	H	4867.50	58.51	5.07	63.58	74	-10.42	PK
		H	4870.75	47.21	5.13	52.34	54	-1.66	PK
		H	7307.00	40.80	8.84	49.64	54(note3)	-4.36	AV
		H	9748.00	36.15	11.56	47.71	54(note3)	-26.29	PK
		V	4874.00	44.08	5.18	49.26	54	-24.74	AV
		V	4876.00	54.42	5.22	59.64	74	-14.36	PK
		V	7307.00	42.92	8.84	51.76	54(note3)	-2.24	PK
		V	9748.00	35.61	11.57	47.18	54(note3)	-6.82	PK
	11	H	4918.50	54.53	5.27	59.80	54(note3)	-14.20	PK
		H	4920.84	45.02	5.27	50.29	54(note3)	-3.71	PK
		H	7383.50	41.16	8.80	49.96	54(note3)	-4.04	PK
		H	9848.00	33.70	11.93	45.63	54(note3)	-8.37	PK
		V	4924.00	42.80	5.27	48.07	54	-5.93	AV
		V	4927.00	56.11	5.28	61.39	74	-12.61	PK
		V	7383.50	41.75	8.80	50.55	54(note3)	-3.45	PK
		V	9848.00	33.41	11.94	45.35	54(note3)	-8.65	PK

Note: 1. Measure Level = Reading Level + Factor.

Note: 2. The test frequency range, 9kHz~30MHz, 18GHz~25GHz, both of the worst case are at least 6dB below the limits, therefore no data appear in the report.

Note: 3. This limit applies for using average detector, if the test result on peak is lower than average limit, then average measurement needn't be performed.

Note: 4. We have evaluated three antennas, shown in the report is the worst data.

Note: 5. The RBW setting, see Clause 6.6.

Product Name	: AC1900 Smart Wi-Fi Router	Power	: AC 120V/60Hz
Test Mode	: Mode 3	Test Site	: AC-5
Test Date	: 2017.04.28		

Chain	CH	Antenna Polarity	Frequency (MHz)	Reading Level (dB μ V)	Factor (dB)	Measured Level (dB μ V/m)	Limit (dB μ V/m)	Over Limt (dB)	Detector
Ant 1+2+3	1	H	4816.50	57.07	4.94	62.01	74	-11.99	PK
		H	4820.00	47.43	4.95	52.38	54	-1.62	AV
		H	7230.50	43.23	9.15	52.38	54(note3)	-1.62	PK
		H	9648.00	36.44	11.38	47.82	54(note3)	-6.18	PK
		V	4816.00	41.00	4.94	45.94	54	-8.06	AV
		V	4816.50	50.07	4.95	55.02	74	-18.98	PK
		V	7222.00	44.05	9.16	53.21	54(note3)	-0.79	PK
		V	9648.00	36.23	11.39	47.62	54(note3)	-6.38	PK
	6	H	4867.50	57.52	5.08	62.60	74	-11.40	PK
		H	4870.00	47.33	5.12	52.45	54	-1.55	AV
		H	7315.50	41.97	9.09	51.06	54(note3)	-2.94	PK
		H	9748.00	35.56	11.57	47.13	54(note3)	-6.87	PK
		V	4875.00	43.02	5.20	48.22	54	-5.78	AV
		V	4876.00	54.27	5.22	59.49	74	-14.51	PK
		V	7298.50	44.39	8.88	53.27	54(note3)	-0.73	PK
		V	9748.00	36.51	11.57	48.08	54(note3)	-5.92	PK
	11	H	4920.00	45.05	5.27	50.32	54	-3.68	V
		H	4927.00	56.67	5.28	61.95	74	-12.05	PK
		H	7386.00	38.69	8.76	47.45	54(note3)	-6.55	PK
		H	9848.00	33.36	11.93	45.29	54(note3)	-8.71	PK
		V	4924.00	41.00	5.27	46.27	54	-7.73	AV
		V	4927.00	54.27	5.28	59.55	74	-14.45	PK
		V	7375.00	43.39	8.94	52.33	54(note3)	-1.67	PK
		V	9848.00	33.83	11.93	45.76	54(note3)	-8.24	PK

Note: 1. Measure Level = Reading Level + Factor.

Note: 2. The test frequency range, 9kHz~30MHz, 18GHz~25GHz, both of the worst case are at least 6dB below the limits, therefore no data appear in the report.

Note: 3. This limit applies for using average detector, if the test result on peak is lower than average limit, then average measurement needn't be performed.

Note: 4. The RBW setting, see Clause 6.6.

Product Name	: AC1900 Smart Wi-Fi Router	Power	: AC 120V/60Hz
Test Mode	: Mode 4	Test Site	: AC-5
Test Date	: 2017.04.28		

Chain	CH	Antenna Polarity	Frequency (MHz)	Reading Level (dB μ V)	Factor (dB)	Measured Level (dB μ V/m)	Limit (dB μ V/m)	Over Limt (dB)	Detector
Ant 1+2+3	3	H	4833.50	49.11	5.05	54.16	74	-19.84	PK
		H	4844.00	43.51	5.11	48.62	54	-5.38	AV
		H	7256.00	41.31	9.22	50.53	54(note3)	-3.47	PK
		H	9688.00	35.76	11.92	47.68	54(note3)	-6.32	PK
		V	4842.00	57.14	5.14	62.28	74	-11.72	PK
		V	4844.00	45.66	5.11	50.77	54	-3.23	AV
		V	7264.50	40.38	8.99	49.37	54(note3)	-4.63	PK
		V	9688.00	36.00	11.92	47.92	54(note3)	-6.08	PK
	6	H	4874.00	46.78	5.18	51.96	54	-2.04	V
		H	4893.00	55.78	5.12	60.90	74	-13.10	PK
		H	7311.00	36.40	8.96	45.36	54(note3)	-8.64	PK
		H	9748.00	34.64	11.57	46.21	54(note3)	-7.79	PK
		V	4874.00	43.72	5.18	48.90	54	-5.10	AV
		V	4893.00	51.92	5.11	57.03	74	-16.97	PK
		V	7332.50	39.73	9.46	49.19	54(note3)	-4.81	PK
		V	9748.00	35.80	11.57	47.37	54(note3)	-6.63	PK
	9	H	4876.00	53.00	5.22	58.22	74	-15.78	PK
		H	4904.00	44.26	5.21	49.47	54	-4.53	V
		H	7356.00	37.19	9.48	46.67	54(note3)	-7.33	PK
		H	9808.00	35.80	11.27	47.07	54(note3)	-6.93	PK
		V	4901.50	51.28	5.19	56.47	74	-17.53	PK
		V	4904.00	43.51	5.21	48.72	54	-5.28	AV
		V	7356.00	38.43	9.49	47.92	54(note3)	-6.08	PK
		V	9808.00	34.76	11.27	46.03	54(note3)	-7.97	PK

Note: 1. Measure Level = Reading Level + Factor.

Note: 2. The test frequency range, 9kHz~30MHz, 18GHz~25GHz, both of the worst case are at least 6dB below the limits, therefore no data appear in the report.

Note: 3. This limit applies for using average detector, if the test result on peak is lower than average limit, then average measurement needn't be performed.

Note: 4. The RBW setting, see Clause 6.6.

The worst case of Radiated Emission below 1GHz:

Site: AC2	Time: 2017/05/19
Limit: FCC_Part15.109_RE(3m)_ClassB	Margin: 0
Probe: AC2_CBL6112_0726	Polarity: Horizontal
EUT: AC1900 dual band gigabit wifi router	Power: AC 120V/60Hz
Note: Mode 1: Transmit at channel 2412MHz by 802.11b with Adapter #2	

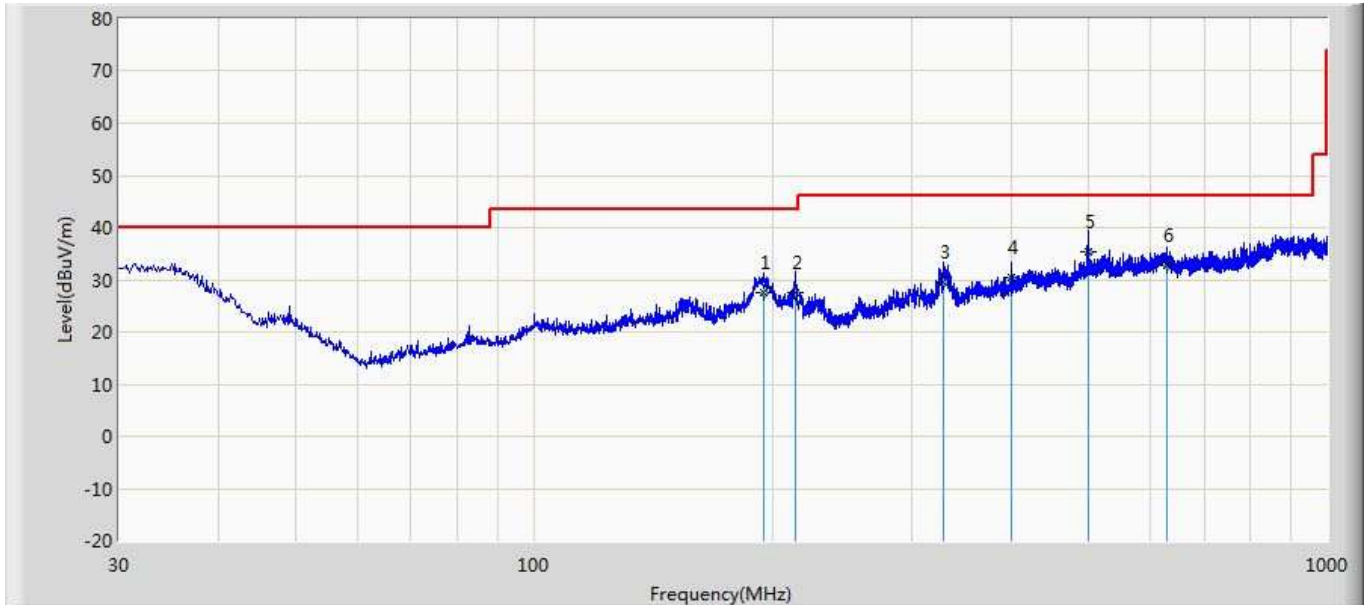

No	Mark	Frequency (MHz)	Measure Level (dBuV/m)	Reading Level (dBuV)	Over Limit (dB)	Limit (dBuV/m)	Probe (dB/m)	Cable (dB)	Amp (dB)	Ant Pos (cm)	Table Pos (deg)	Type
1		195.343	27.520	39.800	-15.980	43.500	9.360	1.520	23.160	100	120	QP
2		213.753	27.542	39.945	-15.958	43.500	9.237	1.580	23.220	100	210	QP
3		328.983	29.671	36.515	-16.329	46.000	14.154	1.962	22.960	200	320	QP
4		399.743	30.506	35.331	-15.494	46.000	15.993	2.212	23.030	100	331	QP
5	*	499.563	35.390	37.936	-10.610	46.000	17.794	2.420	22.760	100	166	QP
6		627.266	32.758	33.521	-13.242	46.000	19.000	2.750	22.513	100	87	QP

Note:

1. " * ", means this data is the worst emission level.
2. Measurement Level = Reading Level + Factor(Probe+Cable-Amp).

Site: AC2	Time: 2017/05/19
Limit: FCC_Part15.109_RE(3m)_ClassB	Margin: 0
Probe: AC2_CBL6112_0726	Polarity: Vertical
EUT: AC1900 dual band gigabit wifi router	Power: AC 120V/60Hz
Note: Mode 1: Transmit at channel 2412MHz by 802.11b with Adapter #2	

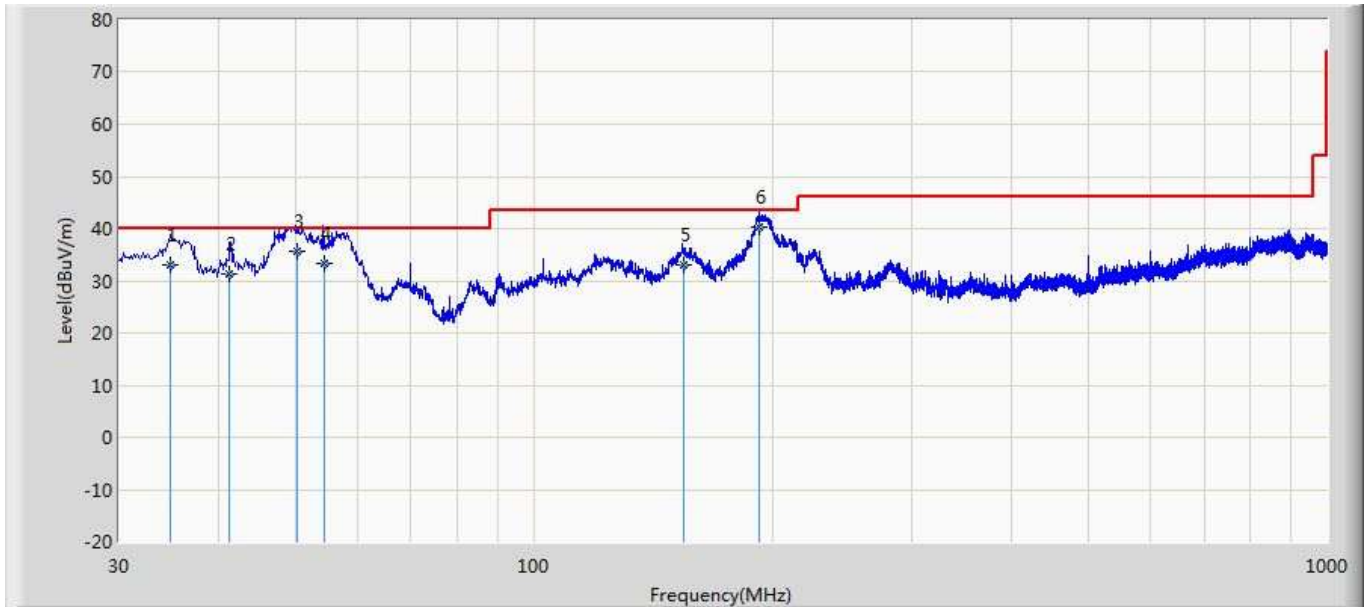

No	Mark	Frequency (MHz)	Measure Level (dBuV/m)	Reading Level (dBuV)	Over Limit (dB)	Limit (dBuV/m)	Probe (dB/m)	Cable (dB)	Amp (dB)	Ant Pos (cm)	Table Pos (deg)	Type
1		34.864	33.076	39.627	-6.924	40.000	15.979	0.640	23.170	200	178	QP
2		41.388	31.316	41.673	-8.684	40.000	12.223	0.697	23.277	100	360	QP
3		50.289	35.517	49.628	-4.483	40.000	8.162	0.779	23.053	100	310	QP
4		54.354	33.330	48.089	-6.670	40.000	7.460	0.801	23.020	100	16	QP
5		154.243	33.136	44.551	-10.364	43.500	10.245	1.350	23.010	100	295	QP
6	*	192.746	40.196	52.556	-3.304	43.500	9.283	1.508	23.150	100	98	QP

Note:

1. " * ", means this data is the worst emission level.
2. Measurement Level = Reading Level + Factor(Probe+Cable-Amp).

5. Emissions in non-restricted frequency bands

5.1. Test Equipment

Occupied Bandwidth / TR-8					
Instrument	Manufacturer	Type No.	Serial No.	Cal. Date	Cal. Due Date
Spectrum Analyzer	Agilent	N9010A	MY48030494	2017.02.04	2018.02.04
EXA Spectrum Analyzer	Keysight	N9010A	MY55370495	2017.04.09	2018.04.09
MXA Signal Analyzer	Keysight	N9020A	MY56060147	2017.04.09	2018.04.09
Temperature/Humidity Meter	zhichen	ZC1-2	TR8-TH	2017.04.10	2018.04.10

Note: All equipments are calibrated with traceable calibrations. Each calibration is traceable to the national or international standards.

5.2. Test Setup

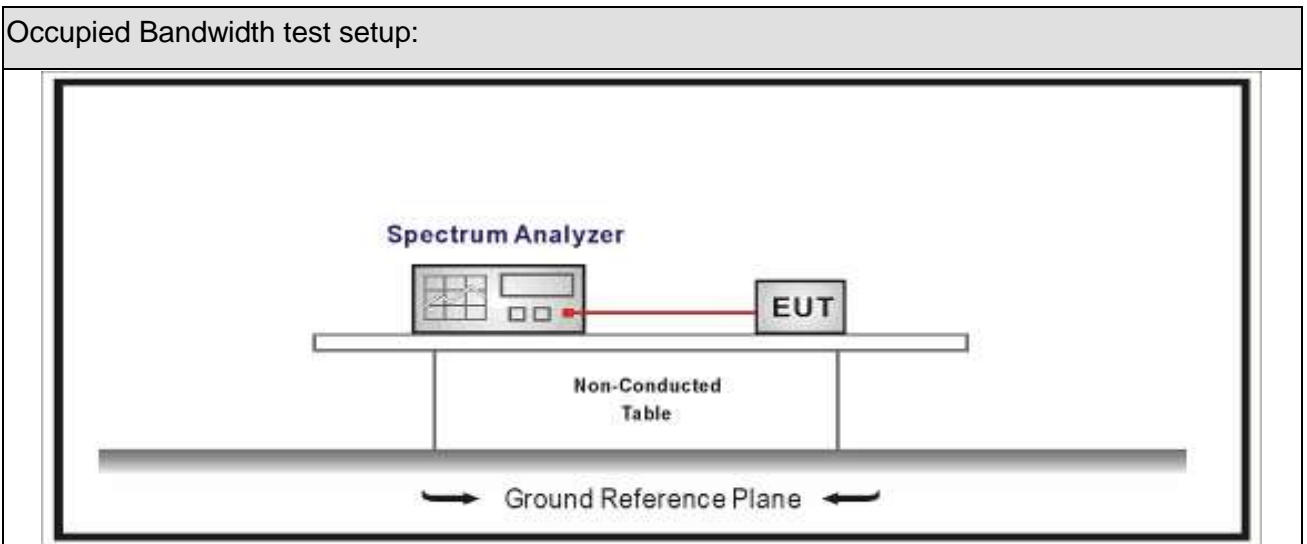



5.3. Limit

Un-Restricted Band Emissions Limit	
RF Output power (Detection methods)	Limit(dB)
RF Output power(Average detector)	30c(Note1)
RF Output power(PK detector)	20c(Note2)
<p>Note 1: If maximum conducted (average) output power was used to demonstrate compliance as described in 9.2, then the peak power in any 100 kHz bandwidth outside of the authorized frequency band shall be attenuated by at least 30 dB relative to the maximum in-band peak PSD level in 100 kHz (i.e., 30 dBc).</p> <p>Note 2: If the maximum peak conducted output power procedure was used, then the peak output power measured in any 100 kHz bandwidth outside of the authorized frequency band shall be attenuated by at least 20 dB relative to the maximum in-band peak PSD level in 100 kHz (i.e., 20 dBc).</p>	

5.4. Test Procedure

Test Method			
	References Rule	Chapter	Description
<input checked="" type="checkbox"/>	ANSI C63.10	11.11	Emissions in non-restricted frequency bands
	<input checked="" type="checkbox"/> ANSI C63.10	11.11.2	Reference level measurement
	<input checked="" type="checkbox"/> ANSI C63.10	11.11.3	Emission level measurement
<input type="checkbox"/>	ANSI C63.10	11.12	Emissions in restricted frequency bands
	<input type="checkbox"/> ANSI C63.10	11.12.1	Radiated emission measurements
	<input type="checkbox"/> ANSI C63.10	11.12.2.7	Radiated spurious emission test
<input type="checkbox"/>	ANSI C63.10	6.4	Radiated emissions from unlicensed wireless devices below 30 MHz
<input type="checkbox"/>	ANSI C63.10	6.5	Radiated emissions from unlicensed wireless devices in the frequency range of 30 MHz to 1000 MHz
<input checked="" type="checkbox"/>	ANSI C63.10	6.6	Radiated emissions from unlicensed wireless devices above 1 GHz
	<input checked="" type="checkbox"/> ANSI C63.10	11.12.2	Antenna-port conducted measurements
	<input type="checkbox"/> ANSI C63.10	11.12.2.3	Quasi-peak measurement procedure
	<input checked="" type="checkbox"/> ANSI C63.10	11.12.2.4	Peak power measurement procedure
	<input type="checkbox"/> ANSI C63.10	11.12.2.5	Average power measurement procedures
	<input type="checkbox"/> ANSI C63.10	11.12.2.5.1	Trace averaging with continuous EUT transmission at full power
	<input type="checkbox"/> ANSI C63.10	11.12.2.5.2	Trace averaging across ON and OFF times of the EUT transmissions followed by duty cycle correction
	<input type="checkbox"/> ANSI C63.10	11.12.2.5.3	Reduced VBW averaging across ON and OFF times of the EUT transmissions with max hold

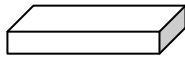
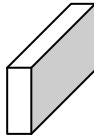
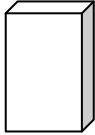
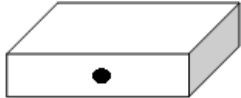
5.5. EUT test Axis definition

Item	Emissions in non-restricted frequency bands			
Device Category	<input checked="" type="checkbox"/>	Fixed position use		
	<input type="checkbox"/>	Mobile position use		
Test mode	Mode 1 ~ Mode 4			
Test method	<input type="checkbox"/>	Radiated		
		X Axis	Y Axis	Z Axis
				
		Worst Axis <input type="checkbox"/>	Worst Axis <input type="checkbox"/>	Worst Axis <input type="checkbox"/>
	<input checked="" type="checkbox"/>	Conducted		
	<input checked="" type="checkbox"/>	Chain 0		
				
	<input type="checkbox"/>	Chain 0	Chain 1	
				
	<input type="checkbox"/>	Chain 0	Chain 1	Chain 2
				

5.6. Test Result

Product Name	: AC1900 Smart Wi-Fi Router	Power	: AC 120V / 60Hz
Test Mode	: Mode1~4	Test Site	: TR8
Test Date	: 2017.03.28		

Antenna #1

Mode	Channel	Test Frequency (MHz)	In-Band PSD[a] (dBm/100kHz)	Frequency (MHz)	Out-Band PSD[b] (dBm/100kHz)	[a]-[b] (dB)	Limit (dB)	Result
1	01	2412	14.818	2400	-36.501	51.319	>30	Pass
1	11	2462	14.079	2483.5	-49.818	63.897	>30	Pass
2	01	2412	2.966	2400	-30.788	33.754	>30	Pass
2	11	2462	2.818	2483.5	-50.057	52.875	>30	Pass
3	01	2412	1.640	2400	-29.968	31.608	>30	Pass
3	11	2462	2.146	2483.5	-50.487	52.633	>30	Pass
4	03	2422	-1.765	2400	-32.789	31.024	>30	Pass
4	09	2452	-1.080	2483.5	-50.379	49.299	>30	Pass

Antenna #2

Mode	Channel	Test Frequency (MHz)	In-Band PSD[a] (dBm/100kHz)	Frequency (MHz)	Out-Band PSD[b] (dBm/100kHz)	[a]-[b] (dB)	Limit (dB)	Result
2	01	2412	3.277	2400	-31.017	34.294	>30	Pass
2	11	2462	3.490	2483.5	-51.187	54.677	>30	Pass
3	01	2412	1.729	2400	-31.152	32.881	>30	Pass
3	11	2462	1.853	2483.5	-51.052	52.905	>30	Pass
4	03	2422	-1.601	2400	-32.631	31.03	>30	Pass
4	09	2452	-0.686	2483.5	-50.214	49.528	>30	Pass

Antenna #3

Mode	Channel	Test Frequency (MHz)	In-Band PSD[a] (dBm/100kHz)	Frequency (MHz)	Out-Band PSD[b] (dBm/100kHz)	[a]-[b] (dB)	Limit (dB)	Result
2	01	2412	3.490	2400	-29.790	33.28	>30	Pass
2	11	2462	3.280	2483.5	-49.198	52.478	>30	Pass
3	01	2412	2.302	2400	-30.391	32.693	>30	Pass
3	11	2462	2.260	2483.5	-48.133	50.393	>30	Pass
4	03	2422	-1.206	2400	-32.788	31.582	>30	Pass
4	09	2452	-0.323	2483.5	-49.117	48.794	>30	Pass

6. Radiated Emission Band Edge

6.1. Test Equipment

Radiated Emission(Above 1GHz) / AC-5					
Instrument	Manufacturer	Type No.	Serial No.	Cal. Date	Cal. Due Date
EMI Receiver	Agilent	N9038A	MY51210196	2016.07.16	2017.07.16
Pre-Amplifier	Miteq	NSP1800-25	1364185	2017.05.03	2018.05.03
DRG Horn Antenna	ETS-Lindgren	3117	00167055	2016.07.12	2017.07.12
Broad-Band Horn Antenna	Schwarzbeck	BBHA9170	294	2016.09.18	2017.09.18
Coaxial Cable	Huber+Suhner	SUCOFLEX 106	AC5-C1	2017.02.28	2018.02.28
Coaxial Cable	Huber+Suhner	SUCOFLEX 106	AC5-C2	2017.02.28	2018.02.28
Temperature/Humidity Meter	Zhichen	ZC1-2	AC5-TH	2017.01.05	2018.01.05

Note: All equipments are calibrated with traceable calibrations. Each calibration is traceable to the national or international standards.

6.2. Test Setup

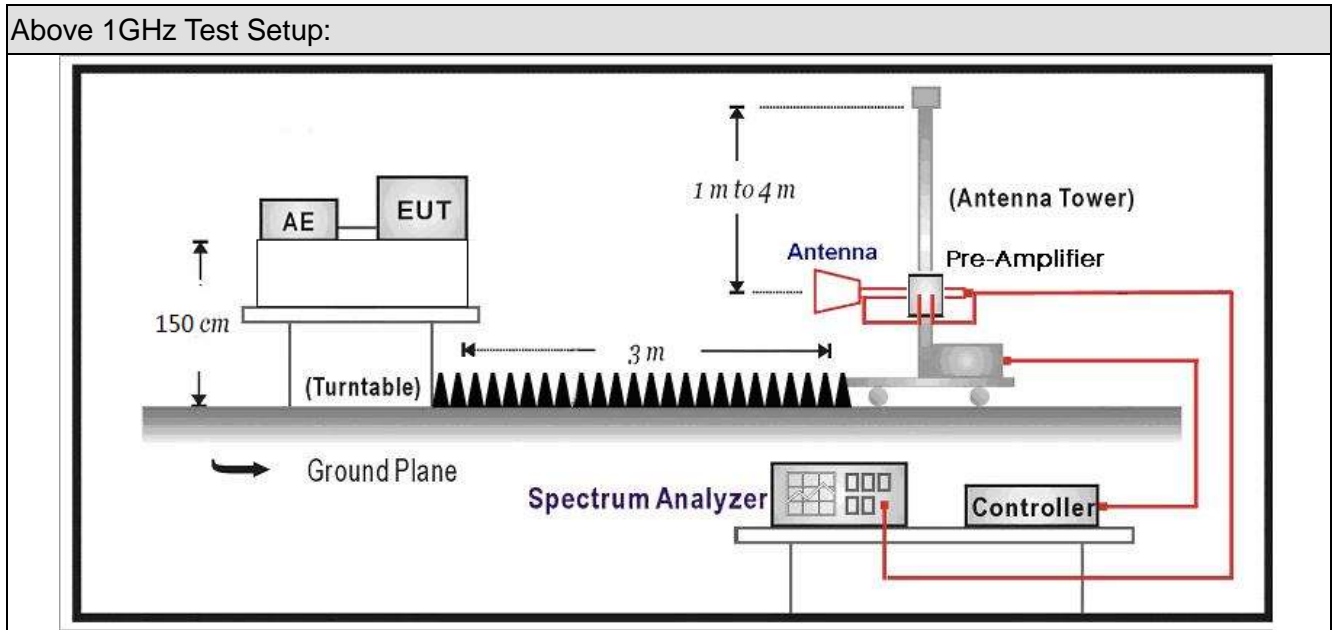

6.3. Limit



Band edge Limit				
Frequency bands (MHz)	Detector	Limit (dB μ V/m)	RBW (MHz)	Distance (m)
2310-2390	PK	74	1	3
2483.5-2500	AV	54	1	3

Note: The field strength of emissions appearing within these frequency bands shall not exceed the limits.

6.4. Test Procedure

Test Method			
	References Rule	Chapter	Description
<input checked="" type="checkbox"/>	ANSI C63.10	6.10	Band-edge testing
	<input checked="" type="checkbox"/> ANSI C63.10	6.10.5	Restricted-band band-edge measurements
	<input type="checkbox"/> ANSI C63.10	6.10.6	Marker-delta method
<input checked="" type="checkbox"/>	ANSI C63.10	11.12	Emissions in restricted frequency bands
	<input checked="" type="checkbox"/> ANSI C63.10	11.12.1	Radiated emission measurements
	<input checked="" type="checkbox"/> ANSI C63.10	11.12.2.7	Radiated spurious emission test
<input type="checkbox"/>	ANSI C63.10	6.4	Radiated emissions from unlicensed wireless devices below 30 MHz
<input type="checkbox"/>	ANSI C63.10	6.5	Radiated emissions from unlicensed wireless devices in the frequency range of 30 MHz to 1000 MHz
<input checked="" type="checkbox"/>	ANSI C63.10	6.6	Radiated emissions from unlicensed wireless devices above 1 GHz
	<input type="checkbox"/> ANSI C63.10	11.12.2.3	Quasi-peak measurement procedure
	<input checked="" type="checkbox"/> ANSI C63.10	11.12.2.4	Peak power measurement procedure
	<input checked="" type="checkbox"/> ANSI C63.10	11.12.2.5	Average power measurement procedures
	<input type="checkbox"/> ANSI C63.10	11.12.2.5.1	Trace averaging with continuous EUT transmission at full power
	<input type="checkbox"/> ANSI C63.10	11.12.2.5.2	Trace averaging across ON and OFF times of the EUT transmissions followed by duty cycle correction
	<input checked="" type="checkbox"/> ANSI C63.10	11.12.2.5.3	Reduced VBW averaging across ON and OFF times of the EUT transmissions with max hold

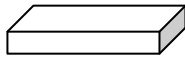
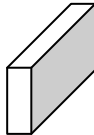
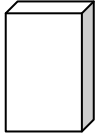
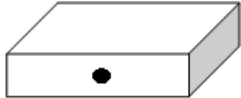
6.5. EUT test definition

Item	Emissions in non-restricted frequency bands			
Device Category	<input checked="" type="checkbox"/>	Fixed position use		
	<input type="checkbox"/>	Mobile position use		
Test mode	Mode 1~4			
Test method	<input checked="" type="checkbox"/>	Radiated		
		X Axis	Y Axis	Z Axis
				
		Worst Axis <input checked="" type="checkbox"/>	Worst Axis <input type="checkbox"/>	Worst Axis <input type="checkbox"/>
	<input type="checkbox"/>	Conducted		
	<input type="checkbox"/>	Chain 1		
				
	<input type="checkbox"/>	Chain 1	Chain 2	
				
	<input type="checkbox"/>	Chain 1	Chain 2	Chain 3
				

6.6. Duty Cycle

Test Mode	Tx On (ms)	Tx Off (ms)	VBW	Tx On + Tx Off (ms)	Duty Cycle
802.11b	N/A	N/A	10Hz	N/A	100%
802.11g	1.386	0.038	1.1KHz	1.424	97.33%
802.11n(20MHz)	1.295	0.038	1.1KHz	1.333	97.15%
802.11n(40MHz)	0.631	0.042	3KHz	0.673	93.76%

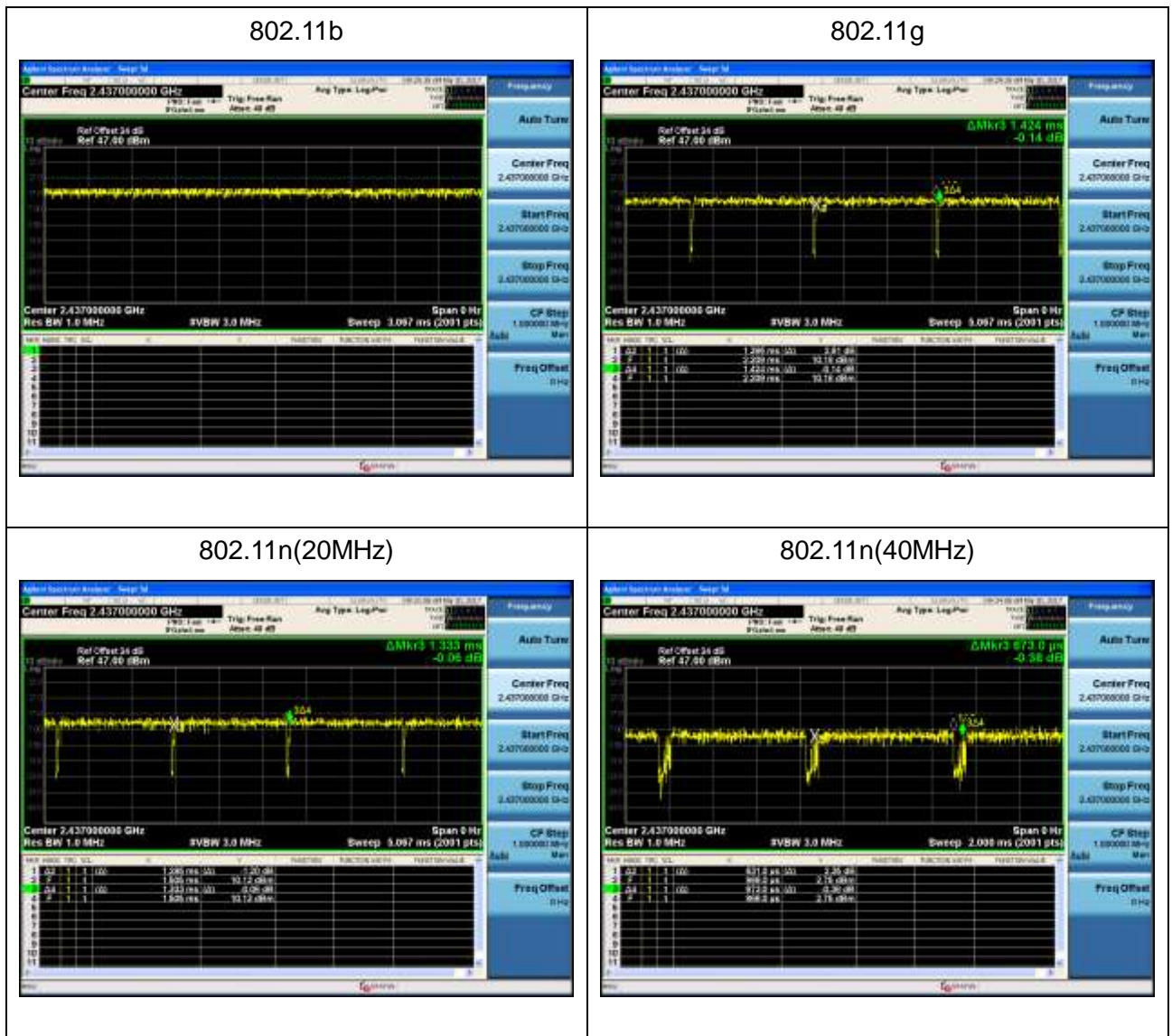

6.7. Test Result

Engineer: Eric	
Site: AC5	Time: 2017/03/22 - 21:53
Limit: FCC_Part15.209_RE(3m)	Margin: 0
Probe: Horn_3117_00167055(1-18GHz)	Polarity: Horizontal
EUT: AC1900 Smart Wi-Fi Router	Power: AC 120V/60Hz
Note: Mode 1:Transmit at 2412MHz by 11b with Adapter #2	



No	Mark	Frequency (MHz)	Measure Level (dBuV/m)	Reading Level (dBuV)	Over Limit (dB)	Limit (dBuV/m)	Factor (dB)	Type
1		2390.000	56.542	20.860	-17.458	74.000	35.682	PK
2	*	2412.088	106.892	71.150	32.892	74.000	35.741	PK

Engineer: Eric	
Site: AC5	Time: 2017/03/22 - 21:58
Limit: FCC_Part15.209_RE(3m)	Margin: 0
Probe: Horn_3117_00167055(1-18GHz)	Polarity: Horizontal
EUT: AC1900 Smart Wi-Fi Router	Power: AC 120V/60Hz
Note: Mode 1:Transmit at 2412MHz by 11b with Adapter #2	



No	Mark	Frequency (MHz)	Measure Level (dBuV/m)	Reading Level (dBuV)	Over Limit (dB)	Limit (dBuV/m)	Factor (dB)	Type
1		2390.000	47.331	11.649	-6.669	54.000	35.682	AV
2	*	2411.248	100.595	64.857	46.595	54.000	35.738	AV

Engineer: Eric	
Site: AC5	Time: 2017/03/22 - 22:00
Limit: FCC_Part15.209_RE(3m)	Margin: 0
Probe: Horn_3117_00167055(1-18GHz)	Polarity: Vertical
EUT: AC1900 Smart Wi-Fi Router	Power: AC 120V/60Hz
Note: Mode 1:Transmit at 2412MHz by 11b with Adapter #2	

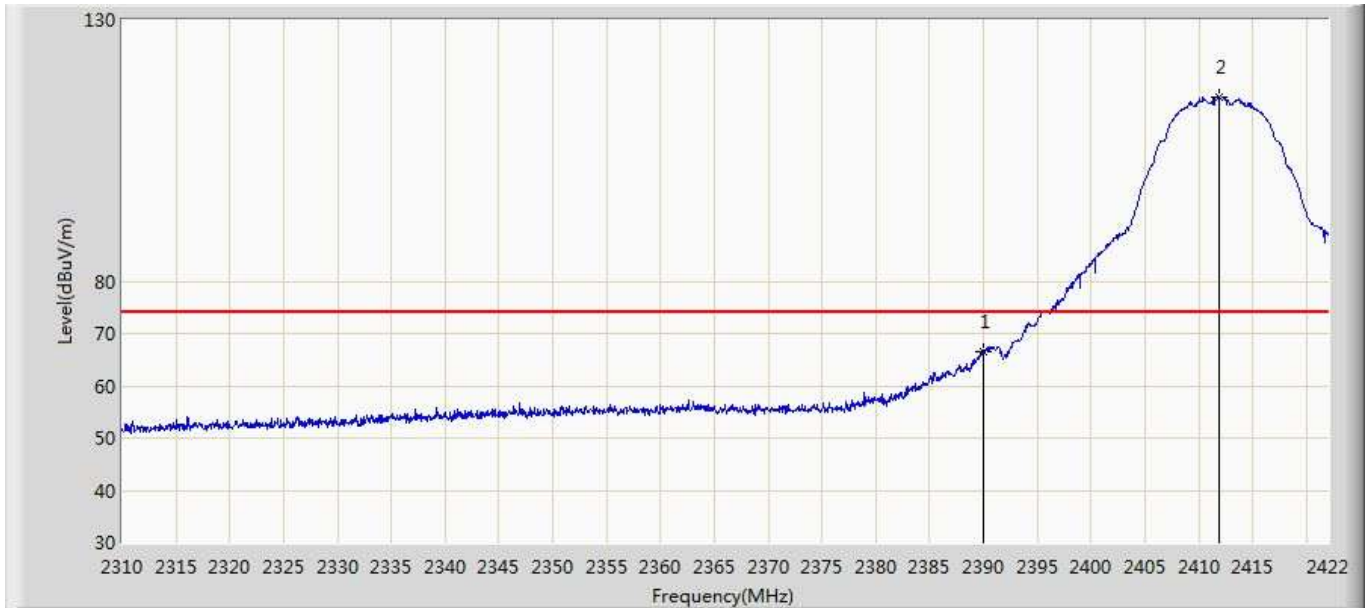

No	Mark	Frequency (MHz)	Measure Level (dBuV/m)	Reading Level (dBuV)	Over Limit (dB)	Limit (dBuV/m)	Factor (dB)	Type
1		2390.000	66.543	30.861	-7.457	74.000	35.682	PK
2	*	2411.864	115.278	79.537	41.278	74.000	35.741	PK

Engineer: Eric	
Site: AC5	Time: 2017/03/22 - 22:03
Limit: FCC_Part15.209_RE(3m)	Margin: 0
Probe: Horn_3117_00167055(1-18GHz)	Polarity: Vertical
EUT: AC1900 Smart Wi-Fi Router	Power: AC 120V/60Hz
Note: Mode 1:Transmit at 2412MHz by 11b with Adapter #2	

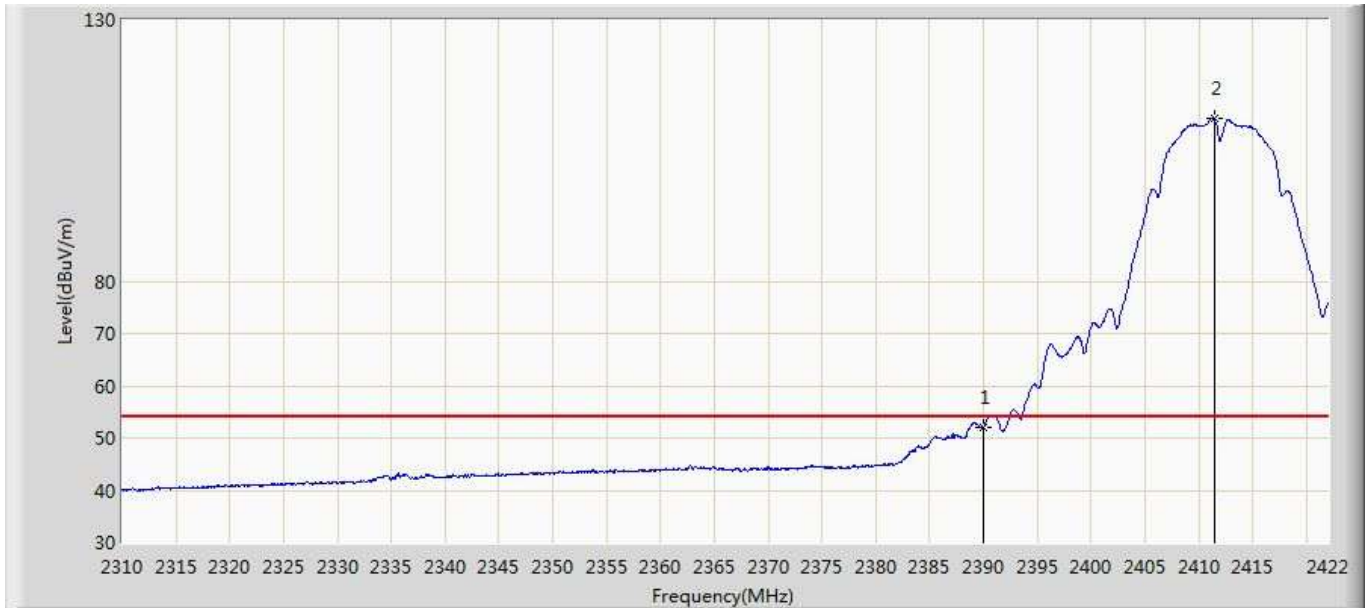

No	Mark	Frequency (MHz)	Measure Level (dBuV/m)	Reading Level (dBuV)	Over Limit (dB)	Limit (dBuV/m)	Factor (dB)	Type
1		2390.000	52.104	16.422	-1.896	54.000	35.682	AV
2	*	2411.416	111.040	75.301	57.040	54.000	35.739	AV

Engineer: Eric	
Site: AC5	Time: 2017/03/22 - 22:18
Limit: FCC_Part15.209_RE(3m)	Margin: 0
Probe: Horn_3117_00167055(1-18GHz)	Polarity: Horizontal
EUT: AC1900 Smart Wi-Fi Router	Power: AC 120V/60Hz
Note: Mode 1:Transmit at 2462MHz by 11b with Adapter #2	



No	Mark	Frequency (MHz)	Measure Level (dBuV/m)	Reading Level (dBuV)	Over Limit (dB)	Limit (dBuV/m)	Factor (dB)	Type
1	*	2461.984	116.903	81.025	42.903	74.000	35.878	PK
2		2483.500	58.300	22.408	-15.700	74.000	35.891	PK

Engineer: Eric	
Site: AC5	Time: 2017/03/22 - 22:22
Limit: FCC_Part15.209_RE(3m)	Margin: 0
Probe: Horn_3117_00167055(1-18GHz)	Polarity: Horizontal
EUT: AC1900 Smart Wi-Fi Router	Power: AC 120V/60Hz
Note: Mode 1:Transmit at 2462MHz by 11b with Adapter #2	



No	Mark	Frequency (MHz)	Measure Level (dBuV/m)	Reading Level (dBuV)	Over Limit (dB)	Limit (dBuV/m)	Factor (dB)	Type
1	*	2461.288	101.278	65.403	47.278	54.000	35.875	AV
2		2483.500	47.209	11.317	-6.791	54.000	35.891	AV

Engineer: Eric	
Site: AC5	Time: 2017/03/22 - 22:24
Limit: FCC_Part15.209_RE(3m)	Margin: 0
Probe: Horn_3117_00167055(1-18GHz)	Polarity: Vertical
EUT: AC1900 Smart Wi-Fi Router	Power: AC 120V/60Hz
Note: Mode 1:Transmit at 2462MHz by 11b with Adapter #2	

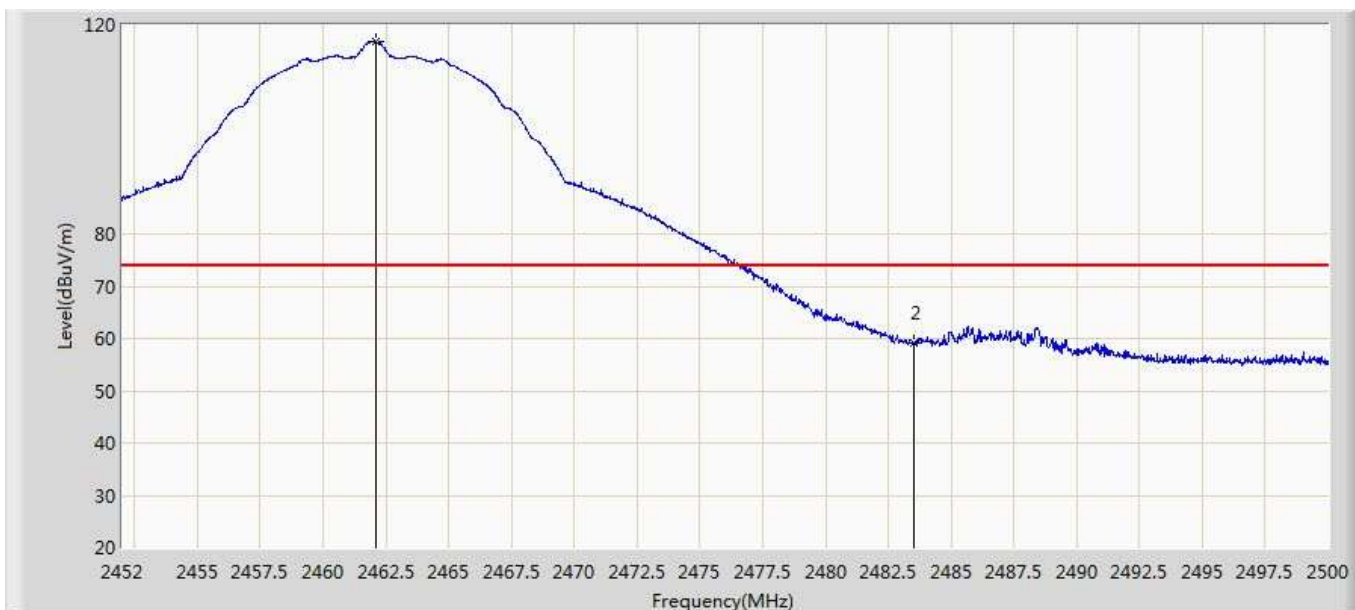

No	Mark	Frequency (MHz)	Measure Level (dBuV/m)	Reading Level (dBuV)	Over Limit (dB)	Limit (dBuV/m)	Factor (dB)	Type
1	*	2462.104	116.826	80.948	42.826	74.000	35.878	PK
2		2483.500	59.125	23.233	-14.875	74.000	35.891	PK

Engineer: Eric	
Site: AC5	Time: 2017/03/22 - 22:35
Limit: FCC_Part15.209_RE(3m)	Margin: 0
Probe: Horn_3117_00167055(1-18GHz)	Polarity: Vertical
EUT: AC1900 Smart Wi-Fi Router	Power: AC 120V/60Hz
Note: Mode 1:Transmit at 2462MHz by 11b with Adapter #2	



No	Mark	Frequency (MHz)	Measure Level (dBuV/m)	Reading Level (dBuV)	Over Limit (dB)	Limit (dBuV/m)	Factor (dB)	Type
1	*	2461.360	110.892	75.017	56.892	54.000	35.875	AV
2		2483.500	50.915	15.023	-3.085	54.000	35.891	AV

Engineer: Eric	
Site: AC5	Time: 2017/03/22 - 22:45
Limit: FCC_Part15.209_RE(3m)	Margin: 0
Probe: Horn_3117_00167055(1-18GHz)	Polarity: Vertical
EUT: AC1900 Smart Wi-Fi Router	Power: AC 120V/60Hz
Note: Mode 2:Transmit at 2412MHz by 11g with Adapter #2	



No	Mark	Frequency (MHz)	Measure Level (dBuV/m)	Reading Level (dBuV)	Over Limit (dB)	Limit (dBuV/m)	Factor (dB)	Type
1		2390.000	72.993	37.311	-1.007	74.000	35.682	PK
2	*	2413.824	115.570	79.821	41.570	74.000	35.749	PK

Engineer: Eric	
Site: AC5	Time: 2017/03/22 - 22:38
Limit: FCC_Part15.209_RE(3m)	Margin: 0
Probe: Horn_3117_00167055(1-18GHz)	Polarity: Vertical
EUT: AC1900 Smart Wi-Fi Router	Power: AC 120V/60Hz
Note: Mode 2:Transmit at 2412MHz by 11g with Adapter #2	

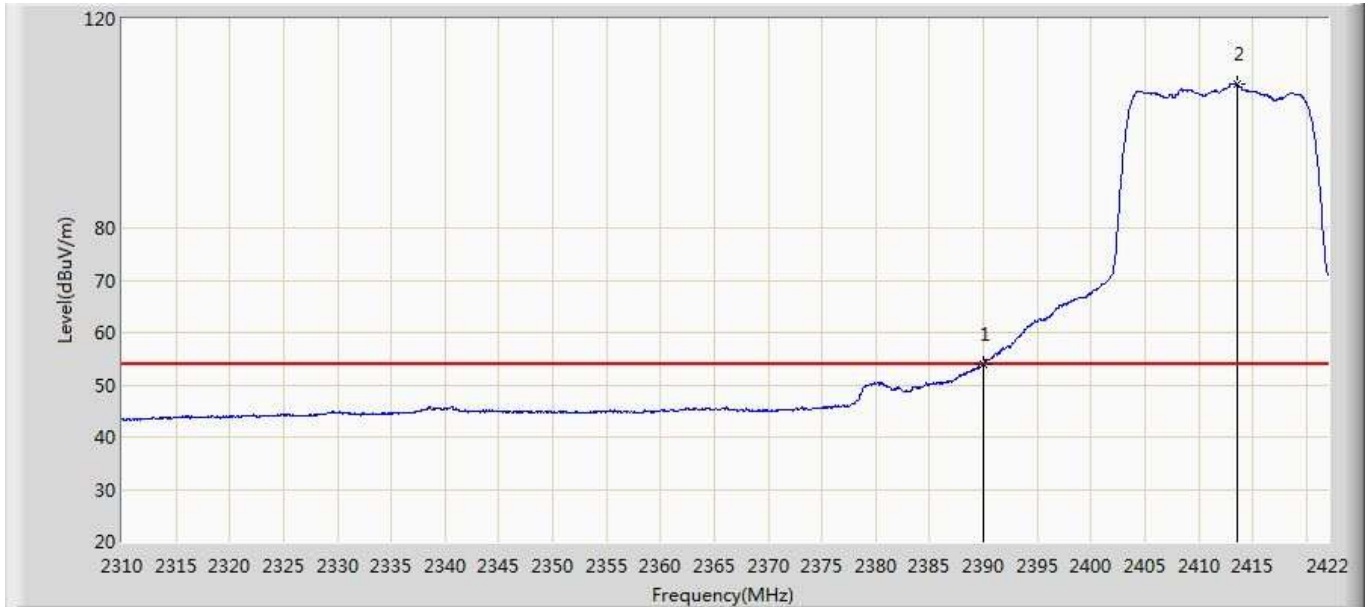

No	Mark	Frequency (MHz)	Measure Level (dBuV/m)	Reading Level (dBuV)	Over Limit (dB)	Limit (dBuV/m)	Factor (dB)	Type
1		2390.000	53.998	18.316	-0.002	54.000	35.682	AV
2	*	2413.544	107.582	71.834	53.582	54.000	35.748	AV

Engineer: Eric	
Site: AC5	Time: 2017/03/22 - 22:48
Limit: FCC_Part15.209_RE(3m)	Margin: 0
Probe: Horn_3117_00167055(1-18GHz)	Polarity: Horizontal
EUT: AC1900 Smart Wi-Fi Router	Power: AC 120V/60Hz
Note: Mode 2:Transmit at 2412MHz by 11g with Adapter #2	



No	Mark	Frequency (MHz)	Measure Level (dBuV/m)	Reading Level (dBuV)	Over Limit (dB)	Limit (dBuV/m)	Factor (dB)	Type
1		2390.000	64.296	28.614	-9.704	74.000	35.682	PK
2	*	2411.248	107.804	72.066	33.804	74.000	35.738	PK

Engineer: Eric	
Site: AC5	Time: 2017/03/22 - 22:50
Limit: FCC_Part15.209_RE(3m)	Margin: 0
Probe: Horn_3117_00167055(1-18GHz)	Polarity: Horizontal
EUT: AC1900 Smart Wi-Fi Router	Power: AC 120V/60Hz
Note: Mode 2:Transmit at 2412MHz by 11g with Adapter #2	



No	Mark	Frequency (MHz)	Measure Level (dBuV/m)	Reading Level (dBuV)	Over Limit (dB)	Limit (dBuV/m)	Factor (dB)	Type
1		2390.000	49.325	13.643	-4.675	54.000	35.682	AV
2	*	2410.184	97.501	61.766	43.501	54.000	35.735	AV

Engineer: Eric	
Site: AC5	Time: 2017/03/22 - 23:07
Limit: FCC_Part15.209_RE(3m)	Margin: 0
Probe: Horn_3117_00167055(1-18GHz)	Polarity: Vertical
EUT: AC1900 Smart Wi-Fi Router	Power: AC 120V/60Hz
Note: Mode 3:Transmit at 2462MHz by 11g with Adapter #2	

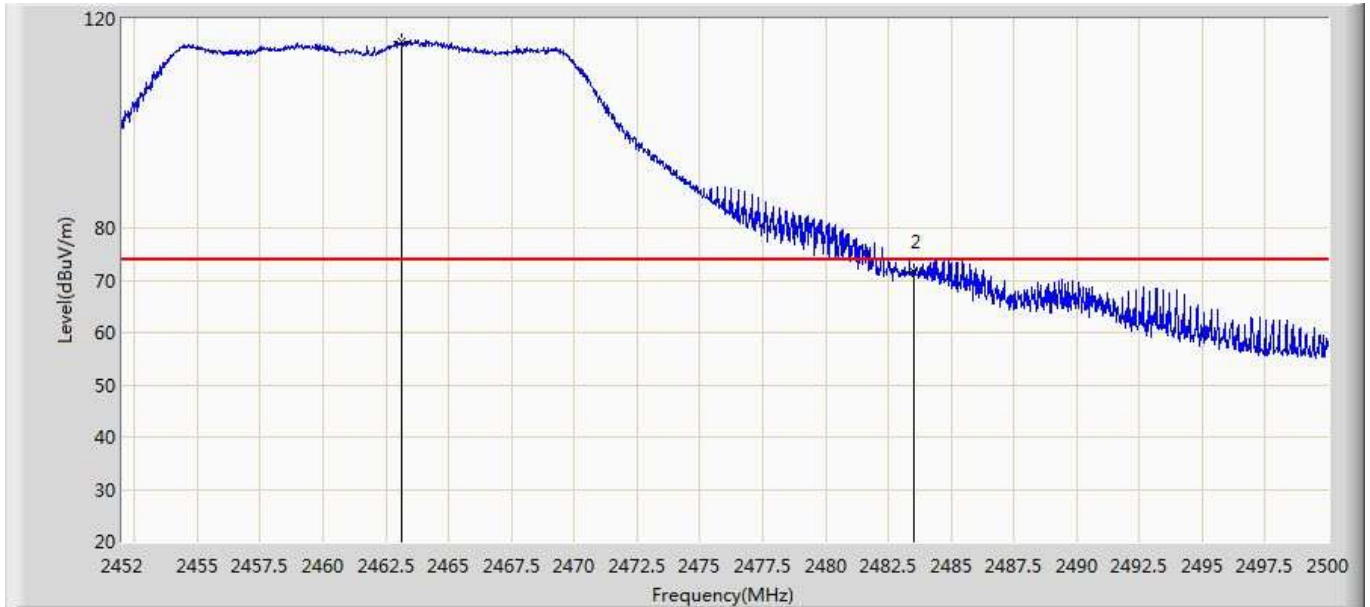

No	Mark	Frequency (MHz)	Measure Level (dBuV/m)	Reading Level (dBuV)	Over Limit (dB)	Limit (dBuV/m)	Factor (dB)	Type
1	*	2463.112	115.646	79.769	41.646	74.000	35.877	PK
2		2483.500	71.512	35.620	-2.488	74.000	35.891	PK

Engineer: Eric	
Site: AC5	Time: 2017/03/22 - 23:02
Limit: FCC_Part15.209_RE(3m)	Margin: 0
Probe: Horn_3117_00167055(1-18GHz)	Polarity: Vertical
EUT: AC1900 Smart Wi-Fi Router	Power: AC 120V/60Hz
Note: Mode 2:Transmit at 2462MHz by 11g with Adapter #2	



No	Mark	Frequency (MHz)	Measure Level (dBuV/m)	Reading Level (dBuV)	Over Limit (dB)	Limit (dBuV/m)	Factor (dB)	Type
1	*	2463.016	107.752	71.875	53.752	54.000	35.877	AV
2		2483.500	52.916	17.024	-1.084	54.000	35.891	AV

Engineer: Eric	
Site: AC5	Time: 2017/03/22 - 23:11
Limit: FCC_Part15.209_RE(3m)	Margin: 0
Probe: Horn_3117_00167055(1-18GHz)	Polarity: Horizontal
EUT: AC1900 Smart Wi-Fi Router	Power: AC 120V/60Hz
Note: Mode 2:Transmit at 2462MHz by 11g with Adapter #2	

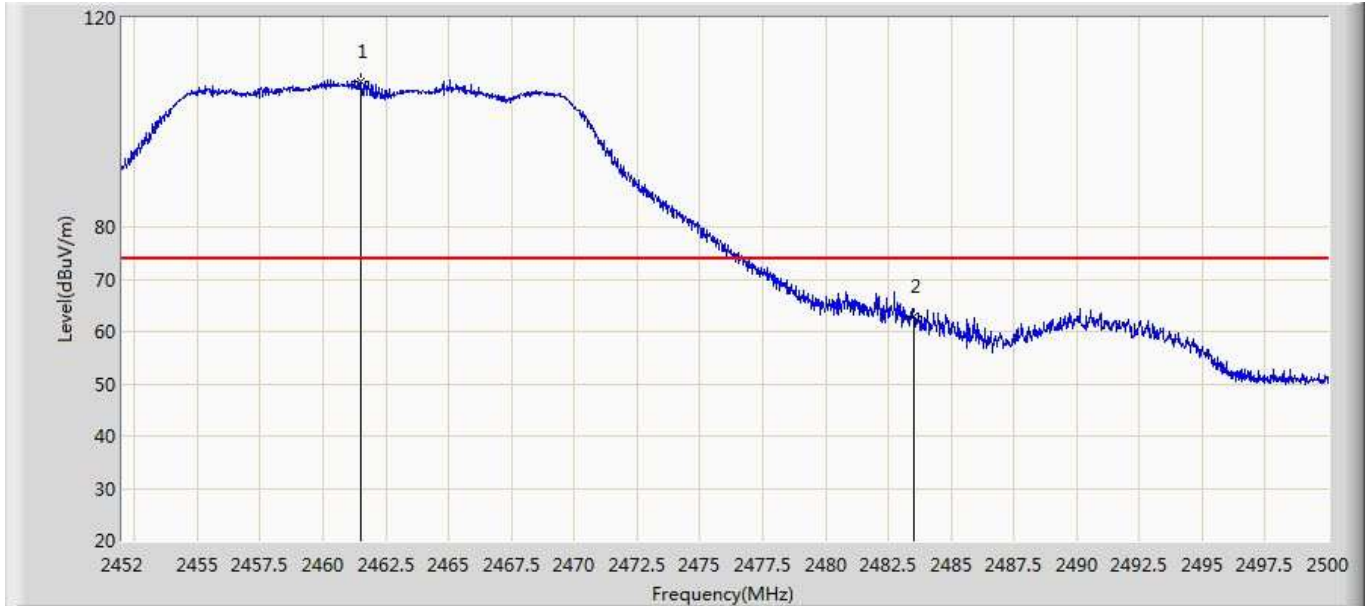

No	Mark	Frequency (MHz)	Measure Level (dBuV/m)	Reading Level (dBuV)	Over Limit (dB)	Limit (dBuV/m)	Factor (dB)	Type
1	*	2461.528	107.940	72.064	33.940	74.000	35.876	PK
2		2483.500	62.957	27.065	-11.043	74.000	35.891	PK

Engineer: Eric	
Site: AC5	Time: 2017/03/22 - 23:13
Limit: FCC_Part15.209_RE(3m)	Margin: 0
Probe: Horn_3117_00167055(1-18GHz)	Polarity: Horizontal
EUT: AC1900 Smart Wi-Fi Router	Power: AC 120V/60Hz
Note: Mode 2:Transmit at 2462MHz by 11g with Adapter #2	



No	Mark	Frequency (MHz)	Measure Level (dBuV/m)	Reading Level (dBuV)	Over Limit (dB)	Limit (dBuV/m)	Factor (dB)	Type
1	*	2461.000	97.589	61.715	43.589	54.000	35.874	AV
2		2483.500	45.996	10.104	-8.004	54.000	35.891	AV

Engineer: Eric	
Site: AC5	Time: 2017/03/22 - 23:17
Limit: FCC_Part15.209_RE(3m)	Margin: 0
Probe: Horn_3117_00167055(1-18GHz)	Polarity: Vertical
EUT: AC1900 Smart Wi-Fi Router	Power: AC 120V/60Hz
Note: Mode 3:Transmit at 2412MHz by 11n20 with Adapter #2	



No	Mark	Frequency (MHz)	Measure Level (dBuV/m)	Reading Level (dBuV)	Over Limit (dB)	Limit (dBuV/m)	Factor (dB)	Type
1		2390.000	70.619	34.937	-3.381	74.000	35.682	PK
2	*	2413.768	114.821	79.072	40.821	74.000	35.748	PK

Engineer: Eric	
Site: AC5	Time: 2017/03/22 - 23:32
Limit: FCC_Part15.209_RE(3m)	Margin: 0
Probe: Horn_3117_00167055(1-18GHz)	Polarity: Vertical
EUT: AC1900 Smart Wi-Fi Router	Power: AC 120V/60Hz
Note: Mode 3:Transmit at 2412MHz by 11n20 with Adapter #2	

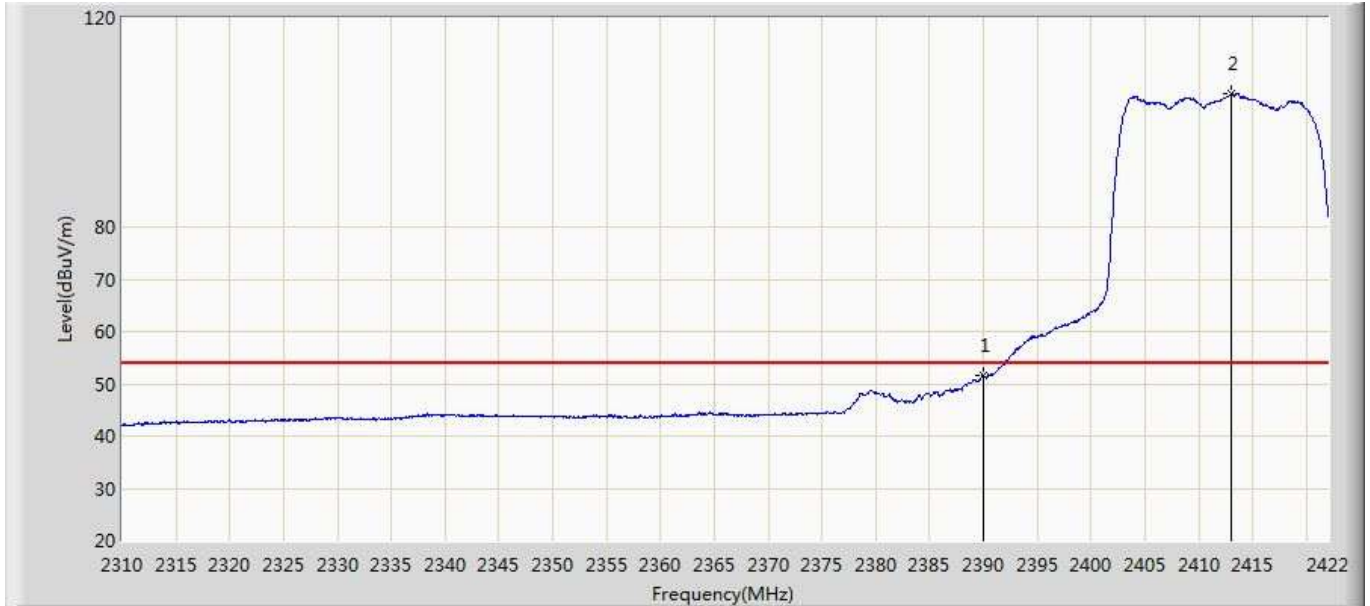

No	Mark	Frequency (MHz)	Measure Level (dBuV/m)	Reading Level (dBuV)	Over Limit (dB)	Limit (dBuV/m)	Factor (dB)	Type
1		2390.000	51.498	15.816	-2.502	54.000	35.682	AV
2	*	2412.984	105.569	69.823	51.569	54.000	35.745	AV

Engineer: Eric	
Site: AC5	Time: 2017/03/22 - 23:34
Limit: FCC_Part15.209_RE(3m)	Margin: 0
Probe: Horn_3117_00167055(1-18GHz)	Polarity: Horizontal
EUT: AC1900 Smart Wi-Fi Router	Power: AC 120V/60Hz
Note: Mode 3:Transmit at 2412MHz by 11n20 with Adapter #2	

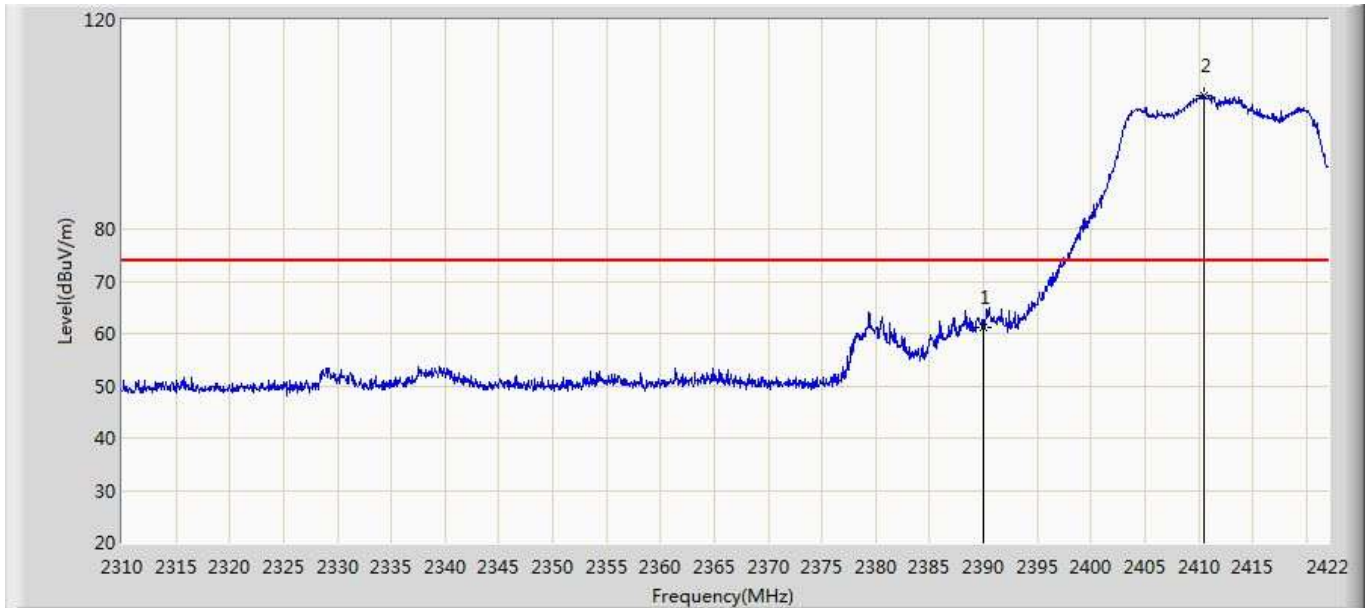

No	Mark	Frequency (MHz)	Measure Level (dBuV/m)	Reading Level (dBuV)	Over Limit (dB)	Limit (dBuV/m)	Factor (dB)	Type
1		2390.000	61.040	25.358	-12.960	74.000	35.682	PK
2	*	2410.520	105.610	69.874	31.610	74.000	35.735	PK

Engineer: Eric	
Site: AC5	Time: 2017/03/22 - 23:37
Limit: FCC_Part15.209_RE(3m)	Margin: 0
Probe: Horn_3117_00167055(1-18GHz)	Polarity: Horizontal
EUT: AC1900 Smart Wi-Fi Router	Power: AC 120V/60Hz
Note: Mode 3:Transmit at 2412MHz by 11n20 with Adapter #2	



No	Mark	Frequency (MHz)	Measure Level (dBuV/m)	Reading Level (dBuV)	Over Limit (dB)	Limit (dBuV/m)	Factor (dB)	Type
1		2390.000	48.856	13.174	-5.144	54.000	35.682	AV
2	*	2410.352	95.710	59.975	41.710	54.000	35.735	AV

Engineer: Eric	
Site: AC5	Time: 2017/03/23 - 00:05
Limit: FCC_Part15.209_RE(3m)	Margin: 0
Probe: Horn_3117_00167055(1-18GHz)	Polarity: Vertical
EUT: AC1900 Smart Wi-Fi Router	Power: AC 120V/60Hz
Note: Mode 3:Transmit at 2462MHz by 11n20 with Adapter #2	

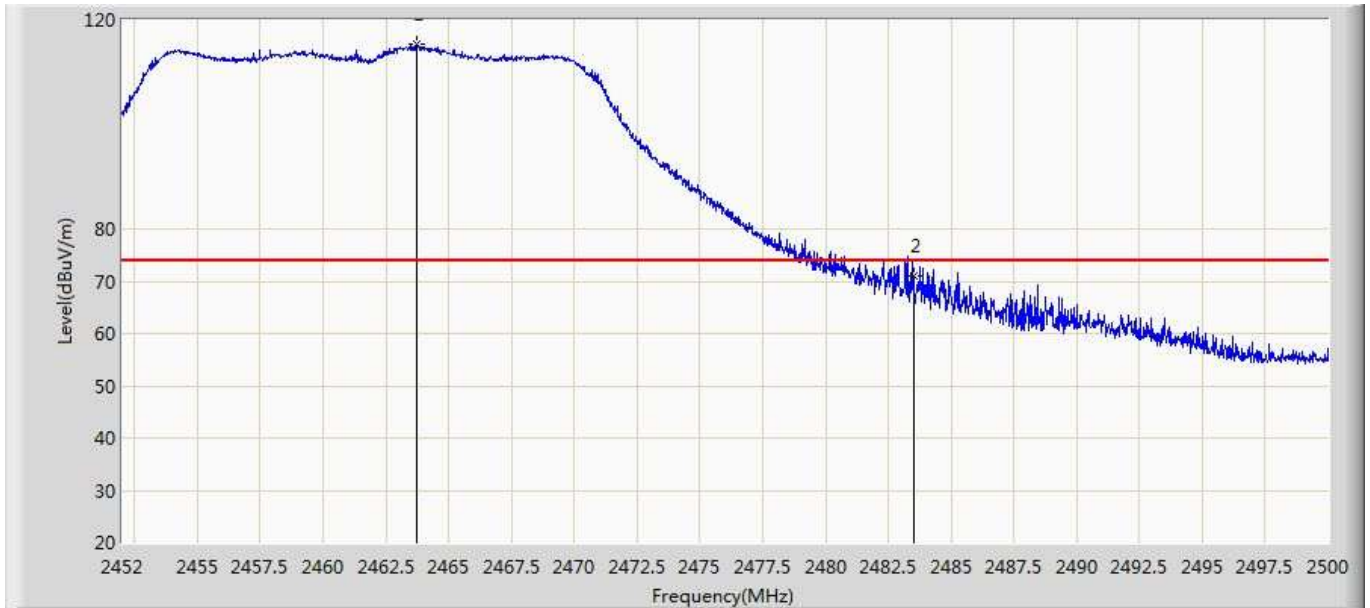

No	Mark	Frequency (MHz)	Measure Level (dBuV/m)	Reading Level (dBuV)	Over Limit (dB)	Limit (dBuV/m)	Factor (dB)	Type
1	*	2463.712	115.440	79.564	41.440	74.000	35.876	PK
2		2483.500	71.112	35.220	-2.888	74.000	35.891	PK

Engineer: Eric	
Site: AC5	Time: 2017/03/23 - 00:11
Limit: FCC_Part15.209_RE(3m)	Margin: 0
Probe: Horn_3117_00167055(1-18GHz)	Polarity: Vertical
EUT: AC1900 Smart Wi-Fi Router	Power: AC 120V/60Hz
Note: Mode 3:Transmit at 2462MHz by 11n20 with Adapter #2	



No	Mark	Frequency (MHz)	Measure Level (dBuV/m)	Reading Level (dBuV)	Over Limit (dB)	Limit (dBuV/m)	Factor (dB)	Type
1	*	2463.952	105.888	70.012	51.888	54.000	35.876	AV
2		2483.500	49.258	13.366	-4.742	54.000	35.891	AV

Engineer: Eric	
Site: AC5	Time: 2017/03/23 - 00:13
Limit: FCC_Part15.209_RE(3m)	Margin: 0
Probe: Horn_3117_00167055(1-18GHz)	Polarity: Horizontal
EUT: AC1900 Smart Wi-Fi Router	Power: AC 120V/60Hz
Note: Mode 3:Transmit at 2462MHz by 11n20 with Adapter #2	

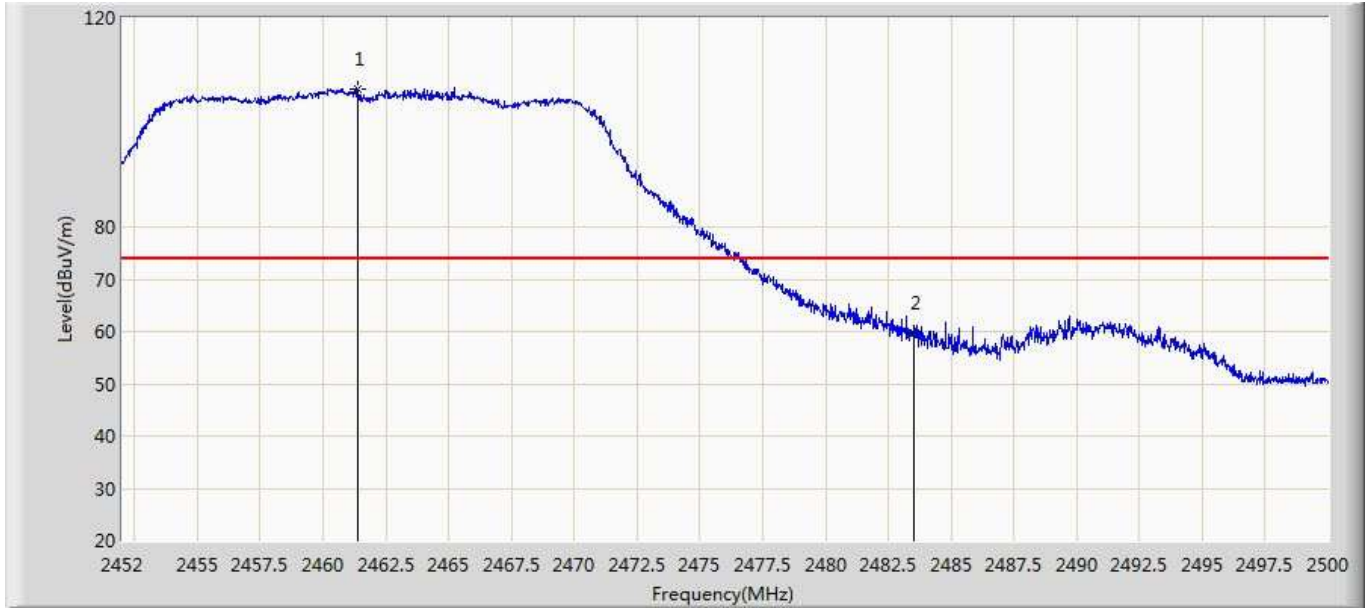

No	Mark	Frequency (MHz)	Measure Level (dBuV/m)	Reading Level (dBuV)	Over Limit (dB)	Limit (dBuV/m)	Factor (dB)	Type
1	*	2461.360	106.495	70.620	32.495	74.000	35.875	PK
2		2483.500	59.673	23.781	-14.327	74.000	35.891	PK

Engineer: Eric	
Site: AC5	Time: 2017/03/23 - 00:15
Limit: FCC_Part15.209_RE(3m)	Margin: 0
Probe: Horn_3117_00167055(1-18GHz)	Polarity: Horizontal
EUT: AC1900 Smart Wi-Fi Router	Power: AC 120V/60Hz
Note: Mode 3:Transmit at 2462MHz by 11n20 with Adapter #2	



No	Mark	Frequency (MHz)	Measure Level (dBuV/m)	Reading Level (dBuV)	Over Limit (dB)	Limit (dBuV/m)	Factor (dB)	Type
1	*	2461.072	96.296	60.422	42.296	54.000	35.874	AV
2		2483.500	45.373	9.481	-8.627	54.000	35.891	AV

Engineer: Eric	
Site: AC5	Time: 2017/03/23 - 20:08
Limit: FCC_Part15.209_RE(3m)	Margin: 0
Probe: Horn_3117_00167055(1-18GHz)	Polarity: Horizontal
EUT: AC1900 Smart Wi-Fi Router	Power: AC 120V/60Hz
Note: Mode 4:Transmit at 2422MHz by 11n40 with Adapter #2	

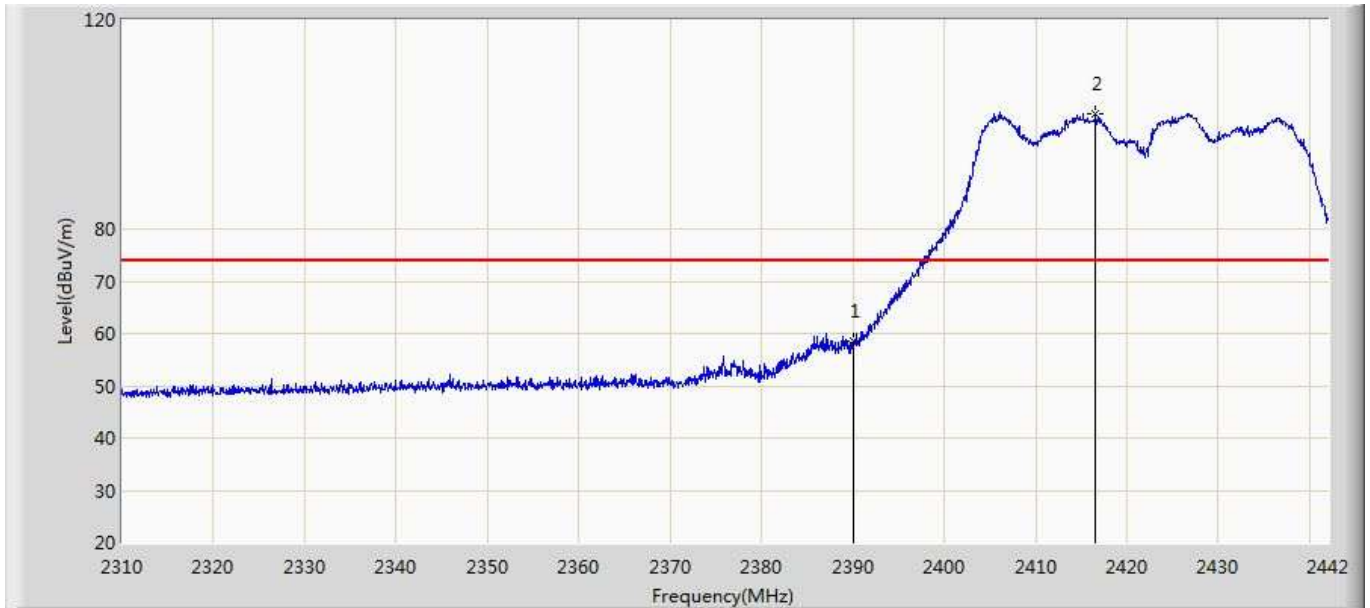

No	Mark	Frequency (MHz)	Measure Level (dBuV/m)	Reading Level (dBuV)	Over Limit (dB)	Limit (dBuV/m)	Factor (dB)	Type
1		2390.000	58.452	22.770	-15.548	74.000	35.682	PK
2	*	2416.524	102.066	66.306	28.066	74.000	35.761	PK

Engineer: Eric	
Site: AC5	Time: 2017/03/23 - 20:09
Limit: FCC_Part15.209_RE(3m)	Margin: 0
Probe: Horn_3117_00167055(1-18GHz)	Polarity: Horizontal
EUT: AC1900 Smart Wi-Fi Router	Power: AC 120V/60Hz
Note: Mode 4:Transmit at 2422MHz by 11n40 with Adapter #2	

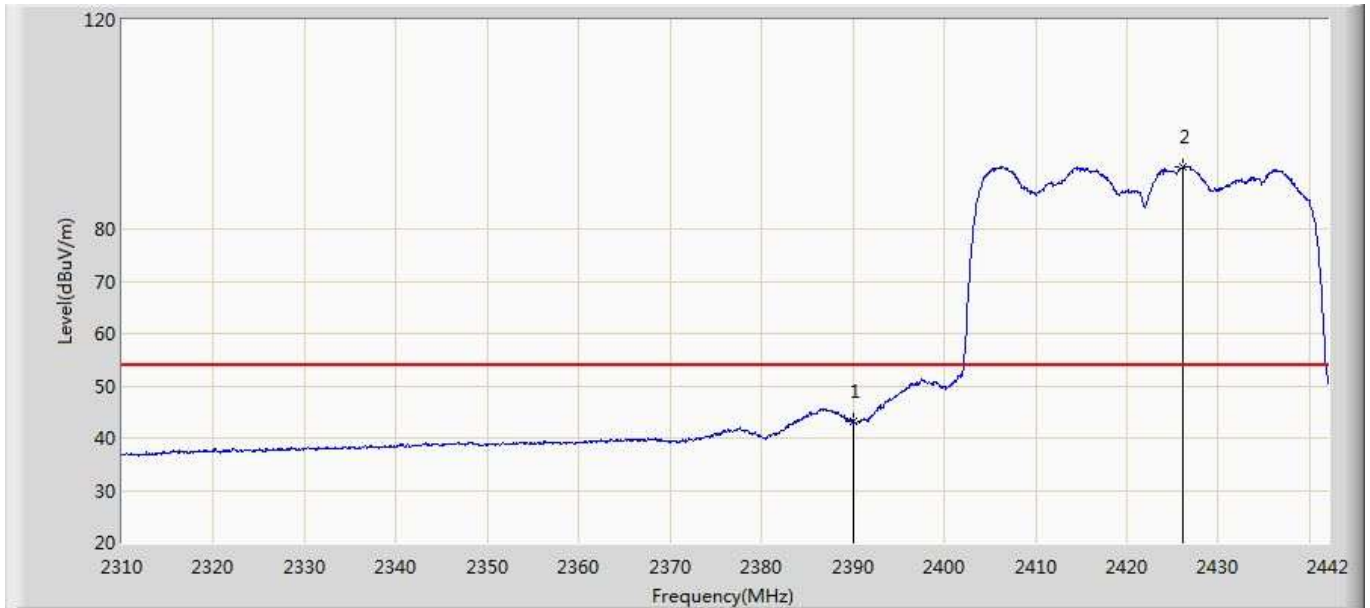

No	Mark	Frequency (MHz)	Measure Level (dBuV/m)	Reading Level (dBuV)	Over Limit (dB)	Limit (dBuV/m)	Factor (dB)	Type
1		2390.000	43.320	7.638	-10.680	54.000	35.682	AV
2	*	2426.094	91.897	56.096	37.897	54.000	35.801	AV

Engineer: Eric	
Site: AC5	Time: 2017/03/23 - 20:03
Limit: FCC_Part15.209_RE(3m)	Margin: 0
Probe: Horn_3117_00167055(1-18GHz)	Polarity: Vertical
EUT: AC1900 Smart Wi-Fi Router	Power: AC 120V/60Hz
Note: Mode 4:Transmit at 2422MHz by 11n40 with Adapter #2	

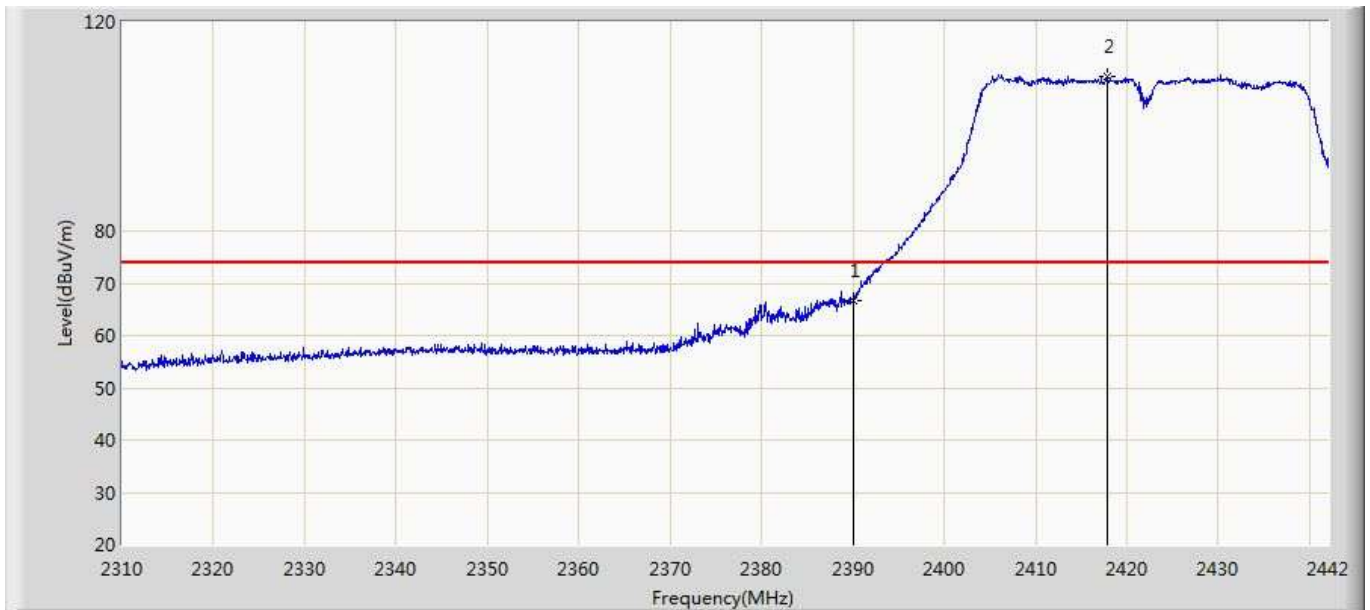

No	Mark	Frequency (MHz)	Measure Level (dBuV/m)	Reading Level (dBuV)	Over Limit (dB)	Limit (dBuV/m)	Factor (dB)	Type
1		2390.000	66.686	31.004	-7.314	74.000	35.682	PK
2	*	2417.778	109.674	73.908	35.674	74.000	35.765	PK

Engineer: Eric	
Site: AC5	Time: 2017/03/23 - 19:48
Limit: FCC_Part15.209_RE(3m)	Margin: 0
Probe: Horn_3117_00167055(1-18GHz)	Polarity: Vertical
EUT: AC1900 Smart Wi-Fi Router	Power: AC 120V/60Hz
Note: Mode 4:Transmit at 2422MHz by 11n40 with Adapter #2	

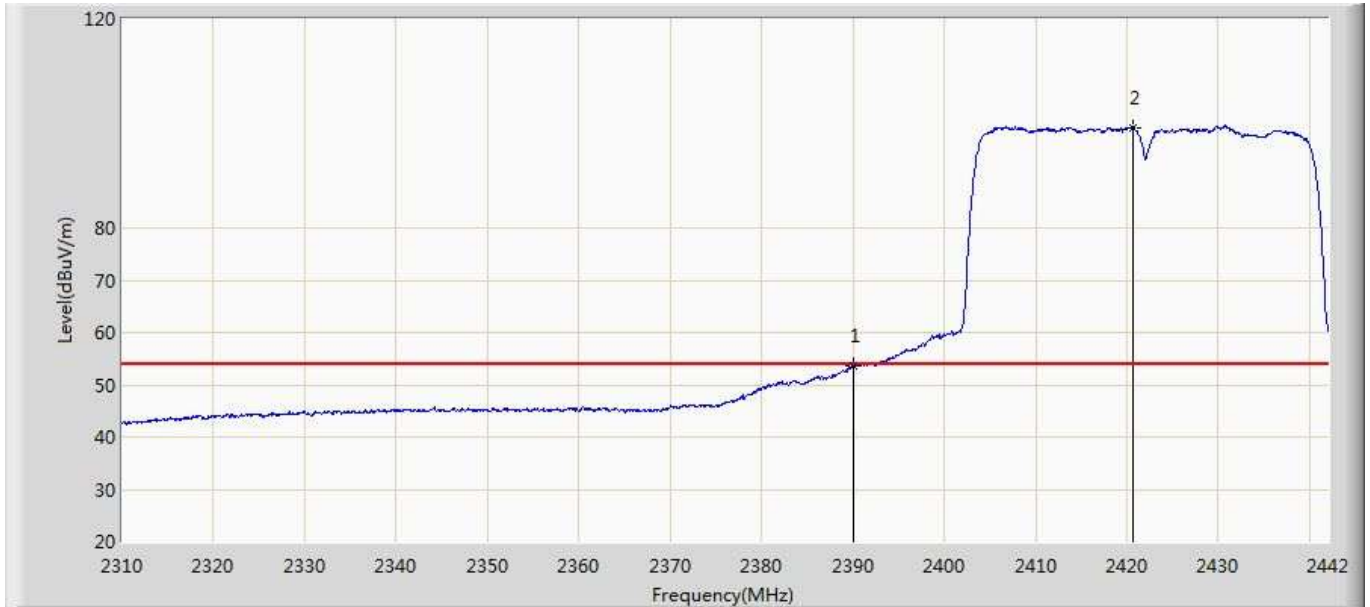

No	Mark	Frequency (MHz)	Measure Level (dBuV/m)	Reading Level (dBuV)	Over Limit (dB)	Limit (dBuV/m)	Factor (dB)	Type
1		2390.000	53.646	17.964	-0.354	54.000	35.682	AV
2	*	2420.682	99.077	63.299	45.077	54.000	35.778	AV

Engineer: Eric	
Site: AC5	Time: 2017/03/23 - 20:31
Limit: FCC_Part15.209_RE(3m)	Margin: 0
Probe: Horn_3117_00167055(1-18GHz)	Polarity: Vertical
EUT: AC1900 Smart Wi-Fi Router	Power: AC 120V/60Hz
Note: Mode 4:Transmit at 2452MHz by 11n40 with Adapter #2	

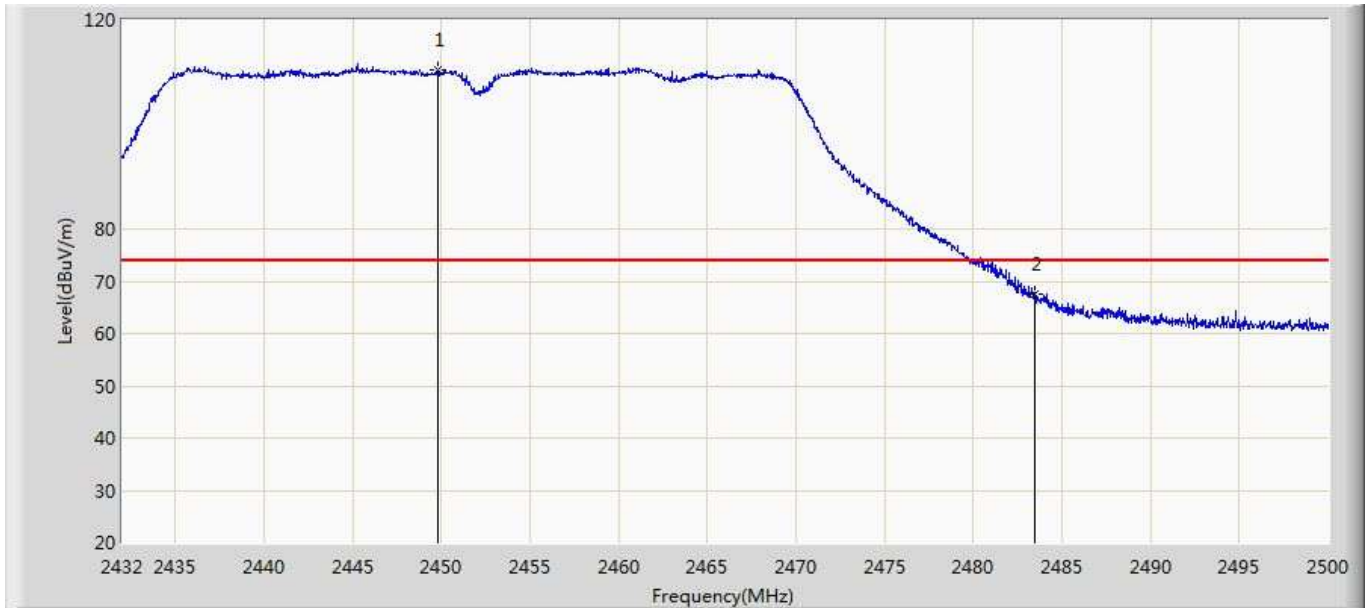

No	Mark	Frequency (MHz)	Measure Level (dBuV/m)	Reading Level (dBuV)	Over Limit (dB)	Limit (dBuV/m)	Factor (dB)	Type
1	*	2449.816	110.447	74.622	36.447	74.000	35.825	PK
2		2483.500	67.554	31.662	-6.446	74.000	35.891	PK

Engineer: Eric	
Site: AC5	Time: 2017/03/23 - 20:25
Limit: FCC_Part15.209_RE(3m)	Margin: 0
Probe: Horn_3117_00167055(1-18GHz)	Polarity: Vertical
EUT: AC1900 Smart Wi-Fi Router	Power: AC 120V/60Hz
Note: Mode 4:Transmit at 2452MHz by 11n40 with Adapter #2	

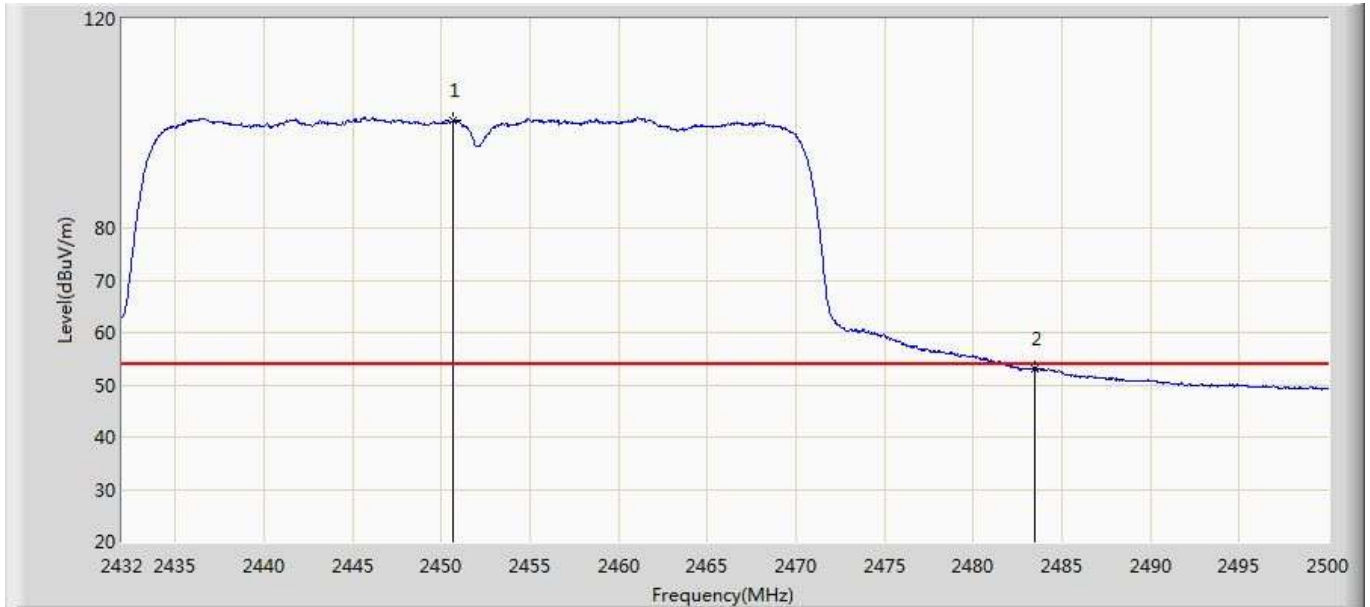

No	Mark	Frequency (MHz)	Measure Level (dBuV/m)	Reading Level (dBuV)	Over Limit (dB)	Limit (dBuV/m)	Factor (dB)	Type
1	*	2450.700	100.615	64.786	46.615	54.000	35.829	AV
2		2483.500	53.021	17.129	-0.979	54.000	35.891	AV

Engineer: Eric	
Site: AC5	Time: 2017/03/23 - 20:33
Limit: FCC_Part15.209_RE(3m)	Margin: 0
Probe: Horn_3117_00167055(1-18GHz)	Polarity: Horizontal
EUT: AC1900 Smart Wi-Fi Router	Power: AC 120V/60Hz
Note: Mode 4:Transmit at 2452MHz by 11n40 with Adapter #2	



No	Mark	Frequency (MHz)	Measure Level (dBuV/m)	Reading Level (dBuV)	Over Limit (dB)	Limit (dBuV/m)	Factor (dB)	Type
1	*	2446.110	102.752	66.943	28.752	74.000	35.808	PK
2		2483.500	60.498	24.606	-13.502	74.000	35.891	PK

Engineer: Eric	
Site: AC5	Time: 2017/03/23 - 20:35
Limit: FCC_Part15.209_RE(3m)	Margin: 0
Probe: Horn_3117_00167055(1-18GHz)	Polarity: Horizontal
EUT: AC1900 Smart Wi-Fi Router	Power: AC 120V/60Hz
Note: Mode 4:Transmit at 2452MHz by 11n40 with Adapter #2	

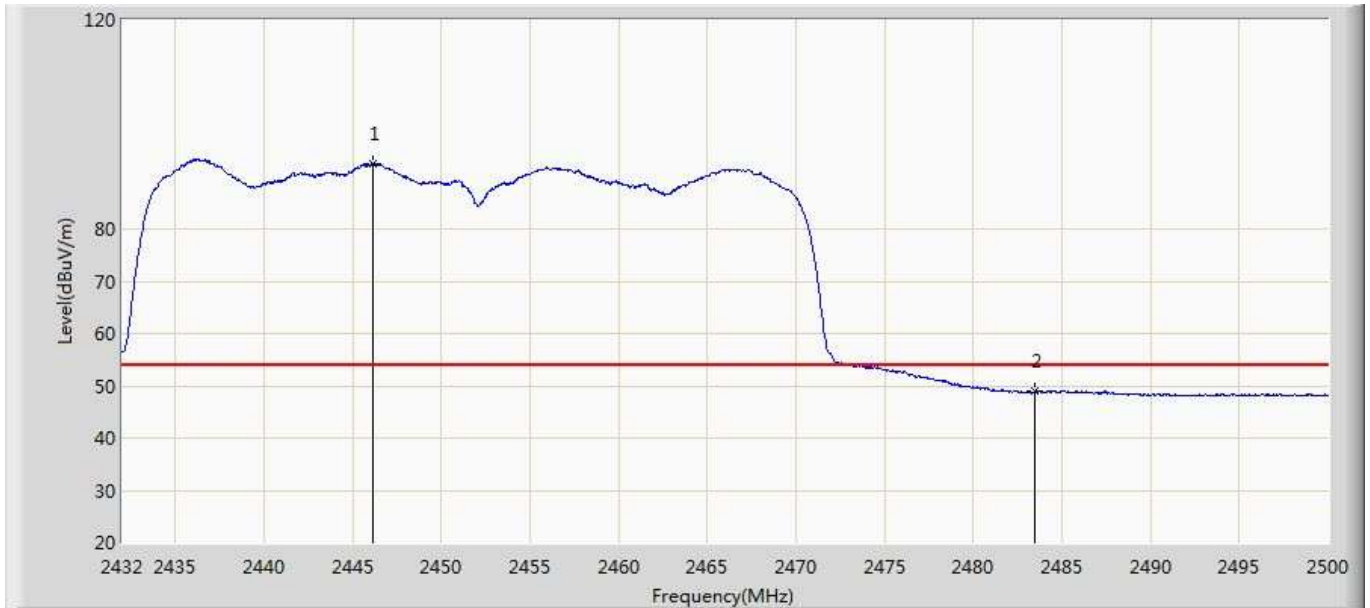

No	Mark	Frequency (MHz)	Measure Level (dBuV/m)	Reading Level (dBuV)	Over Limit (dB)	Limit (dBuV/m)	Factor (dB)	Type
1	*	2446.144	92.581	56.772	38.581	54.000	35.809	AV
2		2483.500	48.848	12.956	-5.152	54.000	35.891	AV

7. Occupied Bandwidth

7.1. Test Equipment

Occupied Bandwidth / TR-8					
Instrument	Manufacturer	Type No.	Serial No.	Cal. Date	Cal. Due Date
Spectrum Analyzer	Agilent	N9010A	MY48030494	2017.02.04	2018.02.04
EXA Spectrum Analyzer	Keysight	N9010A	MY55370495	2017.04.09	2018.04.09
MXA Signal Analyzer	Keysight	N9020A	MY56060147	2017.04.09	2018.04.09
Temperature/Humidity Meter	zhichen	ZC1-2	TR8-TH	2017.04.10	2018.04.10

Note: All equipments are calibrated with traceable calibrations. Each calibration is traceable to the national or international standards.

7.2. Test Setup

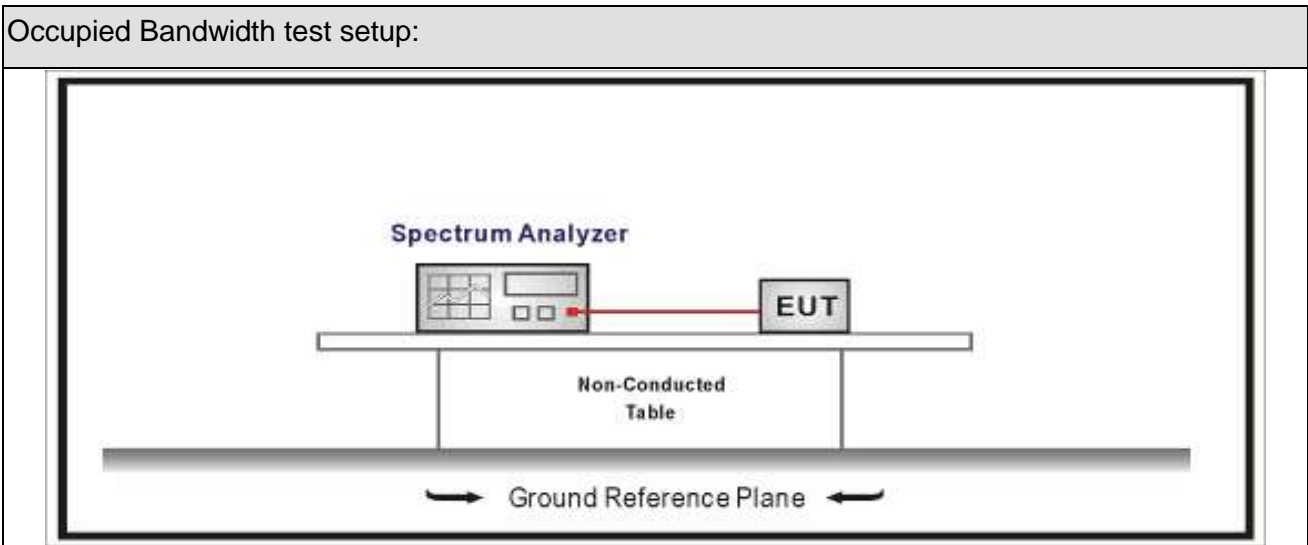





7.3. Limit

Occupied Bandwidth
Systems using digital modulation techniques operate in the 2400-2483.5 MHz. The minimum 6 dB bandwidth shall be at least 500 kHz

7.4. Test Procedure

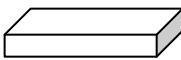
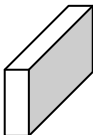
Test Method			
	Reference Rule	Chapter	Description
<input checked="" type="checkbox"/>	ANSI C63.10	11.8	DTS bandwidth
<input type="checkbox"/>	ANSI C63.10	11.8.1	Option 1
<input checked="" type="checkbox"/>	ANSI C63.10	11.8.2	Option 2

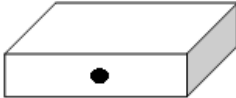
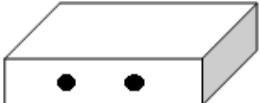
7.5. EUT test definition

Item	Occupied Bandwidth			
Device Category	<input checked="" type="checkbox"/>	Fixed position use		
	<input type="checkbox"/>	Mobile position use		
Test mode	Mode 1~4			
Test method	<input type="checkbox"/>	Radiated		
		X Axis	Y Axis	Z Axis
				
		Worst Axis <input type="checkbox"/>	Worst Axis <input type="checkbox"/>	Worst Axis <input type="checkbox"/>
	<input checked="" type="checkbox"/>	Conducted		
	<input type="checkbox"/>	Chain 1		
				
	<input type="checkbox"/>	Chain 1	Chain 2	
				
	<input checked="" type="checkbox"/>	Chain 1	Chain 2	Chain 3
				

7.6. Test Result

Product Name	: AC1900 Smart Wi-Fi Router	Power	: AC 120V / 60Hz
Test Mode	: Mode1~4	Test Site	: TR8
Test Date	: 2017.02.25		

Mode	CH.	Test Freq. (MHz)	99% Occupied Bandwidth (MHz)	6dB Occupied Bandwidth (MHz)	Limit (kHz)	Result
			Worst Data	Worst Data		
			Ant1	Ant1		
1	01	2412	7.600	10.295	>500	Pass
1	06	2437	8.061	10.299	>500	Pass
1	11	2462	7.599	10.326	>500	Pass
2	01	2412	16.479	16.350	>500	Pass
2	06	2437	16.475	16.330	>500	Pass
2	11	2462	16.475	16.330	>500	Pass
3	01	2412	17.666	17.570	>500	Pass
3	06	2437	17.655	17.550	>500	Pass
3	11	2462	17.662	17.310	>500	Pass
4	03	2422	17.851	17.660	>500	Pass
4	06	2437	17.820	17.650	>500	Pass
4	09	2452	17.817	17.700	>500	Pass

8. Fundamental emission output power

8.1. Test Equipment

Fundamental emission output power/ TR-8					
Instrument	Manufacturer	Type No.	Serial No.	Cal. Date	Cal. Due Date
Spectrum Analyzer	Agilent	E4446A	MY45300103	2017.01.04	2018.01.04
Spectrum Analyzer	Agilent	N9010A	MY48030494	2017.02.04	2018.02.04
Wideband Peak Power Meter	Anritsu	ML2495A	0905006	2016.10.14	2017.10.14
Power Sensor	Anritsu	MA2411B	0846014	2016.10.14	2017.10.14
Temperature/Humidity Meter	zhicheng	ZC1-2	TR8-TH	2017.04.10	2018.04.10

Note: All equipments are calibrated with traceable calibrations. Each calibration is traceable to the national or international standards.

8.2. Test Setup

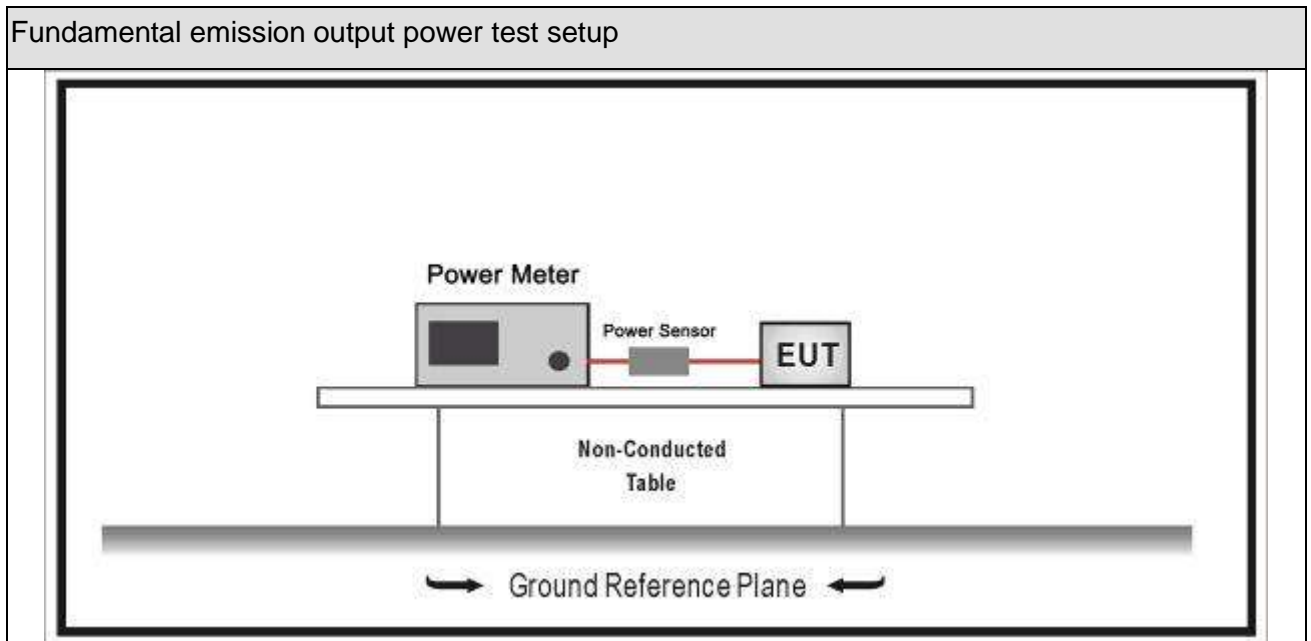



8.3. Limit

Fundamental emission output power Limit		
<input checked="" type="checkbox"/>	$G_{TX} < 6\text{dBi}$	$P_{out} \leq 30\text{dBm}$
<input type="checkbox"/>	$G_{TX} > 6\text{dBi}$	
<input type="checkbox"/>	Non-Fix point-point	$P_{out} \leq 30 - (G_{TX} - 6)$
<input checked="" type="checkbox"/>	Fix point-point	$P_{out} \leq 30 - [(G_{TX} - 6)]/3$
<input type="checkbox"/>	emits multiple directional beams but does not do emit multiple directional beams simultaneously	$P_{out} \leq 30 - [(G_{TX} - 6)]/3$
<input type="checkbox"/>	operates simultaneously on multiple directional beams using the same or different frequency channels	$P_{out} \leq 30 - [(G_{TX} - 6)]/3 + 8\text{dB}$
<input type="checkbox"/>	single directional beam	$P_{out} \leq 30 - [(G_{TX} - 6)]/3$
<p>Note 1 : G_{TX} directional gain of transmitting antennas.</p> <p>Note 2 : P_{out} is maximum peak conducted output power .</p>		

8.4. Test Procedure

Fundamental emission output power Test Method						
	References Rule		Chapter	Description		
<input checked="" type="checkbox"/>	ANSI C63.10		11.9	Fundamental emission output power		
	<input type="checkbox"/>	ANSI C63.10		11.9.1	Maximum peak conducted output power	
		<input type="checkbox"/>	ANSI C63.10	11.9.1.1	RBW \geq DTS bandwidth	
		<input type="checkbox"/>	ANSI C63.10	11.9.1.2	Integrated band power method	
		<input type="checkbox"/>	ANSI C63.10	11.9.1.3	PKPM1 Peak power meter method	
	<input checked="" type="checkbox"/>	ANSI C63.10		11.9.2	Maximum conducted (average) output power	
		<input type="checkbox"/>	ANSI C63.10		11.9.2.2	Measurement using a spectrum analyzer (SA)
			<input type="checkbox"/>	ANSI C63.10	11.9.2.2.2	Method AVGSA-1(Duty cycle \geq 98%)
			<input type="checkbox"/>	ANSI C63.10	11.9.2.2.3	Method AVGSA-1A(Duty cycle \geq 98%)
			<input type="checkbox"/>	ANSI C63.10	11.9.2.2.4	Method AVGSA-2(Duty cycle \leq 98%)
			<input type="checkbox"/>	ANSI C63.10	11.9.2.2.5	Method AVGSA-2A(Duty cycle \leq 98%)
			<input type="checkbox"/>	ANSI C63.10	11.9.2.2.4	Method AVGSA-3
			<input type="checkbox"/>	ANSI C63.10	11.9.2.2.5	Method AVGSA-3A
		<input checked="" type="checkbox"/>	ANSI C63.10		11.9.2.3	Measurement using a power meter (PM)
		<input type="checkbox"/>	ANSI C63.10	11.9.2.3.1	Method AVGPM	
<input checked="" type="checkbox"/>		ANSI C63.10	11.9.2.3.2	Method AVGPM-G		

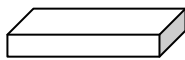
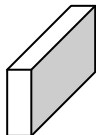
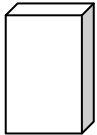
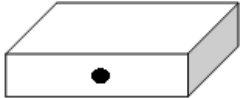
8.5. EUT test definition

Item	Fundamental emission output power			
Device Category	<input checked="" type="checkbox"/>	Fixed position use		
	<input type="checkbox"/>	Mobile position use		
Test mode	Mode 1~4			
Test method	<input type="checkbox"/>	Radiated		
		X Axis	Y Axis	Z Axis
				
		Worst Axis <input type="checkbox"/>	Worst Axis <input type="checkbox"/>	Worst Axis <input type="checkbox"/>
	<input checked="" type="checkbox"/>	Conducted		
	<input type="checkbox"/>	Chain 1		
				
	<input type="checkbox"/>	Chain 1	Chain 2	
				
	<input checked="" type="checkbox"/>	Chain 1	Chain 2	Chain 3
				

8.6. Test Result

Product Name	: AC1900 Smart Wi-Fi Router	Power	: AC 120V / 60Hz
Test Mode	: Mode1~4	Test Site	: TR8
Test Date	: 2017.4.6		

Mode	Channel	Test Frequency (MHz)	Average Power Output (dBm)			Limit (dBm)	Result
			Ant 1	Ant 2	Ant 3		
1	01	2412	19.77	N/A	N/A	30	Pass
1	06	2437	19.87	N/A	N/A	30	Pass
1	11	2462	19.33	N/A	N/A	30	Pass
2	01	2412	12.75	12.78	12.96	30	Pass
2	06	2437	18.43	18.52	18.69	30	Pass
2	11	2462	12.59	12.62	12.77	30	Pass
3	01	2412	11.23	11.35	11.45	30	Pass
3	06	2437	18.25	18.41	18.52	30	Pass
3	11	2462	11.89	11.93	12.12	30	Pass
4	03	2422	10.12	10.31	10.39	30	Pass
4	06	2437	14.74	14.29	14.59	30	Pass
4	09	2452	11.59	11.68	11.71	30	Pass

9. Power Spectral Density

9.1. Test Equipment

Power Spectral Density / TR-8					
Instrument	Manufacturer	Type No.	Serial No.	Cal. Date	Cal. Due Date
Spectrum Analyzer	Agilent	N9010A	MY48030494	2017.02.04	2018.02.04
EXA Spectrum Analyzer	Keysight	N9010A	MY55370495	2017.04.09	2018.04.09
MXA Signal Analyzer	Keysight	N9020A	MY56060147	2017.04.09	2018.04.09
Temperature/Humidity Meter	zhichen	ZC1-2	TR8-TH	2017.04.10	2018.04.10

Note: All equipments are calibrated with traceable calibrations. Each calibration is traceable to the national or international standards.

9.2. Test Setup

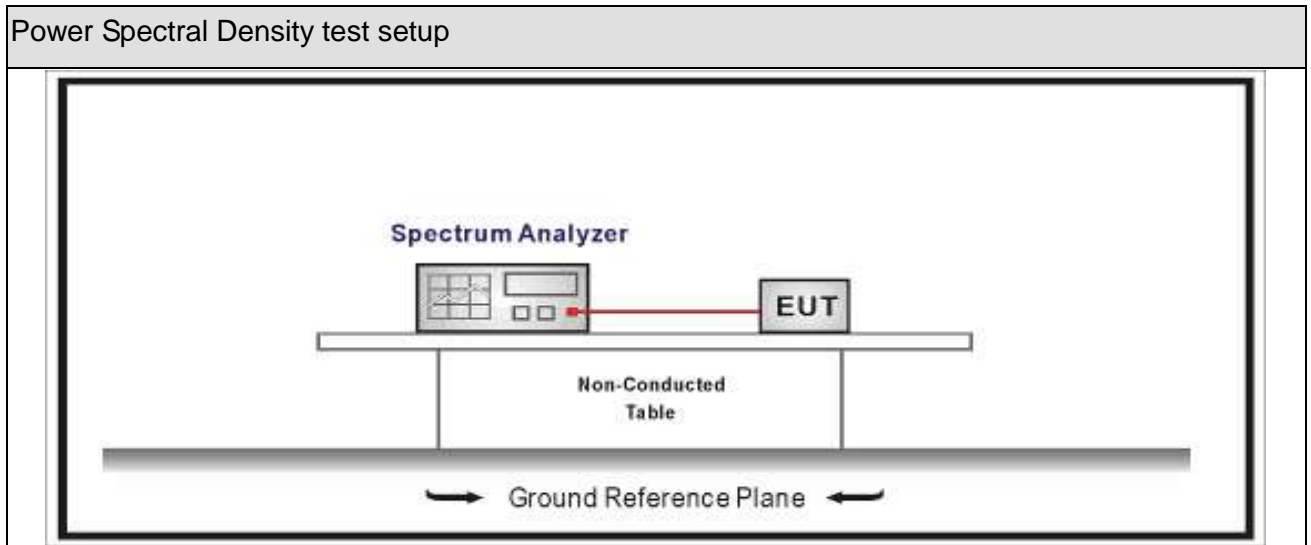





9.3. Limit

Power Spectral Density Limit
Power Spectral Density $\leq 8\text{dBm}/3\text{kHz}$

9.4. Test Procedure

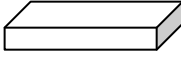
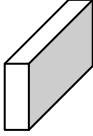
Power Spectral Density Test Method			
	References Rule	Chapter	Description
<input checked="" type="checkbox"/>	ANSI C63.10	11.10	Maximum power spectral density level in the fundamental emission
<input checked="" type="checkbox"/>	ANSI C63.10	11.10.2	Method PKPSD (peak PSD)
<input type="checkbox"/>	ANSI C63.10	11.10.3	Method AVGPSD-1(Duty cycle \geq 98%)
<input type="checkbox"/>	ANSI C63.10	11.10.4	Method AVGPSD-1A(Duty cycle \geq 98%)
<input type="checkbox"/>	ANSI C63.10	11.10.5	Method AVGPSD-2(Duty cycle $<$ 98%)
<input type="checkbox"/>	ANSI C63.10	11.10.6	Method AVGPSD-2A(Duty cycle $<$ 98%)
<input type="checkbox"/>	ANSI C63.10	11.10.7	Method AVGPSD-3
<input type="checkbox"/>	ANSI C63.10	11.10.8	Method AVGPSD-3A

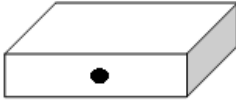
9.5. EUT test definition

Item	Power Spectral Density Test Method			
Device Category	<input checked="" type="checkbox"/>	Fixed position use		
	<input type="checkbox"/>	Mobile position use		
Test mode	Mode 1~4			
Test method	<input type="checkbox"/>	Radiated		
		X Axis	Y Axis	Z Axis
				
		Worst Axis <input type="checkbox"/>	Worst Axis <input type="checkbox"/>	Worst Axis <input type="checkbox"/>
	<input checked="" type="checkbox"/>	Conducted		
	<input type="checkbox"/>	Chain 1		
				
	<input type="checkbox"/>	Chain 1	Chain 2	
				
	<input checked="" type="checkbox"/>	Chain 1	Chain 2	Chain 3
				

9.6. Test Result

Product Name	: AC1900 Smart Wi-Fi Router	Power	: AC 120V / 60Hz
Test Mode	: Mode1~4	Test Site	: TR8
Test Date	: 2017.4.6		

Mode	Channel	Test Frequency (MHz)	Measurement PSD (dBm/3kHz)			Total PPSD (dBm/MHz)	Limit (dBm/3kHz)	Result
			Ant1	Ant2	Ant3			
1	01	2412	-3.679	N/A	N/A	-3.679	5.23	Pass
1	06	2437	-5.117	N/A	N/A	-5.117	5.23	Pass
1	11	2462	-5.445	N/A	N/A	-5.445	5.23	Pass
2	01	2412	-9.731	-8.940	-9.024	N/A	5.23	Pass
2	06	2437	-8.010	-6.828	-6.903	N/A	5.23	Pass
2	11	2462	-8.466	-9.344	-9.884	N/A	5.23	Pass
3	01	2412	-9.578	-8.576	-9.511	-4.426	5.23	Pass
3	06	2437	-10.774	-12.272	-10.381	-6.298	5.23	Pass
3	11	2462	-10.831	-9.378	-9.926	-5.233	5.23	Pass
4	03	2422	-11.629	-10.468	-11.257	-6.319	5.23	Pass
4	06	2437	-10.611	-10.099	-9.791	-5.383	5.23	Pass
4	09	2452	-10.859	-11.019	-10.656	-6.071	5.23	Pass

10. Antenna Requirement

10.1. Limit

Antenna Requirement Limit	
<p>An intentional radiator shall be designed to ensure that no antenna other than that furnished by the responsible party shall be used with the device. The use of a permanently attached antenna or of an antenna that uses a unique coupling to the intentional radiator shall be considered sufficient to comply with the provisions of this section. The manufacturer may design the unit so that a broken antenna can be replaced by the user, but the use of a standard antenna jack or electrical connector is prohibited. This requirement does not apply to carrier current devices or to devices operated under the provisions of §15.211, §15.213, §15.217, §15.219, or §15.221. Further, this requirement does not apply to intentional radiators that must be professionally installed, such as perimeter protection systems and some field disturbance sensors, or to other intentional radiators which, in accordance with §15.31(d), must be measured at the installation site. However, the installer shall be responsible for ensuring that the proper antenna is employed so that the limits in this part are not exceeded.</p>	

10.2. Antenna Connector Construction

Antenna Connector Construction	
<input type="checkbox"/>	The use of a permanently attached antenna
<input type="checkbox"/>	The antenna use of a unique coupling to the intentional radiator
<input checked="" type="checkbox"/>	The use of a nonstandard antenna jack or electrical connector
Please refer to the attached document "Internal Photograph" to show the antenna connector.	

_____ The End _____