

Shanghai Feixun Communication Co., Ltd.

Wireless router

Main Model: FIR302E

Serial Model: N/A

July 14, 2014



Report No.: 14050049-FCC-E

(This report supersedes NONE)

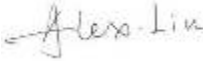

Modifications made to the product : None

This Test Report is Issued Under the Authority of:

		
Amos Xia Compliance Engineer	Alex Liu Technical Manager	

This test report may be reproduced in full only.
Test result presented in this test report is applicable to the representative sample only.

EMC Test Report

To: FCC Part 15 Subpart B Class B, 2013, ANSI C63.4: 2009

SIEMIC, INC.
Accessing global markets



Laboratory Introduction

SIEMIC, headquartered in the heart of Silicon Valley, with superior facilities in US and Asia, is one of the leading independent testing and certification facilities providing customers with one-stop shop services for Compliance Testing and Global Certifications.



In addition to [testing](#) and [certification](#), SIEMIC provides initial design reviews and [compliance management](#) through out a project. Our extensive experience with [China](#), [Asia Pacific](#), [North America](#), [European](#), and [international](#) compliance requirements, assures the fastest, most cost effective way to attain regulatory compliance for the [global markets](#).

Accreditations for Conformity Assessment

Country/Region	Scope
USA	EMC , RF/Wireless , Telecom
Canada	EMC, RF/Wireless , Telecom
Taiwan	EMC, RF, Telecom , Safety
Hong Kong	RF/Wireless ,Telecom
Australia	EMC, RF, Telecom , Safety
Korea	EMI, EMS, RF , Telecom, Safety
Japan	EMI, RF/Wireless, Telecom
Singapore	EMC , RF , Telecom
Europe	EMC, RF, Telecom , Safety



SIEMIC, INC.

Title: EMC Test Report for Wireless router
Main Model: FIR302E
Serial Model: N/A
To: FCC Part 15 Subpart B Class B: 2013 , ANSI C63.4:2009

Report No.: 14050049-FCC-E
Issue Date: July 14, 2014
Page: 3 of 38
www.siemic.com.cn

This page has been left blank intentionally.



SIEMIC, INC.

Title: EMC Test Report for Wireless router
Main Model: FIR302E
Serial Model: N/A
To: FCC Part 15 Subpart B Class B: 2013 , ANSI C63.4:2009

Report No.: 14050049-FCC-E
Issue Date: July 14, 2014
Page: 4 of 38
www.siemic.com.cn

CONTENTS

1	EXECUTIVE SUMMARY & EUT INFORMATION	5
2	TECHNICAL DETAILS.....	6
3	MODIFICATION.....	7
4	TEST SUMMARY.....	8
5	MEASUREMENTS, EXAMINATION AND DERIVED RESULTS.....	9
	ANNEX A. TEST INSTRUMENTATION & GENERAL PROCEDURES	17
	ANNEX B. EUT AND TEST SETUP PHOTOGRAPHS	22
	ANNEX C. TEST SETUP AND SUPPORTING EQUIPMENT.....	33
	ANNEX D. USER MANUAL / BLOCK DIAGRAM / SCHEMATICS / PART LIST	37
	ANNEX E. DECLARATION OF SIMILARITY	38

**SIEMIC, INC.**

Title: EMC Test Report for Wireless router
 Main Model: FIR302E
 Serial Model: N/A
 To: FCC Part 15 Subpart B Class B: 2013 , ANSI C63.4:2009

Report No.: 14050049-FCC-E
 Issue Date: July 14, 2014
 Page: 5 of 38
 www.siemic.com.cn

1 EXECUTIVE SUMMARY & EUT INFORMATION

The purpose of this test programme was to demonstrate compliance of the Shanghai Feixun Communication Co., Ltd., Wireless router and Model: FIR302E against the current Stipulated Standards. The Wireless router has demonstrated compliance with the FCC Part 15 Subpart B Class B: 2013, ANSI C63.4: 2009.

EUT Information

EUT Description	Wireless router
Main Model	FIR302E
Serial Model	N/A
Antenna Gain	WIFI Antenna 1: 5 dBi(Transmitter) WIFI Antenna 2: 5 dBi(Transmitter)
Input Power	Adapter 1: Model: RD1200500-C55-8MG Input: AC 100-240V 250mA Output: DC 12V 0.5A Adapter 2: Model: PSAA06A-120 Input: AC 100-240V 0.2A Output: DC 12V 500mA
Classification Per Stipulated Test Standard	Per FCC Part 15 Subpart B Class B: 2013, ANSI C63.4: 2009

Revision Number	Model	Report Number	Description of Revision	Date of Revision
0	FIR302B	14050026-FCC-E	Original Report	June 09, 2014
1	FIR302E	14050049-FCC-E	Amended Report	July 14, 2014

Note: This is the amended report application (14050049-FCC-E) of the device, the original submission (14050026-FCC-H1) was granted on June 16, 2014. The difference between the original device and the current one was as following the detail information:

The difference of these two models is different Appearance Size and Antenna Color.

**SIEMIC, INC.**

Title: EMC Test Report for Wireless router
 Main Model: FIR302E
 Serial Model: N/A
 To: FCC Part 15 Subpart B Class B: 2013 , ANSI C63.4:2009

Report No.: 14050049-FCC-E
 Issue Date: July 14, 2014
 Page: 6 of 38
 www.siemic.com.cn

2 TECHNICAL DETAILS

Purpose	Compliance testing of Wireless router with stipulated standards
Applicant / Client	Shanghai Feixun Communication Co., Ltd. No.3666,Sixian Rd.,Songjiang District,Shanghai,P.R.China
Manufacturer	Shanghai Feixun Communication Co., Ltd. No.3666,Sixian Rd.,Songjiang District,Shanghai,P.R.China
Laboratory performing the tests	SIEMIC (Nanjing-China) Laboratories NO.2-1,Longcang Dadao, Yuhua Economic Development Zone, Nanjing, China Tel: +86(25)86730128/86730129 Fax: +86(25)86730127 Email: China@siemic.com.cn
Test report reference number	14050049-FCC-E
Date EUT received	July 04, 2014
Standard applied	FCC Part 15 Subpart B Class B: 2013, ANSI C63.4: 2009
Dates of test (from – to)	May 20, 2014
No of Units	#1
Trade Name	PHICOMM
RF Operating Frequency (ies)	WIFI: 802.11b/g/n(20M): 2412-2462 MHz 802.11n(40M): 2422-2452 MHz
Number of Channels	802.11b/g/n(20M): 11CH 802.11n(40M): 7CH
Modulation	802.11b/g/n: CCK/OFDM
Port	Power Port, LAN*4 Port, WAN Port
FCC ID	YJYFIR300



SIEMIC, INC.

Title: EMC Test Report for Wireless router
Main Model: FIR302E
Serial Model: N/A
To: FCC Part 15 Subpart B Class B: 2013 , ANSI C63.4:2009

Report No.: 14050049-FCC-E
Issue Date: July 14, 2014
Page: 7 of 38
www.siemie.com.cn

3 MODIFICATION

NONE

4 TEST SUMMARY

The product was tested in accordance with the following specifications.
 All testing has been performed according to below product classification:

**Class B Emission Product
 Test Results Summary**

Emissions			
Test Standard	Description	Product Class	Pass / Fail
FCC Part 15 Subpart B Class B: 2013, ANSI C63.4: 2009	Conducted Emissions	See Above	Pass
FCC Part 15 Subpart B Class B: 2013, ANSI C63.4: 2009	Radiated Emissions	See Above	Pass

All measurement uncertainty is not taken into consideration for all presented test result.



5 MEASUREMENTS, EXAMINATION AND DERIVED RESULTS

5.1 Conducted Emissions Test Result

Note:

1. All possible modes of operation were investigated. Only the several worst case emissions measured, using the correct CISPR and Average detectors, are reported. All other emissions were relatively insignificant.
2. A "-ve" margin indicates a PASS as it refers to the margin present below the limit line at the particular frequency.
3. Conducted Emissions Measurement Uncertainty
All test measurements carried out are traceable to national standards. The uncertainty of the measurement at a confidence level of approximately 95% (in the case where distributions are normal), with a coverage factor of 2, in the range 9kHz – 30MHz (Average & Quasi-peak) is $\pm 3.86\text{dB}$.
4. Environmental Conditions

Temperature	20°C
Relative Humidity	50%
Atmospheric Pressure	1009mbar
5. Test date : May 20, 2014
Tested By : Amos Xia

Test Result: Pass

Test Mode:	Normal Working (Adapter: RD1200500-C55-8MG)
-------------------	--

Peak Detector		Quasi Peak Limit	
Average Detector		Average Limit	

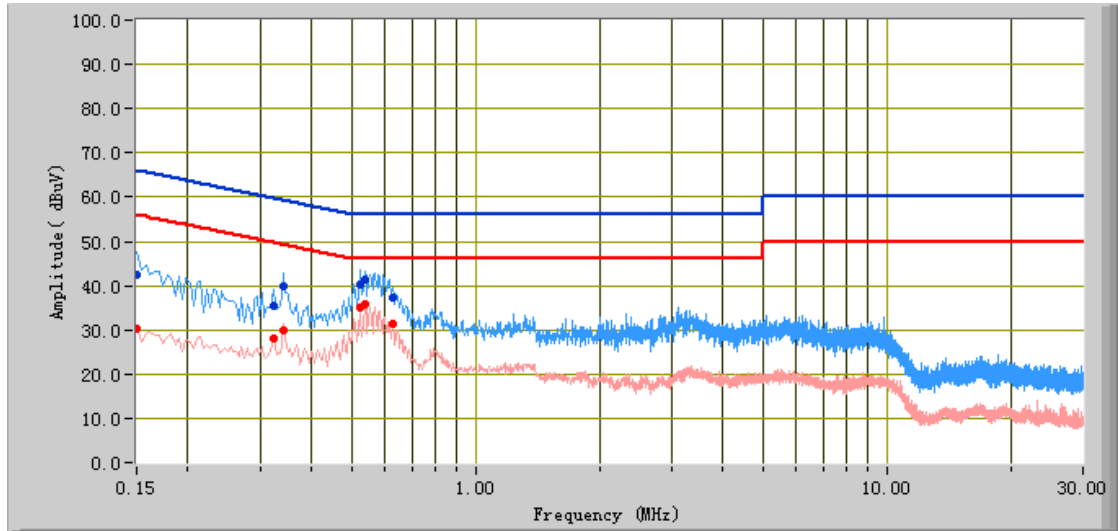

Test Data

Phase Line Plot at 120V AC, 60Hz

Frequency (MHz)	Quasi Peak (dBµV/m)	Limit (dBµV/m)	Margin (dB)	Average (dBµV/m)	Limit (dBµV/m)	Margin (dB)	Factors (dB)
0.52	40.11	56.00	-15.89	34.89	46.00	-11.11	11.07
0.54	41.19	56.00	-14.81	35.61	46.00	-10.39	11.06
0.34	39.82	59.16	-19.34	30.07	49.16	-19.09	11.32
0.63	37.35	56.00	-18.65	31.35	46.00	-14.65	10.98
0.15	42.52	66.00	-23.48	30.33	56.00	-25.67	12.22
0.32	35.55	59.66	-24.11	27.88	49.66	-21.77	11.35

Test Mode:	Normal Working (Adapter: RD1200500-C55-8MG)
-------------------	--

Peak Detector  **Quasi Peak Limit** 
Average Detector  **Average Limit** 

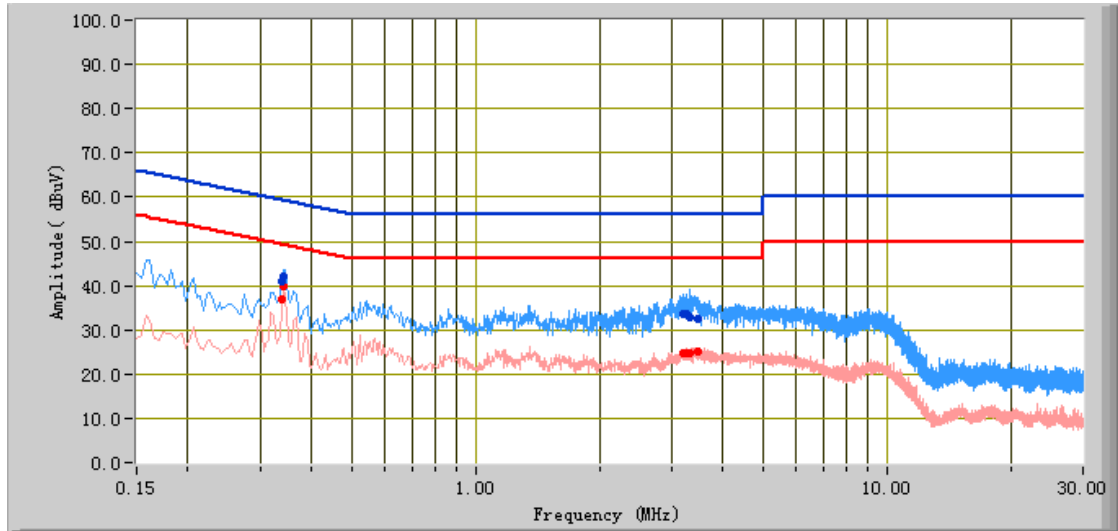

Test Data

Phase Natural Plot at 120V AC, 60Hz

Frequency (MHz)	Quasi Peak (dBµV/m)	Limit (dBµV/m)	Margin (dB)	Average (dBµV/m)	Limit (dBµV/m)	Margin (dB)	Factors (dB)
0.34	42.04	59.16	-17.12	39.95	49.16	-9.21	11.31
0.34	40.86	59.25	-18.39	36.99	49.25	-12.26	11.32
3.32	32.85	56.00	-23.15	24.61	46.00	-21.39	10.93
3.25	33.56	56.00	-22.44	24.89	46.00	-21.11	10.93
3.20	33.54	56.00	-22.46	24.68	46.00	-21.32	10.93
3.47	32.57	56.00	-23.43	24.94	46.00	-21.06	10.94

Test Mode:	Normal Working (Adapter: PSAA06A-120)
-------------------	--

Peak Detector		Quasi Peak Limit	
Average Detector		Average Limit	

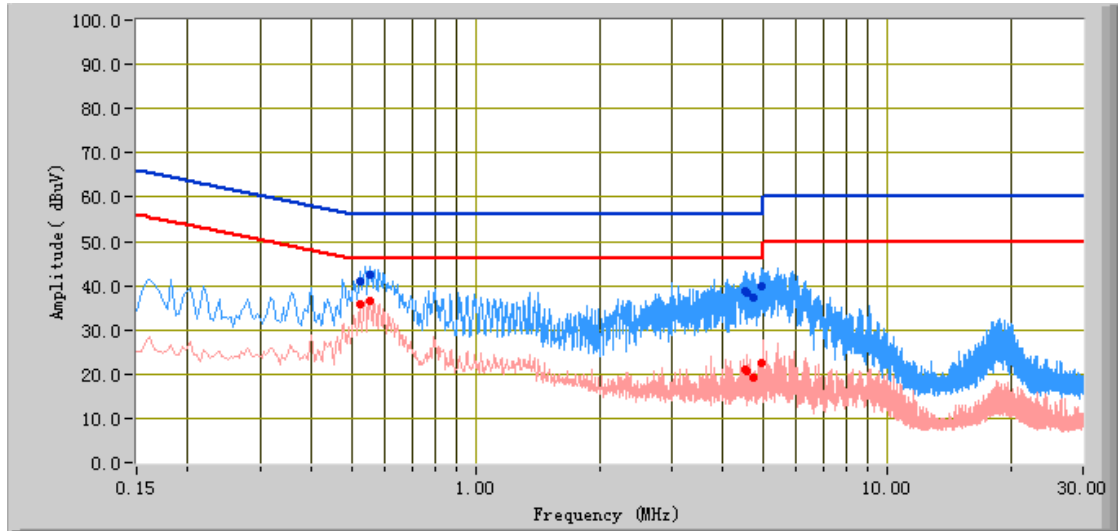

Test Data

Phase Line Plot at 120V AC, 60Hz

Frequency (MHz)	Quasi Peak (dBµV/m)	Limit (dBµV/m)	Margin (dB)	Average (dBµV/m)	Limit (dBµV/m)	Margin (dB)	Factors (dB)
0.55	42.29	56.00	-13.71	36.56	46.00	-9.44	11.04
4.97	40.00	56.00	-16.00	22.36	46.00	-23.64	10.89
4.54	38.78	56.00	-17.22	21.12	46.00	-24.88	10.89
0.52	41.04	56.00	-14.96	35.93	46.00	-10.07	11.07
4.58	38.45	56.00	-17.55	20.53	46.00	-25.47	10.89
4.75	37.35	56.00	-18.65	19.29	46.00	-26.71	10.89

Test Mode:	Normal Working (Adapter: PSAA06A-120)
-------------------	--

Peak Detector  **Quasi Peak Limit** 
Average Detector  **Average Limit** 

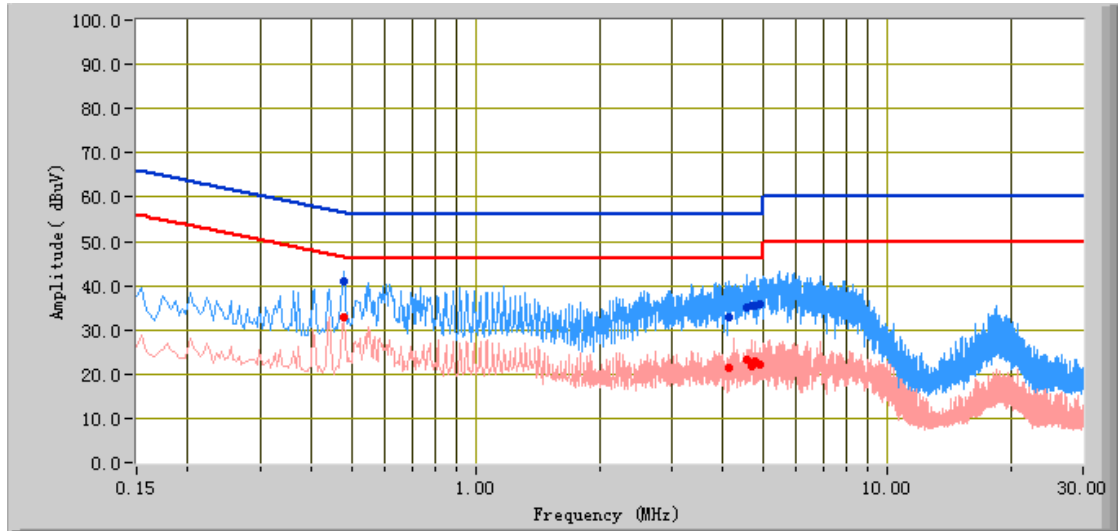



Test Data

Phase Natural Plot at 120V AC, 60Hz

Frequency (MHz)	Quasi Peak (dBµV/m)	Limit (dBµV/m)	Margin (dB)	Average (dBµV/m)	Limit (dBµV/m)	Margin (dB)	Factors (dB)
0.48	40.78	56.37	-15.59	32.99	46.37	-13.39	11.09
4.57	35.20	56.00	-20.80	23.12	46.00	-22.88	10.95
4.77	35.38	56.00	-20.62	22.89	46.00	-23.11	10.95
4.93	35.70	56.00	-20.30	22.07	46.00	-23.93	10.95
4.13	32.71	56.00	-23.29	21.44	46.00	-24.56	10.94
4.70	35.44	56.00	-20.56	21.78	46.00	-24.22	10.95

Test Mode:	Normal Working (Adapter: RD1200500-C55-8MG)
-------------------	--

Below 1GHz

Peak Detector 
 Quasi Peak Limit 

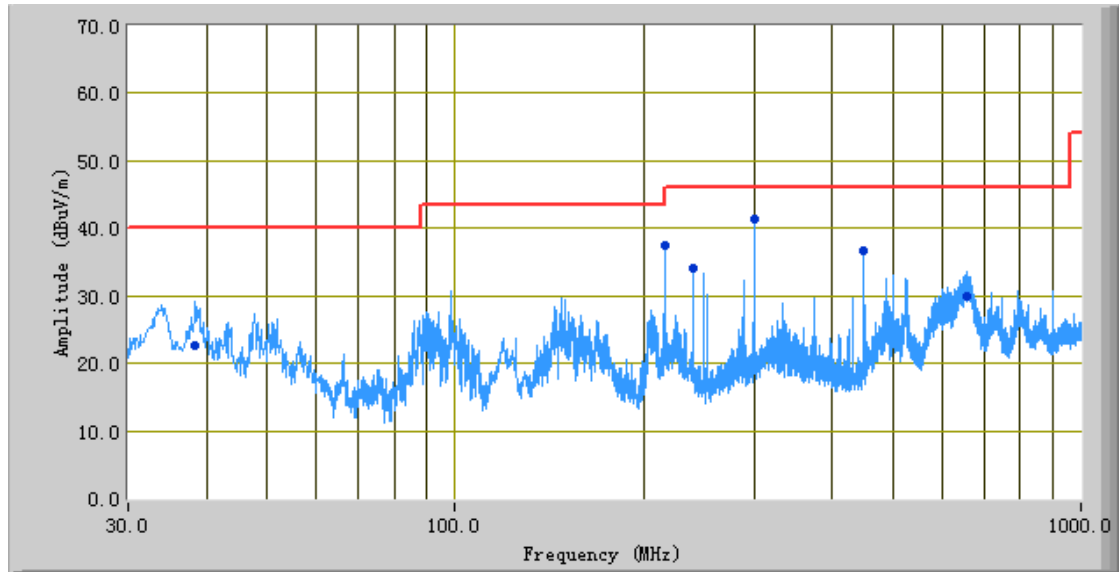

Test Data



Vertical & Horizontal Polarity Plot at 3m

Frequency (MHz)	Quasi Peak (dB μ V/m)	Azimuth	Polarity (H/V)	Height (cm)	Factors (dB)	Limit (dB μ V/m)	Margin (dB)
216.40	37.49	124.00	H	139.00	-33.89	46.00	-8.51
450.00	36.67	194.00	V	111.00	-30.25	46.00	-9.33
38.32	22.55	151.00	V	103.00	-27.94	40.00	-17.45
240.00	34.14	317.00	H	133.00	-33.10	46.00	-11.86
658.56	29.83	342.00	V	112.00	-22.66	46.00	-16.17
300.00	41.46	207.00	H	149.00	-31.63	46.00	-4.54

Note: the data above 1G which below 20dB to the limit was not record.

Test Mode:	Normal Working (Adapter: PSAA06A-120)
-------------------	--

Below 1GHz

Peak Detector 
 Quasi Peak Limit 

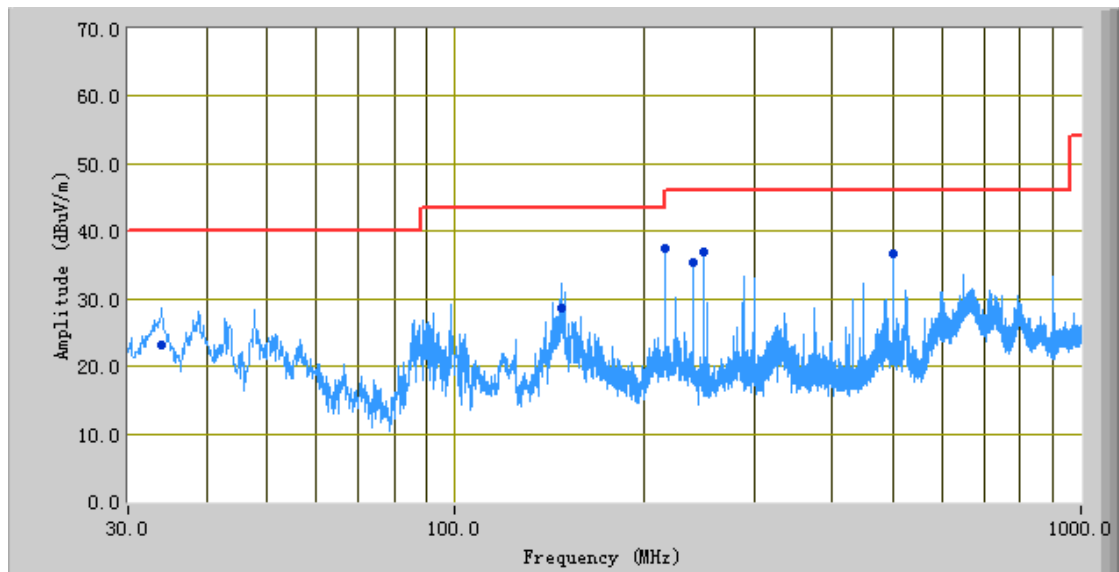

Test Data

Vertical & Horizontal Polarity Plot at 3m

Frequency (MHz)	Quasi Peak (dBµV/m)	Azimuth	Polarity (H/V)	Height (cm)	Factors (dB)	Limit (dBµV/m)	Margin (dB)
500.01	36.77	288.00	V	128.00	-29.70	46.00	-9.23
216.44	37.56	123.00	H	151.00	-33.89	46.00	-8.44
240.00	35.47	316.00	H	132.00	-33.10	46.00	-10.53
148.11	28.54	151.00	H	217.00	-33.40	43.50	-14.96
33.96	23.09	157.00	V	127.00	-25.73	40.00	-16.91
250.01	36.95	226.00	H	136.00	-32.86	46.00	-9.05

Note: the data above 1G which below 20dB to the limit was not record.

**SIEMIC, INC.**

Title: EMC Test Report for Wireless router
 Main Model: FIR302E
 Serial Model: N/A
 To: FCC Part 15 Subpart B Class B: 2013 , ANSI C63.4:2009

Report No.: 14050049-FCC-E
 Issue Date: July 14, 2014
 Page: 17 of 38
 www.siemic.com.cn

Annex A. TEST INSTRUMENTATION & GENERAL PROCEDURES**Annex A.i. TEST INSTRUMENTATION**

Instrument	Model	Serial #	Calibration Date	Calibration Due Date
AC Line Conducted Emissions				
R&S EMI Test Receiver	ESPI3	101216	09/27/2013	09/26/2014
ROHDE&SCHWARZ V-LISN	ESH3-Z5	838979/005	09/27/2013	09/26/2014
Com-Power Transient Limiter	LIT-153	531021	09/27/2013	09/26/2014
SIEMIC Labview Conducted Emissions software	V1.0	N/A	N/A	N/A
Radiated Emissions				
Hp Spectrum Analyzer	8563E	3821A09023	09/27/2013	09/26/2014
R&S EMI Receiver	ESPI3	101216	09/27/2013	09/26/2014
Antenna (30MHz~6GHz)	JB6	A121411	04/15/2014	04/14/2015
ETS-Lindgren Antenna (1 ~18GHz)	3115	N/A	10/09/2013	10/08/2014
A-INFOMW Antenna (1 ~18GHz)	JXTXLB-10180	J2031081120092	10/09/2013	10/08/2014
Horn Antenna (18~40GHz)	AH-840	101013	04/22/2014	04/22/2015
Microwave Pre-Amp (18~40GHz)	PA-840	181250	05/30/2013	05/29/2014
Hp Agilent Pre-Amplifier	8447F	1937A01160	10/27/2013	10/26/2014
MITEQ Pre-Amplifier (0.1 ~ 18GHz)	AMF-7D-00101800-30-10P	1451709	10/27/2013	10/26/2014
Chamber	3m	N/A	04/13/2014	04/12/2015
SIEMIC Labview Radiated Emissions software	V1.0	N/A	N/A	N/A

Annex A.ii. AC LINE CONDUCTED EMISSIONS TEST DESCRIPTION

Test Set-up

1. The EUT and supporting equipment were set up in accordance with the requirements of the standard on top of a 1.5m x 1m x 0.8m high, non-metallic table, as shown in Annex B.
2. The power supply for the EUT was fed through a 50Ω/50μH EUT LISN, connected to filtered mains.
3. The RF OUT of the EUT LISN was connected to the EMI test receiver via a low-loss coaxial cable.
4. All other supporting equipments were powered separately from another main supply.

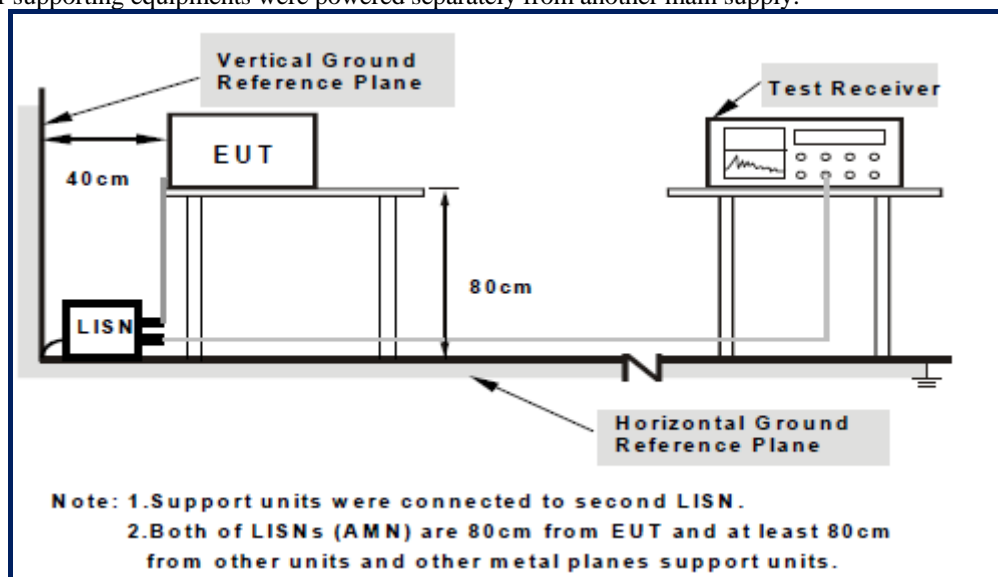

For the actual test configuration, please refer to the related item – Photographs of the Test Configuration1

Test Method

1. The EUT was switched on and allowed to warm up to its normal operating condition.
2. A scan was made on the NEUTRAL line (for AC mains) or Earth line (for DC power) over the required frequency range using an EMI test receiver.
3. High peaks, relative to the limit line, were then selected.
4. The EMI test receiver was then tuned to the selected frequencies and the necessary measurements made with a receiver bandwidth setting of 10 kHz. For FCC tests, only Quasi-peak measurements were made; while for CISPR/EN tests, both Quasi-peak and Average measurements were made.
5. Steps 2 to 4 were then repeated for the LIVE line (for AC mains) or DC line (for DC power).

Description of Conducted Emission Program

This EMC Measurement software run LabView automation software and offers a common user interface for electromagnetic interference (EMI) measurements. This software is a modern and powerful tool for controlling and monitoring EMI test receivers and EMC test systems. It guarantees reliable collection, evaluation, and documentation of measurement results. Basically, this program will run a pre-scan measurement before it proceeds with the final measurement. The pre-scan routine will run the common scan range from 150 kHz to 30 MHz; the program will first start a peak and average scan on selectable measurement time and step size. After the program complete the pre-scan, this program will perform the Quasi Peak and Average measurement, based on the pre-scan peak data reduction result.



SIEMIC, INC.

Title: EMC Test Report for Wireless router
Main Model: FIR302E
Serial Model: N/A
To: FCC Part 15 Subpart B Class B: 2013 , ANSI C63.4:2009

Report No.: 14050049-FCC-E
Issue Date: July 14, 2014
Page: 19 of 38
www.siemic.com.cn

Sample Calculation Example

At 20 MHz

limit = $250 \mu\text{V} = 47.96 \text{ dB}\mu\text{V}$

Transducer factor of LISN, pulse limiter & cable loss at 20 MHz = 11.20 dB

Q-P reading obtained directly from EMI Receiver = 40.00 dB μV
(Calibrated for system losses)

Therefore, Q-P margin = $47.96 - 40.00 = 7.96$ i.e. **7.96 dB below limit**

Annex A. iii. RADIATED EMISSIONS TEST DESCRIPTION

EUT Characterisation

EUT characterisation, over the frequency range from 30MHz to 10th Harmonic, was done in order to minimise radiated emissions testing time while still maintaining high confidence in the test results.

The EUT was placed in the chamber, at a height of about 0.8 m on a turntable. Its radiated emissions frequency profile was observed, using a spectrum analyzer /receiver with the appropriate broadband antenna placed 3m away from the EUT. Radiated emissions from the EUT were maximised by rotating the turntable manually, changing the antenna polarisation and manipulating the EUT cables while observing the frequency profile on the spectrum analyzer / receiver. Frequency points at which maximum emissions occurred; clock frequencies and operating frequencies were then noted for the formal radiated emissions test at the Open Area Test Site (OATS) or 3m EMC chamber.

Test Set-up

1. The EUT and supporting equipment were set up in accordance with the requirements of the standard on top of a 1.5mX1.0mX0.8m high, non-conductive table.
2. The filtered power supply for the EUT and supporting equipment were tapped from the appropriate power sockets located on the turntable.
3. The relevant broadband antenna was set at the required test distance away from the EUT and supporting equipment boundary.

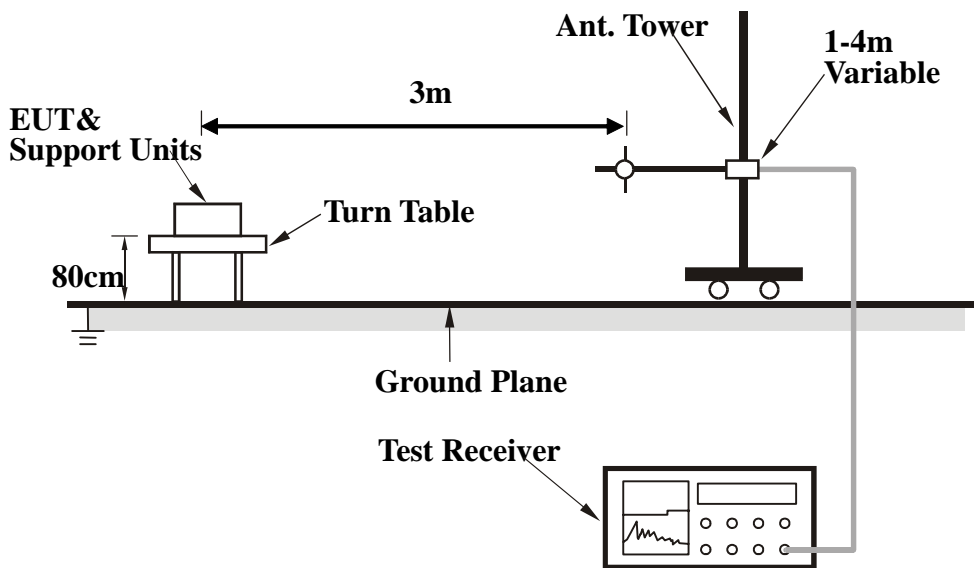

For the actual test configuration, please refer to the related item – Photographs of the Test Configuration2



Test Method

The following procedure was performed to determine the maximum emission axis of EUT:

1. With the receiving antenna is H polarization, rotate the EUT in turns with three orthogonal axes to determine the axis of maximum emission.
2. With the receiving antenna is V polarization, rotate the EUT in turns with three orthogonal axes to determine the axis of maximum emission.
3. Compare the results derived from above two steps. So, the axis of maximum emission from EUT was determined and the configuration was used to perform the final measurement.

Final Radiated Emission Measurement

1. Setup the configuration according to figure 1. Turn on EUT and make sure that it is in normal function.
2. For emission frequencies measured below 1GHz, a pre-scan is performed in a shielded chamber to determine the accurate frequencies of higher emissions will be checked on an open test site. As the same purpose, for emission frequencies measured above 1GHz, a pre-scan also be performed with a 1 meter measuring distance before final test.
3. For emission frequencies measured below and above 1GHz, set the spectrum analyzer on a 100kHz and 1MHz resolution bandwidth respectively for each frequency measured in step 2.
4. The search antenna is to be raised and lowered over a range from 1 to 4 meters in horizontally polarized orientation. Position the height when the highest value is indicated on spectrum analyzer, then change the orientation of EUT on test table over a range from 0° to 360° with a speed as slow as possible, and keep the azimuth that highest emission is indicated on the spectrum analyzer. Vary the antenna position again and record the highest value as a final reading.
5. Repeat step 4 until all frequencies need to be measured was complete.
6. Repeat step 5 with search antenna in vertical polarized orientations.

During the radiated emission test, the Spectrum Analyzer was set with the following configurations:

Frequency Band (MHz)	Function	Resolution bandwidth	Video Bandwidth
30 to 1000	Peak	100kHz	100kHz
Above 1000	Peak	1MHz	1MHz
	Average	1MHz	10Hz

Sample Calculation Example

The field strength is calculated by adding the Antenna Factor and Cable Factor, and subtracting the Amplifier Gain (if any) from the measured reading. For the limit is employed average value, therefore the peak value can be transferred to average value by subtracting the duty factor. The basic equation with a sample calculation is as follows:

$$\text{Peak} = \text{Reading} + \text{Corrected Factor}$$

where

$$\text{Corr. Factor} = \text{Antenna Factor} + \text{Cable Factor} - \text{Amplifier Gain (if any)}$$

And the average value is

$$\text{Average} = \text{Peak Value} + \text{Duty Factor or}$$

$$\text{Set RBW} = 1\text{MHz, VBW} = 10\text{Hz.}$$

Note:

If the measured frequencies are fall in the restricted frequency band, the limit employed must be quasi peak value when frequencies are below or equal to 1GHz. And the measuring instrument is set to quasi peak detector function.



SIEMIC, INC.

Title: EMC Test Report for Wireless router
Main Model: FIR302E
Serial Model: N/A
To: FCC Part 15 Subpart B Class B: 2013 , ANSI C63.4:2009

Report No.: 14050049-FCC-E
Issue Date: July 14, 2014
Page: 22 of 38
www.siemic.com.cn

Annex B. EUT AND TEST SETUP PHOTOGRAPHS

Annex B.i. Photograph : EUT External Photo



All Packages – Front View



SIEMIC, INC.

Title: EMC Test Report for Wireless router
Main Model: FIR302E
Serial Model: N/A
To: FCC Part 15 Subpart B Class B: 2013 , ANSI C63.4:2009

Report No.: 14050049-FCC-E
Issue Date: July 14, 2014
Page: 23 of 38
www.siemic.com.cn



EUT - Front View



EUT - Rear View



SIEMIC, INC.

Title: EMC Test Report for Wireless router
Main Model: FIR302E
Serial Model: N/A
To: FCC Part 15 Subpart B Class B: 2013 , ANSI C63.4:2009

Report No.: 14050049-FCC-E
Issue Date: July 14, 2014
Page: 24 of 38
www.siemic.com.cn



EUT – Top View

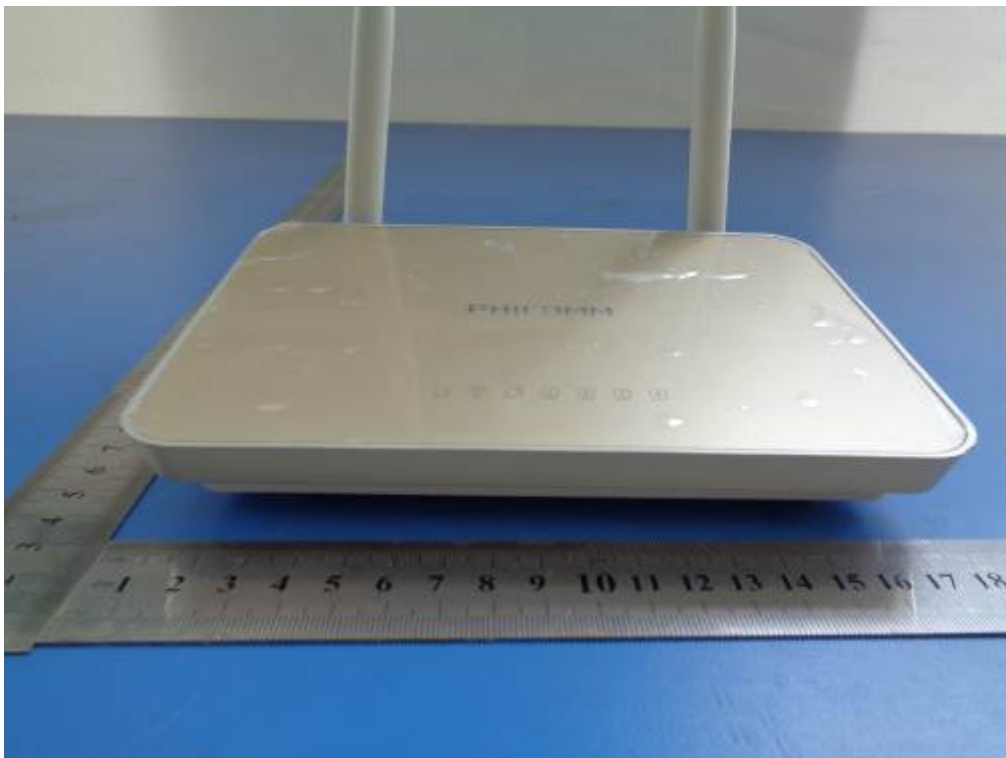

EUT – Bottom View



SIEMIC, INC.

Title: EMC Test Report for Wireless router
Main Model: FIR302E
Serial Model: N/A
To: FCC Part 15 Subpart B Class B: 2013 , ANSI C63.4:2009

Report No.: 14050049-FCC-E
Issue Date: July 14, 2014
Page: 25 of 38
www.siemic.com.cn

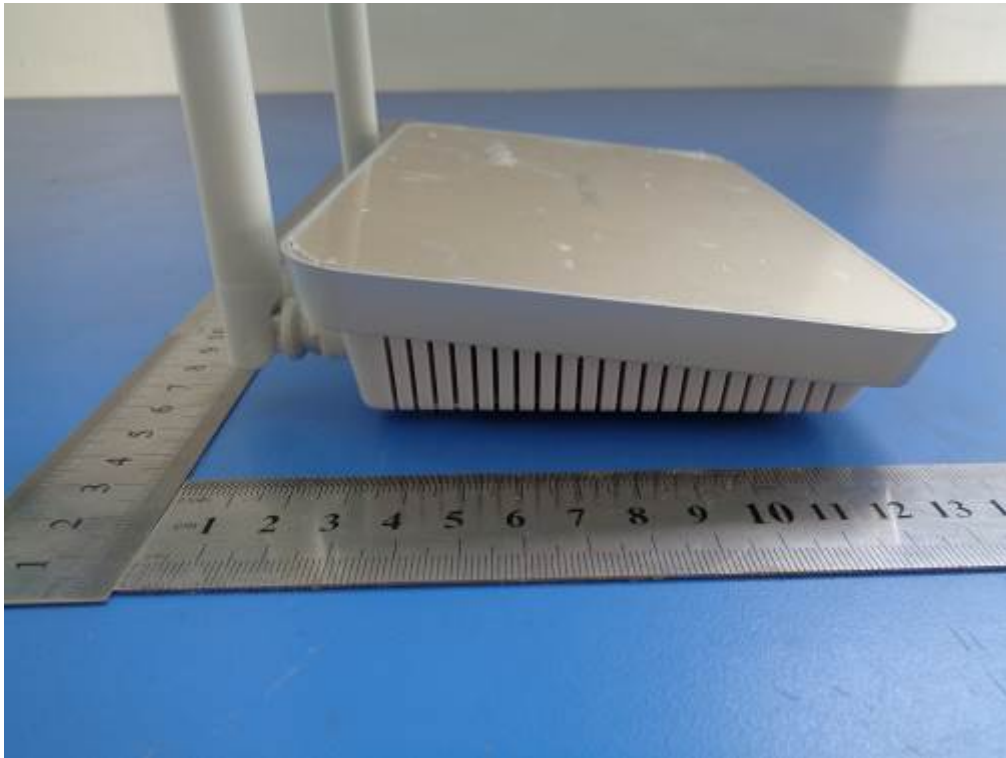

EUT – Left View



EUT – Right View

Annex B.ii. Photograph 2: EUT Internal Photo

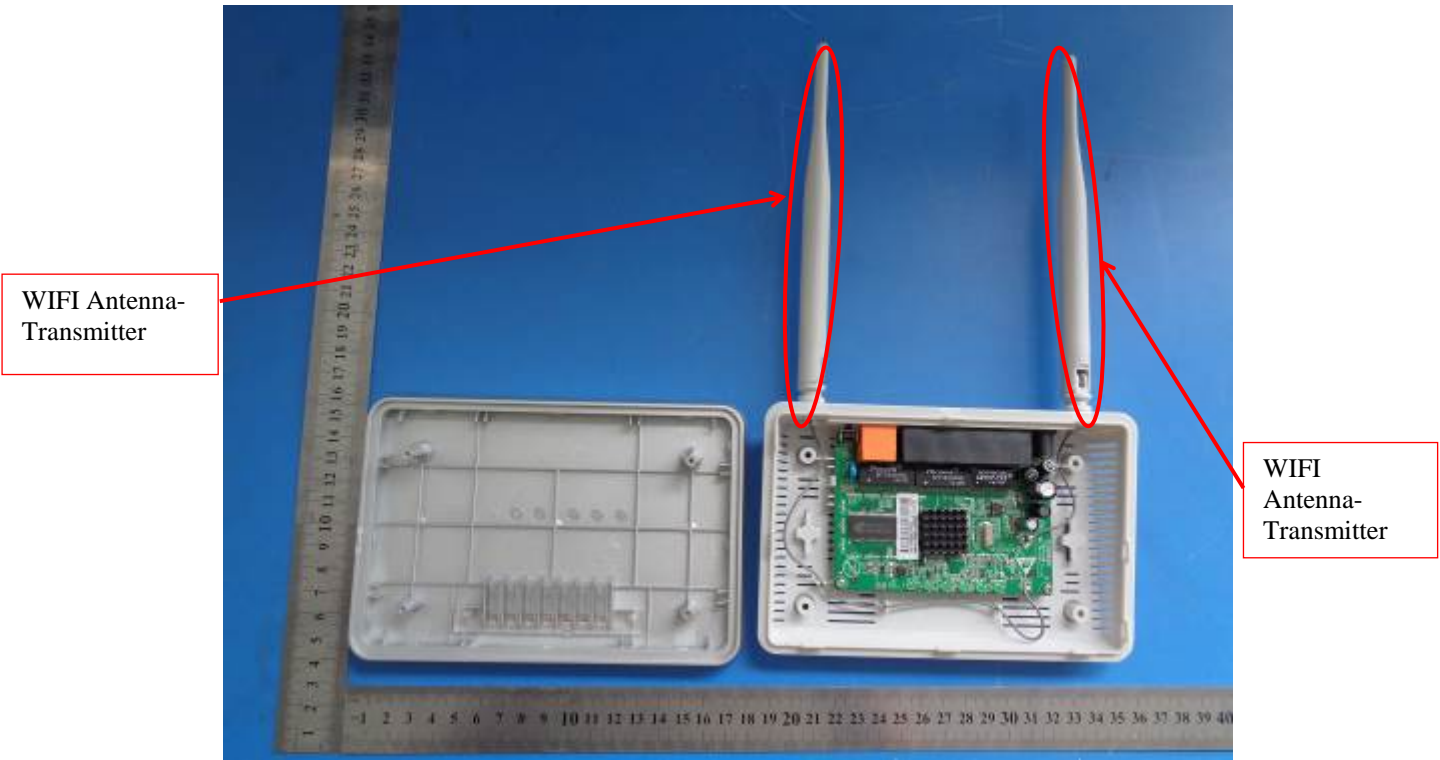

EUT – Uncover Front View 1

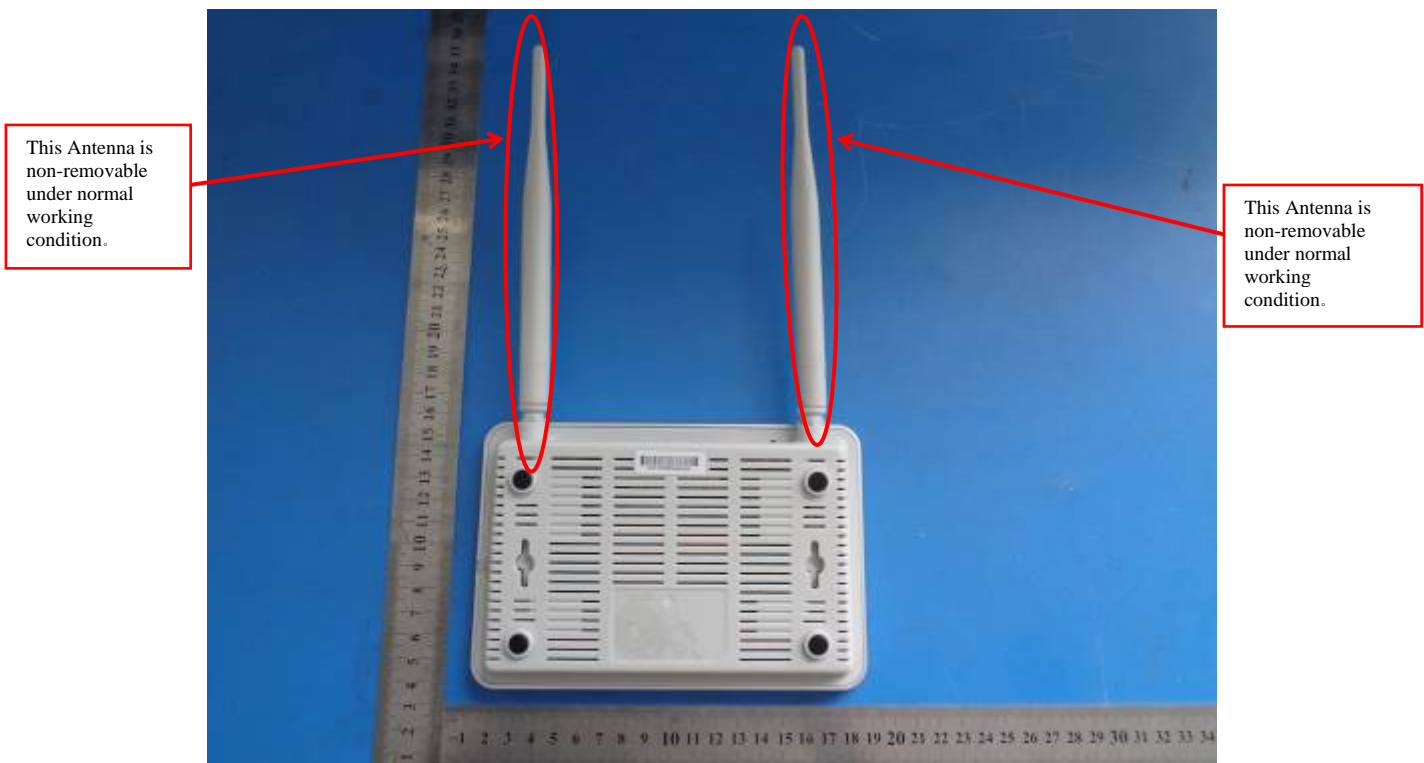

EUT – Uncover Front View 2



SIEMIC, INC.

Title: EMC Test Report for Wireless router
Main Model: FIR302E
Serial Model: N/A
To: FCC Part 15 Subpart B Class B: 2013 , ANSI C63.4:2009

Report No.: 14050049-FCC-E
Issue Date: July 14, 2014
Page: 27 of 38
www.siemec.com.cn



EUT – PCB Front View

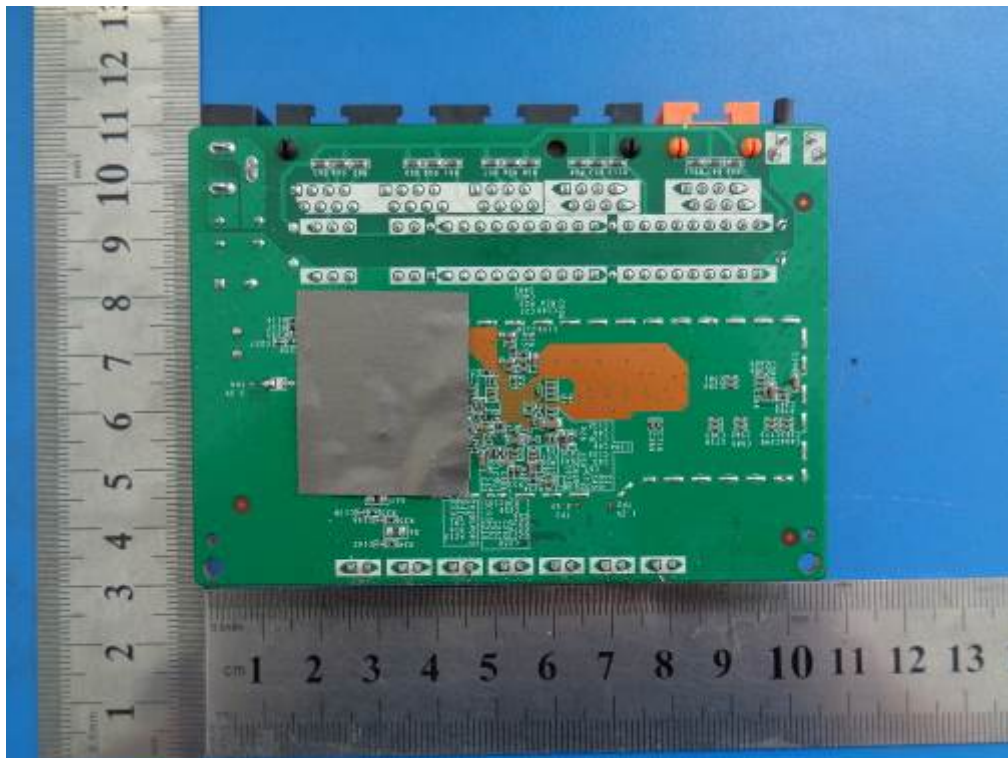

EUT – PCB Rear View



SIEMIC, INC.

Title: EMC Test Report for Wireless router
Main Model: FIR302E
Serial Model: N/A
To: FCC Part 15 Subpart B Class B: 2013 , ANSI C63.4:2009

Report No.: 14050049-FCC-E
Issue Date: July 14, 2014
Page: 28 of 38
www.siemic.com.cn

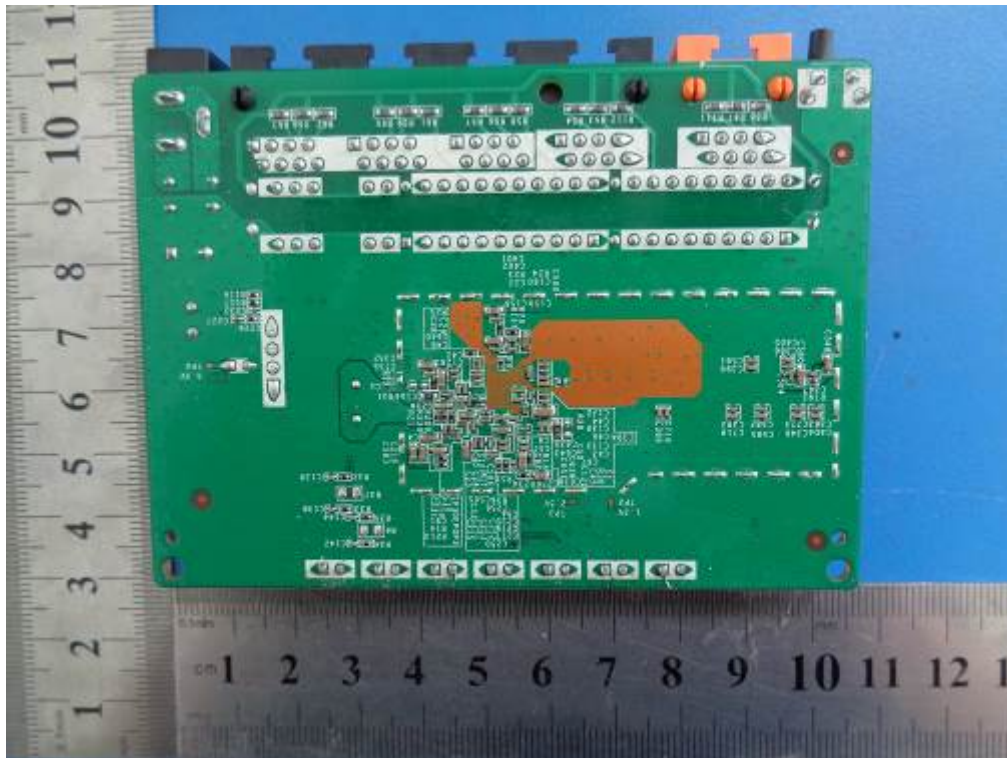

EUT – PCB Rear View(without shielding)



SIEMIC, INC.

Title: EMC Test Report for Wireless router
Main Model: FIR302E
Serial Model: N/A
To: FCC Part 15 Subpart B Class B: 2013 , ANSI C63.4:2009

Report No.: 14050049-FCC-E
Issue Date: July 14, 2014
Page: 29 of 38
www.siemic.com.cn

Annex B.iii. Photograph 3: Test Setup Photo



Conducted Emissions Test Setup Front View-Adapter: RD1200500-C55-8MG



Conducted Emissions Test Setup Side View-Adapter: RD1200500-C55-8MG



SIEMIC, INC.

Title: EMC Test Report for Wireless router
Main Model: FIR302E
Serial Model: N/A
To: FCC Part 15 Subpart B Class B: 2013 , ANSI C63.4:2009

Report No.: 14050049-FCC-E
Issue Date: July 14, 2014
Page: 30 of 38
www.siemic.com.cn



Conducted Emissions Test Setup Front View-Adapter: PSAA06A-120



Conducted Emissions Test Setup Side View-Adapter: PSAA06A-120



SIEMIC, INC.

Title: EMC Test Report for Wireless router
Main Model: FIR302E
Serial Model: N/A
To: FCC Part 15 Subpart B Class B: 2013 , ANSI C63.4:2009

Report No.: 14050049-FCC-E
Issue Date: July 14, 2014
Page: 31 of 38
www.siemic.com.cn



Radiated Emissions Test Setup Below 1GHz - -Adapter: RD1200500-C55-8MG

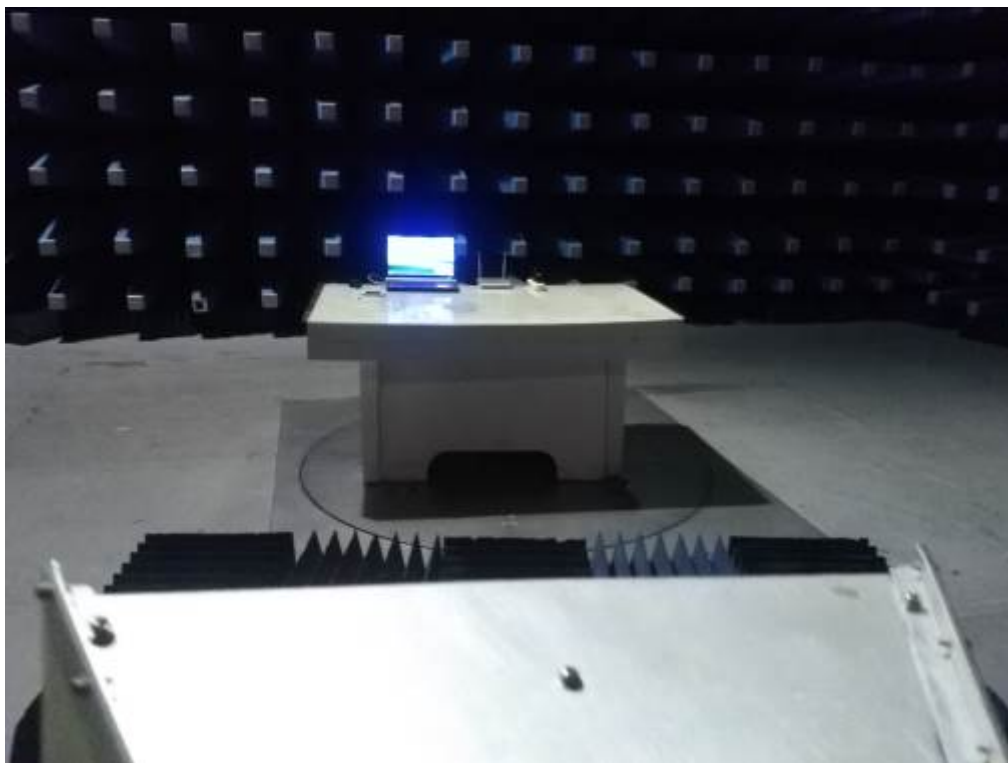

Radiated Emissions Test Setup Above 1GHz--Adapter: RD1200500-C55-8MG



SIEMIC, INC.

Title: EMC Test Report for Wireless router
Main Model: FIR302E
Serial Model: N/A
To: FCC Part 15 Subpart B Class B: 2013 , ANSI C63.4:2009

Report No.: 14050049-FCC-E
Issue Date: July 14, 2014
Page: 32 of 38
www.siemic.com.cn



Radiated Emissions Test Setup Below 1GHz - -Adapter: PSAA06A-120

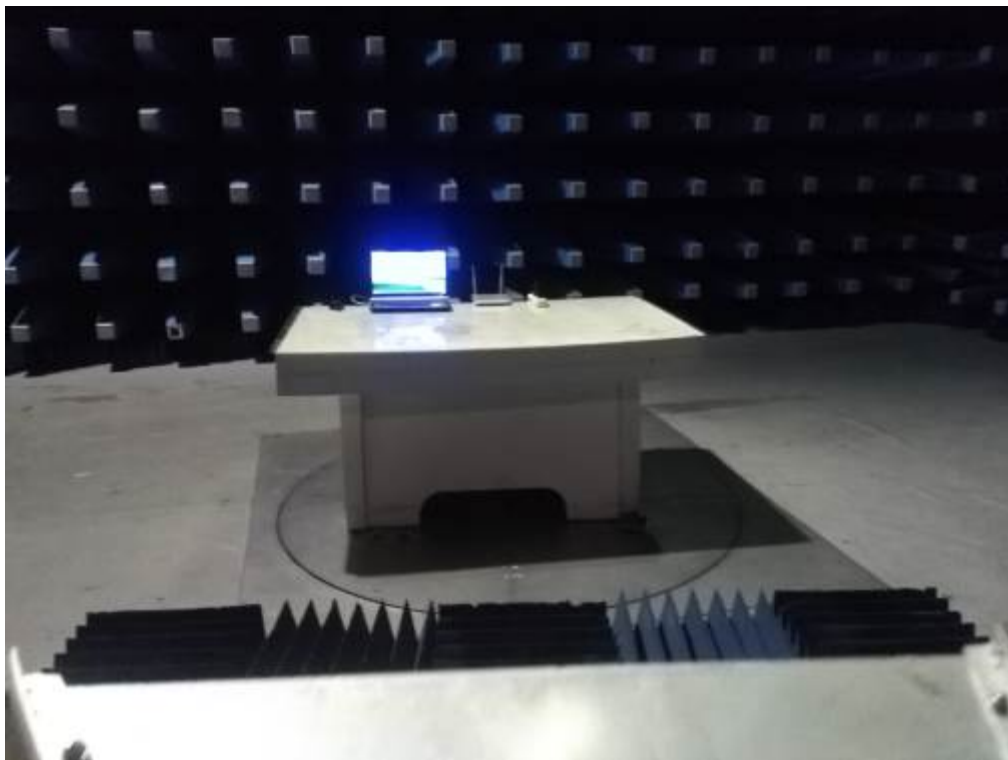

Radiated Emissions Test Setup Above 1GHz--Adapter: PSAA06A-120

**SIEMIC, INC.**

Title: EMC Test Report for Wireless router
Main Model: FIR302E
Serial Model: N/A
To: FCC Part 15 Subpart B Class B: 2013 , ANSI C63.4:2009

Report No.: 14050049-FCC-E
Issue Date: July 14, 2014
Page: 33 of 38
www.siemic.com.cn

Annex C. TEST SETUP AND SUPPORTING EQUIPMENT**EUT TEST CONDITIONS****Annex C. i. SUPPORTING EQUIPMENT DESCRIPTION**

The following is a description of supporting equipment and details of cables used with the EUT.

Manufacturer	Equipment Description (Including Brand Name)	Model	Calibration Due Date
Gateway	Laptop	MS2288 & LXWHF02013951C3CA 92200	N/A



Block Configuration Diagram for Conducted Emissions

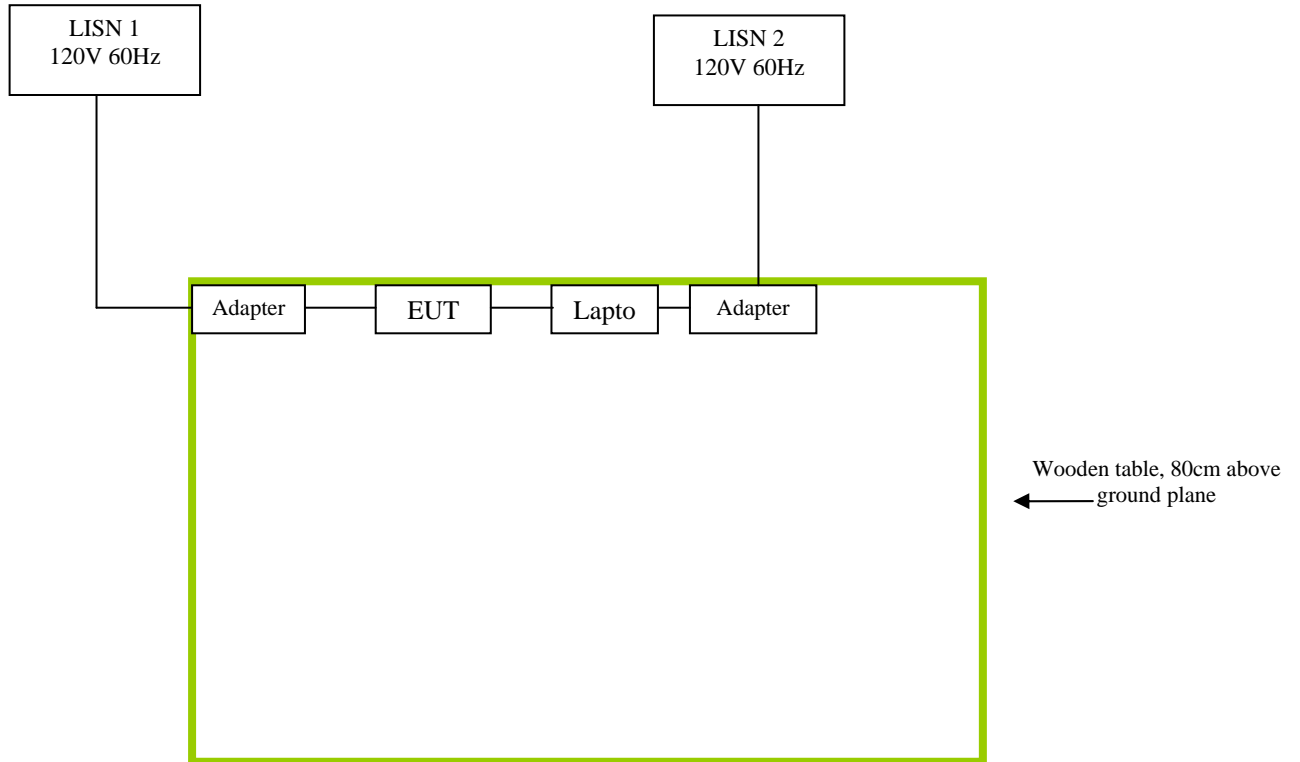



Block Configuration Diagram for Radiated Emission

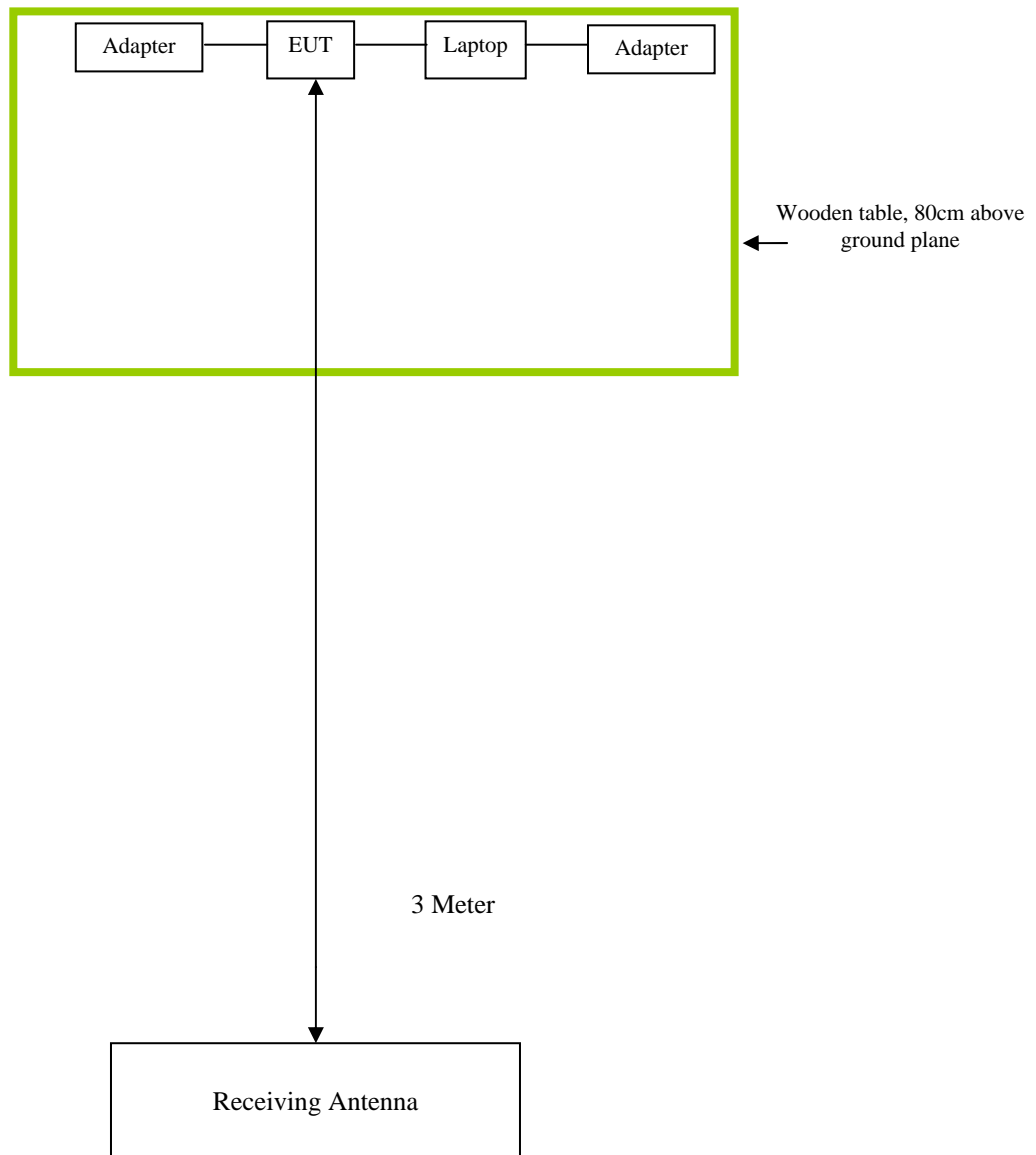

**SIEMIC, INC.**

Title: EMC Test Report for Wireless router
Main Model: FIR302E
Serial Model: N/A
To: FCC Part 15 Subpart B Class B: 2013 , ANSI C63.4:2009

Report No.: 14050049-FCC-E
Issue Date: July 14, 2014
Page: 36 of 38
www.siemic.com.cn

Annex C.ii. EUT OPERATING CONDITIONS

The following is the description of how the EUT is exercised during testing.

Test	Description Of Operation
Emissions	Normal Working (Adapter: PSAA06A-120) Normal Working (Adapter: RD1200500-C55-8MG)



SIEMIC, INC.

Title: EMC Test Report for Wireless router
Main Model: FIR302E
Serial Model: N/A
To: FCC Part 15 Subpart B Class B: 2013 , ANSI C63.4:2009

Report No.: 14050049-FCC-E
Issue Date: July 14, 2014
Page: 37 of 38
www.siemie.com.cn

Annex D. USER MANUAL / BLOCK DIAGRAM / SCHEMATICS / PART LIST

Please see attachment



SIEMIC, INC.

Title: EMC Test Report for Wireless router
Main Model: FIR302E
Serial Model: N/A
To: FCC Part 15 Subpart B Class B: 2013 , ANSI C63.4:2009

Report No.: 14050049-FCC-E
Issue Date: July 14, 2014
Page: 38 of 38
www.siemic.com.cn

Annex E. DECLARATION OF SIMILARITY

(Shanghai Feixun Communication CO.,Ltd.)

To SIEMIC Inc
775 Montague Expressway Milpitas, CA 95035

Statement

We, Shanghai Feixun Communication Co., Ltd. apply a class II permissive change certification for the below models.

Product Name: Wireless router

Model number: FIR302E

FCC ID: YJYFIR300

We hereby state that these models are identical in interior structure, electrical circuits and PCB layout; Only the appearance size and Antenna Color is different.

Your assistance on this matter is highly appreciated.

Sincerely,
Name: Emmy. Xiong
Title: Certification Engineer
Signature: