



EN 300 328 V2.1.1 (2016-11)

TEST REPORT

For

Vesper Marine Ltd.

45 Sale Street, PO Box 91164,
Freemans Bay, Auckland, New Zealand

Model: XB9010
Similar Model: XB8010

Report Type: Original Report		Product Type: Marine Electronic Device
Prepared By	Frank Wang Test Engineer	<i>Frank Wang</i>
Report Number	R1706276-11	
Report Date	2017-09-27	
Reviewed By	Jin Yang RF Engineer	<i>Jin Yang</i>
Bay Area Compliance Laboratories Corp. 1274 Anvilwood Avenue, Sunnyvale, CA 94089 Tel: (408) 732-9162 Fax: (408) 732 9164		

Note: This test report is prepared for the customer shown above and for the device described herein. It may not be duplicated or used in part without prior written consent from Bay Area Compliance Laboratories Corp. This report **must not** be used by the customer to claim product certification, approval, or endorsement by A2LA* or any agency of the Federal Government.

* This report may contain data that are not covered by the A2LA accreditation and are marked with an asterisk “*”

TABLE OF CONTENTS

1.	GENERAL INFORMATION.....	5
1.1	PRODUCT DESCRIPTION FOR UNIT UNDER TEST (UUT)	5
1.2	MECHANICAL DESCRIPTION OF UUT.....	5
1.3	OBJECTIVE.....	5
1.4	RELATED SUBMITTAL(S)/GRANT(S)	5
1.5	TEST METHODOLOGY	5
1.6	MEASUREMENT UNCERTAINTY	6
1.7	TEST FACILITY REGISTRATIONS	6
1.8	TEST FACILITY ACCREDITATIONS.....	6
2.	UUT TEST CONFIGURATION.....	9
2.1	JUSTIFICATION.....	9
2.2	UUT EXERCISE SOFTWARE	9
2.3	EQUIPMENT MODIFICATIONS.....	9
2.4	SPECIAL EQUIPMENT	9
2.5	LOCAL SUPPORT EQUIPMENT	9
2.6	INTERFACE PORTS AND CABLING	9
2.7	POWER SUPPLY AND LINE FILTERS.....	9
3.	SUMMARY OF TEST RESULTS	10
4.	EN 300 328 CLAUSE 4.3.2.9 – TX UNWANTED EMISSIONS IN THE SPURIOUS DOMAIN.....	11
4.1	APPLICABLE STANDARD.....	11
4.2	MEASUREMENT UNCERTAINTY	11
4.3	UUT SETUP	11
4.4	ENVIRONMENTAL CONDITIONS	11
4.5	TEST EQUIPMENT LIST AND DETAILS	12
4.6	MEASUREMENT PROCEDURE	12
4.7	SUMMARY OF TEST RESULTS.....	13
5.	EN 300 328 CLAUSE 4.3.2.11 – RECEIVER BLOCKING.....	14
5.1	APPLICABLE STANDARD.....	14
5.2	MEASUREMENT PROCEDURE	16
5.3	TEST EQUIPMENT LIST AND DETAILS	17
5.4	ENVIRONMENTAL CONDITIONS	17
5.5	TEST RESULTS	18
6.	ANNEX A (NORMATIVE) – PROPOSED PRODUCT LABELING.....	19
6.1	LABEL INFORMATION	19
6.2	UUT LABEL LOCATION	20
7.	ANNEX B (NORMATIVE) - TEST SETUP PHOTOGRAPHS	21
7.1	RADIATED EMISSION BELOW 1 GHZ FRONT VIEW.....	21
7.2	RADIATED EMISSION BELOW 1 GHZ REAR VIEW	21
7.3	RADIATED EMISSION ABOVE 1 GHZ FRONT VIEW	22
7.4	RADIATED EMISSION ABOVE 1 GHZ REAR VIEW.....	22
8.	ANNEX C (NORMATIVE) – UUT PHOTOGRAPHS.....	23
8.1	UUT – TOP VIEW	23
8.2	UUT – BOTTOM VIEW	23
8.3	UUT – OPEN CASE VIEW.....	24
8.4	UUT – MAIN BOARD VIEW	24
8.5	UUT – MAIN BOARD DETAILED VIEW	25
8.6	UUT – W2CBW0015 CHIP TOP VIEW	25
8.7	UUT – W2CBW0015 CHIP BOTTOM VIEW	26

8.8 UUT – POWER LINE26

9. ANNEX D (INFORMATIVE) – DECLARATION OF SIMILARITY27

10. ANNEX E (INFORMATIVE) - A2LA ELECTRICAL TESTING CERTIFICATE28

DOCUMENT REVISION HISTORY

Revision Number	Report Number	Description of Revision	Date of Revision
0	R1706276-11	Original Report	2017-09-27

1. General Information

1.1 Product Description for Unit Under Test (UUT)

This report was compiled on behalf of *Vesper Marine Ltd.*, and their product Marine Electronic Device, model number: *XB9010*, which henceforth are referred to as the UUT. The UUT is a Marine Electronic Device that can operate in the 2.4 GHz Wi-Fi.

Note: Vesper Marine declared the model was similar to the UUT. Please refer to Annex D in this report.

1.2 Mechanical Description of UUT

Dimensions: approximately 17 cm (L) x 12 cm (W) x 6 cm (H)

Weight: approximately 1.5 lb.

Serial Number: *JZ70400* assigned by Vesper Marine Ltd.

UUT Photos: See Annex C of this Test Report.

1.3 Objective

The following type approved report is prepared on behalf of *Vesper Marine Ltd.* in accordance with EN 300 328 V2.1.1 (2016-11), Electromagnetic compatibility and Radio spectrum Matters (ERM); Wideband Transmission systems; data transmission equipment operating in the 2.4 GHz ISM band and using spread spectrum modulation techniques.

The objective is to determine compliance with EN 300 328 V2.1.1 (2016-11), Electromagnetic compatibility and Radio spectrum Matters (ERM) for 5.2 as well as the WLAN portion.

In order to determine compliance, the manufacturer or a contracted laboratory makes measurements and takes the necessary steps to ensure that the equipment complies with the appropriate technical standards.

Maintenance of compliance is the responsibility of the manufacturer. Any modification of the product maybe which result in lowering the immunity should be checked to ensure compliance has been maintained (i.e., printed circuit board layout changes, different line filter, different power supply, harnessing and/or I/O cable changes, etc.).

1.4 Related Submittal(s)/Grant(s)

Contains a BT and IEEE 802.11b/g/n20/n40 combined module W2CBW0015.

1.5 Test Methodology

All measurements contained in this report were conducted with EN 300 328 V2.1.1, Electromagnetic compatibility and Radio spectrum Matters (ERM); Wideband Transmission systems; Data transmission equipment operating in the 2.4 GHz ISM band and using spread spectrum modulation techniques

All tests were performed at Bay Area Compliance Laboratories Corp.

1.6 Measurement Uncertainty

All measurements involve certain levels of uncertainties, especially in the field of EMC. The factors contributing to uncertainties are spectrum analyzer, cable loss, antenna factor calibration, antenna directivity, antenna factor variation with height, antenna phase center variation, antenna factor frequency interpolation, measurement distance variation, site imperfections, mismatch (average), and system repeatability.

Based on NIS 81, The Treatment of Uncertainty in EMC Measurements, the values ranging from ± 2.0 dB for Conducted Emissions tests and ± 4.0 dB for Radiated Emissions tests are the most accurate estimates pertaining to uncertainty of EMC measurements at BACL Corp.

1.7 Test Facility Registrations

BACLs test facilities that are used to perform Radiated and Conducted Emissions tests are currently recognized by the Federal Communications Commission as Accredited with NIST Designation Number US1129.

BACL's test facilities that are used to perform Radiated and Conducted Emissions tests are currently registered with Industry Canada under Registration Numbers: 3062A-1, 3062A-2, and 3062A-3.

BACL is a Chinese Taipei Bureau of Standards Metrology and Inspection (BSMI) validated Conformity Assessment Body (CAB), under Appendix B, Phase I Procedures of the APEC Mutual Recognition Arrangement (MRA). BACL's BSMI Lab Code Number is: SL2-IN-E-1002R

BACL's test facilities that are used to perform AC Line Conducted Emissions, Telecommunications Line Conducted Emissions, Radiated Emissions from 30 MHz to 1 GHz, and Radiated Emissions from 1 GHz to 6 GHz are currently recognized as Accredited in accordance with the Voluntary Control Council for Interference [VCCI] Article 15 procedures under Registration Number A-0027.

1.8 Test Facility Accreditations

Bay Area Compliance Laboratories Corp. (BACL) is:

A- An independent, 3rd-Party, Commercial Test Laboratory accredited to ISO/IEC 17025:2005 by A2LA (Test Laboratory Accreditation Certificate Number 3279.02), in the fields of: Electromagnetic Compatibility and Telecommunications. Unless noted by an Asterisk (*) in the Compliance Matrix (See Section 3 of this Test Report), BACL's ISO/IEC 17025:2005 Scope of Accreditation includes all of the Test Method Standards and/or the Product Family Standards detailed in this Test Report..

BACL's ISO/IEC 17025:2005 Scope of Accreditation includes a comprehensive suite of EMC Emissions, EMC Immunity, Radio, RF Exposure, Safety and wireline Telecommunications test methods applicable to a wide range of product categories. These product categories include Central Office Telecommunications Equipment [including NEBS - Network Equipment Building Systems], Unlicensed and Licensed Wireless and RF devices, Information Technology Equipment (ITE); Telecommunications Terminal Equipment (TTE); Medical Electrical Equipment; Industrial, Scientific and Medical Test Equipment; Professional Audio and Video Equipment; Industrial and Scientific Instruments and Laboratory Apparatus; Cable Distribution Systems, and Energy Efficient Lighting.

B- A Product Certification Body accredited to ISO/IEC 17065:2012 by A2LA (Product Certification Body Accreditation Certificate Number 3279.03) to certify

- For the USA (Federal Communications Commission):

- 1- All Unlicensed radio frequency devices within FCC Scopes A1, A2, A3, and A4;

- 2- All Licensed radio frequency devices within FCC Scopes B1, B2, B3, and B4;
- 3- All Telephone Terminal Equipment within FCC Scope C.
- For the Canada (Industry Canada):
 - 1 All Scope 1-Licence-Exempt Radio Frequency Devices;
 - 2 All Scope 2-Licensed Personal Mobile Radio Services;
 - 3 All Scope 3-Licensed General Mobile & Fixed Radio Services;
 - 4 All Scope 4-Licensed Maritime & Aviation Radio Services;
 - 5 All Scope 5-Licensed Fixed Microwave Radio Services
 - 6 All Broadcasting Technical Standards (BETS) in the Category I Equipment Standards List.
- For Singapore (Info-Communications Development Authority (IDA)):
 - 1 All Line Terminal Equipment: All Technical Specifications for Line Terminal Equipment – Table 1 of IDA MRA Recognition Scheme: 2011, Annex 2
 - 2. All Radio-Communication Equipment: All Technical Specifications for Radio-Communication Equipment – Table 2 of IDA MRA Recognition Scheme: 2011, Annex 2
- For the Hong Kong Special Administrative Region:
 - 1 All Radio Equipment, per KHCA 10XX-series Specifications;
 - 2 All GMDSS Marine Radio Equipment, per HKCA 12XX-series Specifications;
 - 3 All Fixed Network Equipment, per HKCA 20XX-series Specifications.
- For Japan:
 - 1 MIC Telecommunication Business Law (Terminal Equipment):
 - All Scope A1 - Terminal Equipment for the Purpose of Calls;
 - All Scope A2 - Other Terminal Equipment
 - 2 Radio Law (Radio Equipment):
 - All Scope B1 - Specified Radio Equipment specified in Article 38-2-2, paragraph 1, item 1 of the Radio Law
 - All Scope B2 - Specified Radio Equipment specified in Article 38-2-2, paragraph 1, item 2 of the Radio Law
 - All Scope B3 - Specified Radio Equipment specified in Article 38-2-2, paragraph 1, item 3 of the Radio Law

C- A Product Certification Body accredited to ISO/IEC 17065:2012 by A2LA (Product Certification Body Accreditation Certificate Number 3279.01) to certify Products to USA's Environmental Protection Agency (EPA) ENERGY STAR Product Specifications for:

- 1 Electronics and Office Equipment:
 - for Telephony (ver. 3.0)
 - for Audio/Video (ver. 3.0)
 - for Battery Charging Systems (ver. 1.1)
 - for Set-top Boxes & Cable Boxes (ver. 4.1)
 - for Televisions (ver. 6.1)
 - for Computers (ver. 6.0)
 - for Displays (ver. 6.0)
 - for Imaging Equipment (ver. 2.0)
 - for Computer Servers (ver. 2.0)
- 2 Commercial Food Service Equipment
 - for Commercial Dishwashers (ver. 2.0)
 - for Commercial Ice Machines (ver. 2.0)
 - for Commercial Ovens (ver. 2.1)
 - for Commercial Refrigerators and Freezers
- 3 Lighting Products
 - For Decorative Light Strings (ver. 1.5)

- For Luminaires (including sub-components) and Lamps (ver. 1.2)
- For Compact Fluorescent Lamps (CFLs) (ver. 4.3)
- For Integral LED Lamps (ver. 1.4)
- 4 Heating, Ventilation, and AC Products
 - for Residential Ceiling Fans (ver. 3.0)
 - for Residential Ventilating Fans (ver. 3.2)
- 5 Other
 - For Water Coolers (ver. 3.0)

D- A NIST Designated Phase-I and Phase-II Conformity Assessment Body (CAB) for the following economies and regulatory authorities under the terms of the stated MRAs/Treaties:

- Australia: ACMA (Australian Communication and Media Authority) – APEC Tel MRA -Phase I;
- Canada: (Innovation, Science and Economic development Canada - ISEDC) Foreign Certification Body – FCB – APEC Tel MRA -Phase I & Phase II;
- Chinese Taipei (Republic of China – Taiwan):
 - o BSMI (Bureau of Standards, Metrology and Inspection) APEC Tel MRA -Phase I;
 - o NCC (National Communications Commission) APEC Tel MRA -Phase I;
- European Union:
 - o EMC Directive 2014/30/EU US-EU EMC & Telecom MRA CAB (NB)
 - o Radio & Teleterminal Equipment (R&TTE) Directive 1995/5/EC US -EU EMC & Telecom MRA CAB (NB)
 - o Radio Equipment (RE) Directive 2014/53/EU US-EU EMC & Telecom MRA CAB (NB)
 - o Low Voltage Directive (LVD) 2014/35/EU
- Hong Kong Special Administrative Region: (Office of the Telecommunications Authority – OFTA) APEC Tel MRA -Phase I & Phase II
- Israel – US-Israel MRA Phase I
- Republic of Korea (Ministry of Communications - Radio Research Laboratory) APEC Tel MRA -Phase I
- Singapore: (Infocomm Media Development Authority - IMDA) APEC Tel MRA -Phase I & Phase II;
- Japan: VCCI - Voluntary Control Council for Interference US-Japan Telecom Treaty VCCI Side Letter-
- USA:
 - o ENERGY STAR Recognized Test Laboratory – US EPA
 - o Telecommunications Certification Body (TCB) – US FCC;
 - o Nationally Recognized Test Laboratory (NRTL) – US OSHA
- Vietnam: APEC Tel MRA -Phase I;

2. UUT TEST CONFIGURATION

2.1 Justification

The UUT was configured for testing according to EN 300 328 V2.1.1.

2.2 UUT Exercise Software

The test utility used was provided by *Vesper Marine Ltd.*

2.3 Equipment Modifications

N/A

2.4 Special Equipment

None

2.5 Local Support Equipment

Manufacturer	Description	Model	S/N
Dell	Laptop	Latitude D630	FFXR4Q1

2.6 Interface Ports and Cabling

Cable Description	Length (m)	To	From
SMA Cable	< 1	UUT	CMW500

2.7 Power Supply and Line Filters

Manufacturer	Description	Model No.	S/N
Vesper Marine	DC Line	030-041001-02	Unknown

3. Summary of Test Results

EN 300 328 V2.1.1	Description Of Tests	Results
Clause 4.3.2.2	RF Output Power	Note 1
Clause 4.3.2.3	Maximum e.i.r.p Spectral Density	Note 1
Clause 4.3.2.4	Duty Cycle, TX-Sequence, TX-Gap	Note 1
Clause 4.3.2.5	Medium Utilization Factor	Note 1
Clause 4.3.2.6	Adaptivity	Note 1
Clause 4.3.2.7	Occupied Channel Bandwidth	Note 1
Clause 4.3.2.8	TX Unwanted Emissions in the out of Band Domain	Note 1
Clause 4.3.2.9	TX Unwanted Emissions in the Spurious Domain	Compliant
Clause 4.3.2.10	Receiver Spurious Emissions	Note 1
Clause 4.3.2.11	Receiver Blocking	Compliant
Clause 4.3.2.12	Geo-location capability	Note 2

Note 1: Please refer to BACL Report Number: R1412084-11; Issue Date: 02/11/2015

Note 2: Customer declares the device does not have geo-location capability.

4. EN 300 328 Clause 4.3.2.9 – TX Unwanted emissions in the Spurious Domain

4.1 Applicable Standard

The transmitter unwanted emissions in the spurious domain shall not exceed the values given in table 1.

NOTE: In case of equipment with antenna connectors, these limits apply to emissions at the antenna port (conducted) and to the emissions radiated by the cabinet. In case of integral antenna equipment (without temporary antenna connectors), these limits apply to emissions radiated by the equipment.

Table 1: Transmitter limits for spurious emissions

Frequency range	Maximum power	Bandwidth
30 MHz to 47 MHz	-36 dBm	100 kHz
47 MHz to 74 MHz	-54 dBm	100 kHz
74 MHz to 87,5 MHz	-36 dBm	100 kHz
87,5 MHz to 118 MHz	-54 dBm	100 kHz
118 MHz to 174 MHz	-36 dBm	100 kHz
174 MHz to 230 MHz	-54 dBm	100 kHz
230 MHz to 470 MHz	-36 dBm	100 kHz
470 MHz to 862 MHz	-54 dBm	100 kHz
862 MHz to 1 GHz	-36 dBm	100 kHz
1 GHz to 12,75 GHz	-30 dBm	1 MHz

4.2 Measurement Uncertainty

All measurements involve certain levels of uncertainties, especially in field of EMC. The factors contributing to uncertainties are spectrum analyzer, cable loss, antenna factor calibration, antenna directivity, antenna factor variation with height, antenna phase center variation, antenna factor frequency interpolation, measurement distance variation, site imperfections, mismatch (average), and system repeatability.

Based on NIS 81, The Treatment of Uncertainty in EMC Measurements, the best estimate of the uncertainty of a radiation emissions measurement at BAEL is ± 4.0 dB.

4.3 UUT Setup

The radiated emissions tests were performed in a shield room, using the setup accordance with the EN 300 328 V2.1.1. The specification used was the EN 300 328 V2.1.1 limits.

External I/O cables were draped along the edge of the test table and bundle when necessary.

4.4 Environmental Conditions

Temperature:	23~25° C
Relative Humidity:	43~45 %
ATM Pressure:	101.1~102.4 kPa

Testing was performed by Candy Li on 2017-08-17 and 2017-09-08 at the RF site and 5m3 Chamber

4.5 Test Equipment List and Details

Manufacturer	Description	Model	Serial Number	Calibration Date	Calibration Interval
Agilent	Analyzer, Spectrum	E4440A	US45303156	2017-02-24	1 year
Sunol Science Corp	System Controller	SC99V	122303-1	N/R	N/R
Sunol Sciences	Antenna, Biconi-Log	JB3	A020106-2	2015-07-11	27 months
Agilent	Pre-Amplifier	8449B	3008A01978	2016-10-06	1 year
Agilent	Amplifier, Pre	8447D	2944A10187	2017-03-13	1 year
Sunol Sciences	Antenna, Horn	DRH-118	A052704	2016-03-27	2 years
A.R.A.	Antenna, Horn	DRG-118/A	1132	2015-09-21	2 years
HP	Generator, Signal	83650B	3614A00276	2016-09-09	1 year
COM-POWER	Antenna, Dipole	AD-100	721033DB1, 2, 3, 4	2016-02-13	2 years
-	RF Cable	-	-	Each time ¹	N/A

Note¹: cable and attenuator included in the test set-up will be checked each time before testing.

Statement of Traceability: BACL attests that all calibrations have been performed per the A2LA requirements, traceable to NIST.

4.6 Measurement Procedure

Any emissions that exceed the limit or come within 6 dB below the limits were evaluated. All of the emissions were evaluated using an average detector.

4.7 Summary of Test Results

According to the data in following tables, the UUT complied with the EN 300 328 V2.1.1 standards and had the worst margin of:

-0.74dB at 99 MHz in the Vertical polarization, 802.11b mode, High Channel

For detailed results please refer to the following tables and plots

Radiated Spurious Emission (30 MHz – 12.75 GHz):

After Pre-Scan, worst case 802.11b mode results shown below:

Freq. (MHz)	S.A. Amp. (dB μ V)	Table Azimuth (Degrees)	Test Antenna		Substitution				Absolute Level (dBm)	EN 300 328	
			Height (cm)	Polar (H/V)	Freq. (MHz)	S.G. Level (dBm)	Antenna Gain (dBi)	Cable Loss (dBi)		Limit (dBm)	Margin (dB)
Low channel											
99	65.1	304	200	H	99	-54.74	0	0.1	-54.84	-54	-0.84
99	60.8	250	100	V	99	-54.84	0	0.1	-54.94	-54	-0.94
422	57.49	222	200	H	422	-55.67	0	0.2	-55.87	-36	-19.87
520	48.66	300	195	V	520	-64	0	0.2	-64.2	-36	-28.2
1352	57.91	248	133	H	1352	-54.25	7.638	0.53	-47.142	-30	-17.142
1352	58.02	339	216	V	1352	-54.14	7.557	0.53	-47.113	-30	-17.113
2973	62.67	291	252	H	2973	-42.66	9.224	0.67	-34.106	-30	-4.106
2973	61.56	256	220	V	2973	-43.77	9.189	0.67	-35.251	-30	-5.251
High Channel											
99	64.9	0	100	H	99	-54.94	0	0.1	-55.04	-54	-1.04
99	61	150	100	V	99	-54.64	0	0.1	-54.74	-54	-0.74
595	53.25	0	113	H	595	-59.7	0	0.2	-59.9	-54	-5.9
571	55.75	302	195	V	571	-55.41	0	0.2	-55.61	-54	-1.61
1352	57.86	277	199	H	1352	-54.3	7.638	0.53	-47.192	-30	-17.192
1352	57.76	138	147	V	1352	-54.4	7.557	0.53	-47.373	-30	-17.373
3025	63.15	42	225	H	3025	-42.18	9.224	0.67	-33.626	-30	-3.626
3025	62.59	157	126	V	3025	-42.74	9.189	0.67	-34.221	-30	-4.221

5. EN 300 328 Clause 4.3.2.11 – Receiver Blocking

5.1 Applicable Standard

ETSI EN 300 328 v2.1.1 Clause 4.3.2.11.

Receiver blocking is a measure of the ability of the equipment to receive a wanted signal on its operating channel without exceeding a given degradation in the presence of an unwanted signal (blocking signal) at frequencies other than those of the operating band.

According to 4.3.2.11.3: The minimum performance criterion shall be a PER less than or equal to 10 %. The manufacturer may declare alternative performance criteria as long as that is appropriate for the intended use of the equipment (see clause 5.4.1.t)).

While maintaining the minimum performance criteria as defined in clause 4.3.2.11.3, the blocking levels at specified frequency offsets shall be equal to or greater than the limits defined for the applicable receiver category provided in table 14, table 15 or table 16.

Table 14: Receiver Blocking parameters for Receiver Category 1 equipment

Wanted signal mean power from companion device (dBm)	Blocking signal frequency (MHz)	Blocking signal power (dBm) (see note 2)	Type of blocking signal
$P_{\min} + 6$ dB	2 380 2 503,5	-53	CW
$P_{\min} + 6$ dB	2 300 2 330 2 360	-47	CW
$P_{\min} + 6$ dB	2 523,5 2 553,5 2 583,5 2 613,5 2 643,5 2 673,5	-47	CW
NOTE 1: P_{\min} is the minimum level of the wanted signal (in dBm) required to meet the minimum performance criteria as defined in clause 4.3.2.11.3 in the absence of any blocking signal.			
NOTE 2: The levels specified are levels in front of the UUT antenna. In case of conducted measurements, the levels have to be corrected by the actual antenna assembly gain.			

Table 15: Receiver Blocking parameters receiver category 2 equipment

Wanted signal mean power from companion device (dBm)	Blocking signal frequency (MHz)	Blocking signal power (dBm) (see note 2)	Type of blocking signal
$P_{\min} + 6$ dB	2 380 2 503,5	-57	CW
$P_{\min} + 6$ dB	2 300 2 583,5	-47	CW

NOTE 1: P_{\min} is the minimum level of the wanted signal (in dBm) required to meet the minimum performance criteria as defined in clause 4.3.2.11.3 in the absence of any blocking signal.

NOTE 2: The levels specified are levels in front of the UUT antenna. In case of conducted measurements, the levels have to be corrected by the actual antenna assembly gain.

Table 16: Receiver Blocking parameters receiver category 3 equipment

Wanted signal mean power from companion device (dBm)	Blocking signal frequency (MHz)	Blocking signal power (dBm) (see note 2)	Type of blocking signal
$P_{\min} + 12$ dB	2 380 2 503,5	-57	CW
$P_{\min} + 12$ dB	2 300 2 583,5	-47	CW

NOTE 1: P_{\min} is the minimum level of the wanted signal (in dBm) required to meet the minimum performance criteria as defined in clause 4.3.2.11.3 in the absence of any blocking signal.

NOTE 2: The levels specified are levels in front of the UUT antenna. In case of conducted measurements, the levels have to be corrected by the actual antenna assembly gain.

5.2 Measurement Procedure

ETSI EN 300 328 V2.1.1 Clause 5.4.11

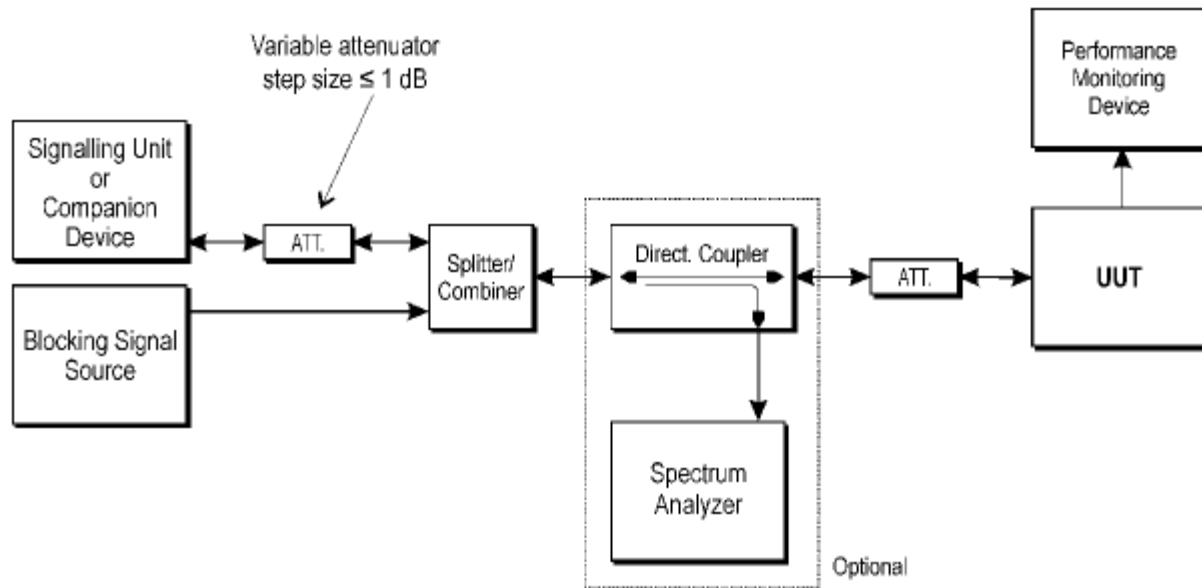

Figure 6: Test Set-up for receiver blocking

The procedure in step 1 to step 6 below was used to verify the receiver blocking requirement as described in clause 4.3.1.12 or clause 4.3.2.11. Table 14, table 15 and table 16 in clause 4.3.2.11.4 contain the applicable blocking frequencies and blocking levels for each of the receiver categories for testing Receiver Blocking on equipment using wide band modulations other than FHSS.

Step 1:

- For non-frequency hopping equipment, the UUT was set to the lowest operating channel.

Step 2:

- The blocking signal generator was set to the first frequency as defined in the appropriate table corresponding to the receiver category and type of equipment.

Step 3:

- With the blocking signal generator switched off, a communication link was established between the UUT and the associated companion device using the test setup shown in figure 6. The attenuation of the variable attenuator was increased in 1 dB steps to a value at which the minimum performance criteria as specified in clause 4.3.1.12.3 or clause 4.3.2.11.3 was still met. The resulting level for the wanted signal at the input of the UUT was P_{min} .
- This signal level (P_{min}) was increased by the value provided in the table corresponding to the receiver category and type of equipment.

Step 4:

• The blocking signal at the UUT was set to the level provided in the table corresponding to the receiver category and type of equipment. It was verified and recorded in the test report that the performance criteria as specified in clause 4.3.1.12.3 or clause 4.3.2.11.3 was met.

Step 5:

• Repeated step 4 for each remaining combination of frequency and level for the blocking signal as provided in the table corresponding to the receiver category and type of equipment.

Step 6:

• For non-frequency hopping equipment, repeated step 2 to step 5 with the UUT operating at the highest operating channel.

5.3 Test Equipment List and Details

Manufacturer	Description	Model	Serial Number	Calibration Date	Calibration Cycle
Keysight Technologies	Vector Signal Generator	N5182B	MY51350070	2017-01-06	1 year
Hewlett-Packard	0-11 dB Variable Attenuator	HP 8494B	859	Calibrated before use	N/A
Hewlett-Packard	0-70 dB Variable Attenuator	HP 8495B	859	Calibrated before use	N/A
Rohde & Schwarz	Wideband Radio Communication Tester	CMW500	120503	2016-09-30	1 year
Mini-Circuits	Power Splitter	ZFSC-2-10G	N/A	Calibrated before use	N/A

Statement of Traceability: BACL attests that all calibrations have been performed per the A2LA requirements, traceable to NIST.

5.4 Environmental Conditions

Temperature:	24° C
Relative Humidity:	45 %
ATM Pressure:	102.5 kPa

The testing was performed by Xiao Lin on 2017-07-06 at RF site.

5.5 Test Results

Note: this device is a Non-adaptive unit and maximum output power is greater than 10 dBm e.i.r.p. Thus, the device is under Receiver Category 1. Please refer to below table for test result.

Operating Frequency (MHz)	Blocking Signal Frequency (MHz)	PER (Packet Error Rate)	Limit
2412	2380	4.6%	≤10%
	2503.5	6.4%	≤10%
	2300	5.8%	≤10%
	2330	5.6%	≤10%
	2360	5.6%	≤10%
	2523.5	5.4%	≤10%
	2553.5	5.0%	≤10%
	2583.5	7.2%	≤10%
	2613.5	3.8%	≤10%
	2643.5	4.2%	≤10%
	2673.5	4.6%	≤10%
2472	2380	2.8%	≤10%
	2503.5	2.8%	≤10%
	2300	2.4%	≤10%
	2330	3.6%	≤10%
	2360	2.4%	≤10%
	2523.5	2.6%	≤10%
	2553.5	3.0%	≤10%
	2583.5	3.2%	≤10%
	2613.5	3.0%	≤10%
	2643.5	2.8%	≤10%
	2673.5	4.4%	≤10%

Note: The Blocking signal power was corrected by the actual antenna assembly gain.

6. Annex A (Normative) – Proposed Product Labeling

6.1 Label Information

1. The CE conformity marking must consist of the initials ‘CE’ taking the form below. If the CE marking is reduced or enlarged the proportions must be respected.

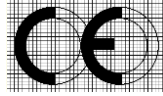

2. The CE marking must have a height of at least 5 mm except where this is not possible on account of the nature of the apparatus.

The EMC Directive recognizes that there are circumstances where it is “not possible or warranted on account of the nature of the product” to have the marking affixed to the apparatus or to its data plate. In such cases it is allowed to have the CE marking’ affixed on the packaging, refer to the Blue Guide when such exemptions are allowed.

3. The CE marking must be affixed to the product or to its data plate. Additionally it must be affixed to the packaging, if any, and to the accompanying documents, where the directive concerned provides for such documents.
4. The CE marking must be affixed visibly, legibly, and indelibly.
5. Other labeling requirements maybe required if the product(s) is/are subject to several directives.

Specifications: Text is black or white in color and is left justified. Labels are printed in indelible ink on permanent adhesive backing or silk-screened and shall be affixed at a conspicuous location on the UUT. The label cannot be positioned on a removable portion of the UUT (e.g. battery cover).

6.2 UUT Label Location



7. Annex B (Normative) - Test Setup Photographs

7.1 Radiated Emission below 1 GHz Front View



7.2 Radiated Emission below 1 GHz Rear View



7.3 Radiated Emission above 1 GHz Front View



7.4 Radiated Emission above 1 GHz Rear View



8. Annex C (Normative) – UUT Photographs

8.1 UUT – Top View

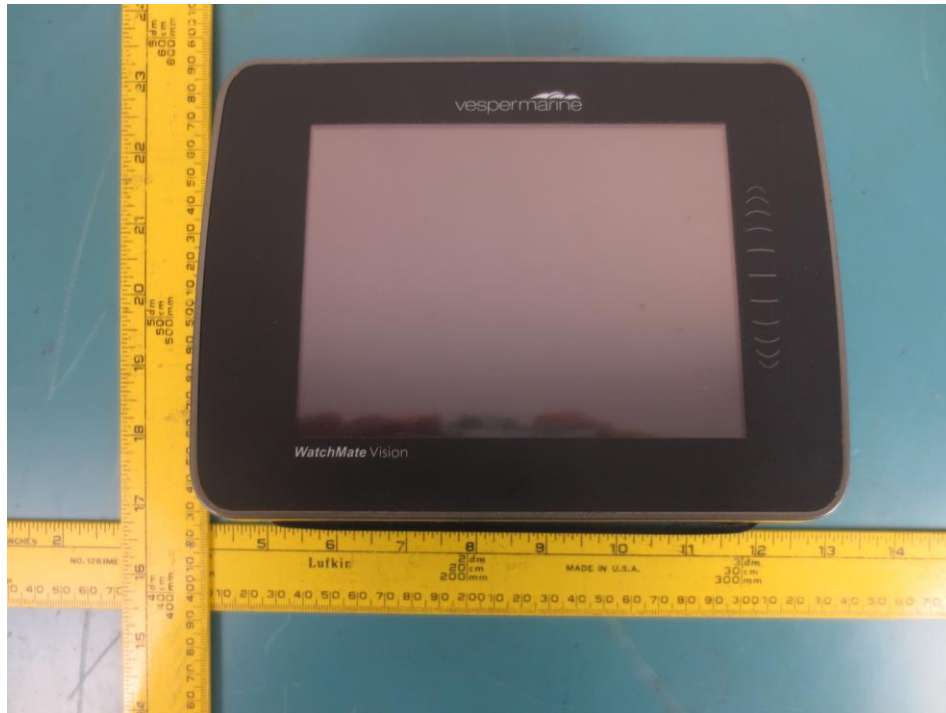

8.2 UUT – Bottom View



8.3 UUT – Open Case View



8.4 UUT – Main Board View

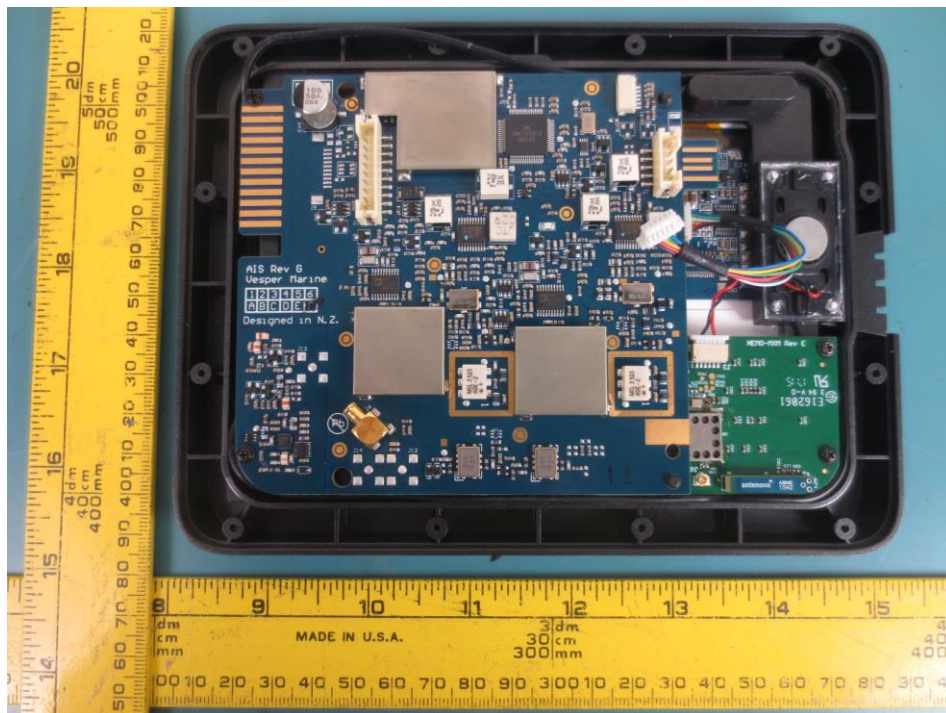

8.5 UUT – Main Board Detailed View

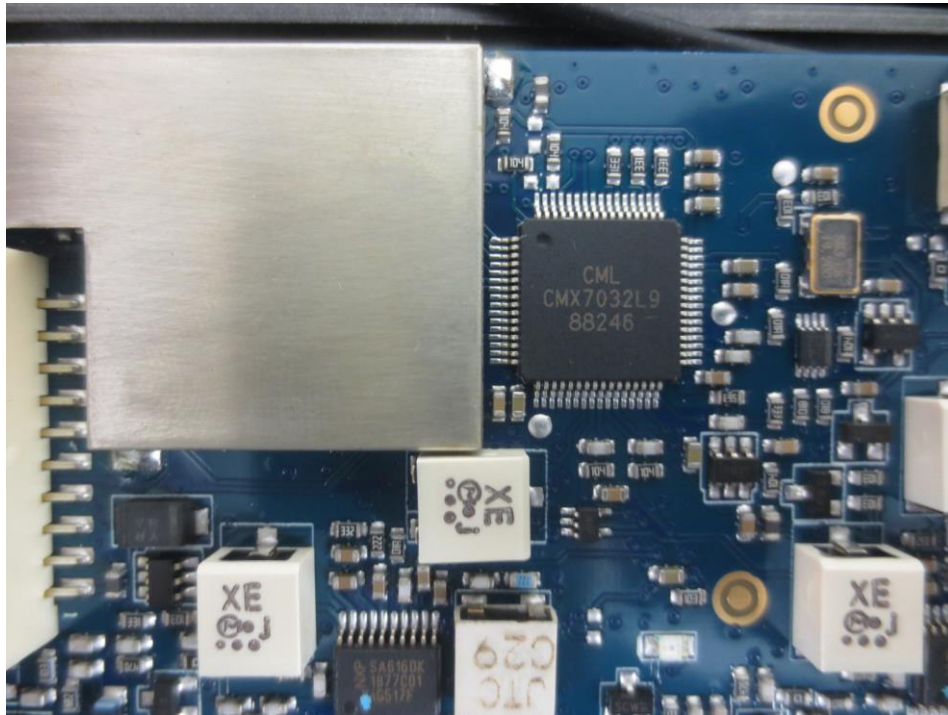

8.6 UUT – W2CBW0015 chip Top View

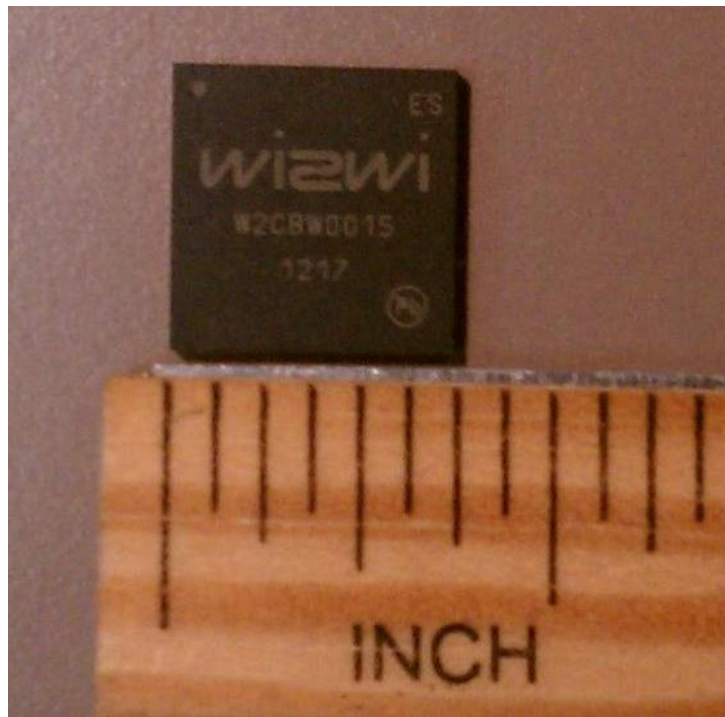

8.7 UUT – W2CBW0015 chip Bottom View

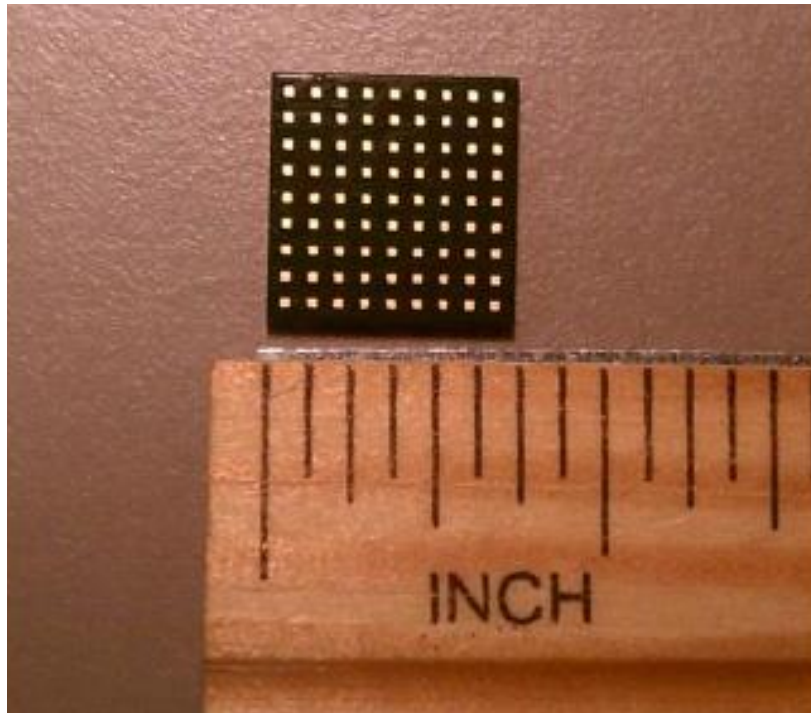

8.8 UUT – Power Line



9. Annex D (Informative) – Declaration of Similarity

DECLARATION OF SIMILARITY

September 27, 2017

To:

Bay Area Compliance Laboratories Corp.

1274 Anvilwood Ave.

Sunnyvale, CA 94089

Phone: 408-732-9162, Fax: 408-732-9164

<http://www.baclcorp.com>

Dear Sir or Madam:

We Vesper Marine hereby declare that product: XB-8010 (model: XB8010) is electrically identical with the same electromagnetic emissions and electromagnetic compatibility characteristics as the WatchMate Vision (model: XB9010) tested by BAACL, the results of which are featured in BAACL project: R1706276.

The only difference is that *XB-8010 has no LCD display*

Please contact me should there be need for any additional clarification or information.

Best Regards,

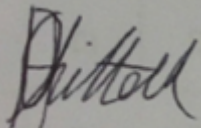

Henry Chittock

Hardware Engineer

Vesper Marine Ltd

45 Sales St. Freemans Bay,

Auckland, New Zealand

10. Annex E (Informative) - A2LA Electrical Testing Certificate



Accredited Laboratory

A2LA has accredited

BAY AREA COMPLIANCE LABORATORIES CORP.

Sunnyvale, CA

for technical competence in the field of

Electrical Testing

This laboratory is accredited in accordance with the recognized International Standard ISO/IEC 17025:2005 General requirements for the competence of testing and calibration laboratories. This laboratory also meets the requirements of A2LA R222 - Specific Requirements - EPA ENERGY STAR Accreditation Program. This accreditation demonstrates technical competence for a defined scope and the operation of a laboratory quality management system (refer to joint ISO-ILAC-IAF Communiqué dated 8 January 2009).



Presented this 30th day of August 2016.

A handwritten signature in blue ink, appearing to read 'J. C. Burt'.

Senior Director of Quality & Communications
For the Accreditation Council
Certificate Number 3297.02
Valid to September 30, 2018

For the tests to which this accreditation applies, please refer to the laboratory's Electrical Scope of Accreditation.

---END OF REPORT---