

# EMC Test Report

**Project Number:** 4195027

**Report Number:** 4195027EMC02

**Revision Level:** 1

**Client:** Stanley Black and Decker

**Equipment Under Test:** Outdoor Access Point

**Model:** DCT100

**FCC ID:** YJ7DCT100

**Applicable Standards:** FCC Part 15 Subpart C, §15.407

**ANSI C63.10: 2013**

**Report issued on:** 05 April 2018

**Test Result:** Compliant

Tested by:



\_\_\_\_\_  
Fabian Nica, Senior Engineering Technician

Reviewed by:



\_\_\_\_\_  
David Schramm, EMC/RF/SAR/HAC Manager

*Remarks: This report details the results of the testing carried out on one sample, the results contained in this test report do not relate to other samples of the same product. The manufacturer should ensure that all products in series production are in conformity with the product sample detailed in this report.*

*This document is issued by the Company under its General Conditions of Service accessible at <http://www.sgs.com/en/Terms-and-Conditions.aspx>. Attention is drawn to the limitation of liability, indemnification and jurisdiction issues defined therein.*

*Any holder of this document is advised that information contained hereon reflects the Company's findings at the time of its intervention only and within the limits of Client's instructions, if any. The Company's sole responsibility is to its Client and this document does not exonerate parties to a transaction from exercising all their rights and obligations under the transaction documents. Any unauthorized alteration, forgery or falsification of the content or appearance of this document is unlawful and offenders may be prosecuted to the fullest extent of the law.*

## Table of Contents

<b>1</b>	<b>SUMMARY OF TEST RESULTS</b> .....	<b>4</b>
1.1	MODIFICATIONS REQUIRED FOR COMPLIANCE .....	4
<b>2</b>	<b>GENERAL INFORMATION</b> .....	<b>5</b>
2.1	CLIENT INFORMATION .....	5
2.2	TEST LABORATORY .....	5
2.3	GENERAL INFORMATION OF EUT .....	5
2.4	OPERATING MODES AND CONDITIONS .....	5
2.5	EUT CONNECTION BLOCK DIAGRAM – CONDUCTED MEASUREMENTS.....	6
2.6	EUT CONNECTION BLOCK DIAGRAM – RADIATED MEASUREMENTS .....	7
2.7	SYSTEM CONFIGURATIONS .....	7
<b>3</b>	<b>EMISSION BANDWIDTH AND OCCUPIED BANDWIDTH</b> .....	<b>8</b>
3.1	TEST RESULT.....	8
3.2	TEST METHOD.....	8
3.3	TEST SITE .....	8
3.4	TEST EQUIPMENT .....	8
3.5	TEST DATA.....	8
<b>4</b>	<b>OUTPUT POWER</b> .....	<b>12</b>
4.1	TEST RESULT.....	12
4.2	TEST METHOD.....	12
4.3	TEST SITE .....	12
4.4	TEST EQUIPMENT .....	12
4.5	TEST DATA – UNII BAND 1 .....	13
4.6	TEST DATA – UNII BAND 3 .....	14
<b>5</b>	<b>POWER SPECTRAL DENSITY</b> .....	<b>15</b>
5.1	TEST RESULT.....	15
5.2	TEST METHOD.....	15
5.3	TEST SITE .....	15
5.4	TEST EQUIPMENT .....	15
5.5	TEST DATA (UNII BAND 1).....	15
5.6	TEST DATA (UNII BAND 3).....	17
<b>6</b>	<b>UNWANTED EMISSIONS</b> .....	<b>19</b>
6.1	TEST RESULT.....	19
6.2	TEST METHOD.....	19
6.3	TEST SITE .....	19
6.4	TEST EQUIPMENT – CONDUCTED MEASUREMENTS .....	19
6.5	TEST EQUIPMENT – RADIATED MEASUREMENTS.....	20
6.6	TEST DATA - UNII BAND 1 – RADIATED BAND EDGE .....	21
6.7	TEST DATA - UNII BAND 3 – RADIATED BAND EDGE .....	23
6.8	TEST DATA – CONDUCTED SPURS .....	25
6.9	UNWANTED EMISSIONS – CABINET RADIATION .....	29
6.10	TABULAR DATA – UNII BAND 1 .....	49
6.11	TABULAR DATA – UNII BAND 3 .....	49
<b>7</b>	<b>FREQUENCY STABILITY</b> .....	<b>50</b>
7.1	TEST RESULT.....	50
7.2	TEST METHOD.....	50
7.3	TEST SITE .....	50
7.4	TEST EQUIPMENT .....	50
7.5	TEST DATA.....	50



**8 CONDUCTED EMISSIONS ..... 51**

8.1 TEST RESULT..... 51

8.2 TEST METHOD..... 51

8.3 TEST SITE ..... 51

8.4 TEST EQUIPMENT ..... 51

8.5 TEST DATA..... 52

**9 REVISION HISTORY ..... 54**

## 1 Summary of Test Results

Test Description	Test Specification	Test Result
Emission Bandwidth	15.407(a), 15.407(e)	Compliant
Spectral Density	15.407(a)	Compliant
Peak Power Output	15.407(a)	Compliant
Unwanted Emissions	15.407(b)	Compliant
Frequency Stability	15.407(g)	Compliant
AC Powerline Conducted Emission	15.107, 15.207	Compliant

### 1.1 *Modifications Required for Compliance*

None

## 2 General Information

### 2.1 Client Information

Name: Stanley Black and Decker  
Address: 701 E. Joppa Road  
City, State, Zip, Country: Towson, MD 21286, USA

### 2.2 Test Laboratory

Name: SGS North America, Inc.  
Address: 620 Old Peachtree Road NW, Suite 100  
City, State, Zip, Country: Suwanee, GA 30024, USA

Accrediting Body: A2LA  
Type of lab: Testing Laboratory  
Certificate Number: 3212.01

### 2.3 General Information of EUT

Type of Product: Outdoor Access Point  
Model Number: DCT100  
DCT100-46361 (Conducted Measurements)  
Serial Number: DCT100-46384 (Radiated Measurements)  
051216 (UNII Band 1 Power Measurements)

Frequency Range: 5150 to 5250 MHz and 5725 to 5825MHz  
Data Modes: 802.11a, 802.11n (HT20), 802.11n (HT40)  
Antenna: Internal, 2x2 MIMO

Rated Voltage: 100-240Vac, 50/60Hz  
Test Voltage: 120Vac, 60Hz

Sample Received Date: 11 July 2017 / 19 February 2018  
Dates of testing: 28 August to 31 October 2017 / 19 March 2018

### 2.4 Operating Modes and Conditions

Using test commands, the EUT would transmit continuously on any of the UNII Band 1 or 3 channels at full power. Worst-case power and PSD were achieved at the lowest data rates. For radiated spurious emissions measurements, only the worst-case mode with respect to peak power was investigated (802.11a).

## 2.5 EUT Connection Block Diagram – Conducted Measurements

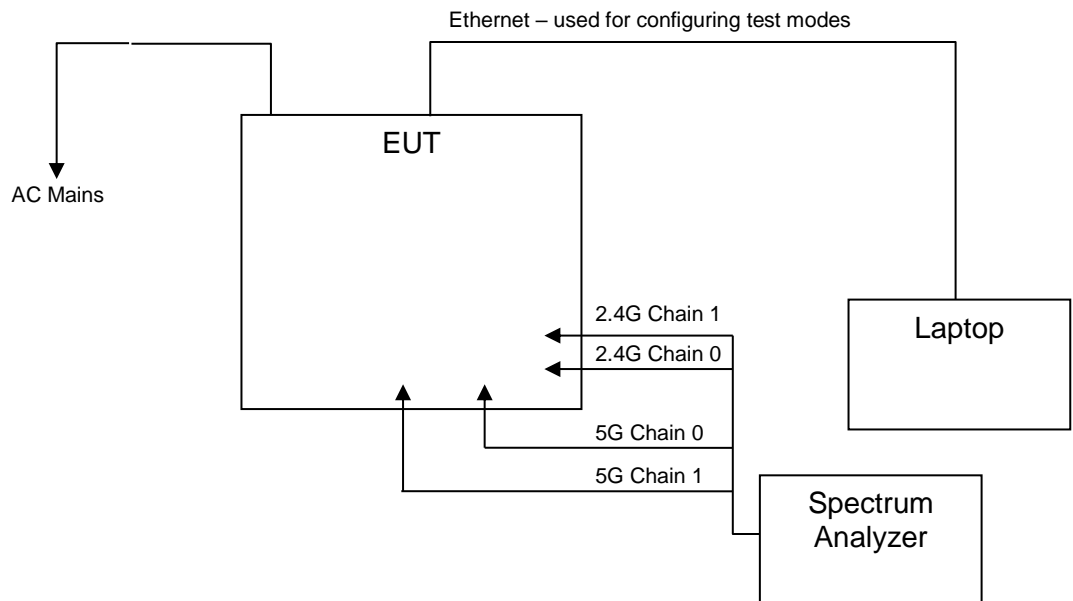

## 2.6 EUT Connection Block Diagram – Radiated Measurements

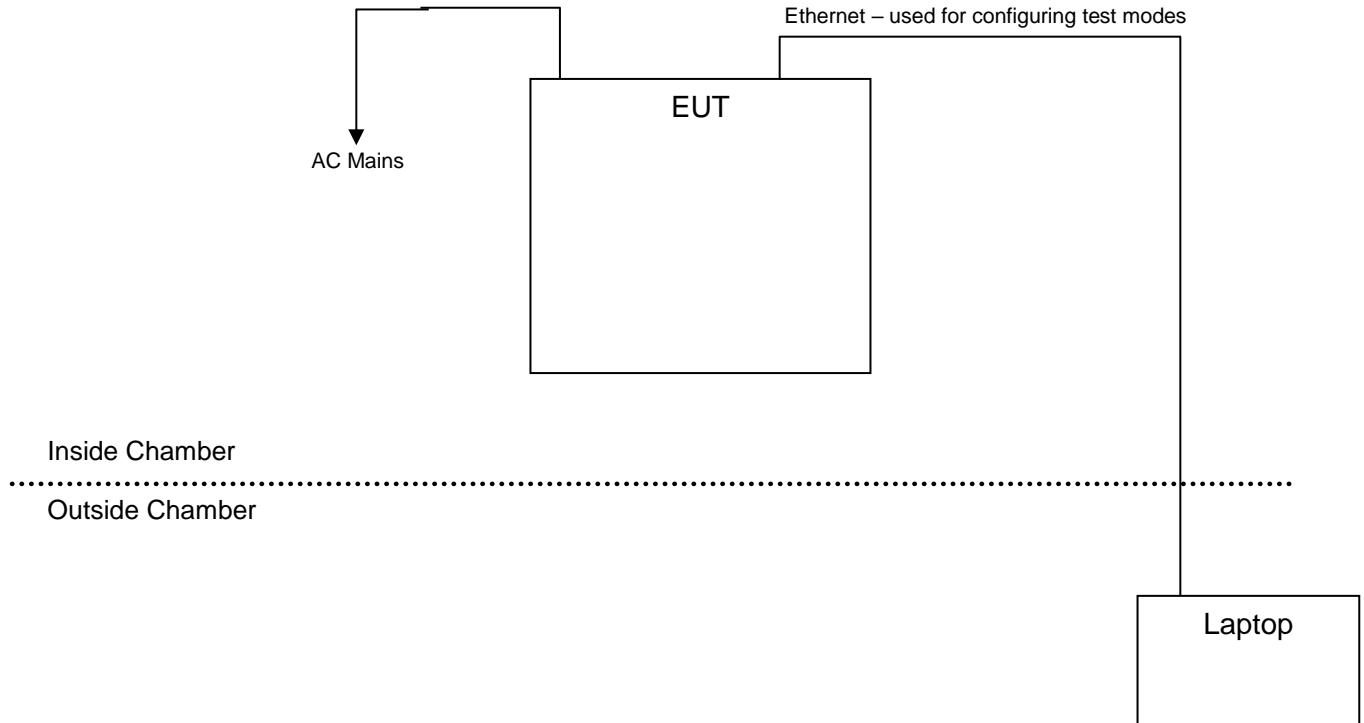

## 2.7 System Configurations

Device reference	Manufacturer	Description	Model Number	Serial Number
A	Stanley Black and Decker	Outdoor Access Point	DCT100	DCT100-46361 (Conducted Measurements) DCT100-46384 (Radiated Measurements)

### 3 Emission Bandwidth and Occupied Bandwidth

#### 3.1 Test Result

Test Description	Test Specification	Test Result
Emission bandwidth / 99% OBW	15.407(a), 15.407(e)	Compliant

#### 3.2 Test Method

The procedures from ANSI C63.10: 2013 clause 12.4 and KDB document 789033 D02 General UNII Test Procedures New Rules v01r04 were used to determine the 6dB bandwidth, the 26dB bandwidth, and 99% OBW.

#### 3.3 Test Site

SGS EMC Laboratory, Suwanee, GA

Environmental Conditions

Temperature: 23.3 °C  
Relative Humidity: 52.7 %

#### 3.4 Test Equipment

Test End Date: 17-Oct-2017

Tester: JOP

Equipment	Model	Manufacturer	Asset Number	Cal Due Date
EMI TEST RECEIVER	ESU8	ROHDE & SCHWARZ	B085759	25-Jul-2018
RF CABLE	SF102	HUBER & SUHNER	B079823	26-Jul-2018
SPECTRUM ANALYZER	FSV30	ROHDE & SCHWARZ	101106	20-Sep-2018

Note: The equipment calibration period is 1 year.

#### 3.5 Test Data

Protocol	Channel	26dB Bandwidth (MHz)	6dB Bandwidth (MHz)	OBW (99%) (MHz)
802.11a	36	23.120	16.366	16.550
802.11a	44	23.388	16.317	16.467
802.11a	48	22.339	16.317	16.467
802.11a	149	23.713	16.342	16.542
802.11a	157	24.988	16.367	16.592
802.11a	165	22.764	16.367	16.517
802.11n (HT40)	38	42.229	36.532	36.232
802.11n (HT40)	46	41.429	36.082	36.132
802.11n (HT40)	151	42.329	36.632	36.132
802.11n (HT40)	159	42.079	36.232	36.182

Note: There was no discernible difference in bandwidth between 802.11a and 802.11n (HT20).



## Sample Plots:

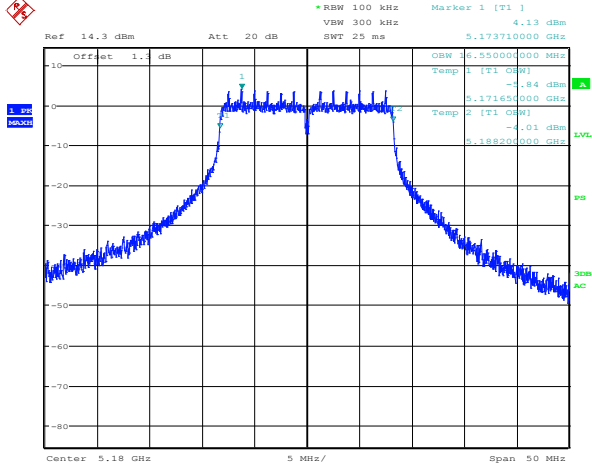

Date: 17.OCT.2017 08:54:29

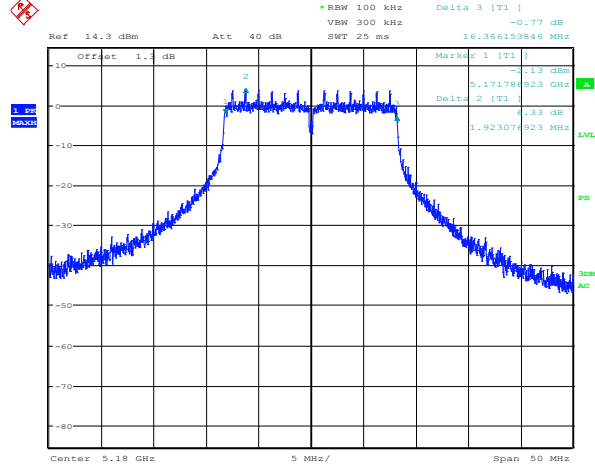

Date: 17.OCT.2017 08:53:12

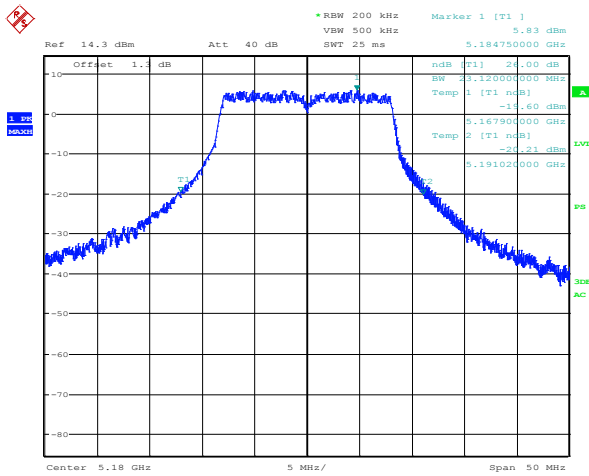

Date: 17.OCT.2017 08:56:57

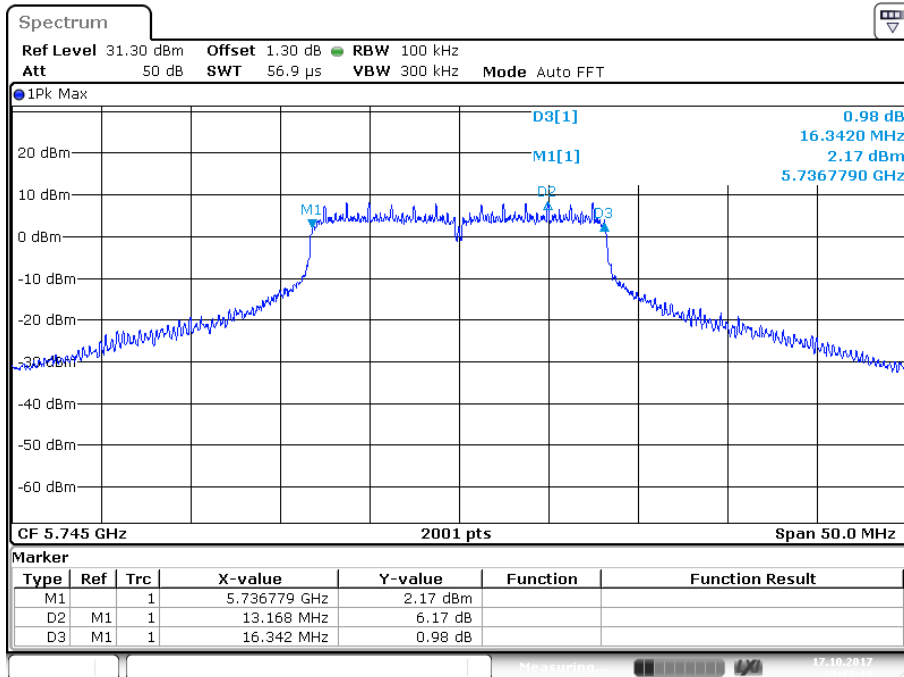

Date: 17.OCT.2017 23:12:20

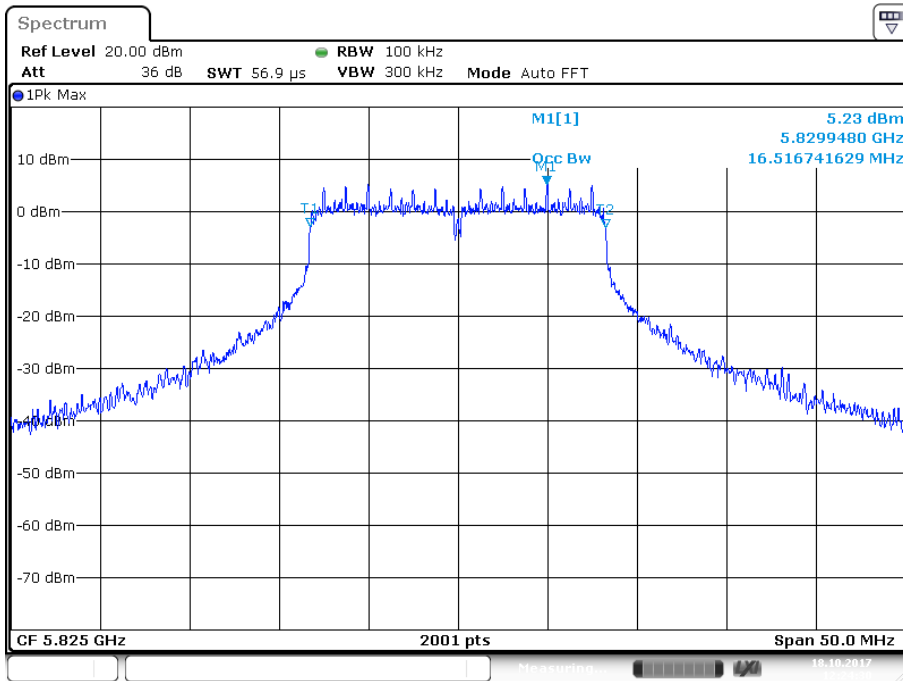

Date: 18 OCT 2017 12:24:31

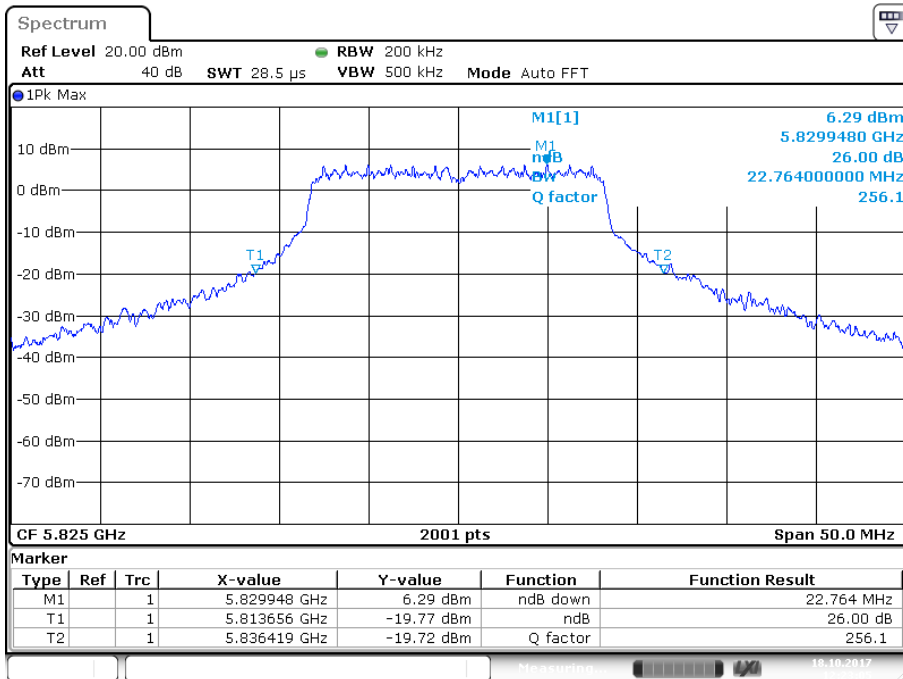

Date: 18 OCT 2017 12:23:05

## 4 Output Power

### 4.1 Test Result

Test Description	Test Specification	Test Result
Peak Output Power	15.407(a)	Compliant

### 4.2 Test Method

Fundamental power measurements were recorded using the procedures from ANSI C63.10: 2013 clause 12.3 and KDB document 789033 D02 General UNII Test Procedures New Rules v01r04.

Note: Antenna gain values were provided by the client. The values were maximum measured gains from the EUT. For correlated streams used in legacy 802.11 (a), the gain is higher because it represents the peak composite gain of all four antennas combined. For uncorrelated streams used in MIMO 802.11 (n/ac), the gain shown is the max peak gain when comparing all four antennas.

#### Limit

For an outdoor access point operating in the band 5.15-5.25 GHz, the maximum conducted output power over the frequency band of operation shall not exceed 1 W provided the maximum antenna gain does not exceed 6 dBi. Additionally, the maximum e.i.r.p. at any elevation angle above 30 degrees as measured from the horizon must not exceed 125 mW (21 dBm).

For the band 5.725-5.85 GHz, the maximum conducted output power over the frequency band of operation shall not exceed 1 W.

For using antennas with greater than 6dBi of gain, the limit is reduced in dB by the amount the gain exceeds 6dBi

### 4.3 Test Site

SGS EMC Laboratory, Suwanee, GA

#### Environmental Conditions

Temperature: 23.3 °C  
Relative Humidity: 52.7 %

### 4.4 Test Equipment

Initial measurements

Test End Date: 12-Oct-2017

Tester: FN

Equipment	Model	Manufacturer	Asset Number	Cal Due Date
EMI TEST RECEIVER	ESU40	ROHDE & SCHWARZ	B079629	25-Apr-2018
RF CABLE	SF102	HUBER & SUHNER	B079823	26-Jul-2018

Note: The equipment calibration period is 1 year.

## UNII Band 1 retest

Test End Date: 27-Mar-2018

Tester: JOP

Equipment	Model	Manufacturer	Asset Number	Cal Due Date
SIGNAL ANALYZER	FSV30	ROHDE & SCHWARZ	B085749	1-Nov-2019
RF CABLE	SF102	HUBER & SUHNER	B079822	27-Jul-2018
OPEN SWITCH AND CONTROL UNIT	OSP 120	ROHDE & SCHWARZ	S/N: 101182	CNR
ATTENUATOR, 10DB	10DB	ROHDE & SCHWARZ	B095591	28-Jul-2018

Note: The equipment calibration period is 1 year except for the FSV which is on a 2-year calibration cycle.

#### 4.5 Test Data – UNII Band 1

Note: Power levels in UNII Band 1 were reduced such that maximum EIRP in any direction would be limited to 21dBm (125mW). In this case, regardless of installation orientation, the requirement will always be met that the maximum e.i.r.p. at any elevation angle above 30 degrees as measured from the horizon must not exceed 125 mW (21 dBm)

802.11a							
Frequency (MHz)	Channel (WLAN)	Chain 0 (dBm)	Chain 1 (dBm)	Total Power (dBm)	Directional Gain (nANT=2)	Limit (dBm)	Margin (dB)
5180	36	11.117	10.707	13.93	6.00	21	-1.07
5200	44	12.326	10.58	14.55	6.00	21	-0.45
5240	48	12.226	11.018	14.67	6.00	21	-0.33

802.11n HT20							
Frequency (MHz)	Channel (WLAN)	Chain 0 (dBm)	Chain 1 (dBm)	Total Power (dBm)	Directional Gain (nANT=2)	Limit (dBm)	Margin (dB)
5180	36	11.112	10.717	13.93	6.00	21	-1.07
5220	44	12.238	10.517	14.47	6.00	21	-0.53
5240	48	12.178	10.783	14.55	6.00	21	-0.45

802.11n HT40							
Frequency (MHz)	Channel (WLAN)	Chain 0 (dBm)	Chain 1 (dBm)	Total Power (dBm)	Directional Gain (nANT=2)	Limit (dBm)	Margin (dB)
5190	38	11.638	10.567	14.15	6.00	21	-0.85
5230	46	12.812	9.4	14.44	6.00	21	-0.56

Note: Antenna gain is directional gain provided by applicant.

#### 4.6 Test Data – UNII Band 3

802.11a							
Frequency (MHz)	Channel (WLAN)	Chain 0 (dBm)	Chain 1 (dBm)	Total Power (dBm)	Antenna Gain (dBi)	Limit (dBm)	Margin (dB)
5745	149	18.80	17.80	21.34	6.00	30	-8.66
5785	157	18.75	17.91	21.37	6.00	30	-8.63
5825	165	19.20	18.17	21.73	6.00	30	-8.27

802.11n HT20							
Frequency (MHz)	Channel (WLAN)	Chain 0 (dBm)	Chain 1 (dBm)	Total Power (dBm)	Antenna Gain (dBi)	Limit (dBm)	Margin (dB)
5745	149	18.70	17.80	21.29	6.00	30	-8.71
5785	157	18.52	18.02	21.29	6.00	30	-8.71
5825	165	19.15	18.25	21.74	6.00	30	-8.26

802.11n HT40							
Frequency (MHz)	Channel (WLAN)	Chain 0 (dBm)	Chain 1 (dBm)	Total Power (dBm)	Antenna Gain (dBi)	Limit (dBm)	Margin (dB)
5755	151	19.40	18.75	22.10	6.00	30	-7.90
5795	159	19.80	19.16	22.51	6.00	30	-7.49

Note: Antenna gain is directional gain provided by applicant.

## 5 Power Spectral Density

### 5.1 Test Result

Test Description	Test Specification	Test Result
Power Spectral Density	15.407(a)	Compliant

### 5.2 Test Method

Fundamental power measurements were recorded using the procedures from ANSI C63.10: 2013 clause 12.5 and KDB document 789033 D02 General UNII Test Procedures New Rules v01r04. The lowest data rate for each modulation was determined to be the worst-case.

#### Limit

The limit is 17dBm in any 1MHz band for channels in the 5.15-5.25GHz band and 30dBm in any 500-kHz band for channels in the 5.725-5.85GHz band.

### 5.3 Test Site

SGS EMC Laboratory, Suwanee, GA

#### Environmental Conditions

Temperature: 23.3 °C  
Relative Humidity: 52.7 %

### 5.4 Test Equipment

Test End Date: 12-Oct-2017

Tester: FN

Equipment	Model	Manufacturer	Asset Number	Cal Due Date
EMI TEST RECEIVER	ESU40	ROHDE & SCHWARZ	B079629	25-Apr-2018
RF CABLE	SF102	HUBER & SUHNER	B079823	26-Jul-2018
SPECTRUM ANALYZER	FSV30	ROHDE & SCHWARZ	101106	20-Sep-2018

Note: The equipment calibration period is 1 year.

### 5.5 Test Data (UNII Band 1)

Protocol	Channel	Meas PSD Chain 0 (dBm/MHz)	Meas PSD Chain 1 (dBm/MHz)	Max PSD Summed (dBm/MHz)	Limit (dBm)	Margin (dB)
802.11a	36	4.55	2.34	6.59	17	-10.41
802.11a	44	6.46	4.48	8.59	17	-8.41
802.11a	48	6.5	4.77	8.73	17	-8.27
802.11n (HT20)	36	5.94	4.69	8.37	17	-8.63
802.11n (HT20)	44	5.86	3.78	7.95	17	-9.05
802.11n (HT20)	48	6.05	4.11	8.20	17	-8.80
802.11n (HT40)	38	5.37	2.4	7.14	17	-9.86
802.11n (HT40)	46	5.54	2.5	7.29	17	-9.71

Note: Antenna gain is directional gain provided by applicant.

### Sample Plot

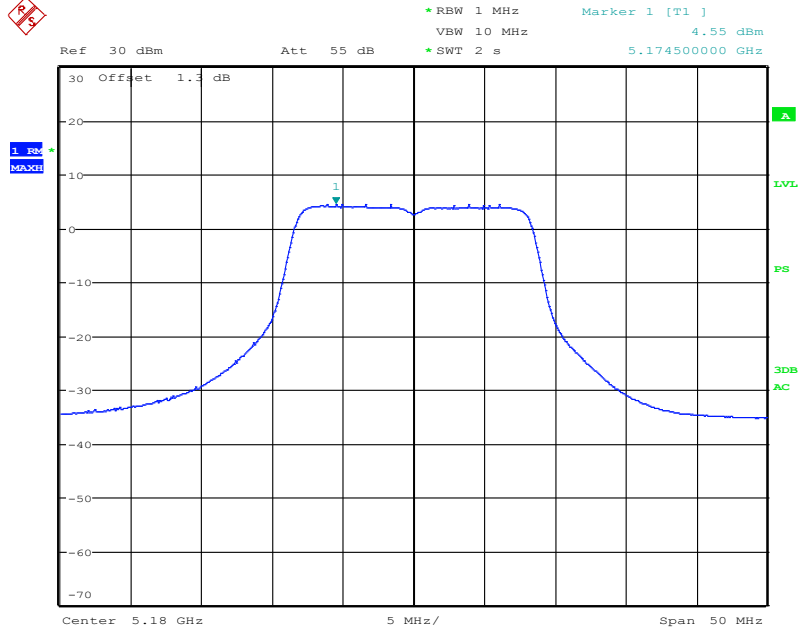

Date: 17.OCT.2017 09:09:48



### 5.6 Test Data (UNII Band 3)

Protocol	Channel	Meas PSD Chain 0 (dBm/500kHz)	Meas PSD Chain 1 (dBm/500kHz)	Max PSD (dBm/500kHz)	Limit (dBm)	Margin (dB)
802.11a	149	5.7	5.02	8.38	30	-21.62
802.11a	157	5.97	5.35	8.68	30	-21.32
802.11a	165	4.52	3.14	6.89	30	-23.11
802.11n (HT20)	149	6.13	5.18	8.69	30	-21.31
802.11n (HT20)	157	6.09	5.13	8.65	30	-21.35
802.11n (HT20)	165	4.68	3.41	7.10	30	-22.90
802.11n (HT40)	151	2.22	1.3	4.79	30	-25.21
802.11n (HT40)	159	1.91	0.56	4.30	30	-25.70

Note: Antenna gain is directional gain provided by applicant.

Sample Plot

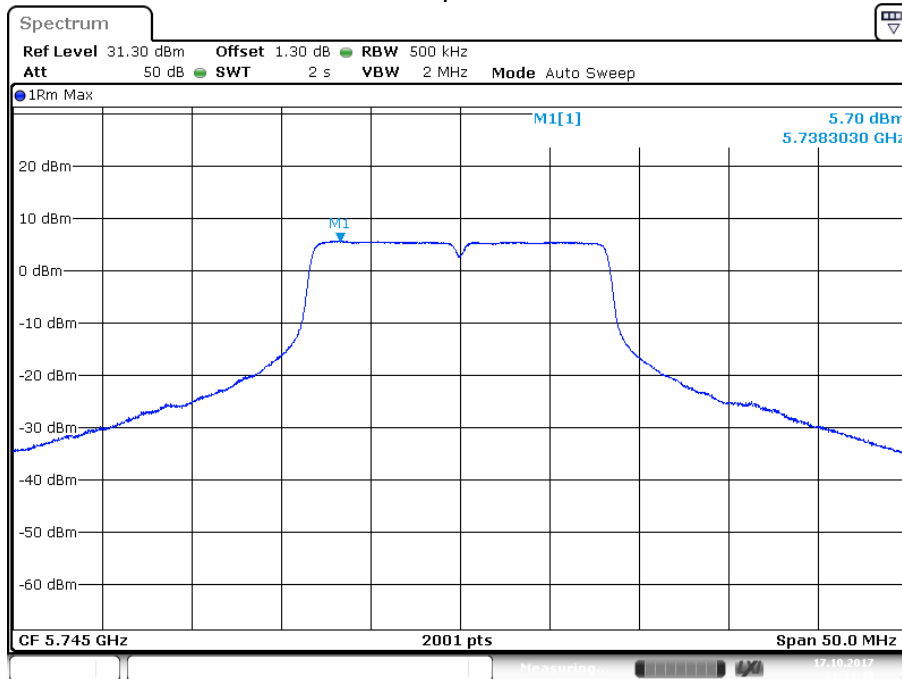

Date: 17.OCT 2017 21:34:50

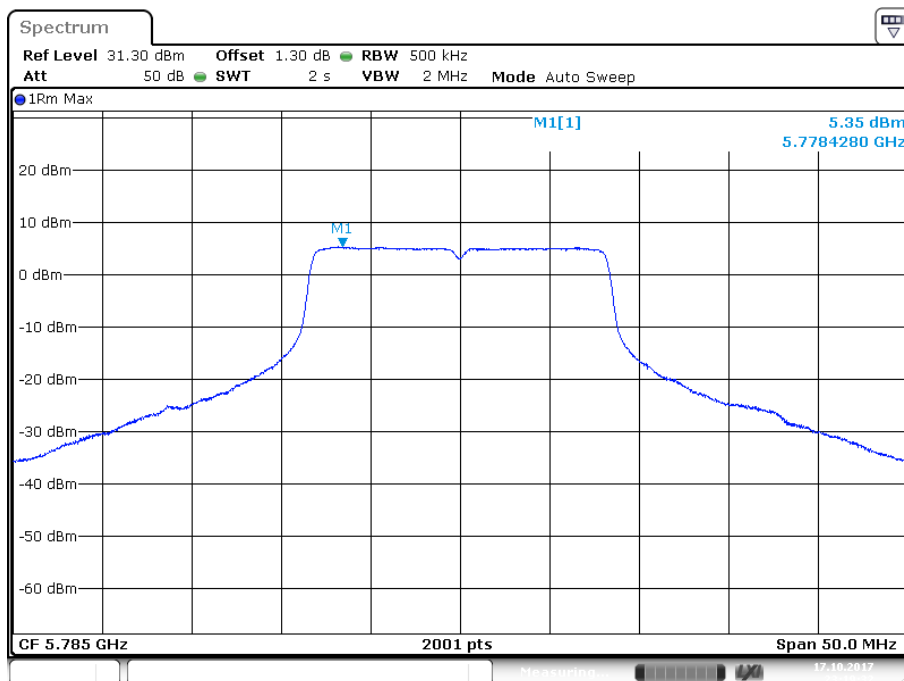

Date: 17 OCT 2017 23:19:32

## 6 Unwanted Emissions

### 6.1 Test Result

Test Description	Test Specification	Test Result
Spurious Emissions	15.407(b) ANSI C63.10: 2013	Compliant

### 6.2 Test Method

Testing was performed using the radiated and conducted methods defined in ANSI C63.10: 2013 clause 12.7 and KDB 789033 D02 General UNII Test Procedures New Rules v01r04. In lieu of the marker-delta or integration methods, band edge compliance was shown using a peak detector and a 1MHz resolution bandwidth.

Lowest, middle, and highest channels were investigated for each band. Only the modulation providing the worst-case power was reported except at the band edges where all modulations and bandwidths were measured. The frequency range examined was 9kHz to 40GHz. A pre-scan was performed in the 9kHz-30MHz range and no emissions associated with the radio were observed.

#### Limit:

For transmitters operating in the 5.15-5.25 GHz band: All emissions outside of the 5.15-5.35 GHz band shall not exceed an e.i.r.p. of -27 dBm/MHz.

For transmitters operating in the 5.725-5.85 GHz band: All emissions within the frequency range from the band edge to 10 MHz above or below the band edge shall not exceed an e.i.r.p. of -17 dBm/MHz; for frequencies 10 MHz or greater above or below the band edge, emissions shall not exceed an e.i.r.p. of -27 dBm/MHz.

### 6.3 Test Site

SGS EMC Laboratory, Suwanee, GA

#### Environmental Conditions

Temperature: 23.3 °C  
Relative Humidity: 52.7 %

### 6.4 Test Equipment – Conducted Measurements

Test End Date: 12-Oct-2017

Tester: FN

Equipment	Model	Manufacturer	Asset Number	Cal Due Date
EMI TEST RECEIVER	ESU40	ROHDE & SCHWARZ	B079629	25-Apr-2018
RF CABLE	SF102	HUBER & SUHNER	B079823	26-Jul-2018

Note: The equipment calibration period is 1 year.

## 6.5 Test Equipment – Radiated Measurements

Test End Date: 23-Oct-2017

Tester: FN

Equipment	Model	Manufacturer	Asset Number	Cal Due Date
EMI TEST RECEIVER	ESU8	ROHDE & SCHWARZ	B085759	25-Jul-2018
EMI TEST RECEIVER	ESU40	ROHDE & SCHWARZ	B079629	25-Apr-2018
ANTENNA, BILOG	JB6	SUNOL	B079690	10-Nov-2017
ANTENNA, DRG HORN (MEDIUM)	3117	ETS LINDGREN	B079699	16-May-2018
ANTENNA, DRG HORN (MEDIUM)	3117	ETS LINDGREN	B079691	27-Jul-2018
RF CABLE	SF106	HUBER & SUHNER	B079712	24-Jul-2018
RF CABLE	NFS-290-78.7-NFS	FLORIDA RF LABS	B095019	24-Jul-2018
RF CABLE	CBL-25FT-NMNM	MINI-CIRCUITS	B094941	25-Jul-2018
RF CABLE	104PE	HUBER & SUHNER	B079793	24-Jul-2018
RF CABLE	SF106	HUBER & SUHNER	B079661	25-Jul-2018
RF CABLE	SUCOFLEX 100	HUBER & SUHNER	B108523	24-Jul-2018
FILTER, HIGH PASS (>2800MHZ)	HPM50111	MICRO-TRONICS	B085747	27-Jul-2018
FILTER, HIGH PASS (>6250MHZ)	HPM50112	MICRO-TRONICS	B093647	27-Jul-2018
RF CABLE	SF106	HUBER & SUHNER	B079716	24-Jul-2018
LOW NOISE AMPLIFIER	TS-PR18	ROHDE & SCHWARZ	15003	28-Jul-2018
LOW NOISE AMPLIFIER	TS-PR18	ROHDE & SCHWARZ	B094463	22-Feb-2018
RF CABLE	SF106	HUBER & SUHNER	B079659	25-Jul-2018
RF CABLE	SUCOFLEX 100	HUBER & SUHNER	B108523	24-Jul-2018
HORN(SMALL)	LB-180400-20-C-KF	A-INFO	15007	21-Mar-2018
RF CABLE	SF102	HUBER & SUHNER	B079822	27-Jul-2018
RF CABLE	SF102	HUBER & SUHNER	B079824	26-Jul-2018
LOW NOISE AMPLIFIER	NSP1840-HG	MITEQ	B087572	28-Jul-2018

Note: The equipment calibration period is 1 year.

### 6.6 Test Data - UNII Band 1 – Radiated Band Edge

#### 802.11a Channels 36 and 48

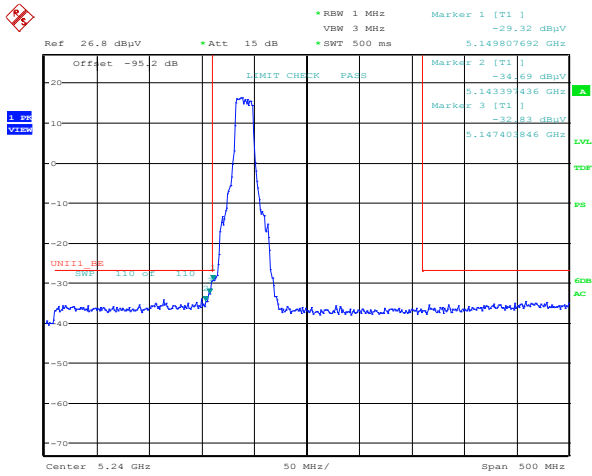

Date: 20.SEP.2017 09:48:29

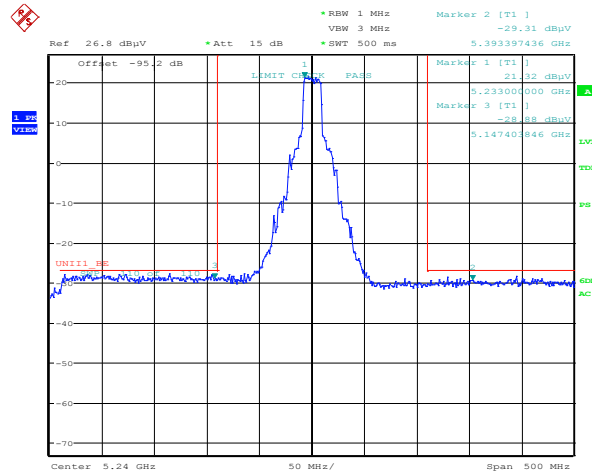

Date: 20.SEP.2017 10:19:31

#### 802.11n (HT20) Channels 36 and 48

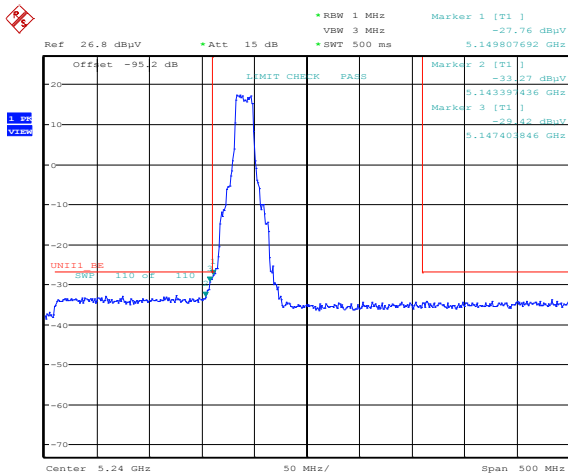

Date: 20.SEP.2017 10:01:22

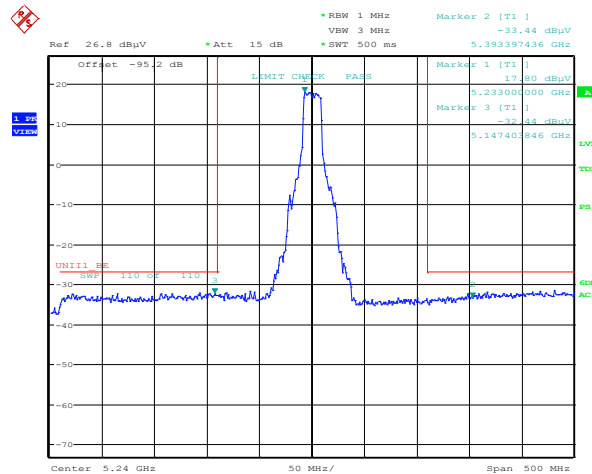

Date: 20.SEP.2017 10:11:33

802.11n (HT40)  
Channels 38 and 46

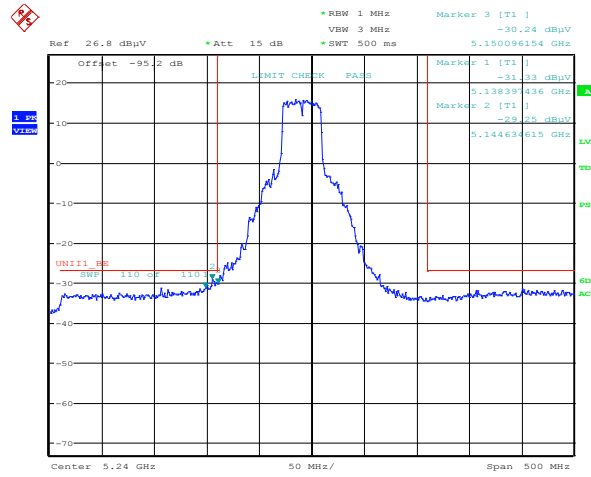
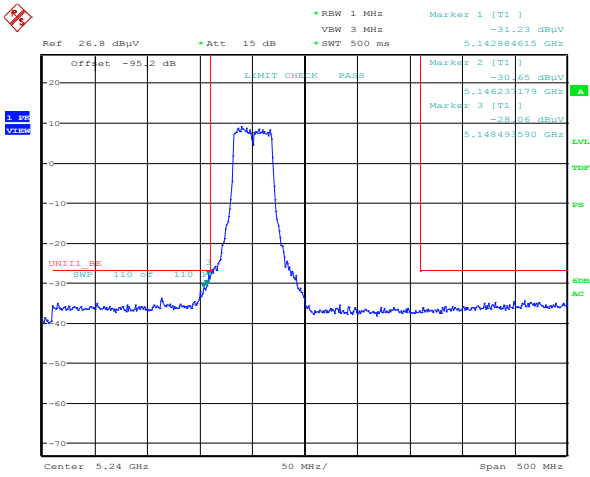

Date: 20.SEP.2017 14:07:30

Date: 20.SEP.2017 14:28:42

### 6.7 Test Data - UNII Band 3 – Radiated Band Edge

#### 802.11a Channels 149 and 165

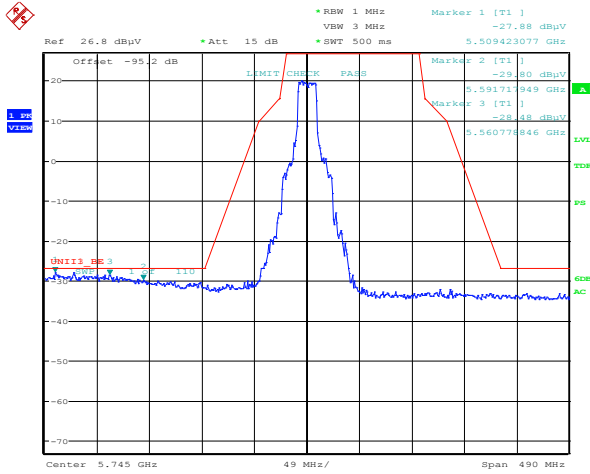

Date: 20.SEP.2017 11:22:49

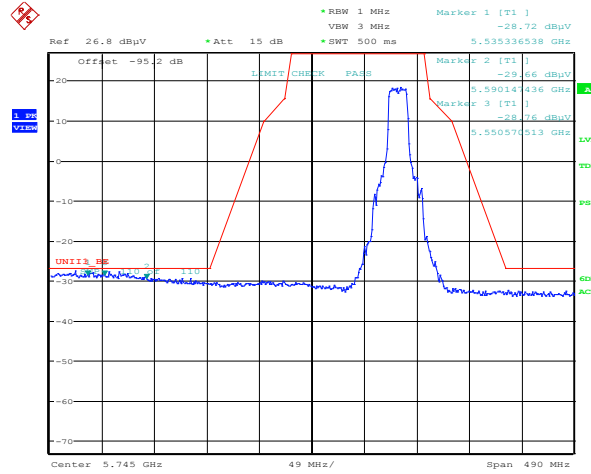

Date: 20.SEP.2017 13:27:22

#### 802.11n (HT20) Channels 149 and 165

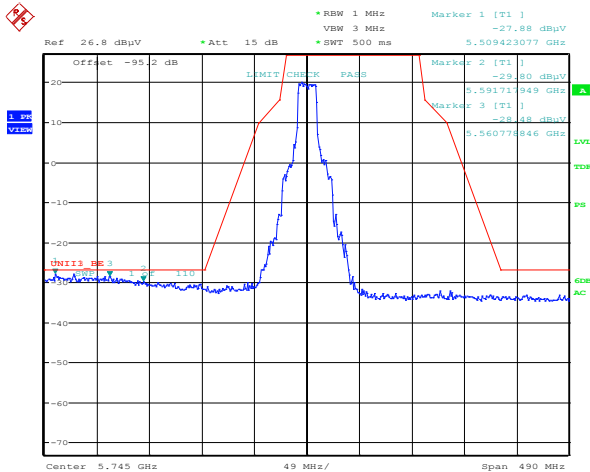

Date: 20.SEP.2017 11:22:49

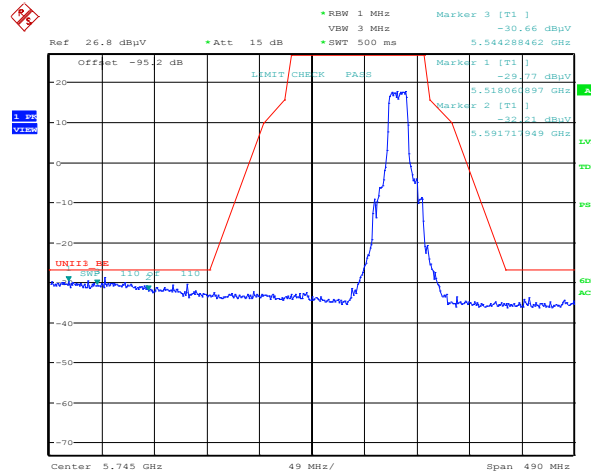

Date: 20.SEP.2017 11:54:09

## 802.11n (HT40) Channels 151 and 159

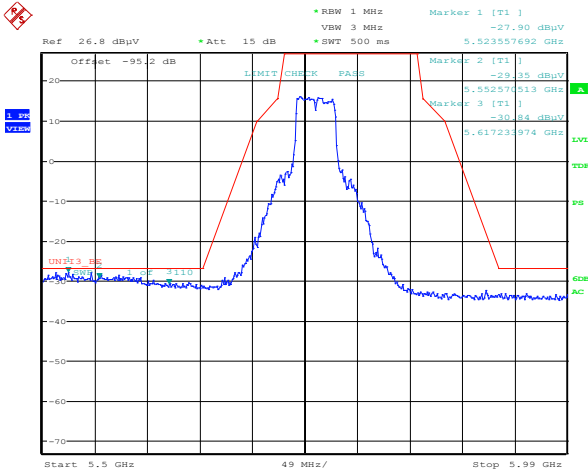

Date: 20.SEP.2017 14:41:39

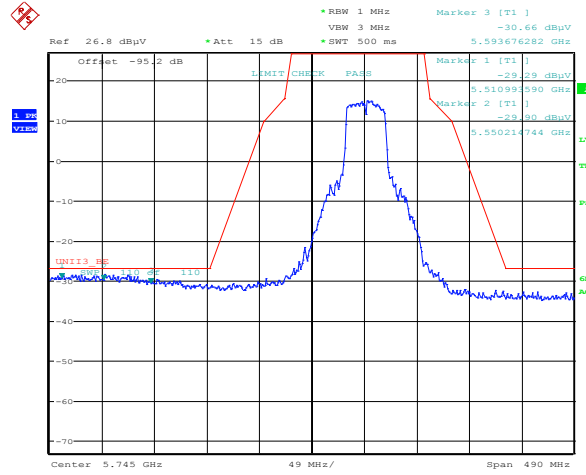

Date: 20.SEP.2017 14:55:04



### 6.8 Test Data – Conducted Spurs

Conducted Spurs – 802.11a, 6Mbit/s, Channel 36

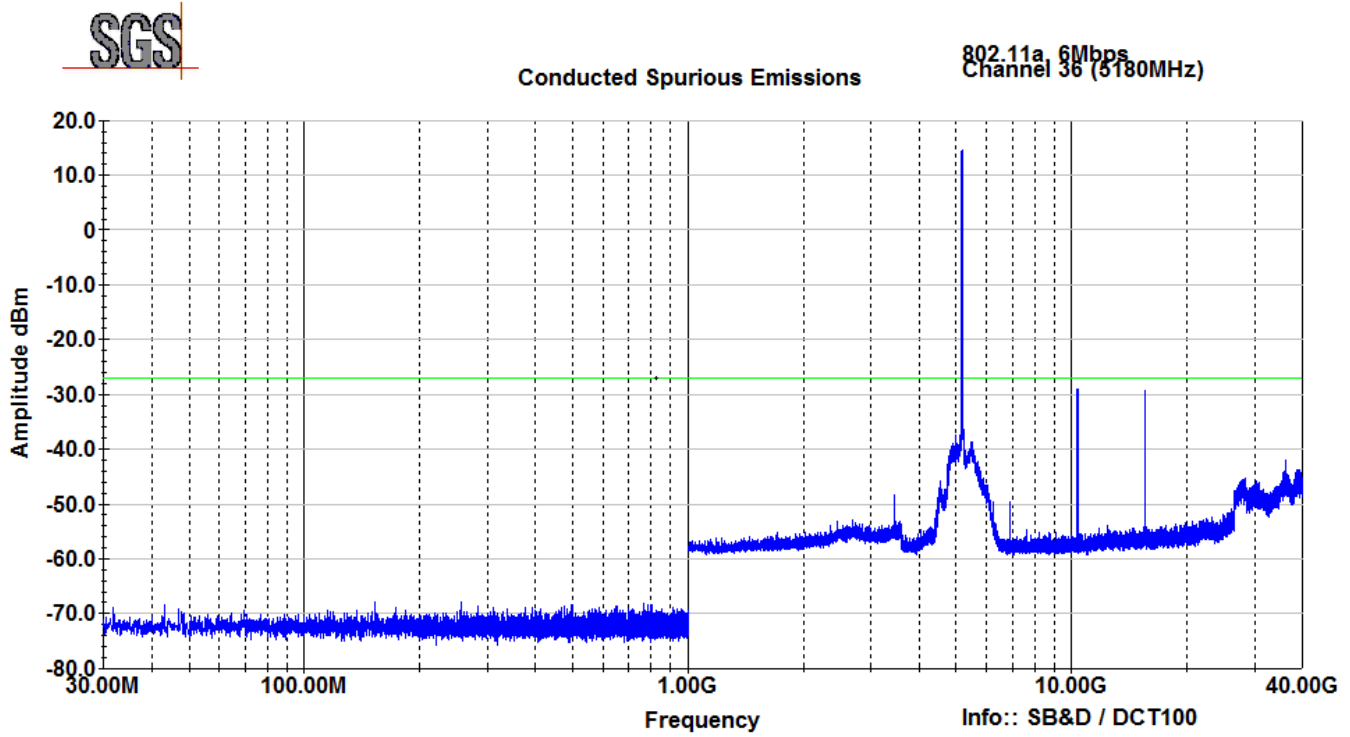

Conducted Spurs – 802.11a, 6Mbit/s, Channel 44

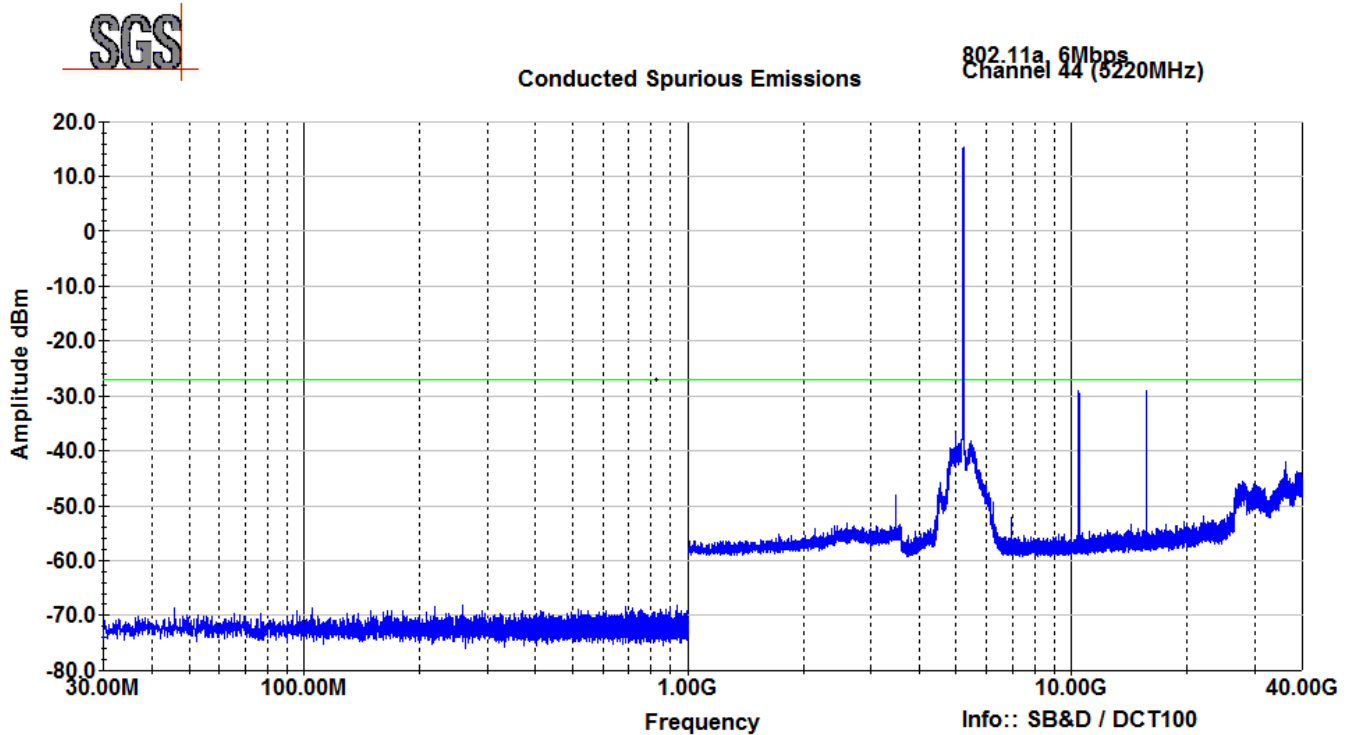

Conducted Spurs – 802.11a, 6Mbit/s, Channel 48

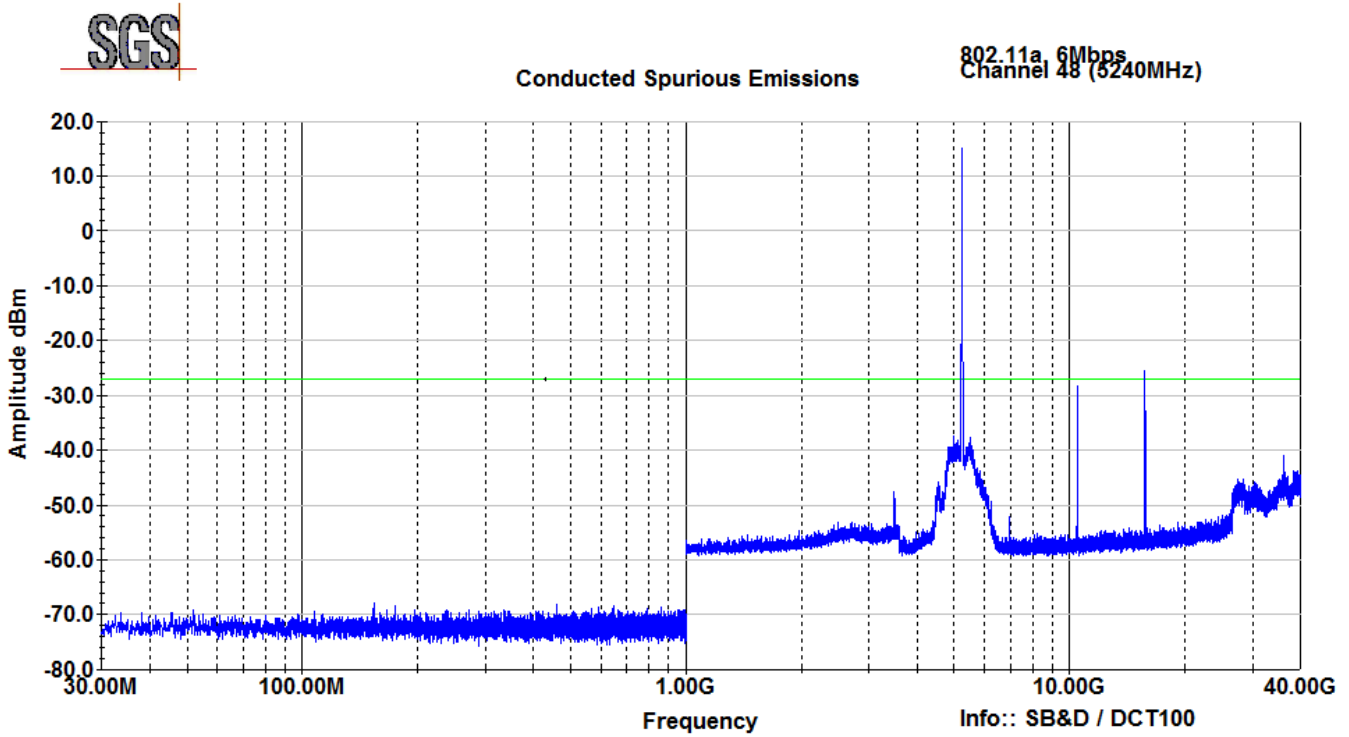

Conducted Spurs – 802.11a, 6Mbit/s, Channel 149

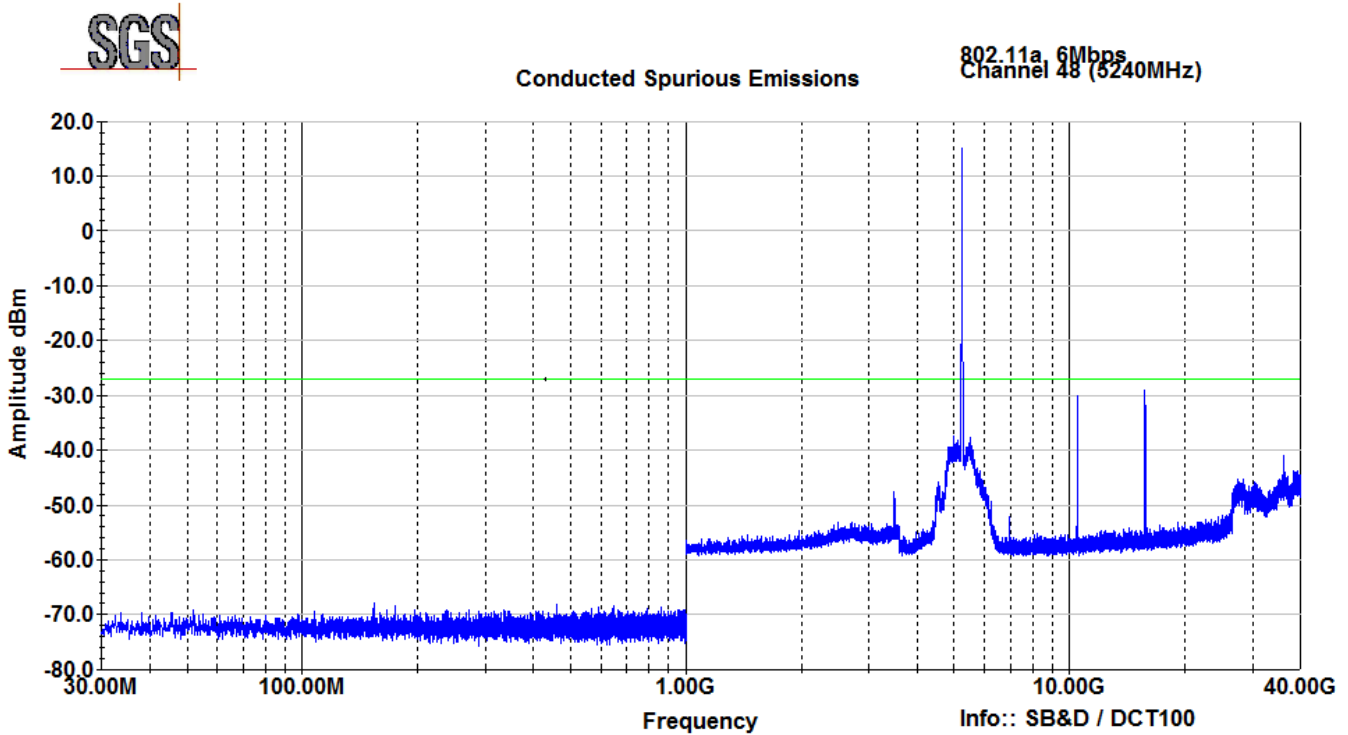

Conducted Spurs – 802.11a, 6Mbit/s, Channel 157

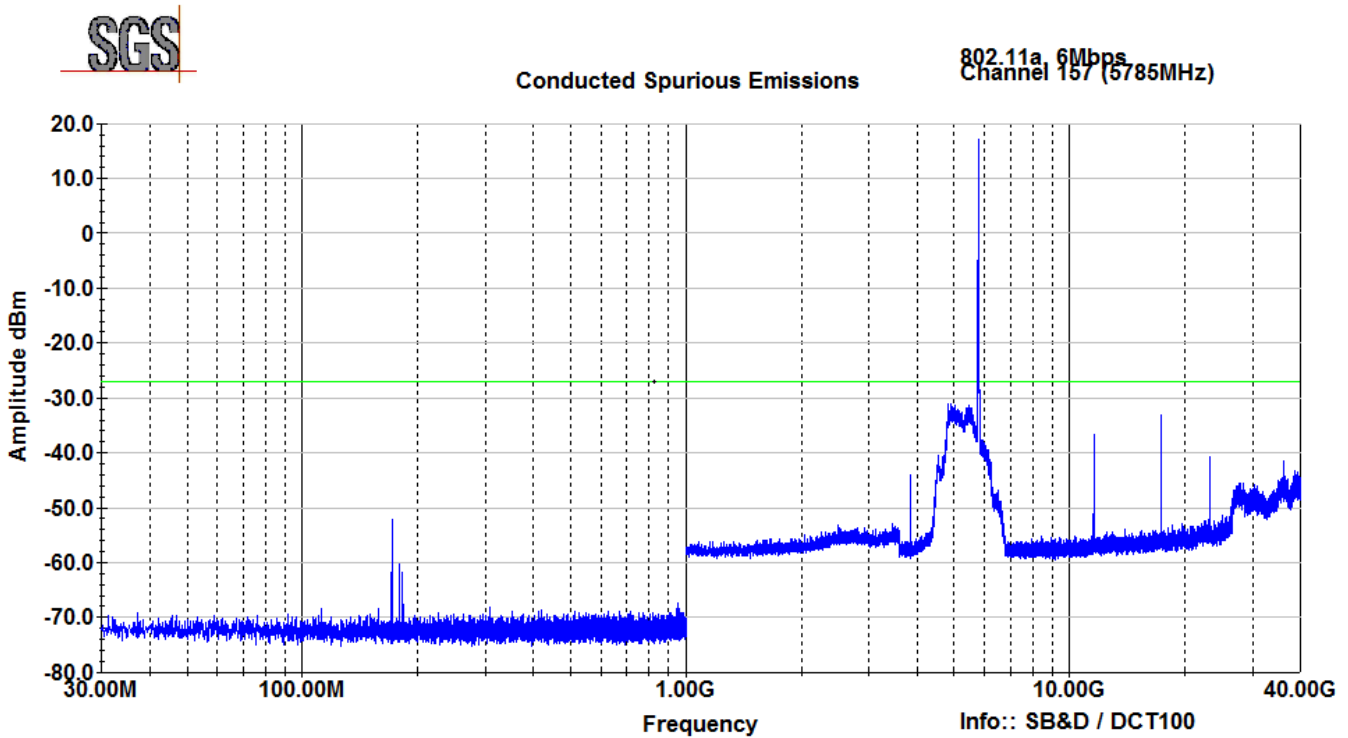

Conducted Spurs – 802.11a, 6Mbit/s, Channel 165

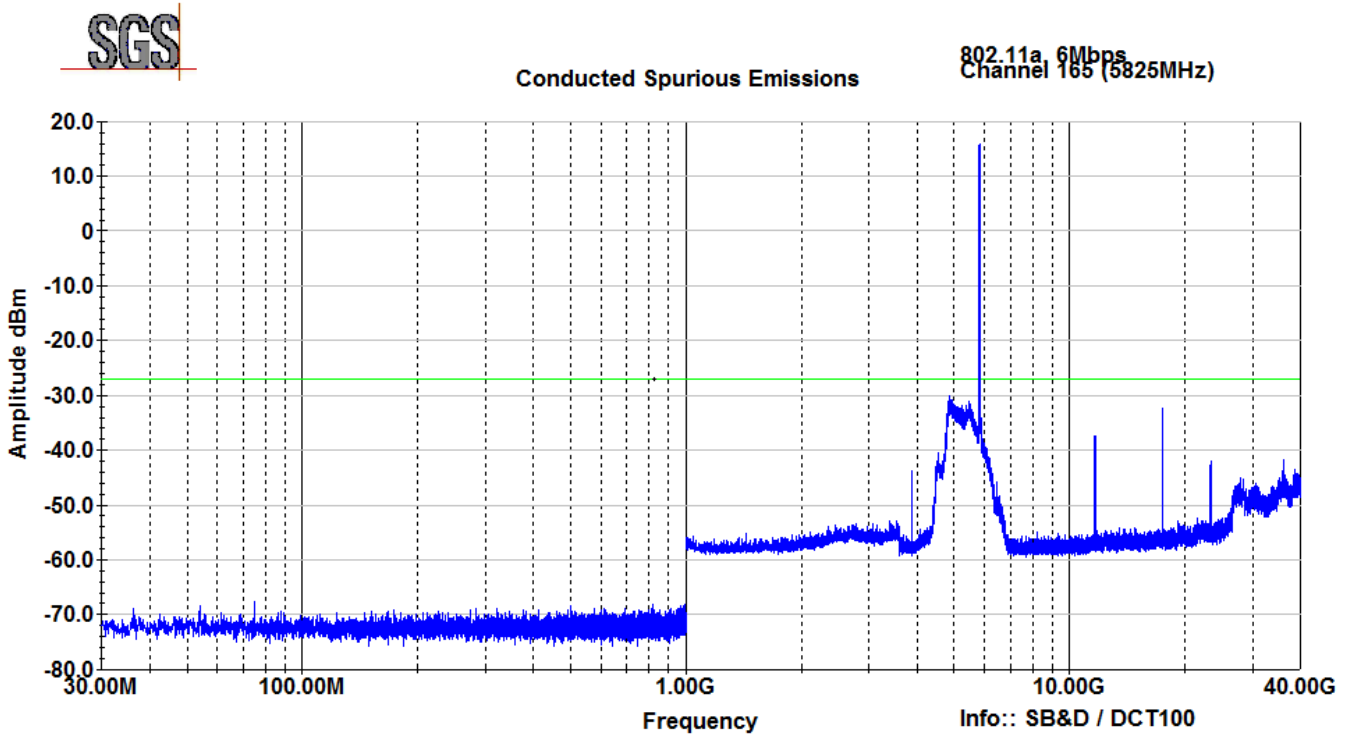

### 6.9 Unwanted Emissions – Cabinet Radiation

Channel 36  
Vertical (1-6GHz)

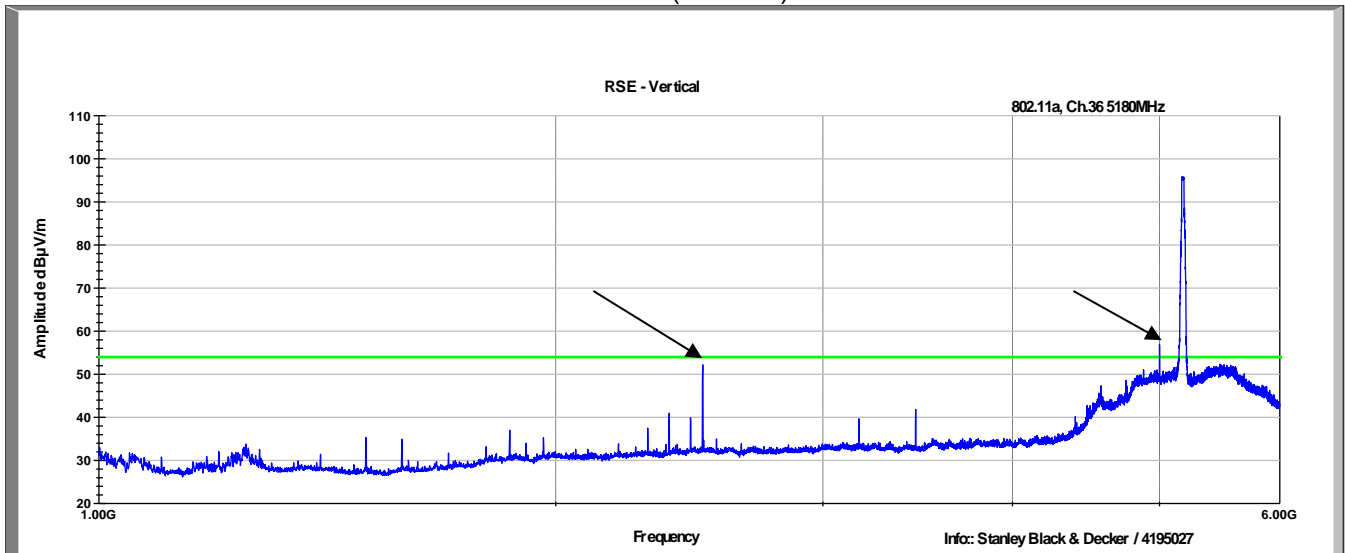

2.5GHz and 5GHz were determined to be digital emissions. These were evaluated under the Subpart B requirements.

Channel 36  
Horizontal (1-6GHz)

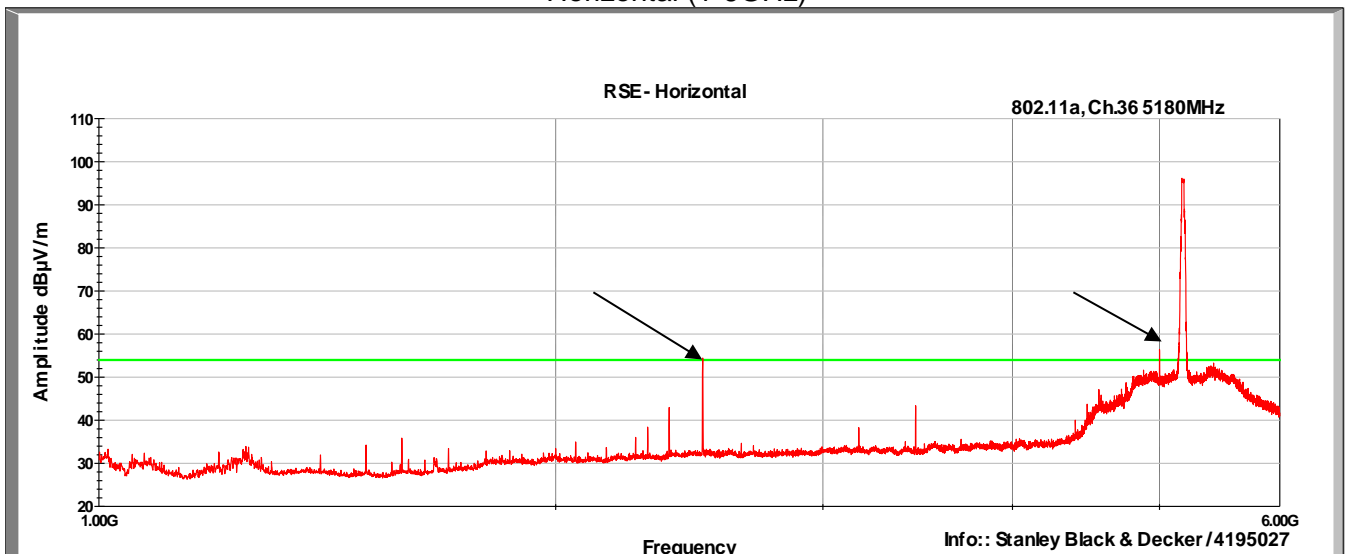

2.5GHz and 5GHz were determined to be digital emissions. These were evaluated under the Subpart B requirements.

Channel 36  
Vertical (6-18GHz)

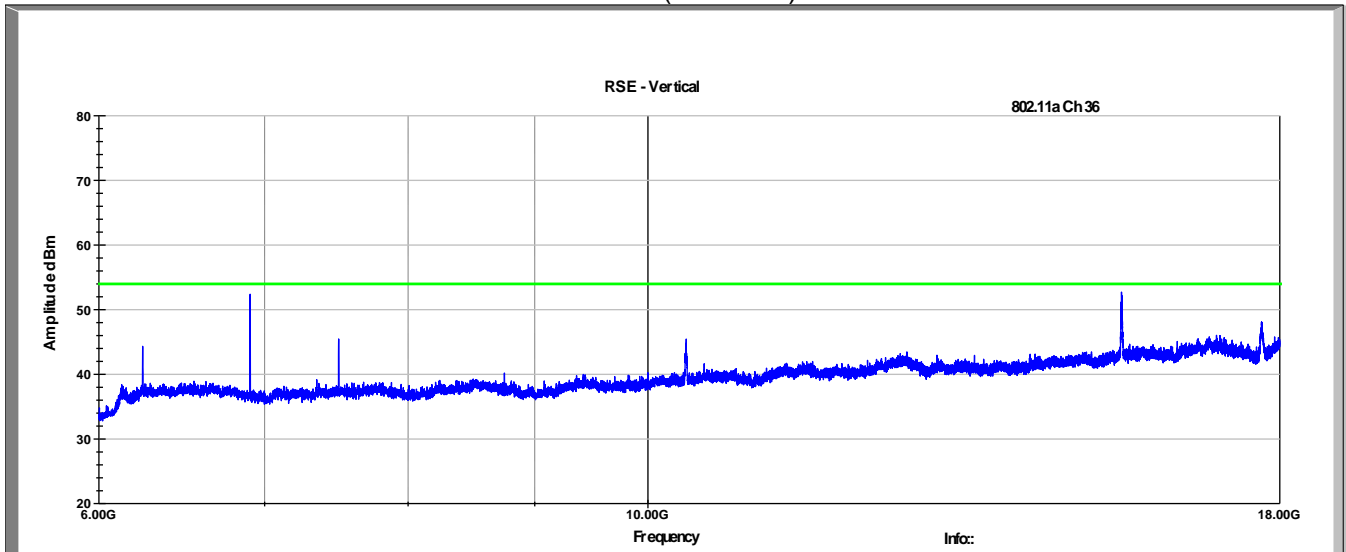

Channel 36  
Horizontal (6-18GHz)

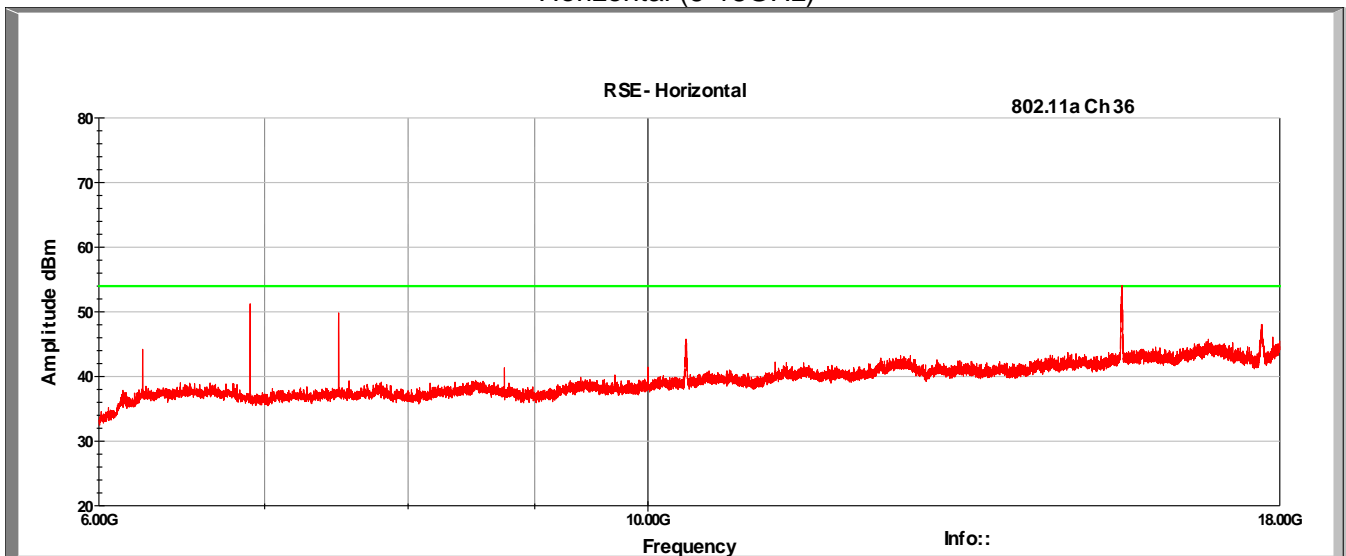

Channel 36  
Vertical (18-40GHz)

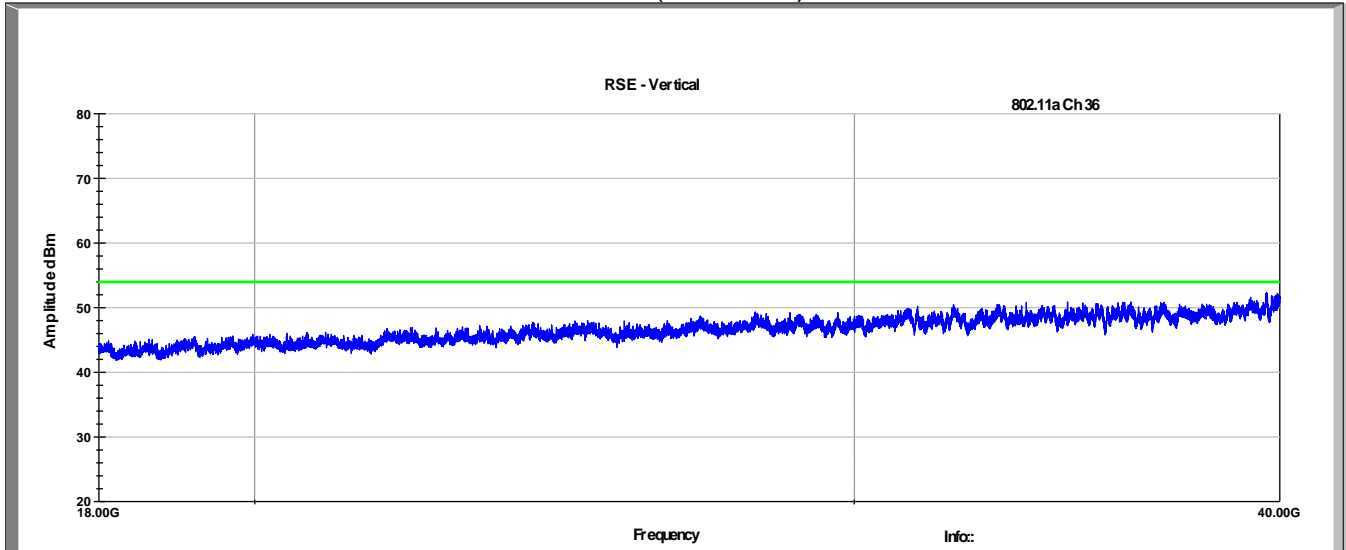

Channel 36  
Horizontal (18-40GHz)

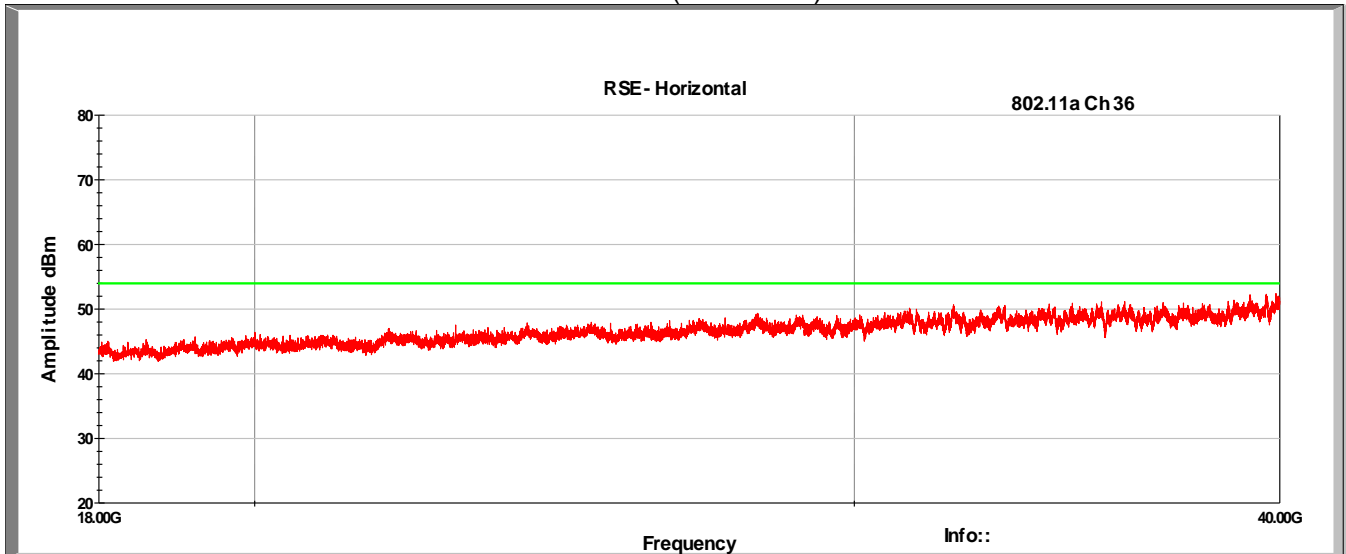

Channel 44  
Vertical (30-1000MHz)

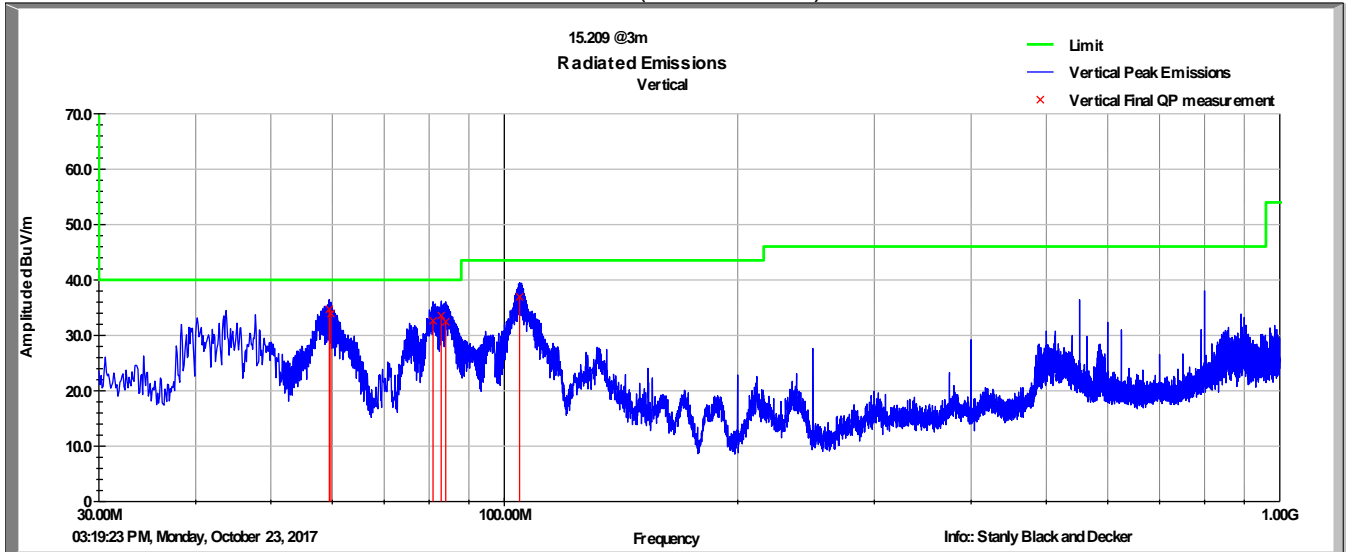

Frequency MHz	Raw QP (dBuV)	Polarity (V/H)	Azimuth (degrees)	Height (cm)	AF (dB/m)	Loss (dB)	Amp (dB)	QP Value (dBuV/m)	Limit (dBuV/m)	Margin (dB)
59.47	59.1	V	291.0	175.0	7.5	1.1	33.0	34.7	40.0	-5.3
59.76	58.3	V	221.0	137.0	7.5	1.1	33.0	33.9	40.0	-6.1
80.92	57.3	V	97.0	120.0	7.8	1.3	33.7	32.6	40.0	-7.4
82.91	58.4	V	278.0	120.0	7.6	1.3	33.7	33.6	40.0	-6.4
84.04	57.3	V	253.0	127.0	7.6	1.3	33.7	32.4	40.0	-7.6
104.64	57.6	V	149.0	120.0	11.7	1.5	33.7	37.0	43.5	-6.6
QP Value = Level + AF + CL - Amp										
Margin = QP Value - Limit										

Channel 44  
Horizontal (30-1000MHz)

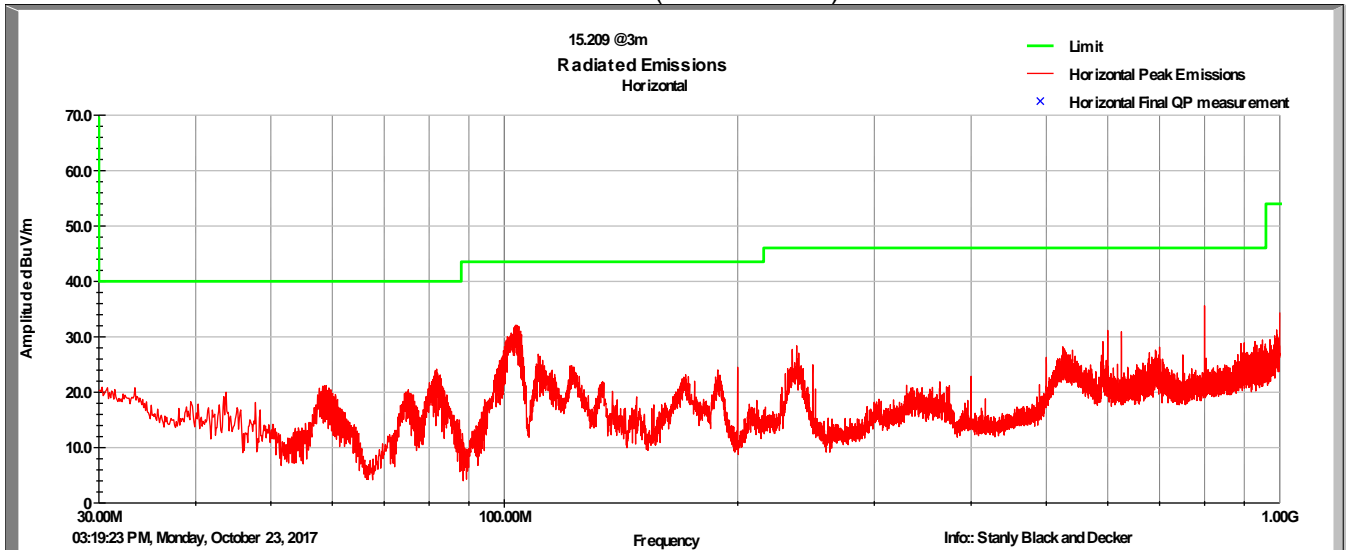



Channel 44  
Vertical (1-6GHz)

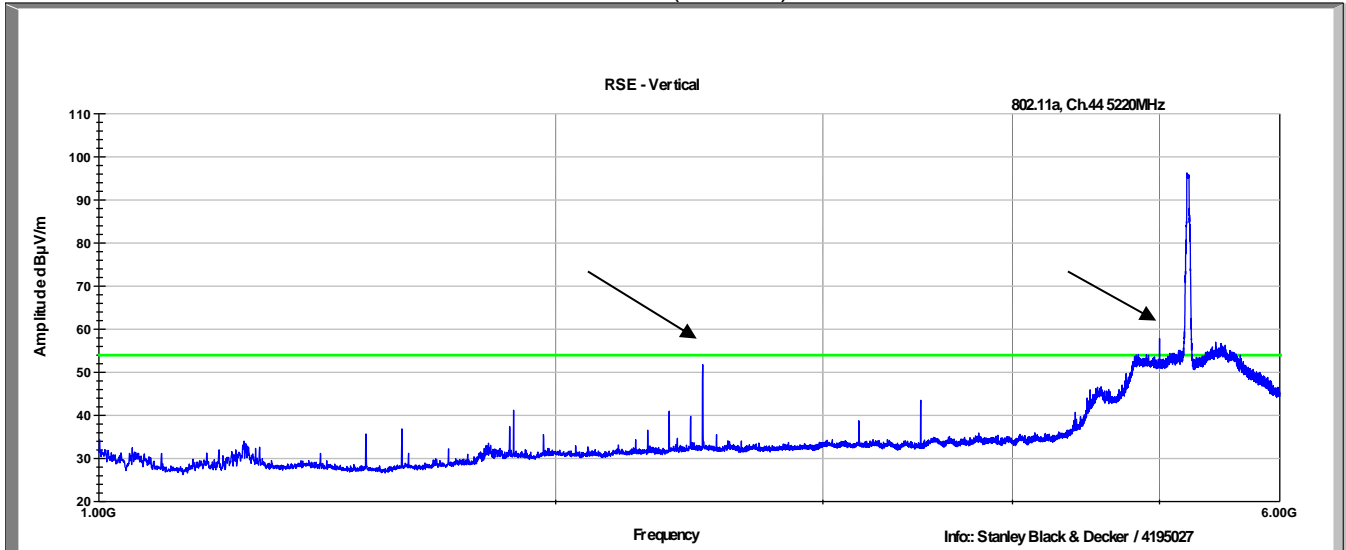

2.5GHz and 5GHz were determined to be digital emissions. These were evaluated under the Subpart B requirements.

Channel 44  
Horizontal (1-6GHz)

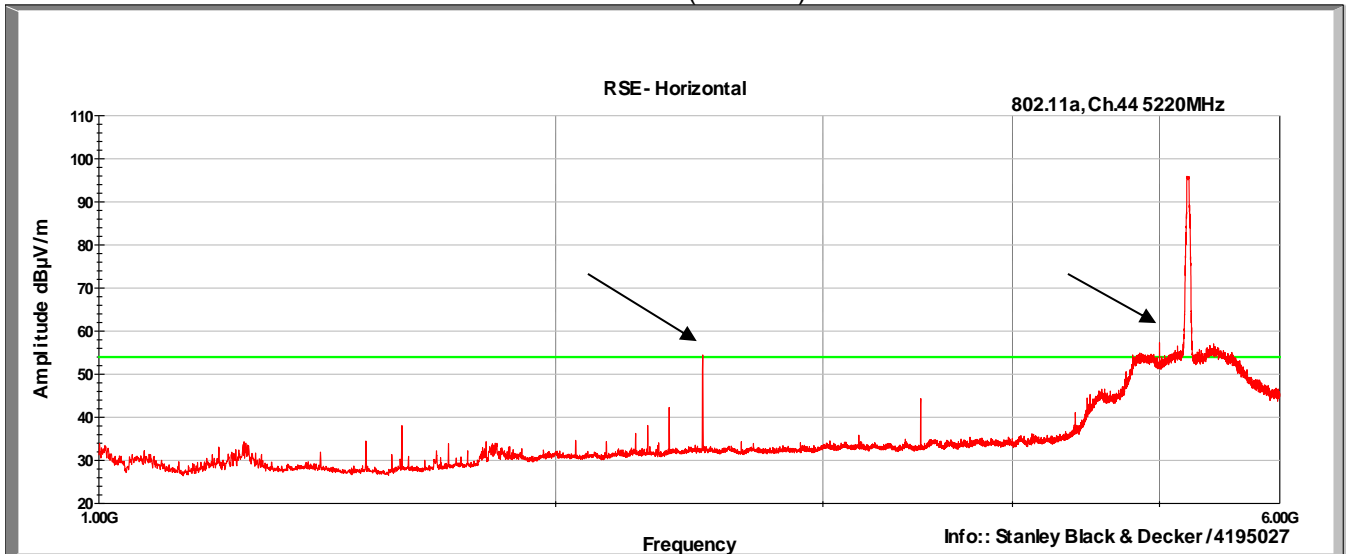

2.5GHz and 5GHz were determined to be digital emissions. These were evaluated under the Subpart B requirements.

Channel 44  
Vertical (6-18GHz)

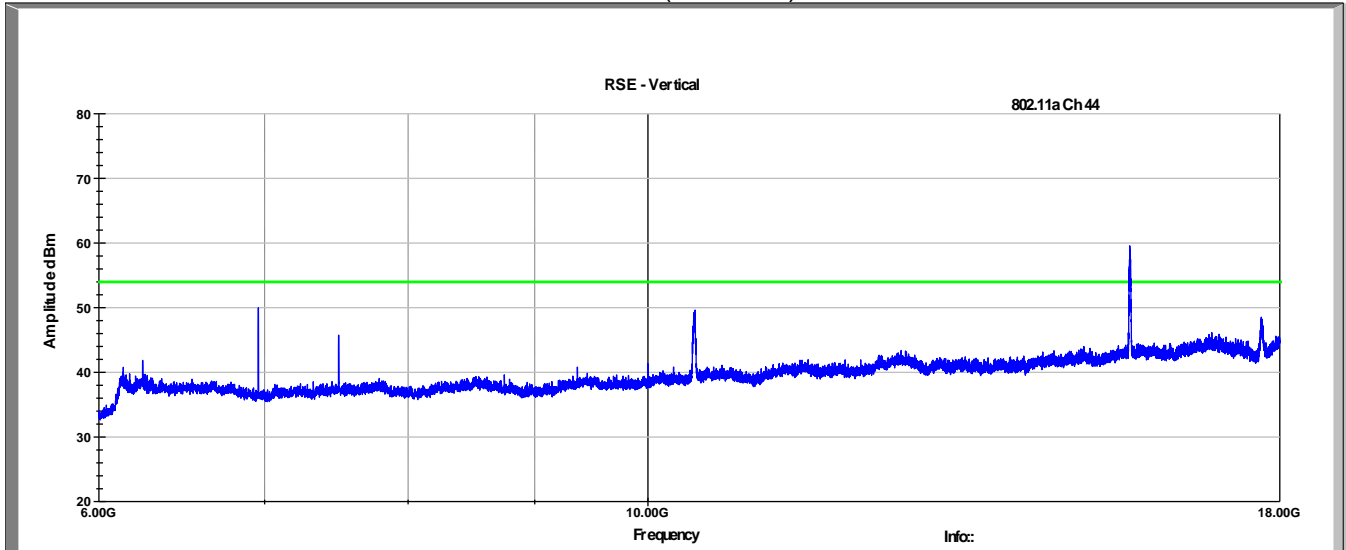

Channel 44  
Horizontal (6-18GHz)

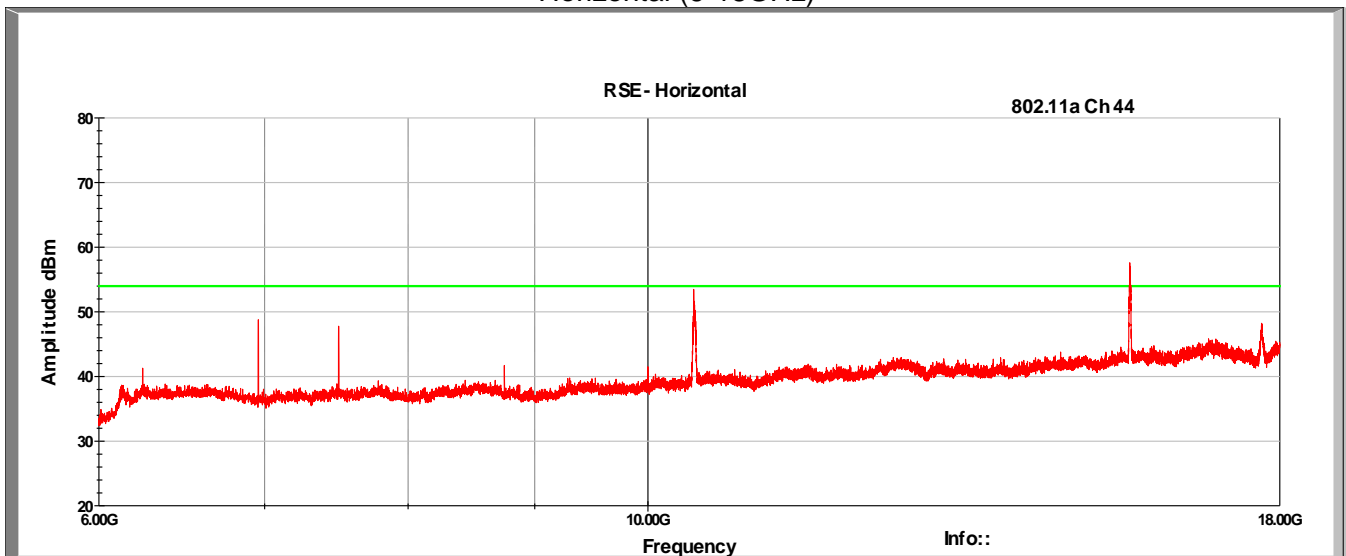

Channel 44  
Vertical (18-40GHz)

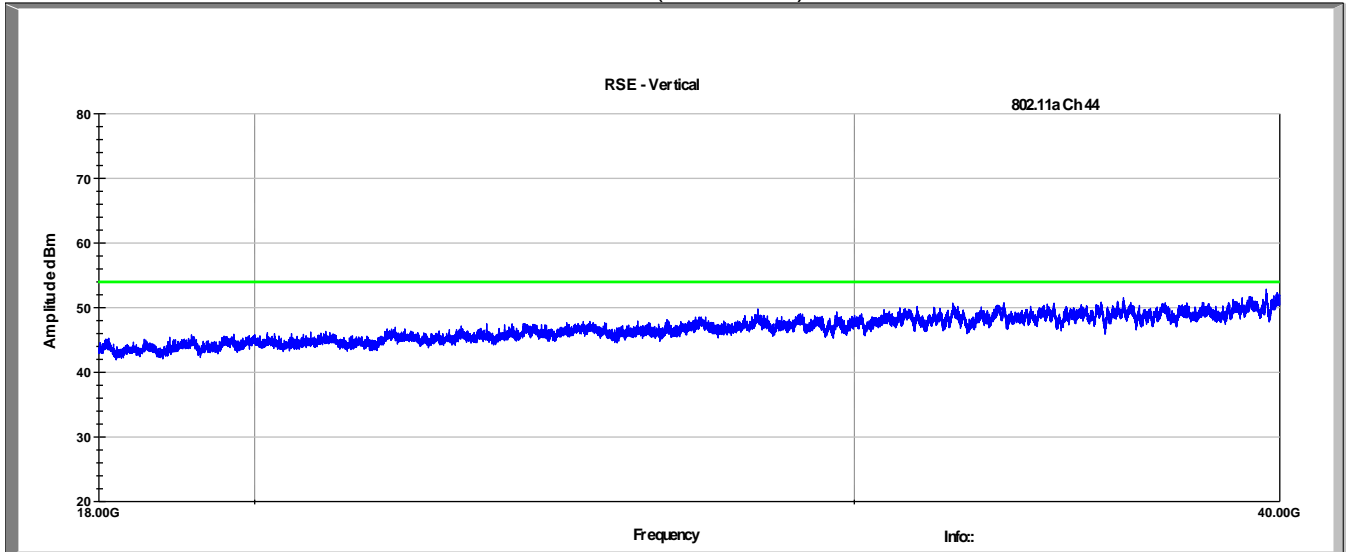

Channel 44  
Horizontal (18-40GHz)

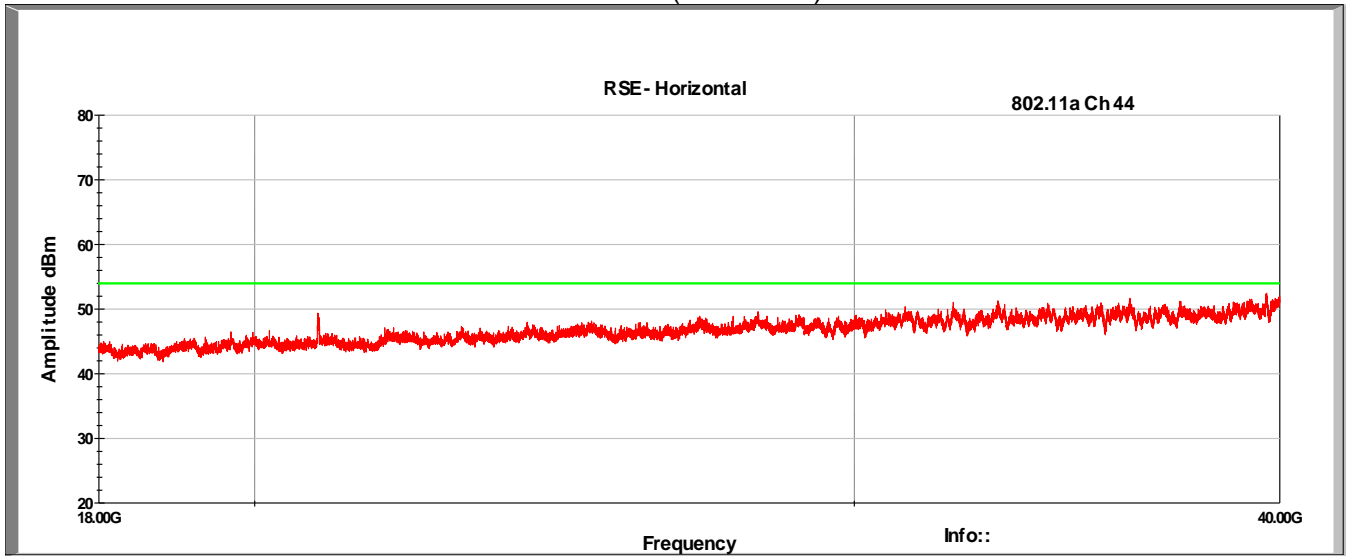

Channel 48  
Vertical (1-6GHz)

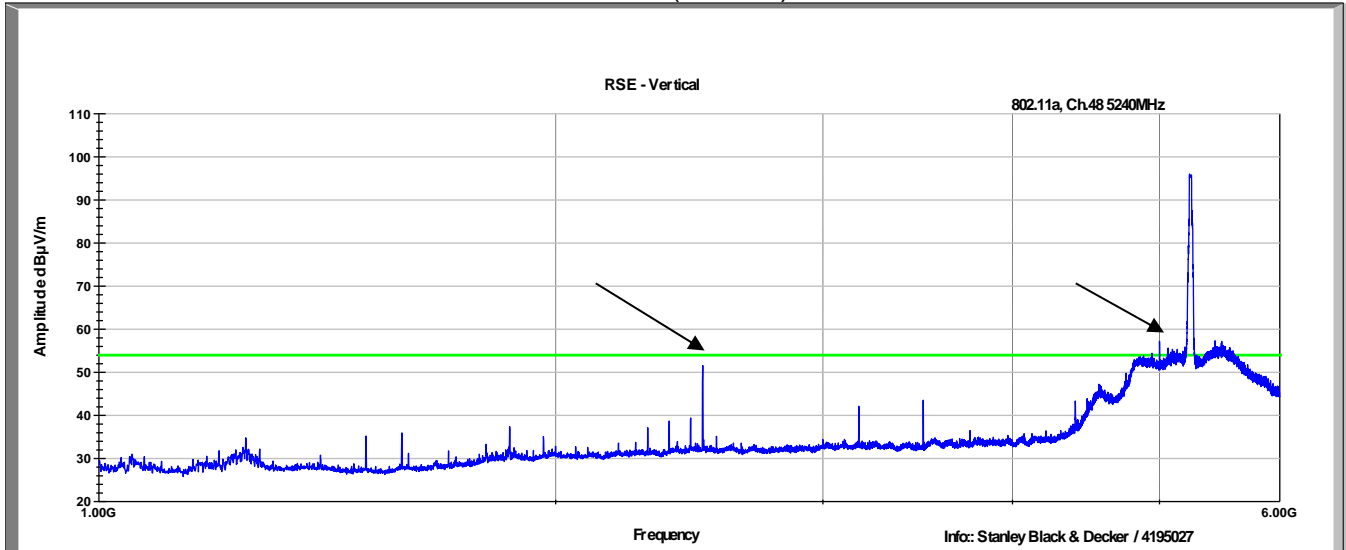

2.5GHz and 5GHz were determined to be digital emissions. These were evaluated under the Subpart B requirements.

Channel 48  
Horizontal (1-6GHz)

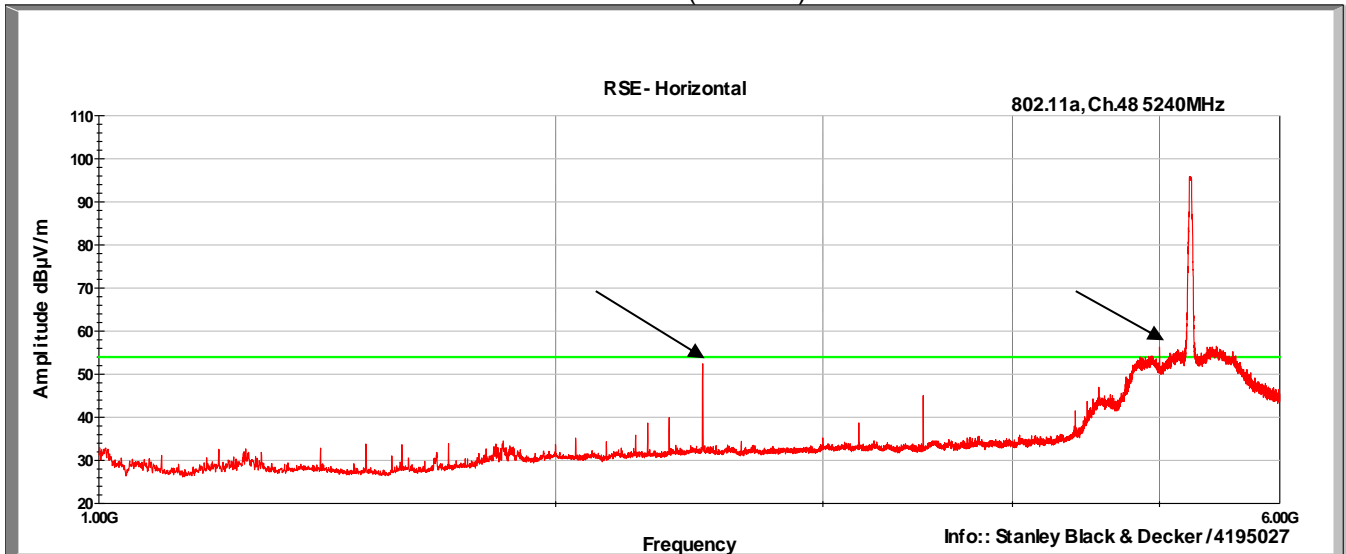

2.5GHz and 5GHz were determined to be digital emissions. These were evaluated under the Subpart B requirements.

Channel 48  
Vertical (6-18GHz)

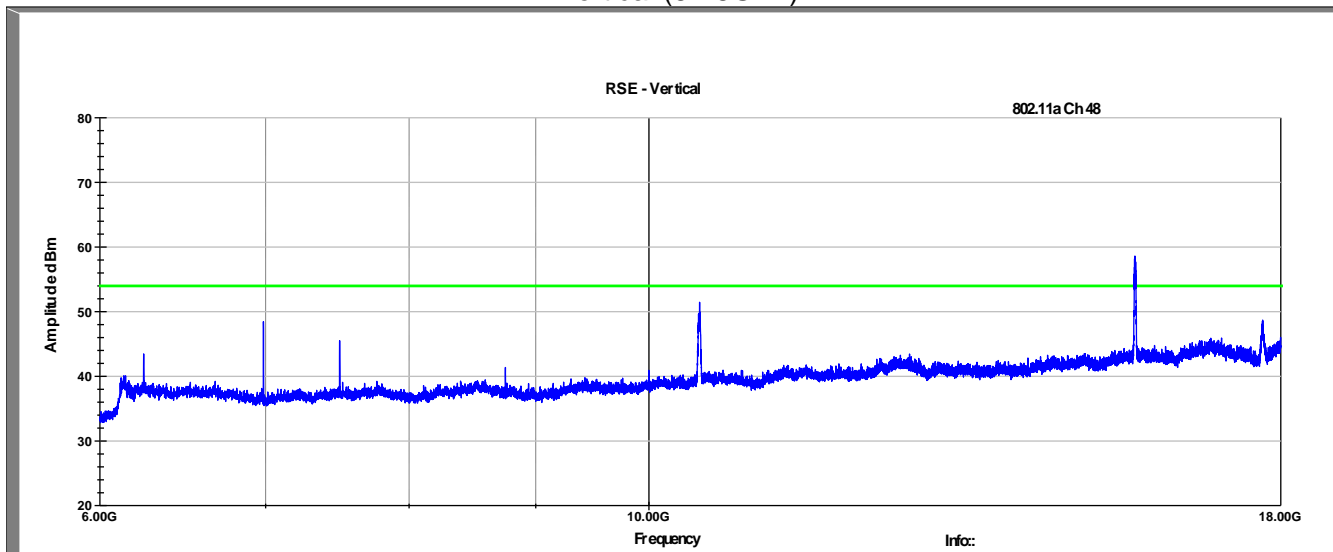

Channel 48  
Horizontal (6-18GHz)

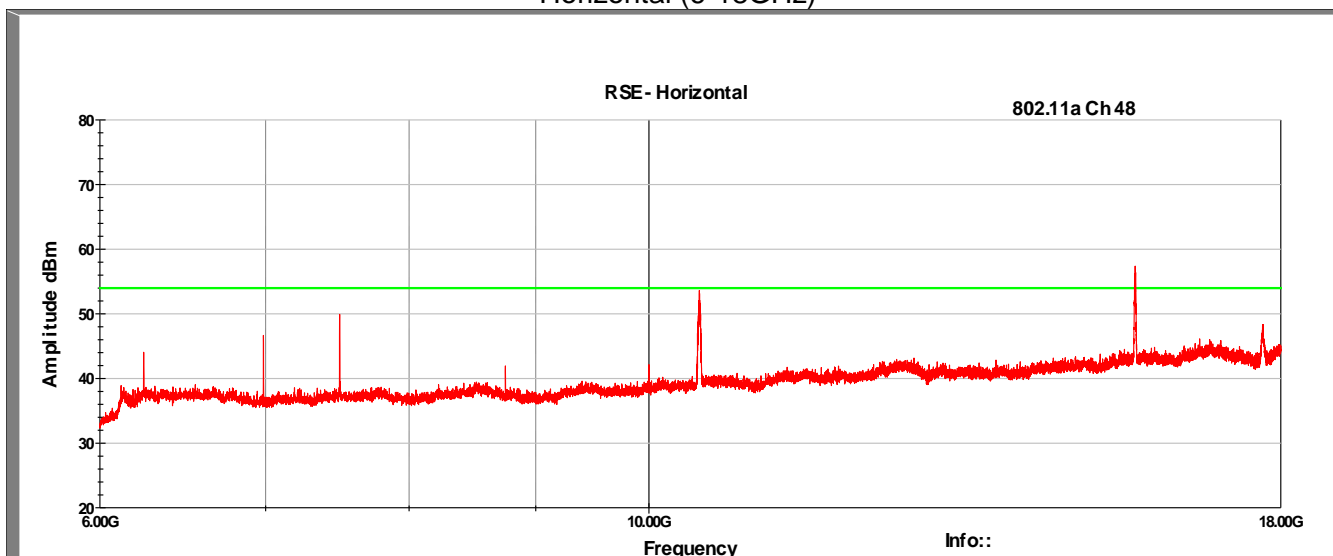

Channel 48  
Vertical (18-40GHz)

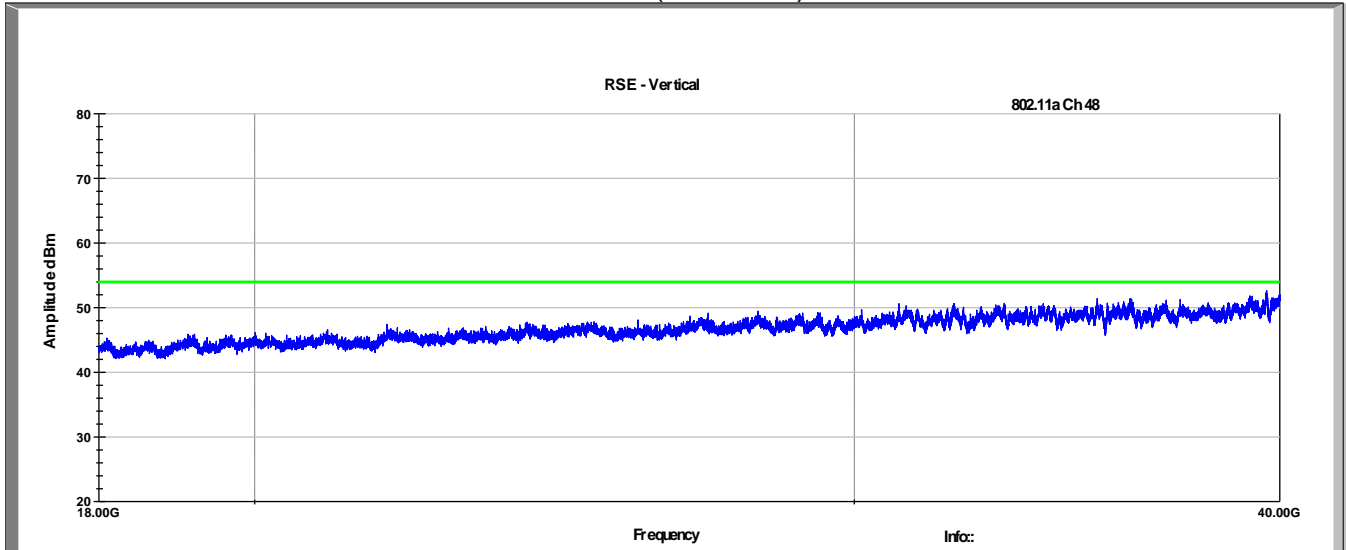

Channel 48  
Horizontal (18-40GHz)

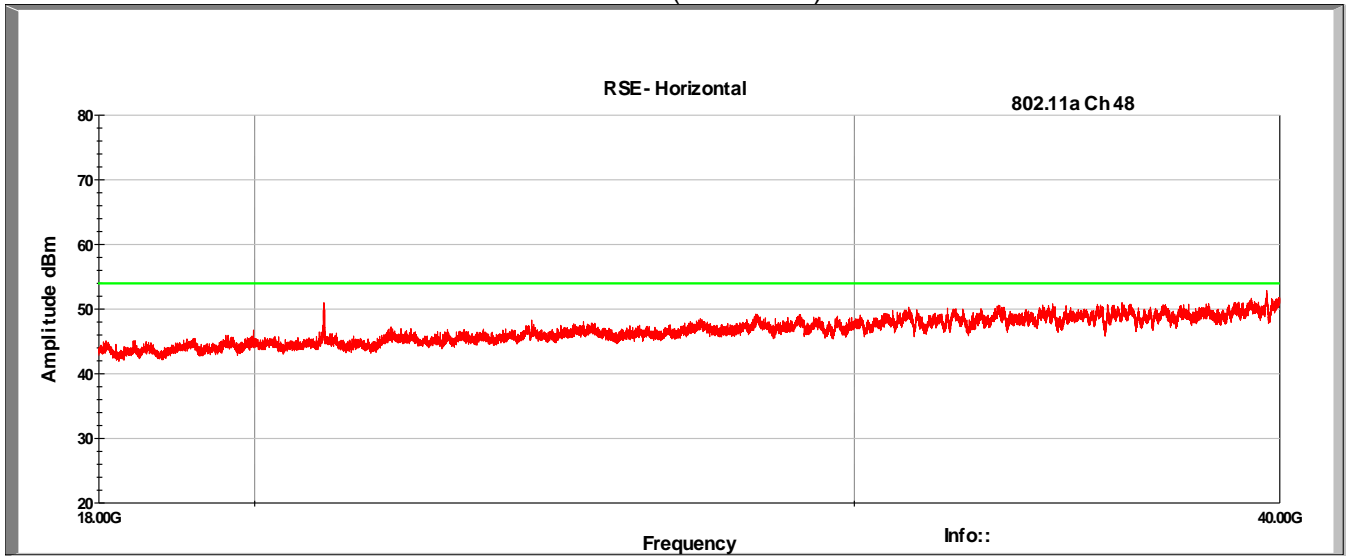

Channel 149  
Vertical (1-6GHz)

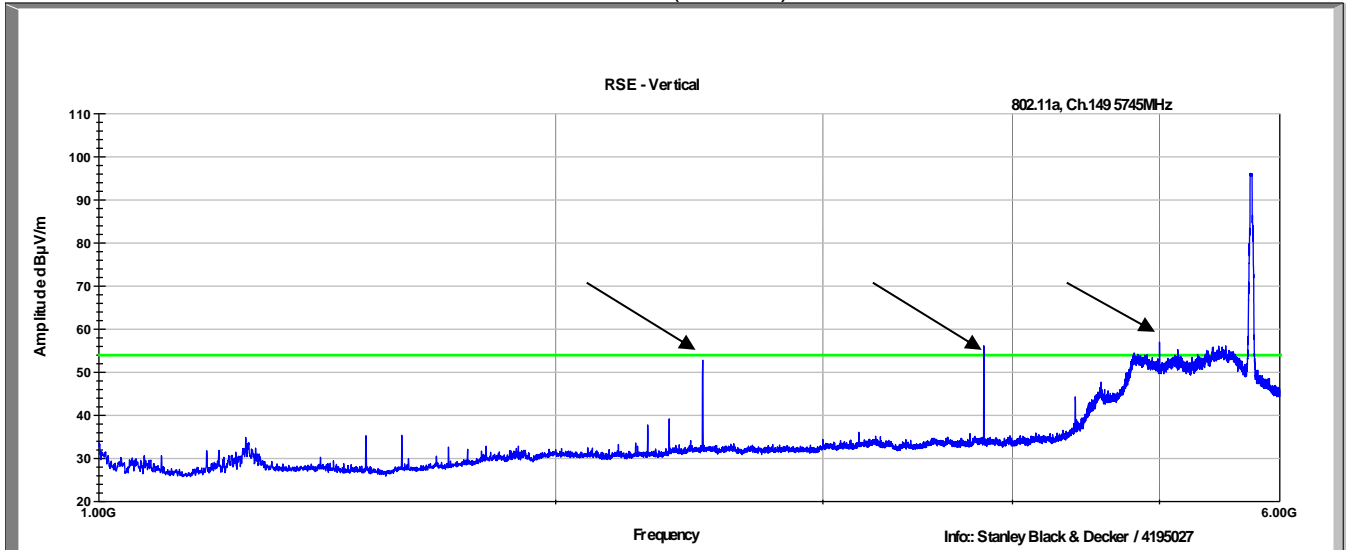

2.5GHz and 5GHz were determined to be digital emissions. These were evaluated under the Subpart B requirements.

Channel 149  
Horizontal (1-6GHz)

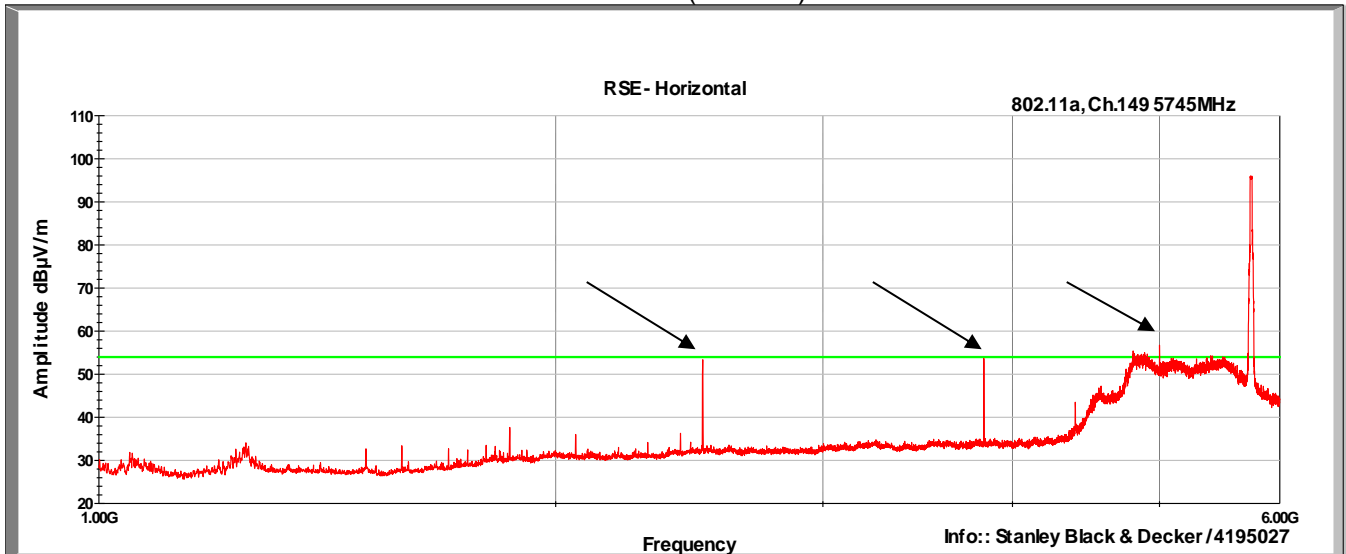

2.5GHz and 5GHz were determined to be digital emissions. These were evaluated under the Subpart B requirements.

Channel 149  
Vertical (6-18GHz)

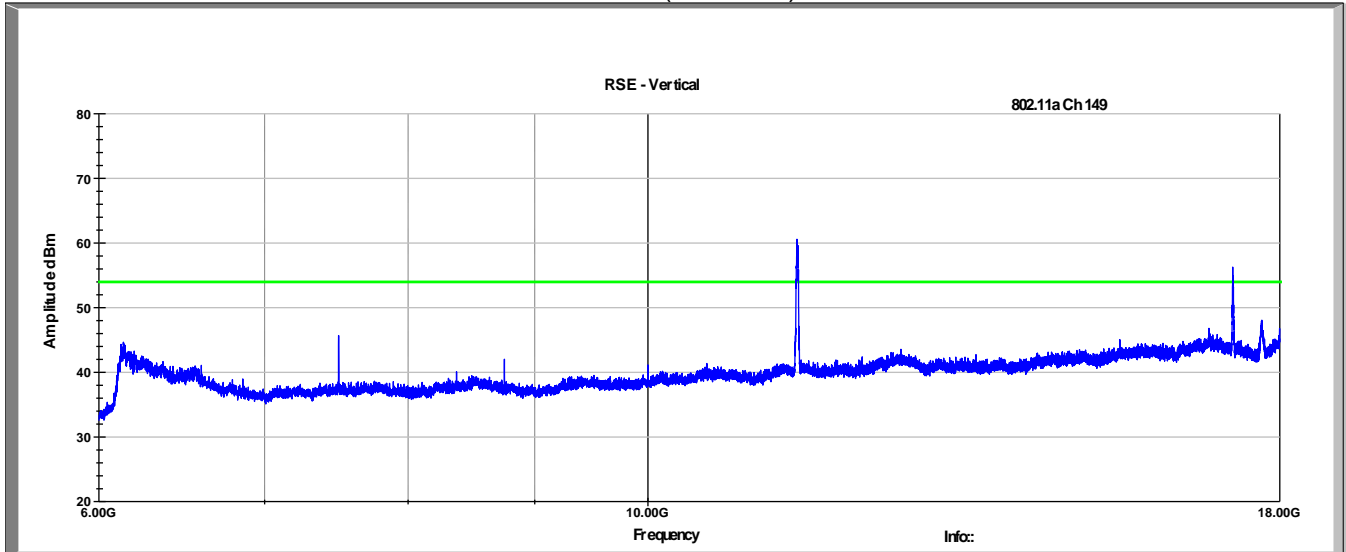

Channel 149  
Horizontal (6-18GHz)

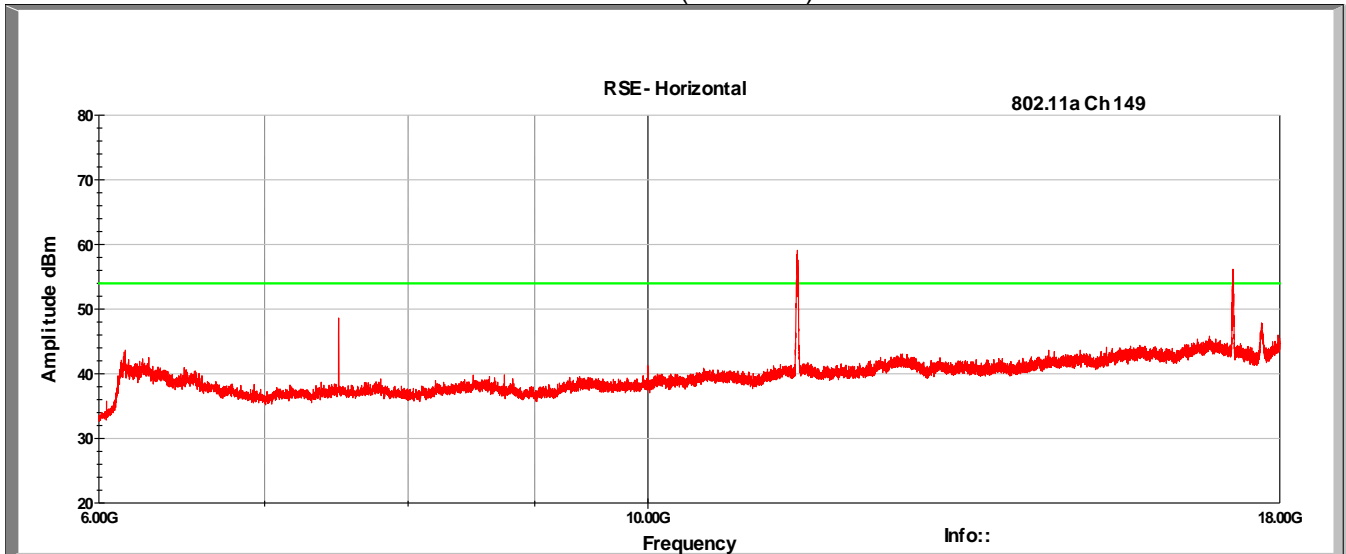



Channel 149  
Vertical (18-40GHz)

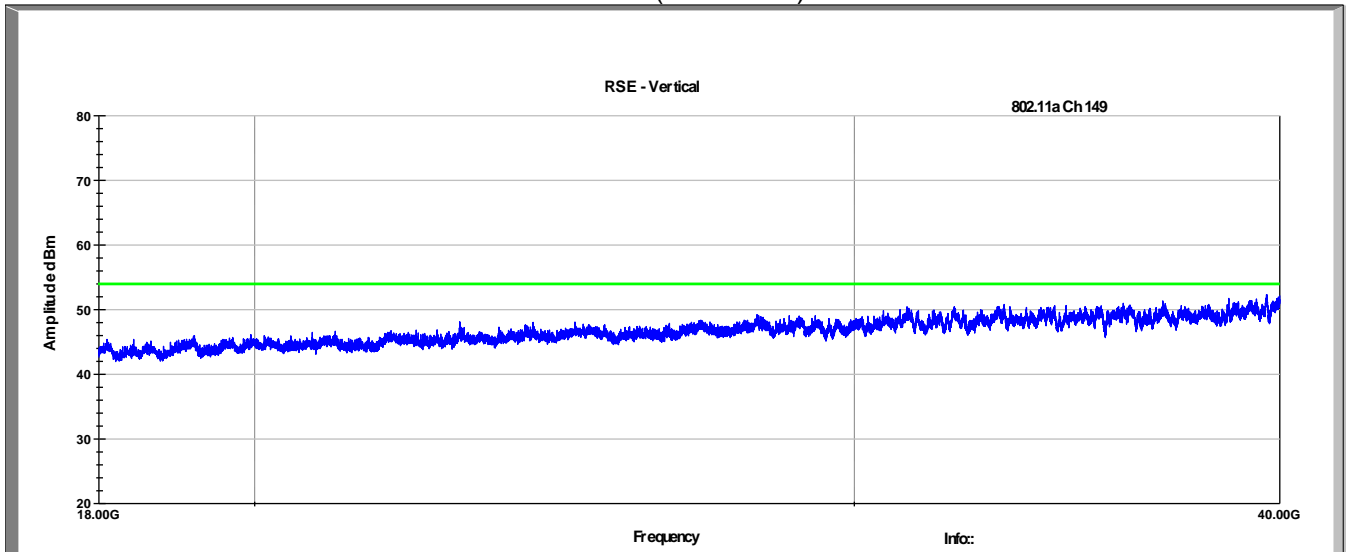

Channel 149  
Horizontal (18-40GHz)

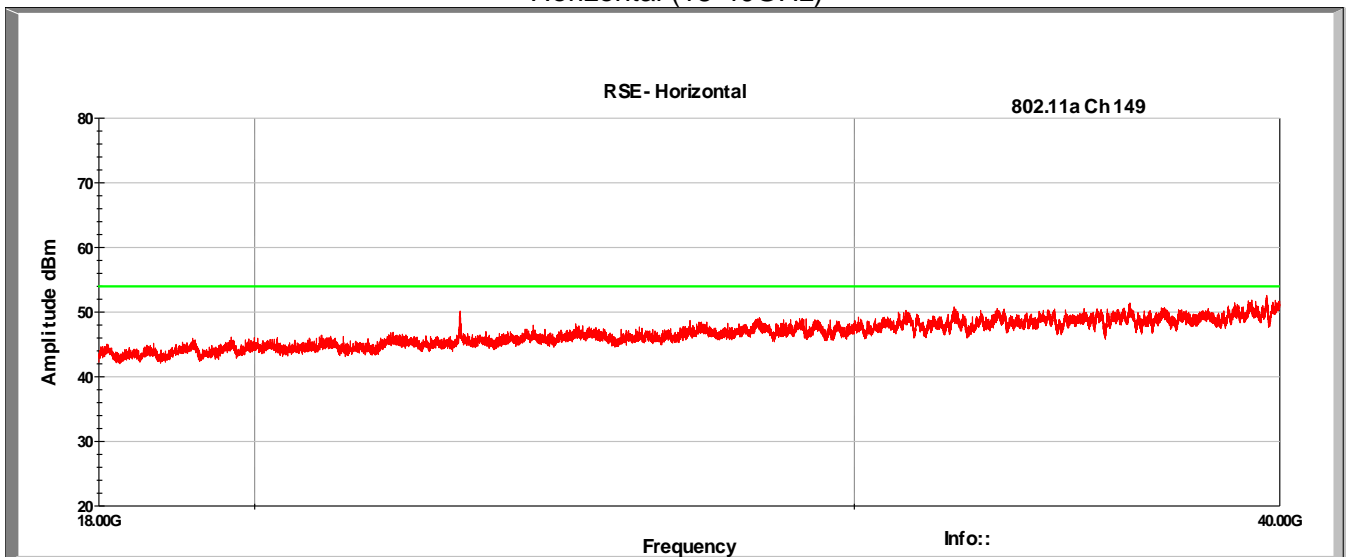

## Channel 157 Vertical (30-1000MHz)

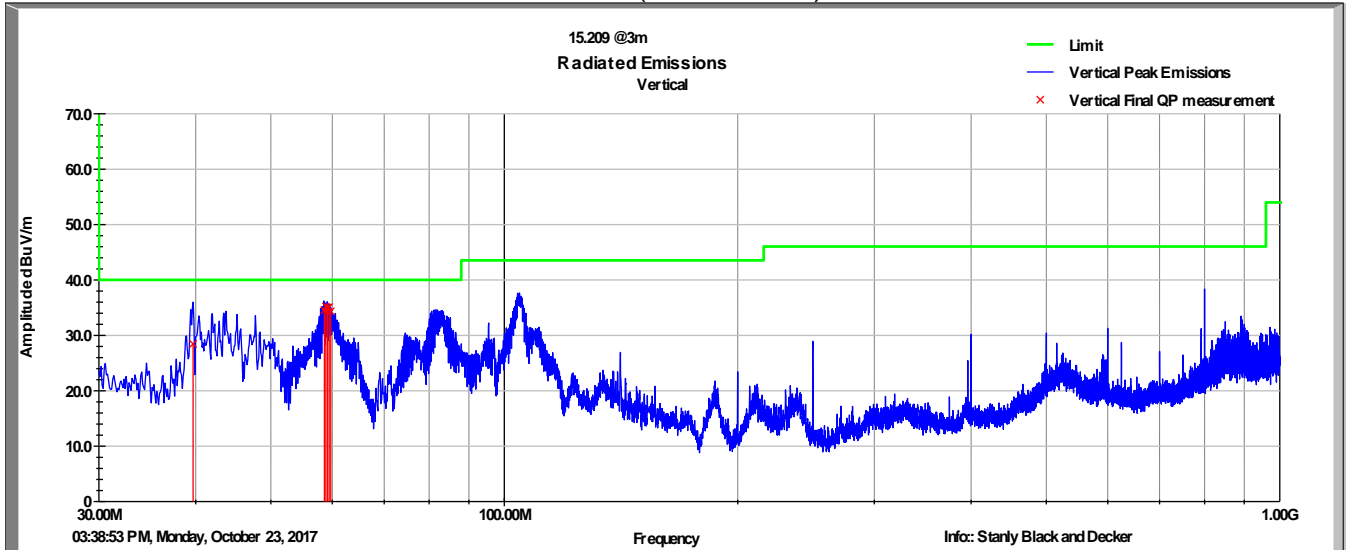

Frequency MHz	Raw QP (dBuV)	Polarity (V/H)	Azimuth (degrees)	Height (cm)	AF (dB/m)	Loss (dB)	Amp (dB)	QP Value (dBuV/m)	Limit (dBuV/m)	Margin (dB)
39.68	45.0	V	309.0	126.0	14.5	0.8	31.8	28.5	40.0	-11.5
58.60	58.8	V	24.0	120.0	7.5	1.1	32.9	34.5	40.0	-5.5
58.88	59.6	V	322.0	175.0	7.5	1.1	32.9	35.2	40.0	-4.8
59.16	59.4	V	320.0	145.0	7.5	1.1	33.0	35.0	40.0	-5.0
59.45	59.5	V	24.0	192.0	7.5	1.1	33.0	35.1	40.0	-4.9
59.73	58.7	V	29.0	184.0	7.5	1.1	33.0	34.3	40.0	-5.7
QP Value = Level + AF + CL - Amp										
Margin = QP Value - Limit										

## Channel 157 Horizontal (30-1000MHz)

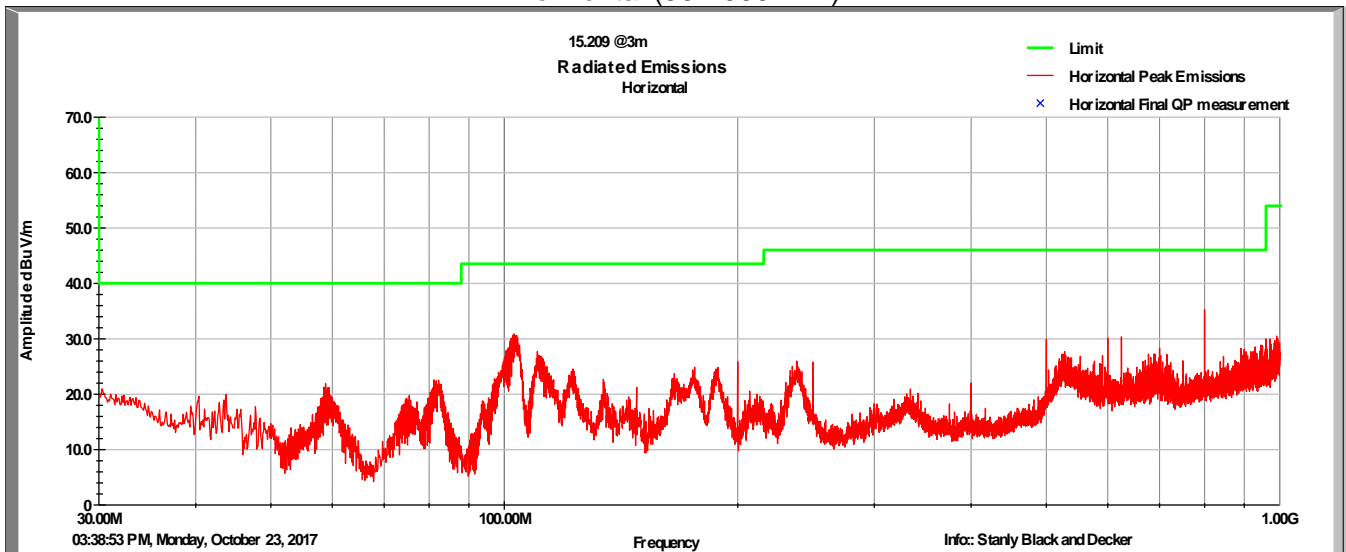

Channel 157  
Vertical (1-6GHz)

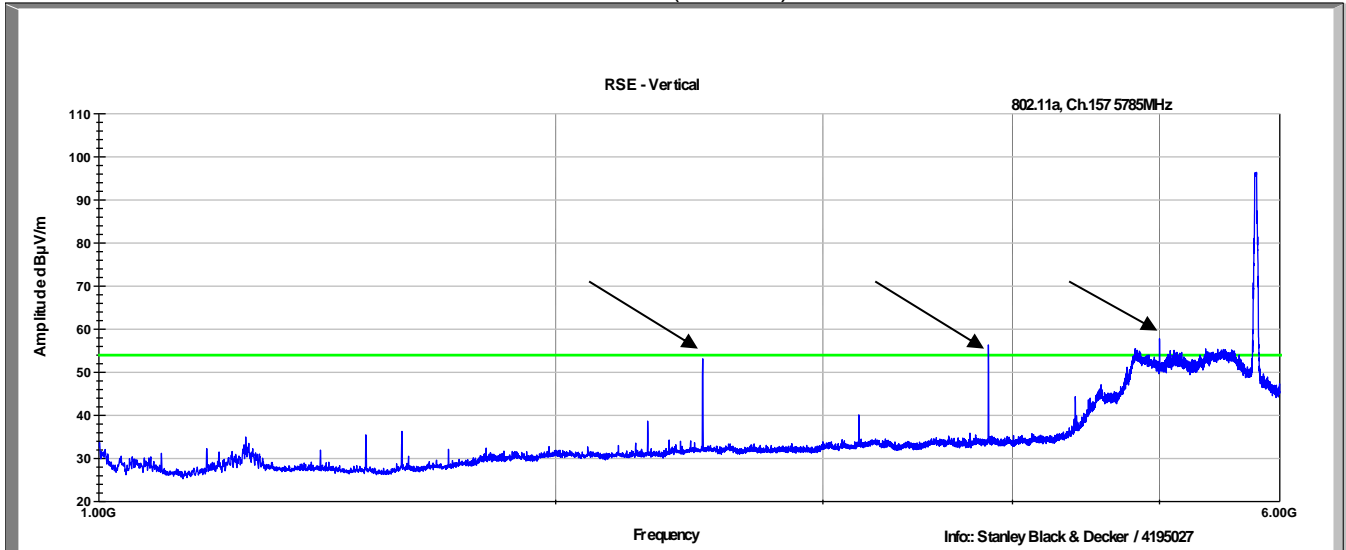

2.5GHz, 3.856GHz, and 5GHz were determined to be digital emissions. These were evaluated under the Subpart B requirements.

Channel 157  
Horizontal (1-6GHz)

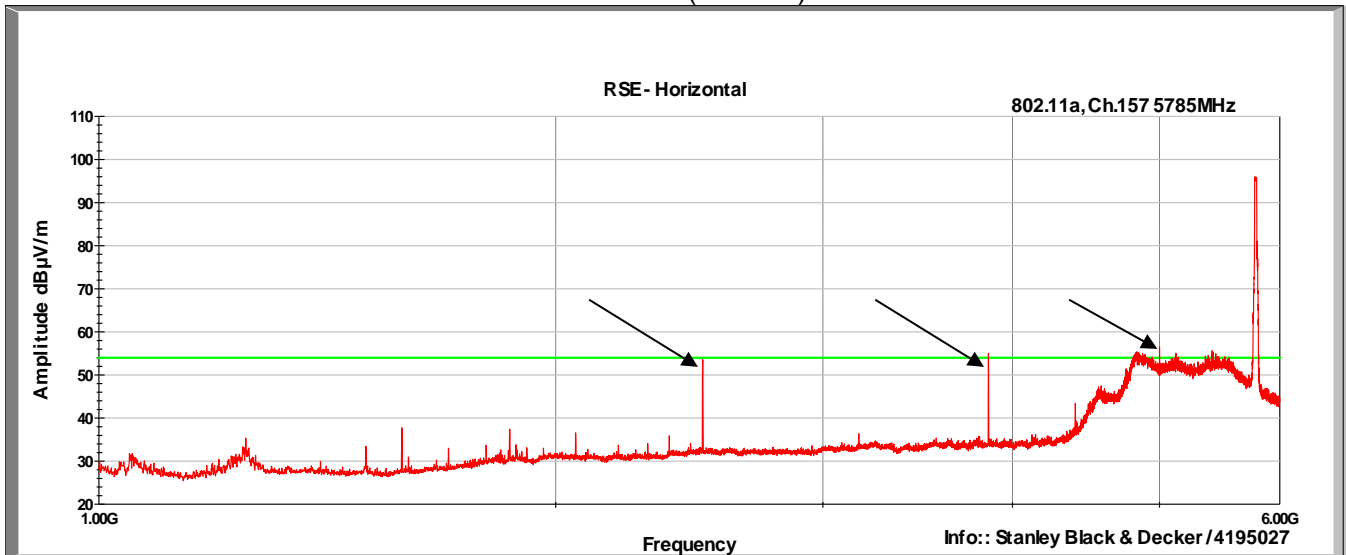

2.5GHz, 3.856GHz, and 5GHz were determined to be digital emissions. These were evaluated under the Subpart B requirements.

Channel 157  
Vertical (6-18GHz)

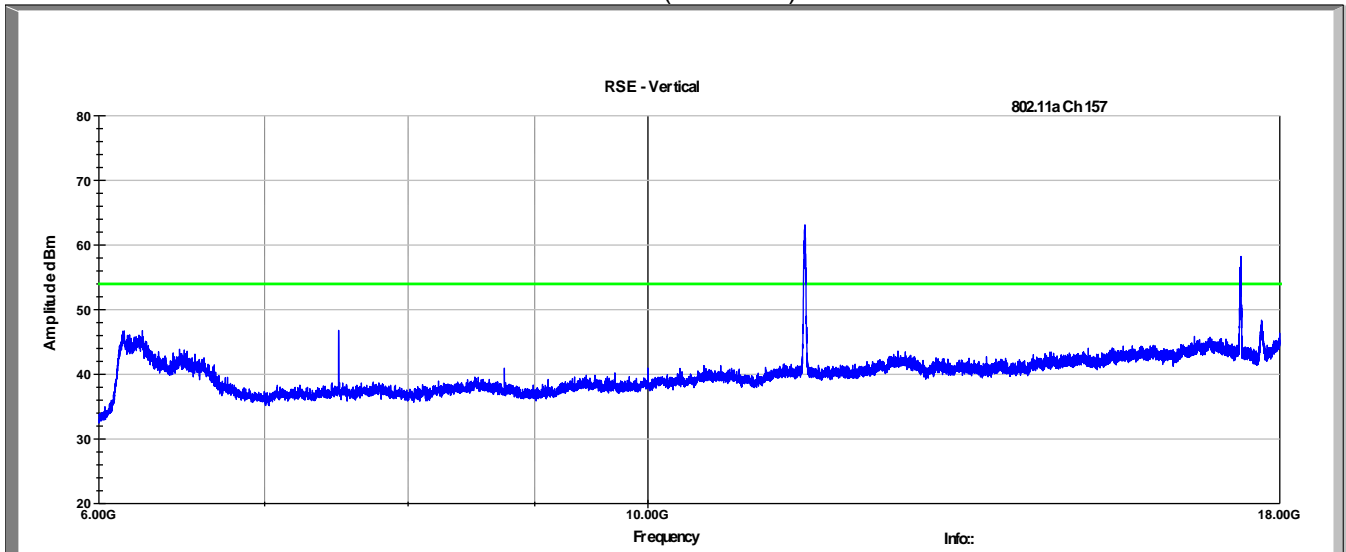

Channel 157  
Horizontal (6-18GHz)

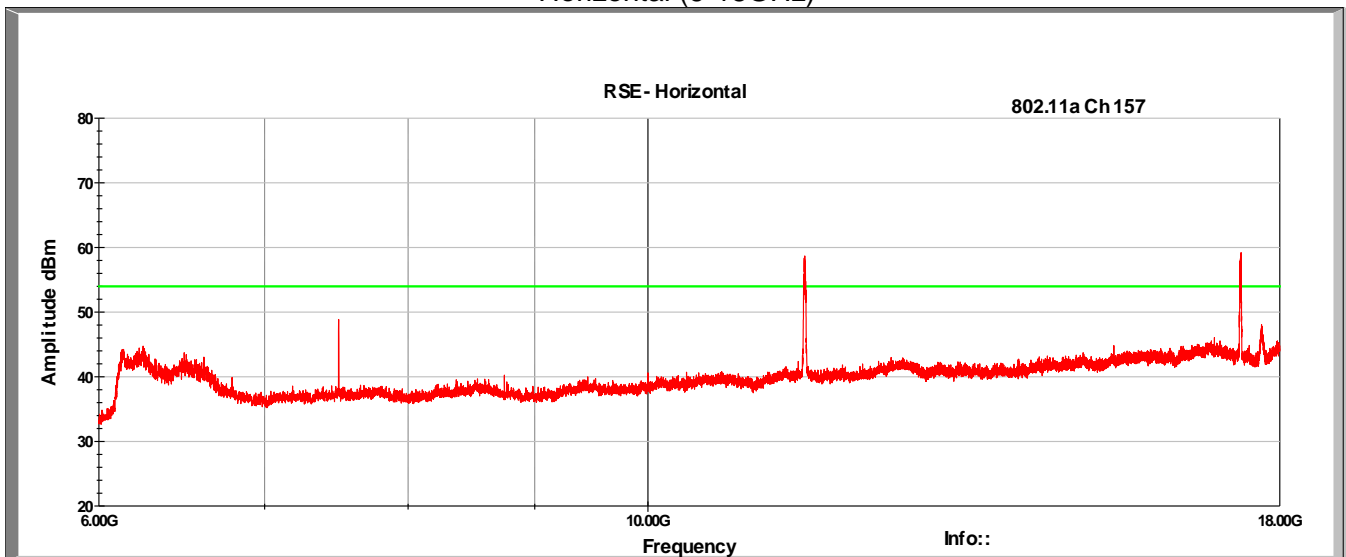

Channel 157  
Vertical (18-40GHz)

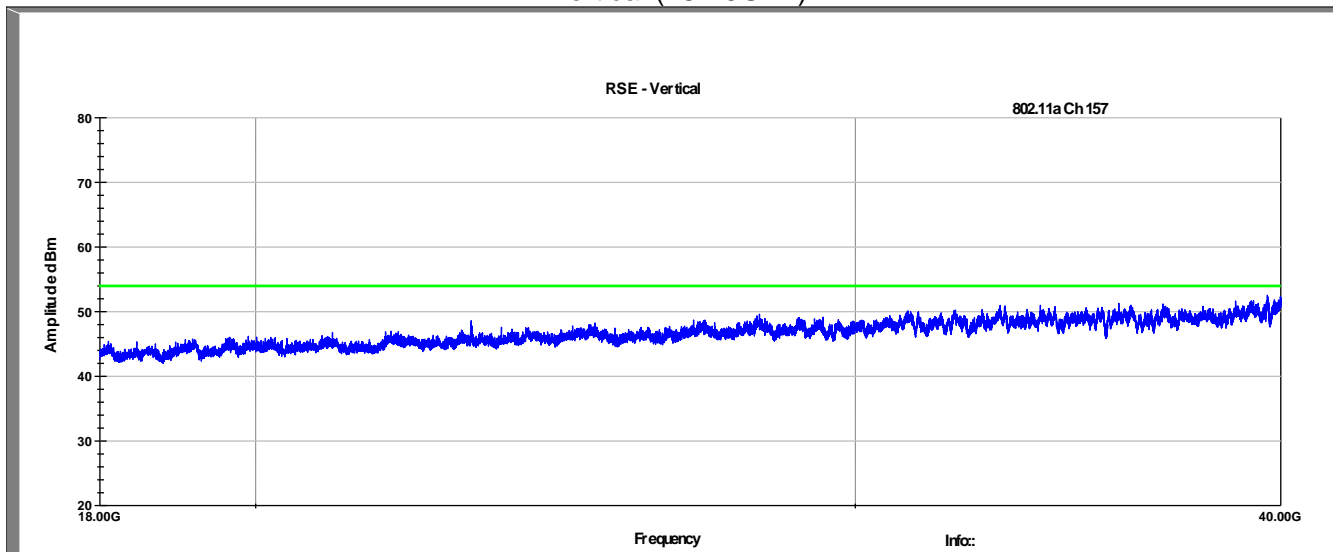

Channel 157  
Horizontal (18-40GHz)

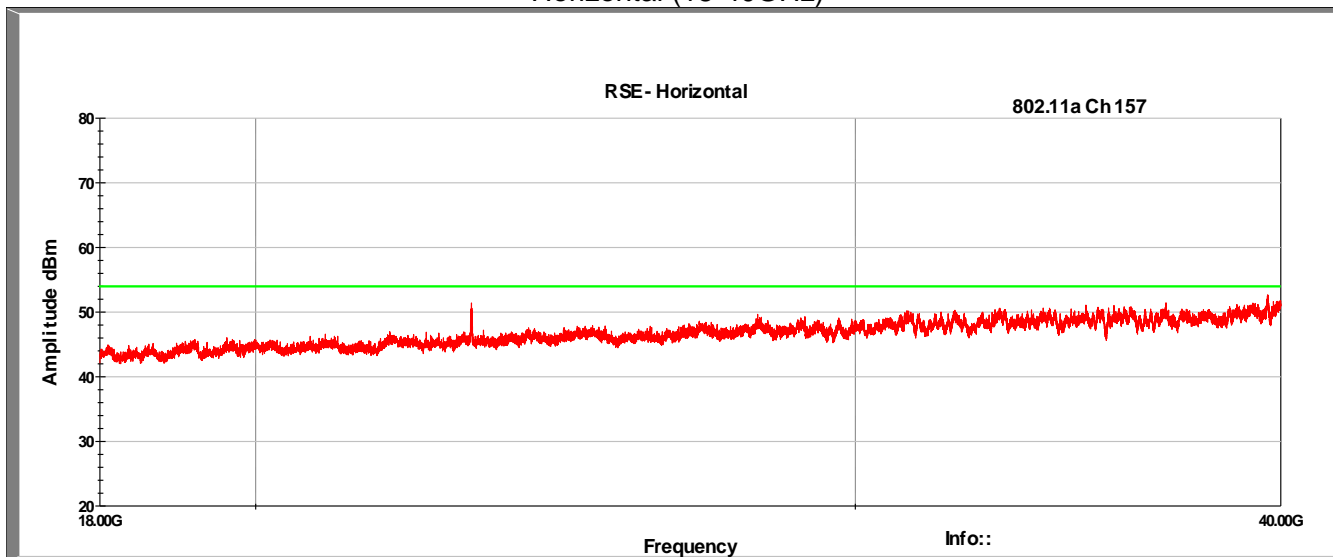

Channel 165  
Vertical (1-6GHz)

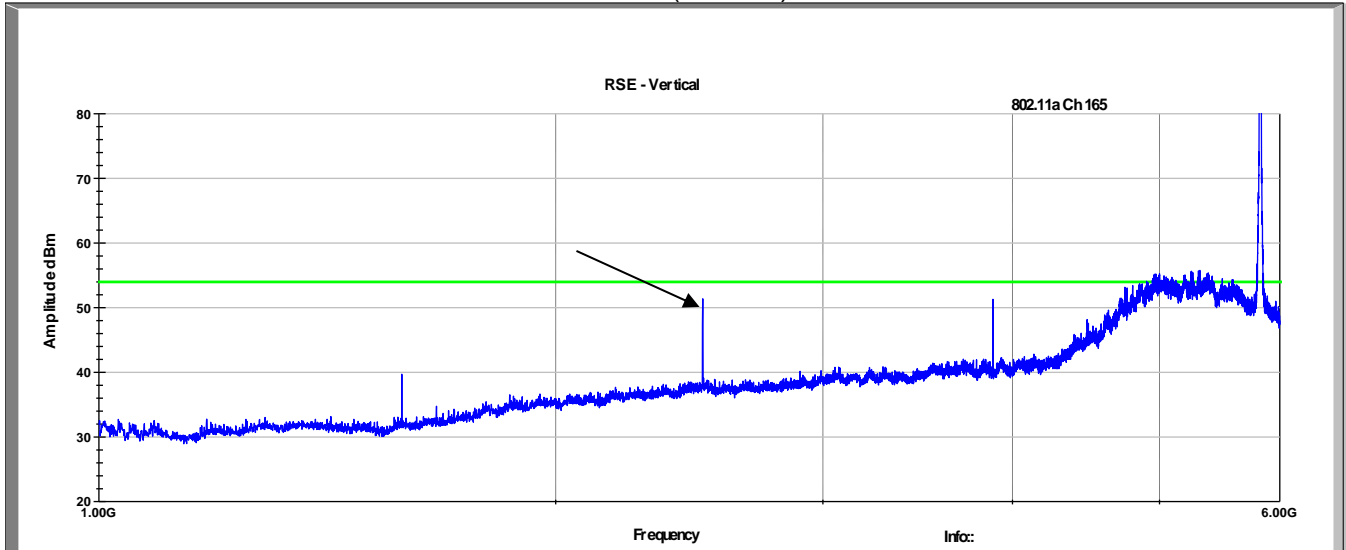

2.5GHz was determined to be a digital emission. This was evaluated under the Subpart B requirements.

Channel 165  
Horizontal (1-6GHz)

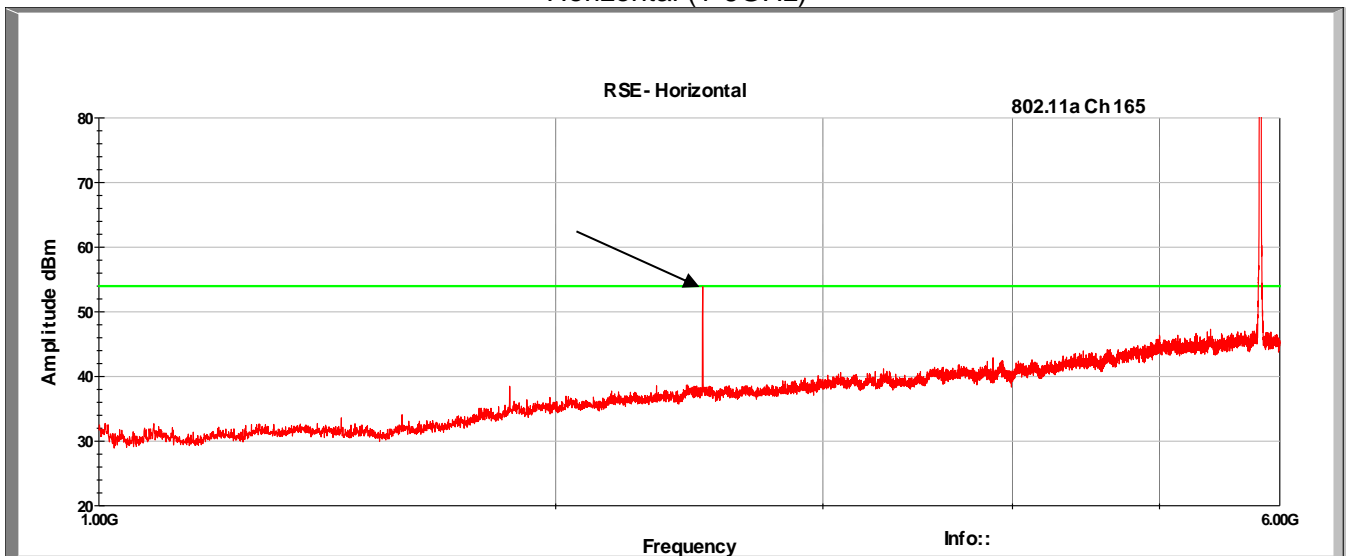

2.5GHz was determined to be a digital emission. This was evaluated under the Subpart B requirements.

Channel 165  
Vertical (6-18GHz)

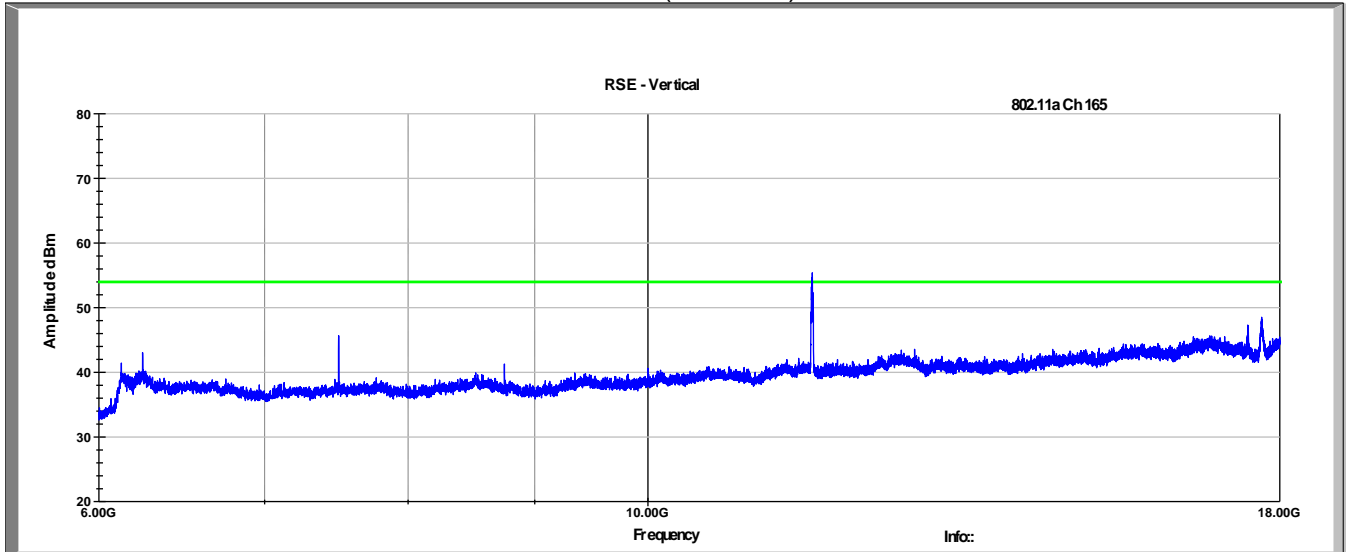

Channel 165  
Horizontal (6-18GHz)

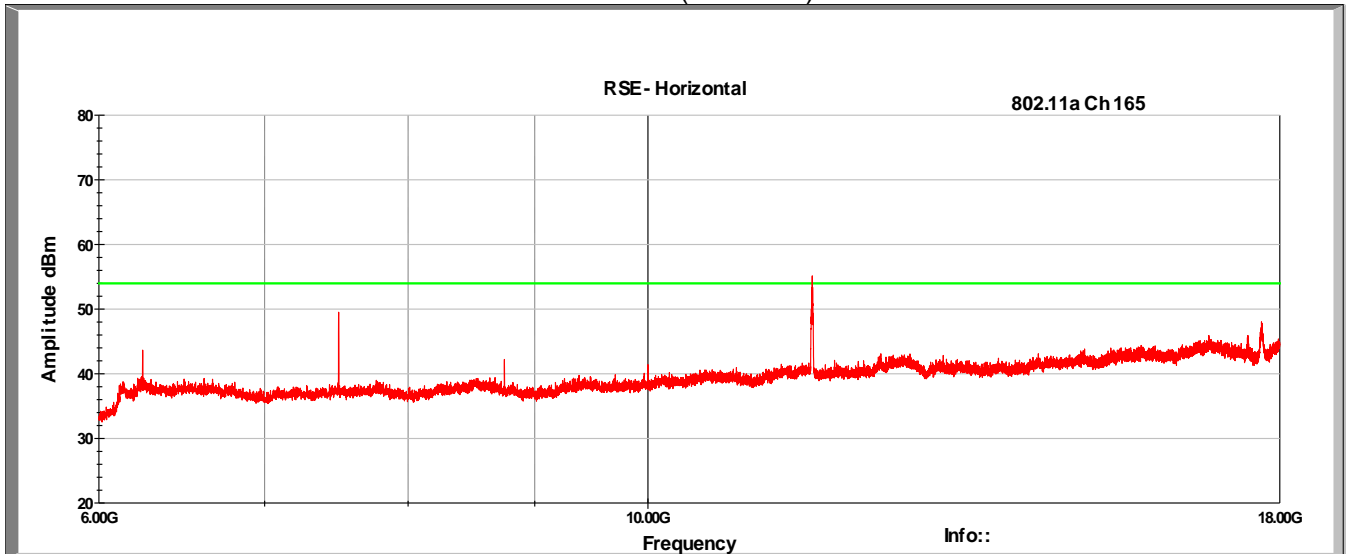

Channel 165  
Vertical (18-40GHz)

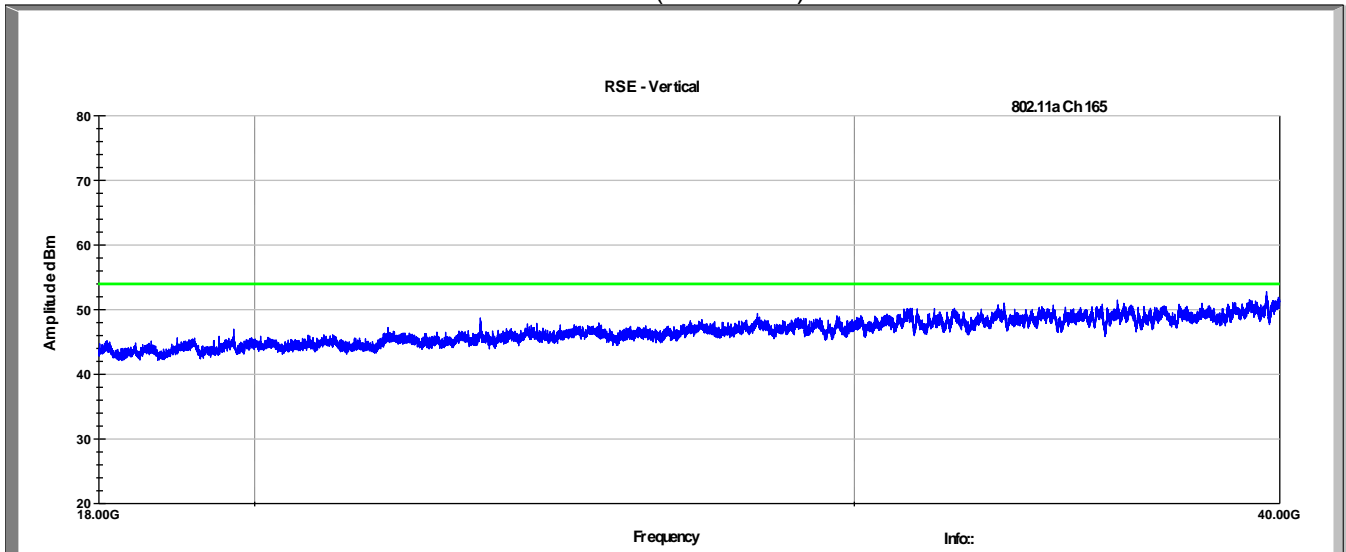

Channel 165  
Horizontal (18-40GHz)

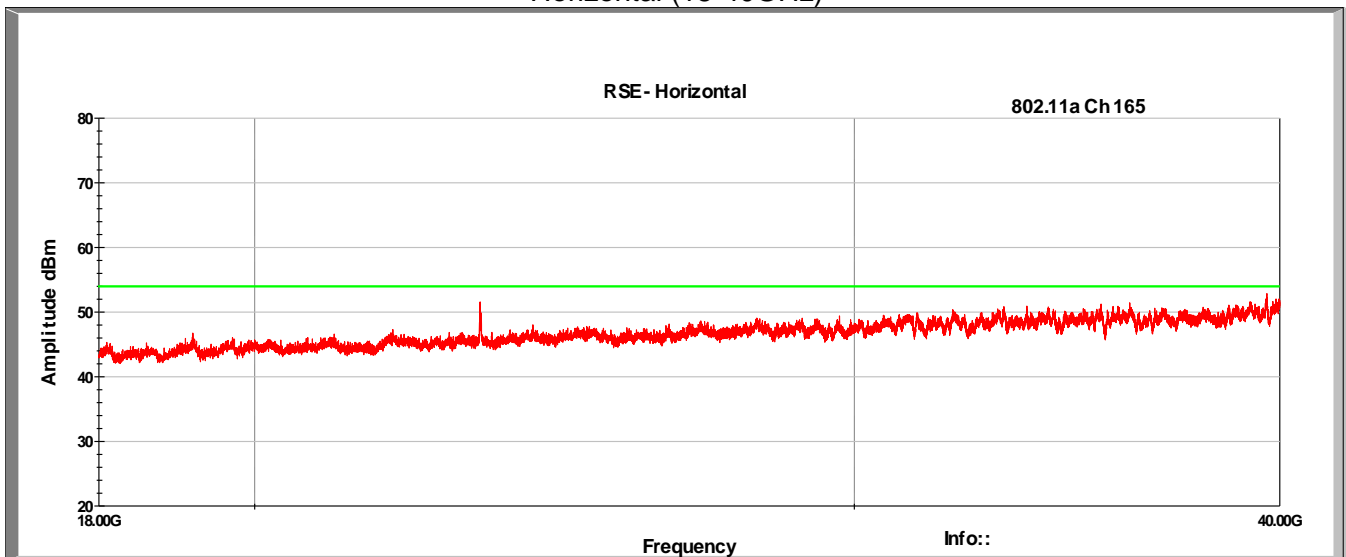



### 6.10 Tabular Data – UNII Band 1

Frequency MHz	Raw Meas (dBuV)	Polarity (V/H)	Correction (dB/m)	Corr Value dBuV/m	Limit (dBuV/m)	Margin (dB)	Detector
Ch. 36							
15540.00	41.3	V	11.4	52.7	74.0	-21.3	Peak
15540.00	29.5	V	11.4	40.9	54.0	-13.1	Average
15540.00	42.6	H	11.4	54.0	74.0	-20.0	Peak
15540.00	30.8	H	11.4	42.2	54.0	-11.8	Average
Ch. 44							
15660.00	47.7	V	11.8	59.5	74.0	-14.5	Peak
15660.00	35.9	V	11.8	47.7	54.0	-6.3	Average
15660.00	45.7	H	11.8	57.5	74.0	-16.5	Peak
15660.00	33.9	H	11.8	45.7	54.0	-8.3	Average
Ch. 48							
15720.00	46.6	V	12.0	58.6	74.0	-15.4	Peak
15720.00	34.8	V	12.0	46.8	54.0	-7.2	Average
15720.00	45.3	H	12.0	57.3	74.0	-16.7	Peak
15720.00	33.5	H	12.0	45.5	54.0	-8.5	Average

Other spurious emissions associated with the transmitter did not fall into restricted bands.

### 6.11 Tabular Data – UNII Band 3

Frequency MHz	Raw Meas (dBuV)	Polarity (V/H)	Correction (dB/m)	Corr Value dBuV/m	Limit (dBuV/m)	Margin (dB)	Detector
Ch. 149							
11490.00	51.4	V	9.2	60.6	74.0	-13.4	Peak
11490.00	39.6	V	9.2	48.8	54.0	-5.2	Average
11490.00	49.9	H	9.2	59.1	74.0	-14.9	Peak
11490.00	38.1	H	9.2	47.3	54.0	-6.7	Average
Ch. 157							
11570.00	53.8	V	9.3	63.1	74.0	-10.9	Peak
11570.00	42.0	V	9.3	51.3	54.0	-2.7	Average
11570.00	49.4	H	9.3	58.7	74.0	-15.3	Peak
11570.00	37.6	H	9.3	46.9	54.0	-7.1	Average
Ch. 165							
11650.00	46.1	V	9.3	55.4	74.0	-18.6	Peak
11650.00	34.3	V	9.3	43.6	54.0	-10.4	Average
11650.00	45.8	H	9.3	55.1	74.0	-18.9	Peak
11650.00	34.0	H	9.3	43.3	54.0	-10.7	Average

Other spurious emissions associated with the transmitter did not fall into restricted bands.

## 7 Frequency Stability

### 7.1 Test Result

Test Description	Test Specification	Test Result
Frequency Stability	15.407(g)	Compliant

### 7.2 Test Method

Frequency stability was measured over the temperature range defined in the user's manual: -4°F to 122°F (-20°C to 50°C). Frequency deviations were measured with a CMW500.

#### Limit:

Manufacturers of U-NII devices are responsible for ensuring frequency stability such that an emission is maintained within the band of operation under all conditions of normal operation as specified in the user's manual. The measured frequency deviations were applied to the worst-case occupied bandwidth to show that the entire 99% OBW will remain inside the authorized bands.

### 7.3 Test Site

SGS EMC Laboratory, Suwanee, GA

#### Environmental Conditions

Temperature: 22.5°C  
Relative Humidity: 52.7 %

### 7.4 Test Equipment

Test End Date: 2-Nov-2017

Tester: JOP

Equipment	Model	Manufacturer	Asset Number	Cal Due Date
WIDEBAND RADIO COMMUNICATION TESTER	CMW500	ROHDE & SCHWARZ	B079788	24-Oct-2020
RF CABLE	141	HUBER & SUHNER	B095585	26-Jul-2018

Note: The equipment calibration period is 1 year except for the CMW500 which is on a 3-year cycle.

### 7.5 Test Data

Channel	99% OBW (MHz)	Center Frequency (MHz)	Band Edge (MHz)	Worst-case Deviation (MHz)	Remains within the band?
36.00	16.55	5180.00	5150.00	-0.030261	Yes
48.00	16.47	5240.00	5250.00	0.018708	Yes
149.00	16.54	5745.00	5725.00	-0.034479	Yes
165.00	16.52	5825.00	5850.00	0.024047	Yes
38.00	36.23	5190.00	5150.00	-0.031481	Yes
46.00	36.13	5230.00	5250.00	0.020562	Yes
151.00	36.13	5755.00	5725.00	-0.035798	Yes
159.00	36.18	5795.00	5850.00	0.023845	Yes

## 8 Conducted Emissions

### 8.1 Test Result

Test Description	Basic Standards	Test Result
Conducted Emissions, Class B	ANSI C63.4:2014 RSS-GEN	Compliant

### 8.2 Test Method

With the receiver's resolution bandwidth was set to 9 kHz the initial preliminary exploratory scans were performed over the measuring frequency range (0.15MHz to 30MHz) using a max hold mode incorporating a Peak detector and Average detector and using the TILE! software. The final test data was measured using a Quasi-Peak detector and Average detector and compared against the limits indicated in the table below.

Frequency Range	Class A Limits (dBuV)	Class B Limits (dBuV) CISPR
0.15 to 0.5 MHz	Avg 66 QP 79	Avg 56 to 46 QP 66 to 56
0.5 to 5 MHz	Avg 60 QP 73	Avg 46 Pk 56
5 to 30 MHz	Avg 60 QP 73	Avg 50 Pk 60

### 8.3 Test Site

SGS EMC Laboratory, Suwanee, GA

Environmental Conditions

Temperature: 24.6°C

Relative Humidity: 55.3%

### 8.4 Test Equipment

Test End Date: 21-Sep-2017

Tester: FN

Equipment	Model	Manufacturer	Asset Number	Cal Due Date
EMI TEST RECEIVER	ESU8	ROHDE & SCHWARZ	B085759	25-Jul-2018
LINE IMPEDANCE STABILIZATION NETWORK	NNB 51	TESEQ	B085882	1-Nov-2017
RF CABLE	UC-N-MM-78	MAURY MICROWAVE	17016	25-Jul-2018

Note: The equipment calibration period is 1 year.

Software:

"Conducted Emissions" TILE! profile dated Dec 2015

### 8.5 Test Data

Line 1 Conducted Emissions Plot 150-30MHz

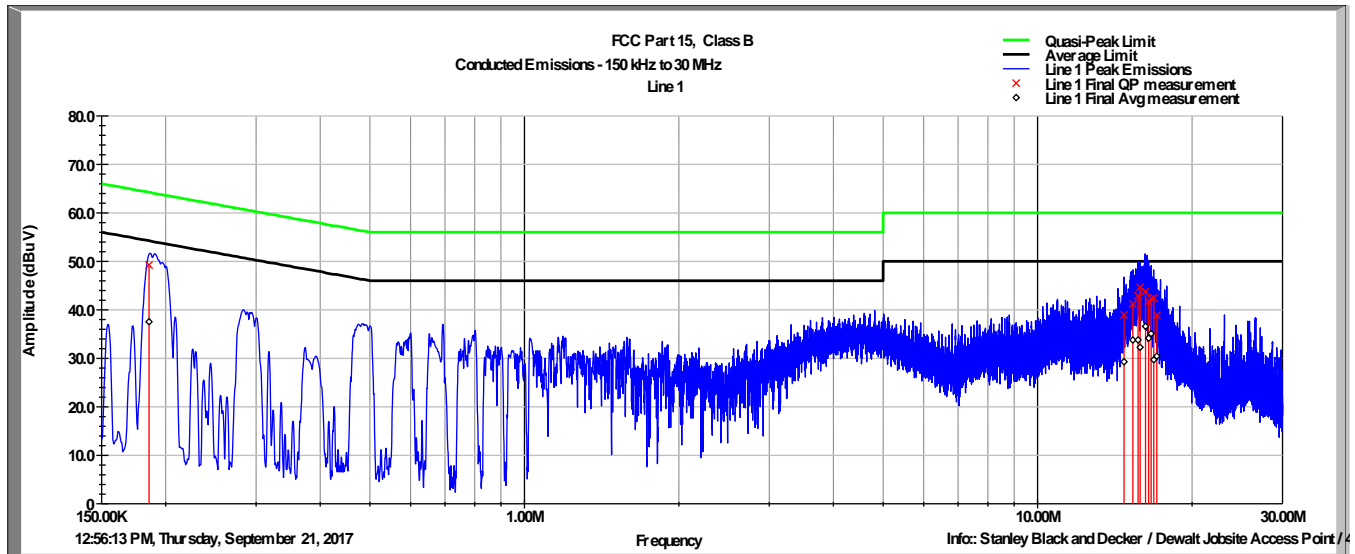

Line 1 Conducted Emissions Data 150-30MHz

Frequency MHz	QP Value dBuV	QP Limit dBuV	QP Margin dB	Avg Value dBuV	Avg Limit dBuV	Avg Margin dB
0.186	49.2	64.3	-15.0	37.5	54.3	-16.7
14.737	39.0	60.0	-21.0	29.3	50.0	-20.7
15.328	41.2	60.0	-18.8	33.8	50.0	-16.2
15.695	42.9	60.0	-17.1	33.8	50.0	-16.2
15.840	44.6	60.0	-15.4	32.3	50.0	-17.7
16.230	43.8	60.0	-16.2	36.6	50.0	-13.4
16.457	41.7	60.0	-18.3	34.2	50.0	-15.8
16.639	42.3	60.0	-17.7	35.1	50.0	-14.9
16.845	42.4	60.0	-17.6	29.7	50.0	-20.3
17.069	38.9	60.0	-21.1	30.4	50.0	-19.6

### Neutral Conducted Emissions Plot 150-30MHz

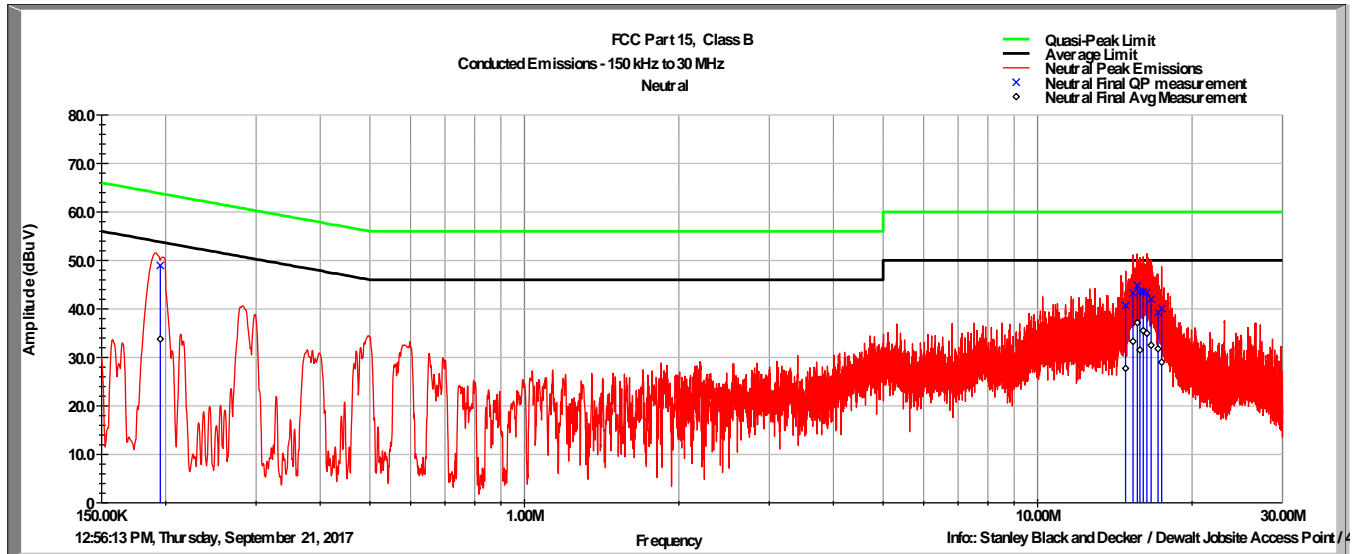

### Neutral Conducted Emissions Data 150-30MHz

Frequency MHz	QP Value dBuV	QP Limit dBuV	QP Margin dB	Avg Value dBuV	Avg Limit dBuV	Avg Margin dB
0.195	49.0	63.8	-14.8	33.8	53.8	-20.0
14.843	40.7	60.0	-19.3	27.7	50.0	-22.3
15.343	43.3	60.0	-16.7	33.3	50.0	-16.7
15.644	44.8	60.0	-15.2	37.2	50.0	-12.8
15.827	43.6	60.0	-16.4	31.5	50.0	-18.5
16.068	43.5	60.0	-16.5	35.5	50.0	-14.5
16.331	43.4	60.0	-16.6	35.0	50.0	-15.0
16.640	42.0	60.0	-18.0	32.5	50.0	-17.5
17.165	39.3	60.0	-20.7	31.8	50.0	-18.2
17.452	40.1	60.0	-19.9	29.0	50.0	-21.0

## 9 Revision History

Revision Level	Description of changes	Revision Date
0	Initial release	31 October 2017
1	<ul style="list-style-type: none"> <li>- Reduced output power and provided updated power measurements for UNII Band 1 (page 13).</li> <li>- Updated sample information to include new DUT</li> </ul>	05 April 2018