

# DEWALT®

**User Guide**  
**D'utilisation**  
**Manual de instrucciones**

**DCT100**

**DeWALT WiFi Access Point (ENG)**

**Name of Tool (FR)**

**Name of Tool (SP)**

**[www.DEWALT.com](http://www.DEWALT.com)**

**If you have questions or comments, contact us.**  
**Pour toute question ou tout commentaire, nous contacter.**  
**Si tiene dudas o comentarios, contáctenos.**

**1-800-4-DEWALT**

English ( <i>original instructions</i> )	1
Français ( <i>traduction de la notice d'instructions originale</i> )	?
Español ( <i>traducido de las instrucciones originales</i> )	?

## SAVE ALL WARNINGS AND INSTRUCTIONS FOR FUTURE REFERENCE

Refer to **Regulatory Notices** and **Safety Information**.

## CONSERVER TOUS LES AVERTISSEMENTS ET TOUTES LES DIRECTIVES POUR UN USAGE ULTÉRIEUR

Refer to **Regulatory Notices** and **Safety Information**.

## CONSERVE TODAS LAS ADVERTENCIAS E INSTRUCCIONES PARA FUTURAS CONSULTAS

Refer to **Regulatory Notices** and **Safety Information**.



**WARNING!** Read all safety warnings and all instructions. Failure to follow the warnings and instructions may result in electric shock, fire and/or serious injury.



**WARNING:** To reduce the risk of injury, read the instruction manual.

If you have any questions or comments about this or any DEWALT tool, call us toll free at:

1-800-4-DEWALT  
(1-800-433-9258).



**AVERTISSEMENT!** lire tous les avertissements de sécurité et toutes les directives. Le non-respect des avertissements et des directives pourrait se solder par un choc électrique, un incendie et/ou une blessure grave.



**AVERTISSEMENT :** afin de réduire le risque de blessures, lire le mode d'emploi de l'outil.

Pour toute question ou remarque au sujet de cet outil ou de tout autre outil DEWALT, composez le numéro sans frais: 1-800-4-DEWALT (1-800-433-9258).



**¡ADVERTENCIA!** Lea todas las advertencias de seguridad e instrucciones. El incumplimiento de las advertencias e instrucciones puede provocar descargas eléctricas, incendios o lesiones graves.



**ADVERTENCIA:** Para reducir el riesgo de lesiones, lea el manual de instrucciones.

Si tiene alguna duda o algún comentario sobre ésta u otra herramienta DEWALT, llámenos al número gratuito: 1-800-4-DEWALT (1-800-433-9258).

## Definitions: Safety Alert Symbols and Words

This instruction manual uses the following safety alert symbols and words to alert you to hazardous situations and your risk of personal injury or property damage.



**DANGER:** Indicates an imminently hazardous situation which, if not avoided, **will** result in **death or serious injury**.



**WARNING:** Indicates a potentially hazardous situation which, if not avoided, **could** result in **death or serious injury**.



**CAUTION:** Indicates a potentially hazardous situation which, if not avoided, **may** result in **minor or moderate injury**.



(Used without word) Indicates a safety related message.

**NOTICE:** Indicates a practice **not related to personal injury** which, if not avoided, **may** result in **property damage**.

## Welcome

Welcome to DEWALT Jobsite WiFi system! This manual will be your guide for setup, usage, safety and specifications of your system. DEWALT Jobsite WiFi System is a dual-band, enterprise class, ruggedized mesh WiFi system designed to provide seamless coverage throughout your jobsite or other demanding environment. Let's get started!

## Getting Started



1. Go to **wifi.dewalt.com** using your computer or mobile device to get started with the app.

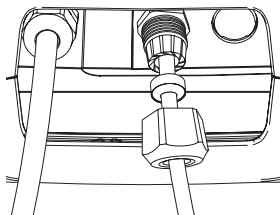

120V AC

Ethernet

2. Power up your first DEWALT Jobsite WiFi Access Point and plug it into the modem (wired internet connection), using the Ethernet weather seal.



3. Configure your WiFi using the DEWALT WiFi app.

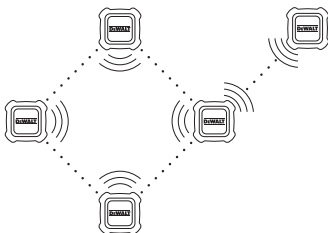

4. Follow the in-app instructions to add more DEWALT WiFi Access Points.

# Getting to Know DeWalt Jobsite WiFi System

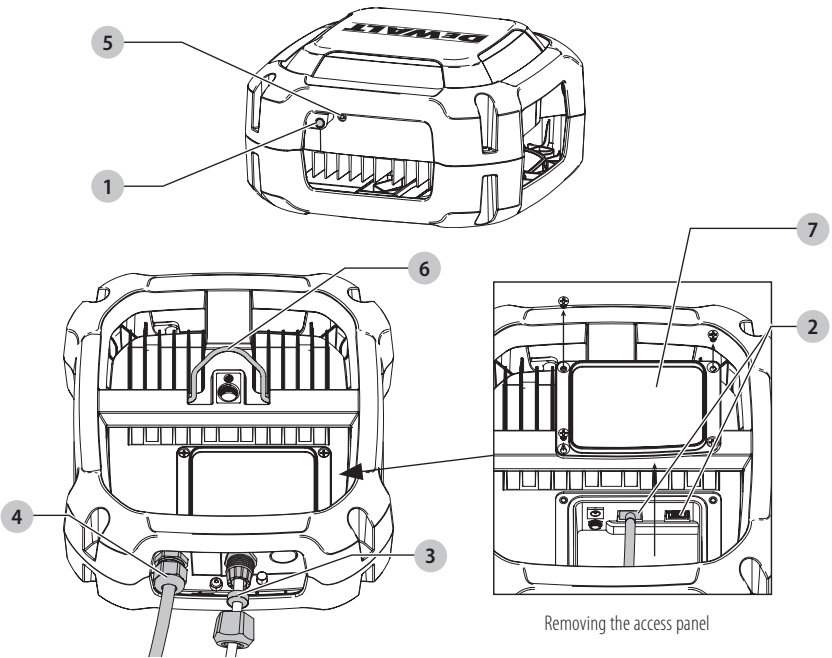

## Package Contents

- 1 DEWALT WiFi Access Point
- 2 Ethernet weather seal
- 1 User guide

## Technical Specifications

		DCT100
Power	V <sub>AC</sub>	120
Channel/Frequency	GHz	2.4 / 5
Operating temperature	°F(°C)	-4°(-20°) to 122°(50°)
Access point coverage (single unit)	sq/ft	10,000*
	sq/m	929*

\*Estimated coverage based on performance testing on typical jobsites. Actual performance may vary based on range or interference.



**CAUTION!** Improperly resealing the access panel will void the unit's IP rating.

## Access Point Features

- 1 LED light: Indicates unit's status and connectivity

Color	Pattern	Meaning
White	(Blinking then Solid)	Starting up.
Blue	(Solid)	Online and ready to be configured.
Green	(Solid)	Connected to mesh network.
Green	(Blinking)	Connected to a network but the connection is not stable (range, interference, etc.)
Red	(Blinking)	Hardware issue with the unit

- 2 Ethernet port: Two Gigabit RJ45 ports for connecting the primary access point to the internet and optional backhaul
- 3 Ethernet cable weather seal
- 4 Power port: Requires 120V AC power
- 5 Factory reset button: Resets unit to factory configuration when held for 20 seconds
- 6 Mounting: Ring for carabiner/hook or UNC-2B 1/4"-20 and 5/8"-11 threaded insert for tripod or bracket mounting
- 7 Access panel door: Protects cord ports from weather/dust (secured by crosshead screws [x4])

## Installation Recommendations

1. Offset (minimum 10 ft) from pillars or obstructions such as walls and large columns.

2. Install 1 unit per floor or every 200 ft.

3. Use line of sight, whenever possible.

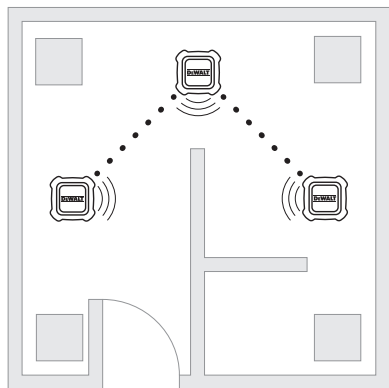
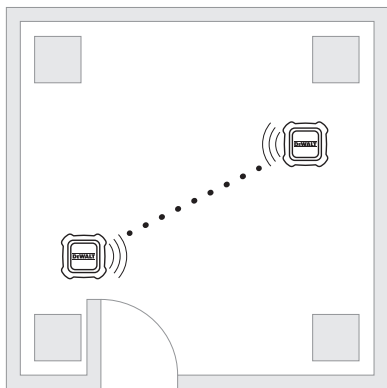
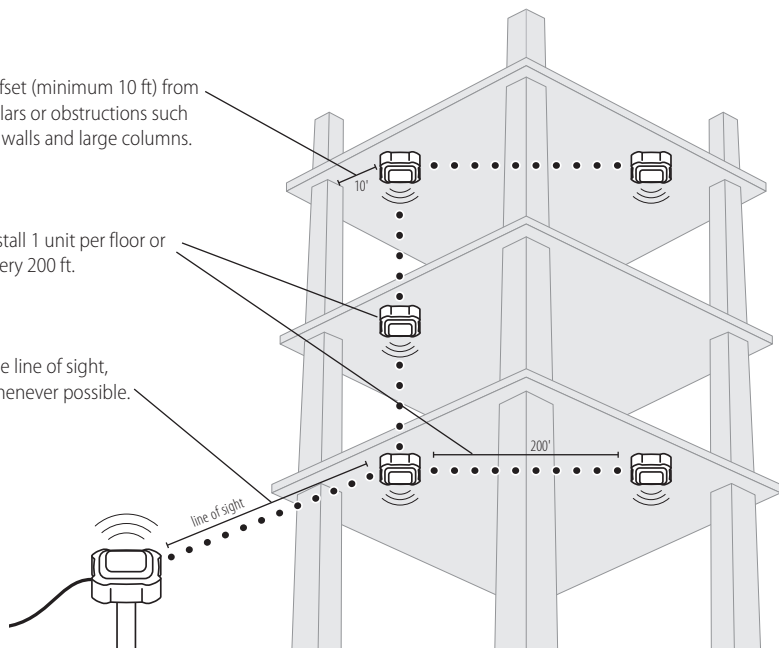

4. The DEWALT Jobsite WiFi system is designed to adapt to your changing jobsite, however some re-calibration may be required as construction progresses.

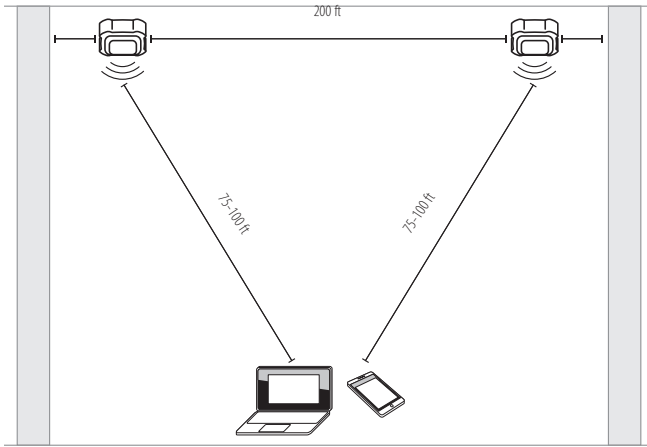

5. WiFi reception may vary by device. Many laptops, phones, tablets, and mobile devices have a maximum range of 75-100 ft.

**FOR MORE INFORMATION, VISIT [WIFI.DEWALT.COM/#TIPS](http://WIFI.DEWALT.COM/#TIPS)**

## Regulatory Notices

To comply with FCC/IC RF exposure limits for general population/uncontrolled exposure, the antenna(s) used for this transmitter must be installed to provide a separation distance of at least 20 cm from all persons and must not be co-located or operated in conjunction with any other antenna or transmitter..

This device complies with Industry Canada's licence-exempt RSSs and Part 15 of the FCC Rules. Operation is subject to the following two conditions:

1. This device may not cause harmful interference, and
2. This device must accept any interference received, including interference that may cause undesired operation.

**NOTE:** This equipment has been tested and found to comply with the limits for a Class B digital device, pursuant to part 15 of the FCC Rules. These limits are designed to provide reasonable protection against harmful interference in a residential installation. This equipment generates, uses and can radiate radio frequency energy and, if not installed and used in accordance with the instructions, may cause harmful interference to radio communications. However, there is no guarantee that interference will not occur in a particular installation. If this equipment does cause harmful interference to radio

or television reception, which can be determined by turning the equipment off and on, the user is encouraged to try to correct the interference by one or more of the following measures:

- Reorient or relocate the receiving antenna.
- Increase the separation between the equipment and receiver.
- Connect the equipment into an outlet on a circuit different from that to which the receiver is connected.
- Consult the dealer or an experienced radio/TV technician for help.

Conditions or modifications not expressly approved by the party responsible for compliance could void the user's authority to operate this equipment.

### CAN ICES-3(B)/NMB-3(B)

Under Industry Canada regulations, this radio transmitter may only operate using an antenna of a type and maximum (or lesser) gain approved for the transmitter by Industry Canada. To reduce radio interference to other users, the antenna type and its gain should be so chosen that the equivalent isotropically radiated power (e.i.r.p.) is not more than that necessary for successful communication.

## Safety Information



### WARNING:

- **When installing the unit, always be sure it is securely mounted.**
  - If using an s-hook to suspend from mounting hook, use s-hook with spring loaded safety latches.
  - if mounting unit to the tripod, check that the legs are firmly set and that the tripod is wobble free.
- **Pull by the plug rather than the cord when disconnecting.** This will reduce the risk of damage to the electric plug and cord.
- **Make sure that the power and ethernet cords are positioned so that they will not be tripped over, or otherwise subjected to damage or stress.**

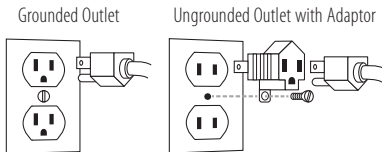

- **The power cable must be plugged into an appropriate outlet that is nearby, properly installed, and grounded in accordance with all local codes and ordinances.** The unit is for use on a nominal 120V circuit and should be connected to a grounded outlet. A temporary adaptor, always being held in place by a screw, may be used to connect this plug to a 2-pole outlet if a properly grounded outlet is not available. The adaptor should be used only until a properly grounded outlet can be installed by a qualified electrician. The green colored rigid ear, lug, and the like, extending from the adaptor must be connected to a permanent ground such as a properly grounded outlet box cover.
- **An extension cord must have adequate wire size (AWG or American Wire Gauge) for safety.** The smaller the gauge number of the wire, the greater the capacity of the cable. For example, a 16 gauge wire has more capacity than an 18 gauge wire. An undersized cord will cause a drop in line voltage resulting in loss of power and overheating. When using more than one extension to make up the total length, be sure each individual extension contains at least

the minimum wire size. The following table shows the correct size to use depending on cord length and nameplate ampere rating. If in doubt, use the next heavier gauge. The lower the gauge number, the heavier the cord. A proper extension cord will be marked with the suffix letter "W" and with a tag stating "Suitable for Use with Outdoor Appliances."

Minimum Gauge for Cord Sets

Volts		Total Length of Cord in Ft. (m)			
120 V		25 (7.6)	50 (15.2)	100 (30.5)	150 (45.7)
240 V		50 (15.2)	100 (30.5)	200 (61.0)	300 (91.4)
Ampere Rating		American Wire Gauge			
More Than	Not More Than				
0	6	18	16	16	14
6	10	18	16	14	12
10	12	16	16	14	12
12	16	14	12	Not Recommended	

## SAVE THESE INSTRUCTIONS FOR FUTURE USE

## Service & Repairs

The unit is not serviceable by the user.



**WARNING:** To assure product SAFETY and RELIABILITY, repairs, maintenance and adjustment should be performed by a DEWALT factory service center or a DEWALT authorized service center. Always use identical replacement parts.

## Cleaning

ALWAYS unplug the unit when cleaning.



**WARNING:** Blow dirt and dust out of all air vents with clean, dry air at least once a week. To minimize the risk of eye injury, always wear ANSI Z87.1 approved eye protection when performing this.



**WARNING:** Never use solvents or other harsh chemicals for cleaning the non-metallic parts of the product. These chemicals may weaken the plastic materials used in these parts. Use a cloth dampened only with water and mild soap. Never let any

## ENGLISH

*liquid get inside the **product**; never immerse any part of the **product** into a liquid.*

### One Year Limited Warranty

DeWALT will repair, without charge, any defects due to faulty materials or workmanship for one year from the date of purchase. This warranty does not cover part failure due to normal wear or abuse. For further detail of warranty coverage and warranty repair information, visit [www.DeWALT.com](http://www.DeWALT.com) or call 1-800-4-DeWALT (1-800-433-9258). This warranty does not apply to accessories or damage caused where repairs have been made or attempted by others. **THIS LIMITED WARRANTY IS GIVEN IN LIEU OF ALL OTHERS, INCLUDING THE IMPLIED WARRANTY OF MERCHANTABILITY AND FITNESS FOR A PARTICULAR PURPOSE, AND EXCLUDES ALL INCIDENTAL OR CONSEQUENTIAL DAMAGES.** Some states do not allow limitations on how long an implied warranty lasts or the exclusion or limitation of incidental or consequential damages, so these limitations may not apply to you. This warranty gives you specific legal rights and you may have other rights which vary in certain states or provinces.

In addition to the warranty, DeWALT **products** are covered by our:

#### 1 YEAR FREE SERVICE

DeWALT will maintain the **product** and replace worn parts caused by normal use, for free, any time during the first year after purchase.

#### 90 DAY MONEY BACK GUARANTEE

If you are not completely satisfied with the performance of your DeWALT **product** for any reason, you can return it within 90 days from the date of purchase with a receipt for a full refund – no questions asked.

**LATIN AMERICA:** This warranty does not apply to products sold in Latin America. For products sold in Latin America, see country specific warranty information contained in the packaging, call the local company or see website for warranty information.

**FREE WARNING LABEL REPLACEMENT:** If your warning labels become illegible or are missing, call 1-800-4-DeWALT (1-800-433-9258) for a free replacement.