

***If you have questions or comments, contact us.  
Pour toute question ou tout commentaire, nous contacter.  
Si tiene dudas o comentarios, contáctenos.***

**1-800-4-DEWALT • [www.dewalt.com](http://www.dewalt.com)**

**INSTRUCTION MANUAL  
GUIDE D'UTILISATION  
MANUAL DE INSTRUCCIONES**

INSTRUCTIVO DE OPERACIÓN, CENTROS DE SERVICIO Y PÓLIZA DE GARANTÍA. **ADVERTENCIA:** LÉASE ESTE INSTRUCTIVO ANTES DE USAR EL PRODUCTO.

**DEWALT®**

**DCT410, DCT411, DCT412  
12V Max\* Cordless Inspection Camera  
Caméra de surveillance sans fil 12 V max\*  
Cámara inalámbrica de inspección 12 V Máx\***

This device complies with part 15 of the FCC rules. Operation is subject to the following two conditions:

- (1) this device may not cause harmful interference, and
- (2) this device must accept any interference received, including interference that may cause undesired operation.

Changes or modifications to this unit not expressly approved by the party responsible for compliance could void the user's authority to operate the equipment.

This device complies with Industry Canada licence-exempt RSS standard(s). Operation is subject to the following two conditions:

- (1) this device may not cause interference, and
- (2) this device must accept any interference, including interference that may cause undesired operation of the device.

Le présent appareil est conforme aux CNR d'Industrie Canada applicables aux appareils radio exempts de licence. L'exploitation est autorisée aux deux conditions suivantes :

- (1) l'appareil ne doit pas produire de brouillage, et
- (2) l'utilisateur de l'appareil doit accepter tout brouillage radioélectrique subi, même si le brouillage est susceptible d'en compromettre le fonctionnement.

This equipment has been tested and found to comply with the limits for a Class B digital device, pursuant to part 15 of the FCC Rules. These limits are designed to provide reasonable protection against harmful interference in a residential installation. This equipment generates, uses and can radiate radio frequency energy and, if not installed and used in accordance with the instructions, may cause harmful interference to radio communications. However, there is no guarantee that interference will not occur in a particular installation. If this equipment does cause harmful interference to radio or television reception, which can be determined by turning the equipment off and on, the user is encouraged to try to correct the interference by one or more of the following measures:

- Reorient or relocate the receiving antenna.
- Increase the separation between the equipment and receiver.
- Connect the equipment into an outlet on a circuit different from that to which the receiver is connected.
- Consult the dealer or an experienced radio/TV technician for help.

### Definitions: Safety Guidelines

The definitions below describe the level of severity for each signal word. Please read the manual and pay attention to these symbols.

**⚠DANGER:** Indicates an imminently hazardous situation which, if not avoided, **will** result in **death or serious injury**.

**⚠WARNING:** Indicates a potentially hazardous situation which, if not avoided, **could** result in **death or serious injury**.

**⚠CAUTION:** Indicates a potentially hazardous situation which, if not avoided, **may** result in **minor or moderate injury**.

**NOTICE:** indicates a practice **not related to personal injury** which, if not avoided, **may** result in **property damage**.

IF YOU HAVE ANY QUESTIONS OR COMMENTS ABOUT THIS OR ANY DEWALT TOOL, CALL US TOLL FREE AT: **1-800-4-DEWALT (1-800-433-9258)**.



**WARNING:** To reduce the risk of injury, read the instruction manual.

### Important Safety Instructions

- Read these instructions.
- Keep these instructions.
- Heed all warnings.
- Follow all instructions.
- Only use attachments/accessories specified by the manufacturer.
- Refer all servicing to qualified service personnel. Servicing is required when the apparatus has been damaged in any way, the apparatus has been exposed to rain or moisture, does not operate normally, or has been dropped.

## SAVE ALL WARNINGS AND INSTRUCTIONS FOR FUTURE REFERENCE

### Work Area Safety

- a) **Keep work area clean and well lit.** Cluttered or dark areas invite accidents.
- b) **Keep children and bystanders away while operating an inspection camera.** Distractions can cause you to lose control.

### Personal Safety

- a) **Stay alert, watch what you are doing and use common sense when operating an inspection camera. Do not use an inspection camera while you are tired or under the influence of drugs, alcohol or medication.** A moment of inattention while operating the inspection camera may result in serious personal injury.
- b) **Use personal protective equipment. Always wear eye protection.** Protective equipment such as dust mask, non-skid safety shoes, hard hat, or hearing protection used for appropriate conditions will reduce personal injuries.
- c) **Do not overreach. Keep proper footing and balance at all times.** This enables better control of the inspection camera in unexpected situations.
- d) **Dress properly. Do not wear loose clothing or jewelry. Keep your hair, clothing and gloves away from moving parts.** Loose clothes, jewelry or long hair can be caught in moving parts.

### Use and Care

- a) **Store an idle inspection camera out of the reach of children and do not allow persons unfamiliar with the inspection camera or these instructions to operate the**

**inspection camera.** Inspection cameras are dangerous in the hands of untrained users.

- b) **Use the inspection camera, accessories and tool bits, etc. in accordance with these instructions, taking into account the working conditions and the work to be performed.** Use of the inspection camera for operations different from those intended could result in a hazardous situation.

### **Battery Tool Use and Care**

- a) **Recharge only with the charger specified by DEWALT.** A charger that is suitable for one type of battery pack may create a risk of fire when used with another battery pack.
- b) **When battery pack is not in use, keep it away from other metal objects like paper clips, coins, keys, nails, screws, or other small metal objects that can make a connection from one terminal to another.** Shorting the battery terminals together may cause burns or a fire.
- c) **Under abusive conditions, liquid may be ejected from the battery; avoid contact. If contact accidentally occurs, flush with water. If liquid contacts eyes, additionally seek medical help.** Liquid ejected from the battery may cause irritation or burns.

### **Safety Information for Inspection Cameras**

**⚠WARNING:** Do not disassemble or modify the inspection camera. There are no serviceable parts inside. If you need assistance contact DEWALT at 1-800-4-DEWALT (1-800-433-9258) or go to <http://www.dewalt.com> on the Internet.

- **Do not operate the inspection camera in explosive atmospheres, such as in the presence of flammable liquids, gases, or dust.** Inspection cameras create sparks which may ignite the dust or fumes.

- **The inspection camera should only be used with specifically designated DEWALT batteries.** Use of any other batteries may create a risk of fire.
- **Store the inspection camera out of reach of children and other untrained persons.** Tools are dangerous in the hands of untrained users.
- **Do not disassemble the inspection camera.** There are no user serviceable parts inside.
- **Do not use anywhere the unit may come into exposure with moving parts, hazardous chemicals, or electrical charges.** Such situations may result in serious injury or death; such as walls, pipes, automobiles, and machinery.
- **Do not operate inspection camera near moving machinery.** Can result in injury if the camera cable gets caught into moving parts and pulls the user in.
- **Do not use the inspection camera around corrosive chemicals.** Exposure to corrosive, oily environments can ruin the plastic covering on the camera head and ruin the picture quality.
- **Do not use the camera if condensation forms inside the lens.** Let the water evaporate before using again.
- **Do not remove or deface warning labels.**

**⚠WARNING:** Do not expose camera, monitor or battery to excessive heat such as sunshine, fire or the like.

**⚠WARNING: Shock hazard. Do not allow the inspection camera cable to come into contact with live wires.** Shut off circuit breakers to the entire area to avoid injury.

**⚠WARNING: ALWAYS** use safety glasses. Everyday eyeglasses are NOT safety glasses. Also use face or dust mask if cutting operation is dusty. ALWAYS WEAR CERTIFIED SAFETY EQUIPMENT:

- ANSI Z87.1 eye protection (CAN/CSA Z94.3).

**⚠ CAUTION:** Do not use on humans or animals. This is not for human or animal use and can cause injury if used.

**⚠ CAUTION:** When not in use, place inspection camera on its side on a stable surface where it will not cause a tripping or falling hazard. Some tools with large battery packs will stand upright on the battery pack but may be easily knocked over.

**⚠ WARNING:** Modifications not authorized by the manufacturer may void user's authority to operate this device.

## **Important Safety Instructions for All Battery Packs**

When ordering replacement battery packs, be sure to include catalog number and voltage. Consult the chart at the end of this manual for compatibility of chargers and battery packs.

The battery pack is not fully charged out of the carton. Before using the battery pack and charger, read the safety instructions below, then follow charging procedures outlined.

### **READ ALL INSTRUCTIONS**

- **Do not charge or use battery in explosive atmospheres, such as in the presence of flammable liquids, gases or dust.** Inserting or removing the battery from the charger may ignite the dust or fumes.
- **NEVER force battery pack into charger. DO NOT modify battery pack in any way to fit into a non-compatible charger as battery pack may rupture causing serious personal injury.** Consult the chart at the end of this manual for compatibility of batteries and chargers.
- Charge the battery packs only in DEWALT chargers.
- **DO NOT** splash or immerse in water or other liquids.
- **Do not store or use the tool and battery pack in locations where the temperature may reach or exceed 104 °F (40 °C) (such as outside sheds or metal buildings in summer).**

**⚠ WARNING:** Fire hazard. Never attempt to open the battery pack for any reason. If battery pack case is cracked or damaged, do not insert into charger. Do not crush, drop or damage battery pack. Do not use a battery pack or charger that has received a sharp blow,

been dropped, run over or damaged in any way (i.e., pierced with a nail, hit with a hammer, stepped on). Damaged battery packs should be returned to service center for recycling.

**⚠WARNING: Fire hazard. Do not store or carry battery so that metal objects can contact exposed battery terminals.** For example, do not place battery in aprons, pockets, tool boxes, product kit boxes, drawers, etc., with loose nails, screws, keys, etc. **Transporting batteries can possibly cause fires if the battery terminals inadvertently come in contact with conductive materials such as keys, coins, hand tools and the like.** The US Department of Transportation Hazardous Material Regulations (HMR) actually prohibit transporting batteries in commerce or on airplanes (i.e., packed in suitcases and carry-on luggage) UNLESS they are properly protected from short circuits. So when transporting individual batteries, make sure that the battery terminals are protected and well insulated from materials that could contact them and cause a short circuit.

#### **SPECIFIC SAFETY INSTRUCTIONS FOR LITHIUM ION (Li-Ion)**

- **Do not incinerate the battery pack even if it is severely damaged or is completely worn out.** The battery pack can explode in a fire. Toxic fumes and materials are created when lithium ion battery packs are burned.
- **If battery contents come into contact with the skin, immediately wash area with mild soap and water.** If battery liquid gets into the eye, rinse water over the open eye for 15 minutes or until irritation ceases. If medical attention is needed, the battery electrolyte is composed of a mixture of liquid organic carbonates and lithium salts.
- **Contents of opened battery cells may cause respiratory irritation.** Provide fresh air. If symptoms persists, seek medical attention.

**⚠WARNING:** Burn hazard. Battery liquid may be flammable if exposed to spark or flame.

#### **The RBRC® Seal**

The RBRC® (Rechargeable Battery Recycling Corporation) Seal on the nickel cadmium, nickel metal hydride or lithium-ion batteries (or battery packs) indicates that the costs to recycle these batteries (or battery packs) at the end of their useful life have already been paid by DEWALT. In some areas, it is illegal to place spent nickel cadmium, nickel metal hydride or lithium-ion batteries in the trash or municipal solid waste stream and the Call 2 Recycle® program provides an environmentally conscious alternative.



Call 2 Recycle, Inc., in cooperation with DEWALT and other battery users, has established the program in the United States and Canada to facilitate the collection of spent nickel cadmium, nickel metal hydride or lithium-ion batteries. Help protect our environment and conserve natural resources by returning the spent nickel cadmium, nickel metal hydride or lithium-ion batteries to an authorized DEWALT service center or to your local retailer for recycling. You may also contact your local recycling center for information on where to drop off the spent battery. RBRC® is a registered trademark of Call 2 Recycle, Inc.

#### **Important Safety Instructions for All Battery Chargers**

**SAVE THESE INSTRUCTIONS:** This manual contains important safety and operating instructions for battery chargers.

- Before using charger, read all instructions and cautionary markings on charger, battery pack, and product using battery pack.

**⚠WARNING:** Shock hazard. Do not allow any liquid to get inside charger. Electric shock may result.

**⚠ CAUTION:** Burn hazard. To reduce the risk of injury, charge only DEWALT rechargeable batteries. Other types of batteries may burst causing personal injury and damage.

**NOTICE:** Under certain conditions, with the charger plugged in to the power supply, the charger can be shorted by foreign material. Foreign materials of a conductive nature such as, but not limited to, grinding dust, metal chips, steel wool, aluminum foil, or any buildup of metallic particles should be kept away from charger cavities. Always unplug the charger from the power supply when there is no battery pack in the cavity. Unplug charger before attempting to clean.

**⚠ WARNING:**

- **DO NOT attempt to charge the battery pack with any chargers other than the ones in this manual.** The charger and battery pack are specifically designed to work together.
- **These chargers are not intended for any uses other than charging DEWALT rechargeable batteries.** Any other uses may result in risk of fire, electric shock or electrocution.
- **Do not expose charger to rain or snow.**
- **Pull by plug rather than cord when disconnecting charger.** This will reduce risk of damage to electric plug and cord.
- **Make sure that cord is located so that it will not be stepped on, tripped over, or otherwise subjected to damage or stress.**
- **Do not use an extension cord unless it is absolutely necessary.** Use of improper extension cord could result in risk of fire, electric shock, or electrocution.
- **When operating an inspection camera outdoors, use an extension cord suitable for outdoor use.** Use of a cord suitable for outdoor use reduces the risk of electric shock.
- **An extension cord must have adequate wire size (AWG or American Wire Gauge) for safety.** The smaller the gauge

number of the wire, the greater the capacity of the cable, that is 16 gauge has more capacity than 18 gauge. An undersized cord will cause a drop in line voltage resulting in loss of power and overheating. When using more than one extension to make up the total length, be sure each individual extension contains at least the minimum wire size. The following table shows the correct size to use depending on cord length and nameplate ampere rating. If in doubt, use the next heavier gauge. The smaller the gauge number, the heavier the cord.

Minimum Gauge for Cord Sets						
Ampere Rating		Volts	Total Length of Cord in Feet (meters)			
		120V	25 (7.6)	50 (15.2)	100 (30.5)	150 (45.7)
		240V	50 (15.2)	100 (30.5)	200 (61.0)	300 (91.4)
More Than	Not More Than	AWG				
0	6		18	16	16	14
6	10		18	16	14	12
10	12		16	16	14	12
12	16		14	12	Not Recommended	

- **Do not place any object on top of charger or place the charger on a soft surface that might block the ventilation slots and result in excessive internal heat.** Place the charger in a position away from any heat source. The charger is ventilated through slots in the top and the bottom of the housing.
- **Do not operate charger with damaged cord or plug.**
- **Do not operate charger if it has received a sharp blow, been dropped, or otherwise damaged in any way.** Take it to an authorized service center.
- **Do not disassemble charger; take it to an authorized service center when service or repair is required.** Incorrect reassembly may result in a risk of electric shock, electrocution or fire.

- **Disconnect the charger from the outlet before attempting any cleaning. This will reduce the risk of electric shock. Removing the battery pack will not reduce this risk.**
- **NEVER attempt to connect 2 chargers together.**
- **The charger is designed to operate on standard 120 V household electrical power. Do not attempt to use it on any other voltage. This does not apply to the vehicular charger.**

### Chargers

Your tool uses a DEWALT charger. Be sure to read all safety instructions before using your charger. Consult the chart on the back cover of this manual for compatibility of chargers and battery packs.

### Charging Procedure (Fig. 1)

1. Plug the charger into an appropriate outlet before inserting battery pack.
2. Insert the battery pack (A) into the charger, as shown in Figure 1, making sure the pack is fully seated in charger. The red (charging) light will blink continuously indicating that the charging process has started.
3. The completion of charge will be indicated by the red light remaining ON continuously. The pack is fully charged and may be used at this time or left in the charger.

FIG. 1

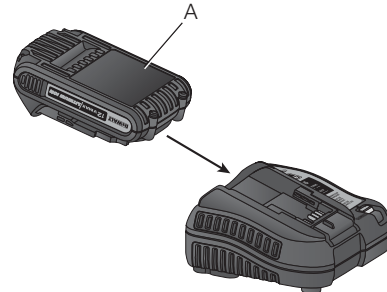

### Indicator Light Operation

DCB101, DCB102, DCB103

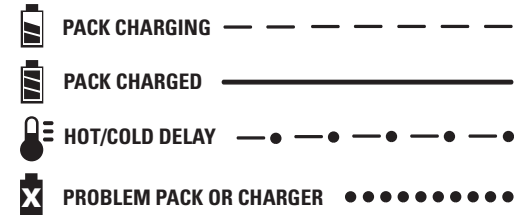

DCB107, DCB112, DCB113, DCB115

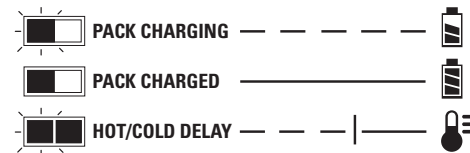

### Charge Indicators

This charger is designed to detect certain problems that can arise. Problems are indicated by the red light flashing at a fast rate. If this occurs, re-insert the battery pack into the charger. If the problem persists, try a different battery pack to determine if the charger is working properly. If the new pack charges correctly, then the original pack is defective and should be returned to a service center or other collection site for recycling. If the new battery pack elicits the same trouble indication as the original, have the charger and the battery pack tested at an authorized service center.



**HOT/COLD DELAY**

**DCB101, DCB102, DCB103**

These chargers have a hot/cold delay feature. When the charger detects a battery that is too hot or too cold, it automatically starts a delay, suspending charging. The red light flashes long, then short while in the hot/cold delay mode.

Once the battery has reached an optimum temperature, the charger will automatically resume the charging procedure. This feature ensures maximum battery life.

**DCB107, DCB112, DCB113, DCB115**

These chargers have a hot/cold delay feature. When the charger detects a battery that is too hot or too cold, it automatically starts a delay, suspending charging. The red light will continue to blink, but a yellow indicator light will be illuminated during this suspension.

Once the battery has reached an optimum temperature, the yellow light will turn off and the charger will automatically resume the charging procedure. This feature ensures maximum battery life.

**LEAVING THE BATTERY PACK IN THE CHARGER**

The charger and battery pack can be left connected with the charge indicator showing Pack Charged.

**WEAK BATTERY PACKS:** Weak batteries will continue to function but should not be expected to perform as much work.

**FAULTY BATTERY PACKS**

**DCB101, DCB102, DCB103**

These chargers will not charge a faulty battery pack. The charger will indicate faulty battery pack by refusing to light or by displaying problem pack or charger.

**NOTE:** This could also mean a problem with a charger.

**DCB107, DCB112, DCB113, DCB115**

These chargers will not charge a faulty battery pack. The charger will indicate faulty battery pack by refusing to light.

**NOTE:** This could also mean a problem with a charger.

**Wall Mounting**

**DCB107, DCB112, DCB113, DCB115**

These chargers are designed to be wall mountable or to sit upright on a table or work surface.

If wall mounting, locate the charger within reach of an electrical outlet. Mount the charger securely using drywall screws at least 1" (25.4 mm) long, screwed into wood to an optimal depth leaving approximately 7/32" (5.5 mm) of the screw exposed.

**Important Charging Notes**

1. Longest life and best performance can be obtained if the battery pack is charged when the air temperature is between 65 °F and 75 °F (18–24 °C). DO NOT charge the battery pack in an air temperature below +40 °F (+4.5 °C), or above +104 °F (+40.5 °C). This is important and will prevent serious damage to the battery pack.
2. The charger and battery pack may become warm to touch while charging. This is a normal condition, and does not indicate a problem. To facilitate the cooling of the battery pack after use, avoid placing the charger or battery pack in a warm environment such as in a metal shed, or an uninsulated trailer.
3. If the battery pack does not charge properly:
  - a. Check operation of receptacle by plugging in a lamp or other appliance;
  - b. Check to see if receptacle is connected to a light switch which turns power off when you turn out the lights;

- c. Move charger and battery pack to a location where the surrounding air temperature is approximately 65 °F–75 °F (18–24 °C);
- d. If charging problems persist, take the tool, battery pack and charger to your local service center.
4. The battery pack should be recharged when it fails to produce sufficient power on jobs which were easily done previously. DO NOT CONTINUE to use under these conditions. Follow the charging procedure. You may also charge a partially used pack whenever you desire with no adverse affect on the battery pack.
5. Foreign materials of a conductive nature such as, but not limited to, grinding dust, metal chips, steel wool, aluminum foil, or any buildup of metallic particles should be kept away from charger cavities. Always unplug the charger from the power supply when there is no battery pack in the cavity. Unplug charger before attempting to clean.
6. Do not freeze or immerse charger in water or any other liquid.

**⚠ WARNING:** Shock hazard. Don't allow any liquid to get inside charger. Electric shock may result.

**⚠ CAUTION:** Never attempt to open the battery pack for any reason. If the plastic housing of the battery pack breaks or cracks, return to a service center for recycling.

### Storage Recommendations

1. The best storage place is one that is cool and dry away from direct sunlight and excess heat or cold.
2. For long storage, it is recommended to store a fully charged battery pack in a cool dry place out of the charger for optimal results.

**NOTE:** Battery packs should not be stored completely depleted of charge. The battery pack will need to be recharged before use.

## SAVE THESE INSTRUCTIONS FOR FUTURE USE

### COMPONENTS (Fig. 2, 3)

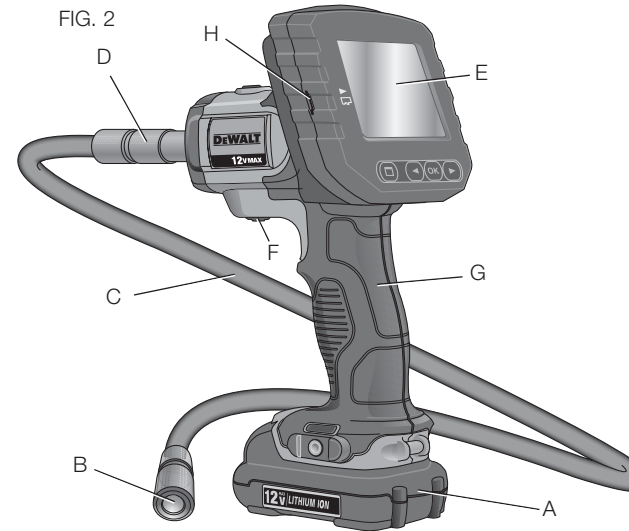

**⚠ WARNING:** Never modify the inspection camera or any part of it. Damage or personal injury could result.

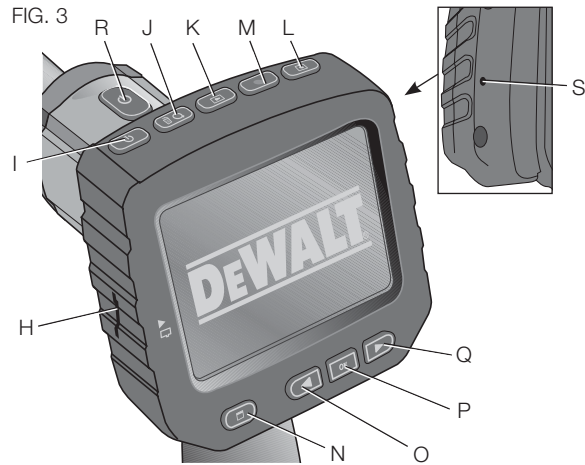

- A. 12V Max\* Lithium Ion Battery  
 B. Camera with LED's  
 C. 3' (.91 m) Camera cable  
 D. Camera connector

- E. Screen
- F. Camera cable on/off switch / LED brightness control switch
- G. Handle set
- H. Micro SD slot for micro SD memory cards 16 gb or less



- I.  **Power button for the screen:** Both the screen and the camera cable (F) need to be turned on.
- J.  **Zoom/Delete button:**  
The button has 2 functions:
  - Zoom:** This is to be used when you need a closer look at the object (3x zoom).
  - Delete:** When in the folder menu, pictures can be deleted by using this button.

- K.  **Play:** Press the button to go to the folder where photos and videos are saved.  
OR  
Press the button to play videos.
- L.  **Camera:** Press this button for taking a photo.
- M.  **Record:** Press this button to start and stop recording a video.
- N.  **Main Menu:** Press this button to show a list of options for operating the inspection camera or to exit a screen.
- O.  **Back Arrow:** Press this button to navigate backward.
- P.  **OK:** Press this button to save changes.
- Q.  **Forward Arrow:** Press this button to navigate forward.
- R.  **Power indicator for the handle set:** When the green light is on it indicates that the handle set is on.
- S. Reset button

#### INTENDED USE

The inspection camera is designed to play real-time video while looking into walls and/or tight spaces. With a micro SD card (sold separately), the tool can then take photos or record videos for documentation purposes.

Photos are saved in JPG format and videos are saved as **MP4**. This DEWALT inspection camera is compatible with micro SD memory cards up to 16 gigabytes.

Applications consist of automotive inspection, plumbing inspection, HVAC inspection or cable routing. Read the entire manual before using this inspection camera.

English

**DO NOT** use in presence of flammable liquids or gases. The camera cable extension is waterproof up to the camera connector. **DO NOT USE** the handle set under wet conditions.

The inspection camera is a professional tool. **DO NOT** let children come into contact with the tool. Supervision is required when inexperienced operators use this tool.

### ASSEMBLY

#### Screen (Fig. 4)

When the screen is attached to the handle set with a battery, it will receive a charge from the battery. Ensure the screen is fully charged before use.

When the screen is disengaged from the handle set, a battery icon appears in the upper left corner. This icon also displays the current charge of the screen.

To install the screen (E) into the handle set (G), align the rails on the handle set and slide it firmly into the handle until you hear the lock snap into place.

To remove the screen from the handle set, firmly slide the screen up from the tool handle.

The screen can be turned on and viewed when it is not attached to the handle set, allowing easier maneuverability of the camera.

FIG. 4

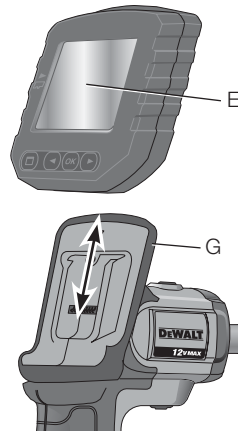

#### Camera Cable (Fig. 5)

Align the camera cable with the camera connector (D). Push in and turn the connector counterclockwise (camera screen facing you) to firmly attach.

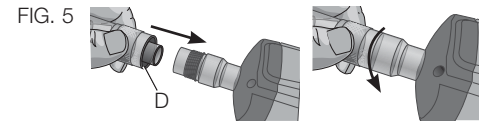

To remove the camera cable, turn the connector clockwise (direction of arrow).

Additional camera cable and extensions are available at additional cost. Please contact DEWALT Industrial Tool Co., 701 East Joppa Road, Towson, MD 21286, call 1-800-4-DEWALT (1-800-433-9258) or visit our website [www.dewalt.com](http://www.dewalt.com).

#### Hook and Magnet DCT410 (Fig. 6)

The hook is beneficial for retrieving cable or wire located in tight spaces. The magnet is beneficial for retrieving metal objects in tight spaces.

To attach the hook or magnet, turn the knurled part of the camera counterclockwise until it stops.

Align the hook or magnet with the gray groove (T) then slide it down until the tabs (U) at the top of the hook/magnet are securely in the notches (V) located in the camera lens.

Turn the knurled part clockwise to lock the base of the hook and magnet.

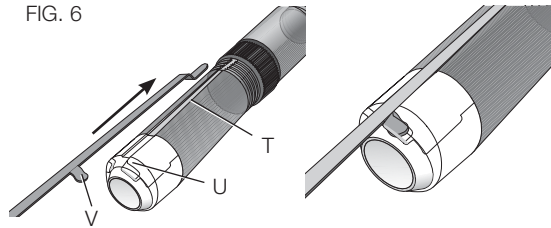

**Hook, Magnet and Mirror DCT411  
(Fig. 7, 8)**

Follow the process below to assemble the hook, magnet or mirror onto the DCT411 9 mm camera.

1. With the sleeve (W) on the accessory, insert the bottom of accessory (bent wire) into the hole (X) in the 9 mm camera cable.

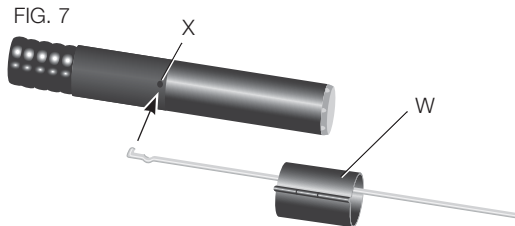

2. Make sure the accessory is in the groove (Y) on the sleeve and slide the sleeve onto the camera until the sleeve covers the hole (X).

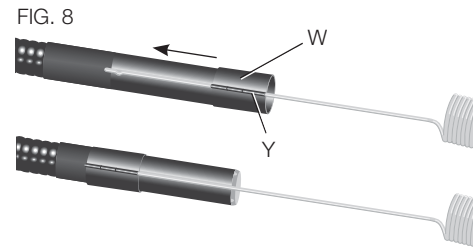

**⚠ CAUTION:** Cut Hazard. Use care when handling hook.

**Belt Hook (Fig. 9)  
(Optional Accessory)**

**⚠ WARNING:** To reduce the risk of serious personal injury, **DO NOT** suspend tool overhead or suspend objects from the belt hook. **ONLY** hang tool's belt hook from a work belt.

**⚠ WARNING:** To reduce the risk of serious personal injury, **ensure the screw (Z) holding the belt hook is secure.**

**IMPORTANT:** When attaching or removing the belt hook, use only the screw (Z) that is provided.

The belt hook (AA) can be attached to either side of the tool using only the screw (Z) provided, to accommodate left- or right-handed users. If the hook is not desired at all, it can be removed from the tool.

To move belt hook, remove the screw (Z) that holds the belt hook in place then reassemble on the opposite side.

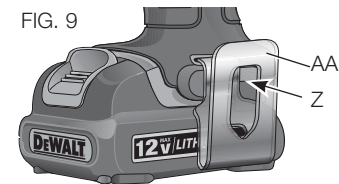

English

**OPERATION****Installing and Removing the Battery Pack (Fig. 10)**

**NOTE:** Make sure your battery pack is fully charged.

To install the battery pack (A) into the tool handle, align the battery with the rails inside the tool's handle and slide it firmly into the handle until you hear the lock snap into place.

FIG. 10



To remove the battery pack from the tool, press the release button (BB) and firmly pull the battery pack out of the tool handle. Insert it into the charger as described in the charger section of this manual.

**Getting Started****INITIAL SETUP****Language Setup**

1. Press the forward or back arrow to select English, French or Spanish.

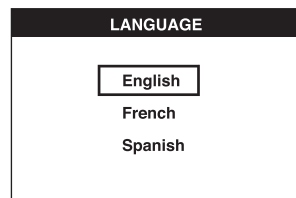

2. Press the OK button to confirm and exit.

**Date and Time Setup**

1. Press the forward or back arrow to highlight the field to change.

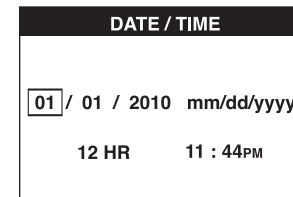

2. Press the OK button to activate the field (field turns green).
3. Press the forward or back arrow to change the activated field.
4. Press the OK button to save changes (field turns yellow).
5. Repeat above steps to change remaining fields.
6. Press the main menu button to exit.

**BASIC OPERATION**

**NOTE:** At any time during the camera operation, pressing the main menu button will return to the previous menu.

**To Record Photos or Videos**

Be sure a micro SD card (sold separately) is loaded in the card slot (H).

1. Turn both the camera (B) and the handle set (G) on.
2. Aim camera at destination.

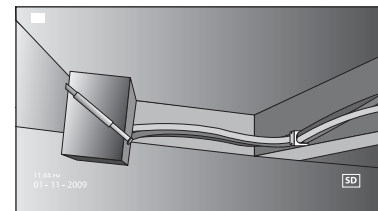

A. Press the camera button (L) to take a photo. A confirmation icon will appear in the top right side of screen.

OR

B. Press the record button (M) to start recording.

A red dot will appear in the top right side of the screen. To stop recording, press the record button again.

The camera will create a folder on the micro SD card for that day. All photos or videos taken that day will be stored in this folder.

**To View Photos or Videos**

1. Press the main menu button to show the Main Menu.
2. Press the forward or back arrow to select the Folder option.

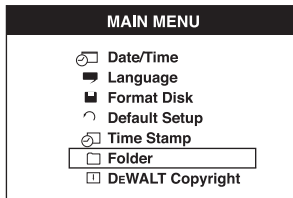

3. Press the OK button to navigate to the next screen.
4. Press the forward or back arrow to select a dated folder.

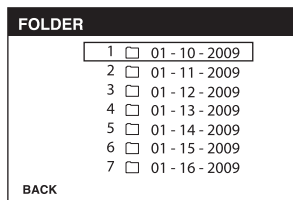

5. Press the OK button to select the dated folder.
6. Press the forward or back arrow to select the photo or video.

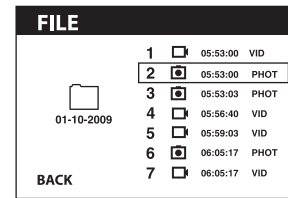

7. Press the OK button to view the photo or video.

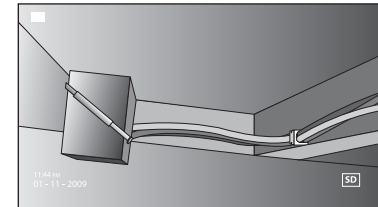

8. Press the forward or back arrow to advance to the next photo or video.
9. When finished, press the main menu button to exit.

**To Delete Individual Photos or Videos:**

1. Press the main menu button to show the Main Menu.
2. Press the forward or back arrow to select the Folder option.

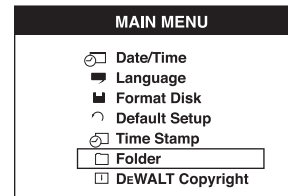

English

3. Press the OK button to navigate to the next screen.
4. Press the forward or back arrow to select a dated folder.

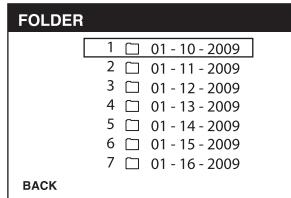

5. Press the OK button to navigate to the next screen.
6. Press the forward or back arrow to select a photo or video.

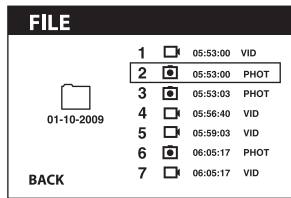

7. Press the delete button. Select YES to delete the individual photo or video.

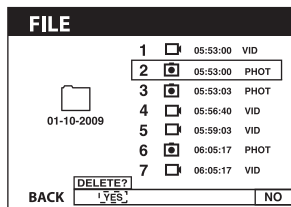

8. Press the main menu button to exit.

**To Delete a Photo or Video While Viewing**

1. Press the main menu button to show the Main Menu.
2. Press the forward or back arrow to select the Folder option.

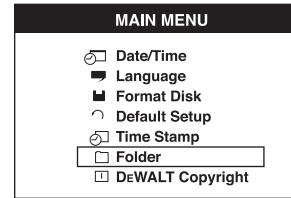

3. Press the OK button to navigate to the next screen.
4. Press the forward or back arrow to select a dated folder.

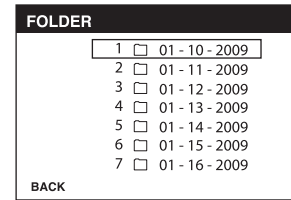

5. Press the OK button to navigate to the next screen.
6. Press the forward or back arrow to select a photo or video.
7. Press the OK button to view.

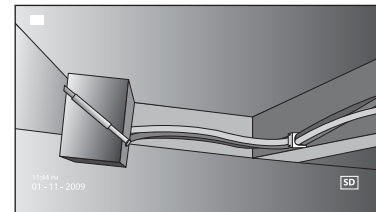



- Press the delete button. Select YES to delete the individual photo or video.

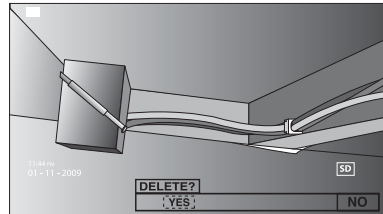

### To Change Languages

- Press the main menu button to show the Main Menu.
- Press the forward or back arrow to select the Language option.

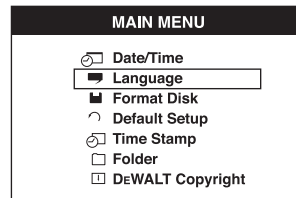

- Press the OK button to select.
- Press the forward or back arrow to select English, French or Spanish.

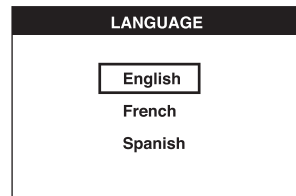

- Press the OK button to save changes.
- Press the main menu button to exit.

### To Change Date/Time

- Press the main menu button to show the Main Menu.
- Press the forward or back arrow to select Date/Time option.

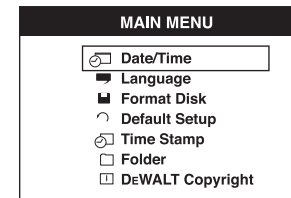

- Press the OK button to navigate to the next screen.
- Press the forward or back arrow to highlight a field to change.

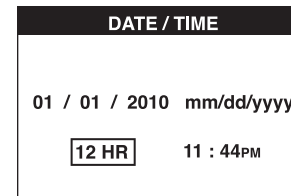

- Press the OK button to activate the field (field turns green).
- Press the forward or back arrow to change the activated field.
- Press the OK button to save changes.
- Repeat above steps to change remaining fields.
- Press the main menu button to exit.

**To Activate the Time Stamp**

1. Press the main menu button to show the Main Menu.
2. Press the forward or back arrow to select the Time Stamp option.

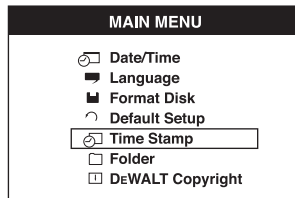

3. Press the OK button to navigate to the next screen.
4. Press the forward or back arrow to select OFF or ON.

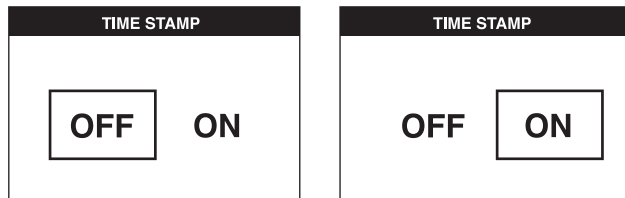

5. Press the OK button to save changes.
6. Press the main menu button to exit.

**To Format Micro SD Card**

**NOTICE: Formatting the micro SD card will erase all data.**

1. Press the main menu button to show the Main Menu.
2. Press the forward or back arrow to select the Format Disk option.

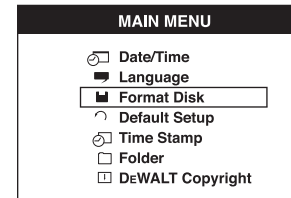

3. Press the OK button to navigate to the next screen.
4. Press the forward or back arrow to select NO or YES.

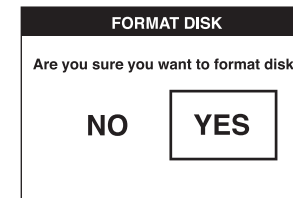
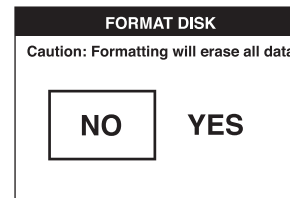

5. Press the OK button to save changes and exit.

**To Change Default Setup**

**NOTICE: Changing to default setup will erase current settings and restore factory settings.**

1. Press the main menu button to show the Main Menu.
2. Press the forward or back arrow to select the Default Setup option.

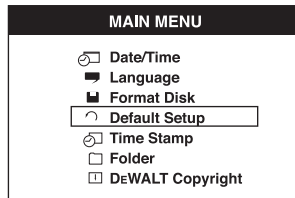

3. Press the OK button to navigate to the next screen.
4. Press the forward or back arrow to select NO or YES.

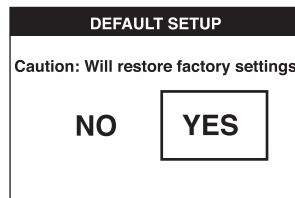
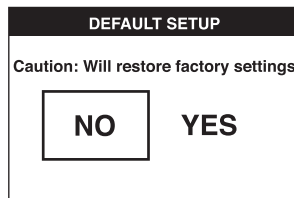

5. Press the OK button to save changes and exit.

### **Operating Tips**

- Use only DEWALT 12V Max\* lithium ion battery.
- Ensure the DEWALT battery is in good working condition. If the low battery indicator light on the screen is flashing, the battery needs to be recharged.
- To extend battery life, make sure to turn both the screen and the handle set off when not in use.
- Make sure the screen is fully charged before operation.

## **MAINTENANCE**

### **Cleaning**

**⚠WARNING:** Blow dirt and dust off with clean, dry air at least once a week. To minimize the risk of eye injury, always wear ANSI Z87.1 approved eye protection when performing this.

**⚠WARNING:** Never use solvents or other harsh chemicals for cleaning the non-metallic parts of the tool. These chemicals may weaken the plastic materials used in these parts. Use a cloth dampened only with water and mild soap. Never let any liquid get inside the tool; never immerse any part of the tool into a liquid.

### **CHARGER CLEANING INSTRUCTIONS**

**⚠WARNING:** Shock hazard. Disconnect the charger from the AC outlet before cleaning. Dirt and grease may be removed from the exterior of the charger using a cloth or soft non-metallic brush. Do not use water or any cleaning solutions.

### **Troubleshooting**

- Make sure the 12V Max\* battery is charged.
- Make sure the screen is fully charged.
- Make sure the screen is always attached to the handle set. The picture may freeze if you attempt to remove the (screen) from the handle set while taking a photo or video.
- Make sure the battery is installed on the handle set when in use.
- Make sure the camera cable is attached to the handle set properly.
- Make sure the handle set is turned on as well as the screen.
- Make sure the back of the handle set is not covered with debris so the screen slides on easily and no damage to the screen occurs.
- If the screen freezes or won't turn on, insert a small object (i.e., paper clip end) into the reset button located on the back of the screen.

- If the picture is dim, roll the brightness control switch to brighten the LED light.

### Accessories

**▲ WARNING:** *Since accessories, other than those offered by DEWALT, have not been tested with this product, use of such accessories with this tool could be hazardous. To reduce the risk of injury, only DEWALT recommended accessories should be used with this product.*

Recommended accessories for use with your tool are available at extra cost from your local dealer or authorized service center. If you need assistance in locating any accessory, please contact DEWALT Industrial Tool Co., 701 East Joppa Road, Towson, MD 21286, call 1-800-4-DEWALT (1-800-433-9258) or visit our website [www.dewalt.com](http://www.dewalt.com).

#### RECOMMENDED ACCESSORIES

- Camera cable: 17mm diameter
- Camera cable: 9 mm diameter
- Camera cable: 5.8mm diameter
- 3' (.91m) cable extension: 17mm diameter
- Hook and magnet (DCT410)
- Hook, magnet and mirror (DCT411)

Please contact DEWALT Industrial Tool Co., 701 East Joppa Road, Towson, MD 21286, call 1-800-4-DEWALT (1-800-433-9258) or visit our website [www.dewalt.com](http://www.dewalt.com).

### Repairs

The charger, battery pack and inspection camera are not serviceable. There are no serviceable parts inside the charger, battery pack or inspection camera.

To assure product SAFETY and RELIABILITY, repairs, maintenance and adjustment should be performed by a DEWALT factory service

center, a DEWALT authorized service center or other qualified service personnel. Always use identical replacement parts.

### Register Online

Thank you for your purchase. Register your product now for:

- **WARRANTY SERVICE:** Registering your product will help you obtain more efficient warranty service in case there is a problem with your product.
- **CONFIRMATION OF OWNERSHIP:** In case of an insurance loss, such as fire, flood or theft, your registration of ownership will serve as your proof of purchase.
- **FOR YOUR SAFETY:** Registering your product will allow us to contact you in the unlikely event a safety notification is required under the Federal Consumer Safety Act.

Register online at [www.dewalt.com/register](http://www.dewalt.com/register).

### Three Year Limited Warranty

DEWALT will repair, without charge, any defects due to faulty materials or workmanship for three years from the date of purchase. This warranty does not cover part failure due to normal wear or tool abuse. For further detail of warranty coverage and warranty repair information, visit [www.dewalt.com](http://www.dewalt.com) or call 1-800-4-DEWALT (1-800-433-9258). This warranty does not apply to accessories or damage caused where repairs have been made or attempted by others. This warranty gives you specific legal rights and you may have other rights which vary in certain states or provinces.

In addition to the warranty, DEWALT tools are covered by our:

#### 1 YEAR FREE SERVICE

DEWALT will maintain the tool and replace worn parts caused by normal use, for free, any time during the first year after purchase.

**2 YEARS FREE SERVICE ON DeWALT BATTERY PACKS**  
 DC9071, DC9091, DC9096, DC9280, DC9360, DC9180, DCB120,  
 DCB201, DCB203, DCB207 and DCB127

**3 YEARS FREE SERVICE ON DeWALT BATTERY PACKS**  
 DCB200, DCB204

**DeWALT BATTERY PACKS**

Product warranty voided if the battery pack is tampered with in any way. DeWALT is not responsible for any injury caused by tampering and may prosecute warranty fraud to the fullest extent permitted by law.

**90 DAY MONEY BACK GUARANTEE**

If you are not completely satisfied with the performance of your DeWALT Power Tool, Laser, or Nailer for any reason, you can return it within 90 days from the date of purchase with a receipt for a full refund – no questions asked.

**LATIN AMERICA:** This warranty does not apply to products sold in Latin America. For products sold in Latin America, see country specific warranty information contained in the packaging, call the local company or see website for warranty information.

**FREE WARNING LABEL REPLACEMENT:** If your warning labels become illegible or are missing, call 1-800-4-DeWALT (1-800-433-9258) for a free replacement.

**SPECIFICATIONS**

Camera Cable Diameter	DCT410: 17mm DCT411: 9 mm DCT412: 5.8mm
Cable length	3' (.91m)
Resolution	320 x 480 dpi
Screen Size	3.5"

**English**

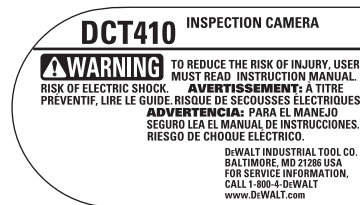

DeWALT Battery and Charger Systems

Chargers/Charge Time (Minutes) – Chargeurs/Durée de charge (Minutes) – Cargadores de baterías/Tiempo de carga (Minutos)

Battery Cat #	Output Voltage	120 Volts																			12 Volts							
		DC011	DC022	DC9000	DC9310	DC9320	DC8095	DC8101	DCB102	DCB103	DCB107	DCB112	DCB113	DCB114	DCB115	DW911	DW9106	DW9107	DW9108	DW9116	DW9117	DW9118	DW9216	DW9226	DCB119	DW0249	DW9109	DC9319
DCB404	40	X	X	X	X	X	X	X	X	X	X	X	X	X	X	X	X	X	X	X	X	X	X	X	X	X	X	X
DCB406	40	X	X	X	X	X	X	X	X	X	X	X	X	130	X	X	X	X	X	X	X	X	X	X	X	X	X	X
DC9360	36	X	X	45	X	X	X	X	X	X	X	X	X	X	X	X	X	X	X	X	X	X	X	X	X	X	X	
DCB361	36	X	X	45	X	X	X	X	X	X	X	X	X	X	X	X	X	X	X	X	X	X	X	X	X	X	X	
DC9280	28	X	X	60	X	X	X	X	X	X	X	X	X	X	X	X	X	X	X	X	X	X	X	X	X	X	X	
DW0242	24	X	X	X	X	X	X	X	X	X	X	X	X	X	X	X	X	X	X	X	X	X	X	X	X	60	X	
DCB200	20	X	X	X	X	X	X	60	60	60	140	90	67	X	45	X	X	X	X	X	X	X	X	X	X	90	X	
DCB201	20	X	X	X	X	X	X	30	30	30	70	45	35	X	22	X	X	X	X	X	X	X	X	X	45	X	X	
DCB203/BT*	20	X	X	X	X	X	X	35	35	35	90	60	45	X	30	X	X	X	X	X	X	X	X	X	60	X	X	
DCB204/BT*	20	X	X	X	X	X	X	70	70	70	185	120	90	X	60	X	X	X	X	X	X	X	X	X	120	X	X	
DCB205	20	X	X	X	X	X	X	90	90	90	240	150	112	X	75	X	X	X	X	X	X	X	X	X	150	X	X	
DCB207	20	X	X	X	X	X	X	30	30	30	60	40	30	X	22	X	X	X	X	X	X	X	X	X	X	X	X	
DC9096	18	60	60	X	60	60	X	60	X	X	60	X	X	X	60	X	X	X	60	60	20	X	60	130	X	X	60	
DC9099	18	45	45	X	45	45	X	X	X	45	X	X	X	X	45	X	X	X	45	45	15	X	45	95	X	X	45	
DC9182	18	X	X	X	40	40	X	X	X	40	X	X	X	X	X	X	X	X	X	X	X	X	X	X	X	X	40	
DW9096	18	60	60	X	60	60	X	X	X	60	X	X	X	X	60	X	X	X	60	60	20	X	60	130	X	X	60	
DW9098	18	30	30	X	30	30	X	X	X	30	X	X	X	X	30	X	X	X	30	30	12	X	30	60	X	X	30	
DW9099	18	45	45	X	45	45	X	X	X	45	X	X	X	X	45	X	X	X	45	45	15	X	45	95	X	X	45	
DC9091	14.4	60	60	X	60	60	X	X	X	60	X	X	X	X	60	90	60	60	60	20	115	60	115	X	X	60	60	
DC9094	14.4	45	45	X	45	45	X	X	X	45	X	X	X	X	45	60	45	45	45	15	90	45	90	X	X	45	45	
DW9091	14.4	45	45	X	45	45	X	X	X	45	X	X	X	X	45	60	45	45	45	15	90	45	90	X	X	45	45	
DW9094	14.4	30	30	X	30	30	X	X	X	30	X	X	X	X	30	45	30	30	30	12	60	30	60	X	X	30	30	
DCB120	12	X	X	X	X	X	X	30	30	30	60	45	35	X	20	X	X	X	X	X	X	X	X	X	45	X	X	
DCB127	12	X	X	X	X	X	X	35	35	35	90	60	50	X	30	X	X	X	X	X	X	X	X	X	60	X	X	
DC9071	12	60	60	X	60	60	X	X	X	60	X	X	X	X	60	90	60	60	60	20	115	60	115	X	X	60	60	
DW9050	12	X	X	X	X	X	X	X	X	X	X	X	X	X	X	40	X	X	X	X	X	X	X	X	X	X	X	
DW9071	12	45	45	X	45	45	X	X	X	45	X	X	X	X	45	60	45	45	45	15	90	45	90	X	X	45	45	
DW9072	12	30	30	X	30	30	X	X	X	30	X	X	X	X	30	45	30	30	30	12	60	30	60	X	X	30	30	
DW9048	9.6	X	X	X	X	X	X	X	X	X	X	X	X	X	X	40	X	X	X	X	X	X	X	X	X	X	X	
DW9061	9.6	45	45	X	45	45	X	X	X	45	X	X	X	X	45	60	45	45	45	15	90	45	90	X	X	45	45	
DW9062	9.6	30	30	X	30	30	X	X	X	30	X	X	X	X	30	45	30	30	30	12	60	30	60	X	X	30	30	
DCB080	8	X	X	X	X	X	60	X	X	X	X	X	X	X	X	X	X	X	X	X	X	X	X	X	X	X	X	
DW9057	7.2	30	30	X	30	30	X	X	X	30	X	X	X	X	30	45	30	30	30	12	60	30	60	X	X	30	30	

\*BT - Bluetooth\*

NOTE: The Bluetooth® word mark and logos are registered trademarks owned by the Bluetooth® SIG, Inc. and any use of such marks by DeWALT is under license. Other trademarks and trade names are those of their respective owners.

"X" Indicates that the battery pack is not compatible with that specific charger. All charge times are approximate. Actual charge time may vary. Read the instruction manual for more specific information.

"X" indique que le bloc-piles n'est pas compatible avec ce chargeur. Les durées de charge sont approximatives; la durée de charge réelle peut varier. Lire le manuel d'utilisation pour obtenir des renseignements plus précis.

Una "X" indica que el paquete de baterías no es compatible con ese determinado cargador. El tiempo de duración de carga es aproximado; la duración de carga real puede variar. Lea el manual de instrucciones para obtener información más precisa.

\* Maximum initial battery voltage (measured without a workload) is 12 volts. Nominal voltage is 10.8.

\* La tension initiale maximum du bloc-piles (mesurée à vide) est de 12 volts. La tension nominale est de 10,8.

\* El máximo voltaje inicial de la batería (medido sin carga de trabajo) es 12 voltios. El voltaje nominal es de 10,8.

DEWALT Industrial Tool Co., 701 East Joppa Road, Towson, MD 21286

(NOV15) Part No. xxxxx DCT410, DCT411, DCT412 Copyright © 2010, 2011, 2013, 2015 DEWALT

The following are trademarks for one or more DEWALT power tools: the yellow and black color scheme; the "D" shaped air intake grill; the array of pyramids on the handgrip; the kit box configuration; and the array of lozenge-shaped humps on the surface of the tool.