

# CAS ToF Units & CAS Dual RF/ToF Units User Manual

Document No. DOCU0093, Rev. B



REVIEWED: By Akshat Shrey at 01:16PM, Apr 21, 2020

CREATED: By Abhijeet Deshmukh at 11:42 am, Apr 21, 2020

APPROVED: By Nagendra at 1:42 pm, Apr 21, 2020

**DOCU0093**  
**CAS ToF Units & CAS Dual RF/ToF Units User Manual**

---

© 2020 Wabtec Corporation. All rights reserved. The information contained in this publication is the property of Wabtec Corporation. This publication shall not be reproduced, redistributed, retransmitted, translated, abridged, adapted, condensed, revised or otherwise modified, in any form, in whole or in part, without the express written consent of Wabtec.

By accessing this, you agree that the information contained herein does not purport to cover all details or variations in Wabtec products or to provide for every possible contingency with installation, operation or maintenance. Should further information be desired or should particular problems arise that are not covered sufficiently for the user's purposes, the matter should be referred to Wabtec Corporation. Any applicable Federal, State or local regulations or company safety or operating rules must take precedence over any information or instructions given in the Technical Documentation. Wabtec has no obligation to keep the material up to date after the original publication.

WABTEC CORPORATION EXPLICITLY DISCLAIMS ALL WARRANTIES OF ACCURACY, MERCHANTABILITY OR FITNESS FOR ANY PURPOSE IN CONNECTION WITH THIS PUBLICATION AND USE THEREOF.

If you are not an authorized recipient of this publication, you are hereby notified that any perusal, use, distribution, copying or disclosure is strictly prohibited. If you have received this publication in error, please immediately return to Wabtec at the following address: Wabtec Corporation, Technical Publications Department, Building 14, 2901 East Lake Rd., Erie, PA 16531.

**Revision History**

<b>REV</b>	<b>DATE</b>	<b>BY</b>	<b>DESCRIPTION</b>
A	Jun 2019	ABD	Created Document for PROD0810 - CAS ToF HV UNIT. Added Internal Document Number as "GEK-115610"
B	Apr 2020	ABD	"Regulatory Information" updated. All CAS ToF & CAS Dual RF/ToF variants added.

Digital Mining Technology  
(Industrea Mining Technology Pty Ltd)  
3 Co-Wyn Close, Fountaindale, NSW 2258, Australia  
Telephone: +61 2 4336 1800  
Fax: +61 2 4389 2355  
Email: [enquiriesIMT@geindustrea.ge.com](mailto:enquiriesIMT@geindustrea.ge.com)  
Web: [www.getransportation.com/mining](http://www.getransportation.com/mining)

## \*\*\*IMPORTANT NOTICE\*\*\*

Followings are the registered business subsidiaries of Wabtec Corporation, referenced throughout this document:

1. "Digital Mining Technology" ("Industrea Mining Technology Pty Ltd")  
3 Co-Wyn Close, Fountaindale, NSW 2258, Australia
  
2. "Digital Mining"  
2901 East Lake Road,  
Erie, PA, 16531,  
(814) 875-2234.

**TABLE OF CONTENTS**

<b>Section</b>	<b>Page</b>
<b>1. GENERAL INFORMATION</b> .....	<b>1</b>
1.1. INTRODUCTION .....	1
1.2. ABBREVIATIONS .....	2
1.3. DEFINITIONS .....	3
1.4. COMPANY DETAILS .....	3
<b>2. SAFETY INFORMATION</b> .....	<b>4</b>
<b>3. LOGISTICS</b> .....	<b>6</b>
3.1. TRANSPORT .....	6
3.2. STORAGE OF EQUIPMENT .....	6
3.3. UNPACKING OF EQUIPMENT .....	6
<b>4. TECHNICAL SPECIFICATIONS</b> .....	<b>7</b>
4.1. CAS TOF UNITS & CAS DUAL RF/TOF UNITS - TECHNICAL SPECIFICATIONS .....	7
4.2. LED INTERFACE .....	8
4.3. CAS ToF UNIT COMPONENTS .....	10
4.4. CAS DUAL RF/ToF UNIT COMPONENTS .....	11
<b>5. OVERVIEW</b> .....	<b>12</b>
5.1. PRODUCT DESCRIPTION .....	12
5.2. PRINCIPLE OF OPERATION .....	13
5.3. SCREEN ELEMENTS .....	14
5.4. ToF DETECTORS .....	15
5.5. INTERCONNECTION-4 CAS-CAM/ToF .....	16
<b>6. INSTALLATION, TEST AND COMMISSION</b> .....	<b>17</b>
6.1. INSTALLATION .....	17
6.2. TEST AND COMMISSION .....	17
<b>7. SERVICE AND MAINTENANCE</b> .....	<b>18</b>
7.1. EQUIPMENT SERVICE .....	18
7.1.1. System .....	18
7.1.2. Scheduled System Servicing .....	18
7.1.3. Software Updates .....	18
7.2. EQUIPMENT MAINTENANCE .....	18
<b>8. TROUBLESHOOTING</b> .....	<b>19</b>
8.1. ToF PROBLEMS .....	19
<b>9. DECOMMISSION AND DISPOSAL</b> .....	<b>20</b>
9.1. DECOMMISSION PROCEDURE .....	20
9.2. DISPOSAL .....	20

<b>10. AUTHORIZED REPRESENTATIVES</b> .....	<b>21</b>
10.1. BRAZIL .....	21
10.2. SUB SAHARA AFRICA .....	21
10.3. INDONESIA .....	21
10.4. CANADA .....	22
10.5. NORTH AMERICA .....	22
10.6. AUSTRALIA .....	22
10.7. MEXICO .....	23
10.8. INDIA .....	23
<b>11. WARRANTY TERMS</b> .....	<b>24</b>
<b>12. REGULATORY INFORMATION</b> .....	<b>25</b>
12.1. DECLARATION OF CONFORMITY WITH FCC RULES FOR ELECTROMAGNETIC COMPATIBILITY .....	25
12.1.1. FCC Interference Statement for Class B devices .....	26
12.1.2. Federal Communication Commission (FCC) - Radiation Exposure Statement. .	26
12.2. INDUSTRY CANADA COMPLIANT .....	26
12.2.1. Concerning Radio Transmitters. ....	26
12.2.2. Industry Canada - Radiation Exposure Statement .....	26
12.2.3. Detachable Antenna: .....	26
12.2.4. Industrie Canada – Déclaration sur l'exposition aux radiations. ....	27
12.2.5. Conforme aux normes d'INDUSTRIE CANADA .....	27
12.2.6. Au sujet des émetteurs radio. ....	27
12.2.7. Antennes détachables: .....	27
12.3. AUSTRALIAN RADIO COMMUNICATIONS EQUIPMENT - RADIATION EXPOSURE STATEMENT .....	27
<b>13. INTERNATIONAL APPROVALS</b> .....	<b>28</b>
13.1. CAS TOF UNITS - INTERNATIONAL CERTIFICATIONS .....	28
13.2. CAS DUAL RF/TOF UNITS - INTERNATIONAL CERTIFICATIONS .....	29
<b>14. LIFE SUPPORT POLICY</b> .....	<b>30</b>
14.1. ELECTROMAGNETIC INTERFERENCE / COMPATIBILITY .....	30
14.2. POTENTIALLY EXPLOSIVE ATMOSPHERES .....	30

**LIST OF FIGURES**

<b>Figure</b>		<b>Page</b>
1	CAS ToF Unit Components . . . . .	10
2	CAS Dual RF/ToF Unit Components . . . . .	11
3	Time of Flight Distance Measurement Algorithm . . . . .	13
4	Screen Elements . . . . .	14
5	ToF Detector Screen . . . . .	15
6	Interconnection of CAS-CAM/ToF . . . . .	16
7	ToF Communication Status . . . . .	19

**LIST OF TABLES**

<b>Table</b>		<b>Page</b>
1	CAS ToF Unit & CAS Dual RF/ToF Unit Variants Details . . . . .	1
2	Abbreviations . . . . .	2
3	Definitions . . . . .	3
4	CAS ToF Units & CAS Dual RF/ToF Units - Technical Specification Details . . . . .	7
5	CAS ToF Units & CAS Dual RF/ToF Units - LED Interface . . . . .	8
6	CAS ToF Units Model No. & Certification No. . . . .	28
7	CAS Dual RF/ToF Units Model No. & Certification No. . . . .	29

## 1. GENERAL INFORMATION

### 1.1. INTRODUCTION

This user manual provides information of the CAS ToF unit & CAS Dual RF/ToF Unit and its variants, overview, installation, operation, key components, service, troubleshooting, decommission and disposal of units.

Refer to Table 1 for the Various types of CAS ToF unit & CAS Dual RF/ToF Unit:

**Table 1. CAS ToF Unit & CAS Dual RF/ToF Unit Variants Details**

PRODUCT NUMBER	PRODUCT NAME	USAGE /APPLICATION
PROD0810	CAS ToF HV UNIT	Suitable for mounting on the exterior of heavy mine vehicles
PROD0811	CAS ToF LV UNIT	Suitable for mounting on the exterior of light mine vehicles
PROD0813	CAS ToF LV BATTERY UNIT	Unit with installed battery - Suitable for mounting on the exterior of light mine vehicles
PROD0814	CAS ToF TEST UNIT	Suitable as a test unit for CAS ToF
PROD0815	CAS ToF STATIONARY OBJECT UNIT	Suitable as a stationary object unit for CAS ToF
PROD0821	CAS ToF HV SINGLE UNIT	Single RF unit - Suitable for mounting on the exterior of heavy mine vehicles
PROD0822	CAS ToF LV VISITOR UNIT	Visitor Unit - Suitable for temporary installation on light vehicles
PROD0799	CAS DUAL RF/ToF HV UNIT	Dual RF Unit - Suitable for mounting on the exterior of heavy mine vehicles
PROD0800	CAS DUAL RF/ToF LV UNIT	Dual RF Unit - Suitable for mounting on the exterior of light mine vehicles
PROD0802	CAS DUAL LV VISITOR UNIT	Dual RF Unit - Suitable for temporary installation on light vehicles
PROD0806	CAS DUAL RF/ToF TEST UNIT	Dual RF Unit - Suitable as a test unit for CAS Dual RF/ToF with fixed installation
PROD0807	CAS DUAL RF/ToF STATIONARY OBJECT UNIT	Dual RF Unit - Suitable as a stationary object unit for CAS Dual RF/ToF
PROD0825	CAS DUAL RF/ToF LV UNIT WITH BATTERY	Dual RF Unit with installed battery - Suitable for mounting on the exterior of light mine vehicles



## 1.2. ABBREVIATIONS

The following abbreviations are used in the text, figures and tables throughout this manual.

**Table 2. Abbreviations**

<b>ABBREVIATION</b>	<b>MEANING</b>
IVU	In Vehicle Unit
GPS	Global Positioning System
CAS	Collision Avoidance System
OEM	Original Equipment Manufacturer
ToF	Time of Flight
LV	Light Vehicle
HV	Heavy Vehicle
MV	Medium Vehicle
RF	Radio Frequency
ISM	Industrial, Scientific & Medical

### 1.3. DEFINITIONS

**Table 3. Definitions**

TERM	DEFINITION
System	Refers to the assembled and installed operational elements which together perform the desired functionality.
System Components	Refers to the individual single elements which when assembled together at the point of installation form the "system". Each of these elements has a unique part number.

### 1.4. COMPANY DETAILS

Digital Mining Technology  
(Industrea Mining Technology Pty Ltd)  
3 Co-Wyn Close, Fountaindale, NSW 2258, Australia  
Telephone: +61 2 4336 1800  
Fax: +61 2 4389 2355  
Email: [enquiriesIMT@geindustrea.ge.com](mailto:enquiriesIMT@geindustrea.ge.com)  
Web: [www.getransportation.com/mining](http://www.getransportation.com/mining)

## 2. SAFETY INFORMATION

The safety section includes safety precautions which must be observed when working on items that appear throughout the publication. Examples of safety precautions and labels are outlined below:

 **DANGER** *Indicates an imminently hazardous situation which, if not avoided, will result in death or serious injury.*

 **WARNING** *Indicates a potentially hazardous situation which, if not avoided, could result in death or serious injury.*

 **CAUTION** *Indicates a potentially hazardous situation which, if not avoided, may result in minor or moderate injury.*

 **CAUTION** *Indicates a potential for equipment damage.*

### Summary of Warnings:

All local safety requirements should be reviewed before beginning the operation work and should be followed. Safety precautions that must be observed when working on the CAS ToF appear throughout in this publication.

 **WARNING** *The CAS product is a driver's aid and should not be relied upon as the primary means of reducing the risks of high potential interactions. Interaction include between Heavy Vehicles, Light Vehicles, infrastructure and personnel.*

 **WARNING** *GPS based proximity detection may not operate when satellites are not fully visible in the sky (e.g. in a deep mining pit near a high-wall or under a workshop roof). Consideration should be given to supplementing GPS with RF proximity detection and visual aids using cameras.*

 **WARNING** *Alarm logic should be determined via site specific risk assessment based on the end-users specified high risk interactions.*

 **WARNING** *The CAS product does not take control of the vehicle although it can provide inhibit signals to prevent movement from a stationary position implementation will require approval from the vehicle OEM, vehicle owner and GE and a detailed risk assessment conducted.*

**⚠ WARNING**

*The CAS ToF system & CAS Dual RF/ToF Unit systems consists of various components including an in vehicle unit and personnel tag all of which are equipped with multiple radio transmitters. AS2187-2:2006 table I1, recommends a safe operating distance from any designated blasting area as greater than 20 meters. AS2187-2:2006 table I1 is an Australian Standard and operators and users should have regard to all relevant and applicable standards, which may apply within the country of use. Operators and users should also have regard to all detonator and blasting contractor and manufacturer recommendations and all applicable safety and operational procedures applicable at the site, where the CAS ToF System is used and which relate to safe operating distances. Details of operating frequency and output power of the various CAS ToF System components are set out in the CAS ToF specification and user documentation. Operators and users should make their own assessment in this regard.*

### 3. LOGISTICS

This section describes the product unit transport, storage and Unpacking details.

#### 3.1. TRANSPORT

All possible precautions are taken to protect the equipment against damage or losses during shipment, however before accepting delivery, check all the items against the packing list or bill of lading. If there are shortages or evidence of physical damage, notify Wabtec Digital Mining Technology immediately.

**NOTE: Notify Wabtec Digital Mining Technology within 7 days (maximum) in case of shortages or discrepancies, according to the packing list. This action will help ensure a speedy resolution to any perceived problems. Keep a record of all claims and correspondence. Photographs are recommended.**

#### **CAUTION**

***Do not remove protective covers prior to installation unless there are indications of damage.***

**NOTE: Boxes opened for inspection and inventory should be carefully repacked to ensure protection of the contents or else the parts should be packaged and stored in a safe place.**

**NOTE: Examine all packing boxes, wrappings and covers for items attached to them, especially if the wrappings are to be discarded.**

#### 3.2. STORAGE OF EQUIPMENT

Where the equipment is not to be installed immediately, proper storage is important to ensure protection of equipment and validity of warranty.

**NOTE: All equipment should be stored indoors protected from the elements in a cool dry area.**

#### **CAUTION**

***If storing on the ground, ensure that the storage area is not an area where water will collect.***

#### 3.3. UNPACKING OF EQUIPMENT

The method of packing used will depend on the size and quantity of equipment.

***Take care when unpacking the equipment to avoid damage.***

#### **CAUTION**

***Take care when unpacking the equipment to avoid damage.***

## 4. TECHNICAL SPECIFICATIONS

### 4.1. CAS TOF UNITS & CAS DUAL RF/TOF UNITS - TECHNICAL SPECIFICATIONS

Refer to the below Table 4 for the technical specifications of various CAS ToF units & CAS Dual RF/ToF Units.

**Table 4. CAS ToF Units & CAS Dual RF/ToF Units - Technical Specification Details**

Product	Description	Power In			Serial Ports			Radio		Features			Power consumption (1.2 W nominal)	Operating temperature (-20° C to +60° C)	Protecting Rating (IP66)	Weight (1.5 kg)
		12V From Vehicle	12V from Parent CAS System	12V from Mains Charger	RS485	RS232	Video Pass-Through	433 MHz	2.4 GHz: 1 Antenna or 2 Antenna Diversity	External LED Indicators	(74Wh) Battery Internal Li-Ion 3.7V 20Ah					
PROD0799	CAS DUAL RF/TOF HV UNIT	-	√	-	√	-	√	√	1	2	-	√	√	√	√	
PROD0800	CAS DUAL RF/TOF LV UNIT	√	-	-	-	√	-	√	1	2	-	√	√	√	√	
PROD0802	CAS DUAL LV VISITOR UNIT	√	-	√	-	√	-	√	1	4	√	√	√	√	√	
PROD0806	CAS DUAL RF/TOF TEST UNIT	-	√	-	-	√	-	√	1	1	-	√	√	√	√	
PROD0807	CAS DUAL RF/TOF STATIONARY OBJECT UNIT	-	√	-	-	√	-	√	1	1	-	√	√	√	√	
PROD0825	CAS DUAL RF/TOF LV UNIT WITH BATTERY	√	-	-	-	√	-	√	1	2	√	√	√	√	√	
PROD0810	CAS TOF HV UNIT	-	√	-	√	-	√	-	2	1	-	√	√	√	√	
PROD0811	CAS TOF LV UNIT	√	-	-	-	√	-	-	2	1	-	√	√	√	√	
PROD0813	CAS TOF LV BATTERY UNIT	√	-	-	-	√	-	-	2	1	√	√	√	√	√	
PROD0814	CAS TOF TEST UNIT	-	√	-	-	√	-	-	2	1	-	√	√	√	√	
PROD0815	CAS TOF STATIONARY OBJECT UNIT	-	√	-	-	√	-	-	2	1	-	√	√	√	√	
PROD0821	CAS TOF HV SINGLE UNIT	-	√	-	√	-	√	-	2	1	-	√	√	√	√	
PROD0822	CAS TOF LV VISITOR UNIT	√	-	√	-	√	-	-	2	3	√	√	√	√	√	

## 4.2. LED INTERFACE

Refer to the below Table 5 for the LED interface of various CAS ToF units & CAS Dual RF/ToF Units.

**Table 5. CAS ToF Units & CAS Dual RF/ToF Units - LED Interface**

LED INTERFACE			
<b>PROD0799, PROD0800, PROD0806, PROD0825</b>			
LED	INDICATION		CONDITION
433 MHz Tx/Rx	GREEN	FLASHING	433 MHz Tx/Rx communication
	BLUE	FLASHING	Antenna Cable NOT Connected
2.4 GHz Tx/Rx	RED	FLASHING	2.4 GHz Tx/Rx communication
	BLUE	FLASHING	Antenna Cable NOT Connected
<b>PROD0802</b>			
LED	INDICATION		CONDITION
433 MHz Tx/Rx	GREEN	FLASHING	433 MHz Tx/Rx communication
	BLUE	FLASHING	Antenna Cable NOT Connected
2.4 GHz Tx/Rx	RED	FLASHING	2.4 GHz Tx/Rx communication
	BLUE	FLASHING	Antenna Cable NOT Connected
Battery Charging	GREEN	ON	Battery Charging
	GREEN	FLASHING	Battery Fault
	OFF	OFF	Fully Charged when External Power LED Blue
External Power	OFF		Running on battery power/external power off
	BLUE	ON	External Power present
<b>PROD0810, PROD0821</b>			
LED	INDICATION		CONDITION
2.4 GHz Tx/Rx	RED	FLASHING	2.4 GHz Tx/Rx communication
	BLUE	FLASHING	Antenna Cable NOT Connected/ Bus-Out connector Disconnected
<b>PROD0811, PROD0813, PROD0814, PROD0815</b>			
LED	INDICATION		CONDITION
2.4 GHz Tx/Rx	RED	FLASHING	2.4 GHz Tx/Rx communication
	BLUE	FLASHING	Antenna Cable NOT Connected

**Table 5. CAS ToF Units & CAS Dual RF/ToF Units - LED Interface (Continues)**

<b>LED INTERFACE</b>			
<b>PROD0822</b>			
<b>LED</b>	<b>INDICATION</b>		<b>CONDITION</b>
2.4 GHz Tx/Rx	RED	FLASHING	2.4 GHz Tx/Rx communication
	BLUE	FLASHING	Antenna Cable NOT Connected
Battery Charging	GREEN	ON	Battery Charging
	GREEN	FLASHING	Battery Fault
	OFF	OFF	Fully Charged when External Power LED Blue
External Power	OFF		Running on battery power/external power off
	BLUE	ON	External Power present



### 4.3. CAS ToF UNIT COMPONENTS

Refer to Figure 1 for the components of CAS ToF units.

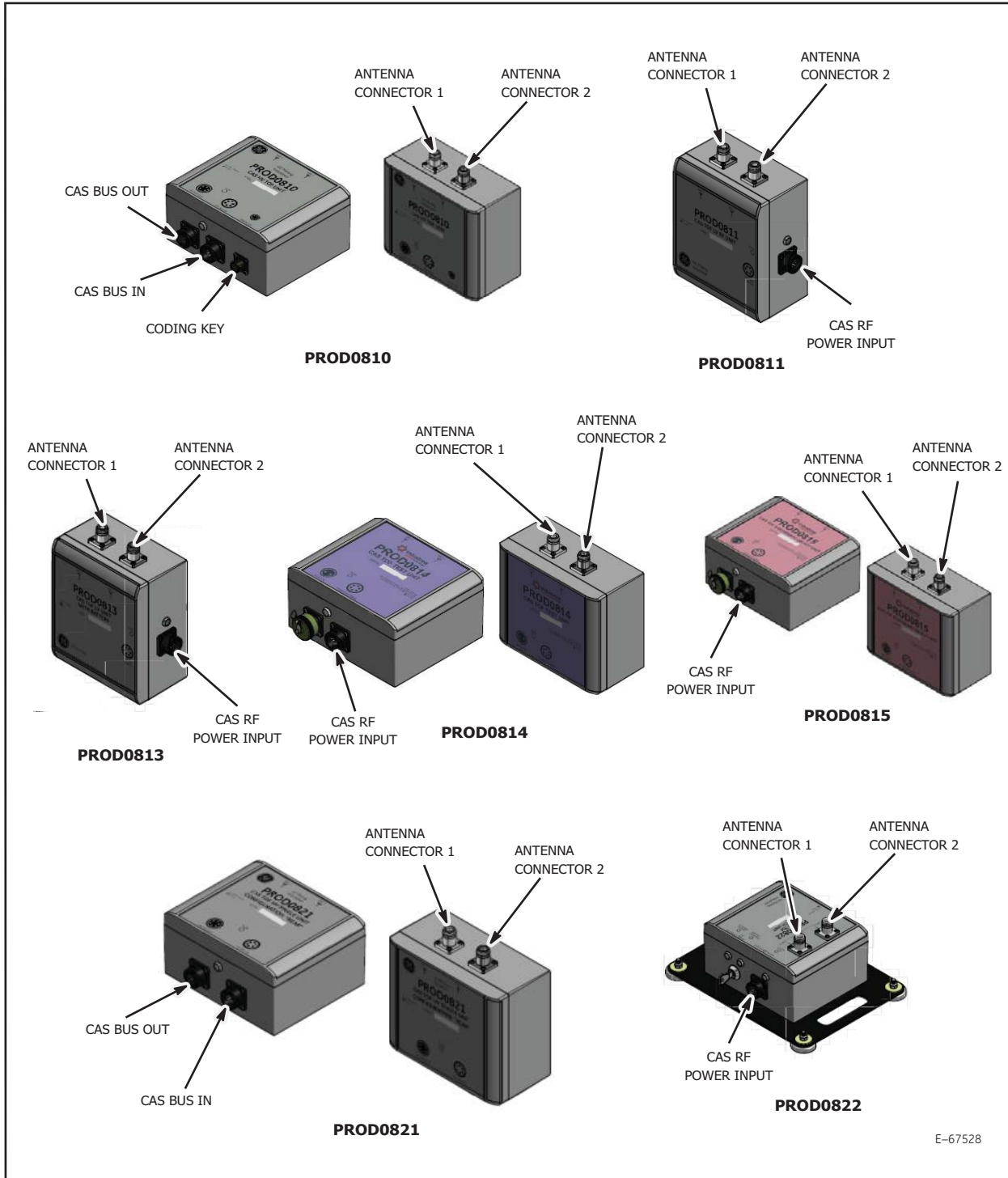

Figure 1. CAS ToF Unit Components

### 4.4. CAS DUAL RF/ToF UNIT COMPONENTS

Refer to Figure 2 for the components of CAS Dual RF/ToF units.

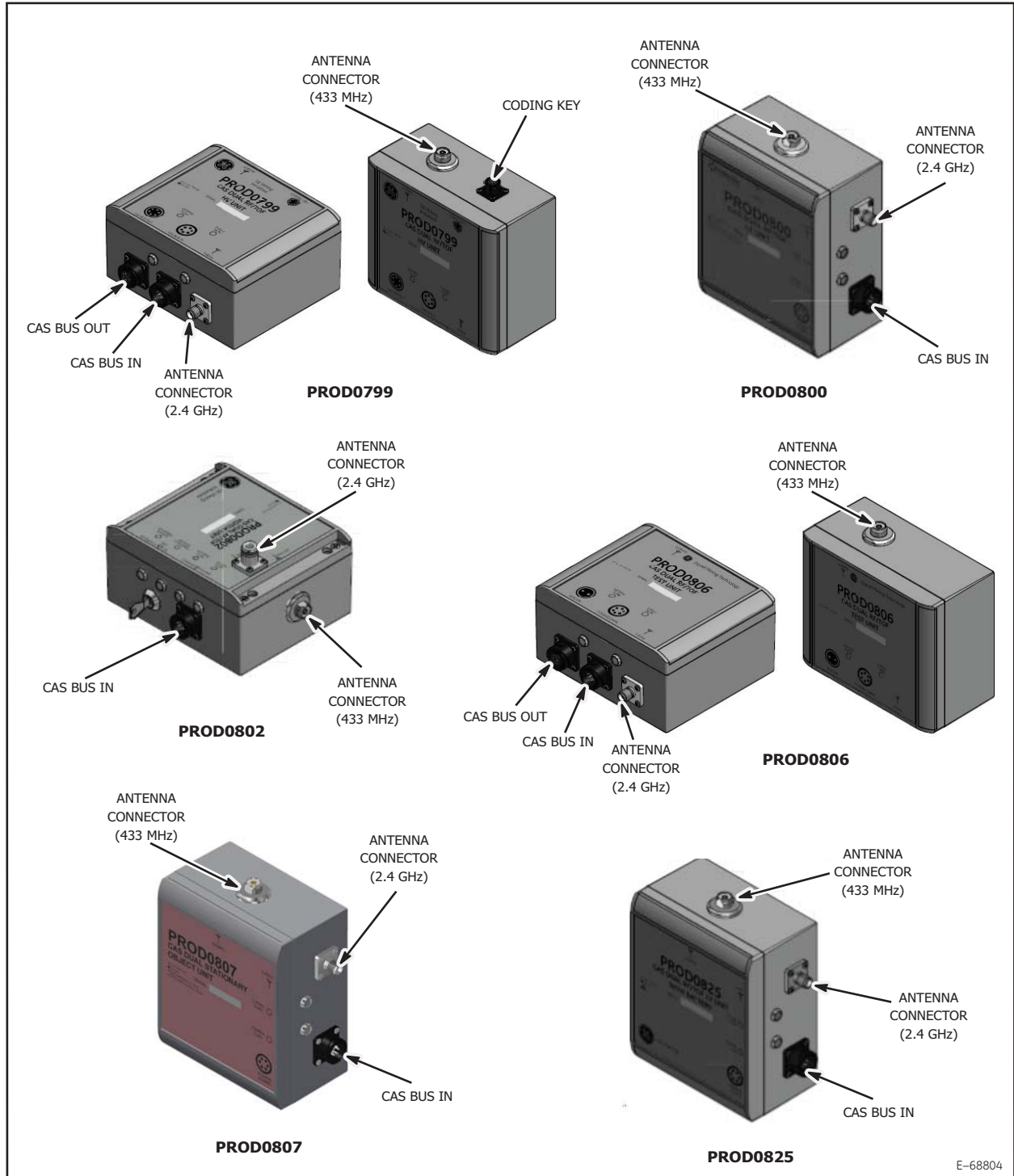

Figure 2. CAS Dual RF/ToF Unit Components

E-68804

## **5. OVERVIEW**

### **5.1. PRODUCT DESCRIPTION**

CAS ToF units and CAS Dual RF/ToF Units, when incorporated with a CAS-GPS system on a vehicle, add an additional layer of protection to the operator's collision awareness system by providing accurate distance measurement techniques between the operator and interacting fleet. This additional functionality within a CAS-GPS system is designed to mitigate possible location errors that are present in a GPS based tracking system due to environmental conditions and further improves relative position accuracy of the location system as a whole.

The CAS ToF units and CAS Dual RF/ToF Units come in a variety of models to suit the specific installation, which include models designed for commercial light vehicles, heavy machinery and vehicles, stationary objects and portable Battery operated products for visitor vehicles.

The CAS ToF and CAS Dual RF/ToF products are built into robust IP66 rated metal enclosures designed for mounting onto the exterior of plant equipment and designed to endure the harsh environmental conditions found in commercial mining operations.

For larger mobile machinery where operators often have a limited field of view, the CAS-GPS heavy vehicle system is designed to allow for an array of CAS ToF products to be located around the vehicle perimeter which adds the additional relative incoming direction and distance of the interacting fleet and can display the information on the operator's CAS-GPS screen and will trigger warnings and alarms when potential threats of collision are eminent. When this CAS ToF array is paired with the CAS-CAM camera product range, the camera vision can be automatically switched to view the blind spot where the interaction of the incoming signal source is occurring and the real-time vision can be viewed on the operator's CAS-GPS screen.

## 5.2. PRINCIPLE OF OPERATION

The CAS ToF units use a 2.4 GHz ISM band short range device radio transceiver for sending and receiving data amongst the locally equipped fleet within radio range. CAS Dual RF/ToF units uses 433 MHz and 2.4 GHz ISM band short range device radio transceiver for sending and receiving data amongst the locally equipped fleet within radio range. For CAS ToF units the transmissions between units comprises a complex form of radio frequency modulation. Figure 3 shows the basic sequence of events and resulting calculations between two CAS ToF products when evaluating distance based on the Time of Flight signal interactions. The transmit and response data sent between the two devices contains additional data information including vehicle identifiers, processing times and correction factors.

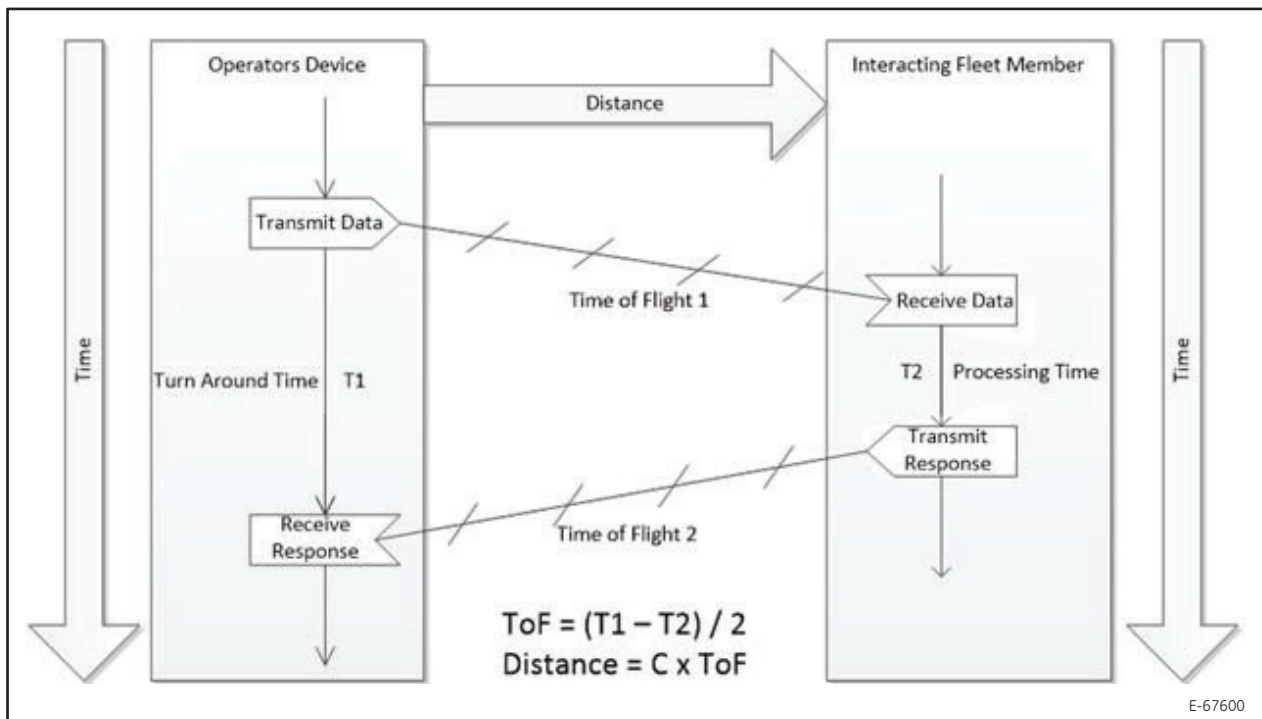





Figure 3. Time of Flight Distance Measurement Algorithm

Multi-path reflections when measuring a ToF (Time of Flight) signal could introduce a measure of inaccuracy to the principle operation of the device. To combat this anomaly each CAS ToF unit is equipped with dual antennas operating in a diversity configuration for improved accuracy and design robustness in difficult environments susceptible to radio signal multi-path reflections.

### 5.3. SCREEN ELEMENTS

Refer to Figure 4 for screen elements of CAS-GPS.

THE FOLLOWING ICONS WILL BE OBSERVED BY THE USER ON THE SCREEN OF CAS-GPS DISPLAY UNIT, WHEN THE CAS ToF UNIT IS INSTALLED AS PART OF THE SYSTEM

ICON	STATUS INDICATION
	GREEN - COMMUNICATING WITH OTHER VEHICLES - NO FAULTS.
	YELLOW - NO OTHER VEHICLES IN RANGE - NO FAULTS.
	RED - RADIO ERROR - FAULT OR ERROR DETECTED.

E-67524

Figure 4. Screen Elements

### 5.4. ToF DETECTORS

The following example shows a truck traveling forward at 6km/h with the front camera selected. As a vehicle fitted with ToF proximity (only) approaches from the RHS the right camera will automatically be selected and the quadrant highlighted to indicate a vehicle is within the pre-configured distance (30m in this example). Refer to Figure 5.

**NOTE: No icon is presented on the screen, but the vehicles ID appears in the table.**

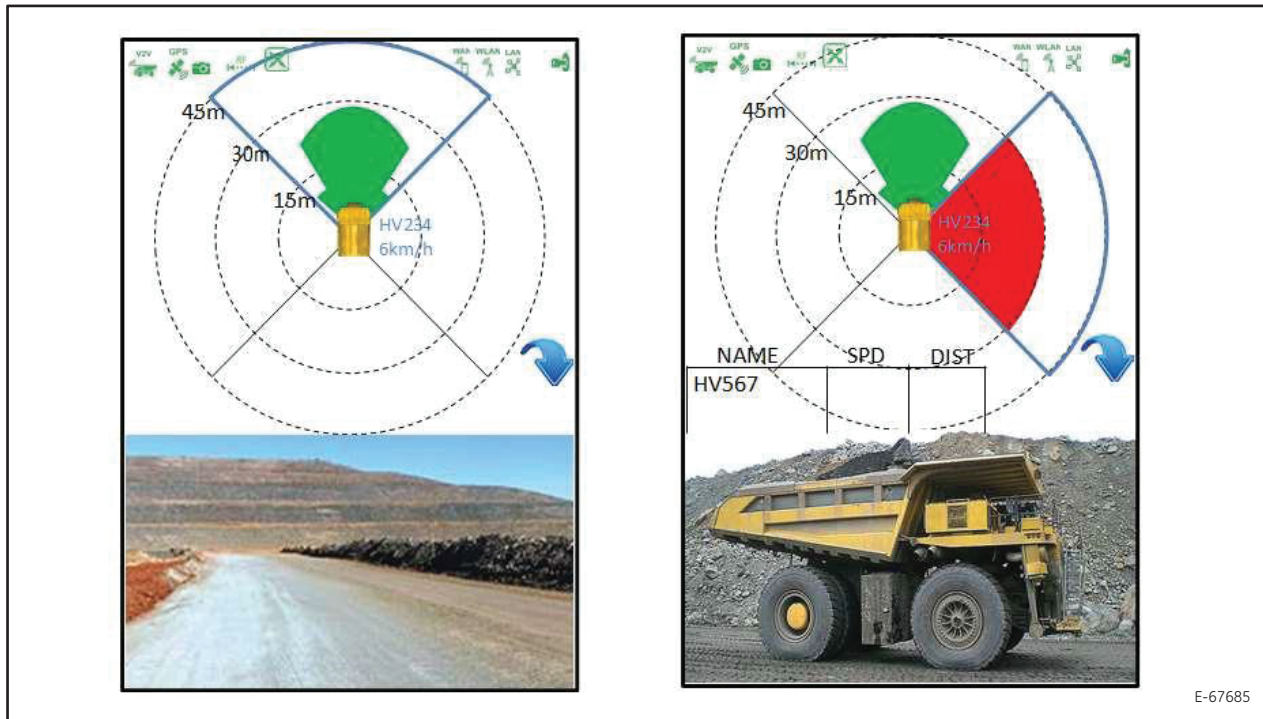

Figure 5. ToF Detector Screen

### 5.5. INTERCONNECTION-4 CAS-CAM/ToF

Refer to Figure 6 for interconnection-4 CAS-CAM/ToF and its details.

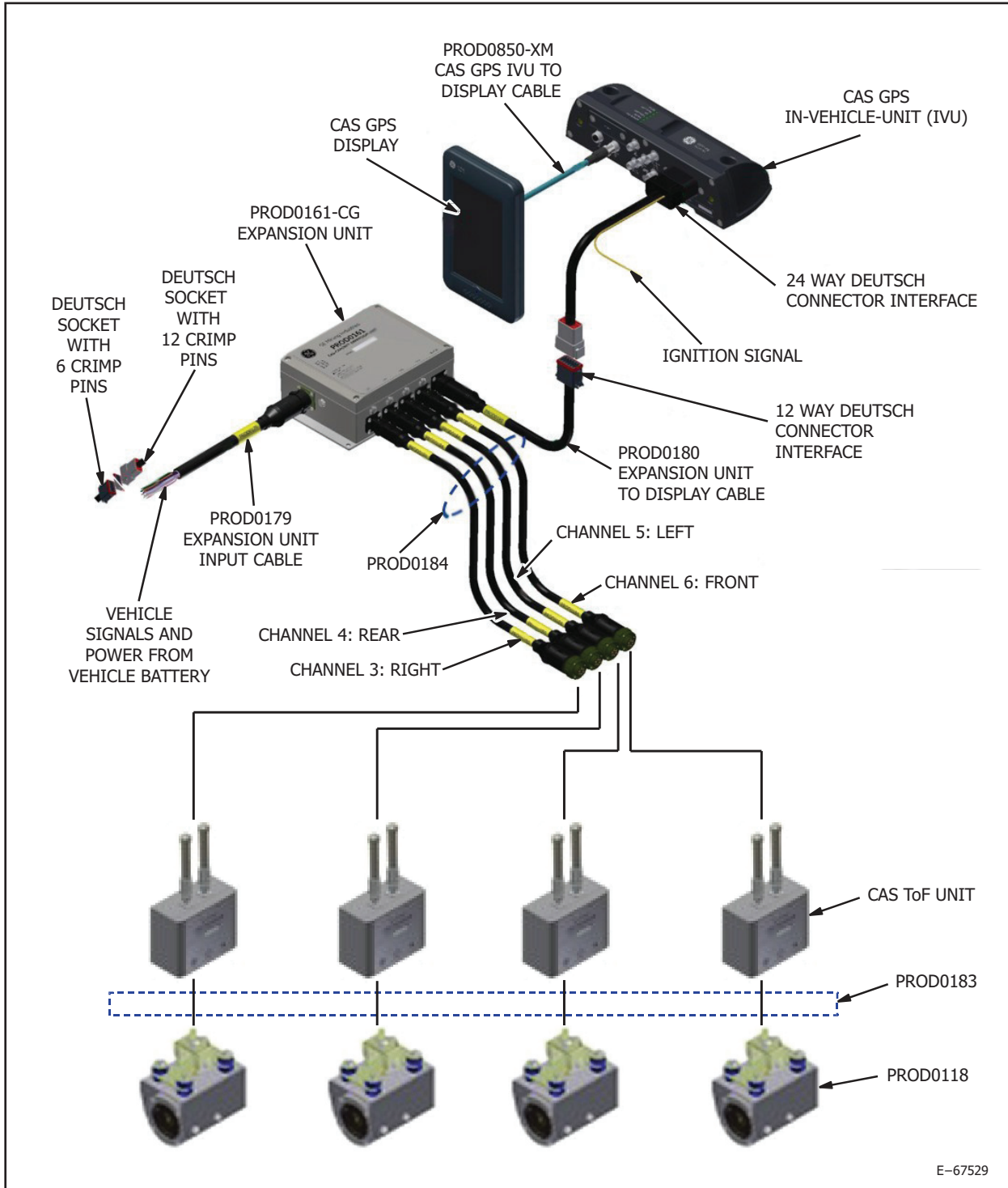

Figure 6. Interconnection of CAS-CAM/ToF

E-67529

## **6. INSTALLATION, TEST AND COMMISSION**

### **6.1. INSTALLATION**

Installation should be in accordance with the installation procedures defined by Wabtec Digital Mining Technology and only performed by authorized and qualified installers.

### **6.2. TEST AND COMMISSION**

At installation the system will be tested, to ensure that electrically and functionally the system is correctly installed. After passing its final installation test, the system must be ready for use after which inbuilt self-diagnostic testing combined with daily user monitoring ensures that any faults can be acted upon.



## 7. SERVICE AND MAINTENANCE

This section describes the service and maintenance of CAS ToF and CAS Dual RF/ToF systems:

### 7.1. EQUIPMENT SERVICE

This section covers the servicing of various parts of CAS ToF and CAS Dual RF/ToF systems.

#### 7.1.1. System

- Check visually that all antennas are in good condition and the antenna cables are connected.
- Check visually that no cables are loose or damaged.
- Verify that the system is working correctly by starting the vehicle, prior to starting the field operation.

#### 7.1.2. Scheduled System Servicing

It is recommended that the system undergo preventative scheduled maintenance and inspections. These should be carried out by trained and authorized personnel for every 6 months or 1500hrs (whichever occurs first).

#### 7.1.3. Software Updates

Software updates are automatically pushed out to all CAS-GPS Host products connected to the CAS-WEB servers.

## 7.2. EQUIPMENT MAINTENANCE

If the systems is not functioning as expected, refer to section 8., TROUBLESHOOTING. If a fault cannot be resolved, please contact your nearest authorized representative.

***NOTE: It is essential that no attempt to be made to repair the equipment (other than replacement of individual components). Opening equipment enclosures should never be attempted and will void any warranty and could compromise the safe operation of the system.***

## 8. TROUBLESHOOTING

### 8.1. ToF PROBLEMS

ToF

The Time of Flight communication status is indicated by the color of the  icon (refer to Figure 4) at the top of the display. For basic fault-finding techniques refer the Figure 7.

- Green – Communicating with other vehicles – no faults.
- Yellow – No other vehicles in range – no faults.
- Red – Radio error – fault or error detected.

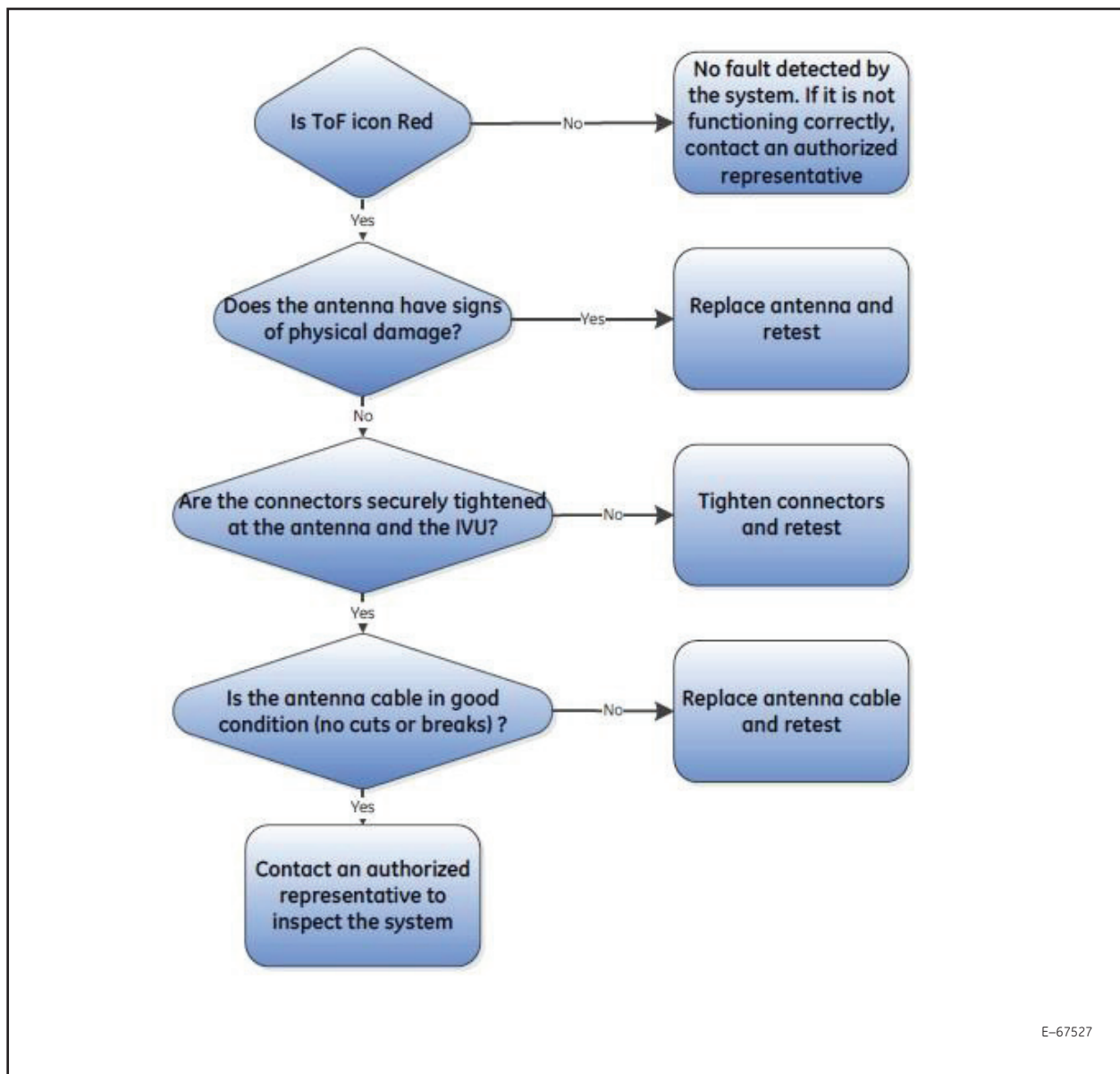

E-67527

Figure 7. ToF Communication Status

## 9. DECOMMISSION AND DISPOSAL

This section describes the decommission and disposal procedure.

### 9.1. DECOMMISSION PROCEDURE

1. Removal of the system should only be performed if authorized by the owner of the vehicle.
2. Removal should be performed by a qualified Auto Electrician.
3. All system components and wiring should be removed.
4. All vehicle wiring should be restored back to original condition.
5. Dispose or store removed system in accordance with this manual.

### 9.2. DISPOSAL

The electronic equipment discussed in this manual must not be treated as general waste. By ensuring that this product is disposed of correctly, you will be helping to prevent potentially negative consequences for the environment and human health which could otherwise be caused by incorrect waste handling of this product.

The system should be disposed of in accordance with local regulations.



#### **WARNING**

*The system contains a Lithium Ion Battery and should be disposed of in accordance with local regulations.*

## 10. AUTHORIZED REPRESENTATIVES

### 10.1. BRAZIL

The address of Brazil representatives:



#### **Wabtec Brasil Fabricação e Manutenção de Equipamentos Ltda**

Avenida General David Sarnoff, n 4600

Cidade Industrial

Contagem, MG 32210-110

Brazil

P: +55 31 2103 5348

F: +55 31 2103 5100

[www.wabteccorp.com](http://www.wabteccorp.com)

### 10.2. SUB SAHARA AFRICA

The address of Sub Sahara Africa representatives:



#### **Probe Integrated Mining Technologies (PTY) Ltd**

245 Albert Amon Road

Meadowdale Germiston 1614

P: +27 11 453 0924

F: +27 11 453 2141

[www.probebattery.co.za](http://www.probebattery.co.za)

### 10.3. INDONESIA

The address of Indonesia representatives:



PT Intecs Teknikatama Industri

Jl. Ciputat Raya No. 18D Kebayoran Lama Selatan

Jakarta 12240.

P: +62 21 729 3351

F: +62 21 729 3352

[www.intecs.co.id](http://www.intecs.co.id)

## 10.4. CANADA

The address of Canada representatives:



### **Wabtec Transportation Canada Inc**

27047 Oakwood Road, Oakbank, Manitoba,  
R0E 1J2 Canada  
P: +1 905 251 0074  
[www.wabteccorp.com](http://www.wabteccorp.com)

## 10.5. NORTH AMERICA

The address of North America representatives:



### **Digital Mining**

2901 East Lake Road, Erie,  
Pennsylvania, 16531, US  
P: +1 (814) 875-2234  
[www.wabteccorp.com](http://www.wabteccorp.com)

## 10.6. AUSTRALIA

The address of Australia representatives:



### **Industrea Mining Technology Pty Ltd**

3 Co-Wyn Close, Fountaindale,  
NSW, 2258, Australia  
P: +612 4336 1800  
F: +612 4389 2355  
[www.wabteccorp.com](http://www.wabteccorp.com)

## 10.7. MEXICO

The address of Mexico representatives:



### **COMERCIALIZADORA MINERA DEL NORTE, S.A. DE C.V.**

Ave. H. Colegio Militar No. 2000-B Col. Las Fuentes

Piedras Negras, Coahuila

México. C.P. 26010.

P: +52 (878) 783-8215 / +1 (830) 352-5519

F: +52 (878) 783-8218

[www.cominsa.com.mx](http://www.cominsa.com.mx)

## 10.8. INDIA

The address of India representatives:



GE Transportation

a Wabtec company

### **GE Transportation India (Wabtec Company) Pvt Ltd**

A-18, First Floor

Okhla Industrial Area Phase II

New Delhi - 110020, India

P: +91 124 4808776

F: +91 124 490 6933

[www.getransportation.com](http://www.getransportation.com)

## 11. WARRANTY TERMS

### **Equipment and Parts:**

The warranty period for equipment and parts is 15 months from delivery, or 12 months from when system is placed in service (whichever occurs first). Modifications to this product without written consent from the manufacturer or its designated authorized representatives will void all warranty obligations.

12. REGULATORY INFORMATION



**WARNING**

*Modifications to this product without written consent from the manufacturer or its designated authorized representatives could void the user's authority to operate the equipment.*

12.1. DECLARATION OF CONFORMITY WITH FCC RULES FOR ELECTROMAGNETIC COMPATIBILITY

Supplier's Declaration of Conformity 47 CFR § 2.1077 Compliance Information	
MAKE:	CAS TOF UNIT
FCC ID:	YIY-CASTOF
Unique Identifier:	PROD0810, CAS TOF HV UNIT PROD0811, CAS TOF LV UNIT PROD0813, CAS TOF LV WITH BATTERY RF UNIT
Responsible Party:	Digital Mining 2901 East Lake Road Erie, PA 16531 (814) 875-2234
FCC Compliance Statement: This device complies with Part 15 of the FCC Rules. Operation is subject to the following two conditions: (1) This device may not cause harmful interference, and (2) this device must accept any interference received, including interference that may cause undesired operation.	



### **12.1.1. FCC Interference Statement for Class B devices**

This equipment has been tested and found to comply with the limits for a Class B digital device, pursuant to part 15 of the FCC Rules. These limits are designed to provide reasonable protection against harmful interference in a residential installation. This equipment generates, uses and can radiate radio frequency energy and, if not installed and used in accordance with the instructions, may cause harmful interference to radio communications. However, there is no guarantee that interference will not occur in a particular installation. If this equipment does cause harmful interference to radio or television reception, which can be determined by turning the equipment off and on, the user is encouraged to try to correct the interference by one or more of the following measures:

- Reorient or relocate the receiving antenna.
- Increase the separation between the equipment and receiver.
- Connect the equipment into an outlet on a circuit different from that to which the receiver is connected.
- Consult the dealer or an experienced radio/TV technician for help.

### **12.1.2. Federal Communication Commission (FCC) - Radiation Exposure Statement**

To comply with FCC RF exposure limits for general population / uncontrolled exposure, the antennas used for this transmitter must be installed to provide a separation distance of at least 20 cm from all persons and must not be co-located or operating in conjunction with any other antenna or transmitter.

## **12.2. INDUSTRY CANADA COMPLIANT**

This Class B digital apparatus complies with Canadian ICES-003. Changes or modifications not expressly approved by the party responsible for compliance could void the user's authority to operate the equipment.

### **12.2.1. Concerning Radio Transmitters**

This device complies with Industry Canada's license-exempt RSSs.

Operation is subject to the following two conditions:

1. This device may not cause interference; and
2. This device must accept any interference, including that may cause undesired operation of the device.

### **12.2.2. Industry Canada - Radiation Exposure Statement**

To comply with Industry Canada RF exposure limits for general population / uncontrolled exposure, the antennas used for this transmitter must be installed to provide a separation distance of at least 20 cm from all persons and must not be co-located or operating in conjunction with any other antenna or transmitter.

### **12.2.3. Detachable Antenna:**

This radio transmitter has been approved by Industry Canada to operate with the antenna types listed in the installation manual with the maximum permissible gain and required antenna impedance for each antenna type indicated. Antenna types not included in this list, having a gain greater than the maximum gain indicated for that type, are strictly prohibited for use with this device.

#### **12.2.4. Industrie Canada – Déclaration sur l'exposition aux radiations**

Afin de respecter les limites d'exposition pour l'ensemble de la population/l'exposition non contrôlée de la FCC/IC RF, les antennes utilisées pour cet émetteur doivent être installées de manière à offrir une distance de séparation minimum de 20 cm les personnes et ne doivent pas être utilisées en conjonction avec d'autres antennes ou émetteurs.

#### **12.2.5. Conforme aux normes d'INDUSTRIE CANADA**

Cet appareil numérique de classe B est conforme à la norme canadienne ICES-003. Les changements ou les modifications non approuvés expressément par la partie responsable de la conformité pourraient annuler l'autorisation de l'utilisateur de faire fonctionner l'équipement.

#### **12.2.6. Au sujet des émetteurs radio**

Ce dispositif est conforme à la partie 15 des règles de la Federal Communications Commission (FCC) des États-Unis et d'Industrie Canada (IC) exempts de licence RSS norme(s).

Son fonctionnement est assujetti aux deux conditions suivantes:

1. Ce dispositif ne doit pas provoquer de brouillage préjudiciable, et
2. il doit accepter tout brouillage reçu, y compris le brouillage pouvant entraîner un mauvais fonctionnement.

#### **12.2.7. Antennes détachables:**

Cet émetteur radio a été approuvé par Industrie Canada pour fonctionner avec les types d'antennes inscrites dans le manuel d'installation avec le gain maximum permis et l'impédance d'antenne requise pour chaque type d'antenne indiqué. Les types d'antennes non compris dans la liste, qui ont un gain supérieur au gain maximum indiqué pour le type en question, sont strictement interdits.

### **12.3. AUSTRALIAN RADIO COMMUNICATIONS EQUIPMENT - RADIATION EXPOSURE STATEMENT**

The equipment complies with the Radio communications (Electromagnetic Radiation). Human Exposure Standard 2014 for General Public Exposure, Non-Aware User, for a Compliance Level 2 Radio communications Equipment, when the minimum safety distance of 20 cm is adhered to and shall bear the RCM.

### 13. INTERNATIONAL APPROVALS

#### 13.1. CAS TOF UNITS - INTERNATIONAL CERTIFICATIONS

Refer the below Table 6 for the International Certifications of the CAS ToF units.

**Table 6. CAS ToF Units Model No. & Certification No.**

<b>COUNTRY</b>	<b>PROD0810</b>	<b>PROD0811</b>	<b>PROD0812</b>	<b>PROD0813</b>
Chile SUBTEL	ORD No.: 0068/DO No. 60635/ F71			
Colombia CRC	2017812554			
Ghana NCA	BR3-1M-GE2-03C			
India WPC	NR-ETA/9963-RLO(NR)	ETA-0448/2018/RLO(NR)	NR-ETA/9960-RLO(NR)	NR-ETA/9962-RLO(NR)
Mozambique INCM	Nº 20/R/RML/2018			
Peru MTC	TRSS42810			
PNG NICTA	PNG17/1104			
S Africa ICASA	TA-2016/2415	TA-2016/2417	TA-2016/2417	TA-2016/2417

**Table 6. CAS ToF Units Model No. & Certification No. (Continues)**

<b>COUNTRY</b>	<b>PROD0814</b>	<b>PROD0815</b>	<b>PROD0821</b>	<b>PROD0822</b>
Chile SUBTEL				
Colombia CRC				
Ghana NCA				
India WPC	NR-ETA/9954-RLO(NR)	ETA-0533/2018/RLO(NR)	NR-ETA/9956-RLO(NR)	NR-ETA/9959-RLO(NR)
Mozambique INCM				
Peru MTC				
PNG NICTA				
S Africa ICASA	TA-2016/2416	TA-2016/2416	TA-2016/2416	TA-2016/2416

### 13.2. CAS DUAL RF/TOF UNITS - INTERNATIONAL CERTIFICATIONS

Refer the below Table 7 for the International Certifications of CAS Dual RF/ToF Units.

**Table 7. CAS Dual RF/ToF Units Model No. & Certification No.**

COUNTRY	PROD0799	PROD0800	PROD0802
Chile SUBTEL	ORD No.: 2978/DO No. 62117/F23, dt: Feb 17, 2020	ORD No.: 2978/DO No. 62117/F23, dt: Feb 17, 2020	ORD No.: 2978/DO No. 62117/F23, dt: Feb 17, 2020
Colombia CRC			
Ghana NCA			
India WPC	ETA-0435/2018/RLO(NR) NR-ETA/9957-RLO(NR)	ETA-0434/2018/RLO(NR) ETA-0532/2018/RLO(NR)	ETA-0433/2018/RLO(NR) NR-ETA/9955-RLO(NR)
Indonesia POSTEL	53942/SDPPI/2017	53944/SDPPI/2017	53943/SDPPI/2017
Mozambique INCM	N° 15/R/RML/2018 N° 16/R/RML/2018	N° 17/R/RML/2018 N° 18/R/RML/2018	N° 19/R/RML/2018 N° 37/R/RML/2018
Peru MTC	TRSS41883		
PNG NICTA			
S Africa ICASA	TA-2016/1993	TA-2016/1993	TA-2016/1993

**Table 7. CAS Dual RF/ToF Units Model No. & Certification No. (Continues)**

COUNTRY	PROD0806	PROD0807	PROD0825
Chile SUBTEL			
Colombia CRC			
Ghana NCA			
India WPC	ETA-0436/2018/RLO(NR) ETA-0698/2018/RLO(NR)	ETA-0534/2018/RLO(NR) NR-ETA/9958-RLO(NR)	ETA-0437/2018/RLO(NR) NR-ETA/9961-RLO(NR)
Indonesia POSTEL			
Mozambique INCM	N° 43/R/RML/2018 N° 42/R/RML/2018		N° 44/R/RML/2018 N° 45/R/RML/2018
Peru MTC			
PNG NICTA			
S Africa ICASA	TA-2016/1993	TA-2016/2417	TA-2016/2415

## 14. LIFE SUPPORT POLICY

These products are not designed for use in life support appliances, devices, or systems where malfunction of these products can reasonably be expected to result in personal injury. Wabtec Digital Mining Technology customers using or selling these products for use in such applications do so at their own risk and agree to fully indemnify Wabtec Digital Mining Technology from all damages resulting from such improper use or sale.

### 14.1. ELECTROMAGNETIC INTERFERENCE / COMPATIBILITY

Nearly every electronic device is susceptible to electromagnetic interference (EMI) if inadequately shielded, designed, or otherwise configured for electromagnetic compatibility.

To avoid electromagnetic interference and/or compatibility conflicts, do not use this device in any facility where posted notices instruct you to do so. In aircraft, use of any radio frequency devices must be in accordance with applicable regulations. Hospitals or health care facilities may be using equipment that is sensitive to external RF energy.

With medical devices, maintain a minimum separation of 15 cm (6 inches) between pacemakers and wireless devices and some wireless radios may interfere with some hearing aids. If other personal medical devices are being used in the vicinity of wireless devices, ensure that the device has been adequately shielded from RF energy. In a domestic environment this product may cause radio interference in which case the user may be required to take adequate measures.

### 14.2. POTENTIALLY EXPLOSIVE ATMOSPHERES



The products listed in this document are not designed for use in explosive atmospheres. Turn off your electronic device before entering an area with potentially explosive atmosphere. It is rare, but your electronic device could generate sparks. Sparks in such areas could cause an explosion or fire resulting in bodily injury or even death.

Areas with a potentially explosive atmosphere are often, but not always, clearly marked. They include fueling areas, such as petrol station, below deck on boats, fuel or chemical transfer or storage facilities, and areas where the air contains chemicals or particles, such as grain, dust, or metal powders.



**CAUTION!** Electrostatic Sensitive Device. Precaution should be used when handling the device in order to prevent permanent damage.