

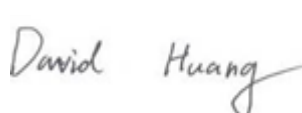

RF TEST REPORT



Report No.: 17071472-FCC-R2

Supersede Report No.: N/A

Applicant	BLU Products , Inc	
Product Name	Feature Phone	
Model No.	Z5	
Serial No.	N/A	
Test Standard	FCC Part 15.247: 2017, ANSI C63.10: 2013	
Test Date	December 28, 2017 to January 17, 2018	
Issue Date	January 18, 2018	
Test Result	<input checked="" type="checkbox"/> Pass <input type="checkbox"/> Fail	
Equipment complied with the specification	<input checked="" type="checkbox"/>	
Equipment did not comply with the specification	<input type="checkbox"/>	
		
Aarron Liang Test Engineer	David Huang Checked By	
This test report may be reproduced in full only Test result presented in this test report is applicable to the tested sample only		

Issued by:

SIEMIC (SHENZHEN-CHINA) LABORATORIES

Zone A, Floor 1, Building 2 Wan Ye Long Technology Park

South Side of Zhoushi Road, Bao' an District, Shenzhen, Guangdong China 518108

Phone: +86 0755 2601 4629801 Email: China@siemic.com.cn

Laboratories Introduction

SIEMIC, headquartered in the heart of Silicon Valley, with superior facilities in US and Asia, is one of the leading independent testing and certification facilities providing customers with one-stop shop services for Compliance Testing and Global Certifications.



In addition to testing and certification, SIEMIC provides initial design reviews and compliance management throughout a project. Our extensive experience with China, Asia Pacific, North America, European, and International compliance requirements, assures the fastest, most cost effective way to attain regulatory compliance for the global markets.

Accreditations for Conformity Assessment

Country/Region	Scope
USA	EMC, RF/Wireless, SAR, Telecom
Canada	EMC, RF/Wireless, SAR, Telecom
Taiwan	EMC, RF, Telecom, SAR, Safety
Hong Kong	RF/Wireless, SAR, Telecom
Australia	EMC, RF, Telecom, SAR, Safety
Korea	EMI, EMS, RF, SAR, Telecom, Safety
Japan	EMI, RF/Wireless, SAR, Telecom
Singapore	EMC, RF, SAR, Telecom
Europe	EMC, RF, SAR, Telecom, Safety

Test Report	17071472-FCC-R2
Page	3 of 66

This page has been left blank intentionally.

CONTENTS

1. REPORT REVISION HISTORY	5
2. CUSTOMER INFORMATION	5
3. TEST SITE INFORMATION	5
4. EQUIPMENT UNDER TEST (EUT) INFORMATION	6
5. TEST SUMMARY	8
6. MEASUREMENTS, EXAMINATION AND DERIVED RESULTS	9
6.1 ANTENNA REQUIREMENT	9
6.2 CHANNEL SEPARATION	10
6.3 20DB BANDWIDTH	14
6.4 PEAK OUTPUT POWER	18
6.5 NUMBER OF HOPPING CHANNEL	22
6.6 TIME OF OCCUPANCY (DWELL TIME)	24
6.7 BAND EDGE & RESTRICTED BAND	28
6.8 AC POWER LINE CONDUCTED EMISSIONS	36
6.9 RADIATED EMISSIONS & RESTRICTED BAND	42
ANNEX A. TEST INSTRUMENT	49
ANNEX B. EUT AND TEST SETUP PHOTOGRAPHS	50
ANNEX C. TEST SETUP AND SUPPORTING EQUIPMENT	61
ANNEX D. USER MANUAL / BLOCK DIAGRAM / SCHEMATICS / PARTLIST	65
ANNEX E. DECLARATION OF SIMILARITY	66

1. Report Revision History

Report No.	Report Version	Description	Issue Date
17071472-FCC-R2	NONE	Original	January 18, 2018

2. Customer information

Applicant Name	BLU Products , Inc
Applicant Add	10814 NW 33rd St # 100 Doral, FL 33172 , USA
Manufacturer	BLU Products , Inc
Manufacturer Add	10814 NW 33rd St # 100 Doral, FL 33172 , USA

3. Test site information

Test Lab A:

Lab performing tests	SIEMIC (Shenzhen-China) LABORATORIES
Lab Address	Zone A, Floor 1, Building 2 Wan Ye Long Technology Park South Side of Zhoushi Road, Bao' an District, Shenzhen, Guangdong China 518108
FCC Test Site No.	535293
IC Test Site No.	4842E-1
Test Software	Radiated Emission Program-To Shenzhen v2.0

Test Lab B:

Lab performing tests	SIEMIC (Nanjing-China) Laboratories
Lab Address	2-1 Longcang Avenue Yuhua Economic and Technology Development Park, Nanjing, China
FCC Test Site No.	694825
IC Test Site No.	4842B-1
Test Software	EZ_EMG(ver.lcp-03A1)

Note: We just perform Radiated Spurious Emission above 18GHz in the test Lab. B.

4. Equipment under Test (EUT) Information

Description of EUT:	Feature Phone
Main Model:	Z5
Serial Model:	N/A
Date EUT received:	December 27, 2017
Test Date(s):	December 28, 2017 to January 17, 2018
Equipment Category :	DSS
Antenna Gain:	GSM850: -0.5dBi PCS1900: -0.8dBi Bluetooth: -0.4dBi
Antenna Type:	GSM: PIFA antenna BT: monopole antenna
Type of Modulation:	GSM / GPRS: GMSK Bluetooth: GFSK, π /4DQPSK, 8DPSK
RF Operating Frequency (ies):	GSM850 TX: 824.2 ~ 848.8 MHz; RX: 869.2 ~ 893.8 MHz PCS1900 TX: 1850.2 ~ 1909.8 MHz; RX: 1930.2 ~ 1989.8 MHz Bluetooth: 2402-2480 MHz
Max. Output Power:	9.136dBm
Number of Channels:	GSM 850: 124CH PCS1900: 299CH Bluetooth: 79CH
Port:	USB Port, Earphone Port

Adapter:
Model: US-SL-0550
Input: AC 100-240V~50/60Hz,0.15A
Output: DC 5.0V-550mA

Input Power: Battery
Model: N5C600T
Spec: 3.7V, 600mAh 2.22Wh

Trade Name : BLU

FCC ID: YHLBLUZ5

5. Test Summary

The product was tested in accordance with the following specifications.

All testing has been performed according to below product classification:

FCC Rules	Description of Test	Result
§15.203	Antenna Requirement	Compliance
§15.247(a)(1)	Channel Separation	Compliance
§15.247(a)(1)	20 dB Bandwidth	Compliance
§15.247(b)(1)	Peak Output Power	Compliance
§15.247(a)(1)(iii)	Number of Hopping Channel	Compliance
§15.247(a)(1)(iii)	Time of Occupancy (Dwell Time)	Compliance
§15.247(d)	Band Edge& Restricted Band	Compliance
§15.207(a)	AC Line Conducted Emissions	Compliance
§15.205, §15.209, §15.247(d)	Radiated Emissions& Restricted Band	Compliance

Measurement Uncertainty

Emissions		
Test Item	Description	Uncertainty
Band Edge& Restricted Band and Radiated Emissions& Restricted Band	Confidence level of approximately 95% (in the case where distributions are normal), with a coverage factor of 2 (for EUTs < 0.5m X 0.5m X 0.5m)	+5.6dB/-4.5dB
-	-	-

6. Measurements, Examination And Derived Results

6.1 Antenna Requirement

Applicable Standard

According to § 15.203, an intentional radiator shall be designed to ensure that no antenna other than that furnished by the responsible party shall be used with the device. The use of a permanently attached antenna or of an antenna that uses a unique coupling to the intentional radiator shall be considered sufficient to comply with the provisions of this section. The manufacturer may design the unit so that a broken antenna can be replaced by the user, but the user of a standard antenna jack or electrical connector is prohibited. The structure and application of the EUT were analyzed to determine compliance with section §15.203 of the rules. §15.203 state that the subject device must meet the following criteria:

- a. Antenna must be permanently attached to the unit.
- b. Antenna must use a unique type of connector to attach to the EUT.

Unit must be professionally installed, and installer shall be responsible for verifying that the correct antenna is employed with the unit.

And according to FCC 47 CFR section 15.247 (b), if the transmitting antennas of directional gain greater than 6dBi are used, the power shall be reduced by the amount in dB that the directional gain of the antenna exceeds 6 dBi.

Antenna Connector Construction

The EUT has 2 antennas:

A permanently attached monopole antenna for Bluetooth, the gain is -0.4dBi for Bluetooth.

A permanently attached PIFA antenna for GSM/PCS, the gain is -0.5dBi for GSM850, -0.8dBi for PCS1900.

The antenna meets up with the ANTENNA REQUIREMENT.

Result: Compliance.

6.2 Channel Separation

Temperature	25°C
Relative Humidity	58%
Atmospheric Pressure	1016mbar
Test date :	January 16, 2018
Tested By :	Aarron Liang

Requirement(s):

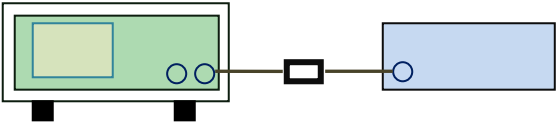
Spec	Item	Requirement	Applicable
§ 15.247(a)(1)	a)	Channel Separation < 20dB BW and 20dB BW < 25KHz ; Channel Separation Limit=25KHz Chanel Separation < 20dB BW and 20dB BW > 25kHz ; Channel Separation Limit=2/3 20dB BW	<input checked="" type="checkbox"/>
Test Setup	 <p style="text-align: center;">Spectrum Analyzer EUT</p>		
Test Procedure	<p>The test follows FCC Public Notice DA 00-705 Measurement Guidelines. Use the following spectrum analyzer settings:</p> <ul style="list-style-type: none"> - The EUT must have its hopping function enabled - Span = wide enough to capture the peaks of two adjacent channels - Resolution (or IF) Bandwidth (RBW) ≥ 1% of the span - Video (or Average) Bandwidth (VBW) ≥ RBW - Sweep = auto - Detector function = peak - Trace = max hold - Allow the trace to stabilize. Use the marker-delta function to determine the separation between the peaks of the adjacent channels. The limit is specified in one of the subparagraphs of this Section. Submit this plot. 		

Remark	
Result	<input checked="" type="checkbox"/> Pass <input type="checkbox"/> Fail

Test Data Yes N/A

Test Plot Yes (See below) N/A

Channel Separation measurement result

Type/ Modulation	CH	CH Frequency (MHz)	CH Separation (MHz)	Limit (MHz)	Result
CH Separation GFSK	Low Channel	2402	1.002	0.959	Pass
	Adjacency Channel	2403			
	Mid Channel	2440	1.005	0.956	Pass
	Adjacency Channel	2441			
	High Channel	2480	1.005	0.956	Pass
	Adjacency Channel	2479			
CH Separation $\pi/4$ DQPSK	Low Channel	2402	1.002	0.859	Pass
	Adjacency Channel	2403			
	Mid Channel	2440	1.005	0.857	Pass
	Adjacency Channel	2441			
	High Channel	2480	1.002	0.858	Pass
	Adjacency Channel	2479			
CH Separation 8DPSK	Low Channel	2402	1.005	0.858	Pass
	Adjacency Channel	2403			
	Mid Channel	2440	1.002	0.860	Pass
	Adjacency Channel	2441			
	High Channel	2480	1.005	0.860	Pass
	Adjacency Channel	2479			

Test Plots

Channel Separation measurement result



GFSK - Low Channel

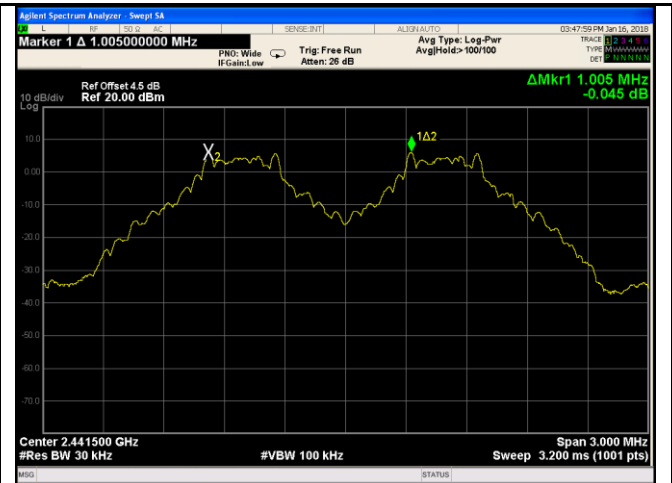

GFSK - Middle Channel

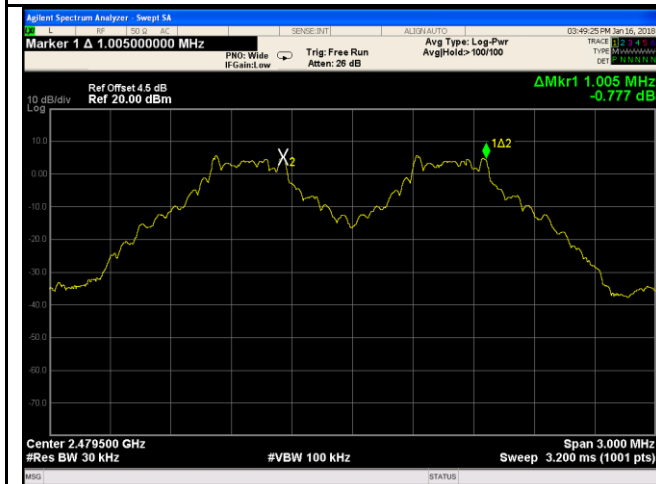

GFSK - High Channel

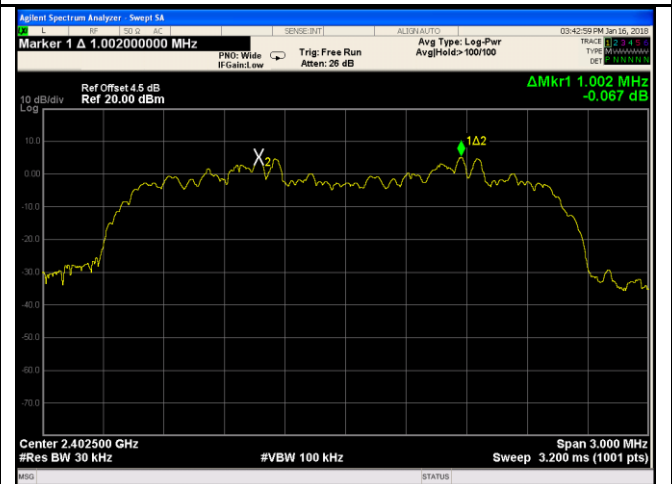

$\pi/4$ DPSK - Low Channel

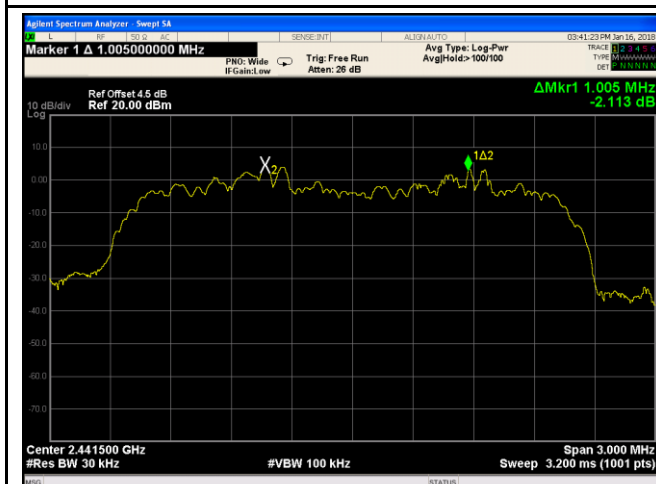

$\pi/4$ DQPSK - Middle Channel



$\pi/4$ DQPSK - High Channel

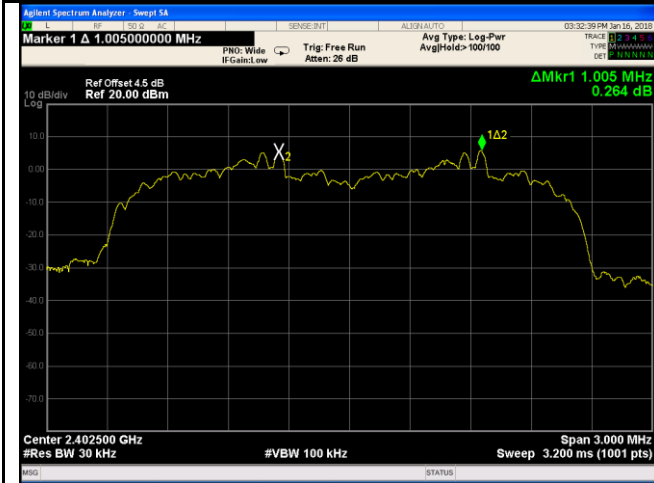

8DPSK - Low Channel

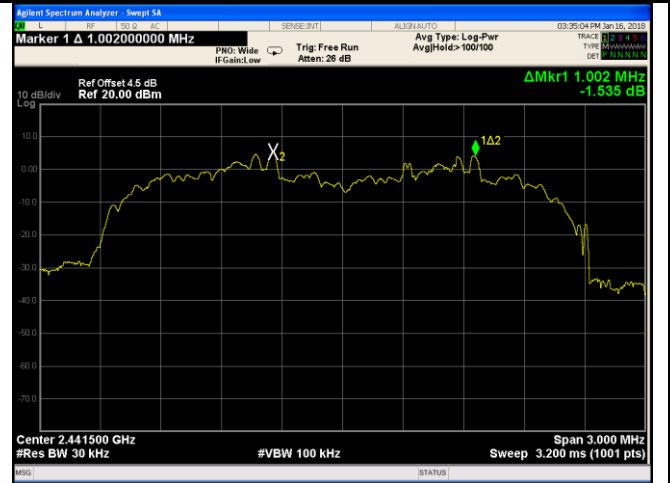

8DPSK - Middle Channel



8DPSK - High Channel

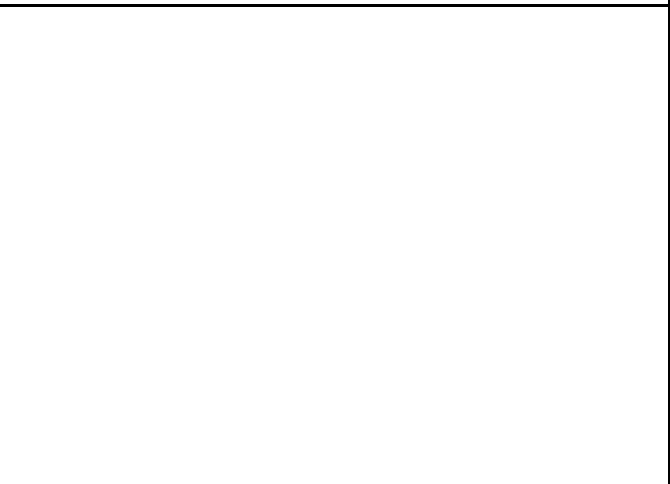

6.3 20dB Bandwidth

Temperature	25°C
Relative Humidity	58%
Atmospheric Pressure	1016mbar
Test date :	January 16, 2018
Tested By :	Aarron Liang

Requirement(s):

Spec	Item	Requirement	Applicable
§15.247(a) (1)	a)	Frequency hopping systems shall have hopping channel carrier frequencies separated by a minimum of 25 kHz or the 20 dB bandwidth of the hopping channel, whichever is greater.	<input checked="" type="checkbox"/>

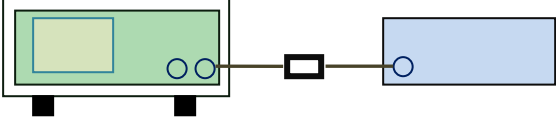
Test Setup	 <p style="text-align: center;">Spectrum Analyzer EUT</p>
------------	--

Test Procedure	<p>The test follows FCC Public Notice DA 00-705 Measurement Guidelines.</p> <p><u>Use the following spectrum analyzer settings:</u></p> <ul style="list-style-type: none"> - Span = approximately 2 to 3 times the 20 dB bandwidth, centered on a hopping channel - RBW \geq 1% of the 20 dB bandwidth - VBW \geq RBW - Sweep = auto - Detector function = peak - Trace = max hold. - The EUT should be transmitting at its maximum data rate. Allow the trace to stabilize. Use the marker-to-peak function to set the marker to the peak of the emission. Use the marker-delta function to measure 20 dB down one side of the emission. Reset the marker-delta function, and move the marker to the other side of the emission, until it is (as close as possible to) even with the reference
----------------	--

	marker level. The marker-delta reading at this point is the 20 dB bandwidth of the emission. If this value varies with different modes of operation (e.g., data rate, modulation format, etc.), repeat this test for each variation. The limit is specified in one of the subparagraphs of this Section. Submit this plot(s).
Remark	
Result	<input checked="" type="checkbox"/> Pass <input type="checkbox"/> Fail

Test Data Yes N/A

Test Plot Yes (See below) N/A

Measurement result

Modulation	CH	CH Frequency (MHz)	20dB Bandwidth (MHz)	99% Occupied Bandwidth (MHz)
GFSK	Low	2402	0.959	0.886
	Mid	2441	0.956	0.886
	High	2480	0.956	0.888
$\pi/4$ DQPSK	Low	2402	1.289	1.1785
	Mid	2441	1.286	1.1828
	High	2480	1.287	1.1789
8-DPSK	Low	2402	1.287	1.1898
	Mid	2441	1.290	1.1864
	High	2480	1.290	1.1871

Test Plots

20dB Bandwidth measurement result

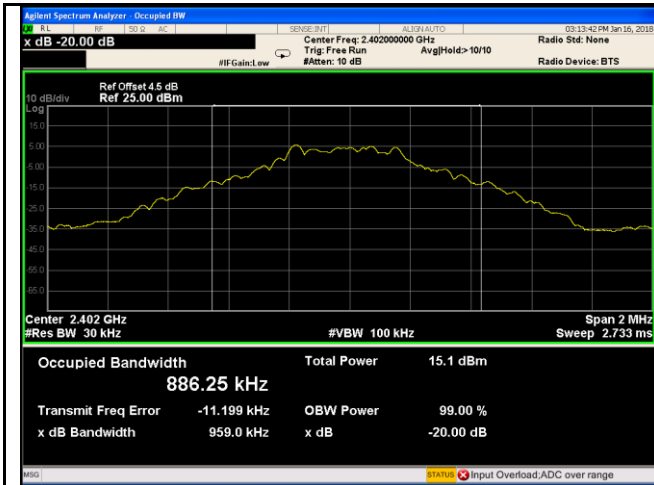

GFSK - Low Channel



GFSK - Middle Channel

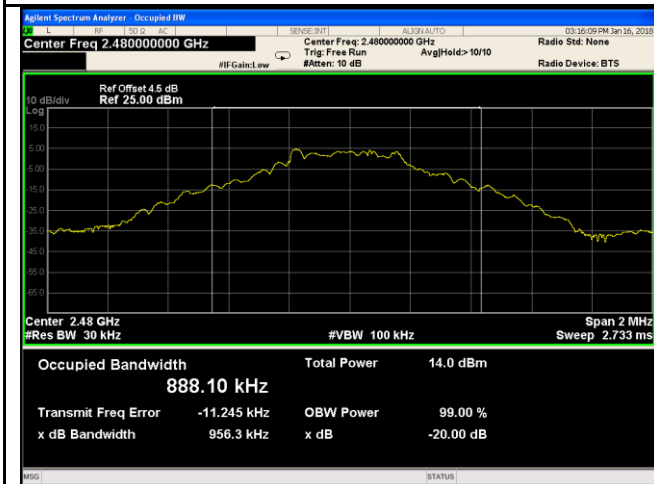

GFSK - High Channel

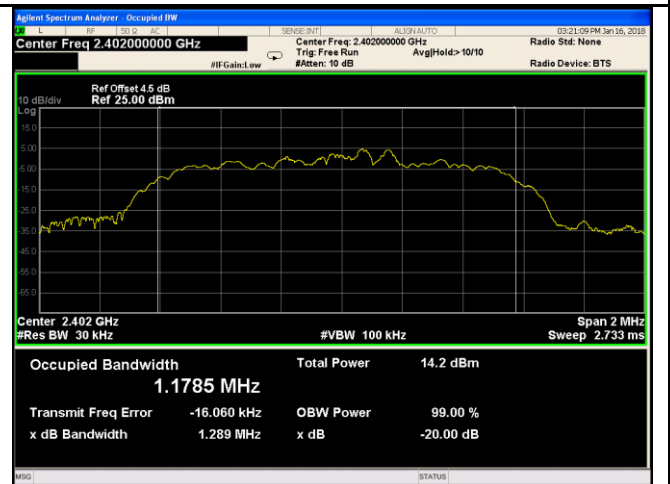

$\pi/4$ DPSK - Low Channel

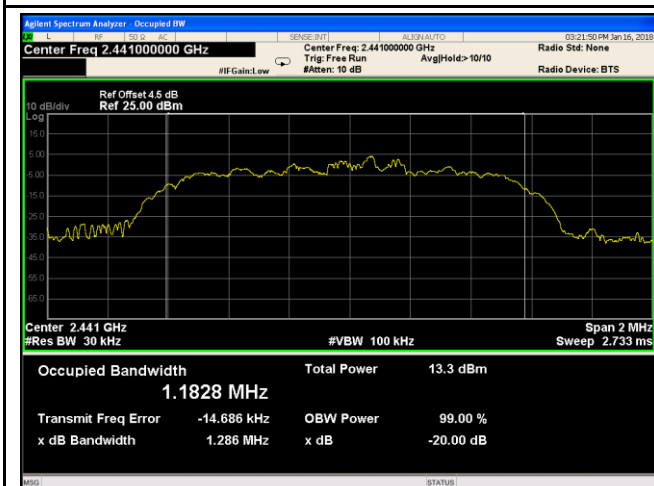

$\pi/4$ DQPSK - Middle Channel

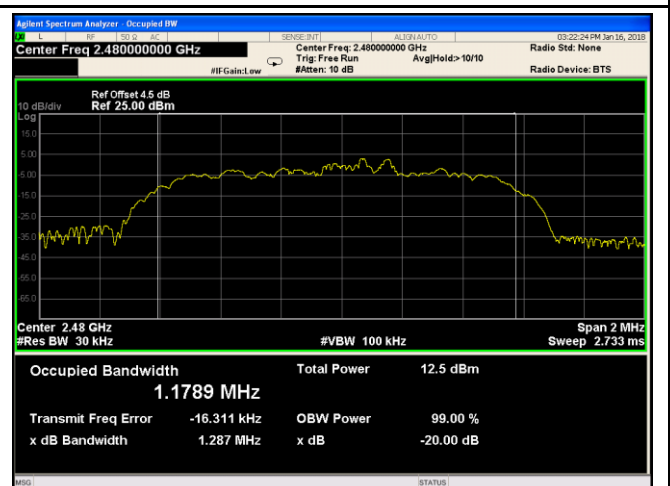

$\pi/4$ DQPSK - High Channel

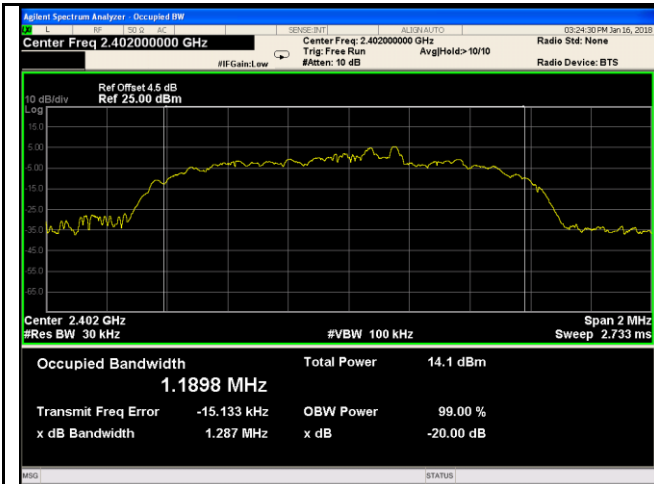

8DPSK - Low Channel

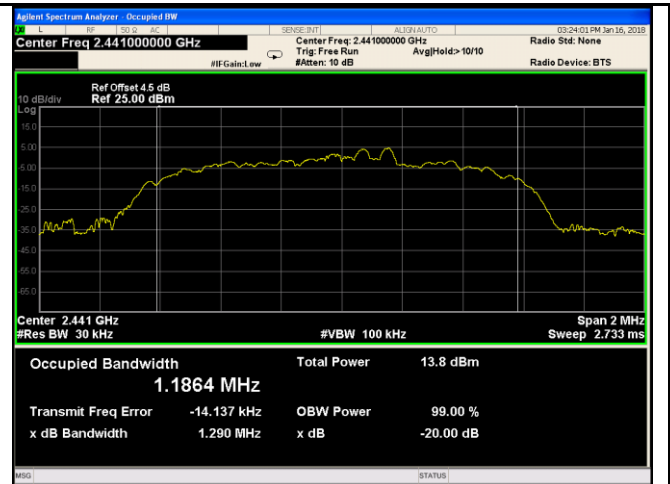

8DPSK - Middle Channel

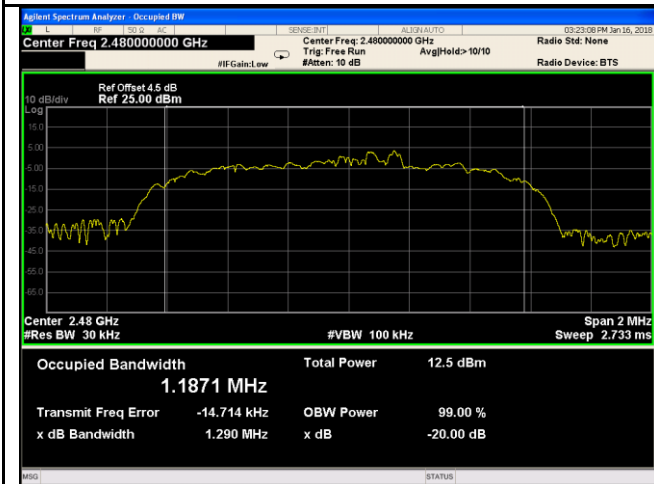

8DPSK - High Channel

6.4 Peak Output Power

Temperature	25°C
Relative Humidity	58%
Atmospheric Pressure	1016mbar
Test date :	January 16, 2018
Tested By :	Aarron Liang

Requirement(s):

Spec	Item	Requirement	Applicable
§15.247(b) (3)	a)	FHSS in 2400-2483.5MHz with ≥ 75 channels: ≤ 1 Watt	<input checked="" type="checkbox"/>
	b)	FHSS in 5725-5850MHz: ≤ 1 Watt	<input type="checkbox"/>
	c)	For all other FHSS in the 2400-2483.5MHz band: ≤ 0.125 Watt.	<input checked="" type="checkbox"/>
	d)	FHSS in 902-928MHz with ≥ 50 channels: ≤ 1 Watt	<input type="checkbox"/>
	e)	FHSS in 902-928MHz with ≥ 25 & < 50 channels: ≤ 0.25 Watt	<input type="checkbox"/>
	f)	DTS in 902-928MHz, 2400-2483.5MHz: ≤ 1 Watt	<input type="checkbox"/>

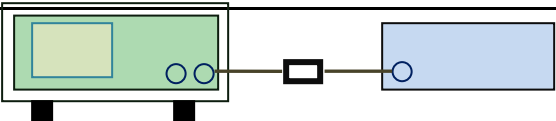
Test Setup	 <p style="text-align: center;">Spectrum Analyzer EUT</p>
------------	--

Test Procedure	<p>The test follows FCC Public Notice DA 00-705 Measurement Guidelines.</p> <p><u>Use the following spectrum analyzer settings:</u></p> <ul style="list-style-type: none"> - Span = approximately 5 times the 20 dB bandwidth, centered on a hopping channel - RBW $>$ the 20 dB bandwidth of the emission being measured - VBW \geq RBW - Sweep = auto - Detector function = peak - Trace = max hold - Allow the trace to stabilize.
----------------	---

	<ul style="list-style-type: none"> - Use the marker-to-peak function to set the marker to the peak of the emission. The indicated level is the peak output power (see the note above regarding external attenuation and cable loss). The limit is specified in one of the subparagraphs of this Section. Submit this plot. A peak responding power meter may be used instead of a spectrum analyzer.
Remark	
Result	<input checked="" type="checkbox"/> Pass <input type="checkbox"/> Fail

Test Data Yes N/A
 Test Plot Yes (See below) N/A

Peak Output Power measurement result

Type	Modulation	CH	Frequency (MHz)	Conducted Power (dBm)	Limit (mW)	Result
Output power	GFSK	Low	2402	7.784	1000	Pass
		Mid	2441	7.120	1000	Pass
		High	2480	6.933	1000	Pass
	$\pi/4$ DQPSK	Low	2402	9.133	125	Pass
		Mid	2441	8.265	125	Pass
		High	2480	8.197	125	Pass
	8-DPSK	Low	2402	9.136	125	Pass
		Mid	2441	8.570	125	Pass
		High	2480	8.378	125	Pass

Test Plots

Output Power measurement result

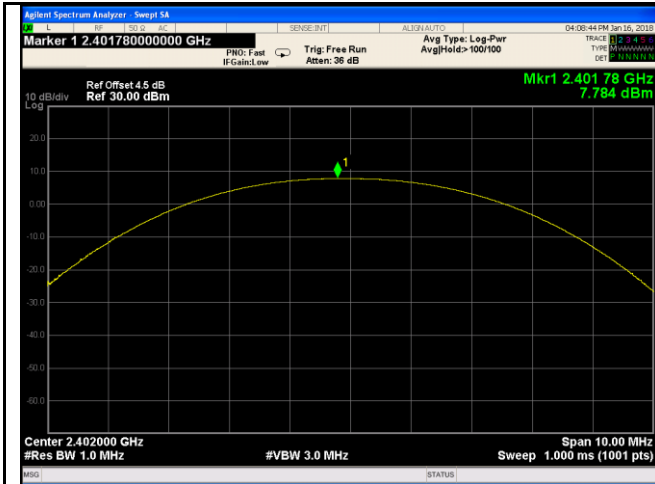

GFSK Output power - Low CH 2402

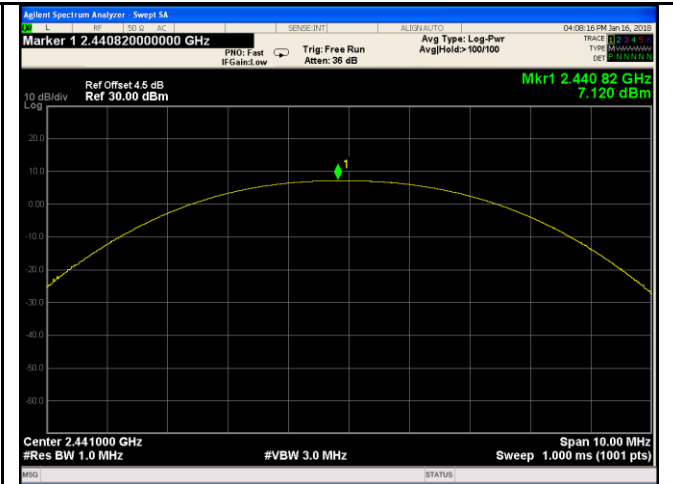

GFSK Output power - Mid CH 2441

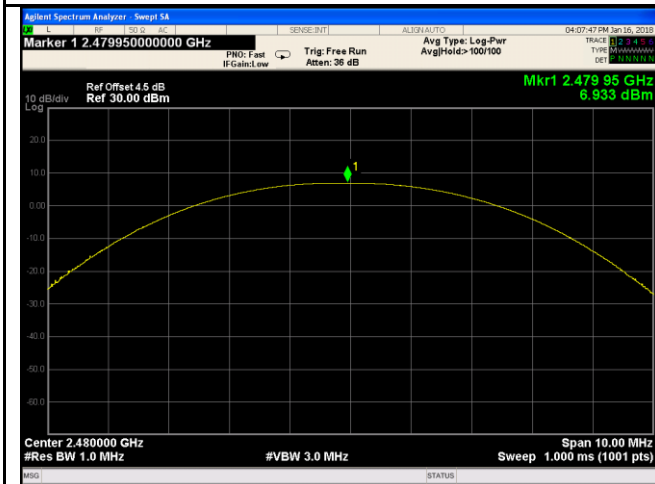

GFSK Output power - High CH 2480

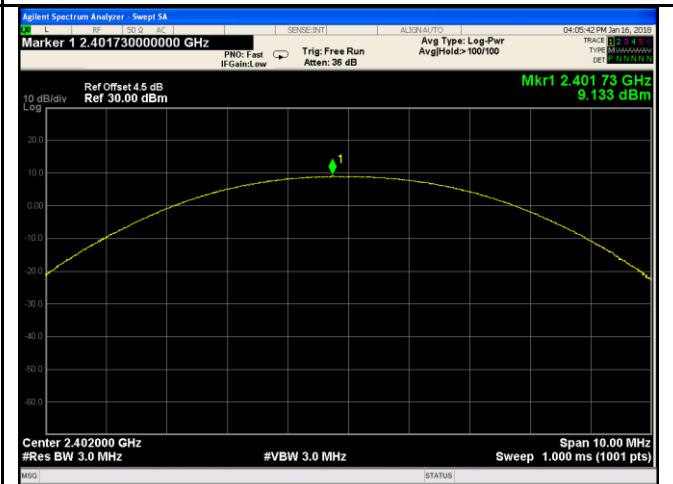

$\pi/4$ DQPSK Output power - Low CH 2402

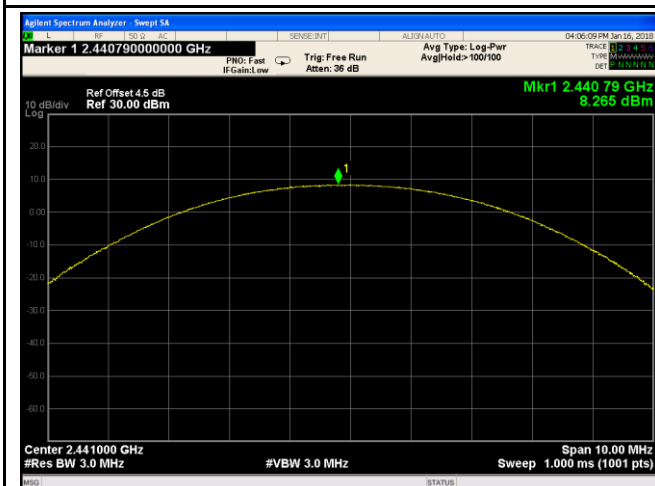

$\pi/4$ DQPSK Output power - Mid CH 2441

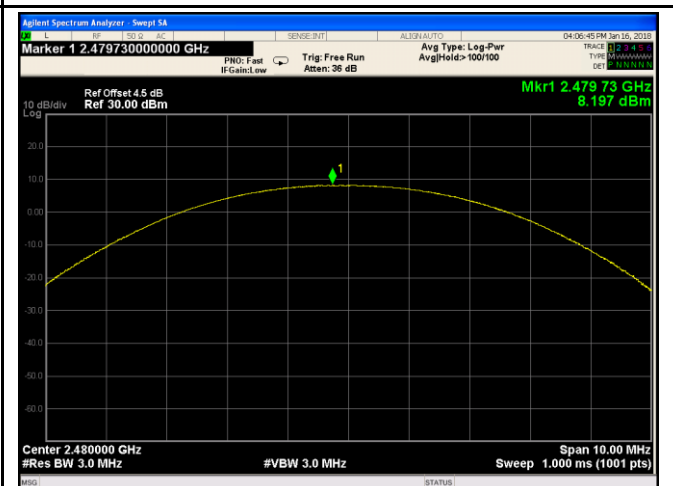

$\pi/4$ DQPSK Output power - High CH 2480

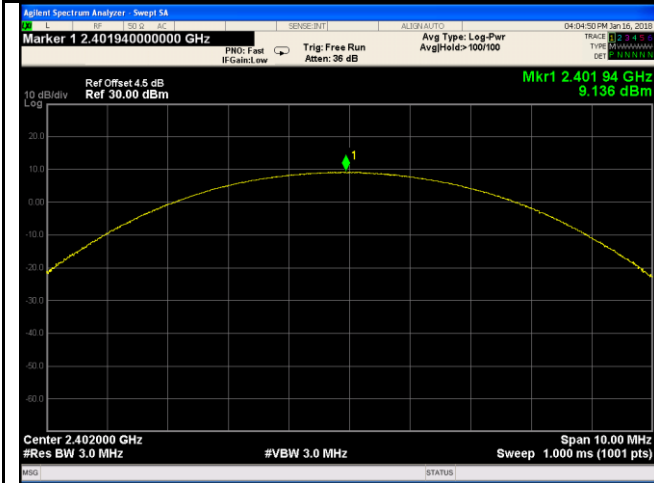

8DPSK Output power - Low CH 2402

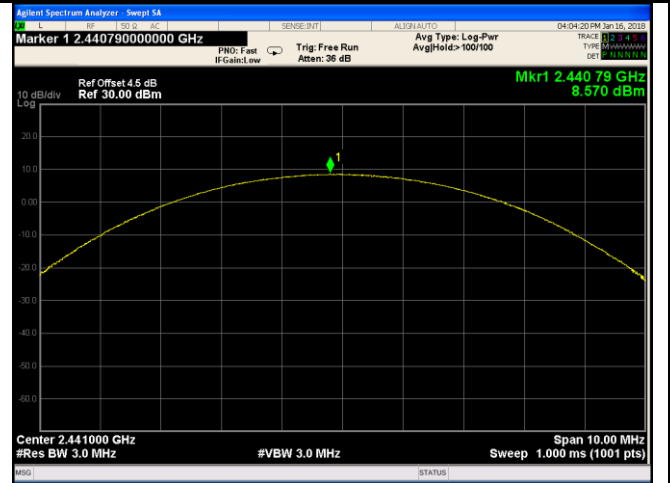

8DPSK Output power - Mid CH 2441

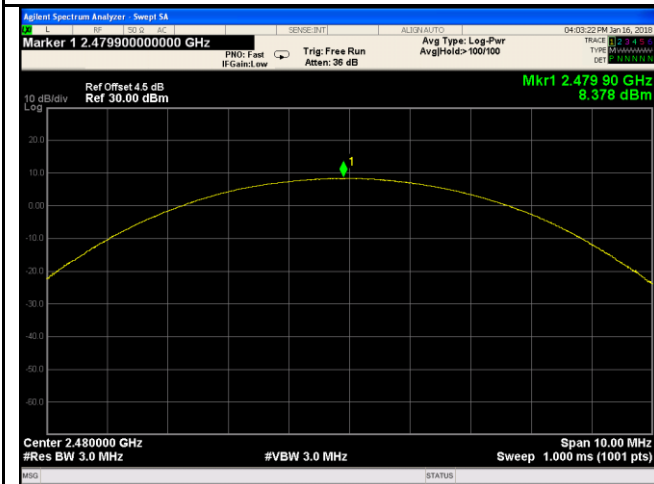

8DPSK Output power - High CH 2480

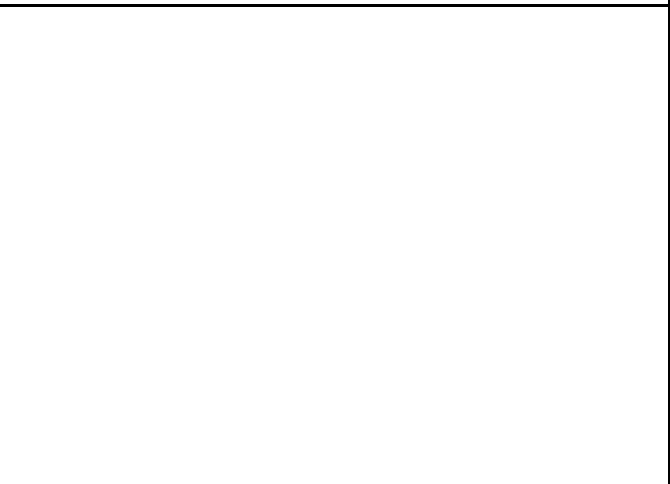

6.5 Number of Hopping Channel

Temperature	25°C
Relative Humidity	58%
Atmospheric Pressure	1016mbar
Test date :	January 16, 2018
Tested By :	Aarron Liang

Requirement(s):

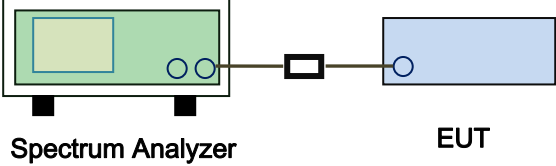
Spec	Item	Requirement	Applicable
§15.247(a) (1)(iii)	a)	FHSS in 2400-2483.5MHz ≥ 15 channels	<input checked="" type="checkbox"/>
Test Setup	 <p style="text-align: center;">Spectrum Analyzer EUT</p>		
Test Procedure	<p>The test follows FCC Public Notice DA 00-705 Measurement Guidelines. <u>Use the following spectrum analyzer settings:</u> The EUT must have its hopping function enabled.</p> <ul style="list-style-type: none"> - Span = the frequency band of operation - RBW ≥ 1% of the span - VBW ≥ RBW - Sweep = auto - Detector function = peak - Trace = max hold - Allow trace to fully stabilize. - It may prove necessary to break the span up to sections, in order to clearly show all of the hopping frequencies. The limit is specified in one of the subparagraphs of this Section. Submit this plot(s). 		
Remark			
Result	<input checked="" type="checkbox"/> Pass <input type="checkbox"/> Fail		

Test Data Yes N/A
 Test Plot Yes (See below) N/A

Number of Hopping Channel measurement result

Type	Modulation	Frequency Range	Number of Hopping Channel	Limit
Number of Hopping Channel	GFSK	2400-2483.5	79	15
	$\pi/4$ DQPSK	2400-2483.5	79	15
	8-DPSK	2400-2483.5	79	15

Test Plots

Number of Hopping Channels measurement result

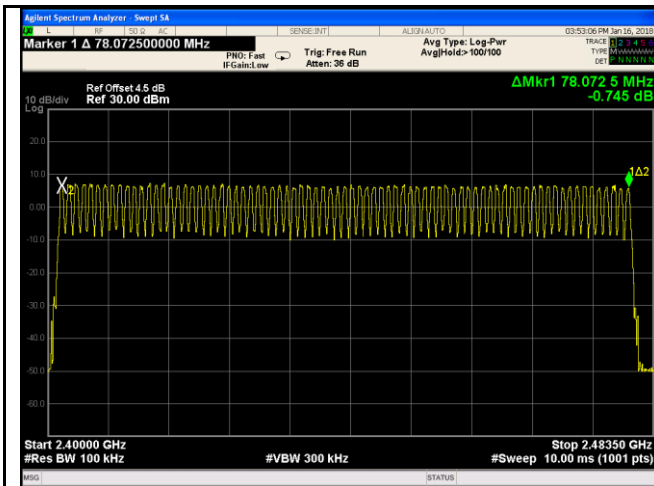

GFSK

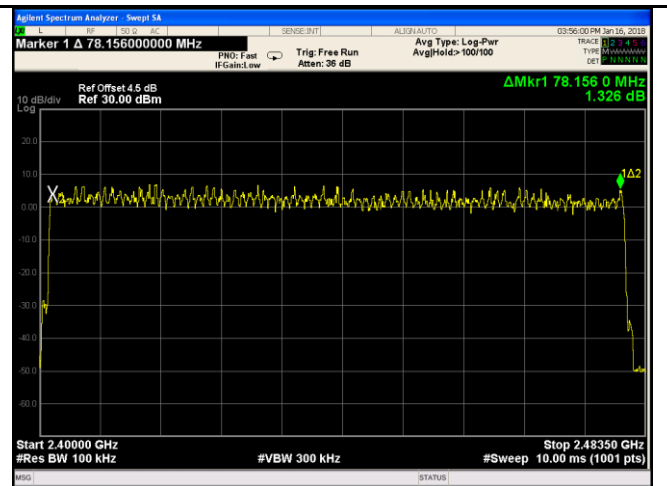

$\pi/4$ DQPSK

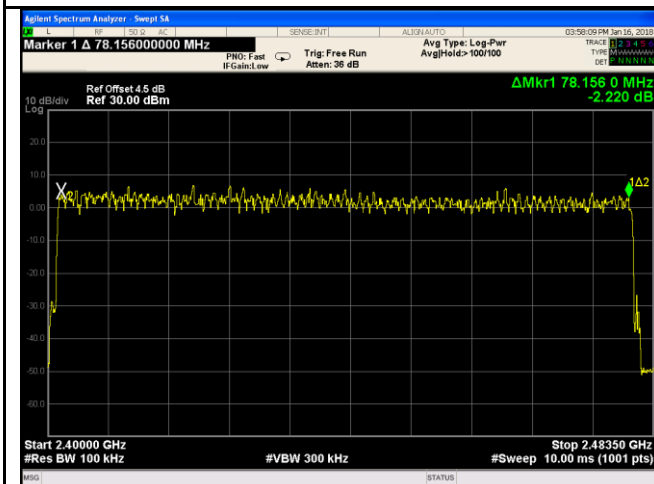

8DPSK

6.6 Time of Occupancy (Dwell Time)

Temperature	25°C
Relative Humidity	58%
Atmospheric Pressure	1016mbar
Test date :	January 16, 2018
Tested By :	Aarron Liang

Requirement(s):

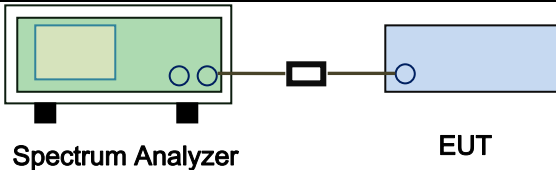
Spec	Item	Requirement	Applicable
§15.247(a) (1)(iii)	a)	Dwell Time < 0.4s	<input checked="" type="checkbox"/>
Test Setup	 <p style="text-align: center;">Spectrum Analyzer EUT</p>		
Test Procedure	<p>The test follows FCC Public Notice DA 00-705 Measurement Guidelines. <u>Use the following spectrum analyzer</u></p> <ul style="list-style-type: none"> - Span = zero span, centered on a hopping channel - RBW = 1 MHz - VBW ≥ RBW - Sweep = as necessary to capture the entire dwell time per hopping channel - Detector function = peak - Trace = max hold - use the marker-delta function to determine the dwell time 		
Remark			
Result	<input checked="" type="checkbox"/> Pass <input type="checkbox"/> Fail		

Test Data Yes N/A
 Test Plot Yes (See below) N/A

Dwell Time measurement result

Type	Modulation	CH	Pulse Width (ms)	Dwell Time (ms)	Limit (ms)	Result
Dwell Time	GFSK	Low	2.99	318.933	400	Pass
		Mid	2.98	317.867	400	Pass
		High	3.00	320.000	400	Pass
	π /4 DQPSK	Low	2.97	316.800	400	Pass
		Mid	2.99	318.933	400	Pass
		High	2.96	315.733	400	Pass
	8-DPSK	Low	2.93	312.533	400	Pass
		Mid	2.97	316.800	400	Pass
		High	2.96	315.733	400	Pass
Note: Dwell time=Pulse Time (ms) × (1600 ÷ 6 ÷ 79) ×31.6						

Test Plots

Dwell Time measurement result

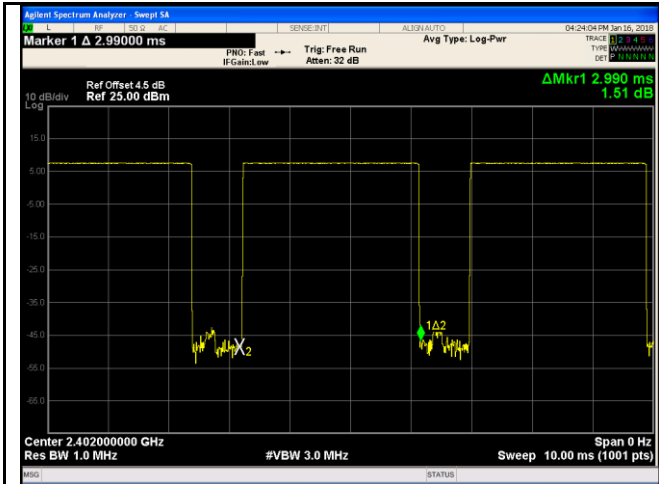

GFSK - Low CH 2402

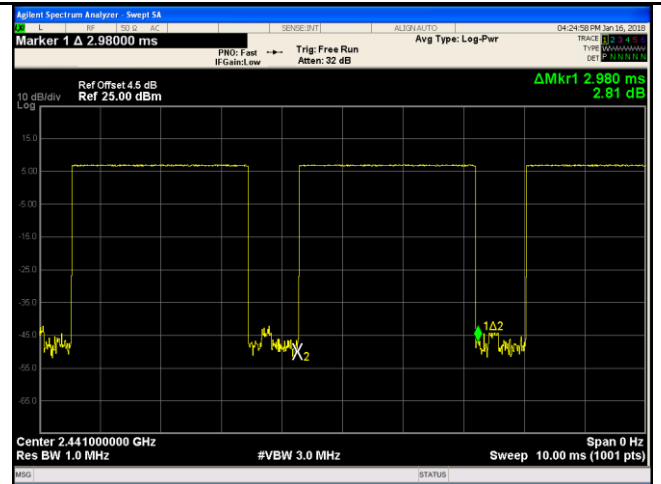

GFSK - Mid CH 2441

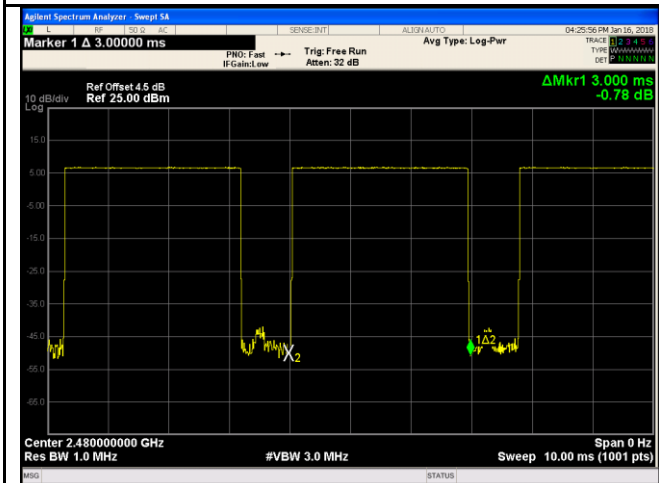

GFDK - High CH 2480

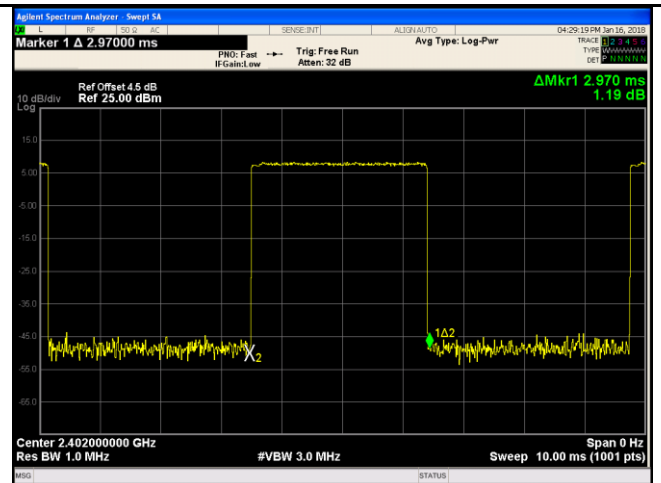

$\pi/4$ DQPSK - Low CH 2402

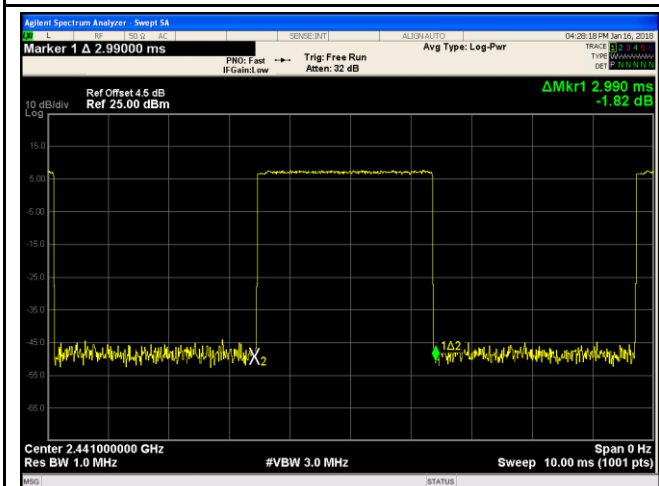

$\pi/4$ DQPSK - Mid CH 2441

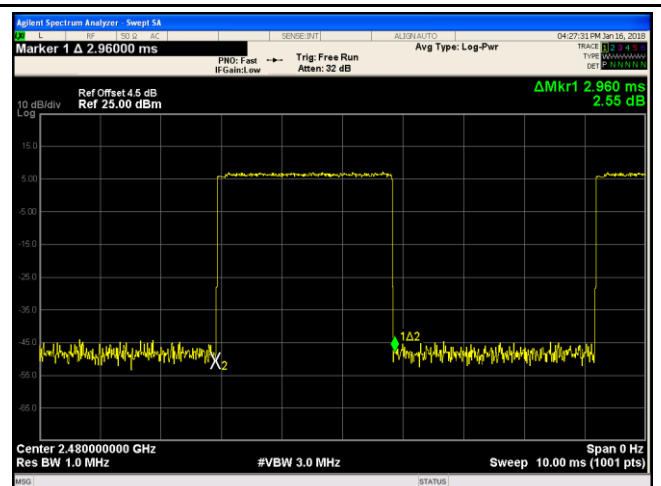

$\pi/4$ DQPSK - High CH 2480

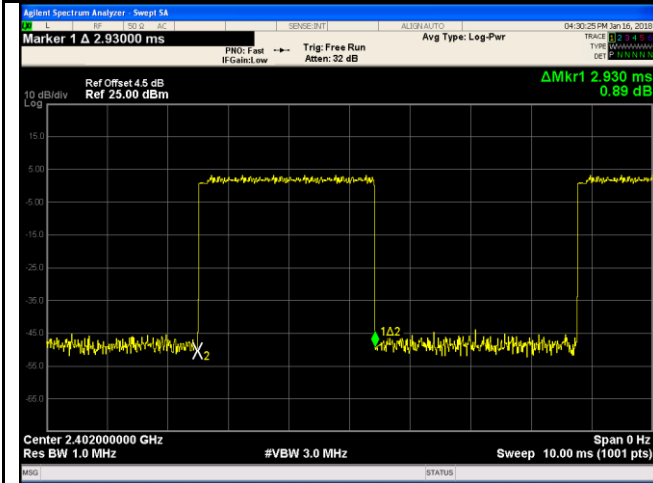

8DPSK - Low CH 2402

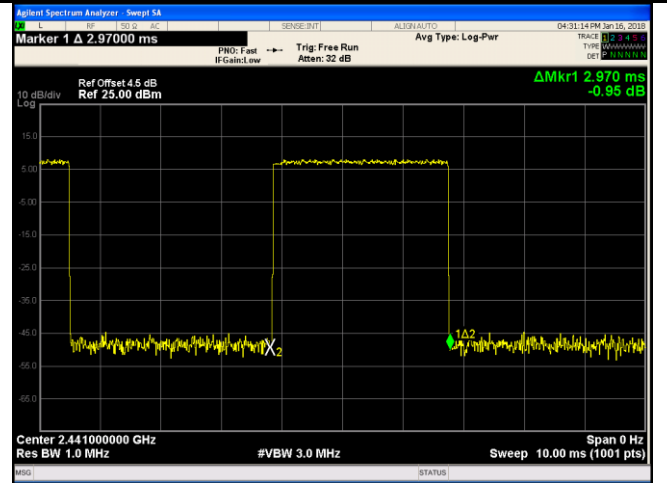

8DPSK - Mid CH 2441

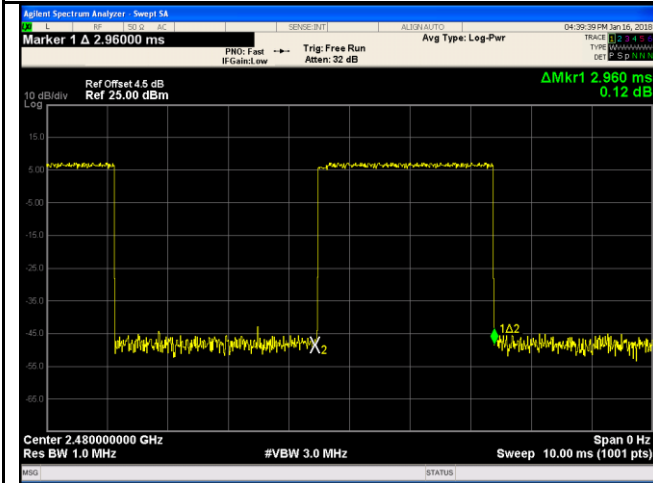

8DPSK - High CH 2480

6.7 Band Edge & Restricted Band

Temperature	23°C
Relative Humidity	54%
Atmospheric Pressure	1020mbar
Test date :	December 28, 2017
Tested By :	Aarron Liang

Requirement(s):

Spec	Item	Requirement	Applicable
§15.247(a) (1)(iii)	a)	In any 100 kHz bandwidth outside the frequency band in which the spread spectrum or digitally modulated intentional radiator is operating, the radio frequency power that is produced by the intentional radiator shall be at least 20 dB below that in the 100 kHz bandwidth within the band that contains the highest level of the desired power, based on either an RF conducted or a radiated measurement, provided the transmitter demonstrates compliance with the peak conducted power limits. □	<input checked="" type="checkbox"/>

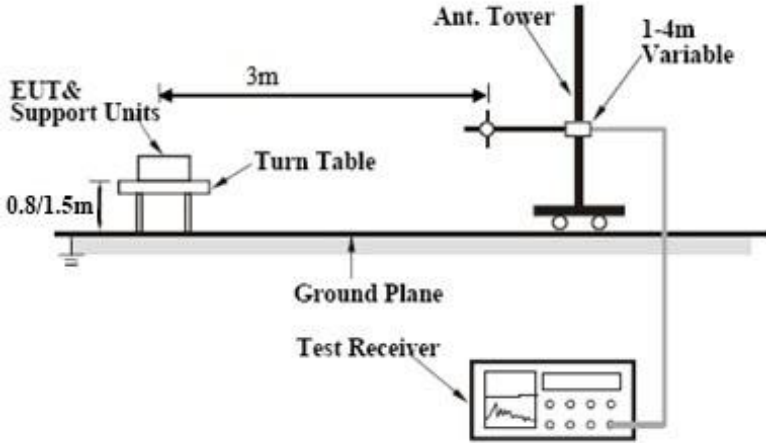
Test Setup	
------------	--

Test Procedure	<p>The test follows FCC Public Notice DA 00-705 Measurement Guidelines. Radiated Method Only</p> <ul style="list-style-type: none"> - 1. Check the calibration of the measuring instrument using either an internal calibrator or a known signal from an external generator. - 2. Position the EUT without connection to measurement instrument. Put it on the Rotated table and turn on the EUT and make it operate in transmitting mode. Then set it to Low Channel and High Channel within its operating range,
----------------	--

	<p>and make sure the instrument is operated in its linear range.</p> <ul style="list-style-type: none"> - 3. First, set both RBW and VBW of spectrum analyzer to 100 kHz with a convenient frequency span including 100kHz bandwidth from band edge, check the emission of EUT, if pass then set Spectrum Analyzer as below: <ul style="list-style-type: none"> a. The resolution bandwidth and video bandwidth of test receiver/spectrum analyzer is 120 kHz for Quasiy Peak detection at frequency below 1GHz. b. The resolution bandwidth of test receiver/spectrum analyzer is 1MHz and video bandwidth is 3MHz with Peak detection for Peak measurement at frequency above 1GHz. c. The resolution bandwidth of test receiver/spectrum analyzer is 1MHz and the video bandwidth is 10Hz with Peak detection for Average Measurement as below at frequency above 1GHz. - 4. Measure the highest amplitude appearing on spectral display and set it as a reference level. Plot the graph with marking the highest point and edge frequency. - 5. Repeat above procedures until all measured frequencies were complete.
Remark	
Result	<input checked="" type="checkbox"/> Pass <input type="checkbox"/> Fail

Test Data Yes N/A
Test Plot Yes (See below) N/A

Test Plots

GFSK Mode:

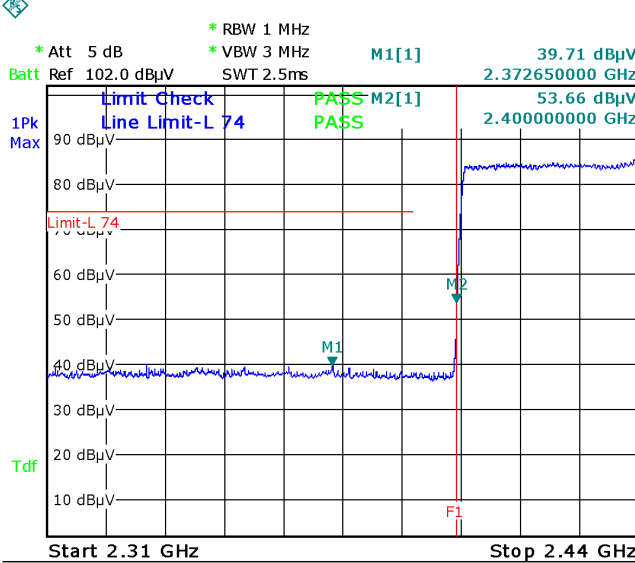
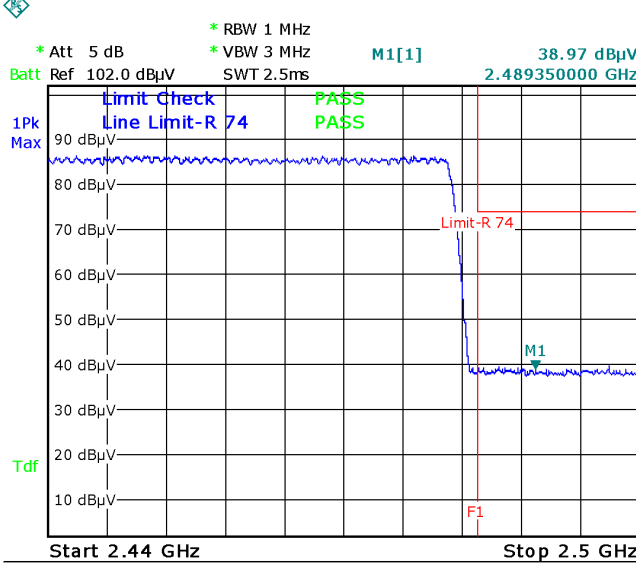
 <p>Date: 28.DEC.2017 17:14:56</p>	 <p>Date: 28.DEC.2017 17:17:29</p>
<p style="text-align: center;">GFSK-Hopping Left Side-PK</p> <p style="text-align: center;">Note: F1 is frequency 2400MHz</p>	<p style="text-align: center;">GFSK-Hopping Right Side-PK</p> <p style="text-align: center;">Note: F1 is frequency 2483.5MHz</p>
<p style="text-align: center;">Note: (no need if PK value less than the AV limit)</p>	<p style="text-align: center;">Note: (no need if PK value less than the AV limit)</p>
<p style="text-align: center;">GFSK-Hopping Left Side-AV</p>	<p style="text-align: center;">GFSK-Hopping Right Side-AV</p>

Note: Both Horizontal and vertical polarities were investigated.

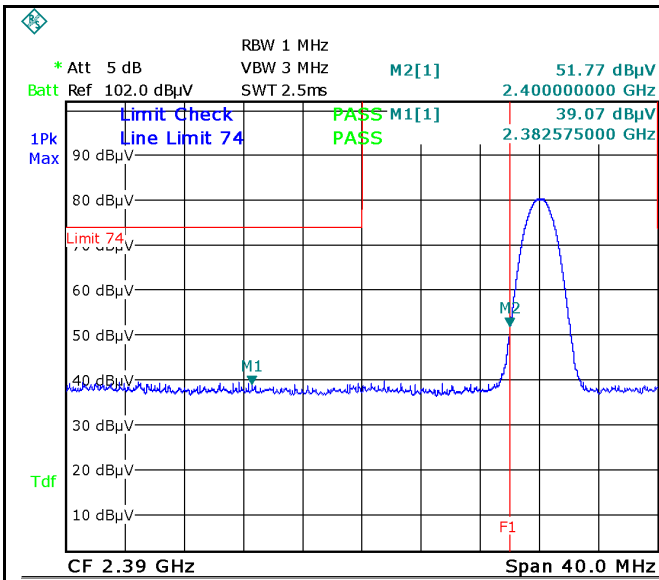

Date: 28.DEC.2017 17:10:58

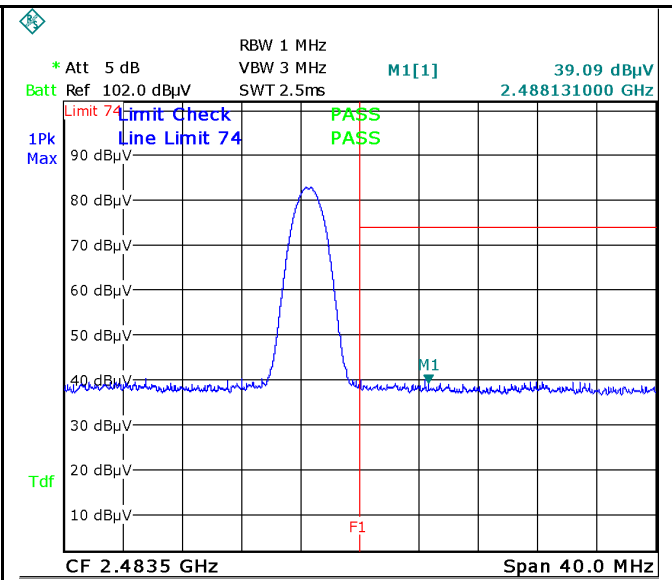

Date: 28.DEC.2017 17:08:10

GFSK-Left Side-PK

Note: F1 is frequency 2400MHz

GFSK-Right Side-PK

Note: F1 is frequency 2483.5MHz

Note: (no need if PK value less than the AV limit)

Note: (no need if PK value less than the AV limit)

GFSK-Left Side-AV

GFSK-Right Side-AV

Note: Both Horizontal and vertical polarities were investigated.

$\pi/4$ DQPSK Mode:

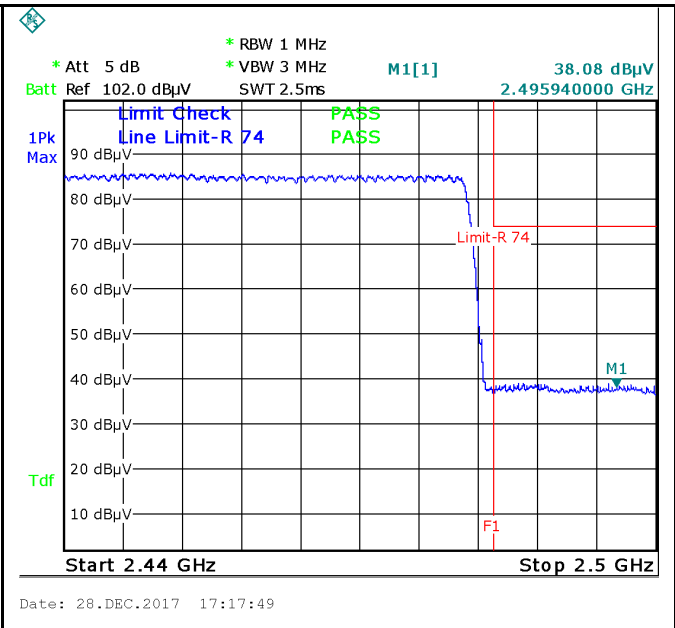
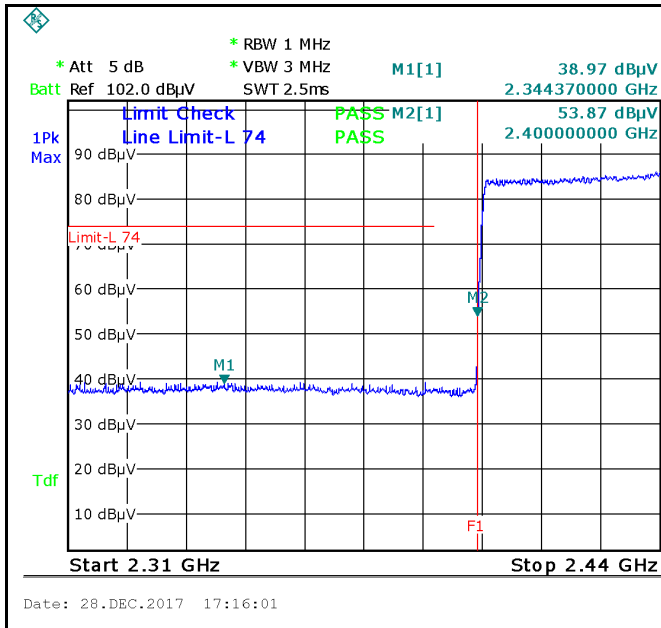

$\pi/4$ DQPSK-Hopping Left Side-PK
Note: F1 is frequency 2400MHz

$\pi/4$ DQPSK-Hopping Right Side-PK
Note: F1 is frequency 2483.5MHz

Note: (no need if PK value less than the AV limit)

Note: (no need if PK value less than the AV limit)

$\pi/4$ DQPSK-Hopping Left-AV

$\pi/4$ DQPSK-Hopping Right-AV

Note: Both Horizontal and vertical polarities were investigated.

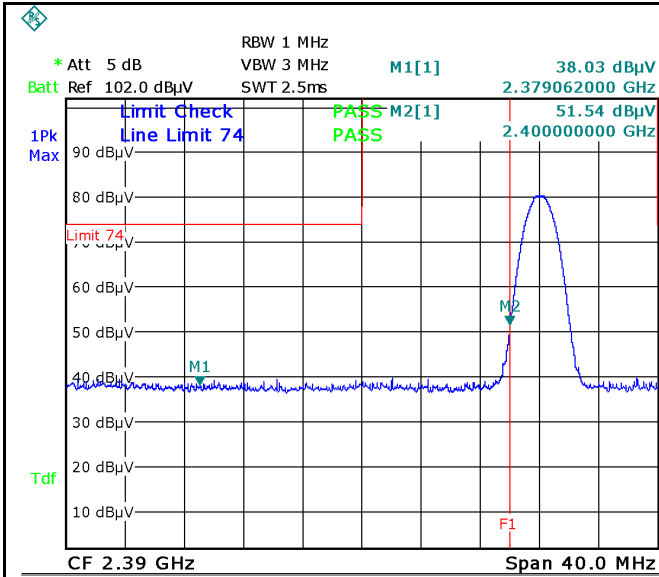

Date: 28.DEC.2017 17:11:25

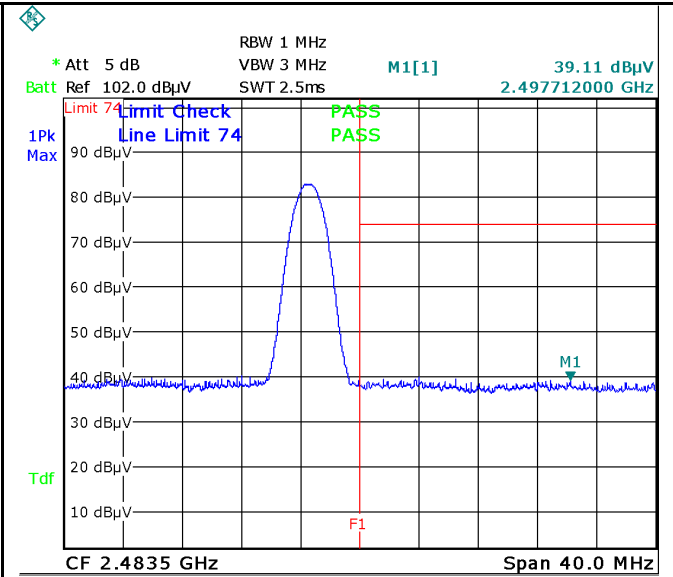

Date: 28.DEC.2017 17:08:23

π / 4 DQPSK-Left Side-PK

Note: F1 is frequency 2400MHz

π / 4 DQPSK-Right Side-PK

Note: F1 is frequency 2483.5MHz

Note: (no need if PK value less than the AV limit)

Note: (no need if PK value less than the AV limit)

π / 4 DQPSK-Left Side-AV

π / 4 DQPSK-Right Side-AV

Note: Both Horizontal and vertical polarities were investigated.

8-DPSK Mode:

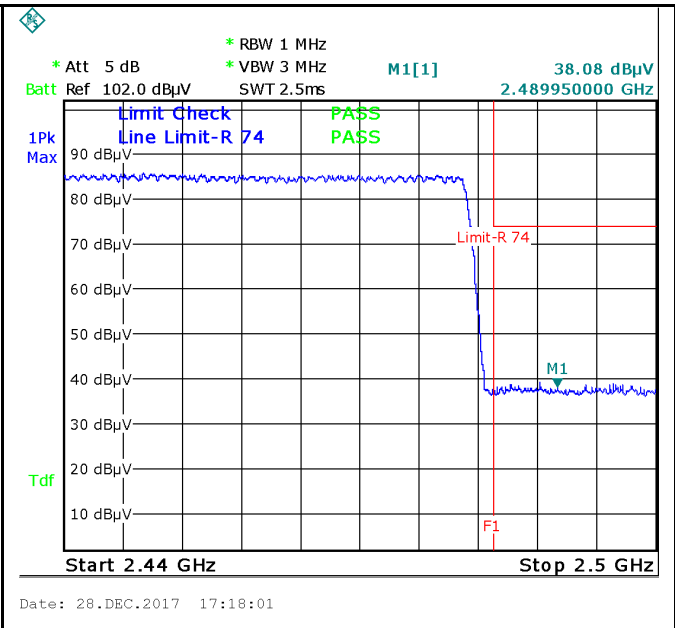
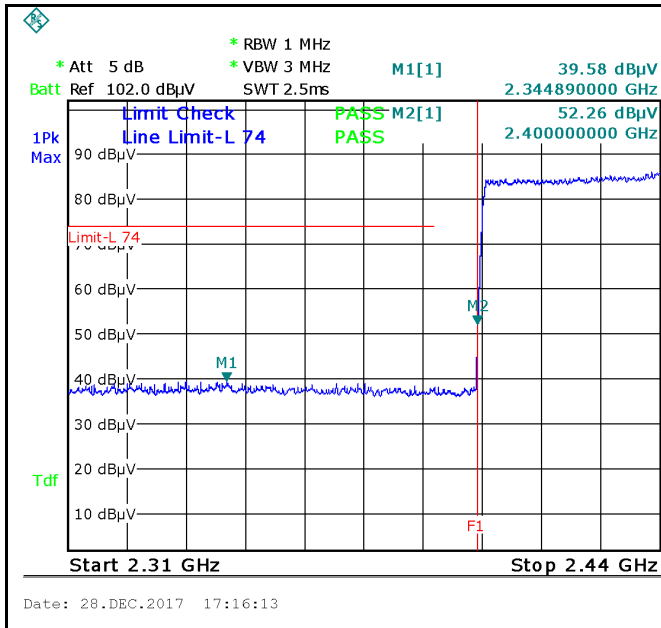

8DPSK-Hopping Left Side-PK

Note: F1 is frequency 2400MHz

8DPSK-Hopping Right Side-PK

Note: F1 is frequency 2483.5MHz

Note: (no need if PK value less than the AV limit)

Note: (no need if PK value less than the AV limit)

8DPSK-Hopping Left-AV

8DPSK-Hopping Right-AV

Note: Both Horizontal and vertical polarities were investigated.

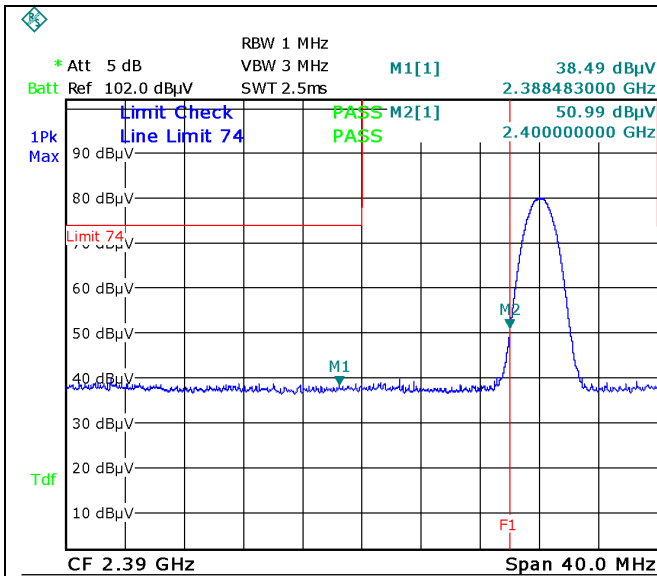

Date: 28.DEC.2017 17:11:49

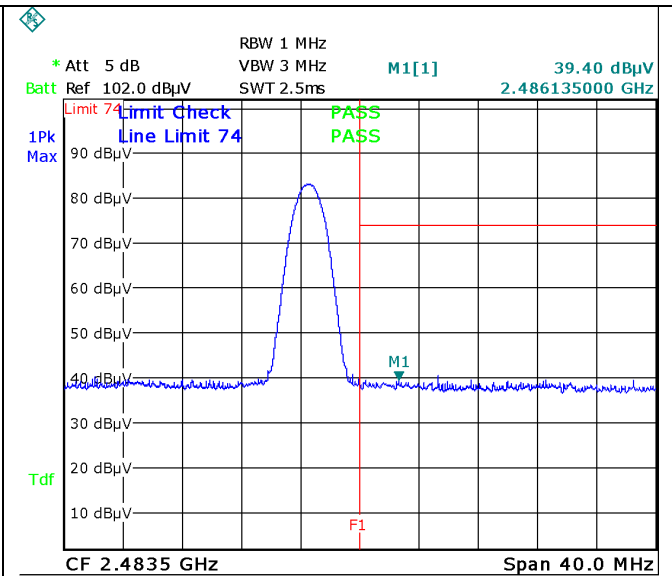

Date: 28.DEC.2017 17:08:41

8DPSK-Left Side-PK

Note: F1 is frequency 2400MHz

8DPSK-Right Side-PK

Note: F1 is frequency 2483.5MHz

Note: (no need if PK value less than the AV limit)

Note: (no need if PK value less than the AV limit)

8DPSK-Left Side-AV

8DPSK-Right Side-AV

Note: Both Horizontal and vertical polarities were investigated.

6.8 AC Power Line Conducted Emissions

Temperature	23°C
Relative Humidity	54%
Atmospheric Pressure	1020mbar
Test date :	December 28, 2017
Tested By :	Aarron Liang

Requirement(s):

Spec	Item	Requirement	Applicable														
47CFR§15.207, RSS210 (A8.1)	a)	For Low-power radio-frequency devices that is designed to be connected to the public utility (AC) power line, the radio frequency voltage that is conducted back onto the AC power line on any frequency or frequencies, within the band 150 kHz to 30 MHz, shall not exceed the limits in the following table, as measured using a 50 [μ]H/50 ohms line impedance stabilization network (LISN). The lower limit applies at the boundary between the frequencies ranges.	<input checked="" type="checkbox"/>														
		<table border="1"> <thead> <tr> <th rowspan="2">Frequency ranges (MHz)</th> <th colspan="2">Limit (dBμV)</th> </tr> <tr> <th>QP</th> <th>Average</th> </tr> </thead> <tbody> <tr> <td>0.15 ~ 0.5</td> <td>66 – 56</td> <td>56 – 46</td> </tr> <tr> <td>0.5 ~ 5</td> <td>56</td> <td>46</td> </tr> <tr> <td>5 ~ 30</td> <td>60</td> <td>50</td> </tr> </tbody> </table>		Frequency ranges (MHz)	Limit (dBμV)		QP	Average	0.15 ~ 0.5	66 – 56	56 – 46	0.5 ~ 5	56	46	5 ~ 30	60	50
		Frequency ranges (MHz)			Limit (dBμV)												
				QP	Average												
0.15 ~ 0.5	66 – 56	56 – 46															
0.5 ~ 5	56	46															
5 ~ 30	60	50															

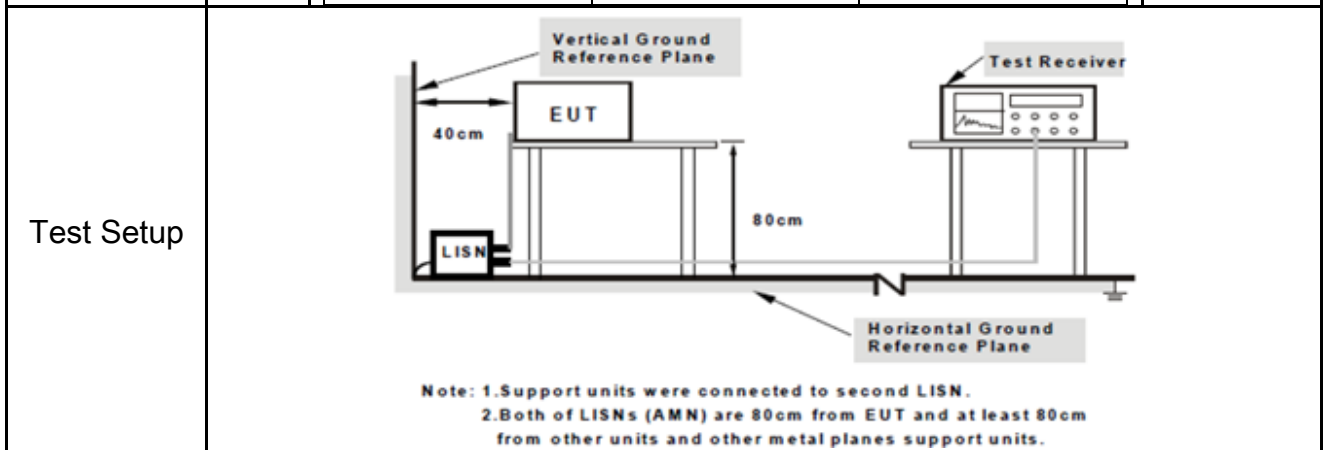

Procedure	<ol style="list-style-type: none"> The EUT and supporting equipment were set up in accordance with the requirements of the standard on top of a 1.5m x 1m x 0.8m high, non-metallic table. The power supply for the EUT was fed through a 50W/50mH EUT LISN, connected to filtered mains. The RF OUT of the EUT LISN was connected to the EMI test receiver via a low-loss
-----------	---

Test Report	17071472-FCC-R2
Page	37 of 66

	<p>coaxial cable.</p> <ol style="list-style-type: none"> 4. All other supporting equipment were powered separately from another main supply. 5. The EUT was switched on and allowed to warm up to its normal operating condition. 6. A scan was made on the NEUTRAL line (for AC mains) or Earth line (for DC power) over the required frequency range using an EMI test receiver. 7. High peaks, relative to the limit line, The EMI test receiver was then tuned to the selected frequencies and the necessary measurements made with a receiver bandwidth setting of 10 kHz. 8. Step 7 was then repeated for the LIVE line (for AC mains) or DC line (for DC power).
Remark	
Result	<input checked="" type="checkbox"/> Pass <input type="checkbox"/> Fail

Test Data Yes N/A

Test Plot Yes (See below) N/A

Test Mode:	Bluetooth Mode
-------------------	-----------------------

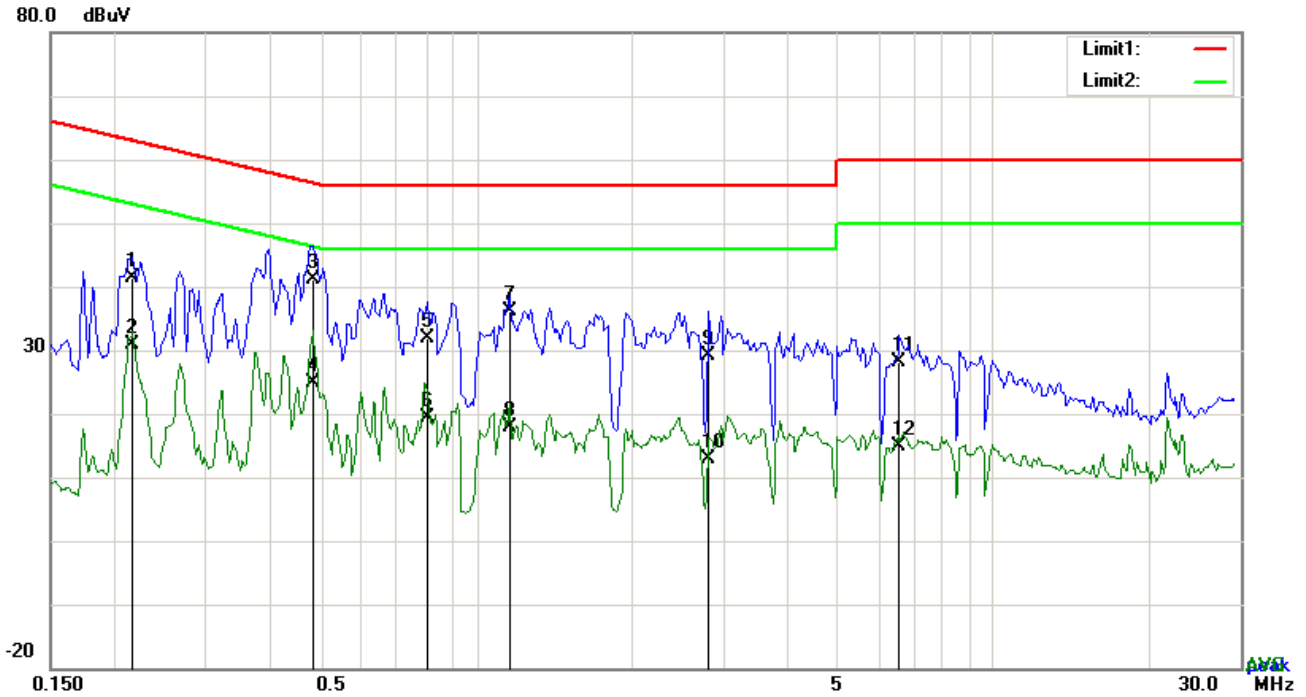

Test Data

Phase Line Plot at 120Vac, 60Hz

No.	P/L	Frequency	Reading	Detector	Corrected	Result	Limit	Margin
		(MHz)	(dBuV)		(dB)	(dBuV)	(dBuV)	(dB)
1	L1	0.2163	31.42	QP	10.03	41.45	62.96	-21.51
2	L1	0.2163	20.80	AVG	10.03	30.83	52.96	-22.13
3	L1	0.4815	31.07	QP	10.03	41.10	56.31	-15.21
4	L1	0.4815	14.96	AVG	10.03	24.99	46.31	-21.32
5	L1	0.8013	21.74	QP	10.03	31.77	56.00	-24.23
6	L1	0.8013	9.38	AVG	10.03	19.41	46.00	-26.59
7	L1	1.1640	25.98	QP	10.03	36.01	56.00	-19.99
8	L1	1.1640	7.75	AVG	10.03	17.78	46.00	-28.22
9	L1	2.8059	19.08	QP	10.05	29.13	56.00	-26.87
10	L1	2.8059	2.91	AVG	10.05	12.96	46.00	-33.04
11	L1	6.5763	18.14	QP	10.10	28.24	60.00	-31.76
12	L1	6.5763	4.87	AVG	10.10	14.97	50.00	-35.03

Test Mode:	Bluetooth Mode
-------------------	-----------------------

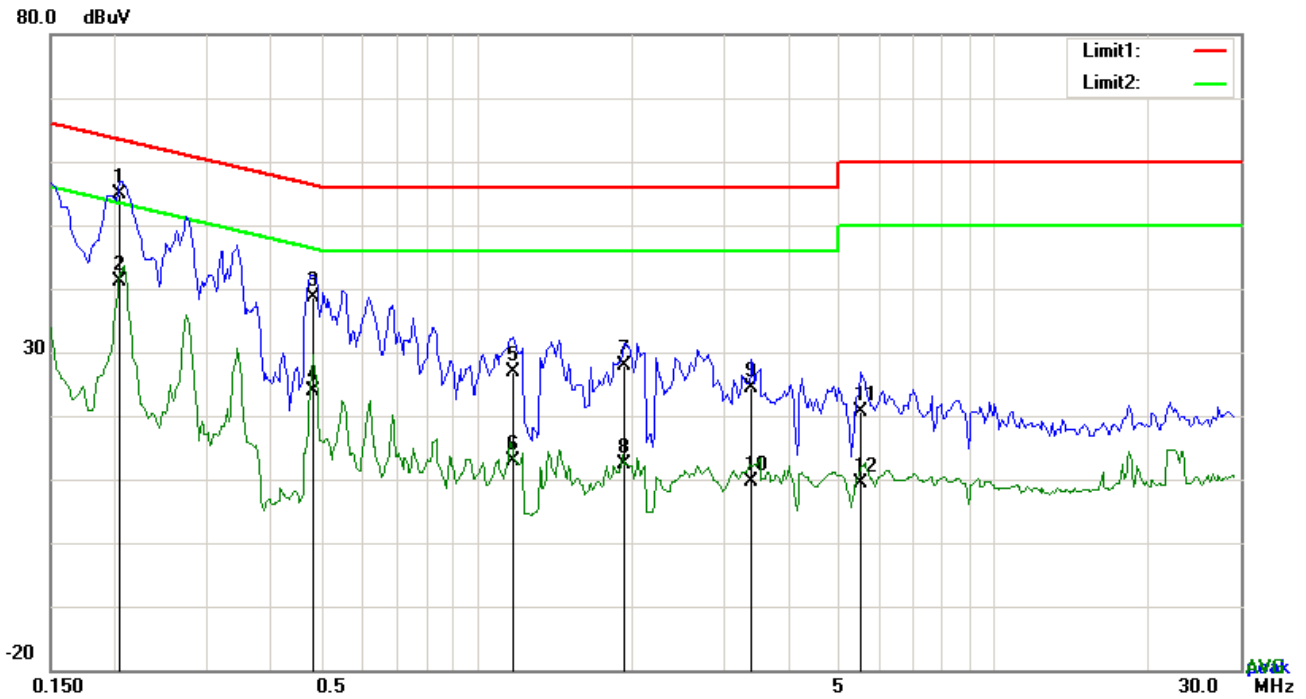

Test Data

Phase Neutral Plot at 120Vac, 60Hz

No.	P/L	Frequency	Reading	Detector	Corrected	Result	Limit	Margin
		(MHz)	(dBuV)		(dB)	(dBuV)	(dBuV)	(dB)
1	N	0.2046	44.76	QP	10.02	54.78	63.42	-8.64
2	N	0.2046	31.21	AVG	10.02	41.23	53.42	-12.19
3	N	0.4815	28.69	QP	10.02	38.71	56.31	-17.60
4	N	0.4815	13.81	AVG	10.02	23.83	46.31	-22.48
5	N	1.1796	16.78	QP	10.03	26.81	56.00	-29.19
6	N	1.1796	2.86	AVG	10.03	12.89	46.00	-33.11
7	N	1.9362	17.82	QP	10.04	27.86	56.00	-28.14
8	N	1.9362	2.38	AVG	10.04	12.42	46.00	-33.58
9	N	3.4095	14.44	QP	10.05	24.49	56.00	-31.51
10	N	3.4095	-0.53	AVG	10.05	9.52	46.00	-36.48
11	N	5.5233	10.62	QP	10.08	20.70	60.00	-39.30
12	N	5.5233	-0.58	AVG	10.08	9.50	50.00	-40.50

Test Mode:	Bluetooth Mode
-------------------	-----------------------

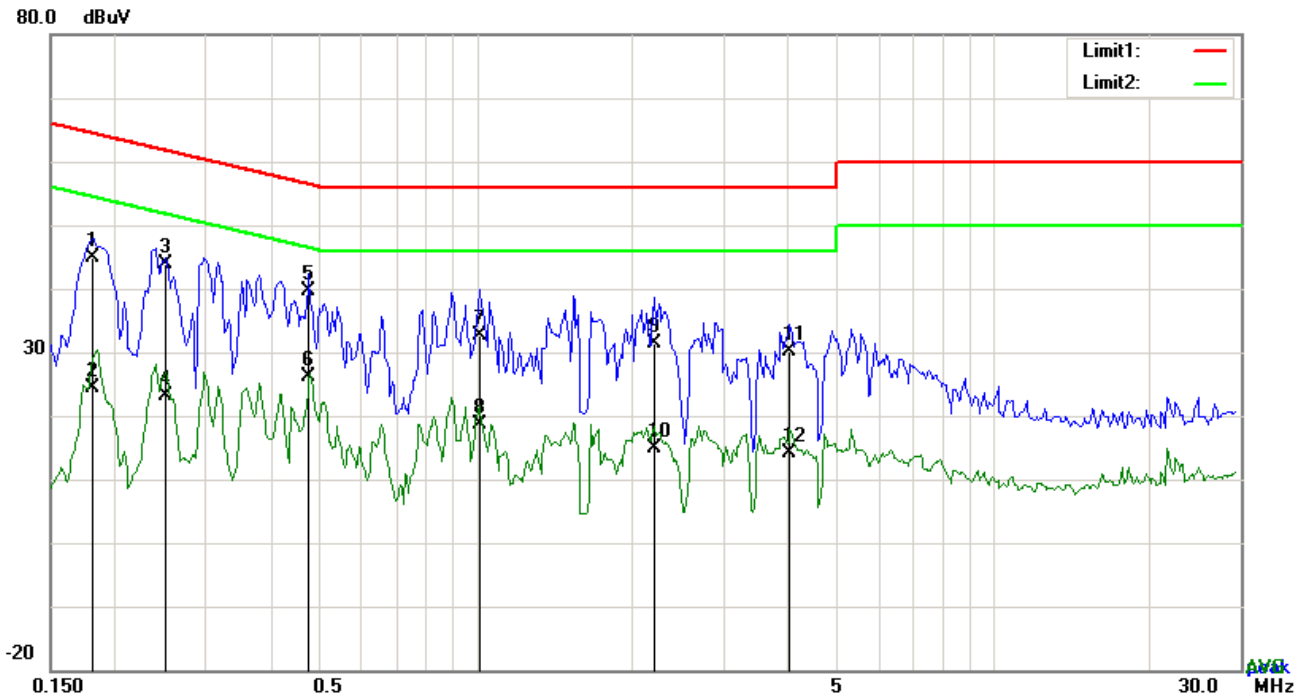

Test Data

Phase Line Plot at 240Vac, 60Hz

No.	P/L	Frequency	Reading	Detector	Corrected	Result	Limit	Margin
		(MHz)	(dBuV)		(dB)	(dBuV)	(dBuV)	(dB)
1	L1	0.1812	34.83	QP	10.03	44.86	64.43	-19.57
2	L1	0.1812	14.31	AVG	10.03	24.34	54.43	-30.09
3	L1	0.2514	33.76	QP	10.03	43.79	61.71	-17.92
4	L1	0.2514	12.98	AVG	10.03	23.01	51.71	-28.70
5	L1	0.4737	29.55	QP	10.03	39.58	56.45	-16.87
6	L1	0.4737	16.09	AVG	10.03	26.12	46.45	-20.33
7	L1	1.0119	22.51	QP	10.03	32.54	56.00	-23.46
8	L1	1.0119	8.65	AVG	10.03	18.68	46.00	-27.32
9	L1	2.2053	21.25	QP	10.05	31.30	56.00	-24.70
10	L1	2.2053	4.83	AVG	10.05	14.88	46.00	-31.12
11	L1	4.0374	20.10	QP	10.07	30.17	56.00	-25.83
12	L1	4.0374	4.08	AVG	10.07	14.15	46.00	-31.85

Test Mode:	Bluetooth Mode
-------------------	-----------------------

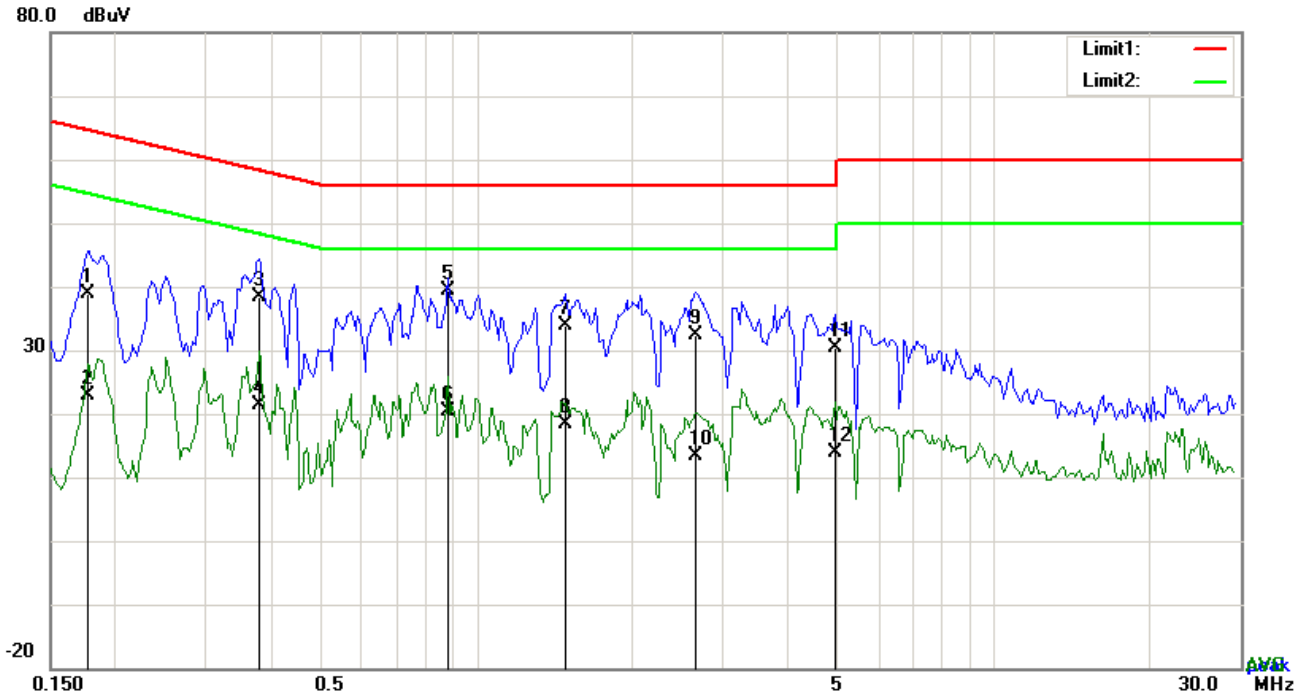

Test Data

Phase Neutral Plot at 240Vac, 60Hz

No.	P/L	Frequency	Reading	Detector	Corrected	Result	Limit	Margin
		(MHz)	(dBuV)		(dB)	(dBuV)	(dBuV)	(dB)
1	N	0.1773	28.78	QP	10.02	38.80	64.61	-25.81
2	N	0.1773	12.76	AVG	10.02	22.78	54.61	-31.83
3	N	0.3801	28.25	QP	10.02	38.27	58.28	-20.01
4	N	0.3801	11.33	AVG	10.02	21.35	48.28	-26.93
5	N	0.8832	29.25	QP	10.03	39.28	56.00	-16.72
6	N	0.8832	10.42	AVG	10.03	20.45	46.00	-25.55
7	N	1.4838	23.90	QP	10.03	33.93	56.00	-22.07
8	N	1.4838	8.37	AVG	10.03	18.40	46.00	-27.60
9	N	2.6577	22.45	QP	10.05	32.50	56.00	-23.50
10	N	2.6577	3.27	AVG	10.05	13.32	46.00	-32.68
11	N	4.9422	20.34	QP	10.07	30.41	56.00	-25.59
12	N	4.9422	3.73	AVG	10.07	13.80	46.00	-32.20

6.9 Radiated Emissions & Restricted Band

Temperature	23°C
Relative Humidity	54%
Atmospheric Pressure	1020mbar
Test date :	December 28, 2017
Tested By :	Aarron Liang

Requirement(s):

Spec	Item	Requirement	Applicable																
47CFR§15.205, §15.209, §15.247(d)	a)	Except higher limit as specified elsewhere in other section, the emissions from the low-power radio-frequency devices shall not exceed the field strength levels specified in the following table and the level of any unwanted emissions shall not exceed the level of the fundamental emission. The tighter limit applies at the band edges	<input checked="" type="checkbox"/>																
		<table border="1"> <thead> <tr> <th>Frequency range (MHz)</th> <th>Field Strength ($\mu\text{V}/\text{m}$)</th> </tr> </thead> <tbody> <tr> <td>0.009~0.490</td> <td>2400/F(KHz)</td> </tr> <tr> <td>0.490~1.705</td> <td>24000/F(KHz)</td> </tr> <tr> <td>1.705~30.0</td> <td>30</td> </tr> <tr> <td>30 – 88</td> <td>100</td> </tr> <tr> <td>88 – 216</td> <td>150</td> </tr> <tr> <td>216 960</td> <td>200</td> </tr> <tr> <td>Above 960</td> <td>500</td> </tr> </tbody> </table>		Frequency range (MHz)	Field Strength ($\mu\text{V}/\text{m}$)	0.009~0.490	2400/F(KHz)	0.490~1.705	24000/F(KHz)	1.705~30.0	30	30 – 88	100	88 – 216	150	216 960	200	Above 960	500
		Frequency range (MHz)		Field Strength ($\mu\text{V}/\text{m}$)															
		0.009~0.490		2400/F(KHz)															
		0.490~1.705		24000/F(KHz)															
		1.705~30.0		30															
		30 – 88		100															
		88 – 216		150															
216 960	200																		
Above 960	500																		

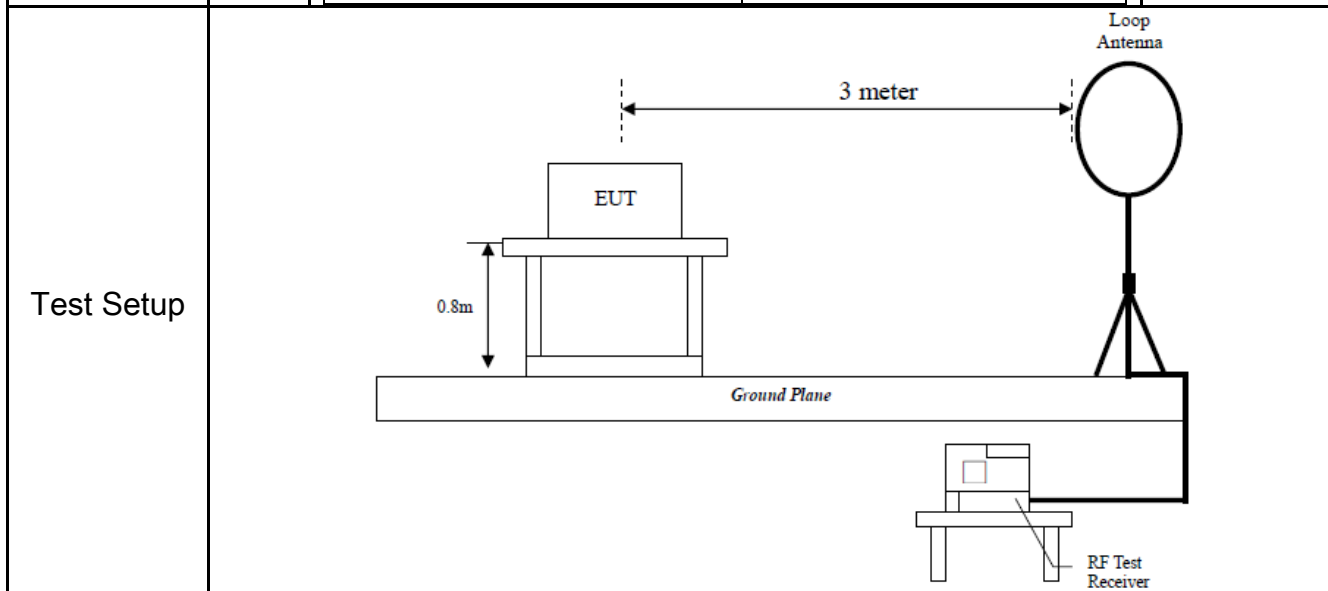

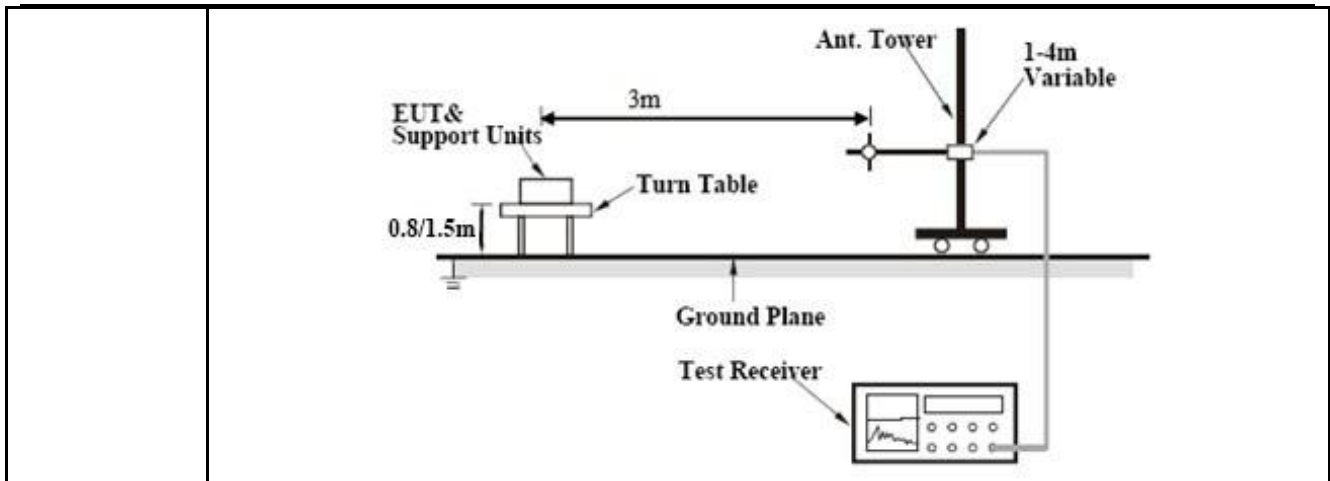

Procedure

- The EUT was switched on and allowed to warm up to its normal operating condition.
- The test was carried out at the selected frequency points obtained from the EUT characterization. Maximization of the emissions, was carried out by rotating the EUT, changing the antenna polarization, and adjusting the antenna height in the following manner:
 - Vertical or horizontal polarization (whichever gave the higher emission level over a full rotation of the EUT) was chosen.
 - The EUT was then rotated to the direction that gave the maximum emission.
 - Finally, the antenna height was adjusted to the height that gave the maximum emission.
- The resolution bandwidth and video bandwidth of test receiver/spectrum analyzer is 120 kHz for Quasi Peak detection at frequency below 1GHz.
- The resolution bandwidth of test receiver/spectrum analyzer is 1MHz and video bandwidth is 3MHz with Peak detection for Peak measurement at frequency above 1GHz.
The resolution bandwidth of test receiver/spectrum analyzer is 1MHz and the video bandwidth is 10Hz with Peak detection for Average Measurement as below at frequency above 1GHz.
- Steps 2 and 3 were repeated for the next frequency point, until all selected frequency points were measured.

Remark

Result Pass Fail

Test Data Yes N/A

Test Plot Yes (See below) N/A

Test Result:

Test Mode:	Transmitting Mode
-------------------	-------------------

Frequency range: 9KHz - 30MHz

Freq. (MHz)	Detection value	Factor (dB/m)	Reading (dBuV/m)	Result (dBuV/m)	Limit@3m (dBuV/m)	Margin (dB)
--	--	--	--	--	--	>20
--	--	--	--	--	--	>20

Note:

The amplitude of spurious emissions which are attenuated by more than 20dB below the permissible value has no need to be reported.

Distance extrapolation factor = $40 \log(\text{specific distance}/\text{test distance})$ (dB);

Limit line = specific limits(dBuv) + distance extrapolation factor.

Test Mode:	Bluetooth Mode
-------------------	-----------------------

30MHz -1GHz

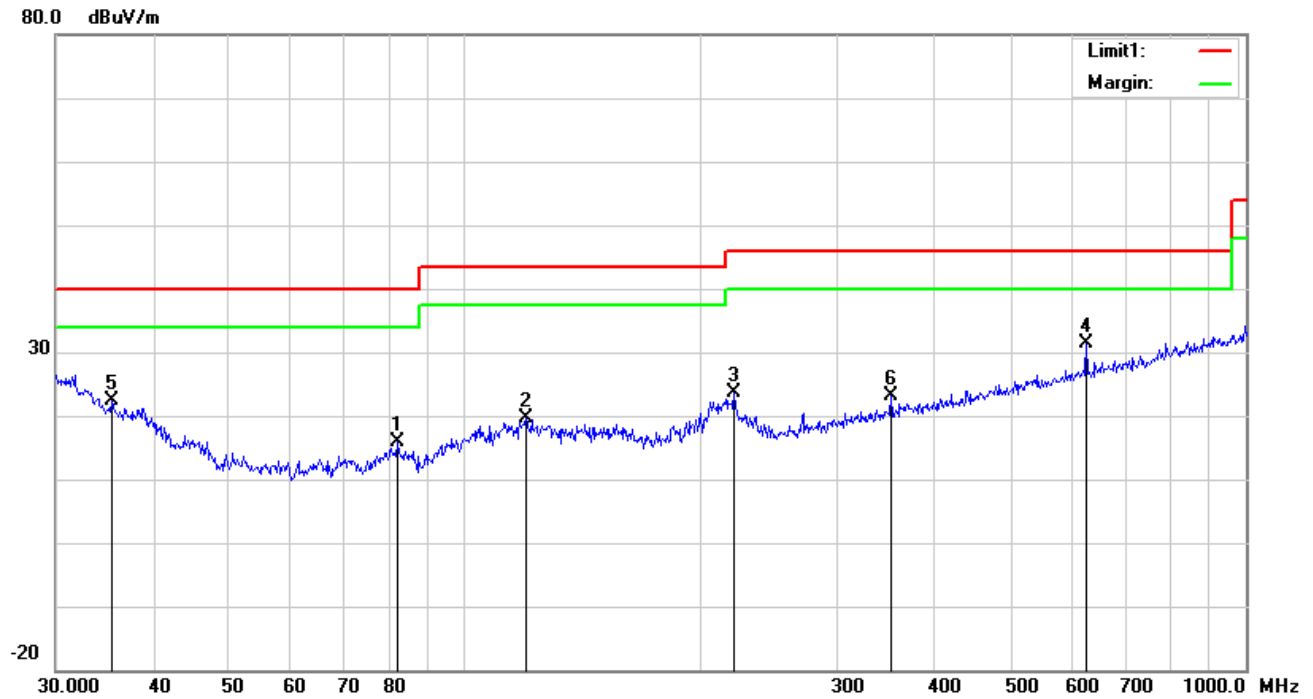

Test Data

Horizontal Polarity Plot @3m

No.	P/L	Frequency	Reading	Detect or	Ant_F	PA_G	Cab_L	Result	Limit	Margin	Height	Degree
		(MHz)	(dBuV/m)		(dB/m)	(dB)	(dB)	(dBuV/m)	(dBuV/m)	(dB)	(cm)	(°)
1	H	82.0706	29.53	peak	7.68	22.40	1.06	15.87	40.00	-24.13	100	345
2	H	119.8556	27.04	peak	13.87	22.36	1.16	19.71	43.50	-23.79	100	179
3	H	221.3921	32.68	peak	11.80	22.34	1.61	23.75	46.00	-22.25	100	228
4	H	625.0780	30.93	peak	19.38	21.52	2.56	31.35	46.00	-14.65	200	265
5	H	35.3750	26.58	peak	17.28	22.25	0.76	22.37	40.00	-17.63	100	38
6	H	351.7079	28.60	peak	14.69	22.15	2.04	23.18	46.00	-22.82	100	297

30MHz -1GHz

80.0 dBuV/m

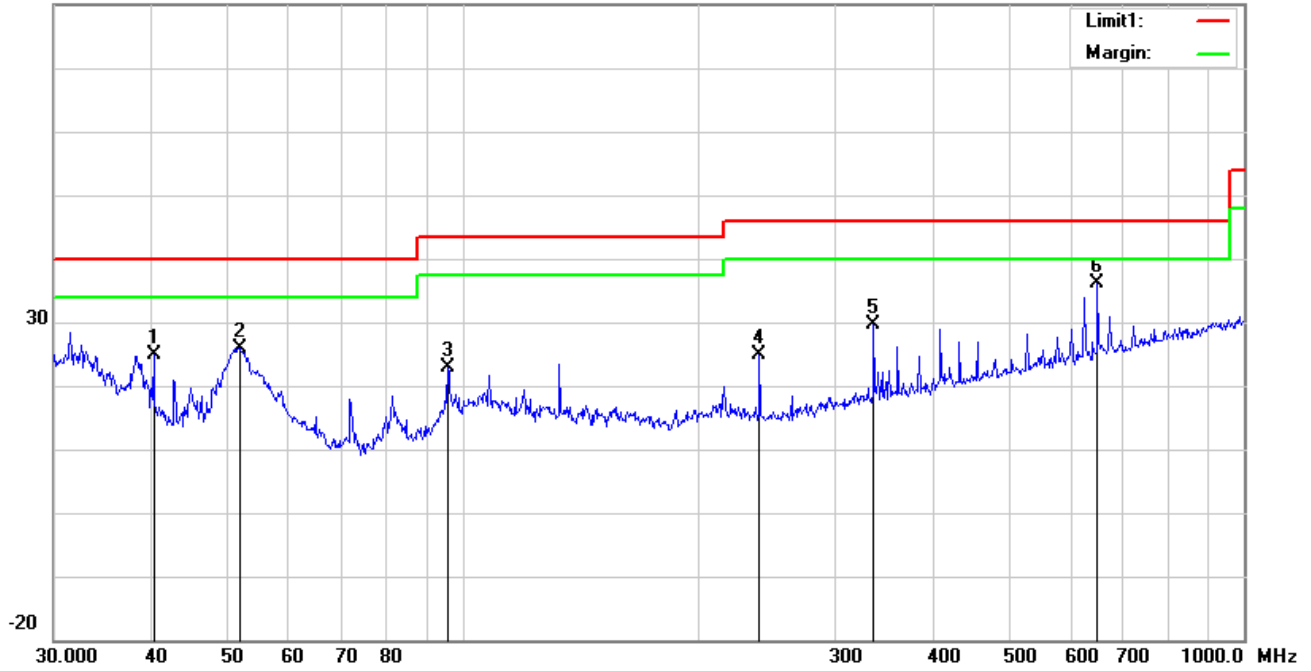

Test Data

Vertical Polarity Plot @3m

No.	P/L	Frequency (MHz)	Reading (dBuV/m)	Detect or	Ant_F (dB/m)	PA_G (dB)	Cab_L (dB)	Result (dBuV/m)	Limit (dBuV/m)	Margin (dB)	Height (cm)	Degr ee ()
1	V	40.2757	32.71	peak	13.72	22.28	0.79	24.94	40.00	-15.06	100	311
2	V	52.0251	39.37	peak	8.18	22.39	0.79	25.95	40.00	-14.05	100	113
3	V	95.7622	34.70	peak	9.38	22.32	1.01	22.77	43.50	-20.73	100	90
4	V	239.9873	34.01	peak	11.54	22.31	1.67	24.91	46.00	-21.09	100	144
5	V	336.0352	35.47	peak	14.36	22.19	1.97	29.61	46.00	-16.39	100	119
6	V	649.6597	35.21	peak	19.65	21.47	2.63	36.02	46.00	-9.98	100	315

Above 1GHz

Test Mode:	Transmitting Mode
-------------------	--------------------------

Low Channel: 8-DPSK Mode (Worst Case) (2402 MHz)

Frequency (MHz)	S.A. Reading (dBμV)	Detector (PK/AV)	Polarity (H/V)	Ant. Factor (dB/m)	Cable Loss (dB)	Pre-Amp. Gain (dB)	Cord. Amp. (dBμV/m)	Limit (dBμV/m)	Margin (dB)
4804	48.17	AV	V	33.39	7.22	48.46	40.32	54	-13.68
4804	47.18	AV	H	33.39	7.22	48.46	39.33	54	-14.67
4804	70.51	PK	V	33.39	7.22	48.46	62.66	74	-11.34
4804	65.37	PK	H	33.39	7.22	48.46	57.52	74	-16.48
7893	33.5	AV	V	36.76	7.39	47.36	30.29	54	-23.71
7893	34.04	AV	H	36.76	7.39	47.36	30.83	54	-23.17
7893	54.86	PK	V	36.76	7.39	47.36	51.65	74	-22.35
7893	57.09	PK	H	36.76	7.39	47.36	53.88	74	-20.12

Middle Channel: 8-DPSK Mode (Worst Case) (2441 MHz)

Frequency (MHz)	S.A. Reading (dBμV)	Detector (PK/AV)	Polarity (H/V)	Ant. Factor (dB/m)	Cable Loss (dB)	Pre-Amp. Gain (dB)	Cord. Amp. (dBμV/m)	Limit (dBμV/m)	Margin (dB)
4882	49.04	AV	V	33.62	7.53	48.36	41.83	54	-12.17
4882	47.55	AV	H	33.62	7.53	48.36	40.34	54	-13.66
4882	70.62	PK	V	33.62	7.53	48.36	63.41	74	-10.59
4882	62.46	PK	H	33.62	7.53	48.36	55.25	74	-18.75
13431	28.72	AV	V	40.62	12.96	46.38	35.92	54	-18.08
13431	28.39	AV	H	40.62	12.96	46.38	35.59	54	-18.41
13431	49.14	PK	V	40.62	12.96	46.38	56.34	74	-17.66
13431	43.62	PK	H	40.62	12.96	46.38	50.82	74	-23.18

High Channel: 8-DPSK Mode (Worst Case) (2480 MHz)

Frequency (MHz)	S.A. Reading (dB μ V)	Detector (PK/AV)	Polarity (H/V)	Ant. Factor (dB/m)	Cable Loss (dB)	Pre-Amp. Gain (dB)	Cord. Amp. (dB μ V/m)	Limit (dB μ V/m)	Margin (dB)
4960	49.69	AV	V	33.89	7.86	48.31	43.13	54	-10.87
4960	47.08	AV	H	33.89	7.86	48.31	40.52	54	-13.48
4960	67.58	PK	V	33.89	7.86	48.31	61.02	74	-12.98
4960	66.86	PK	H	33.89	7.86	48.31	60.30	74	-13.70
17787	19.94	AV	V	43.44	19.58	45.27	37.69	54	-16.31
17787	19.89	AV	H	43.44	19.58	45.27	37.64	54	-16.36
17787	41.05	PK	V	43.44	19.58	45.27	58.80	74	-15.20
17787	42.59	PK	H	43.44	19.58	45.27	60.34	74	-13.66

Note:

1, The testing has been conformed to $10 \times 2480\text{MHz} = 24,800\text{MHz}$

2, All other emissions more than 30 dB below the limit

3, X-Axis, Y-Axis and Z-Axis were investigated. The results above show only the worst case.

4, The radiated spurious test above 18GHz is subcontracted to SIEMIC (Nanjing-China) Laboratories. and found 30dB below the limit at least.

Annex A. TEST INSTRUMENT

Instrument	Model	Serial #	Cal Date	Cal Due	In use
AC Line Conducted					
EMI test receiver	ESCS30	8471241027	09/15/2017	09/14/2018	<input checked="" type="checkbox"/>
Line Impedance	LI-125A	191106	09/23/2017	09/22/2018	<input checked="" type="checkbox"/>
Line Impedance	LI-125A	191107	09/23/2017	09/22/2018	<input checked="" type="checkbox"/>
ISN	ISN T800	34373	09/23/2017	09/22/2018	<input type="checkbox"/>
Transient Limiter	LIT-153	531118	08/30/2017	08/29/2018	<input type="checkbox"/>
RF conducted test					
Agilent ESA-E SERIES	E4407B	MY45108319	09/15/2017	09/14/2018	<input checked="" type="checkbox"/>
Power Splitter	1#	1#	08/30/2017	08/29/2018	<input checked="" type="checkbox"/>
DC Power Supply	E3640A	MY40004013	09/15/2017	09/14/2018	<input checked="" type="checkbox"/>
Radiated Emissions					
EMI test receiver	ESL6	100262	09/15/2017	09/14/2018	<input checked="" type="checkbox"/>
Positioning Controller	UC3000	MF780208282	11/17/2017	11/16/2018	<input checked="" type="checkbox"/>
OPT 010 AMPLIFIER (0.1-1300MHz)	8447E	2727A02430	08/30/2017	08/29/2018	<input checked="" type="checkbox"/>
Microwave Preamplifier (1 ~ 26.5GHz)	8449B	3008A02402	03/23/2017	03/22/2018	<input checked="" type="checkbox"/>
Horn Antenna	BBHA9170	3145226D1	09/27/2017	09/26/2018	<input checked="" type="checkbox"/>
Active Antenna (9kHz-30MHz)	AL-130	121031	10/12/2017	10/11/2018	<input checked="" type="checkbox"/>
Bilog Antenna (30MHz~6GHz)	JB6	A110712	09/19/2017	09/18/2018	<input checked="" type="checkbox"/>
Double Ridge Horn Antenna (1 ~18GHz)	AH-118	71283	09/22/2017	09/21/2018	<input checked="" type="checkbox"/>
Universal Radio Communication Tester	CMU200	121393	09/23/2017	09/22/2018	<input checked="" type="checkbox"/>

Annex B. EUT And Test Setup Photographs

Annex B.i. Photograph: EUT External Photo

Whole Package View



Adapter - Label View



EUT - Front View



EUT - Rear View



EUT - Top View



EUT - Bottom View



EUT - Left View



EUT - Right View



Annex B.ii. Photograph: EUT Internal Photo

Cover Off - Top View 1



Cover Off - Top View 2

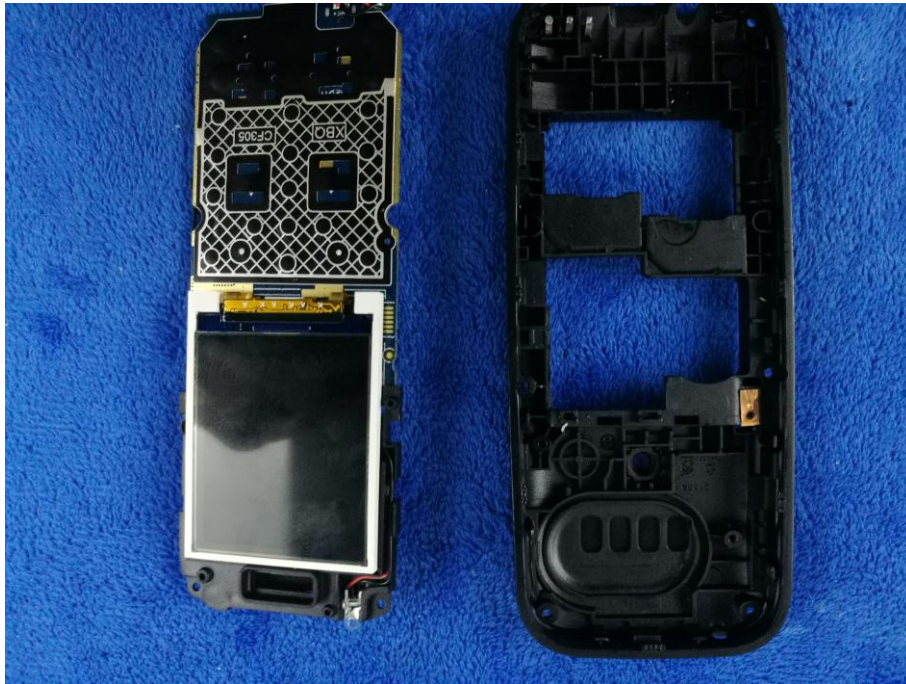

Battery - Front View



Battery - Rear View



Mainboard with Shielding - Front View



Mainboard without Shielding - Front View

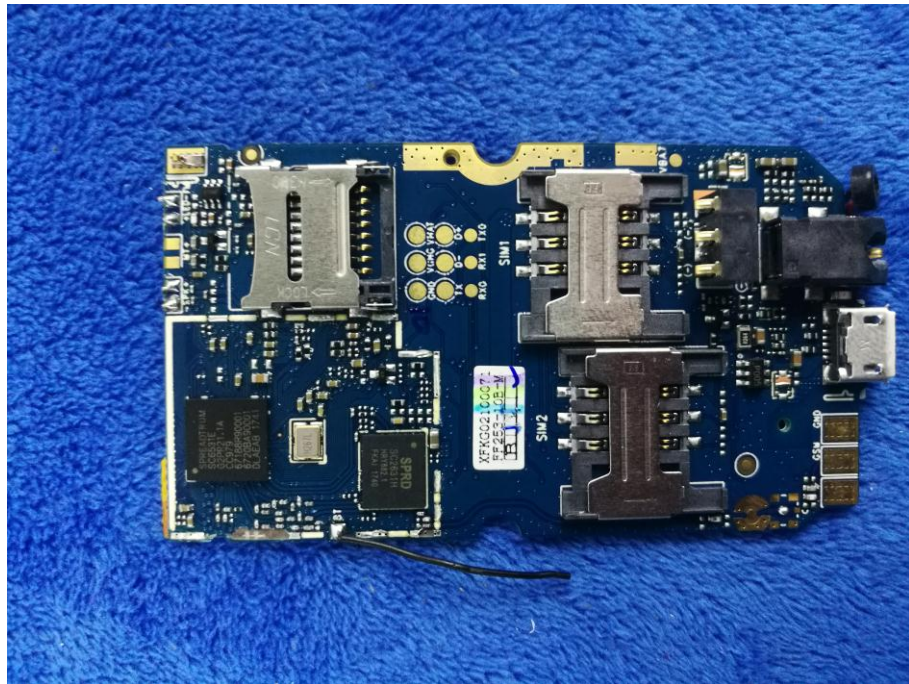

Mainboard with Shielding – Rear View

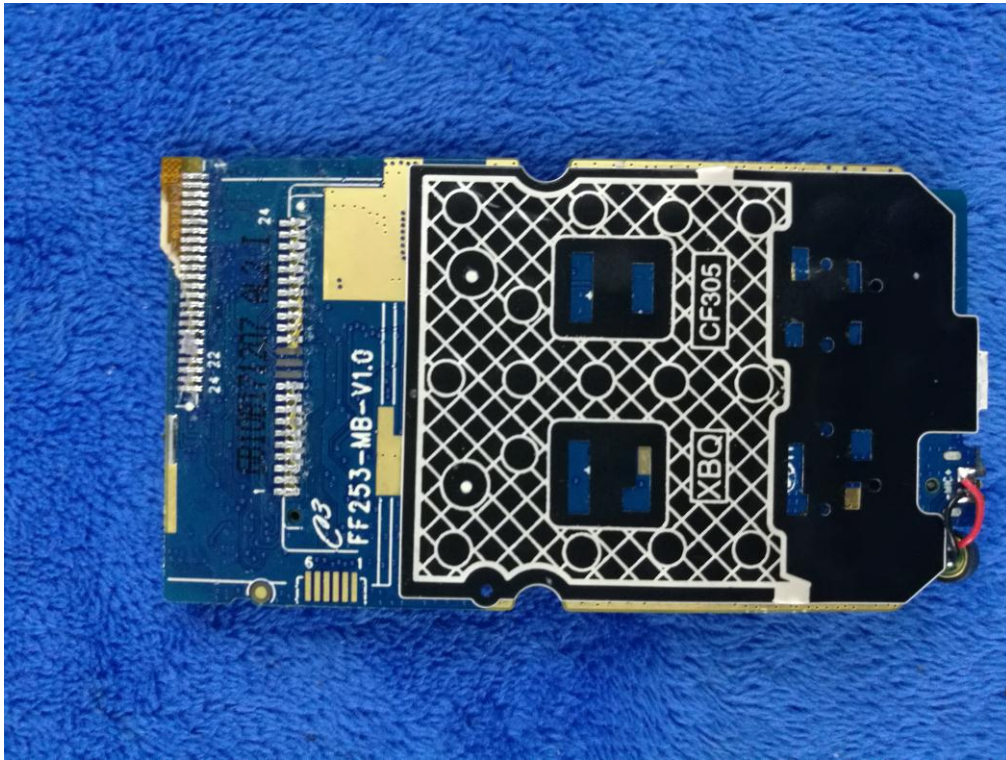

Mainboard without Shielding – Rear View

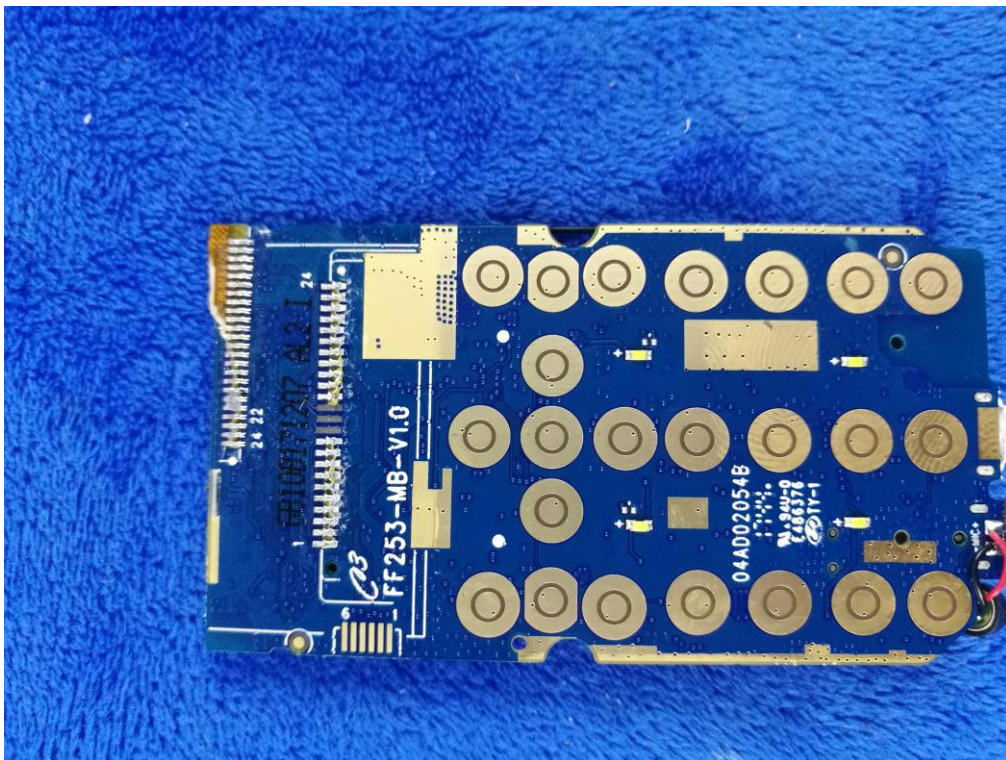

LCD – Front View

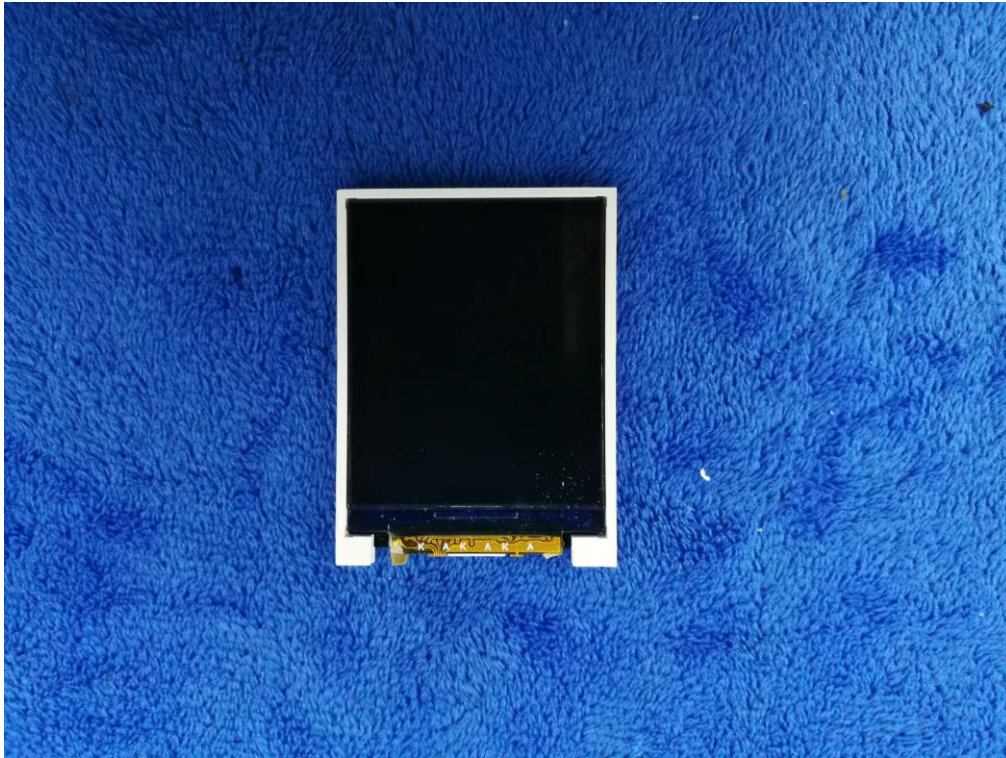

LCD – Rear View



GSM/PCS Antenna View



BT - Antenna View

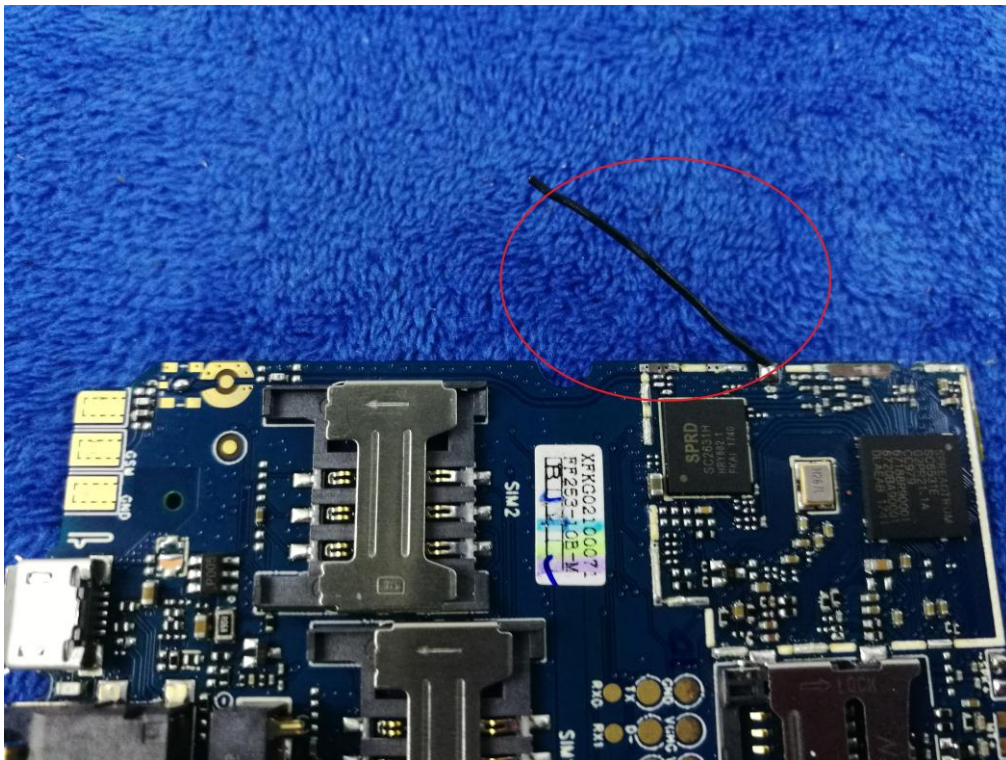

Annex B.iii. Photograph: Test Setup Photo



Conducted Emissions Test Setup Front View



Conducted Emissions Test Setup Side View

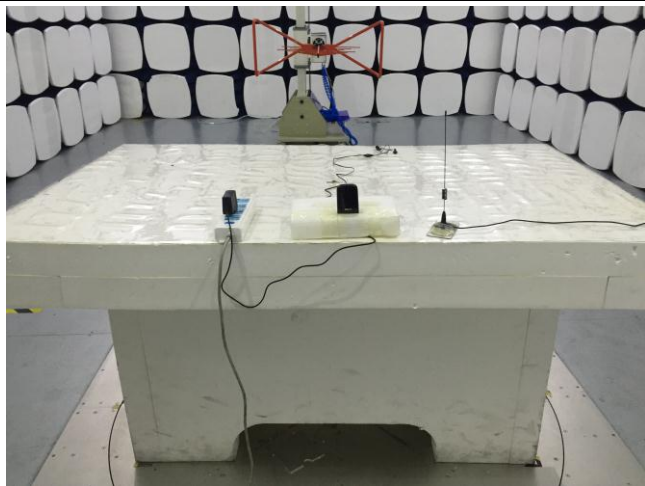

Radiated Spurious Emissions Test Setup Below 1GHz



Radiated Spurious Emissions Test Setup Above
1GHz

Annex C. TEST SETUP AND SUPPORTING EQUIPMENT

Annex C.ii. TEST SET UP BLOCK

Block Configuration Diagram for AC Line Conducted Emissions

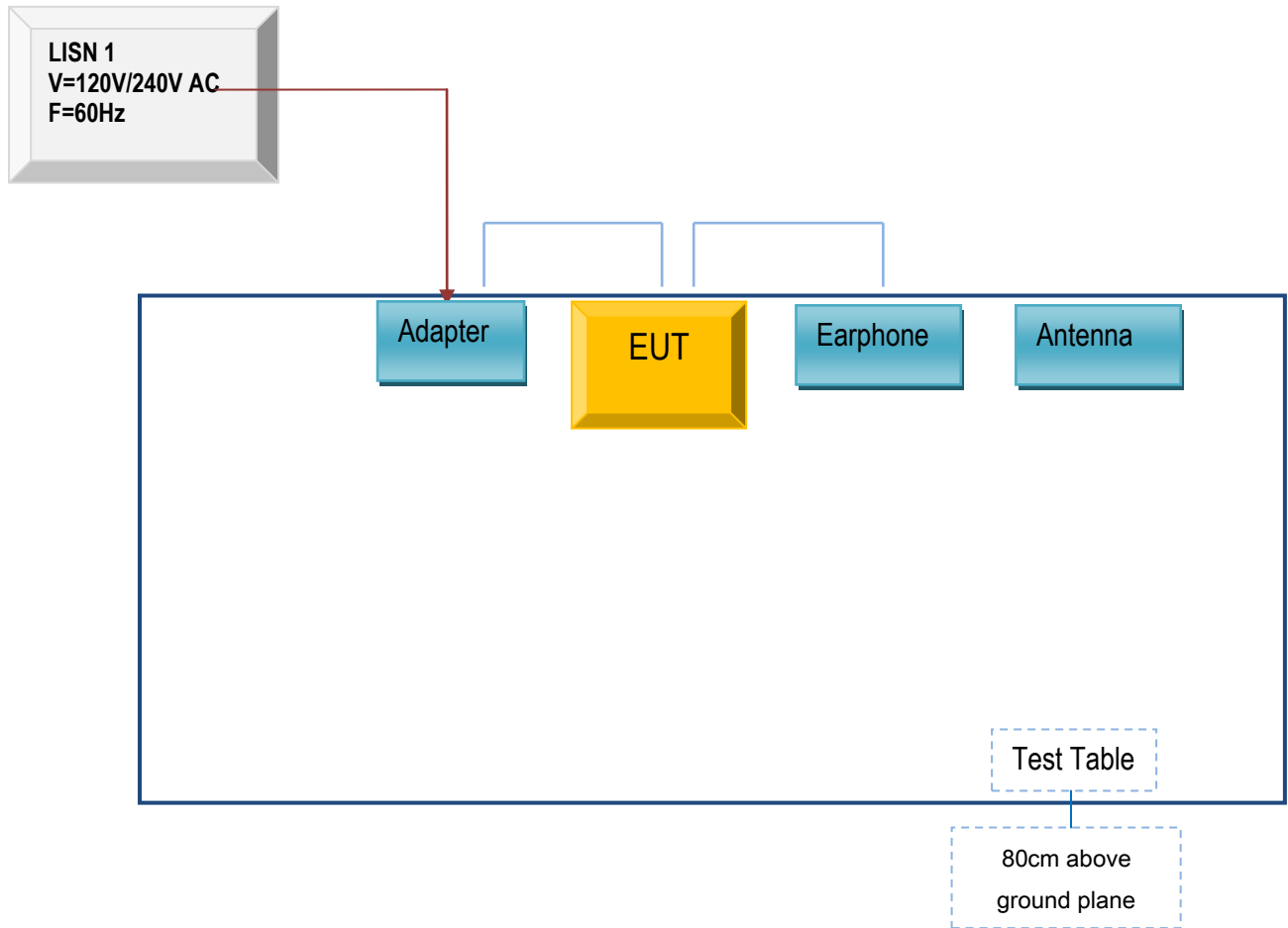

Block Configuration Diagram for Radiated Emissions (Below 1GHz) .

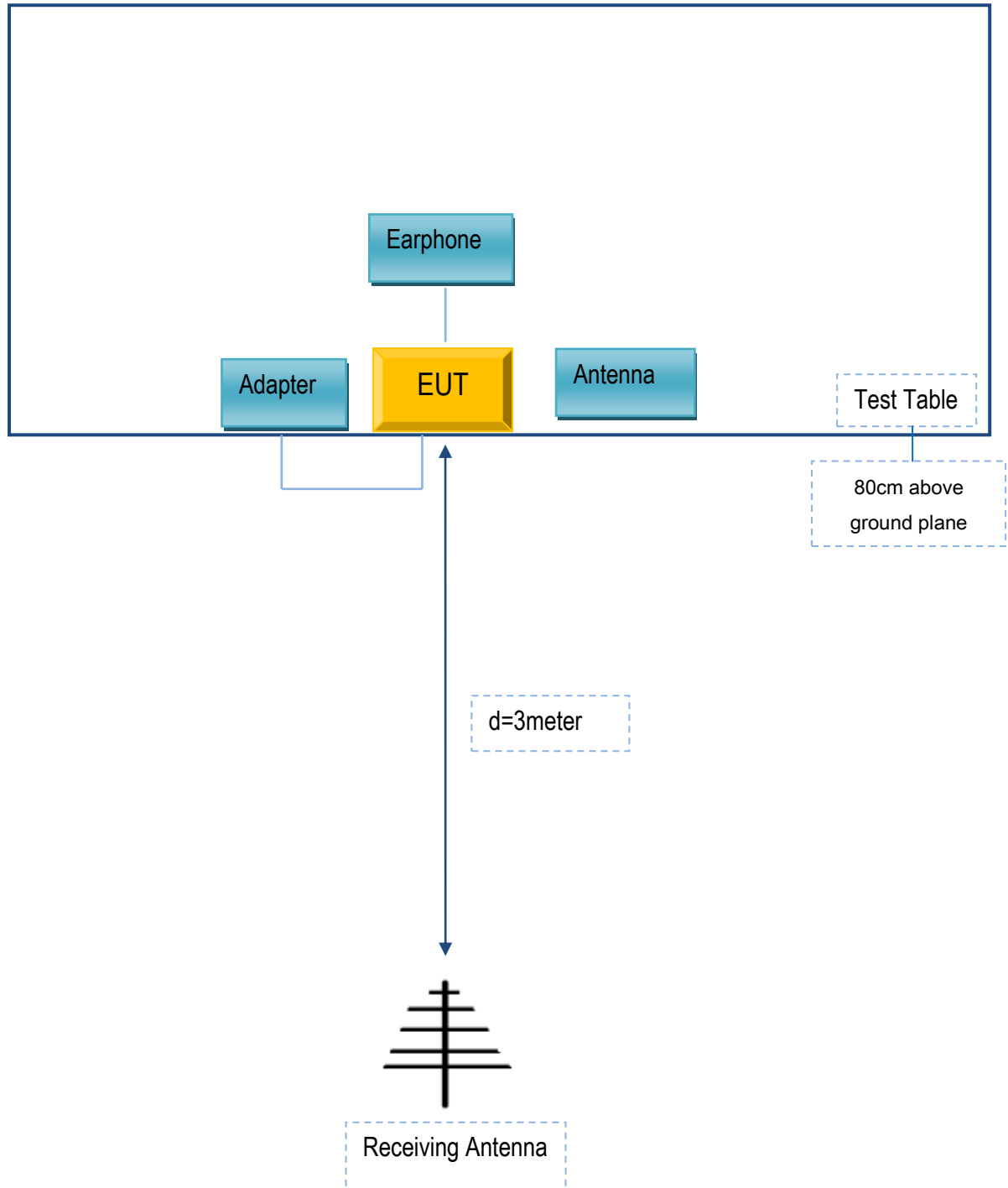

Block Configuration Diagram for Radiated Emissions (Above 1GHz) .

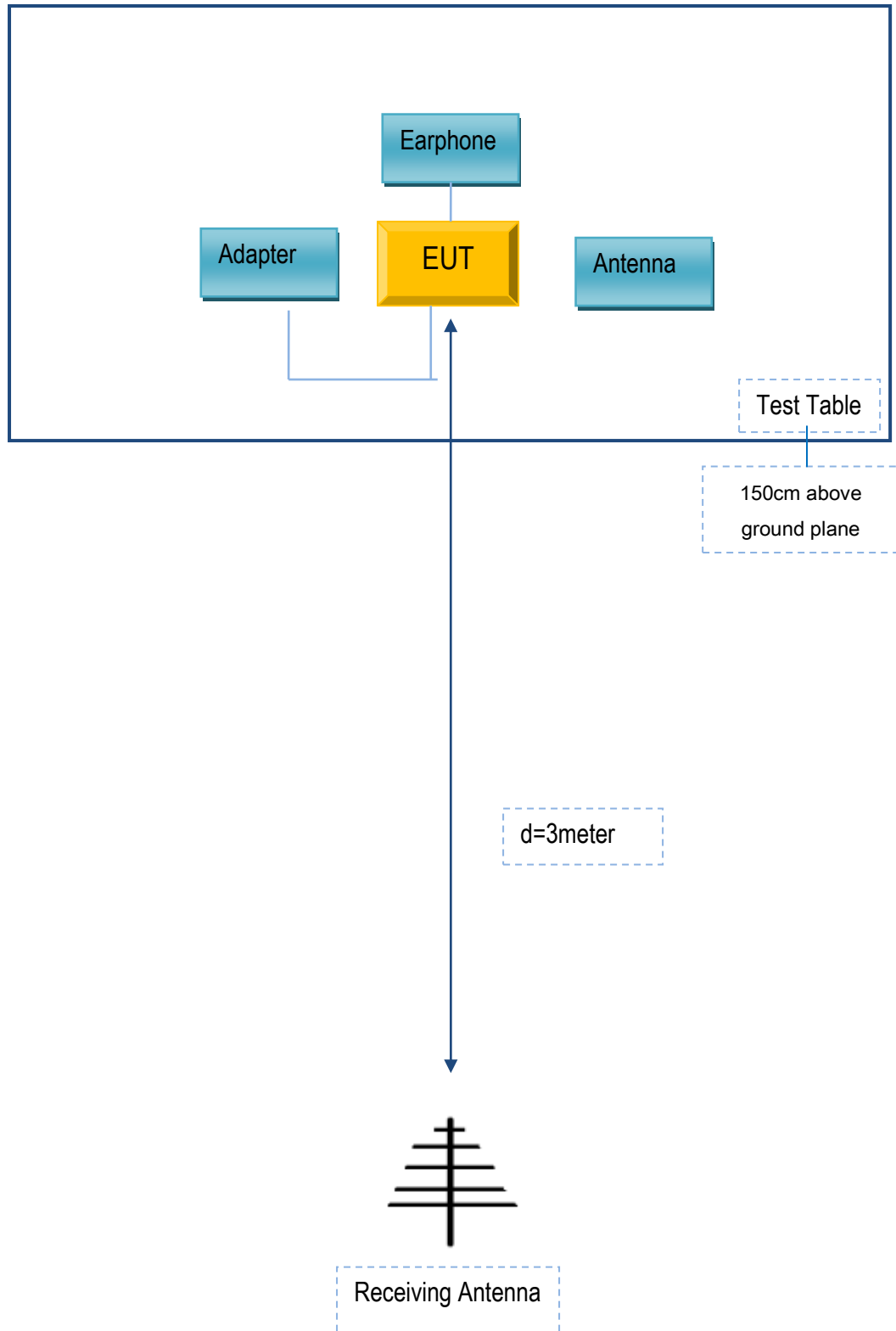

Annex C. ii. SUPPORTING EQUIPMENT DESCRIPTION

The following is a description of supporting equipment and details of cables used with the EUT.

Supporting Equipment:

Manufacturer	Equipment Description	Model	Serial No
BLU Products , Inc	Adapter	US-SL-0550	N/A
BLU Products , Inc	Earphone	Z5	N/A

Supporting Cable:

Cable type	Shield Type	Ferrite Core	Length	Serial No
USB Cable	Un-shielding	No	0.8m	N/A

Test Report	17071472-FCC-R2
Page	65 of 66

Annex D. User Manual / Block Diagram / Schematics / Partlist

Please see the attachment

Test Report	17071472-FCC-R2
Page	66 of 66

Annex E. DECLARATION OF SIMILARITY

N/A