

<b>Test Mode:</b>	<b>Bluetooth Mode</b>
-------------------	-----------------------

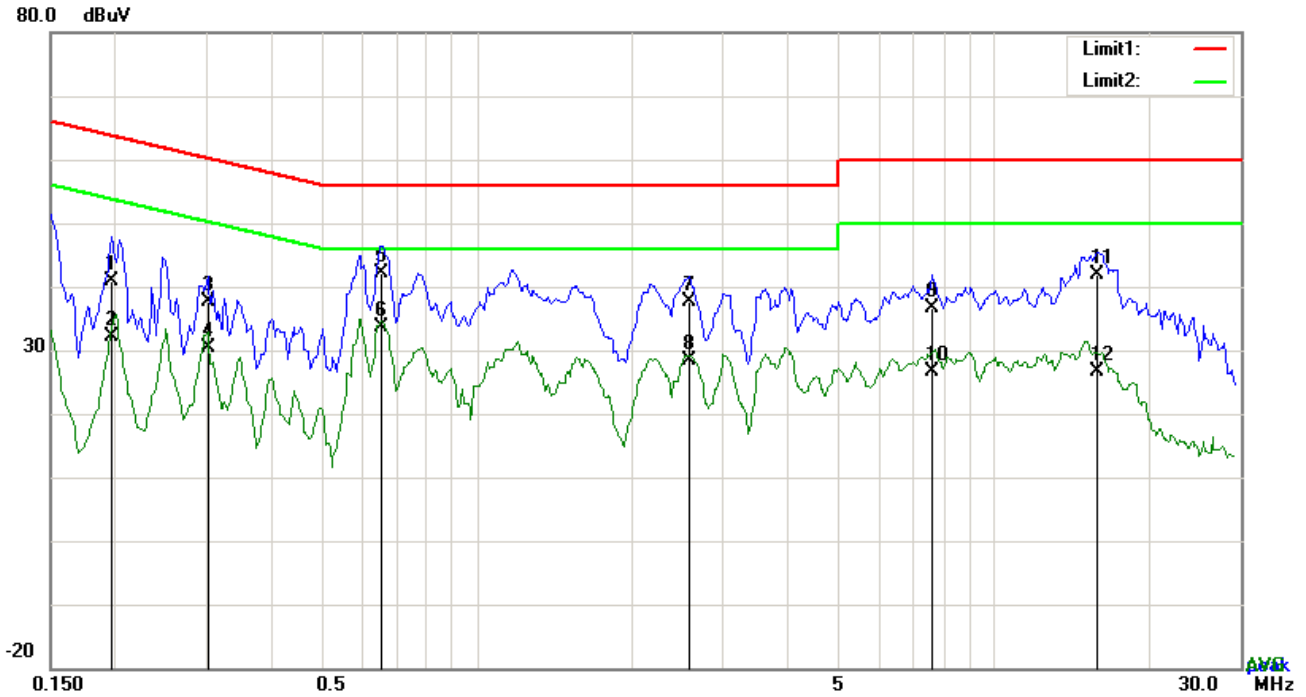

**Test Data**

**Phase Line Plot at 240Vac, 60Hz**

No.	P/L	Frequency	Reading	Detector	Corrected	Result	Limit	Margin
		(MHz)	(dBuV)		(dB)	(dBuV)	(dBuV)	(dB)
1	L1	0.1968	30.96	QP	10.03	40.99	63.74	-22.75
2	L1	0.1968	22.10	AVG	10.03	32.13	53.74	-21.61
3	L1	0.3021	27.49	QP	10.03	37.52	60.18	-22.66
4	L1	0.3021	20.28	AVG	10.03	30.31	50.18	-19.87
5	L1	0.6570	32.18	QP	10.03	42.21	56.00	-13.79
6	L1	0.6570	23.57	AVG	10.03	33.60	46.00	-12.40
7	L1	2.5836	27.47	QP	10.05	37.52	56.00	-18.48
8	L1	2.5836	18.40	AVG	10.05	28.45	46.00	-17.55
9	L1	7.5942	26.39	QP	10.12	36.51	60.00	-23.49
10	L1	7.5942	16.40	AVG	10.12	26.52	50.00	-23.48
11	L1	15.8115	31.76	QP	10.24	42.00	60.00	-18.00
12	L1	15.8115	16.45	AVG	10.24	26.69	50.00	-23.31

<b>Test Mode:</b>	<b>Bluetooth Mode</b>
-------------------	-----------------------

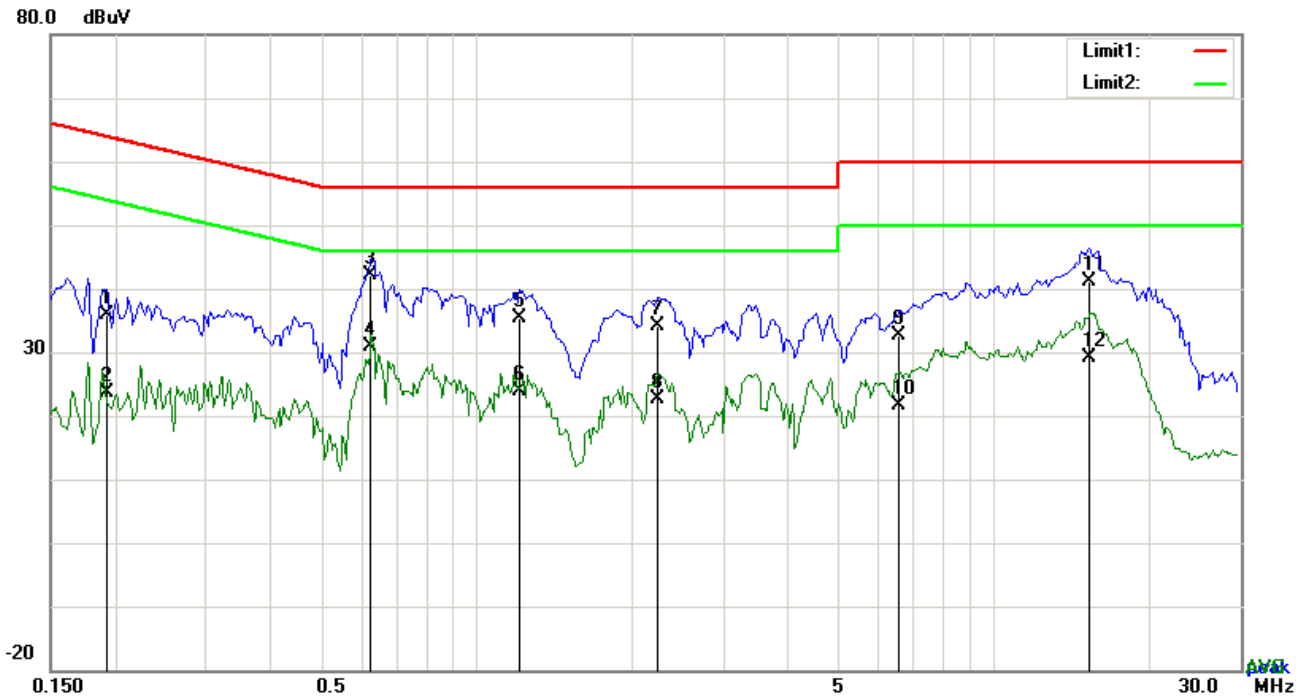

**Test Data**

**Phase Neutral Plot at 240Vac, 60Hz**

No.	P/L	Frequency	Reading	Detector	Corrected	Result	Limit	Margin
		(MHz)	(dBuV)		(dB)	(dBuV)	(dBuV)	(dB)
1	N	0.1929	25.78	QP	10.02	35.80	63.91	-28.11
2	N	0.1929	13.66	AVG	10.02	23.68	53.91	-30.23
3	N	0.6258	32.20	QP	10.02	42.22	56.00	-13.78
4	N	0.6258	20.79	AVG	10.02	30.81	46.00	-15.19
5	N	1.2108	25.25	QP	10.03	35.28	56.00	-20.72
6	N	1.2108	13.89	AVG	10.03	23.92	46.00	-22.08
7	N	2.2482	24.19	QP	10.04	34.23	56.00	-21.77
8	N	2.2482	12.56	AVG	10.04	22.60	46.00	-23.40
9	N	6.5880	22.48	QP	10.09	32.57	60.00	-27.43
10	N	6.5880	11.51	AVG	10.09	21.60	50.00	-28.40
11	N	15.2460	30.97	QP	10.20	41.17	60.00	-18.83
12	N	15.2460	18.92	AVG	10.20	29.12	50.00	-20.88

## 6.9 Radiated Emissions & Restricted Band

Temperature	25 °C
Relative Humidity	57%
Atmospheric Pressure	1016mbar
Test date :	January 17, 2018
Tested By :	Aaron Liang

### Requirement(s):

Spec	Item	Requirement	Applicable																
47CFR§15.205, §15.209, §15.247(d)	a)	Except higher limit as specified elsewhere in other section, the emissions from the low-power radio-frequency devices shall not exceed the field strength levels specified in the following table and the level of any unwanted emissions shall not exceed the level of the fundamental emission. The tighter limit applies at the band edges	<input checked="" type="checkbox"/>																
		<table border="1"> <thead> <tr> <th>Frequency range (MHz)</th> <th>Field Strength (<math>\mu\text{V}/\text{m}</math>)</th> </tr> </thead> <tbody> <tr> <td>0.009~0.490</td> <td>2400/F(KHz)</td> </tr> <tr> <td>0.490~1.705</td> <td>24000/F(KHz)</td> </tr> <tr> <td>1.705~30.0</td> <td>30</td> </tr> <tr> <td>30 – 88</td> <td>100</td> </tr> <tr> <td>88 – 216</td> <td>150</td> </tr> <tr> <td>216 960</td> <td>200</td> </tr> <tr> <td>Above 960</td> <td>500</td> </tr> </tbody> </table>		Frequency range (MHz)	Field Strength ( $\mu\text{V}/\text{m}$ )	0.009~0.490	2400/F(KHz)	0.490~1.705	24000/F(KHz)	1.705~30.0	30	30 – 88	100	88 – 216	150	216 960	200	Above 960	500
		Frequency range (MHz)		Field Strength ( $\mu\text{V}/\text{m}$ )															
		0.009~0.490		2400/F(KHz)															
		0.490~1.705		24000/F(KHz)															
		1.705~30.0		30															
		30 – 88		100															
		88 – 216		150															
216 960	200																		
Above 960	500																		

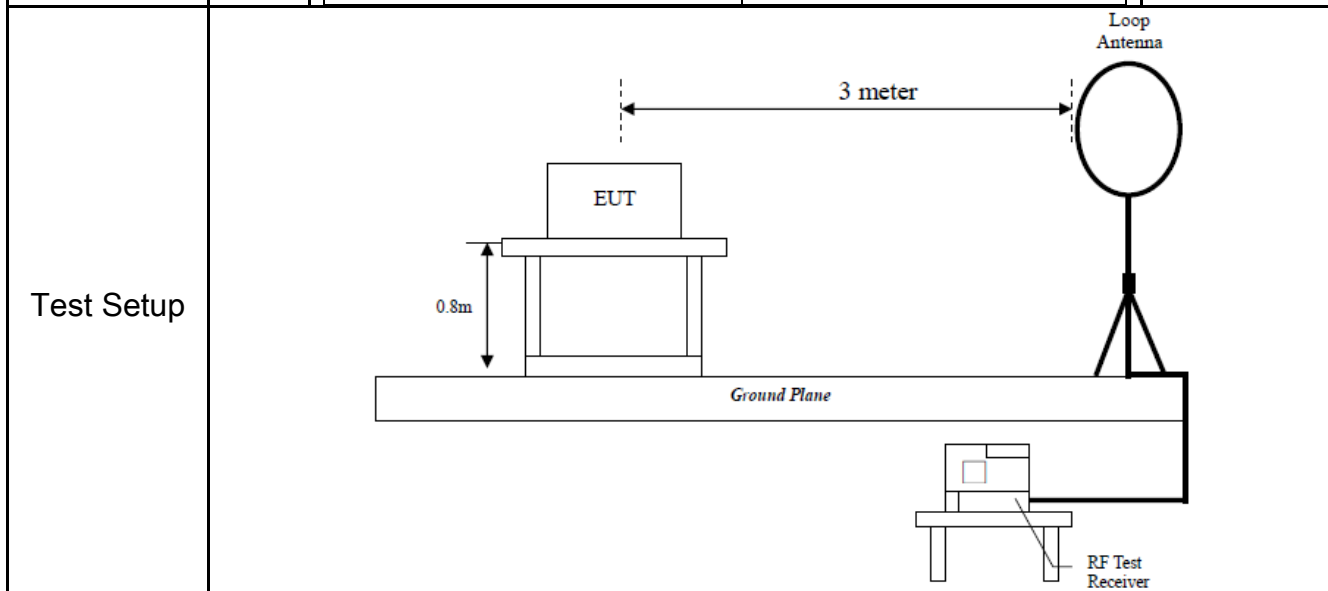

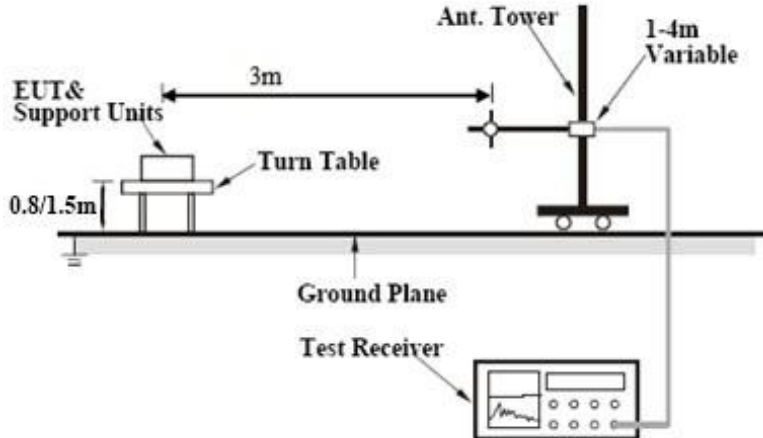
	
<p>Procedure</p>	<ol style="list-style-type: none"> <li>1. The EUT was switched on and allowed to warm up to its normal operating condition.</li> <li>2. The test was carried out at the selected frequency points obtained from the EUT characterization. Maximization of the emissions, was carried out by rotating the EUT, changing the antenna polarization, and adjusting the antenna height in the following manner:             <ol style="list-style-type: none"> <li>a. Vertical or horizontal polarization (whichever gave the higher emission level over a full rotation of the EUT) was chosen.</li> <li>b. The EUT was then rotated to the direction that gave the maximum emission.</li> <li>c. Finally, the antenna height was adjusted to the height that gave the maximum emission.</li> </ol> </li> <li>3. The resolution bandwidth and video bandwidth of test receiver/spectrum analyzer is 120 kHz for Quasi Peak detection at frequency below 1GHz.</li> <li>4. The resolution bandwidth of test receiver/spectrum analyzer is 1MHz and video bandwidth is 3MHz with Peak detection for Peak measurement at frequency above 1GHz. The resolution bandwidth of test receiver/spectrum analyzer is 1MHz and the video bandwidth is 10Hz with Peak detection for Average Measurement as below at frequency above 1GHz.</li> <li>5. Steps 2 and 3 were repeated for the next frequency point, until all selected frequency points were measured.</li> </ol>
<p>Remark</p>	
<p>Result</p>	<input checked="" type="checkbox"/> Pass <input type="checkbox"/> Fail

Test Data     Yes       N/A  
 Test Plot     Yes (See below)       N/A

**Test Result:**

<b>Test Mode:</b>	Transmitting Mode
-------------------	-------------------

Frequency range: 9KHz - 30MHz

Freq. (MHz)	Detection value	Factor (dB/m)	Reading (dBuV/m)	Result (dBuV/m)	Limit@3m (dBuV/m)	Margin (dB)
--	--	--	--	--	--	>20
--	--	--	--	--	--	>20

**Note:**

The amplitude of spurious emissions which are attenuated by more than 20dB below the permissible value has no need to be reported.

Distance extrapolation factor =  $40 \log(\text{specific distance}/\text{test distance})$ (dB);

Limit line = specific limits(dBuv) + distance extrapolation factor.

**Test Mode:** Bluetooth Mode

**30MHz -1GHz**

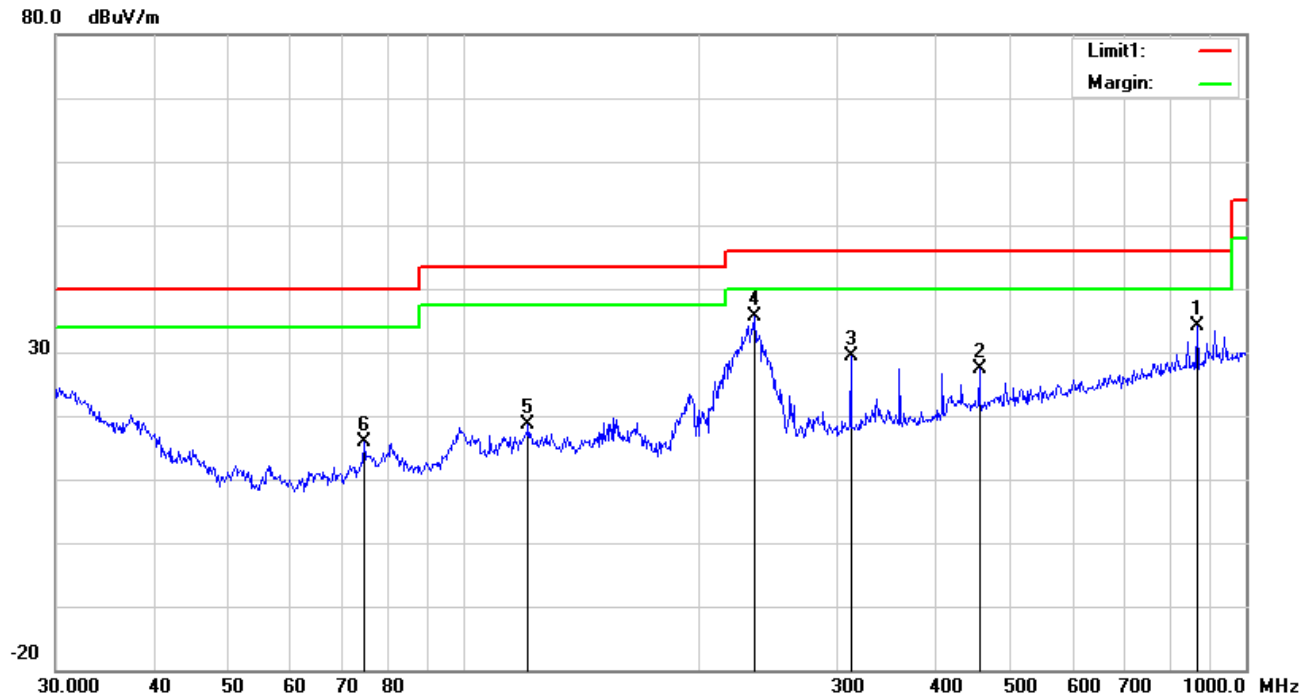

**Test Data**

**Horizontal Polarity Plot @3m**

No.	P/L	Frequency (MHz)	Reading (dBuV/m)	Detect or	Ant_F (dB/m)	PA_G (dB)	Cab_L (dB)	Result (dBuV/m)	Limit (dBuV/m)	Margin (dB)	Height (cm)	Degr ee ( )
1	H	866.0879	30.14	peak	22.13	20.97	2.93	34.23	46.00	-11.77	100	217
2	H	455.9058	30.20	peak	16.82	21.90	2.16	27.28	46.00	-18.72	100	131
3	H	312.1794	35.89	peak	13.86	22.26	1.85	29.34	46.00	-16.66	100	214
4	H	234.9909	44.63	peak	11.61	22.32	1.65	35.57	46.00	-10.43	200	84
5	H	120.6991	25.92	peak	13.85	22.36	1.16	18.57	43.50	-24.93	100	42
6	H	74.3955	29.70	peak	7.71	22.40	0.96	15.97	40.00	-24.03	100	121

### 30MHz -1GHz

80.0 dBuV/m

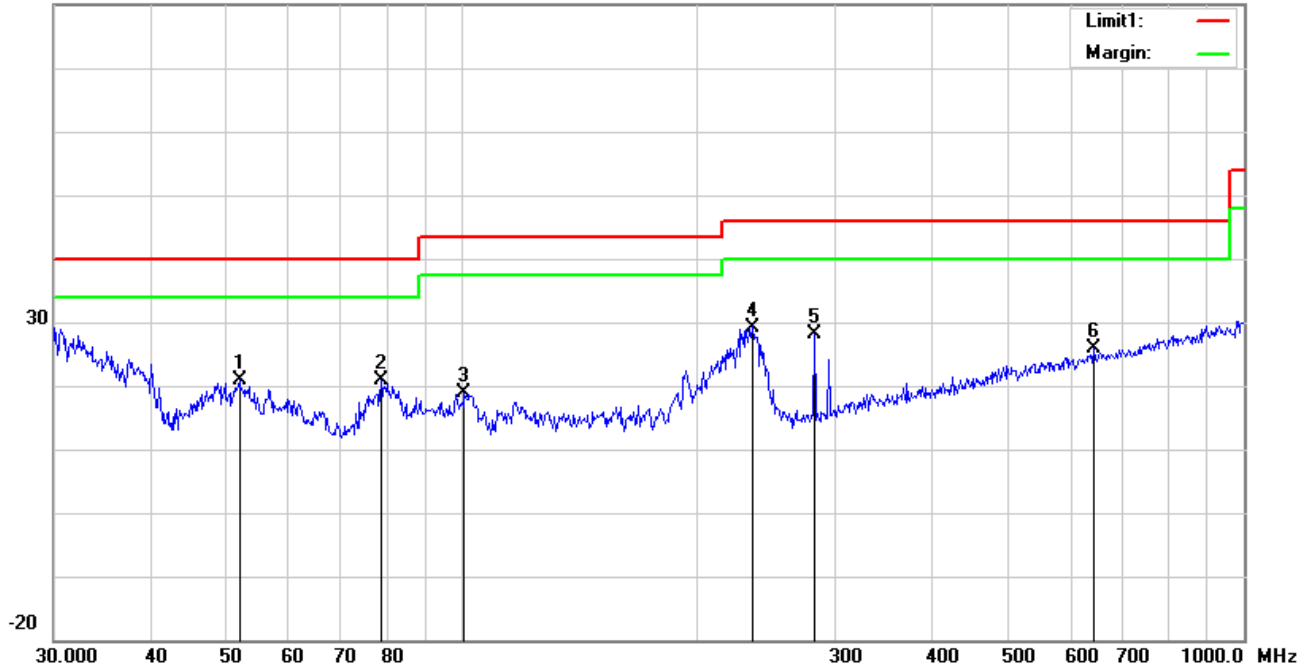

### Test Data

#### Vertical Polarity Plot @3m

No.	P/L	Frequency (MHz)	Reading (dBuV/m)	Detect or	Ant_F (dB/m)	PA_G (dB)	Cab_L (dB)	Result (dBuV/m)	Limit (dBuV/m)	Margin (dB)	Height (cm)	Degr ee ( )
1	V	51.8430	34.23	peak	8.20	22.39	0.79	20.83	40.00	-19.17	100	289
2	V	78.6888	34.68	peak	7.63	22.41	1.03	20.93	40.00	-19.07	100	344
3	V	100.5806	29.54	peak	10.50	22.32	1.12	18.84	43.50	-24.66	100	142
4	V	234.9909	38.31	peak	11.61	22.32	1.65	29.25	46.00	-16.75	100	55
5	V	281.9946	35.75	peak	12.81	22.29	1.76	28.03	46.00	-17.97	100	319
6	V	642.8613	25.17	peak	19.57	21.49	2.61	25.86	46.00	-20.14	100	290

### Above 1GHz

<b>Test Mode:</b>	<b>Transmitting Mode</b>
-------------------	--------------------------

#### Low Channel: GFSK Mode (Worst Case) (2402 MHz)

Frequency (MHz)	S.A. Reading (dBμV)	Detector (PK/AV)	Polarity (H/V)	Ant. Factor (dB/m)	Cable Loss (dB)	Pre-Amp. Gain (dB)	Cord. Amp. (dBμV/m)	Limit (dBμV/m)	Margin (dB)
4804	46.99	AV	V	33.39	7.22	48.46	39.14	54	-14.86
4804	45	AV	H	33.39	7.22	48.46	37.15	54	-16.85
4804	68.36	PK	V	33.39	7.22	48.46	60.51	74	-13.49
4804	63.03	PK	H	33.39	7.22	48.46	55.18	74	-18.82
7258	30.5	AV	V	35.93	8.7	50.12	25.01	54	-28.99
7258	29.7	AV	H	35.93	8.7	50.12	24.21	54	-29.79
7258	53.65	PK	V	35.93	8.7	50.12	48.16	74	-25.84
7258	52.34	PK	H	35.93	8.7	50.12	46.85	74	-27.15

#### Middle Channel: GFSK Mode (Worst Case) (2441 MHz)

Frequency (MHz)	S.A. Reading (dBμV)	Detector (PK/AV)	Polarity (H/V)	Ant. Factor (dB/m)	Cable Loss (dB)	Pre-Amp. Gain (dB)	Cord. Amp. (dBμV/m)	Limit (dBμV/m)	Margin (dB)
4882	48.01	AV	V	33.62	7.53	48.36	40.8	54	-13.2
4882	47.84	AV	H	33.62	7.53	48.36	40.63	54	-13.37
4882	66.34	PK	V	33.62	7.53	48.36	59.13	74	-14.87
4882	62.13	PK	H	33.62	7.53	48.36	54.92	74	-19.08
11348	29.45	AV	V	39.94	12.03	46.1	35.32	54	-18.68
11348	29.43	AV	H	39.94	12.03	46.1	35.3	54	-18.7
11348	48.36	PK	V	39.94	12.03	46.1	54.23	74	-19.77
11348	43.89	PK	H	39.94	12.03	46.1	49.76	74	-24.24



**High Channel: GFSK Mode (Worst Case) (2480 MHz)**

Frequency (MHz)	S.A. Reading (dBμV)	Detector (PK/AV)	Polarity (H/V)	Ant. Factor (dB/m)	Cable Loss (dB)	Pre-Amp. Gain (dB)	Cord. Amp. (dBμV/m)	Limit (dBμV/m)	Margin (dB)
4960	42.78	AV	V	33.89	7.86	48.31	36.22	54	-17.78
4960	48.39	AV	H	33.89	7.86	48.31	41.83	54	-12.17
4960	66.64	PK	V	33.89	7.86	48.31	60.08	74	-13.92
4960	65.67	PK	H	33.89	7.86	48.31	59.11	74	-14.89
17909	20.16	AV	V	42.56	20.25	44.53	38.44	54	-15.56
17909	19.59	AV	H	42.56	20.25	44.53	37.87	54	-16.13
17909	41.2	PK	V	42.56	20.25	44.53	59.48	74	-14.52
17909	42.46	PK	H	42.56	20.25	44.53	60.74	74	-13.26

**Note:**

1, The testing has been conformed to  $10 \times 2480 \text{ MHz} = 24,800 \text{ MHz}$

2, All other emissions more than 30 dB below the limit

3, X-Axis, Y-Axis and Z-Axis were investigated. The results above show only the worst case.

4, The radiated spurious test above 18GHz is subcontracted to SIEMIC (Nanjing-China) Laboratories. and found 30dB below the limit at least.

## Annex A. TEST INSTRUMENT

Instrument	Model	Serial #	Cal Date	Cal Due	In use
<b>AC Line Conducted</b>					
EMI test receiver	ESCS30	8471241027	09/15/2017	09/14/2018	<input checked="" type="checkbox"/>
Line Impedance	LI-125A	191106	09/23/2017	09/22/2018	<input checked="" type="checkbox"/>
Line Impedance	LI-125A	191107	09/23/2017	09/22/2018	<input checked="" type="checkbox"/>
ISN	ISN T800	34373	09/23/2017	09/22/2018	<input type="checkbox"/>
Transient Limiter	LIT-153	531118	08/30/2017	08/29/2018	<input type="checkbox"/>
<b>RF conducted test</b>					
Agilent ESA-E SERIES	E4407B	MY45108319	09/15/2017	09/14/2018	<input checked="" type="checkbox"/>
Power Splitter	1#	1#	08/30/2017	08/29/2018	<input checked="" type="checkbox"/>
DC Power Supply	E3640A	MY40004013	09/15/2017	09/14/2018	<input checked="" type="checkbox"/>
<b>Radiated Emissions</b>					
EMI test receiver	ESL6	100262	09/15/2017	09/14/2018	<input checked="" type="checkbox"/>
Positioning Controller	UC3000	MF780208282	11/17/2017	11/16/2018	<input checked="" type="checkbox"/>
OPT 010 AMPLIFIER (0.1-1300MHz)	8447E	2727A02430	08/30/2017	08/29/2018	<input checked="" type="checkbox"/>
Microwave Preamplifier (1 ~ 26.5GHz)	8449B	3008A02402	03/23/2017	03/22/2018	<input checked="" type="checkbox"/>
Horn Antenna	BBHA9170	3145226D1	09/27/2017	09/26/2018	<input checked="" type="checkbox"/>
Active Antenna (9kHz-30MHz)	AL-130	121031	10/12/2017	10/11/2018	<input checked="" type="checkbox"/>
Bilog Antenna (30MHz~6GHz)	JB6	A110712	09/19/2017	09/18/2018	<input checked="" type="checkbox"/>
Double Ridge Horn Antenna (1 ~18GHz)	AH-118	71283	09/22/2017	09/21/2018	<input checked="" type="checkbox"/>
Universal Radio Communication Tester	CMU200	121393	09/23/2017	09/22/2018	<input checked="" type="checkbox"/>

**Annex B. EUT And Test Setup Photographs**

**Annex B.i. Photograph: EUT External Photo**

Whole Package View

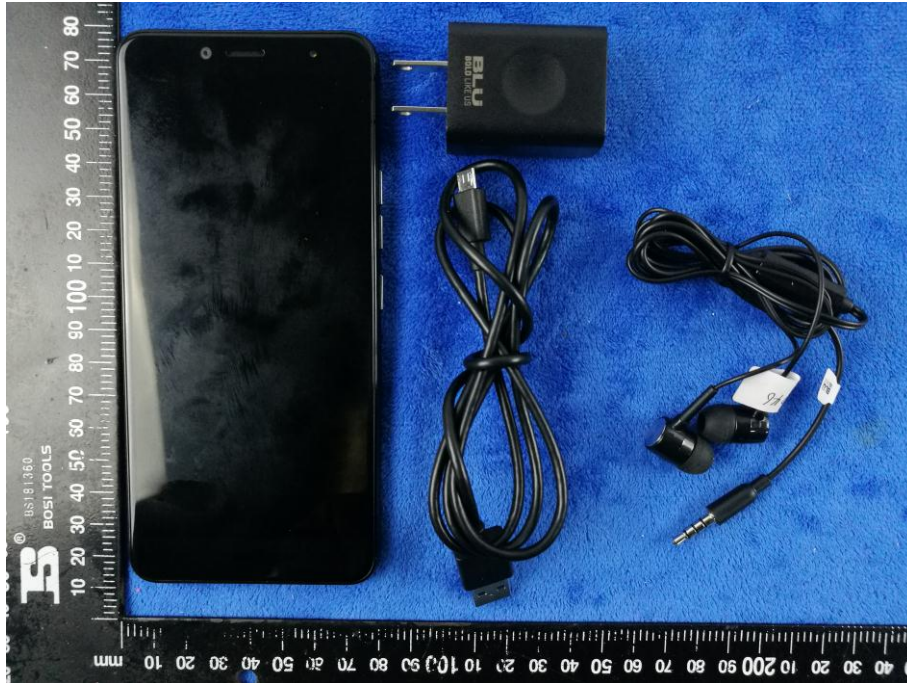

Adapter View

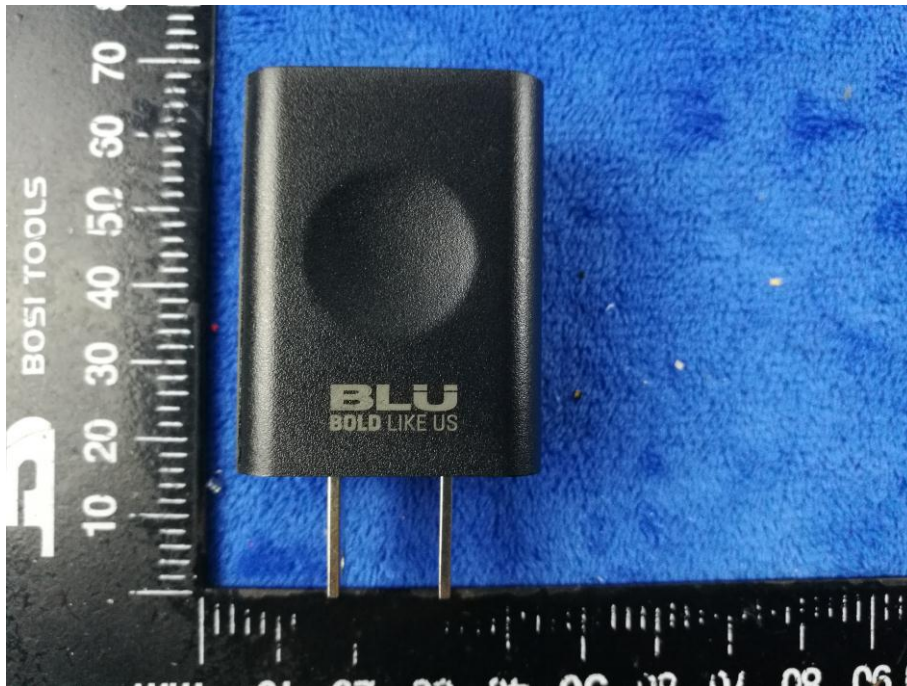

Label View

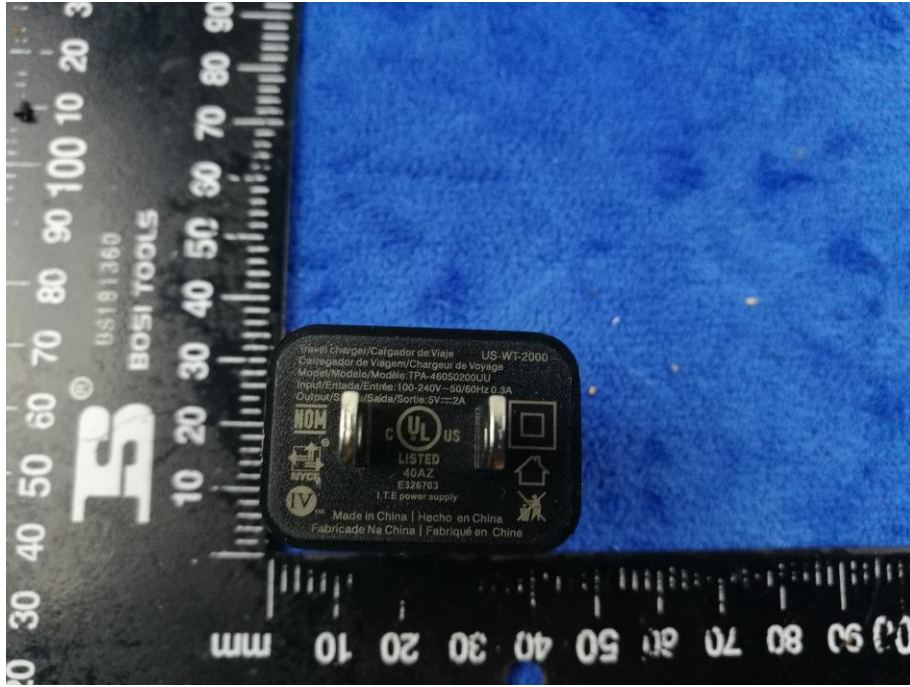

EUT - Front View



EUT - Rear View



EUT - Top View

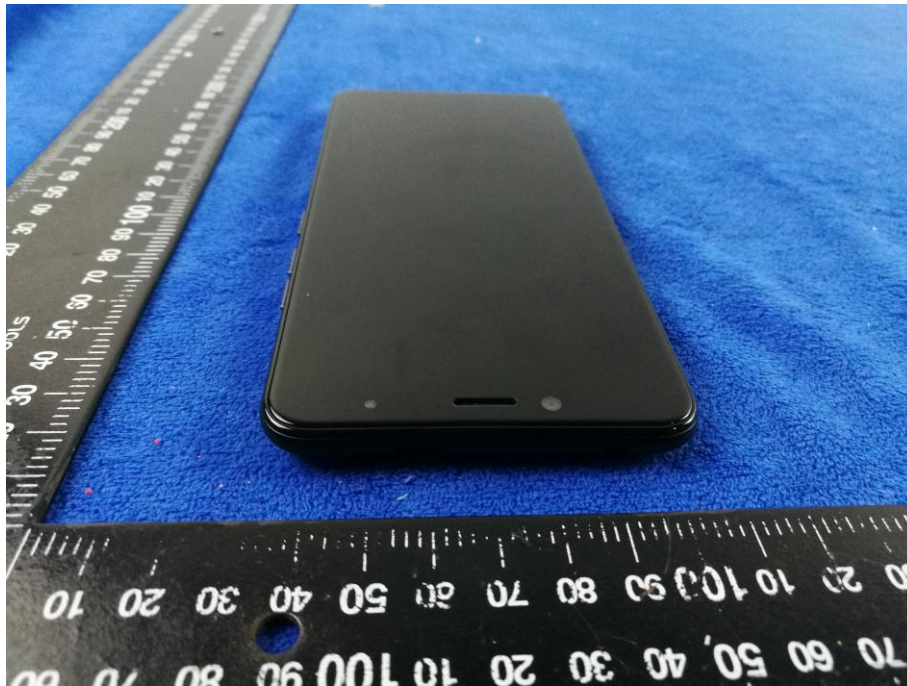

EUT - Bottom View

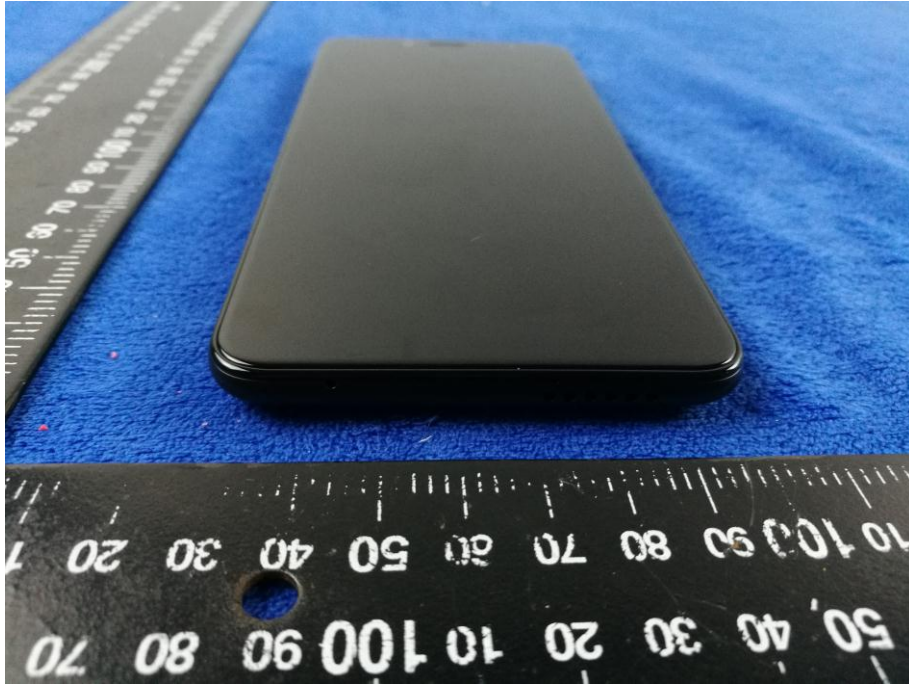

EUT - Left View

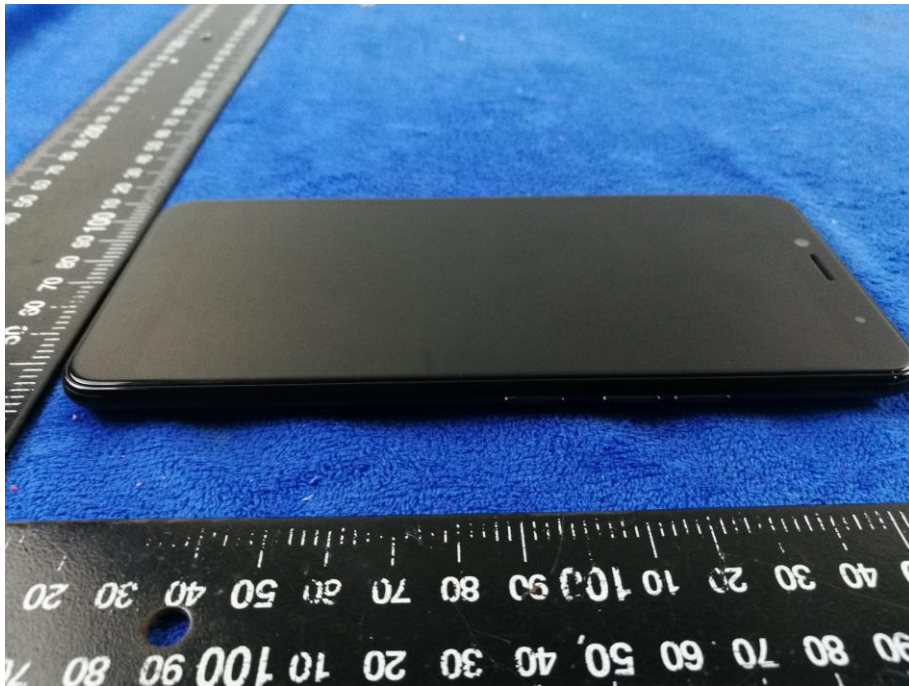

EUT - Right View

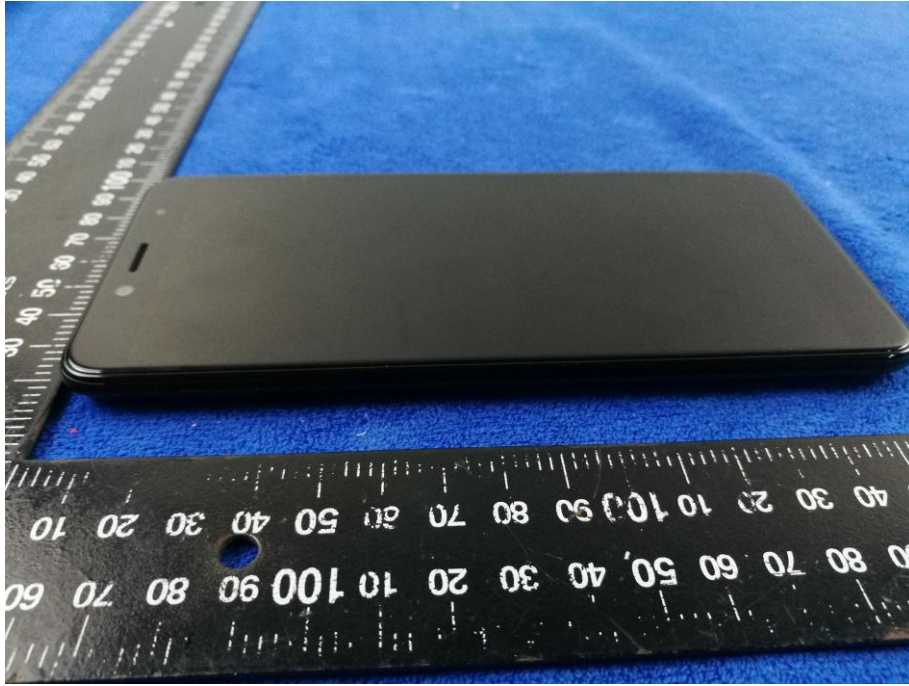

**Annex B.ii. Photograph: EUT Internal Photo**

Cover Off - Top View 1



Cover Off - Top View 2





Battery - Front View



Battery - Rear View



Mainboard with Shielding - Front View

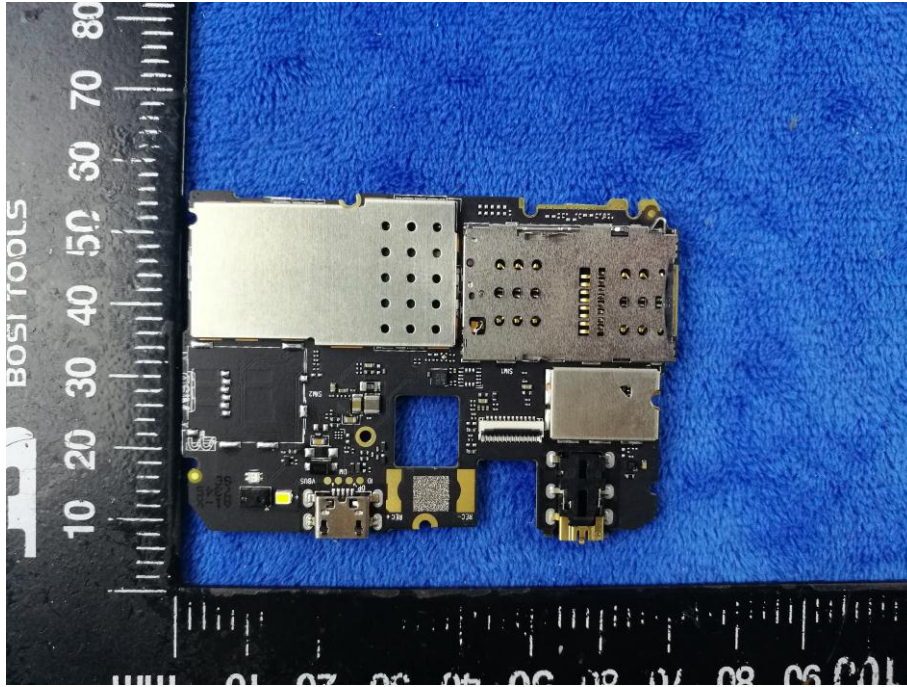

Mainboard with Shielding - Rear View



Mainboard without Shielding - Front View

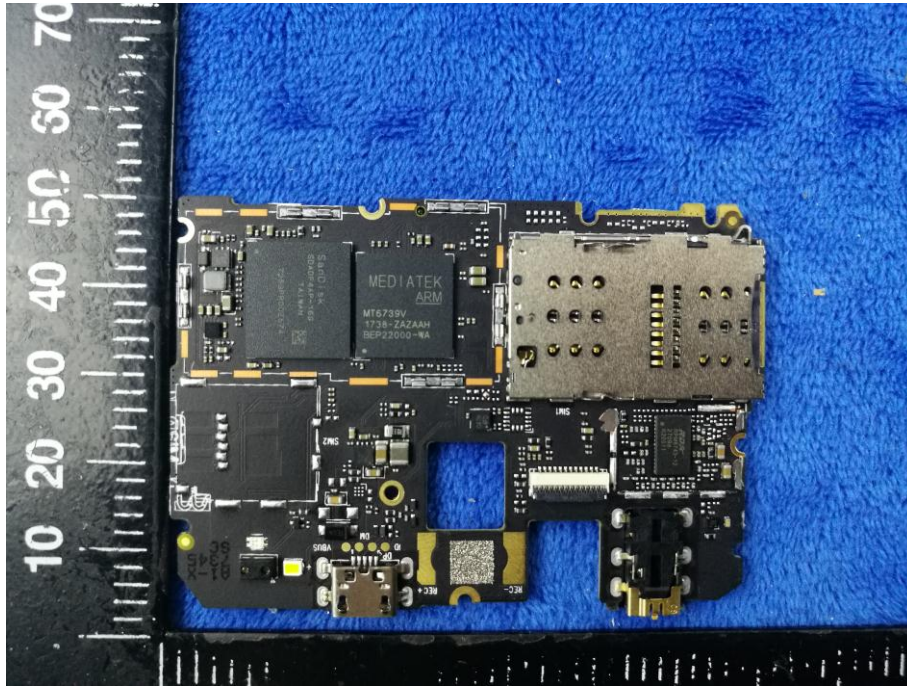

Mainboard without Shielding - Rear View

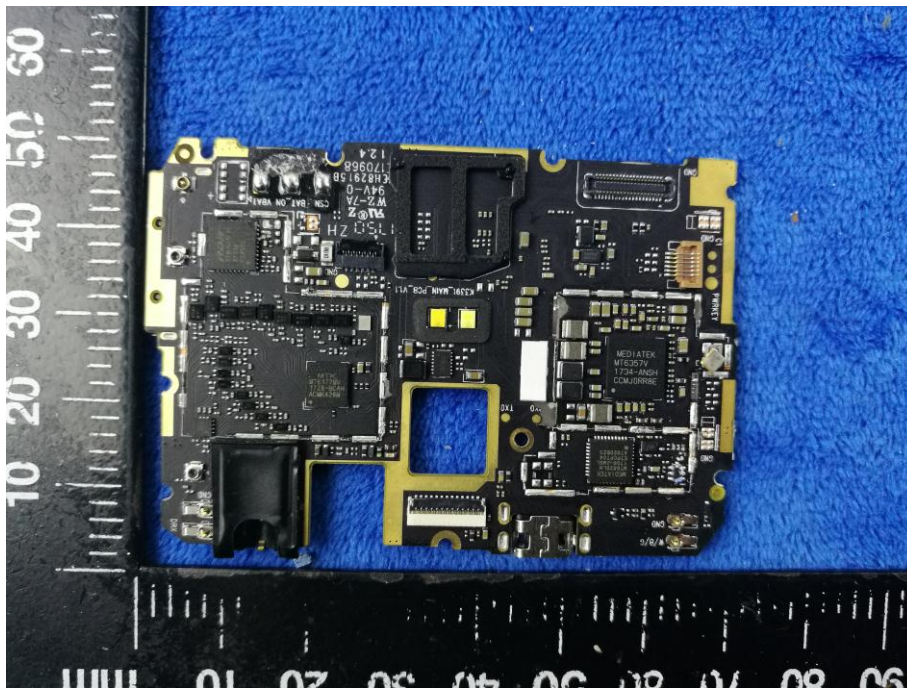

Smallboard – Front View

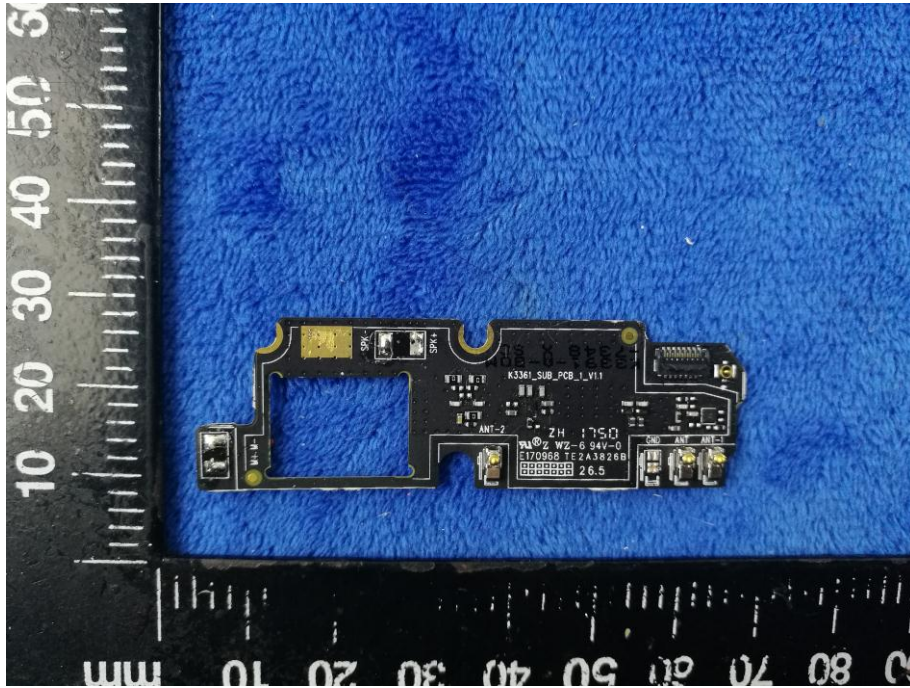

Smallboard – Rear View

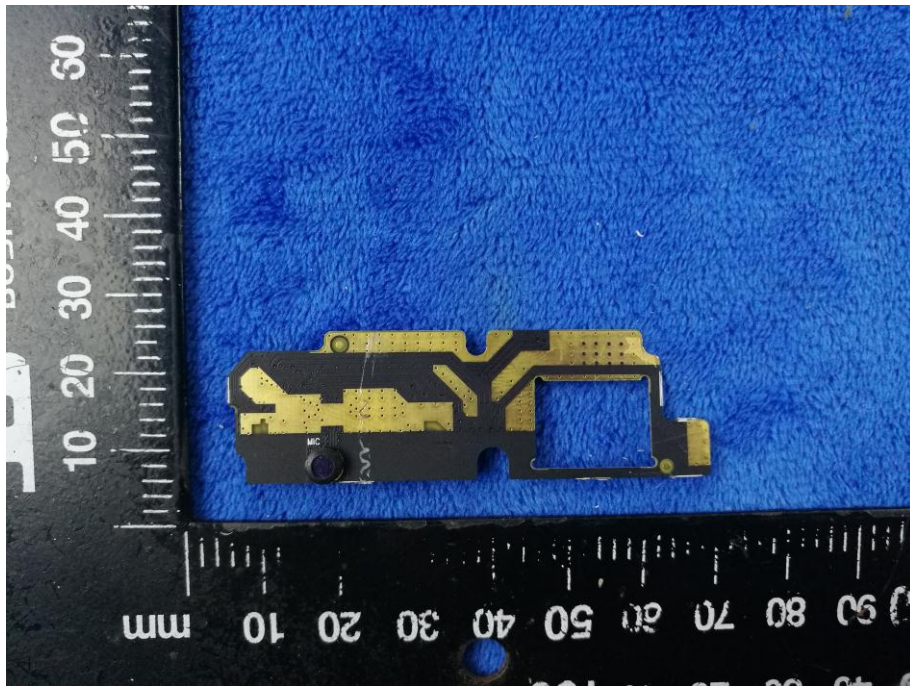

LCD – Front View

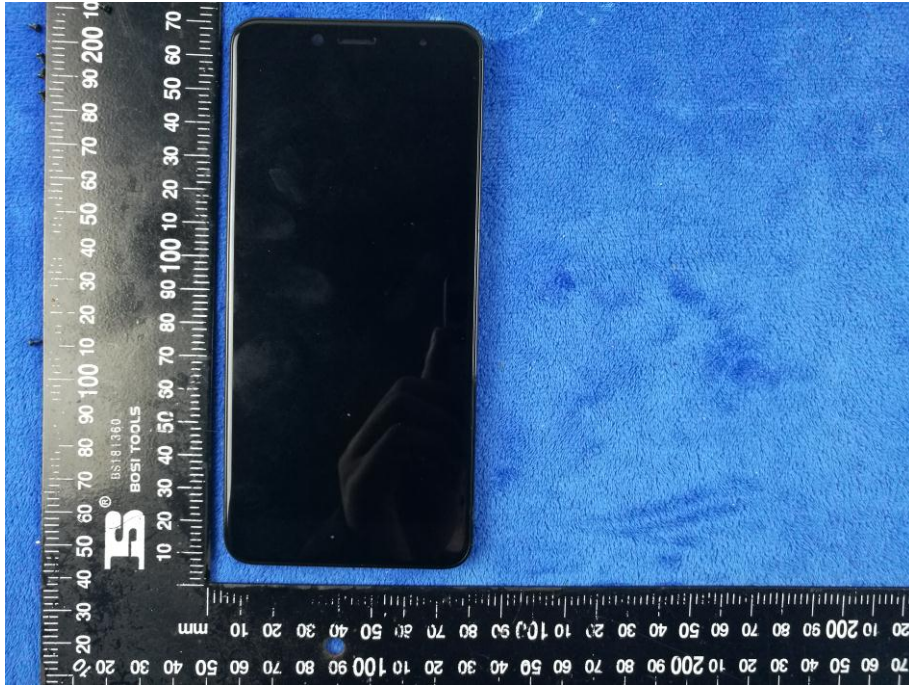

LCD – Rear View



GSM/PCS/UMTS-FDD/LTE Antenna View



WIFI/BT/BLE/GPS - Antenna View



RXD- Antenna View



**Annex B.iii. Photograph: Test Setup Photo**

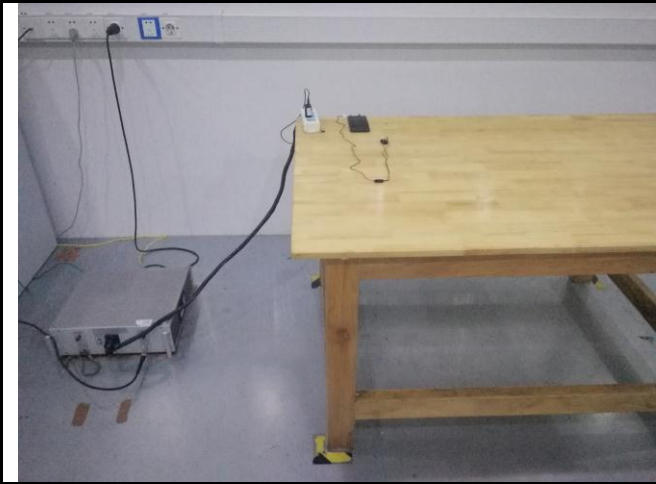

Conducted Emissions Test Setup Front View



Conducted Emissions Test Setup Side View

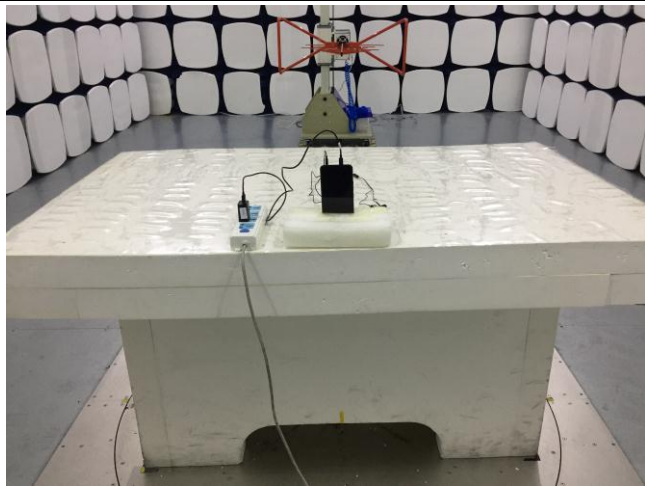

Radiated Spurious Emissions Test Setup Below 1GHz



Radiated Spurious Emissions Test Setup Above  
1GHz



## Annex C. TEST SETUP AND SUPPORTING EQUIPMENT

### Annex C.ii. TEST SET UP BLOCK

#### Block Configuration Diagram for AC Line Conducted Emissions

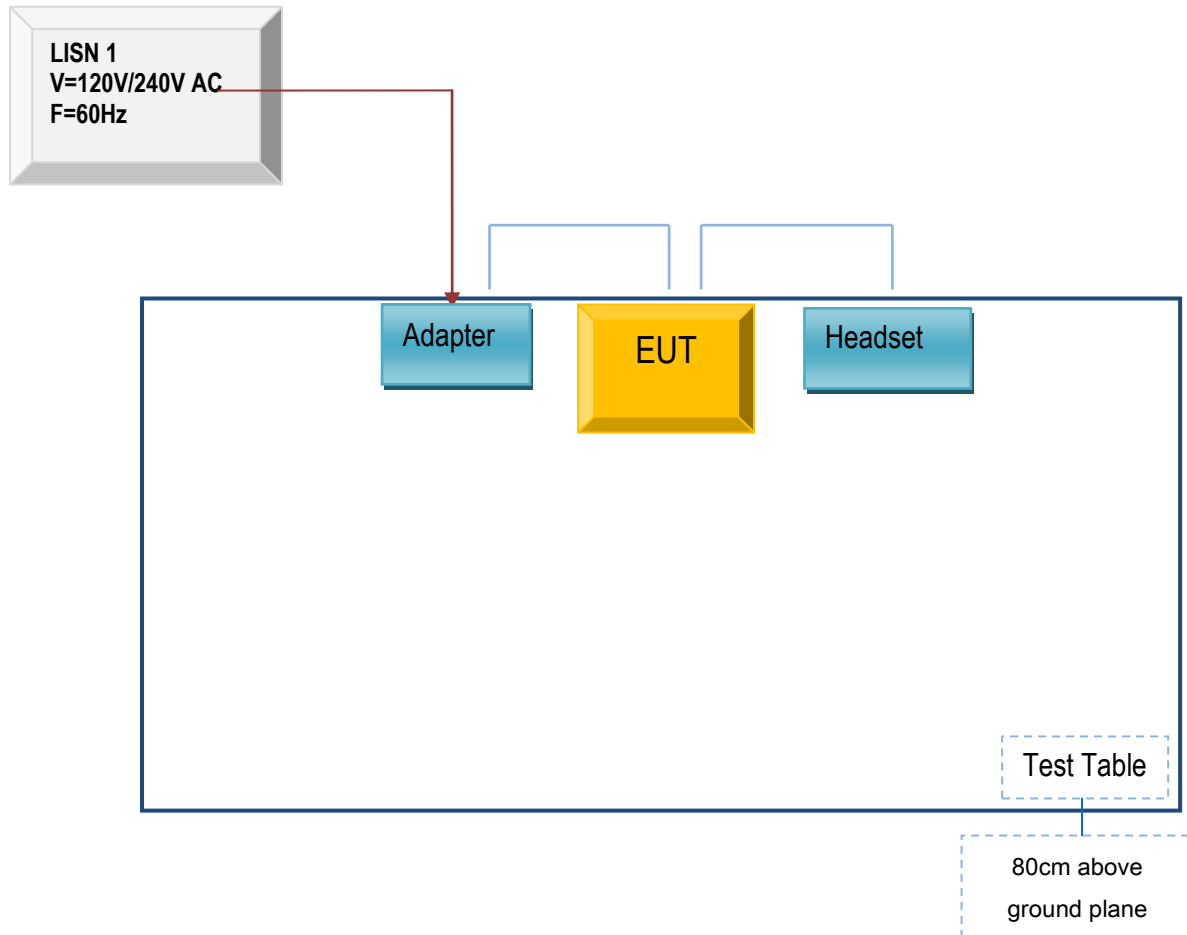

Block Configuration Diagram for Radiated Emissions ( Below 1GHz ) .

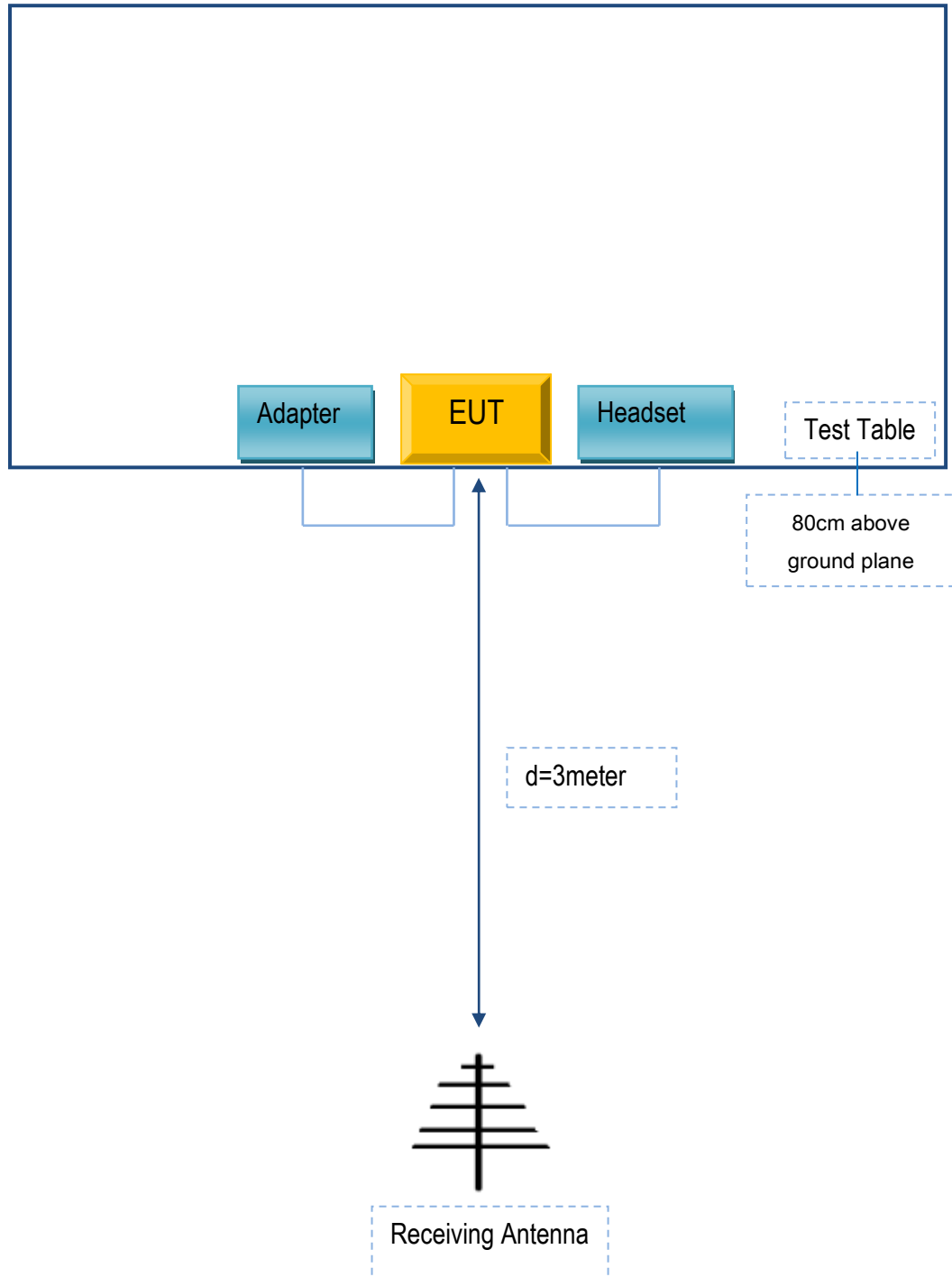

**Block Configuration Diagram for Radiated Emissions ( Above 1GHz ) .**

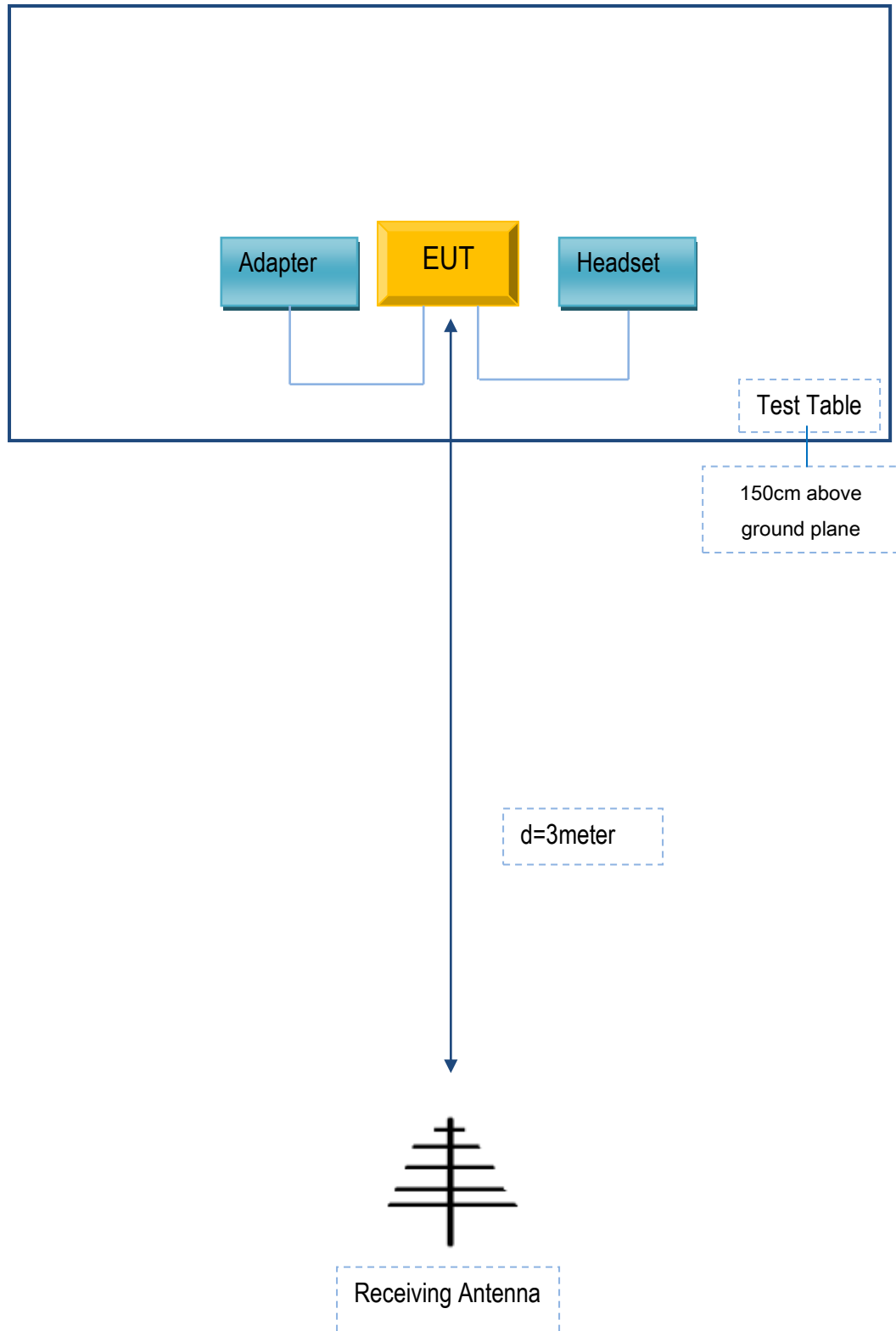

## Annex C. ii. SUPPORTING EQUIPMENT DESCRIPTION

The following is a description of supporting equipment and details of cables used with the EUT.

### Supporting Equipment:

Manufacturer	Equipment Description	Model	Serial No
BLU Products, Inc	Adapter	TPA-46050200UU	N/A
BLU Products, Inc	headset	VIVO ONE PLUS	N/A

### Supporting Cable:

Cable type	Shield Type	Ferrite Core	Length	Serial No
USB Cable	Un-shielding	No	0.8m	N/A

Test Report	18070046-FCC-R3
Page	69 of 70

## Annex D. User Manual / Block Diagram / Schematics / Partlist

Please see the attachment

Test Report	18070046-FCC-R3
Page	70 of 70

## Annex E. DECLARATION OF SIMILARITY

N/A