

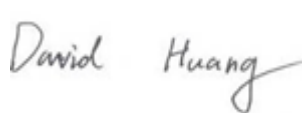

# RF TEST REPORT



Report No.: 18070046-FCC-R4

Supersede Report No.: N/A

|  |   |   |
|--|---|---|
| Applicant  | BLU Products,Inc  |   |
| Product Name   | Mobile Phone  |   |
| Model No.  | VIVO ONE PLUS   |   |
| Serial No.   | N/A   |   |
| Test Standard  | FCC Part 15.247: 2016, ANSI C63.10: 2013  |   |
| Test Date  | January 13 to January 28, 2018  |   |
| Issue Date   | January 29, 2018  |   |
| Test Result  | <input checked="" type="checkbox"/> Pass <input type="checkbox"/> Fail              |   |
| Equipment complied with the specification  | <input checked="" type="checkbox"/>   |   |
| Equipment did not comply with the specification  | <input type="checkbox"/>  |   |
|   |  |  |
| Aaron Liang<br>Test Engineer   | David Huang<br>Checked By   |   |
| This test report may be reproduced in full only<br>Test result presented in this test report is applicable to the tested sample only |   |   |

Issued by:

**SIEMIC (SHENZHEN-CHINA) LABORATORIES**

Zone A, Floor 1, Building 2 Wan Ye Long Technology Park

South Side of Zhoushi Road, Bao' an District, Shenzhen, Guangdong China 518108

Phone: +86 0755 2601 4629801 Email: [China@siemic.com.cn](mailto:China@siemic.com.cn)

## Laboratories Introduction

SIEMIC, headquartered in the heart of Silicon Valley, with superior facilities in US and Asia, is one of the leading independent testing and certification facilities providing customers with one-stop shop services for Compliance Testing and Global Certifications.



In addition to testing and certification, SIEMIC provides initial design reviews and compliance management throughout a project. Our extensive experience with China, Asia Pacific, North America, European, and International compliance requirements, assures the fastest, most cost effective way to attain regulatory compliance for the global markets.

### Accreditations for Conformity Assessment

| Country/Region | Scope                              |
|----------------|------------------------------------|
| USA            | EMC, RF/Wireless, SAR, Telecom     |
| Canada         | EMC, RF/Wireless, SAR, Telecom     |
| Taiwan         | EMC, RF, Telecom, SAR, Safety      |
| Hong Kong      | RF/Wireless, SAR, Telecom          |
| Australia      | EMC, RF, Telecom, SAR, Safety      |
| Korea          | EMI, EMS, RF, SAR, Telecom, Safety |
| Japan          | EMI, RF/Wireless, SAR, Telecom     |
| Singapore      | EMC, RF, SAR, Telecom              |
| Europe         | EMC, RF, SAR, Telecom, Safety      |

|                 |                 |
|-----------------|-----------------|
| Test Report No. | 18070046-FCC-R4 |
| Page            | 3 of 53         |

This page has been left blank intentionally.

# CONTENTS

|  |    |
|--|----|
| 1. REPORT REVISION HISTORY .....   | 5  |
| 2. CUSTOMER INFORMATION.....   | 5  |
| 3. TEST SITE INFORMATION .....   | 5  |
| 4. EQUIPMENT UNDER TEST (EUT) INFORMATION .....                          | 6  |
| 5. TEST SUMMARY .....  | 9  |
| 6. MEASUREMENTS, EXAMINATION AND DERIVED RESULTS.....                    | 10 |
| 6.1 ANTENNA REQUIREMENT .....  | 10 |
| 6.2 DTS (6 DB) CHANNEL BANDWIDTH .....                                   | 11 |
| 6.3 MAXIMUM OUTPUT POWER.....  | 13 |
| 6.4 POWER SPECTRAL DENSITY .....   | 15 |
| 6.5 BAND-EDGE & UNWANTED EMISSIONS INTO RESTRICTED FREQUENCY BANDS ..... | 17 |
| 6.6 AC POWER LINE CONDUCTED EMISSIONS.....                               | 20 |
| 6.7 RADIATED EMISSIONS & RESTRICTED BAND.....                            | 26 |
| ANNEX A. TEST INSTRUMENT .....   | 33 |
| ANNEX B. EUT AND TEST SETUP PHOTOGRAPHS.....                             | 34 |
| ANNEX C. TEST SETUP AND SUPPORTING EQUIPMENT.....                        | 48 |
| ANNEX D. USER MANUAL / BLOCK DIAGRAM / SCHEMATICS / PARTLIST .....       | 52 |
| ANNEX E. DECLARATION OF SIMILARITY .....                                 | 53 |

## 1. Report Revision History

| Report No.      | Report Version | Description | Issue Date       |
|-----------------|----------------|-------------|------------------|
| 18070046-FCC-R4 | NONE           | Original    | January 29, 2018 |
|                 |                |             |                  |
|                 |                |             |                  |
|                 |                |             |                  |
|                 |                |             |                  |

## 2. Customer information

|                  |  |
|------------------|--|
| Applicant Name   | BLU Products, Inc                      |
| Applicant Add    | 10814 NW 33rd St # 100 Doral, FL 33172 |
| Manufacturer     | BLU Products, Inc                      |
| Manufacturer Add | 10814 NW 33rd St # 100 Doral, FL 33172 |

## 3. Test site information

Test Lab A:

|                      |  |
|----------------------|--|
| Lab performing tests | SIEMIC (Shenzhen-China) LABORATORIES   |
| Lab Address          | Zone A, Floor 1, Building 2 Wan Ye Long Technology Park<br>South Side of Zhoushi Road, Bao' an District, Shenzhen, Guangdong China<br>518108 |
| FCC Test Site No.    | 535293   |
| IC Test Site No.     | 4842E-1  |
| Test Software        | Radiated Emission Program-To Shenzhen v2.0   |

Test Lab B:

|                      |   |
|----------------------|---|
| Lab performing tests | SIEMIC (Nanjing-China) Laboratories   |
| Lab Address          | 2-1 Longcang Avenue Yuhua Economic and<br>Technology Development Park, Nanjing, China |
| FCC Test Site No.    | 694825  |
| IC Test Site No.     | 4842B-1   |
| Test Software        | EZ_EMG(ver.lcp-03A1)  |

Note: We just perform Radiated Spurious Emission above 18GHz in the test Lab. B.

## 4. Equipment under Test (EUT) Information

|                      |  |
|----------------------|--|
| Description of EUT:  | Mobile Phone   |
| Main Model:          | VIVO ONE PLUS  |
| Serial Model:        | N/A  |
| Date EUT received:   | January 12, 2018   |
| Test Date(s):        | January 13 to January 28, 2018   |
| Equipment Category : | DTS  |
| Antenna Gain:        | GSM850: -2.8dBi<br>PCS1900: -2.3dBi<br>UMTS-FDD Band V: -2.5dBi<br>UMTS-FDD Band IV: -2.5dBi<br>UMTS-FDD Band II: -2.5dBi<br>LTE Band II: -2.5dBi<br>LTE Band IV: -2.5dBi<br>LTE Band VII: -3.0dBi<br>LTE Band XII: -2.8dBi<br>LTE Band XVII: -2.8dBi<br>Bluetooth/BLE: -2.7dBi<br>WIFI: -2.7dBi<br>GPS: -2.5dBi |
| Antenna Type:        | PIFA Antenna   |
| Type of Modulation:  | GSM / GPRS: GMSK<br>EGPRS: GMSK<br>UMTS-FDD: QPSK<br>LTE Band: QPSK, 16QAM<br>802.11b/g/n: DSSS, OFDM<br>Bluetooth: GFSK, $\pi$ /4DQPSK, 8DPSK<br>BLE: GFSK<br>GPS: BPSK   |

RF Operating Frequency (ies):

GSM850 TX: 824.2 ~ 848.8 MHz; RX: 869.2 ~ 893.8 MHz  
PCS1900 TX: 1850.2 ~ 1909.8 MHz; RX: 1930.2 ~ 1989.8 MHz  
UMTS-FDD Band V TX: 826.4 ~ 846.6 MHz; RX: 871.4 ~ 891.6 MHz  
UMTS-FDD Band IV TX:1712.4 ~ 1752.6 MHz;  
RX : 2112.4 ~ 2152.6 MHz  
UMTS-FDD Band II TX:1852.4 ~ 1907.6 MHz;  
RX: 1932.4 ~ 1987.6 MHz  
LTE Band II TX: 1850.7 ~ 1909.3MHz; RX : 1930.7 ~ 1989.3 MHz  
LTE Band IV TX: 1710.7 ~ 1754.3 MHz; RX : 2110.7~ 2154.3 MHz  
LTE Band VII TX: 2502.5 ~ 2567.5 MHz; RX : 2622.5 ~ 2687.5 MHz  
LTE Band XII TX:699.7 ~ 715.3 MHz; RX : 729.7~ 745.3MHz  
LTE Band XVII TX: 706.5 ~ 713.5 MHz; RX : 736.5 ~ 743.5 MHz  
WIFI: 802.11b/g/n(20M): 2412-2462 MHz  
WIFI: 802.11n(40M): 2422-2452 MHz  
Bluetooth& BLE: 2402-2480 MHz  
GPS: 1575.42 MHz

Max. Output Power: 3.488dBm

Number of Channels:

GSM 850: 124CH  
PCS1900: 299CH  
UMTS-FDD Band V: 102CH  
UMTS-FDD Band IV: 202CH  
UMTS-FDD Band II: 277CH  
WIFI :802.11b/g/n(20M): 11CH  
WIFI :802.11n(40M): 7CH  
Bluetooth: 79CH  
BLE: 40CH  
GPS:1CH

Port: USB Port, Earphone Port

Brand Name : BLU

Trade Name : 

Adapter :  
Input Power: Model: TPA-46050200UU  
Input: AC100-240V~50/60Hz,0.3A

|                 |                 |
|-----------------|-----------------|
| Test Report No. | 18070046-FCC-R4 |
| Page            | 8 of 53         |

Output: DC 5V, 2A

Battery:

Model: C916241400P

Spec: 3.85V, 4000mAh, 15.4Wh

Voltage: 4.4V

GPRS/EGPRS Multi-slot class      8/10/11/12

FCC ID:                                      YHLBLUVOONEPLUS



## 5. Test Summary

The product was tested in accordance with the following specifications.

All testing has been performed according to below product classification:

| FCC Rules                       | Description of Test   | Result     |
|---------------------------------|---|------------|
| §15.203                         | Antenna Requirement   | Compliance |
| §15.247 (a)(2)                  | DTS (6 dB) CHANNEL BANDWIDTH  | Compliance |
| §15.247(b)(3)                   | Conducted Maximum Output Power  | Compliance |
| §15.247(e)                      | Power Spectral Density  | Compliance |
| §15.247(d)                      | Band-Edge & Unwanted Emissions into Restricted Frequency Bands          | Compliance |
| §15.207 (a),                    | AC Power Line Conducted Emissions                                       | Compliance |
| §15.205, §15.209,<br>§15.247(d) | Radiated Emissions & Unwanted Emissions into Restricted Frequency Bands | Compliance |

### Measurement Uncertainty

| Emissions  |   |               |
|--|---|---------------|
| Test Item  | Description   | Uncertainty   |
| Band-Edge & Unwanted Emissions into Restricted Frequency Bands and Radiated Emissions & Unwanted Emissions into Restricted Frequency Bands | Confidence level of approximately 95% (in the case where distributions are normal), with a coverage factor of 2 (for EUTs < 0.5m X 0.5m X 0.5m) | +5.6dB/-4.5dB |
| -  | -   | -             |

## 6. Measurements, Examination And Derived Results

### 6.1 Antenna Requirement

#### Applicable Standard

According to § 15.203, an intentional radiator shall be designed to ensure that no antenna other than that furnished by the responsible party shall be used with the device. The use of a permanently attached antenna or of an antenna that uses a unique coupling to the intentional radiator shall be considered sufficient to comply with the provisions of this section. The manufacturer may design the unit so that a broken antenna can be replaced by the user, but the user of a standard antenna jack or electrical connector is prohibited. The structure and application of the EUT were analyzed to determine compliance with section §15.203 of the rules. §15.203 state that the subject device must meet the following criteria:

- a. Antenna must be permanently attached to the unit.
- b. Antenna must use a unique type of connector to attach to the EUT.

Unit must be professionally installed, and installer shall be responsible for verifying that the correct antenna is employed with the unit.

And according to FCC 47 CFR section 15.247 (b), if the transmitting antennas of directional gain greater than 6dBi are used, the power shall be reduced by the amount in dB that the directional gain of the antenna exceeds 6 dBi.

#### Antenna Connector Construction

The EUT has 2 antennas:

A permanently attached PIFA antenna for Bluetooth/BLE/WIF/GPS, the gain is -2.7dBi for Bluetooth/BLE/WIFI, the gain is -2.5dBi for GPS.

A permanently attached PIFA antenna for GSM/PCS/UMTS/ LTE Band II/IV/VII/XII/XVII, the gain is -2.8dBi for GSM850, -2.3dBi for PCS1900, -2.5dBi for UMTS-FDD Band II/V/ IV, the gain is -2.5dBi LTE Band II/IV, -3.0dBi for LTE Band VII, -2.8dBi for XII/ XVII.

**The antenna meets up with the ANTENNA REQUIREMENT.**

**Result:** Compliance.

## 6.2 DTS (6 dB) Channel Bandwidth

|                      |                  |
|----------------------|------------------|
| Temperature          | 26 °C            |
| Relative Humidity    | 57%              |
| Atmospheric Pressure | 1025mbar         |
| Test date :          | January 25, 2018 |
| Tested By :          | Aaron Liang      |

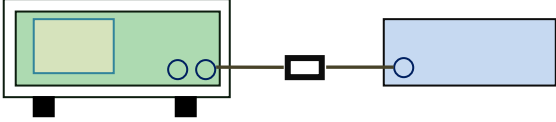
| Spec           | Item   | Requirement                                     | Applicable                          |
|----------------|--|---|-------------------------------------|
| § 15.247(a)(2) | a)   | 6dB BW ≥ 500kHz;                                | <input checked="" type="checkbox"/> |
| RSS Gen(4.6.1) | b)   | 99% BW: For FCC reference only; required by IC. | <input checked="" type="checkbox"/> |
| Test Setup     |  <p style="text-align: center;">Spectrum Analyzer                      EUT</p>  |   |                                     |
| Test Procedure | <p>558074 D01 DTS MEAS Guidance v03r03, 8.1 DTS bandwidth<br/><u>6dB Emission bandwidth measurement procedure</u></p> <ul style="list-style-type: none"> <li>- Set RBW = 100 kHz.</li> <li>- Set the video bandwidth (VBW) ≥ 3 RBW.</li> <li>- Detector = Peak.</li> <li>- Trace mode = max hold.</li> <li>- Sweep = auto couple.</li> <li>- Allow the trace to stabilize.</li> </ul> <p>Measure the maximum width of the emission that is constrained by the frequencies associated with the two outermost amplitude points (upper and lower frequencies) that are attenuated by 6 dB relative to the maximum level measured in the fundamental emission.</p> |   |                                     |
| Remark         |  |   |                                     |
| Result         | <input checked="" type="checkbox"/> Pass <input type="checkbox"/> Fail   |   |                                     |

Test Data     Yes                       N/A

Test Plot     Yes (See below)                       N/A

## 6dB Bandwidth measurement result

### Test Data

| CH   | Frequency (MHz) | 6dB Bandwidth (kHz) | 99% Occupied Bandwidth (MHz) |
|------|-----------------|---------------------|------------------------------|
| Low  | 2402            | 701.2               | 1.0528                       |
| Mid  | 2440            | 715.5               | 1.0519                       |
| High | 2480            | 712.8               | 1.0446                       |

### Test Plots

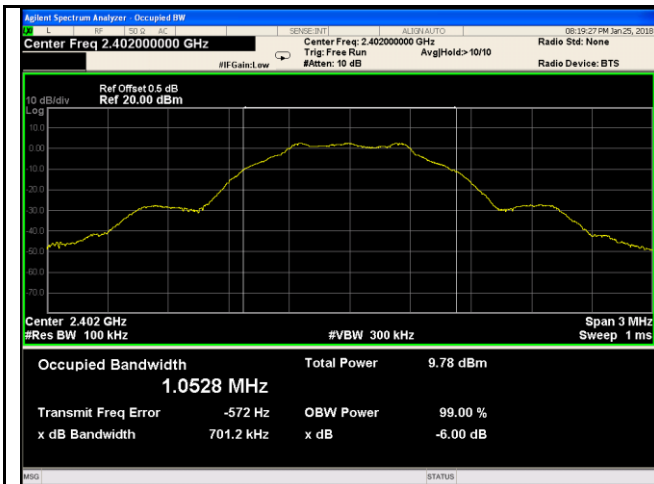

6dB Bandwidth - Low CH 2402

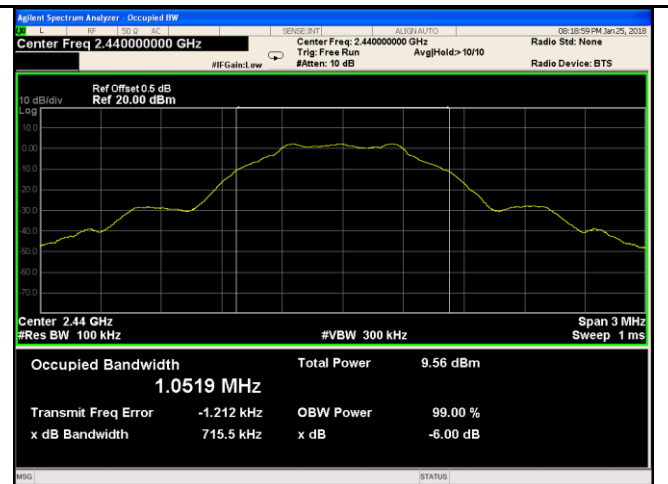

6dB Bandwidth - Mid CH 2440

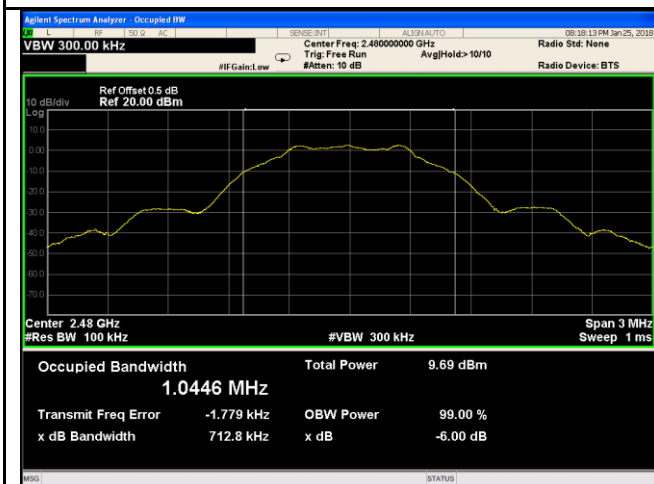

6dB Bandwidth - High CH 2480

### 6.3 Maximum Output Power

|                      |                  |
|----------------------|------------------|
| Temperature          | 26 °C            |
| Relative Humidity    | 57%              |
| Atmospheric Pressure | 1025mbar         |
| Test date :          | January 25, 2018 |
| Tested By :          | Aaron Liang      |

#### Requirement(s):

| Spec                               | Item | Requirement  | Applicable                          |
|------------------------------------|------|--|-------------------------------------|
| §15.247(b)<br>(3),RSS210<br>(A8.4) | a)   | FHSS in 2400-2483.5MHz with $\geq 75$ channels: $\leq 1$ Watt        | <input type="checkbox"/>            |
|                                    | b)   | FHSS in 5725-5850MHz: $\leq 1$ Watt                                  | <input type="checkbox"/>            |
|                                    | c)   | For all other FHSS in the 2400-2483.5MHz band: $\leq 0.125$ Watt.    | <input type="checkbox"/>            |
|                                    | d)   | FHSS in 902-928MHz with $\geq 50$ channels: $\leq 1$ Watt            | <input type="checkbox"/>            |
|                                    | e)   | FHSS in 902-928MHz with $\geq 25$ & $<50$ channels: $\leq 0.25$ Watt | <input type="checkbox"/>            |
|                                    | f)   | DTS in 902-928MHz, 2400-2483.5MHz: $\leq 1$ Watt                     | <input checked="" type="checkbox"/> |

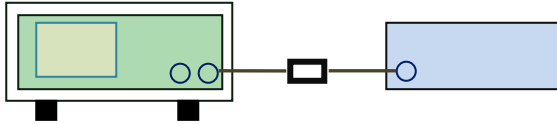
|            |  |
|------------|--|
| Test Setup |  <p style="text-align: center;">Spectrum Analyzer                      EUT</p> |
|------------|--|

|                |   |
|----------------|---|
| Test Procedure | <p>558074 D01 DTS MEAS Guidance v03r03, 9.1.2 Integrated band power method<br/>Maximum output power measurement procedure</p> <ol style="list-style-type: none"> <li>Set the RBW <math>\geq</math> DTS bandwidth.</li> <li>Set VBW <math>\geq 3 \times</math> RBW.</li> <li>Set span <math>\geq 3 \times</math> RBW</li> <li>Sweep time = auto couple.</li> <li>Detector = peak.</li> <li>Trace mode = max hold.</li> <li>Allow trace to fully stabilize.</li> <li>Use peak marker function to determine the peak amplitude level.</li> </ol> |
|----------------|---|

|        |  |
|--------|--|
| Remark |  |
| Result | <input checked="" type="checkbox"/> Pass <input type="checkbox"/> Fail |

Test Data  Yes  N/A  
 Test Plot  Yes (See below)  N/A

### Output Power measurement result

#### Test Data

| Type         | CH   | Frequency (MHz) | Conducted Power (dBm) | Limit (dBm) | Result |
|--------------|------|-----------------|-----------------------|-------------|--------|
| Output power | Low  | 2402            | 3.488                 | 30          | Pass   |
|              | Mid  | 2440            | 3.038                 | 30          | Pass   |
|              | High | 2480            | 3.346                 | 30          | Pass   |

#### Test Plots

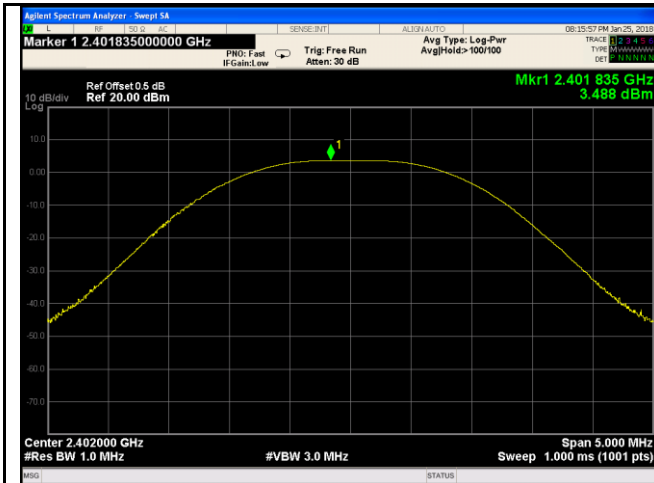

PK Output power - Low CH 2402

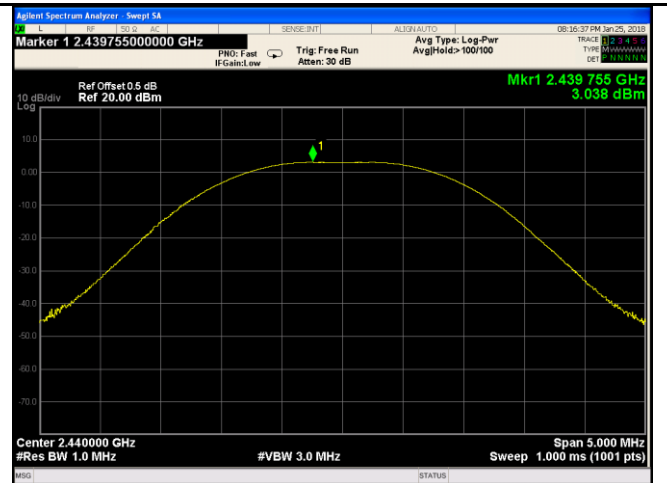

PK Output power - Mid CH 2440

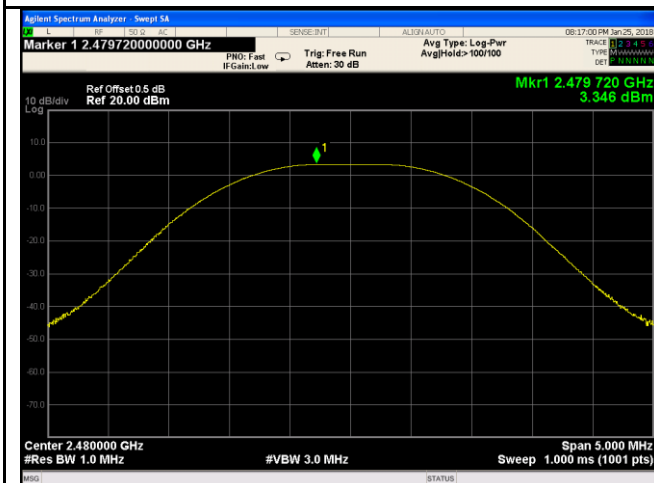

PK Output power - High CH 2480

## 6.4 Power Spectral Density

|                      |                  |
|----------------------|------------------|
| Temperature          | 26 °C            |
| Relative Humidity    | 57%              |
| Atmospheric Pressure | 1025mbar         |
| Test date :          | January 25, 2018 |
| Tested By :          | Aaron Liang      |

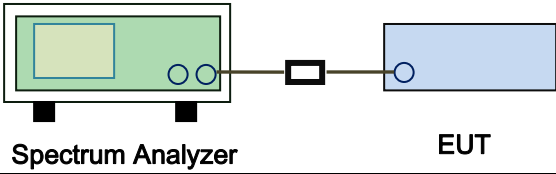
| Spec           | Item  | Requirement  | Applicable                          |
|----------------|---|--|-------------------------------------|
| §15.247(e)     | a)  | The power spectral density conducted from the intentional radiator to the antenna shall not be greater than 8 dBm in any 3 kHz band during any time interval of continuous transmission. | <input checked="" type="checkbox"/> |
| Test Setup     |  <p style="text-align: center;">Spectrum Analyzer                      EUT</p>  |  |                                     |
| Test Procedure | <p>558074 D01 DTS MEAS Guidance v03r03, 10.2 power spectral density method power spectral density measurement procedure</p> <ul style="list-style-type: none"> <li>- a) Set analyzer center frequency to DTS channel center frequency.</li> <li>- b) Set the span to 1.5 times the DTS bandwidth.</li> <li>- c) Set the RBW to: 3 kHz ≤ RBW ≤ 100 kHz.</li> <li>- d) Set the VBW ≥ 3 × RBW.</li> <li>- e) Detector = peak.</li> <li>- f) Sweep time = auto couple.</li> <li>- g) Trace mode = max hold.</li> <li>- h) Allow trace to fully stabilize.</li> <li>- i) Use the peak marker function to determine the maximum amplitude level within the RBW.</li> <li>- j) If measured value exceeds limit, reduce RBW (no less than 3 kHz) and repeat.</li> </ul> |  |                                     |
| Remark         |   |  |                                     |
| Result         | <input checked="" type="checkbox"/> Pass <input type="checkbox"/> Fail  |  |                                     |

Test Data     Yes                       N/A  
 Test Plot     Yes (See below)                       N/A

### Power Spectral Density measurement result

#### Test Data

| Type | CH   | Freq (MHz) | Reading (dBm) | Factor (dB) | Result (dBm) | Limit (dBm) | Result |
|------|------|------------|---------------|-------------|--------------|-------------|--------|
| PSD  | Low  | 2402       | -6.601        | -5.23       | -11.831      | 8           | Pass   |
|      | Mid  | 2440       | -7.007        | -5.23       | -12.237      | 8           | Pass   |
|      | High | 2480       | -6.819        | -5.23       | -12.049      | 8           | Pass   |

Note: factor= $10\log(3/10)=-5.23$

#### Test Plots

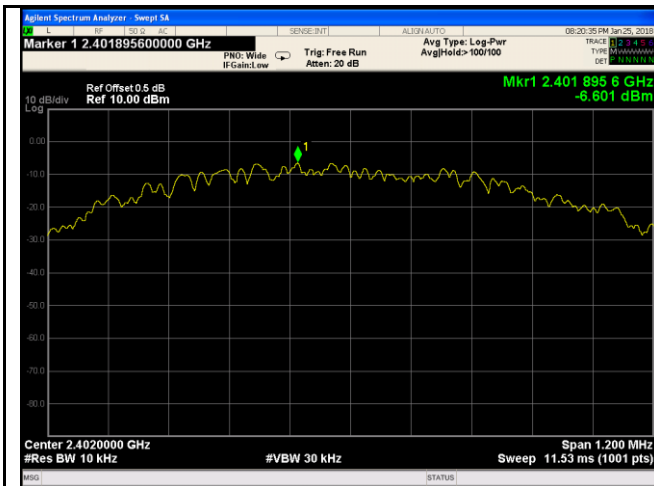

PSD - Low CH 2402

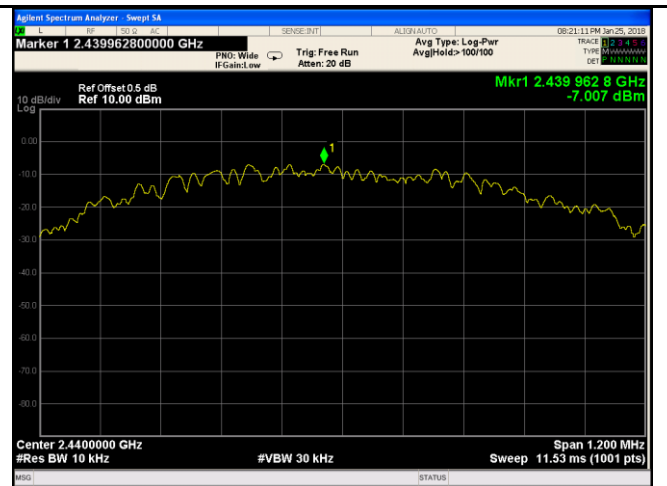

PSD - Mid CH 2440

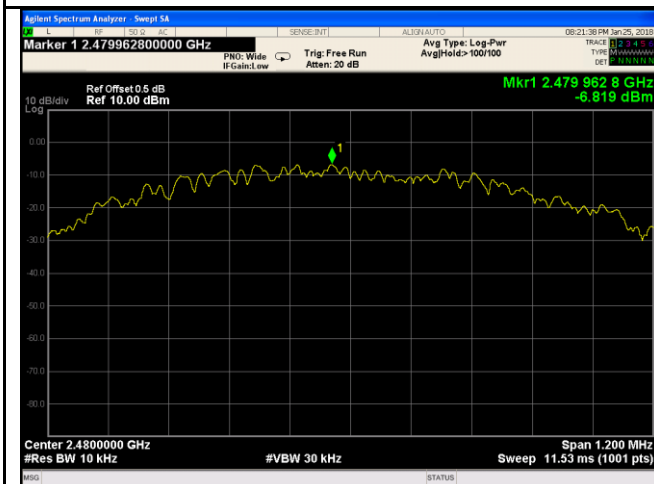

PSD - High CH 2480



## 6.5 Band-Edge & Unwanted Emissions into Restricted Frequency Bands

|                      |                  |
|----------------------|------------------|
| Temperature          | 25 °C            |
| Relative Humidity    | 57%              |
| Atmospheric Pressure | 1018mbar         |
| Test date :          | January 19, 2018 |
| Tested By :          | Aaron Liang      |

### Requirement(s):

| Spec       | Item | Requirement   | Applicable                          |
|------------|------|---|-------------------------------------|
| §15.247(d) | a)   | In any 100 kHz bandwidth outside the frequency band in which the spread spectrum or digitally modulated intentional radiator is operating, the radio frequency power that is produced by the intentional radiator shall be at least 20 dB below that in the 100 kHz bandwidth within the band that contains the highest level of the desired power, based on either an RF conducted or a radiated measurement, provided the transmitter demonstrates compliance with the peak conducted power limits. | <input checked="" type="checkbox"/> |

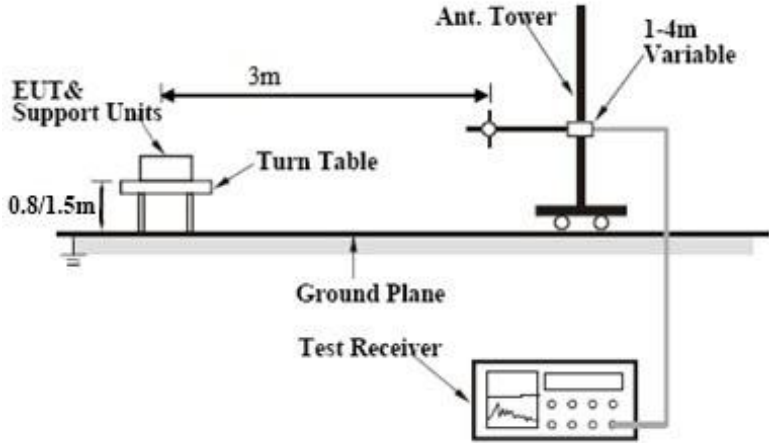
|            |  |
|------------|--|
| Test Setup |  |
|------------|--|

|                |   |
|----------------|---|
| Test Procedure | <p>Radiated Method Only</p> <ul style="list-style-type: none"> <li>- 1. Check the calibration of the measuring instrument using either an internal calibrator or a known signal from an external generator.</li> <li>- 2. Position the EUT without connection to measurement instrument. Put it on the Rotated table and turn on the EUT and make it operate in transmitting mode. Then set it to Low Channel and High Channel within its operating range, and make sure the instrument is operated in its linear range.</li> </ul> |
|----------------|---|

|                 |                 |
|-----------------|-----------------|
| Test Report No. | 18070046-FCC-R4 |
| Page            | 18 of 53        |

|        |   |
|--------|---|
|        | <ul style="list-style-type: none"> <li>- 3. First, set both RBW and VBW of spectrum analyzer to 100 kHz with a convenient frequency span including 100kHz bandwidth from band edge, check the emission of EUT, if pass then set Spectrum Analyzer as below:               <ul style="list-style-type: none"> <li>a. The resolution bandwidth and video bandwidth of test receiver/spectrum analyzer is 120 kHz for Quasiy Peak detection at frequency below 1GHz.</li> <li>b. The resolution bandwidth of test receiver/spectrum analyzer is 1MHz and video bandwidth is 3MHz with Peak detection for Peak measurement at frequency above 1GHz.</li> <li>c. The resolution bandwidth of test receiver/spectrum analyzer is 1MHz and the video bandwidth is 10Hz with Peak detection for Average Measurement as below at frequency above 1GHz.</li> </ul> </li> <li>- 4. Measure the highest amplitude appearing on spectral display and set it as a reference level. Plot the graph with marking the highest point and edge frequency.</li> <li>- 5. Repeat above procedures until all measured frequencies were complete.</li> </ul> |
| Remark |   |
| Result | <input checked="" type="checkbox"/> Pass <input type="checkbox"/> Fail  |

Test Data     Yes                       N/A

Test Plot     Yes (See below)             N/A

### Test Plots

#### Band Edge measurement result

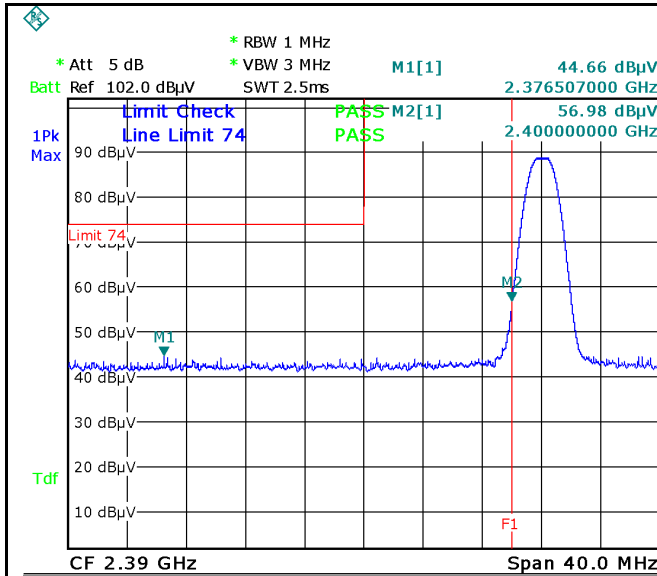

Date: 19.JAN.2018 19:25:35

#### Band Edge, Left Side (Peak)

Note: F1 is frequency 2390MHz; F2 is frequency 2400MHz

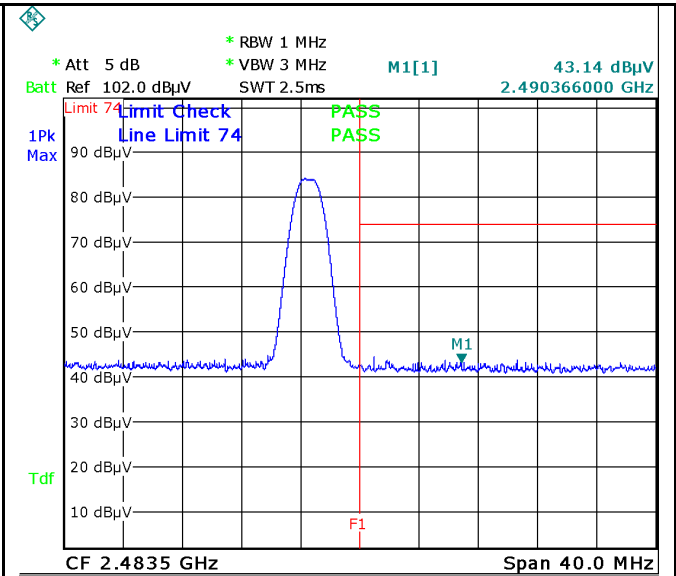

Date: 19.JAN.2018 19:23:51

#### Band Edge, Right Side (Peak)

Note: F1 is frequency 2483.5MHz

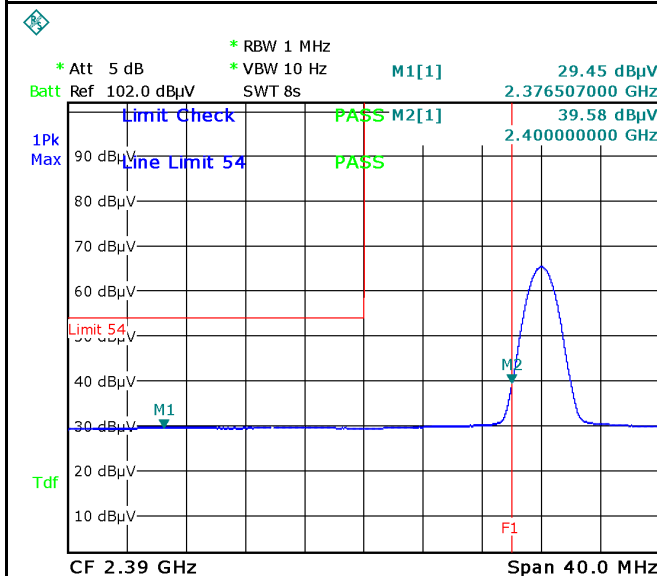

Date: 19.JAN.2018 19:26:06

#### Band Edge, Left Side-AV

Note: (no need if PK value less than the AV limit)

#### Band Edge, Right Side-AV

Note: Both Horizontal and vertical polarities were investigated.

## 6.6 AC Power Line Conducted Emissions

|                      |                  |
|----------------------|------------------|
| Temperature          | 24 °C            |
| Relative Humidity    | 53%              |
| Atmospheric Pressure | 1010mbar         |
| Test date :          | January 15, 2018 |
| Tested By :          | Aaron Liang      |

### Requirement(s):

| Spec                        | Item    | Requirement  | Applicable                          |                        |              |  |    |         |            |         |         |         |    |    |        |    |    |
|-----------------------------|---------|--|-------------------------------------|------------------------|--------------|--|----|---------|------------|---------|---------|---------|----|----|--------|----|----|
| 47CFR§15.207, RSS210 (A8.1) | a)      | For Low-power radio-frequency devices that is designed to be connected to the public utility (AC) power line, the radio frequency voltage that is conducted back onto the AC power line on any frequency or frequencies, within the band 150 kHz to 30 MHz, shall not exceed the limits in the following table, as measured using a 50 [mu] H/50 ohms line impedance stabilization network (LISN). The lower limit applies at the boundary between the frequencies ranges. | <input checked="" type="checkbox"/> |                        |              |  |    |         |            |         |         |         |    |    |        |    |    |
|                             |         | <table border="1"> <thead> <tr> <th rowspan="2">Frequency ranges (MHz)</th> <th colspan="2">Limit (dBµV)</th> </tr> <tr> <th>QP</th> <th>Average</th> </tr> </thead> <tbody> <tr> <td>0.15 ~ 0.5</td> <td>66 – 56</td> <td>56 – 46</td> </tr> <tr> <td>0.5 ~ 5</td> <td>56</td> <td>46</td> </tr> <tr> <td>5 ~ 30</td> <td>60</td> <td>50</td> </tr> </tbody> </table>   |                                     | Frequency ranges (MHz) | Limit (dBµV) |  | QP | Average | 0.15 ~ 0.5 | 66 – 56 | 56 – 46 | 0.5 ~ 5 | 56 | 46 | 5 ~ 30 | 60 | 50 |
|                             |         | Frequency ranges (MHz)   |                                     |                        | Limit (dBµV) |  |    |         |            |         |         |         |    |    |        |    |    |
|                             |         |  |                                     | QP                     | Average      |  |    |         |            |         |         |         |    |    |        |    |    |
| 0.15 ~ 0.5                  | 66 – 56 | 56 – 46  |                                     |                        |              |  |    |         |            |         |         |         |    |    |        |    |    |
| 0.5 ~ 5                     | 56      | 46   |                                     |                        |              |  |    |         |            |         |         |         |    |    |        |    |    |
| 5 ~ 30                      | 60      | 50   |                                     |                        |              |  |    |         |            |         |         |         |    |    |        |    |    |

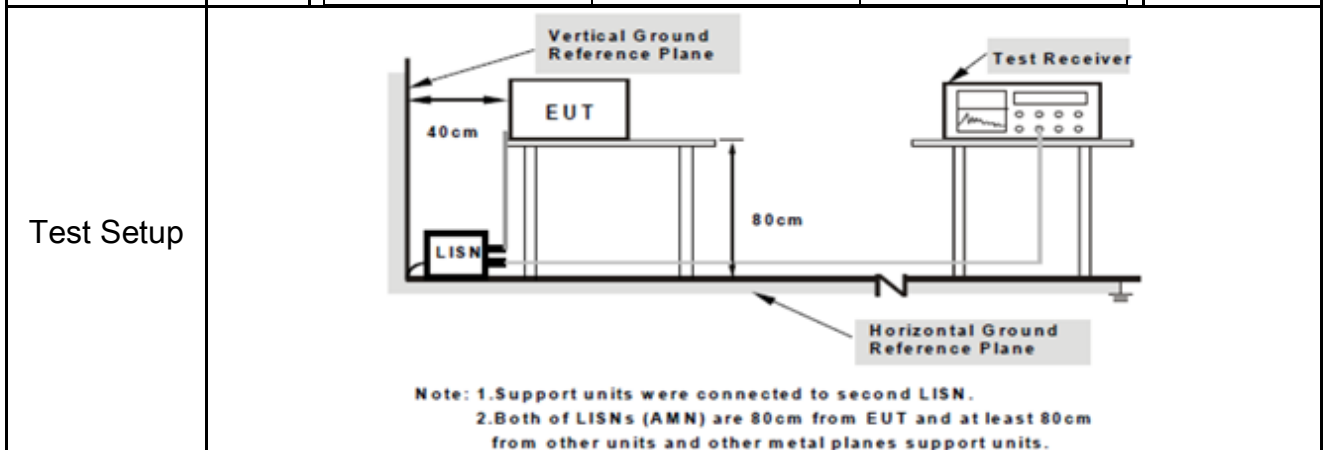

|           |   |
|-----------|---|
| Procedure | <ol style="list-style-type: none"> <li>The EUT and supporting equipment were set up in accordance with the requirements of the standard on top of a 1.5m x 1m x 0.8m high, non-metallic table.</li> <li>The power supply for the EUT was fed through a 50W/50mH EUT LISN, connected to filtered mains.</li> <li>The RF OUT of the EUT LISN was connected to the EMI test receiver via a low-loss</li> </ol> |
|-----------|---|

|        |  |
|--------|--|
|        | <p>coaxial cable.</p> <ol style="list-style-type: none"> <li>4. All other supporting equipment were powered separately from another main supply.</li> <li>5. The EUT was switched on and allowed to warm up to its normal operating condition.</li> <li>6. A scan was made on the NEUTRAL line (for AC mains) or Earth line (for DC power) over the required frequency range using an EMI test receiver.</li> <li>7. High peaks, relative to the limit line, The EMI test receiver was then tuned to the selected frequencies and the necessary measurements made with a receiver bandwidth setting of 10 kHz.</li> <li>8. Step 7 was then repeated for the LIVE line (for AC mains) or DC line (for DC power).</li> </ol> |
| Remark |  |
| Result | <input checked="" type="checkbox"/> Pass <input type="checkbox"/> Fail   |

Test Data     Yes                       N/A

Test Plot     Yes (See below)             N/A

|                   |                          |
|-------------------|--------------------------|
| <b>Test Mode:</b> | <b>Transmitting Mode</b> |
|-------------------|--------------------------|

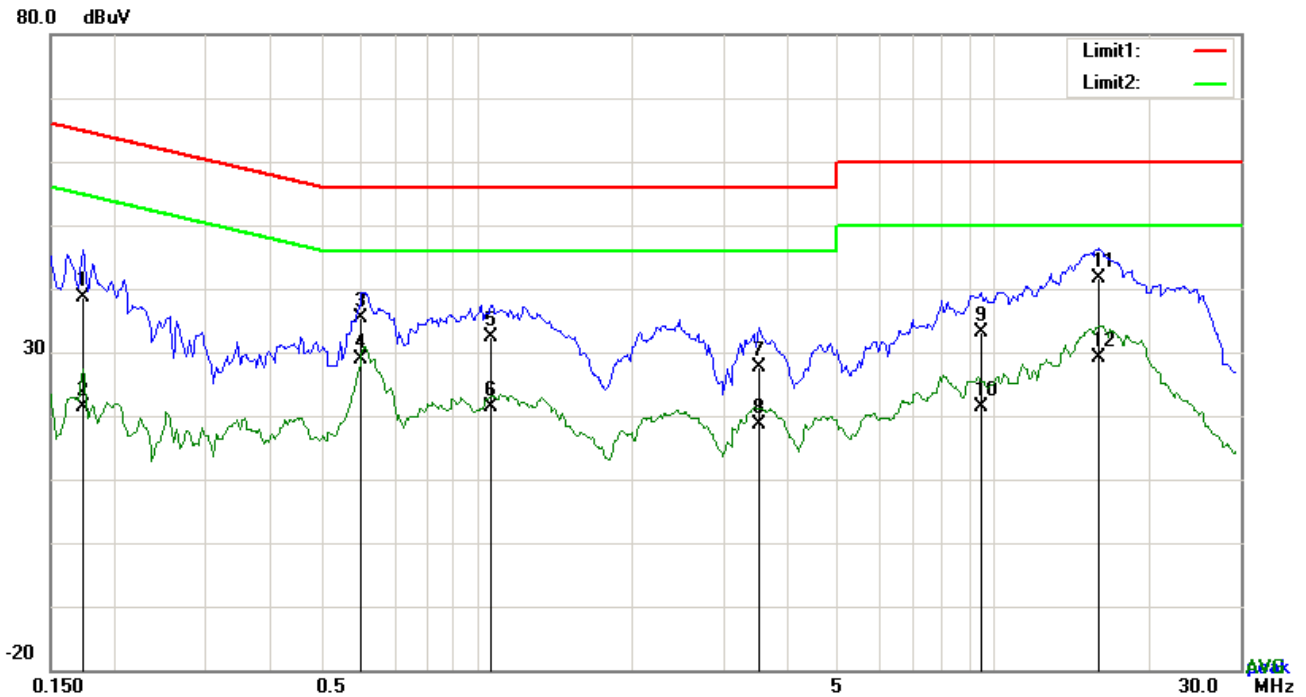

**Test Data**

**Phase Line Plot at 120Vac, 60Hz**

| No. | P/L | Frequency (MHz) | Reading (dBµV) | Detector | Corrected (dB) | Result (dBµV) | Limit (dBµV) | Margin (dB) |
|-----|-----|-----------------|----------------|----------|----------------|---------------|--------------|-------------|
| 1   | L1  | 0.1734          | 28.71          | QP       | 10.03          | 38.74         | 64.80        | -26.06      |
| 2   | L1  | 0.1734          | 11.24          | AVG      | 10.03          | 21.27         | 54.80        | -33.53      |
| 3   | L1  | 0.5985          | 25.32          | QP       | 10.03          | 35.35         | 56.00        | -20.65      |
| 4   | L1  | 0.5985          | 18.90          | AVG      | 10.03          | 28.93         | 46.00        | -17.07      |
| 5   | L1  | 1.0704          | 22.44          | QP       | 10.03          | 32.47         | 56.00        | -23.53      |
| 6   | L1  | 1.0704          | 11.28          | AVG      | 10.03          | 21.31         | 46.00        | -24.69      |
| 7   | L1  | 3.5109          | 17.60          | QP       | 10.06          | 27.66         | 56.00        | -28.34      |
| 8   | L1  | 3.5109          | 8.67           | AVG      | 10.06          | 18.73         | 46.00        | -27.27      |
| 9   | L1  | 9.4623          | 22.97          | QP       | 10.14          | 33.11         | 60.00        | -26.89      |
| 10  | L1  | 9.4623          | 11.29          | AVG      | 10.14          | 21.43         | 50.00        | -28.57      |
| 11  | L1  | 15.9831         | 31.29          | QP       | 10.24          | 41.53         | 60.00        | -18.47      |
| 12  | L1  | 15.9831         | 18.83          | AVG      | 10.24          | 29.07         | 50.00        | -20.93      |

|                   |                          |
|-------------------|--------------------------|
| <b>Test Mode:</b> | <b>Transmitting Mode</b> |
|-------------------|--------------------------|

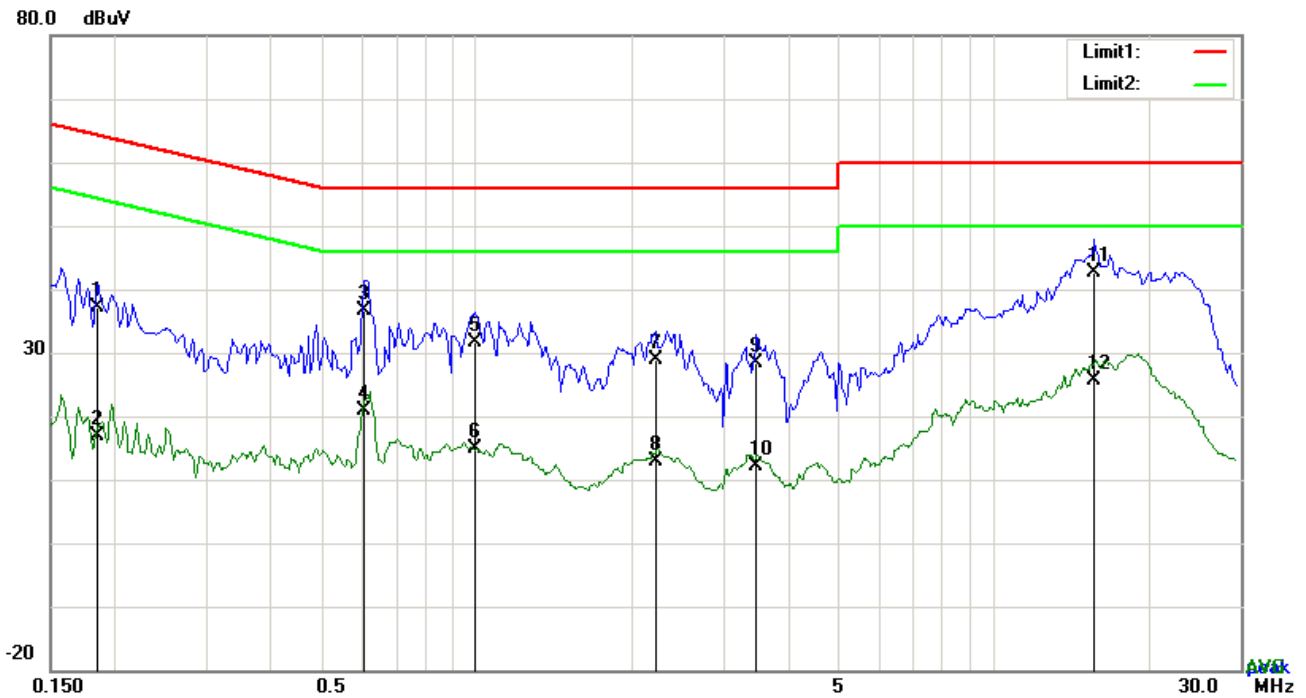

**Test Data**

**Phase Neutral Plot at 120Vac, 60Hz**

| No. | P/L | Frequency (MHz) | Reading (dBμV) | Detector | Corrected (dB) | Result (dBμV) | Limit (dBμV) | Margin (dB) |
|-----|-----|-----------------|----------------|----------|----------------|---------------|--------------|-------------|
| 1   | N   | 0.1851          | 27.13          | QP       | 10.02          | 37.15         | 64.25        | -27.10      |
| 2   | N   | 0.1851          | 6.77           | AVG      | 10.02          | 16.79         | 54.25        | -37.46      |
| 3   | N   | 0.6063          | 26.52          | QP       | 10.02          | 36.54         | 56.00        | -19.46      |
| 4   | N   | 0.6063          | 10.83          | AVG      | 10.02          | 20.85         | 46.00        | -25.15      |
| 5   | N   | 0.9924          | 21.59          | QP       | 10.03          | 31.62         | 56.00        | -24.38      |
| 6   | N   | 0.9924          | 4.74           | AVG      | 10.03          | 14.77         | 46.00        | -31.23      |
| 7   | N   | 2.2209          | 18.72          | QP       | 10.04          | 28.76         | 56.00        | -27.24      |
| 8   | N   | 2.2209          | 2.79           | AVG      | 10.04          | 12.83         | 46.00        | -33.17      |
| 9   | N   | 3.4797          | 18.29          | QP       | 10.05          | 28.34         | 56.00        | -27.66      |
| 10  | N   | 3.4797          | 2.00           | AVG      | 10.05          | 12.05         | 46.00        | -33.95      |
| 11  | N   | 15.6360         | 32.41          | QP       | 10.21          | 42.62         | 60.00        | -17.38      |
| 12  | N   | 15.6360         | 15.43          | AVG      | 10.21          | 25.64         | 50.00        | -24.36      |

**Test Mode:** Transmitting Mode

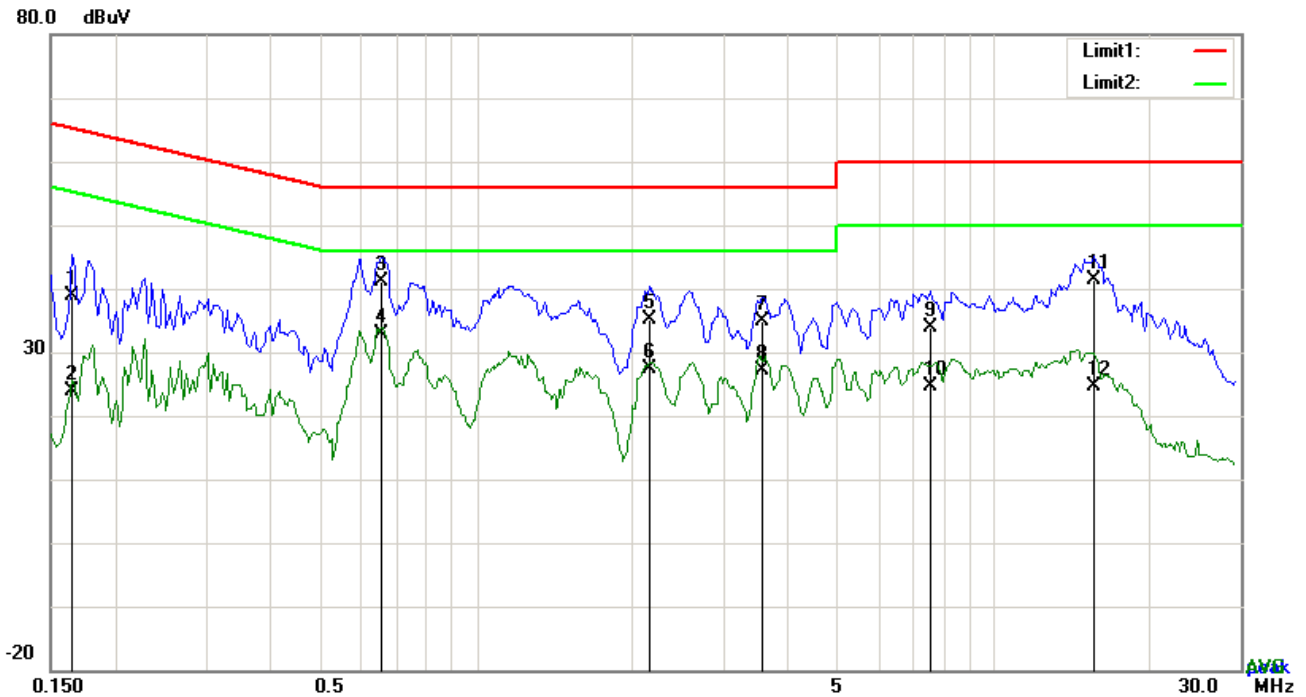

**Test Data**

**Phase Line Plot at 240Vac, 60Hz**

| No. | P/L | Frequency (MHz) | Reading (dBµV) | Detector | Corrected (dB) | Result (dBµV) | Limit (dBµV) | Margin (dB) |
|-----|-----|-----------------|----------------|----------|----------------|---------------|--------------|-------------|
| 1   | L1  | 0.1656          | 28.96          | QP       | 10.03          | 38.99         | 65.18        | -26.19      |
| 2   | L1  | 0.1656          | 13.96          | AVG      | 10.03          | 23.99         | 55.18        | -31.19      |
| 3   | L1  | 0.6570          | 31.22          | QP       | 10.03          | 41.25         | 56.00        | -14.75      |
| 4   | L1  | 0.6570          | 22.86          | AVG      | 10.03          | 32.89         | 46.00        | -13.11      |
| 5   | L1  | 2.1585          | 24.97          | QP       | 10.04          | 35.01         | 56.00        | -20.99      |
| 6   | L1  | 2.1585          | 17.22          | AVG      | 10.04          | 27.26         | 46.00        | -18.74      |
| 7   | L1  | 3.5811          | 24.87          | QP       | 10.06          | 34.93         | 56.00        | -21.07      |
| 8   | L1  | 3.5811          | 17.06          | AVG      | 10.06          | 27.12         | 46.00        | -18.88      |
| 9   | L1  | 7.5396          | 23.71          | QP       | 10.12          | 33.83         | 60.00        | -26.17      |
| 10  | L1  | 7.5396          | 14.47          | AVG      | 10.12          | 24.59         | 50.00        | -25.41      |
| 11  | L1  | 15.6282         | 31.25          | QP       | 10.23          | 41.48         | 60.00        | -18.52      |
| 12  | L1  | 15.6282         | 14.40          | AVG      | 10.23          | 24.63         | 50.00        | -25.37      |



|                   |                          |
|-------------------|--------------------------|
| <b>Test Mode:</b> | <b>Transmitting Mode</b> |
|-------------------|--------------------------|

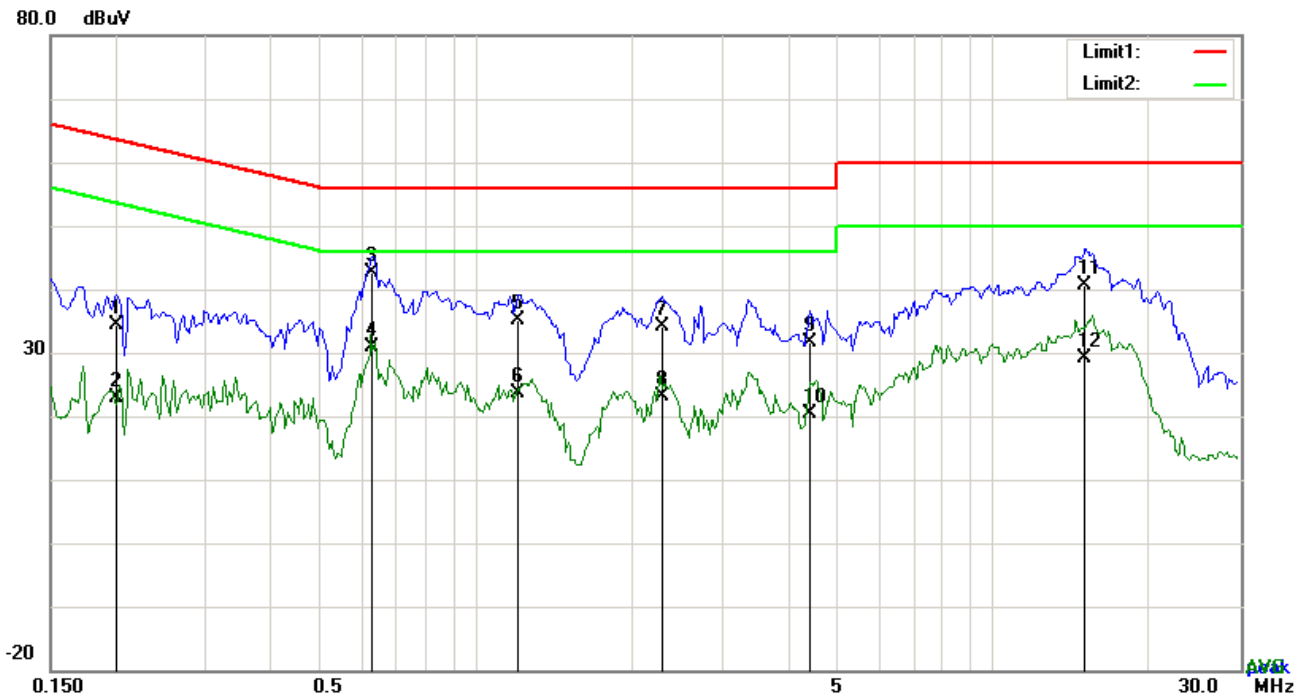

**Test Data**

**Phase Neutral Plot at 240Vac, 60Hz**

| No. | P/L | Frequency (MHz) | Reading (dBµV) | Detector | Corrected (dB) | Result (dBµV) | Limit (dBµV) | Margin (dB) |
|-----|-----|-----------------|----------------|----------|----------------|---------------|--------------|-------------|
| 1   | N   | 0.2007          | 24.39          | QP       | 10.02          | 34.41         | 63.58        | -29.17      |
| 2   | N   | 0.2007          | 12.79          | AVG      | 10.02          | 22.81         | 53.58        | -30.77      |
| 3   | N   | 0.6297          | 32.58          | QP       | 10.02          | 42.60         | 56.00        | -13.40      |
| 4   | N   | 0.6297          | 20.95          | AVG      | 10.02          | 30.97         | 46.00        | -15.03      |
| 5   | N   | 1.2069          | 25.09          | QP       | 10.03          | 35.12         | 56.00        | -20.88      |
| 6   | N   | 1.2069          | 13.60          | AVG      | 10.03          | 23.63         | 46.00        | -22.37      |
| 7   | N   | 2.2950          | 24.16          | QP       | 10.04          | 34.20         | 56.00        | -21.80      |
| 8   | N   | 2.2950          | 13.11          | AVG      | 10.04          | 23.15         | 46.00        | -22.85      |
| 9   | N   | 4.4196          | 21.64          | QP       | 10.06          | 31.70         | 56.00        | -24.30      |
| 10  | N   | 4.4196          | 10.25          | AVG      | 10.06          | 20.31         | 46.00        | -25.69      |
| 11  | N   | 15.0393         | 30.47          | QP       | 10.20          | 40.67         | 60.00        | -19.33      |
| 12  | N   | 15.0393         | 19.02          | AVG      | 10.20          | 29.22         | 50.00        | -20.78      |

## 6.7 Radiated Emissions & Restricted Band

|                      |                  |
|----------------------|------------------|
| Temperature          | 25 °C            |
| Relative Humidity    | 57%              |
| Atmospheric Pressure | 1016mbar         |
| Test date :          | January 17, 2018 |
| Tested By :          | Aaron Liang      |

### Requirement(s):

| Spec                                 | Item  | Requirement  | Applicable            |                       |             |             |             |              |            |    |         |     |          |     |         |     |           |     |                                     |
|--------------------------------------|---|--|-----------------------|-----------------------|-------------|-------------|-------------|--------------|------------|----|---------|-----|----------|-----|---------|-----|-----------|-----|-------------------------------------|
| 47CFR§15.247(d),<br>RSS210<br>(A8.5) | a)  | <p>Except higher limit as specified elsewhere in other section, the emissions from the low-power radio-frequency devices shall not exceed the field strength levels specified in the following table and the level of any unwanted emissions shall not exceed the level of the fundamental emission. The tighter limit applies at the band edges</p> <table border="1"> <thead> <tr> <th>Frequency range (MHz)</th> <th>Field Strength (µV/m)</th> </tr> </thead> <tbody> <tr> <td>0.009~0.490</td> <td>2400/F(KHz)</td> </tr> <tr> <td>0.490~1.705</td> <td>24000/F(KHz)</td> </tr> <tr> <td>1.705~30.0</td> <td>30</td> </tr> <tr> <td>30 – 88</td> <td>100</td> </tr> <tr> <td>88 – 216</td> <td>150</td> </tr> <tr> <td>216 960</td> <td>200</td> </tr> <tr> <td>Above 960</td> <td>500</td> </tr> </tbody> </table> | Frequency range (MHz) | Field Strength (µV/m) | 0.009~0.490 | 2400/F(KHz) | 0.490~1.705 | 24000/F(KHz) | 1.705~30.0 | 30 | 30 – 88 | 100 | 88 – 216 | 150 | 216 960 | 200 | Above 960 | 500 | <input checked="" type="checkbox"/> |
|                                      | Frequency range (MHz)   | Field Strength (µV/m)  |                       |                       |             |             |             |              |            |    |         |     |          |     |         |     |           |     |                                     |
|                                      | 0.009~0.490   | 2400/F(KHz)  |                       |                       |             |             |             |              |            |    |         |     |          |     |         |     |           |     |                                     |
| 0.490~1.705                          | 24000/F(KHz)  |  |                       |                       |             |             |             |              |            |    |         |     |          |     |         |     |           |     |                                     |
| 1.705~30.0                           | 30  |  |                       |                       |             |             |             |              |            |    |         |     |          |     |         |     |           |     |                                     |
| 30 – 88                              | 100   |  |                       |                       |             |             |             |              |            |    |         |     |          |     |         |     |           |     |                                     |
| 88 – 216                             | 150   |  |                       |                       |             |             |             |              |            |    |         |     |          |     |         |     |           |     |                                     |
| 216 960                              | 200   |  |                       |                       |             |             |             |              |            |    |         |     |          |     |         |     |           |     |                                     |
| Above 960                            | 500   |  |                       |                       |             |             |             |              |            |    |         |     |          |     |         |     |           |     |                                     |
| b)                                   | <p>For non-restricted band, In any 100 kHz bandwidth outside the frequency band in which the spread spectrum or digitally modulated intentional radiator is operating, the radio frequency power that is produced by the intentional radiator shall be at least 20 dB or 30dB below that in the 100 kHz bandwidth within the band that contains the highest level of the desired power, determined by the measurement method on output power to be used. Attenuation below the general limits specified in § 15.209(a) is not required</p> <p><input checked="" type="checkbox"/> 20 dB down      <input type="checkbox"/> 30 dB down</p> | <input checked="" type="checkbox"/>  |                       |                       |             |             |             |              |            |    |         |     |          |     |         |     |           |     |                                     |
| c)                                   | <p>or restricted band, emission must also comply with the radiated emission limits specified in 15.209</p>  | <input checked="" type="checkbox"/>  |                       |                       |             |             |             |              |            |    |         |     |          |     |         |     |           |     |                                     |

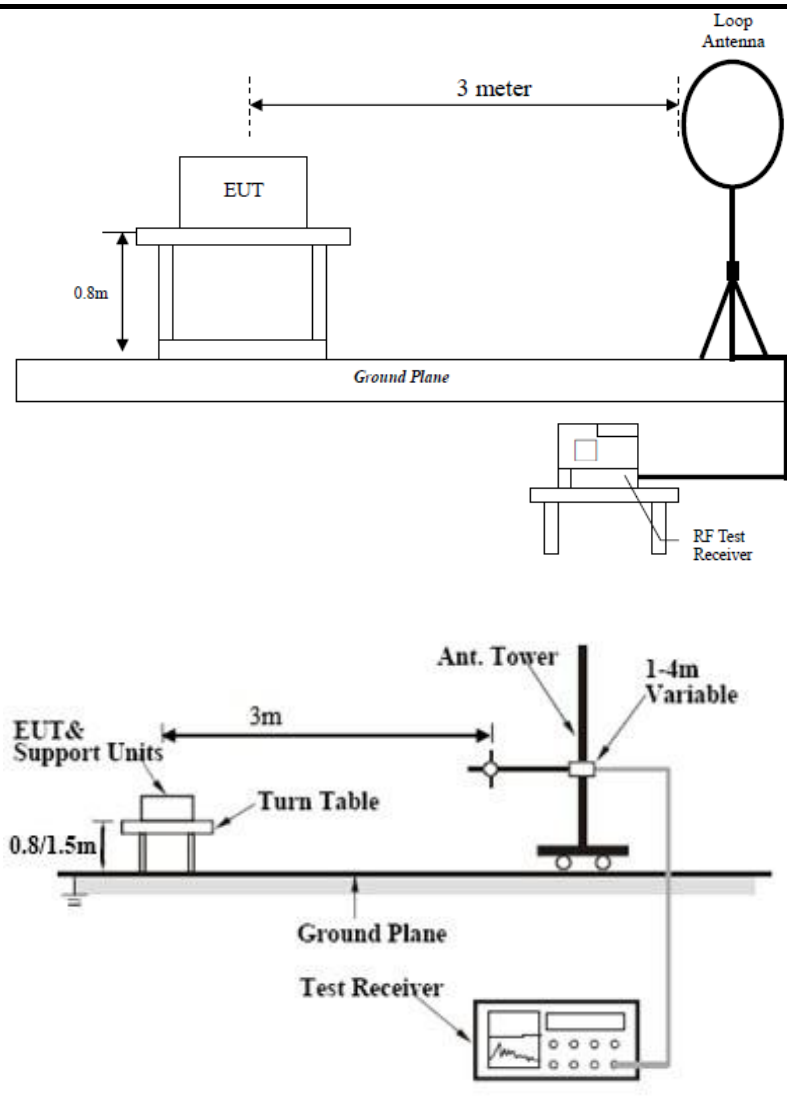
|                   |  |
|-------------------|--|
| <p>Test Setup</p> |   |
| <p>Procedure</p>  | <ol style="list-style-type: none"> <li>1. The EUT was switched on and allowed to warm up to its normal operating condition.</li> <li>2. The test was carried out at the selected frequency points obtained from the EUT characterization. Maximization of the emissions, was carried out by rotating the EUT, changing the antenna polarization, and adjusting the antenna height in the following manner:             <ol style="list-style-type: none"> <li>a. Vertical or horizontal polarization (whichever gave the higher emission level over a full rotation of the EUT) was chosen.</li> <li>b. The EUT was then rotated to the direction that gave the maximum emission.</li> <li>c. Finally, the antenna height was adjusted to the height that gave the maximum emission.</li> </ol> </li> <li>3. The resolution bandwidth and video bandwidth of test receiver/spectrum analyzer is 120 kHz for Quasi Peak detection at frequency below 1GHz.</li> <li>4. The resolution bandwidth of test receiver/spectrum analyzer is 1MHz and video bandwidth is 3MHz with Peak detection for Peak measurement at frequency above 1GHz.</li> </ol> |

|        |   |
|--------|---|
|        | <p>The resolution bandwidth of test receiver/spectrum analyzer is 1MHz and the video bandwidth is 10Hz with Peak detection for Average Measurement as below at frequency above 1GHz.</p> <p>5. Steps 2 and 3 were repeated for the next frequency point, until all selected frequency points were measured.</p> |
| Remark |   |
| Result | <input checked="" type="checkbox"/> Pass <input type="checkbox"/> Fail  |

Test Data     Yes       N/A  
 Test Plot     Yes (See below)     N/A

**Test Result:**

|                   |                   |
|-------------------|-------------------|
| <b>Test Mode:</b> | Transmitting Mode |
|-------------------|-------------------|

Frequency range: 9KHz - 30MHz

| Freq.<br>(MHz) | Detection<br>value | Factor<br>(dB/m) | Reading<br>(dBuV/m) | Result<br>(dBuV/m) | Limit@3m<br>(dBuV/m) | Margin<br>(dB) |
|----------------|--------------------|------------------|---------------------|--------------------|----------------------|----------------|
| --             | --                 | --               | --                  | --                 | --                   | >20            |
| --             | --                 | --               | --                  | --                 | --                   | >20            |

Note:

The amplitude of spurious emissions which are attenuated by more than 20dB below the permissible value has no need to be reported.

Distance extrapolation factor = 40 log (specific distance/test distance)(dB);

Limit line = specific limits(dBuv) + distance extrapolation factor.

|                   |                          |
|-------------------|--------------------------|
| <b>Test Mode:</b> | <b>Transmitting Mode</b> |
|-------------------|--------------------------|

**30MHz -1GHz**

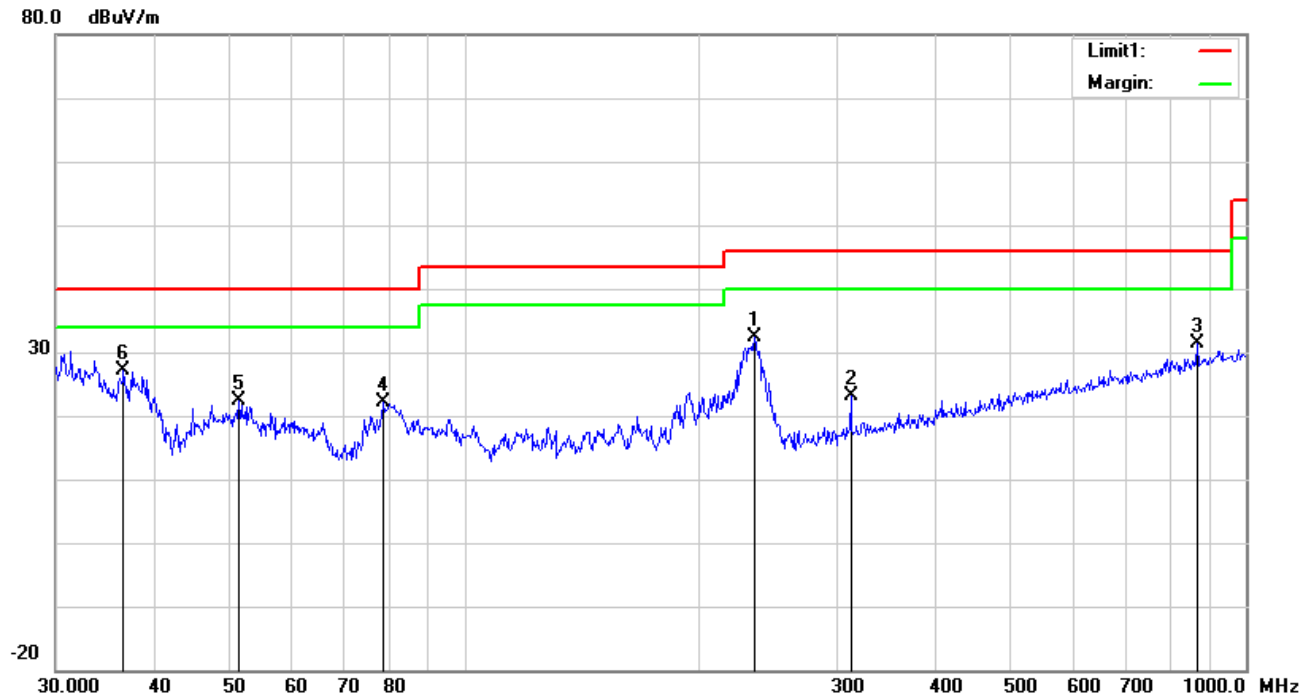

*Test Data*

**Vertical Polarity Plot @3m**

| No. | P/L | Frequency<br>(MHz) | Reading<br>(dBuV/m) | Detect<br>or | Ant_F<br>(dB/m) | PA_G<br>(dB) | Cab_L<br>(dB) | Result<br>(dBuV/m) | Limit<br>(dBuV/m) | Margin<br>(dB) | Height<br>(cm) | Degr<br>ee<br>( ) |
|-----|-----|--------------------|---------------------|--------------|-----------------|--------------|---------------|--------------------|-------------------|----------------|----------------|-------------------|
| 1   | V   | 234.9909           | 41.36               | peak         | 11.61           | 22.32        | 1.65          | 32.30              | 46.00             | -13.70         | 100            | 152               |
| 2   | V   | 312.1794           | 29.77               | peak         | 13.86           | 22.26        | 1.85          | 23.22              | 46.00             | -22.78         | 100            | 98                |
| 3   | V   | 866.0879           | 27.23               | peak         | 22.13           | 20.97        | 2.93          | 31.32              | 46.00             | -14.68         | 100            | 117               |
| 4   | V   | 78.6888            | 35.81               | peak         | 7.63            | 22.41        | 1.03          | 22.06              | 40.00             | -17.94         | 100            | 140               |
| 5   | V   | 51.4807            | 35.82               | peak         | 8.24            | 22.38        | 0.79          | 22.47              | 40.00             | -17.53         | 100            | 324               |
| 6   | V   | 36.6375            | 32.28               | peak         | 16.35           | 22.26        | 0.77          | 27.14              | 40.00             | -12.86         | 100            | 52                |

### 30MHz -1GHz

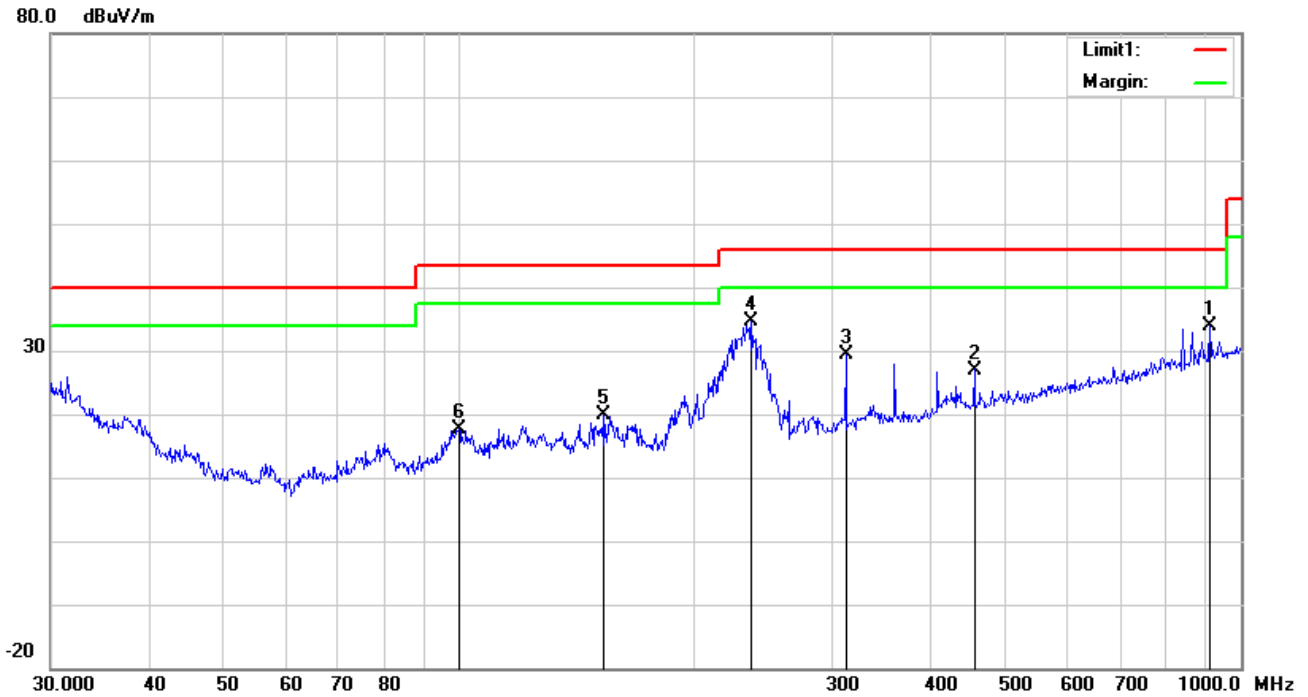

### Test Data

### Horizontal Polarity Plot @3m

| N o. | P/L | Frequency (MHz) | Reading (dBuV/m) | Detect or | Ant_F (dB/m) | PA_G (dB) | Cab_L (dB) | Result (dBuV/m) | Limit (dBuV/m) | Margin (dB) | Height (cm) | Degr ee ( ) |
|------|-----|-----------------|------------------|-----------|--------------|-----------|------------|-----------------|----------------|-------------|-------------|-------------|
| 1    | H   | 912.8620        | 29.11            | peak      | 22.56        | 20.86     | 3.10       | 33.91           | 46.00          | -12.09      | 100         | 227         |
| 2    | H   | 455.9058        | 29.92            | peak      | 16.82        | 21.90     | 2.16       | 27.00           | 46.00          | -19.00      | 100         | 316         |
| 3    | H   | 312.1794        | 35.87            | peak      | 13.86        | 22.26     | 1.85       | 29.32           | 46.00          | -16.68      | 100         | 349         |
| 4    | H   | 236.6447        | 43.74            | peak      | 11.59        | 22.31     | 1.66       | 34.68           | 46.00          | -11.32      | 100         | 300         |
| 5    | H   | 153.2004        | 28.12            | peak      | 12.60        | 22.32     | 1.36       | 19.76           | 43.50          | -23.74      | 100         | 343         |
| 6    | H   | 99.8777         | 28.44            | peak      | 10.37        | 22.32     | 1.12       | 17.61           | 43.50          | -25.89      | 100         | 280         |

**Above 1GHz**

|                   |                          |
|-------------------|--------------------------|
| <b>Test Mode:</b> | <b>Transmitting Mode</b> |
|-------------------|--------------------------|

**Low Channel (2402 MHz)**

| Frequency (MHz) | S.A. Reading (dB $\mu$ V) | Detector (PK/AV) | Polarity (H/V) | Ant. Factor (dB/m) | Cable Loss (dB) | Pre-Amp. Gain (dB) | Cord. Amp. (dB $\mu$ V/m) | Limit (dB $\mu$ V/m) | Margin (dB) |
|-----------------|---------------------------|------------------|----------------|--------------------|-----------------|--------------------|---------------------------|----------------------|-------------|
| 4804            | 45.37                     | AV               | V              | 33.39              | 7.22            | 48.46              | 37.52                     | 54                   | -16.48      |
| 4804            | 43.03                     | AV               | H              | 33.39              | 7.22            | 48.46              | 35.18                     | 54                   | -18.82      |
| 4804            | 68.77                     | PK               | V              | 33.39              | 7.22            | 48.46              | 60.92                     | 74                   | -13.08      |
| 4804            | 67.24                     | PK               | H              | 33.39              | 7.22            | 48.46              | 59.39                     | 74                   | -14.61      |
| 7147            | 32.52                     | AV               | V              | 36.21              | 8.14            | 48.81              | 28.06                     | 54                   | -25.94      |
| 7147            | 31.35                     | AV               | H              | 36.21              | 8.14            | 48.81              | 26.89                     | 54                   | -27.11      |
| 7147            | 51.07                     | PK               | V              | 36.21              | 8.14            | 48.81              | 46.61                     | 74                   | -27.39      |
| 7147            | 49.45                     | PK               | H              | 36.21              | 8.14            | 48.81              | 44.99                     | 74                   | -29.01      |

**Middle Channel (2440 MHz)**

| Frequency (MHz) | S.A. Reading (dB $\mu$ V) | Detector (PK/AV) | Polarity (H/V) | Ant. Factor (dB/m) | Cable Loss (dB) | Pre-Amp. Gain (dB) | Cord. Amp. (dB $\mu$ V/m) | Limit (dB $\mu$ V/m) | Margin (dB) |
|-----------------|---------------------------|------------------|----------------|--------------------|-----------------|--------------------|---------------------------|----------------------|-------------|
| 4880            | 49.07                     | AV               | V              | 33.62              | 7.53            | 48.36              | 41.86                     | 54                   | -12.14      |
| 4880            | 45.99                     | AV               | H              | 33.62              | 7.53            | 48.36              | 38.78                     | 54                   | -15.22      |
| 4880            | 67.52                     | PK               | V              | 33.62              | 7.53            | 48.36              | 60.31                     | 74                   | -13.69      |
| 4880            | 67.37                     | PK               | H              | 33.62              | 7.53            | 48.36              | 60.16                     | 74                   | -13.84      |
| 9179            | 29.45                     | AV               | V              | 37.73              | 10.12           | 47.57              | 29.73                     | 54                   | -24.27      |
| 9179            | 29.28                     | AV               | H              | 37.73              | 10.12           | 47.57              | 29.56                     | 54                   | -24.44      |
| 9179            | 48.33                     | PK               | V              | 37.73              | 10.12           | 47.57              | 48.61                     | 74                   | -25.39      |
| 9179            | 45.03                     | PK               | H              | 37.73              | 10.12           | 47.57              | 45.31                     | 74                   | -28.69      |

**High Channel (2480 MHz)**

| Frequency (MHz) | S.A. Reading (dB $\mu$ V) | Detector (PK/AV) | Polarity (H/V) | Ant. Factor (dB/m) | Cable Loss (dB) | Pre-Amp. Gain (dB) | Cord. Amp. (dB $\mu$ V/m) | Limit (dB $\mu$ V/m) | Margin (dB) |
|-----------------|---------------------------|------------------|----------------|--------------------|-----------------|--------------------|---------------------------|----------------------|-------------|
| 4960            | 49.92                     | AV               | V              | 33.89              | 7.86            | 48.31              | 43.36                     | 54                   | -10.64      |
| 4960            | 45.82                     | AV               | H              | 33.89              | 7.86            | 48.31              | 39.26                     | 54                   | -14.74      |
| 4960            | 70.04                     | PK               | V              | 33.89              | 7.86            | 48.31              | 63.48                     | 74                   | -10.52      |
| 4960            | 69.64                     | PK               | H              | 33.89              | 7.86            | 48.31              | 63.08                     | 74                   | -10.92      |
| 17772           | 18.66                     | AV               | V              | 42.98              | 16.06           | 46.35              | 31.35                     | 54                   | -22.65      |
| 17772           | 18.02                     | AV               | H              | 42.98              | 16.06           | 46.35              | 30.71                     | 54                   | -23.29      |
| 17772           | 40.21                     | PK               | V              | 42.98              | 16.06           | 46.35              | 52.9                      | 74                   | -21.1       |
| 17772           | 40.83                     | PK               | H              | 42.98              | 16.06           | 46.35              | 53.52                     | 74                   | -20.48      |

**Note:**

- 1, The testing has been conformed to  $10 \times 2480 \text{ MHz} = 24,800 \text{ MHz}$
- 2, All other emissions more than 30 dB below the limit
- 3, X-Axis, Y-Axis and Z-Axis were investigated. The results above show only the worst case.
- 4, The radiated spurious test above 18GHz is subcontracted to SIEMIC (Nanjing-China) Laboratories. and found 30dB below the limit at least.



## Annex A. TEST INSTRUMENT

| Instrument                              | Model    | Serial #    | Cal Date   | Cal Due    | In use                              |
|---|----------|-------------|------------|------------|-------------------------------------|
| <b>AC Line Conducted</b>                |          |             |            |            |                                     |
| EMI test receiver                       | ESCS30   | 8471241027  | 09/15/2017 | 09/14/2018 | <input checked="" type="checkbox"/> |
| Line Impedance                          | LI-125A  | 191106      | 09/23/2017 | 09/22/2018 | <input checked="" type="checkbox"/> |
| Line Impedance                          | LI-125A  | 191107      | 09/23/2017 | 09/22/2018 | <input checked="" type="checkbox"/> |
| ISN                                     | ISN T800 | 34373       | 09/23/2017 | 09/22/2018 | <input type="checkbox"/>            |
| Transient Limiter                       | LIT-153  | 531118      | 08/30/2017 | 08/29/2018 | <input type="checkbox"/>            |
| <b>RF conducted test</b>                |          |             |            |            |                                     |
| Agilent ESA-E SERIES                    | E4407B   | MY45108319  | 09/15/2017 | 09/14/2018 | <input checked="" type="checkbox"/> |
| Power Splitter                          | 1#       | 1#          | 08/30/2017 | 08/29/2018 | <input checked="" type="checkbox"/> |
| DC Power Supply                         | E3640A   | MY40004013  | 09/15/2017 | 09/14/2018 | <input checked="" type="checkbox"/> |
| <b>Radiated Emissions</b>               |          |             |            |            |                                     |
| EMI test receiver                       | ESL6     | 100262      | 09/15/2017 | 09/14/2018 | <input checked="" type="checkbox"/> |
| Positioning Controller                  | UC3000   | MF780208282 | 11/17/2017 | 11/16/2018 | <input checked="" type="checkbox"/> |
| OPT 010 AMPLIFIER<br>(0.1-1300MHz)      | 8447E    | 2727A02430  | 08/30/2017 | 08/29/2018 | <input checked="" type="checkbox"/> |
| Microwave Preamplifier<br>(1 ~ 26.5GHz) | 8449B    | 3008A02402  | 03/23/2017 | 03/22/2018 | <input checked="" type="checkbox"/> |
| Horn Antenna                            | BBHA9170 | 3145226D1   | 09/27/2017 | 09/26/2018 | <input checked="" type="checkbox"/> |
| Active Antenna<br>(9kHz-30MHz)          | AL-130   | 121031      | 10/12/2017 | 10/11/2018 | <input checked="" type="checkbox"/> |
| Bilog Antenna<br>(30MHz~6GHz)           | JB6      | A110712     | 09/19/2017 | 09/18/2018 | <input checked="" type="checkbox"/> |
| Double Ridge Horn<br>Antenna (1 ~18GHz) | AH-118   | 71283       | 09/22/2017 | 09/21/2018 | <input checked="" type="checkbox"/> |
| Universal Radio<br>Communication Tester | CMU200   | 121393      | 09/23/2017 | 09/22/2018 | <input checked="" type="checkbox"/> |

## Annex B. EUT And Test Setup Photographs

### Annex B.i. Photograph: EUT External Photo

Whole Package View



Adapter View

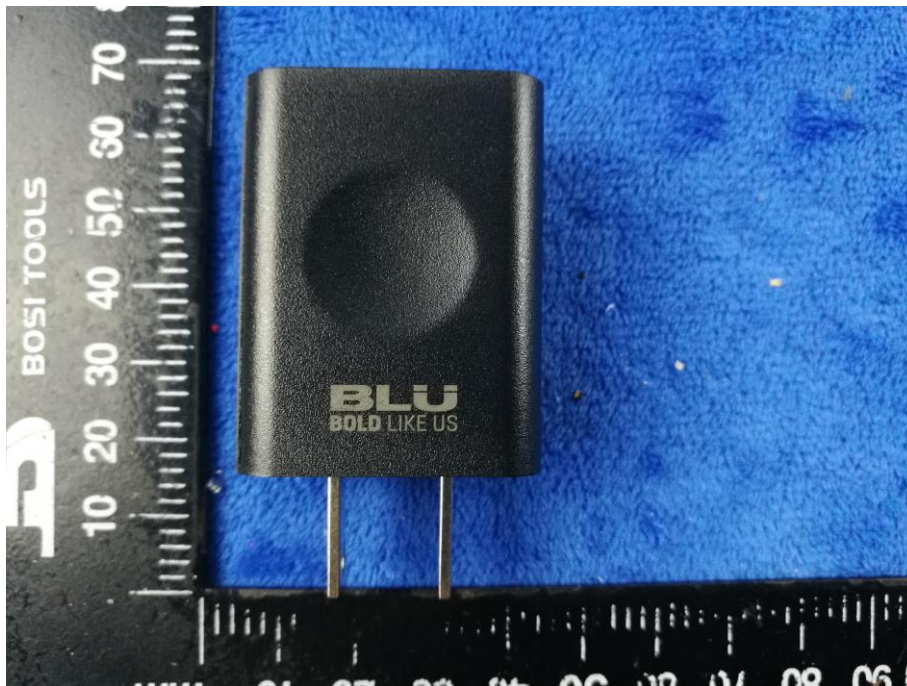

Label View

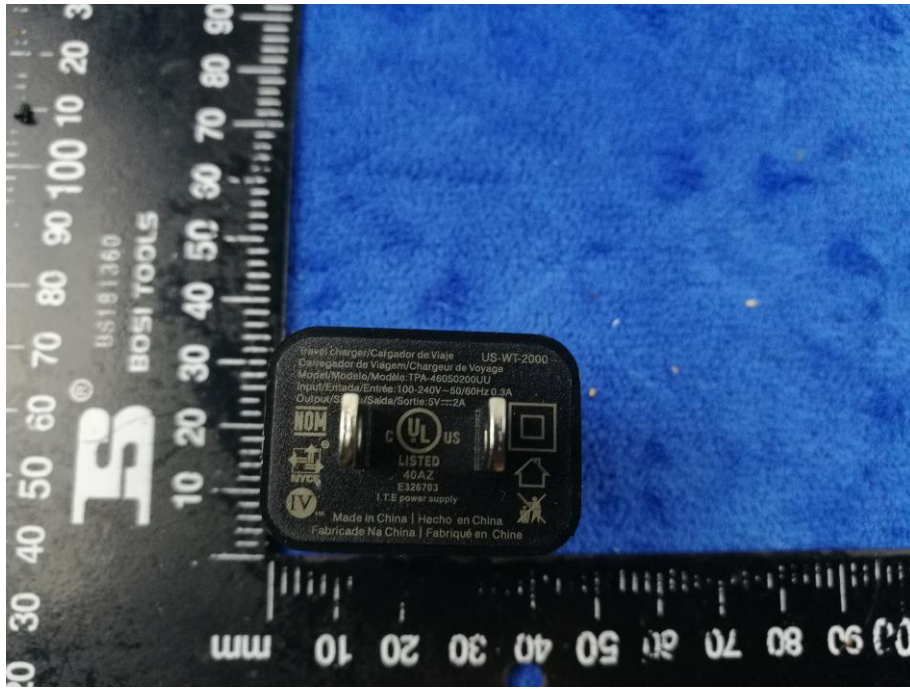

EUT - Front View

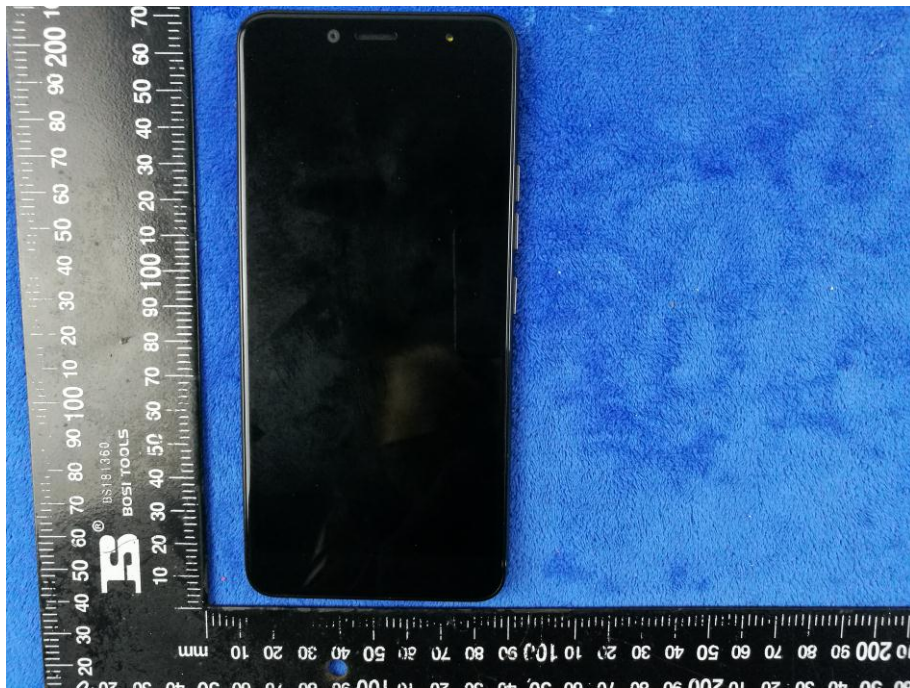



EUT - Rear View



EUT - Top View

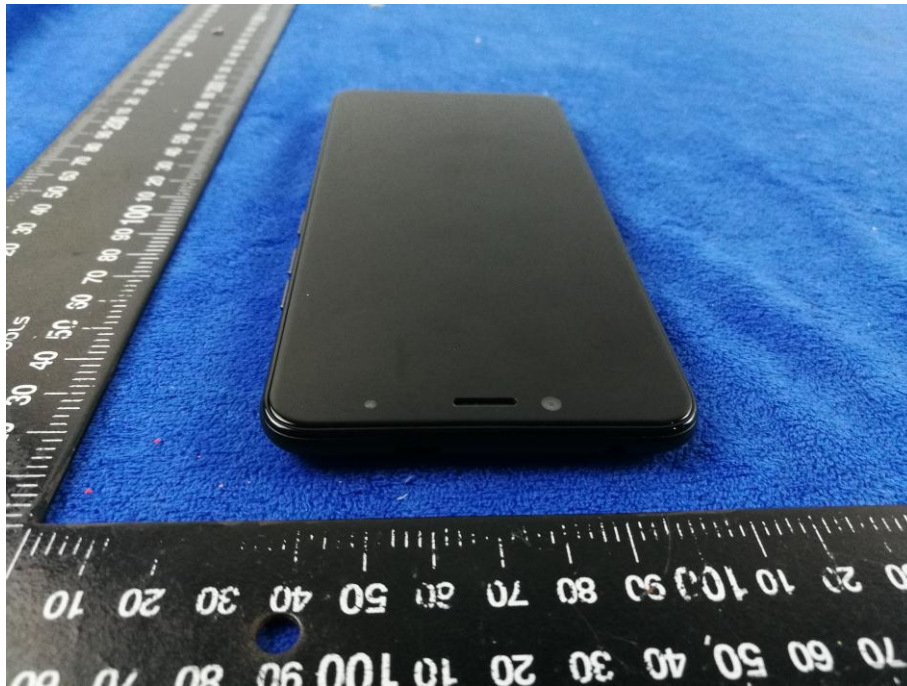

EUT - Bottom View

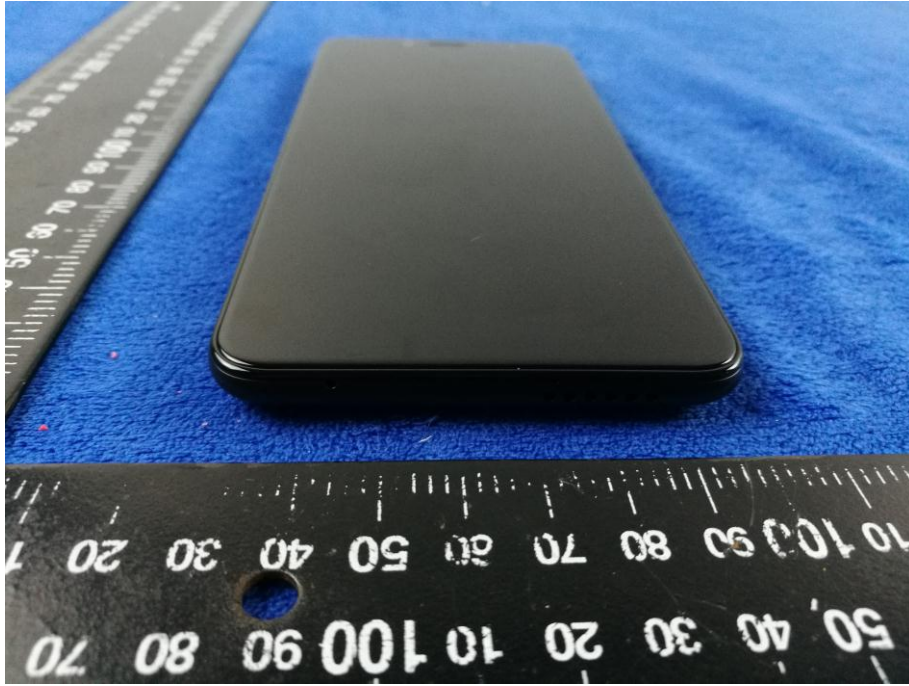

EUT - Left View

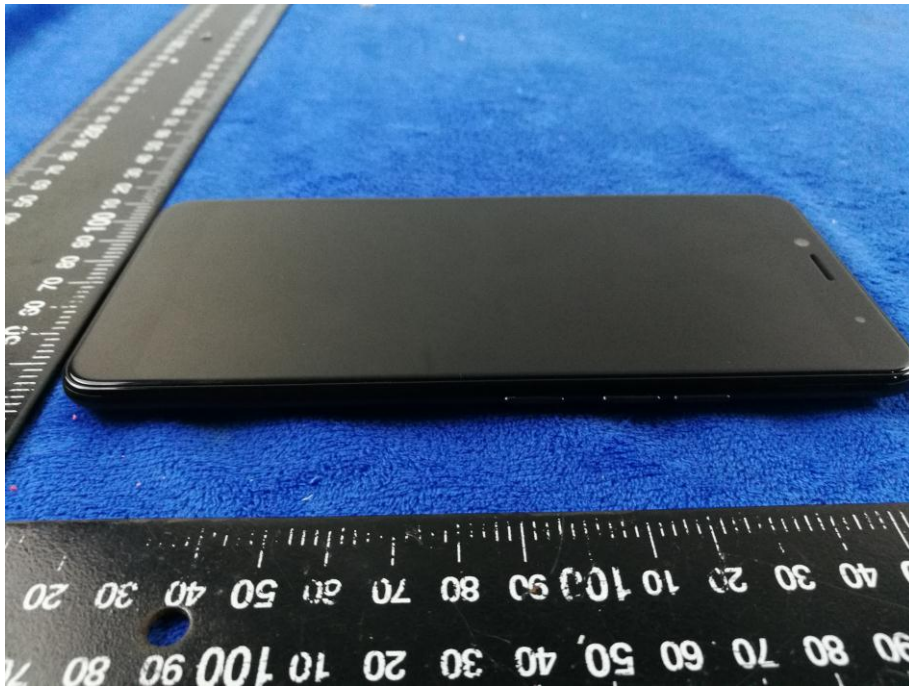

|                 |                 |
|-----------------|-----------------|
| Test Report No. | 18070046-FCC-R4 |
| Page            | 38 of 53        |

EUT - Right View

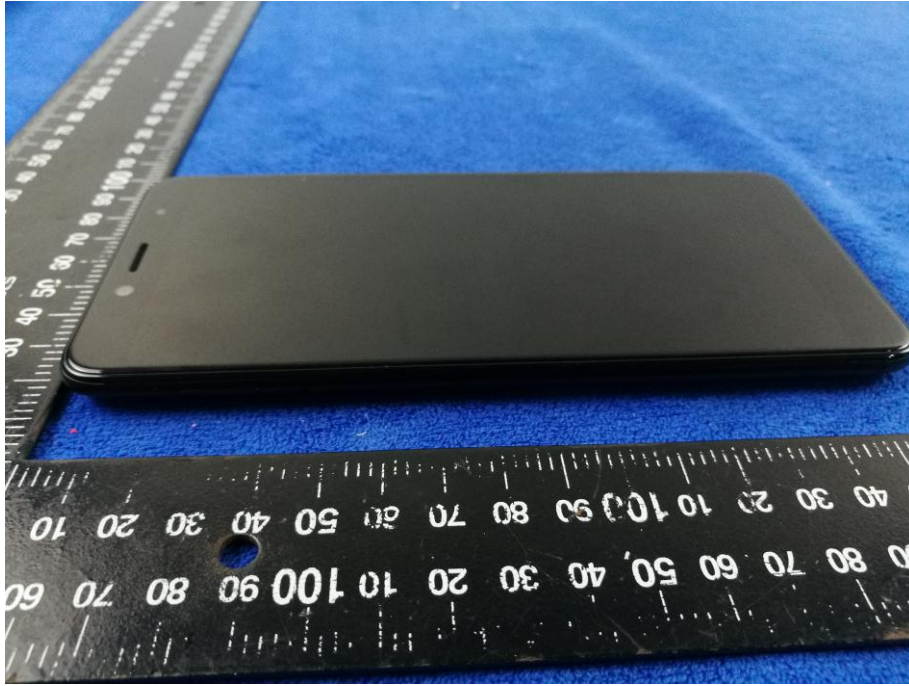



**Annex B.ii. Photograph: EUT Internal Photo**

Cover Off - Top View 1



Cover Off - Top View 2



Battery - Front View



Battery - Rear View





Mainboard with Shielding - Front View

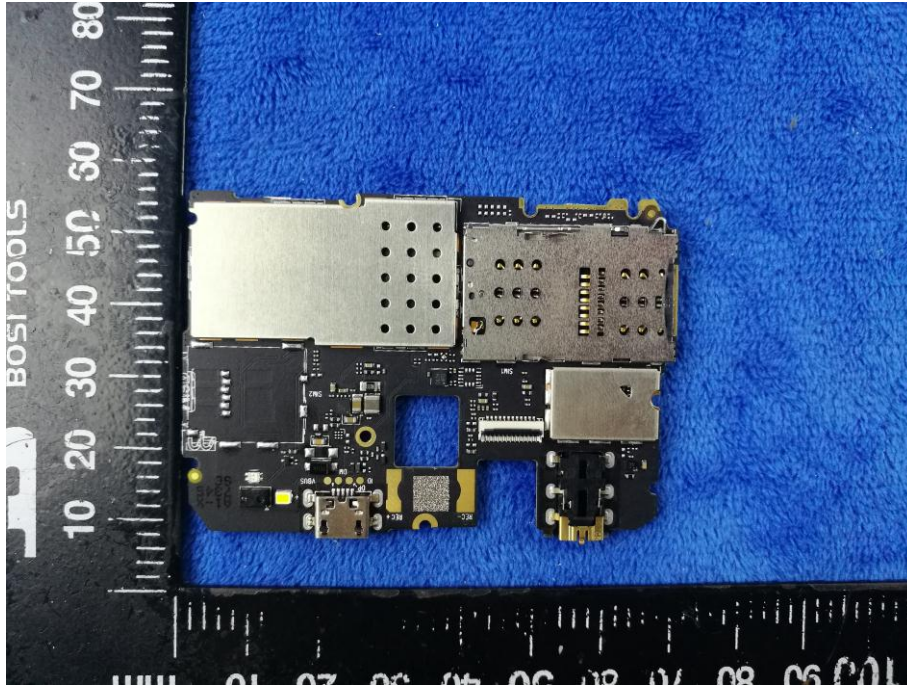

Mainboard with Shielding - Rear View



Mainboard without Shielding - Front View

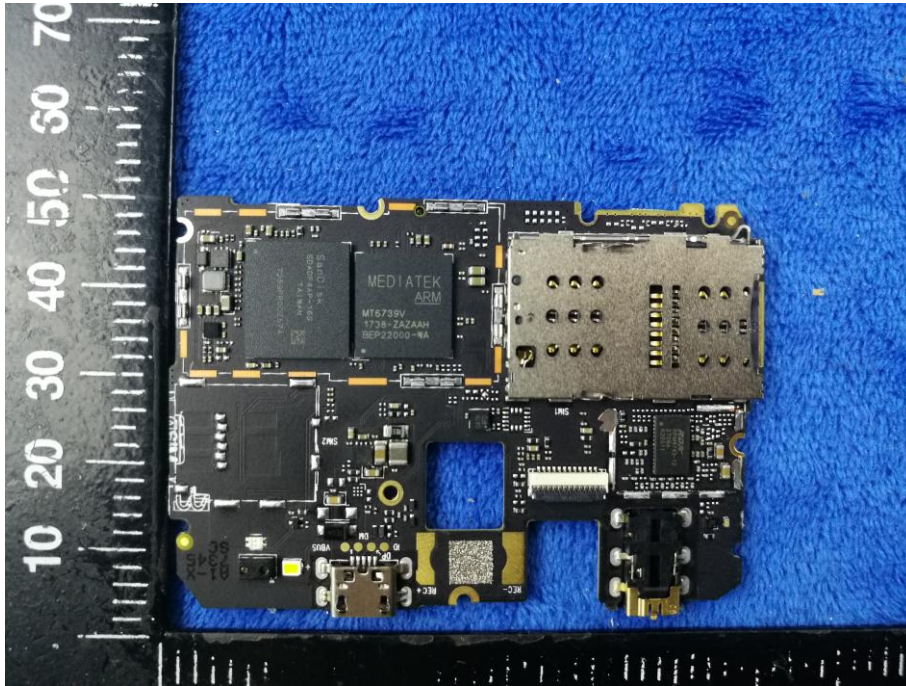

Mainboard without Shielding - Rear View

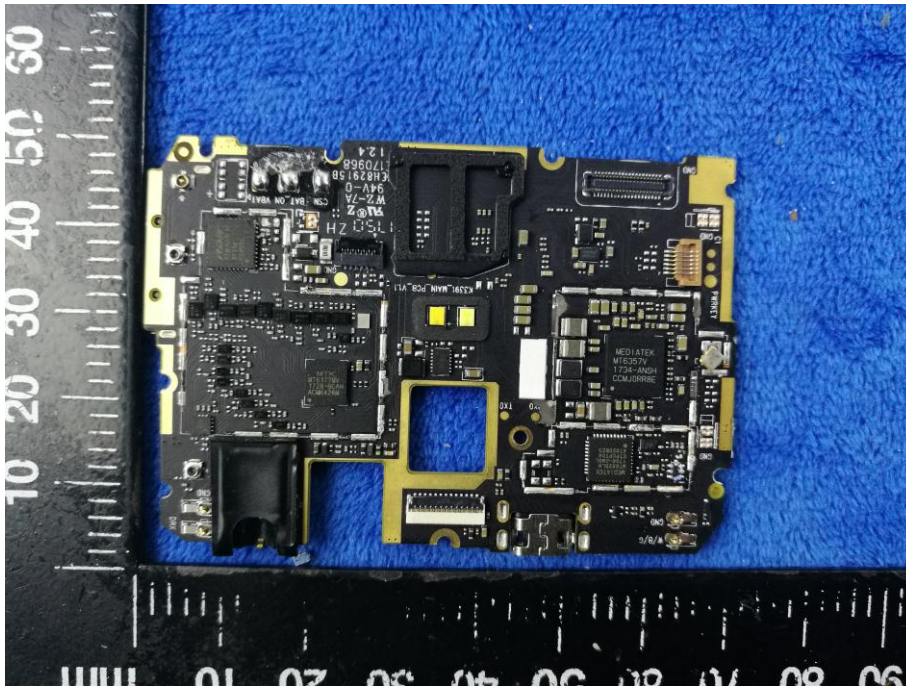



Smallboard – Front View

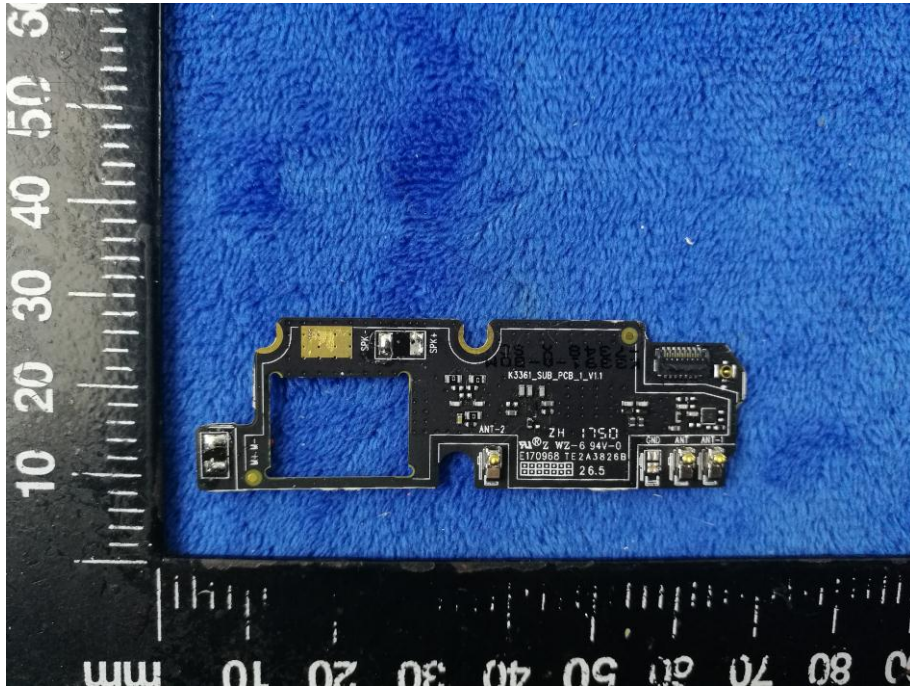

Smallboard – Rear View

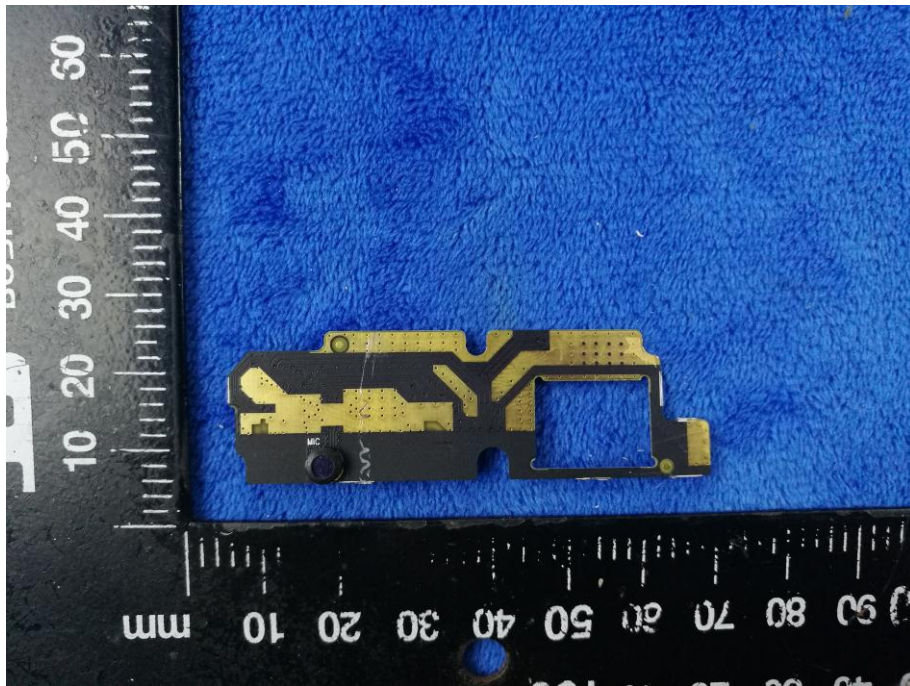

LCD – Front View

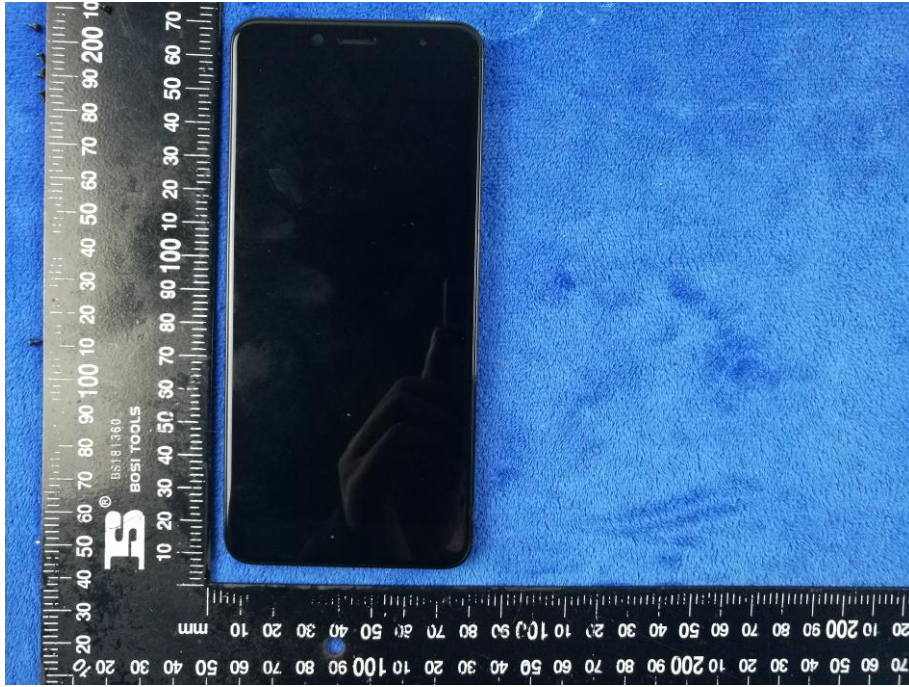

LCD – Rear View





GSM/PCS/UMTS-FDD/LTE Antenna View



WIFI/BT/BLE/GPS - Antenna View



RXD- Antenna View



**Annex B.iii. Photograph: Test Setup Photo**

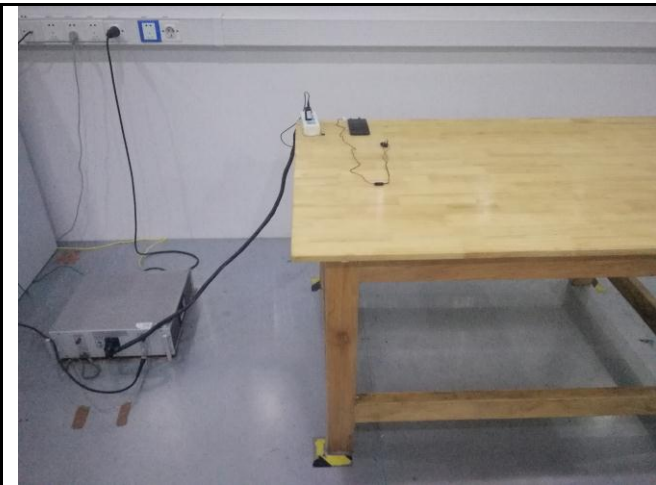

Conducted Emissions Test Setup Front View



Conducted Emissions Test Setup Side View

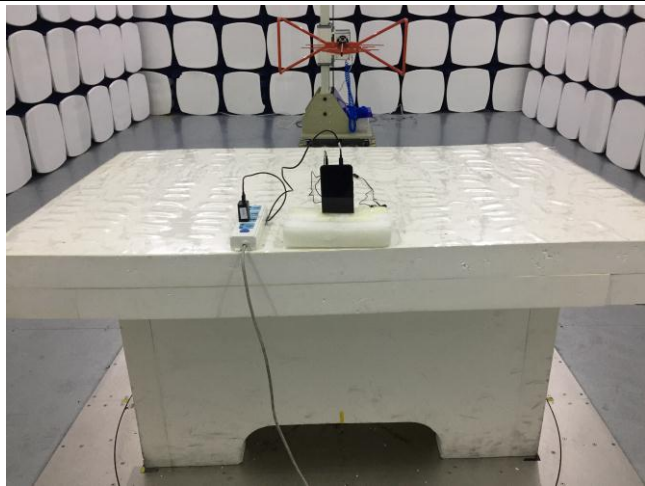

Radiated Spurious Emissions Test Setup Below 1GHz



Radiated Spurious Emissions Test Setup Above  
1GHz

## Annex C. TEST SETUP AND SUPPORTING EQUIPMENT

### Annex C.ii. TEST SET UP BLOCK

#### Block Configuration Diagram for AC Line Conducted Emissions

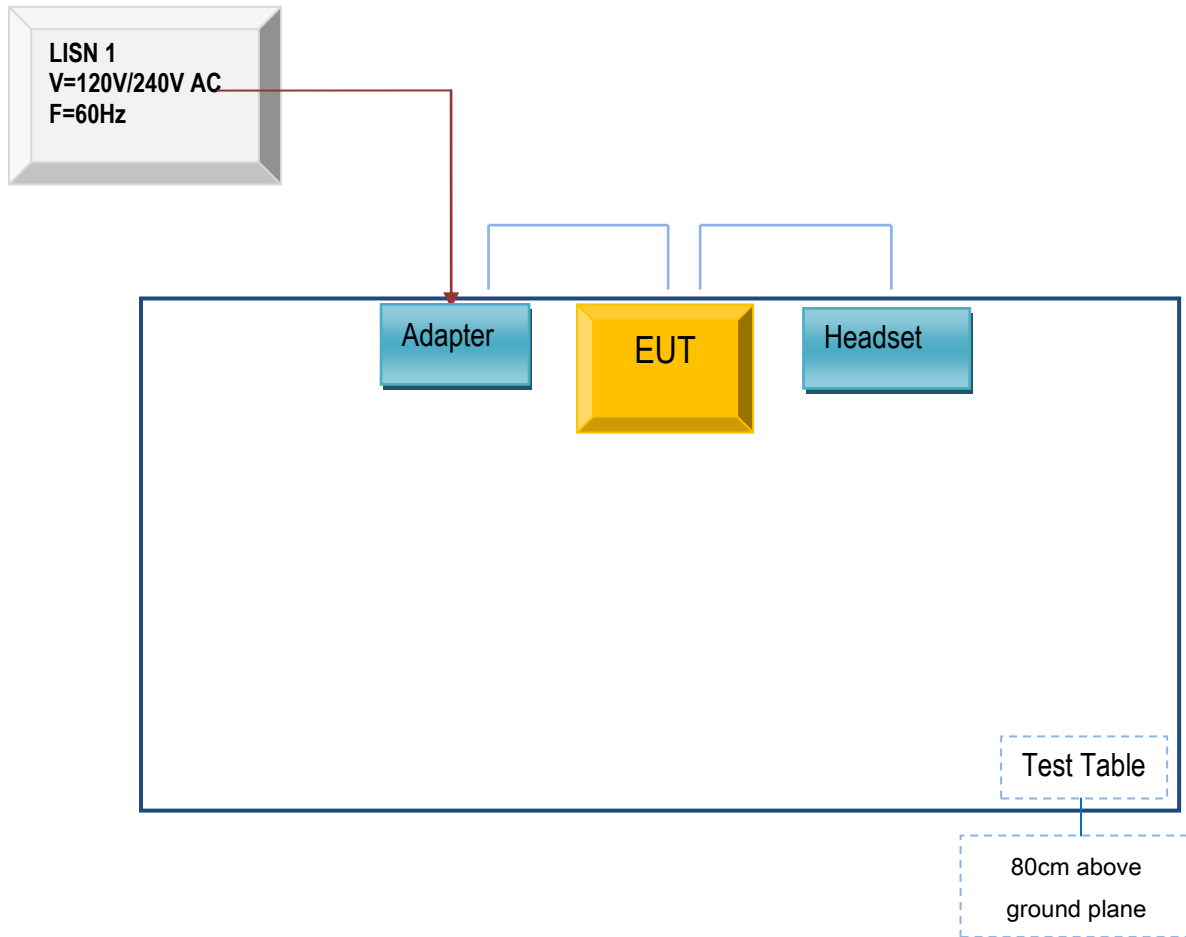



**Block Configuration Diagram for Radiated Emissions ( Below 1GHz ) .**

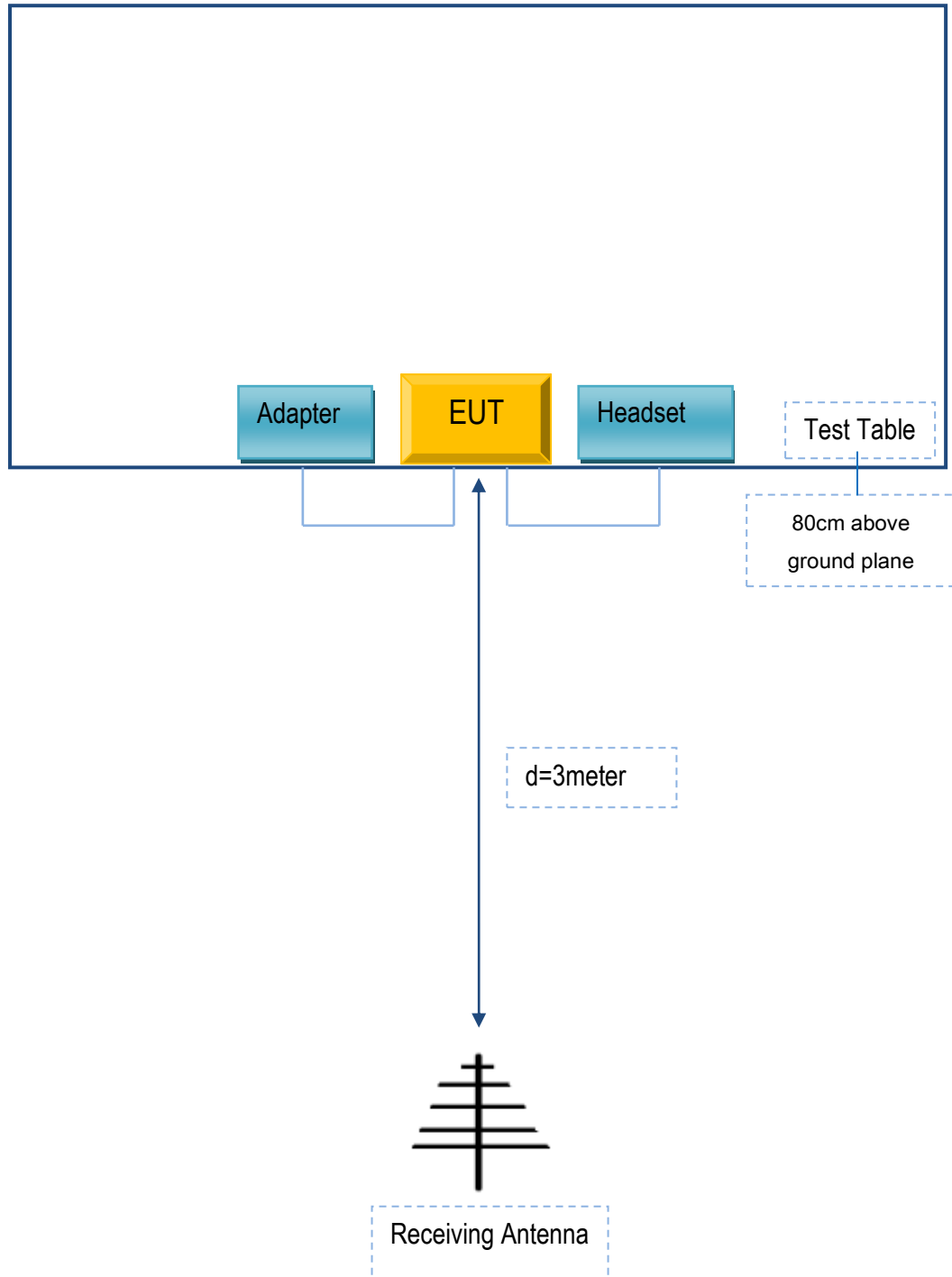

**Block Configuration Diagram for Radiated Emissions ( Above 1GHz ) .**

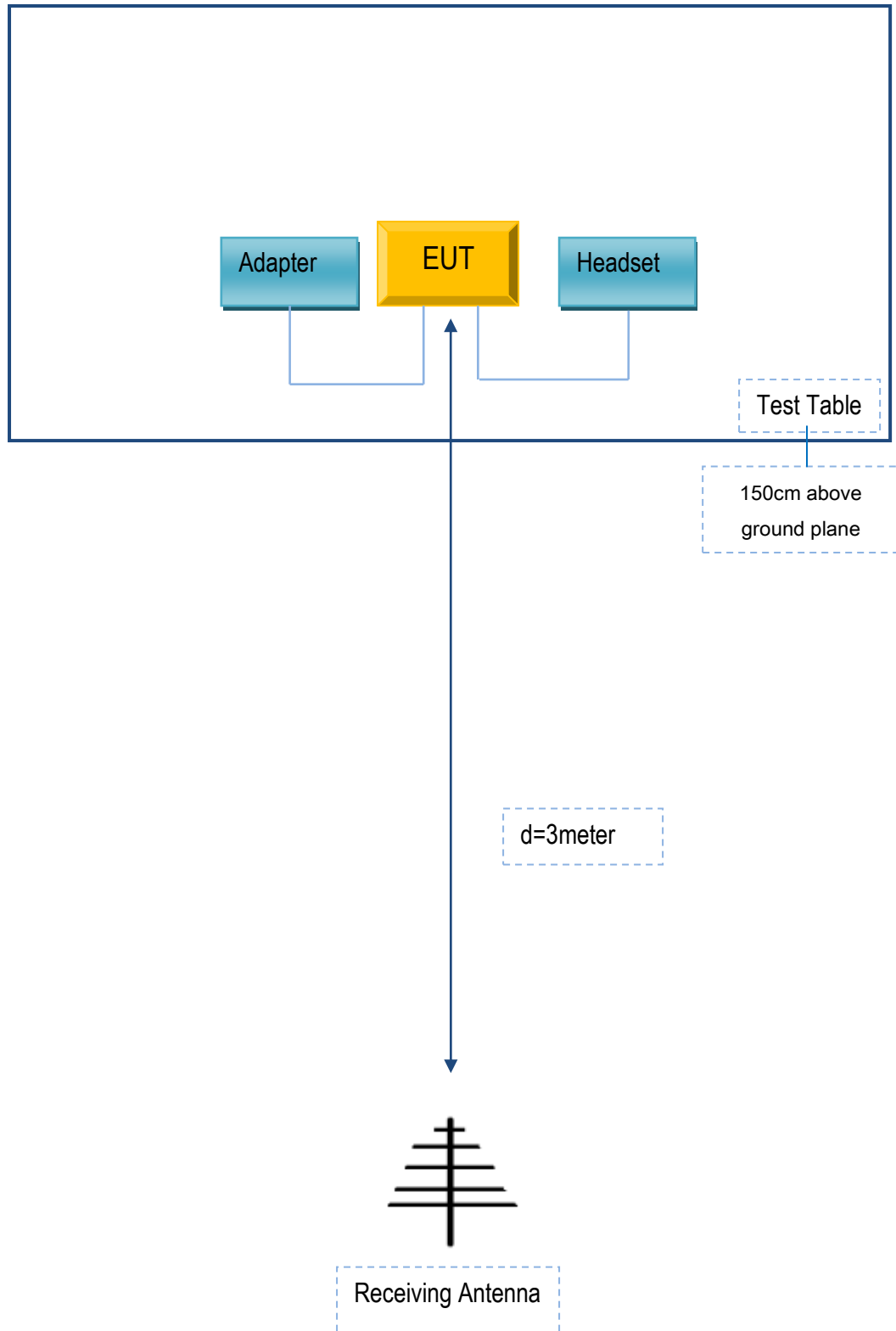

## Annex C. ii. SUPPORTING EQUIPMENT DESCRIPTION

The following is a description of supporting equipment and details of cables used with the EUT.

### Supporting Equipment:

| Manufacturer      | Equipment Description | Model          | Serial No |
|-------------------|-----------------------|----------------|-----------|
| BLU Products, Inc | Adapter               | TPA-46050200UU | N/A       |
| BLU Products, Inc | headset               | VIVO ONE PLUS  | N/A       |

### Supporting Cable:

| Cable type | Shield Type  | Ferrite Core | Length | Serial No |
|------------|--------------|--------------|--------|-----------|
| USB Cable  | Un-shielding | No           | 0.8m   | N/A       |

|                 |                 |
|-----------------|-----------------|
| Test Report No. | 18070046-FCC-R4 |
| Page            | 52 of 53        |

## Annex D. User Manual / Block Diagram / Schematics / Partlist

Please see the attachment

|                 |                 |
|-----------------|-----------------|
| Test Report No. | 18070046-FCC-R4 |
| Page            | 53 of 53        |

## Annex E. DECLARATION OF SIMILARITY

N/A