

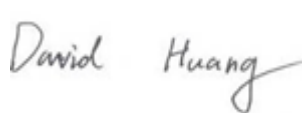

# RF TEST REPORT



Report No.: 18070046-FCC-R2

Supersede Report No.: N/A

Applicant	BLU Products, Inc	
Product Name	Mobile Phone	
Model No.	VIVO ONE PLUS	
Serial No.	N/A	
Test Standard	FCC Part 15.247: 2016, ANSI C63.10: 2013	
Test Date	January 13 to January 28, 2018	
Issue Date	January 29, 2018	
Test Result	<input checked="" type="checkbox"/> Pass <input type="checkbox"/> Fail	
Equipment complied with the specification	<input checked="" type="checkbox"/>	
Equipment did not comply with the specification	<input type="checkbox"/>	
		
Aaron Liang Test Engineer	David Huang Checked By	
This test report may be reproduced in full only Test result presented in this test report is applicable to the tested sample only		

Issued by:

**SIEMIC (SHENZHEN-CHINA) LABORATORIES**

Zone A, Floor 1, Building 2 Wan Ye Long Technology Park

South Side of Zhoushi Road, Bao' an District, Shenzhen, Guangdong China 518108

Phone: +86 0755 2601 4629801 Email: [China@siemic.com.cn](mailto:China@siemic.com.cn)

## Laboratories Introduction

SIEMIC, headquartered in the heart of Silicon Valley, with superior facilities in US and Asia, is one of the leading independent testing and certification facilities providing customers with one-stop shop services for Compliance Testing and Global Certifications.



In addition to testing and certification, SIEMIC provides initial design reviews and compliance management throughout a project. Our extensive experience with China, Asia Pacific, North America, European, and International compliance requirements, assures the fastest, most cost effective way to attain regulatory compliance for the global markets.

### Accreditations for Conformity Assessment

Country/Region	Scope
USA	EMC, RF/Wireless, SAR, Telecom
Canada	EMC, RF/Wireless, SAR, Telecom
Taiwan	EMC, RF, Telecom, SAR, Safety
Hong Kong	RF/Wireless, SAR, Telecom
Australia	EMC, RF, Telecom, SAR, Safety
Korea	EMI, EMS, RF, SAR, Telecom, Safety
Japan	EMI, RF/Wireless, SAR, Telecom
Singapore	EMC, RF, SAR, Telecom
Europe	EMC, RF, SAR, Telecom, Safety

Test Report No.	18070046-FCC-R2
Page	3 of 66

This page has been left blank intentionally.

# CONTENTS

1. REPORT REVISION HISTORY .....	5
2. CUSTOMER INFORMATION.....	5
3. TEST SITE INFORMATION .....	5
4. EQUIPMENT UNDER TEST (EUT) INFORMATION .....	6
5. TEST SUMMARY .....	9
6. MEASUREMENTS, EXAMINATION AND DERIVED RESULTS.....	10
6.1 ANTENNA REQUIREMENT .....	10
6.2 DTS (6 DB&20 DB) CHANNEL BANDWIDTH .....	11
6.3 MAXIMUM OUTPUT POWER.....	18
6.4 POWER SPECTRAL DENSITY .....	22
6.5 BAND-EDGE & UNWANTED EMISSIONS INTO RESTRICTED FREQUENCY BANDS .....	26
6.6 AC POWER LINE CONDUCTED EMISSIONS.....	32
6.7 RADIATED SPURIOUS EMISSIONS & RESTRICTED BAND.....	38
ANNEX A. TEST INSTRUMENT .....	46
ANNEX B. EUT AND TEST SETUP PHOTOGRAPHS.....	47
ANNEX C. TEST SETUP AND SUPPORTING EQUIPMENT.....	61
ANNEX D. USER MANUAL / BLOCK DIAGRAM / SCHEMATICS / PARTLIST .....	65
ANNEX E. DECLARATION OF SIMILARITY .....	66

## 1. Report Revision History

Report No.	Report Version	Description	Issue Date
18070046-FCC-R2	NONE	Original	January 29, 2018

## 2. Customer information

Applicant Name	BLU Products, Inc
Applicant Add	10814 NW 33rd St # 100 Doral, FL 33172
Manufacturer	BLU Products, Inc
Manufacturer Add	10814 NW 33rd St # 100 Doral, FL 33172

## 3. Test site information

### Test Lab A:

Lab performing tests	SIEMIC (Shenzhen-China) LABORATORIES
Lab Address	Zone A, Floor 1, Building 2 Wan Ye Long Technology Park South Side of Zhoushi Road, Bao' an District, Shenzhen, Guangdong China 518108
FCC Test Site No.	535293
IC Test Site No.	4842E-1
Test Software	Radiated Emission Program-To Shenzhen v2.0

### Test Lab B:

Lab performing tests	SIEMIC (Nanjing-China) Laboratories
Lab Address	2-1 Longcang Avenue Yuhua Economic and Technology Development Park, Nanjing, China
FCC Test Site No.	694825
IC Test Site No.	4842B-1
Test Software	EZ_EMG(ver.lcp-03A1)

Note: We just perform Radiated Spurious Emission above 18GHz in the test Lab. B.

## 4. Equipment under Test (EUT) Information

Description of EUT:	Mobile Phone
Main Model:	VIVO ONE PLUS
Serial Model:	N/A
Date EUT received:	January 12, 2018
Test Date(s):	January 13 to January 28, 2018
Equipment Category :	DTS
Antenna Gain:	GSM850: -2.8dBi PCS1900: -2.3dBi UMTS-FDD Band V: -2.5dBi UMTS-FDD Band IV: -2.5dBi UMTS-FDD Band II: -2.5dBi LTE Band II: -2.5dBi LTE Band IV: -2.5dBi LTE Band VII: -3.0dBi LTE Band XII: -2.8dBi LTE Band XVII: -2.8dBi Bluetooth/BLE: -2.7dBi WIFI: -2.7dBi GPS: -2.5dBi
Antenna Type:	PIFA Antenna
Type of Modulation:	GSM / GPRS: GMSK EGPRS: GMSK UMTS-FDD: QPSK LTE Band: QPSK, 16QAM 802.11b/g/n: DSSS, OFDM Bluetooth: GFSK, $\pi$ /4DQPSK, 8DPSK BLE: GFSK GPS: BPSK

	GSM850 TX: 824.2 ~ 848.8 MHz; RX: 869.2 ~ 893.8 MHz
	PCS1900 TX: 1850.2 ~ 1909.8 MHz; RX: 1930.2 ~ 1989.8 MHz
	UMTS-FDD Band V TX: 826.4 ~ 846.6 MHz; RX: 871.4 ~ 891.6 MHz
	UMTS-FDD Band IV TX:1712.4 ~ 1752.6 MHz; RX : 2112.4 ~ 2152.6 MHz
	UMTS-FDD Band II TX:1852.4 ~ 1907.6 MHz; RX: 1932.4 ~ 1987.6 MHz
RF Operating Frequency (ies):	LTE Band II TX: 1850.7 ~ 1909.3MHz; RX : 1930.7 ~ 1989.3 MHz
	LTE Band IV TX: 1710.7 ~ 1754.3 MHz; RX : 2110.7~ 2154.3 MHz
	LTE Band VII TX: 2502.5 ~ 2567.5 MHz; RX : 2622.5 ~ 2687.5 MHz
	LTE Band XII TX:699.7 ~ 715.3 MHz; RX : 729.7~ 745.3MHz
	LTE Band XVII TX: 706.5 ~ 713.5 MHz; RX : 736.5 ~ 743.5 MHz
	WIFI: 802.11b/g/n(20M): 2412-2462 MHz
	WIFI: 802.11n(40M): 2422-2452 MHz
	Bluetooth& BLE: 2402-2480 MHz
	GPS: 1575.42 MHz
	802.11b: 15.27dBm
	802.11g: 13.43dBm
Max. Output Power:	802.11n(20M): 13.50dBm
	802.11n(40M): 15.18dBm
	GSM 850: 124CH
	PCS1900: 299CH
	UMTS-FDD Band V: 102CH
	UMTS-FDD Band IV: 202CH
Number of Channels:	UMTS-FDD Band II: 277CH
	WIFI :802.11b/g/n(20M): 11CH
	WIFI :802.11n(40M): 7CH
	Bluetooth: 79CH
	BLE: 40CH
	GPS:1CH
Port:	USB Port, Earphone Port
	Adapter :
	Model: TPA-46050200UU
Input Power:	Input: AC100-240V~50/60Hz,0.3A
	Output: DC 5V, 2A
	Battery:

Test Report No.	18070046-FCC-R2
Page	8 of 66

Model: C916241400P  
Spec: 3.85V, 4000mAh, 15.4Wh  
Voltage: 4.4V

Brand Name : BLU

Trade Name :



GPRS/EGPRS Multi-slot class 8/10/11/12

FCC ID: YHLBLUVOONEPLUS



## 5. Test Summary

The product was tested in accordance with the following specifications.

All testing has been performed according to below product classification:

FCC Rules	Description of Test	Result
§15.203	Antenna Requirement	Compliance
§15.247 (a)(2)	DTS (6 dB&20 dB) CHANNEL BANDWIDTH	Compliance
§15.247(b)(3)	Conducted Maximum Output Power	Compliance
§15.247(e)	Power Spectral Density	Compliance
§15.247(d)	Band-Edge & Unwanted Emissions into Restricted Frequency Bands	Compliance
§15.207 (a),	AC Power Line Conducted Emissions	Compliance
§15.205, §15.209, §15.247(d)	Radiated Emissions & Unwanted Emissions into Restricted Frequency Bands	Compliance

### Measurement Uncertainty

Emissions		
Test Item	Description	Uncertainty
Band-Edge & Unwanted Emissions into Restricted Frequency Bands and Radiated Emissions & Unwanted Emissions into Restricted Frequency Bands	Confidence level of approximately 95% (in the case where distributions are normal), with a coverage factor of 2 (for EUTs < 0.5m X 0.5m X 0.5m)	+5.6dB/-4.5dB
-	-	-

## 6. Measurements, Examination And Derived Results

### 6.1 Antenna Requirement

#### Applicable Standard

According to § 15.203, an intentional radiator shall be designed to ensure that no antenna other than that furnished by the responsible party shall be used with the device. The use of a permanently attached antenna or of an antenna that uses a unique coupling to the intentional radiator shall be considered sufficient to comply with the provisions of this section. The manufacturer may design the unit so that a broken antenna can be replaced by the user, but the user of a standard antenna jack or electrical connector is prohibited. The structure and application of the EUT were analyzed to determine compliance with section §15.203 of the rules. §15.203 state that the subject device must meet the following criteria:

- a. Antenna must be permanently attached to the unit.
- b. Antenna must use a unique type of connector to attach to the EUT.

Unit must be professionally installed, and installer shall be responsible for verifying that the correct antenna is employed with the unit.

And according to FCC 47 CFR section 15.247 (b), if the transmitting antennas of directional gain greater than 6dBi are used, the power shall be reduced by the amount in dB that the directional gain of the antenna exceeds 6 dBi.

#### Antenna Connector Construction

The EUT has 2 antennas:

A permanently attached PIFA antenna for Bluetooth/BLE/WIF/GPS, the gain is -2.7dBi for Bluetooth/BLE/WIFI, the gain is -2.5dBi for GPS.

A permanently attached PIFA antenna for GSM/PCS/UMTS/ LTE Band II/IV/VII/XII/XVII, the gain is -2.8dBi for GSM850, -2.3dBi for PCS1900, -2.5dBi for UMTS-FDD Band II/V/ IV, the gain is -2.5dBi LTE Band II/IV, -3.0dBi for LTE Band VII, -2.8dBi for XII/ XVII.

**The antenna meets up with the ANTENNA REQUIREMENT.**

**Result:** Compliance.

## 6.2 DTS (6 dB&20 dB) Channel Bandwidth

Temperature	25 °C
Relative Humidity	57%
Atmospheric Pressure	1016mbar
Test date :	January 17, 2018
Tested By :	Aaron Liang

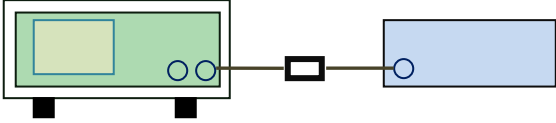
Spec	Item	Requirement	Applicable
§ 15.247(a)(2)	a)	6dB BW ≥ 500kHz;	<input checked="" type="checkbox"/>
RSS Gen(4.6.1)	b)	99% BW: For FCC reference only; required by IC.	<input checked="" type="checkbox"/>
Test Setup	 <p style="text-align: center;">Spectrum Analyzer                      EUT</p>		
Test Procedure	<p>558074 D01 DTS MEAS Guidance v03r03, 8.1 DTS bandwidth</p> <p><u>6dB bandwidth</u></p> <ol style="list-style-type: none"> <li>Set RBW = 100 kHz.</li> <li>Set the video bandwidth (VBW) ≥ 3 × RBW.</li> <li>Detector = Peak.</li> <li>Trace mode = max hold.</li> <li>Sweep = auto couple.</li> <li>Allow the trace to stabilize.</li> <li>Measure the maximum width of the emission that is constrained by the frequencies associated with the two outermost amplitude points (upper and lower frequencies) that are attenuated by 6 dB relative to the maximum level measured in the fundamental emission.</li> </ol> <p><u>20dB bandwidth</u></p> <p>C63.10 Occupied Bandwidth (OBW=20dB bandwidth)</p> <ol style="list-style-type: none"> <li>Set RBW = 1%-5% OBW.</li> <li>Set the video bandwidth (VBW) ≥ 3 x RBW.</li> <li>Set the span range between 2 times and 5 times of the OBW.</li> <li>Sweep time=Auto, Detector=PK, Trace=Max hold.</li> <li>Once the reference level is established, the equipment is conditioned with typical modulating signals to produce the worst-</li> </ol>		

	case (i.e., the widest) bandwidth. Unless otherwise specified for an unlicensed wireless device, measure the bandwidth at the 20 dB levels with respect to the reference level.
Remark	
Result	<input checked="" type="checkbox"/> Pass <input type="checkbox"/> Fail

Test Data  Yes  N/A

Test Plot  Yes (See below)  N/A

### Measurement result

Test mode	CH	Freq (MHz)	6dB Bandwidth (MHz)	Limit (MHz)
802.11b	Low	2412	9.137	≥ 0.5
	Mid	2437	9.573	≥ 0.5
	High	2462	8.628	≥ 0.5
802.11g	Low	2412	15.209	≥ 0.5
	Mid	2437	15.522	≥ 0.5
	High	2462	15.182	≥ 0.5
802.11n (20M)	Low	2412	16.461	≥ 0.5
	Mid	2437	15.785	≥ 0.5
	High	2462	15.987	≥ 0.5
802.11n (40M)	Low	2422	35.307	≥ 0.5
	Mid	2437	35.261	≥ 0.5
	High	2452	35.346	≥ 0.5

Test mode	CH	Freq (MHz)	20dB Bandwidth (MHz)
802.11b	Low	2412	14.414
	Mid	2437	14.408
	High	2462	14.422
802.11g	Low	2412	18.544
	Mid	2437	18.811
	High	2462	18.918
802.11n (20M)	Low	2412	19.141
	Mid	2437	19.121
	High	2462	19.153
802.11n (40M)	Low	2422	41.864
	Mid	2437	41.798
	High	2452	43.455

### Test Plots

#### 6dB Bandwidth measurement result

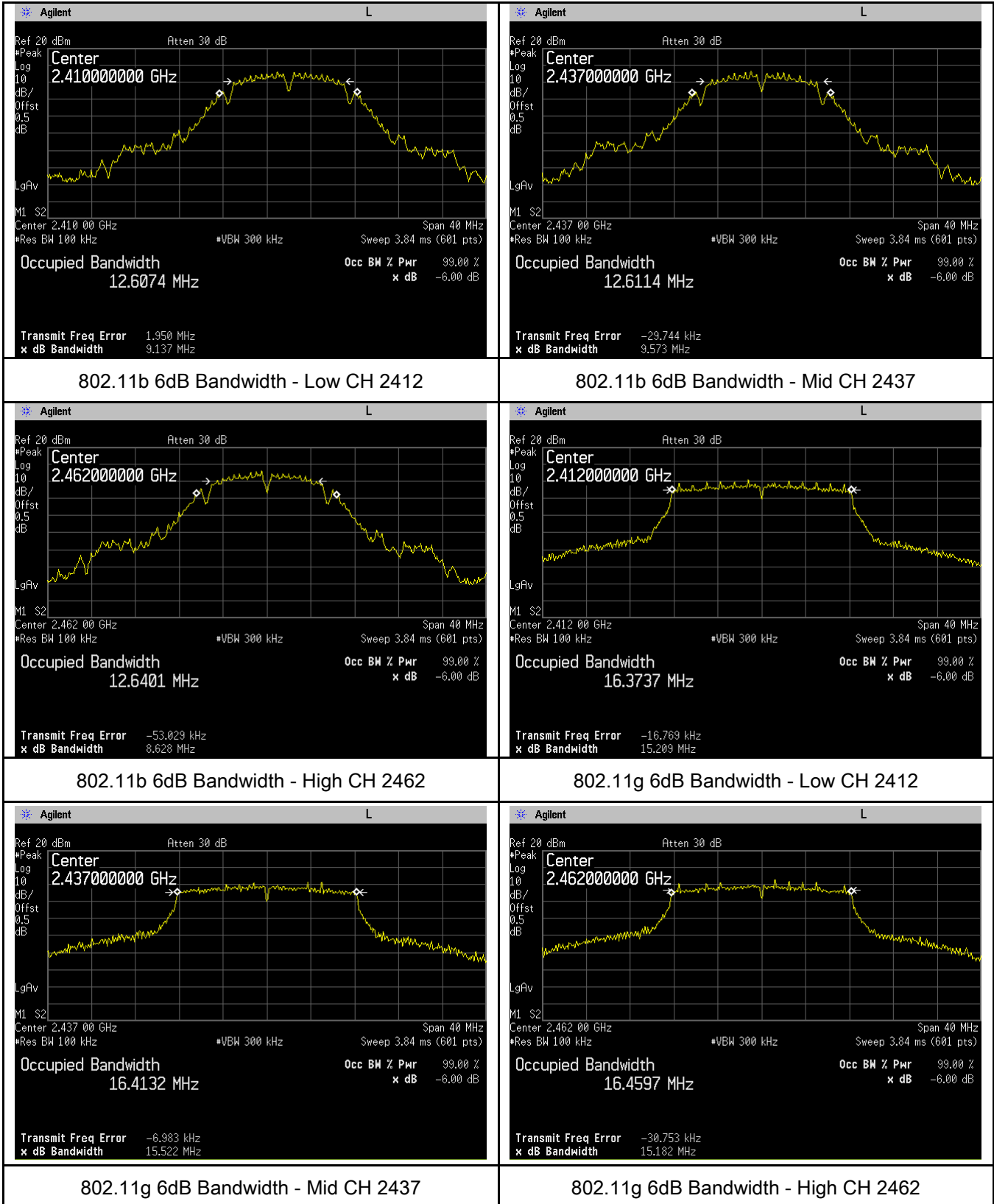

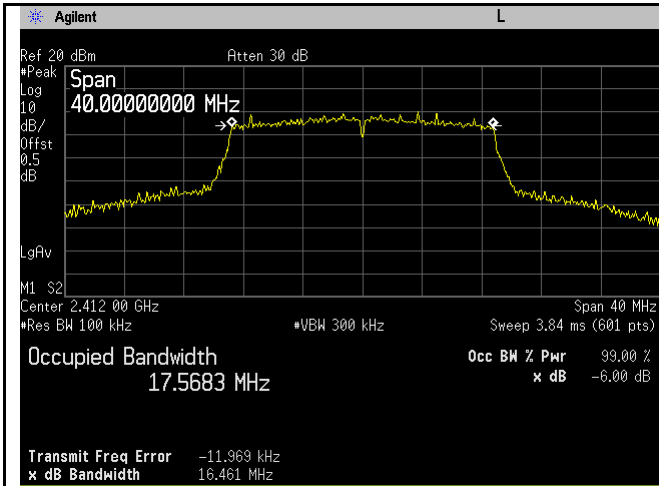

802.11n20 6dB Bandwidth - Low CH 2412

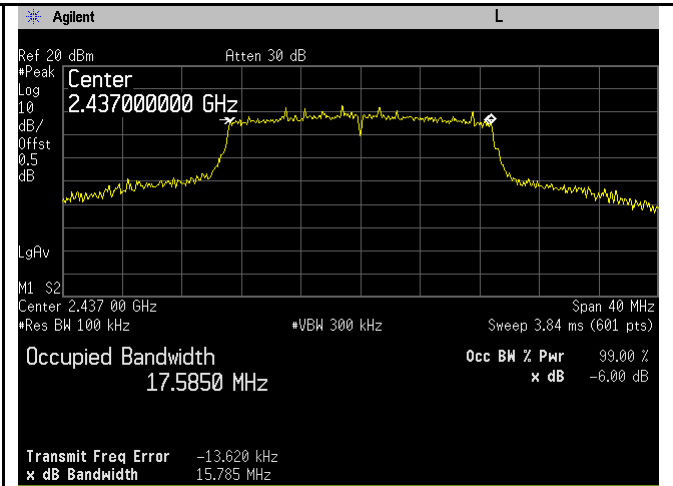

802.11n20 6dB Bandwidth - Mid CH 2437

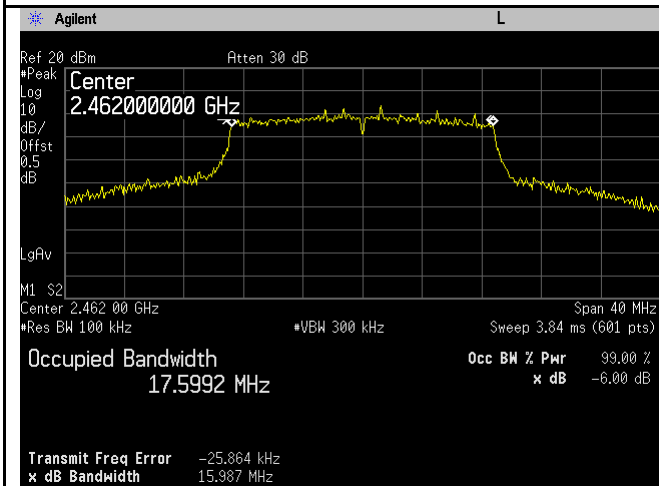

802.11n20 6dB Bandwidth - High CH 2462

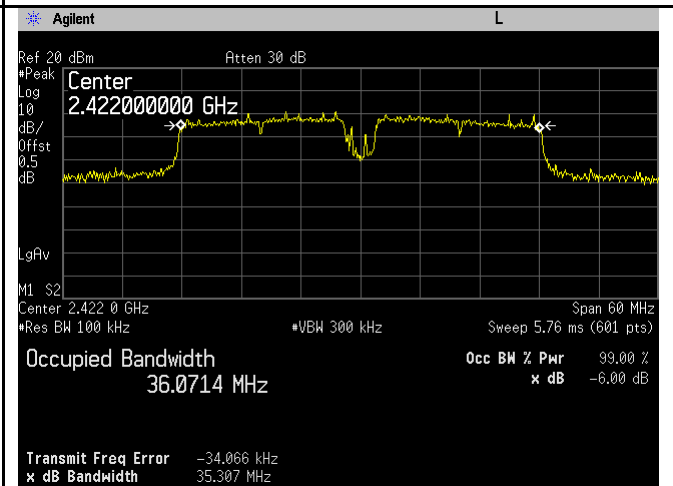

802.11n40 6dB Bandwidth - Low CH 2422

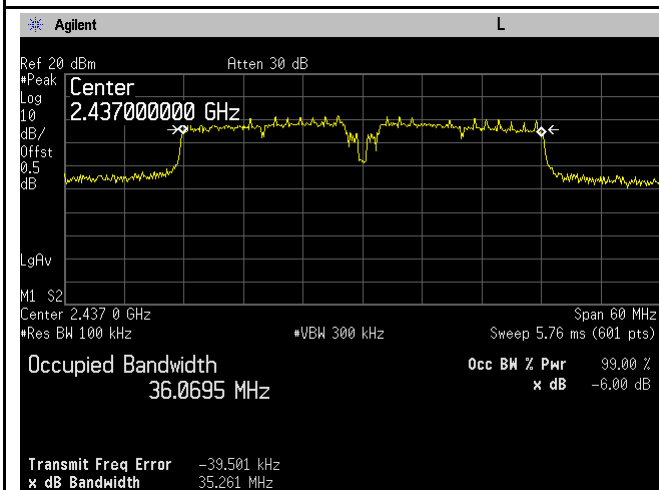

802.11n40 6dB Bandwidth - Mid CH 2437

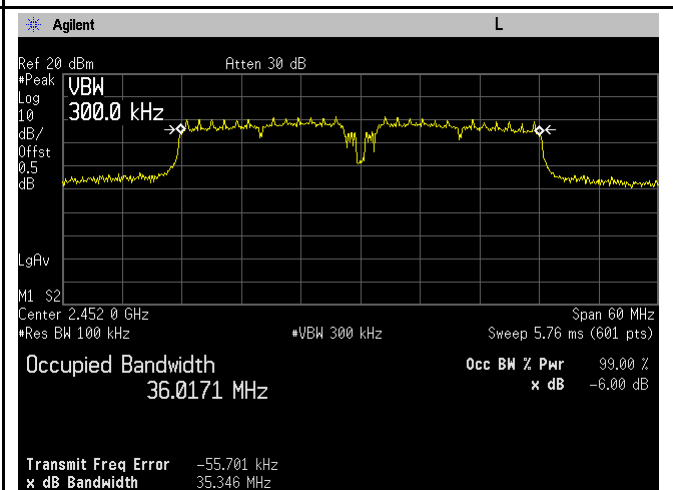

802.11n40 6dB Bandwidth - High CH 2452

### 20 dB Bandwidth measurement result

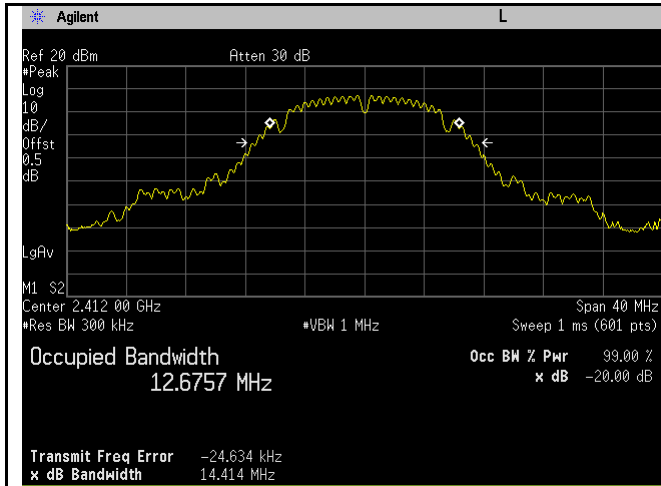

802.11b 20dB Bandwidth - Low CH 2412

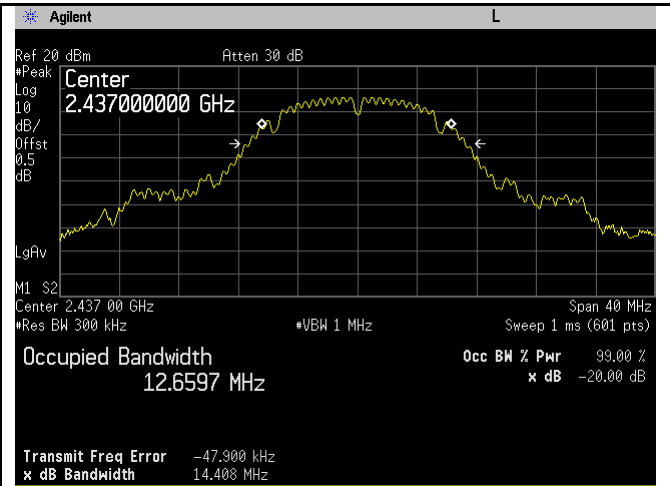

802.11b 20dB Bandwidth - Mid CH 2437

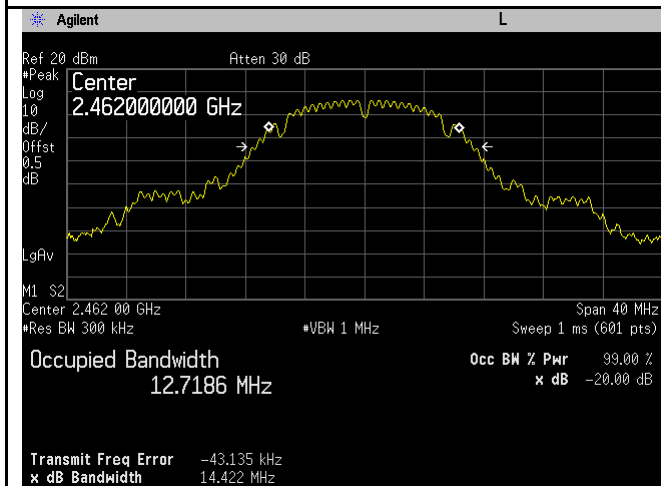

802.11b 20dB Bandwidth - High CH 2462

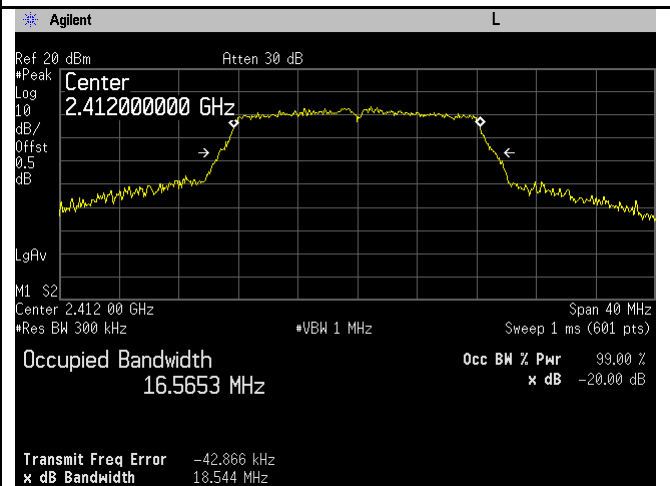

802.11g 20dB Bandwidth - Low CH 2412

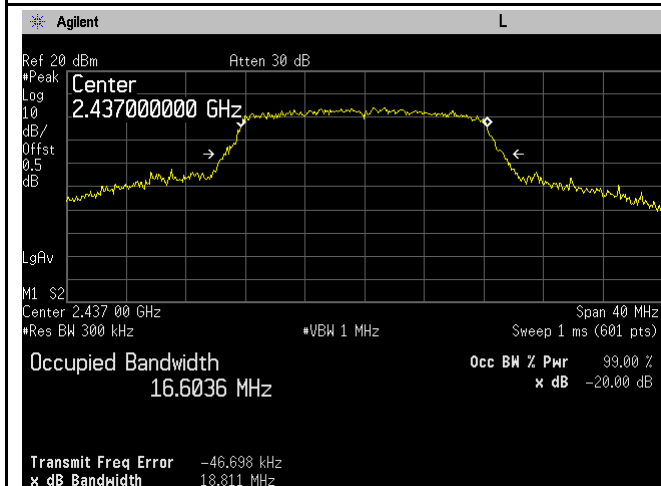

802.11g 20dB Bandwidth - Mid CH 2437

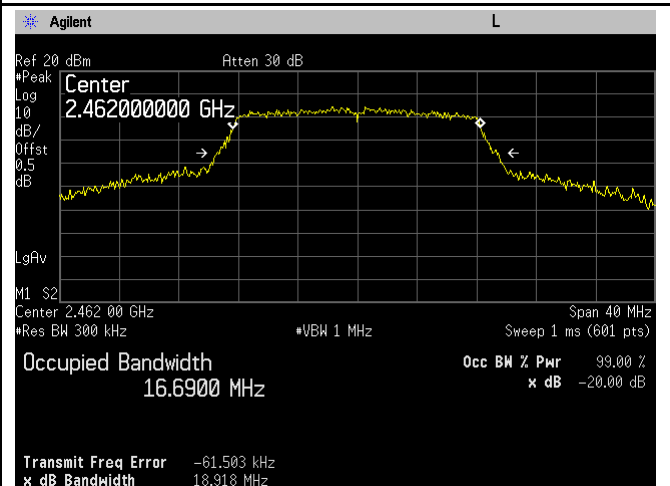

802.11g 20dB Bandwidth - High CH 2462



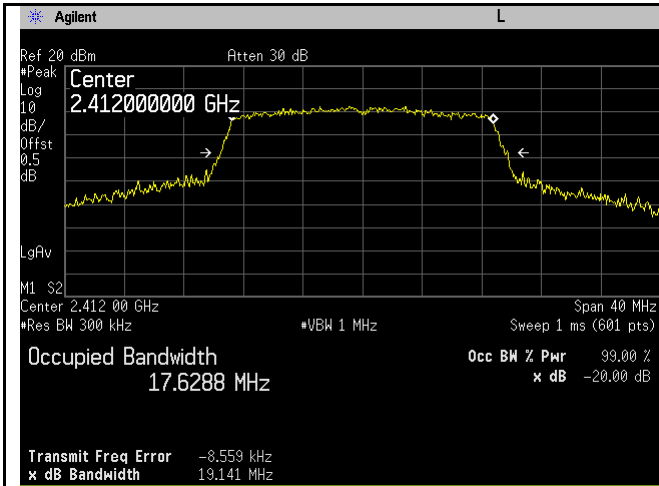

802.11n20 20dB Bandwidth - Low CH 2412

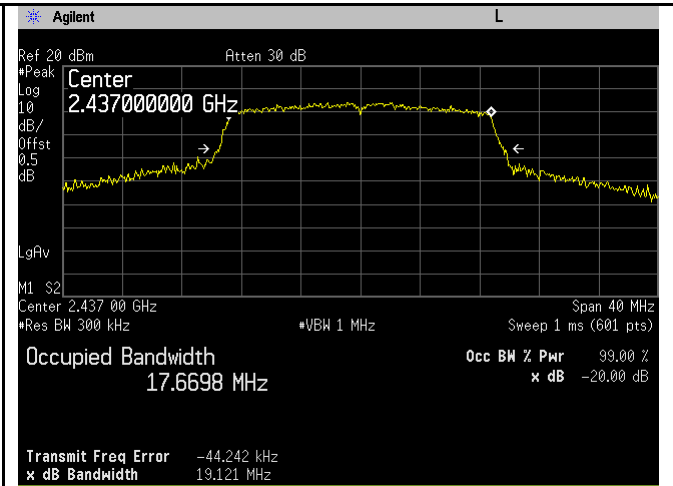

802.11n20 20dB Bandwidth - Mid CH 2437

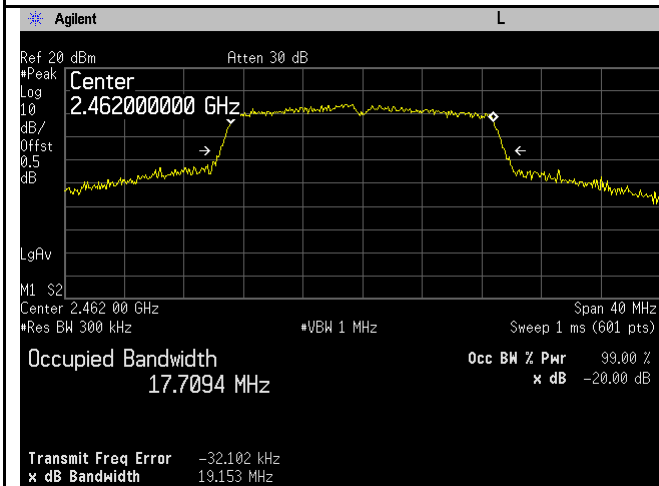

802.11n20 20dB Bandwidth - High CH 2462

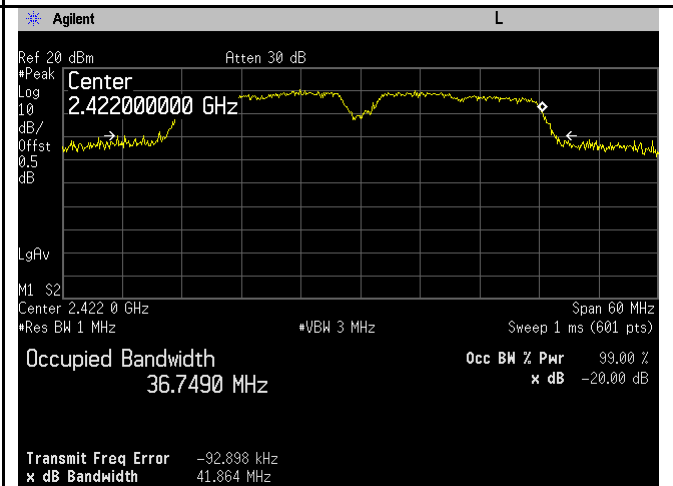

802.11n40 20dB Bandwidth - Low CH 2422

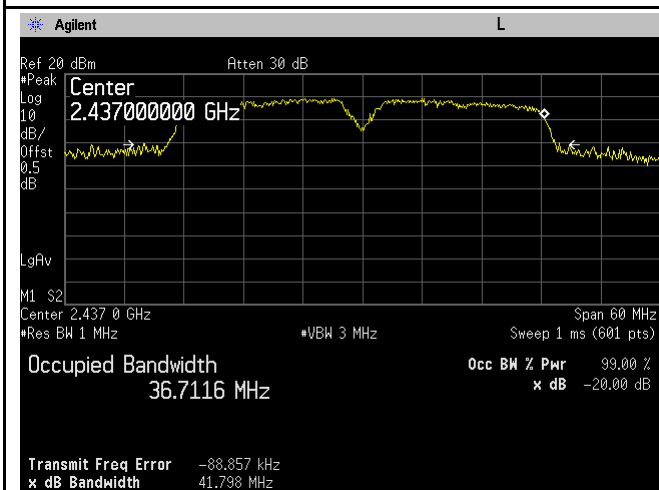

802.11n40 20dB Bandwidth - Mid CH 2437

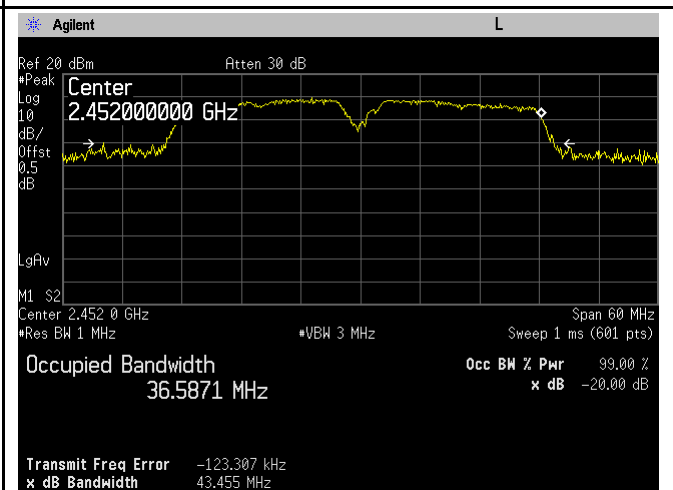

802.11n40 20dB Bandwidth - High CH 2452

### 6.3 Maximum Output Power

Temperature	26 °C
Relative Humidity	57%
Atmospheric Pressure	1018mbar
Test date :	January 21, 2018
Tested By :	Aaron Liang

#### Requirement(s):

Spec	Item	Requirement	Applicable
§15.247(b) (3),RSS210 (A8.4)	a)	FHSS in 2400-2483.5MHz with $\geq 75$ channels: $\leq 1$ Watt	<input type="checkbox"/>
	b)	FHSS in 5725-5850MHz: $\leq 1$ Watt	<input type="checkbox"/>
	c)	For all other FHSS in the 2400-2483.5MHz band: $\leq 0.125$ Watt.	<input type="checkbox"/>
	d)	FHSS in 902-928MHz with $\geq 50$ channels: $\leq 1$ Watt	<input type="checkbox"/>
	e)	FHSS in 902-928MHz with $\geq 25$ & $<50$ channels: $\leq 0.25$ Watt	<input type="checkbox"/>
	f)	DTS in 902-928MHz, 2400-2483.5MHz: $\leq 1$ Watt	<input checked="" type="checkbox"/>

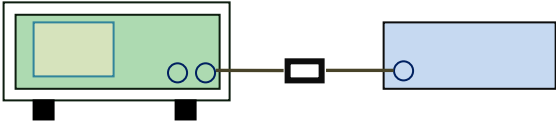
Test Setup	 <p style="text-align: center;">Spectrum Analyzer                      EUT</p>
------------	--

Test Procedure	<p>558074 D01 DTS MEAS Guidance v03r03, 9.1.2 Integrated band power method Maximum output power measurement procedure</p> <ul style="list-style-type: none"> <li>- a) Set span to at least 1.5 times the OBW.</li> <li>- b) Set RBW = 1-5% of the OBW, not to exceed 1 MHz.</li> <li>- c) Set VBW <math>\geq 3 \times</math> RBW.</li> <li>- d) Number of points in sweep <math>\geq 2 \times</math> span / RBW. (This gives bin-to-bin spacing <math>\leq</math> RBW/2, so that narrowband signals are not lost between frequency bins.)</li> <li>- e) Sweep time = auto.</li> <li>- f) Detector = RMS (i.e., power averaging), if available. Otherwise, use sample detector mode.</li> <li>- g) If transmit duty cycle <math>&lt; 98\%</math>, use a sweep trigger with the level set to enable triggering only on full power pulses. The transmitter shall operate at maximum</li> </ul>
----------------	---

	<p>power control level for the entire duration of every sweep. If the EUT transmits continuously (i.e., with no off intervals) or at duty cycle <math>\geq 98\%</math>, and if each transmission is entirely at the maximum power control level, then the trigger shall be set to “ free run” .</p> <ul style="list-style-type: none"> <li>- h) Trace average at least 100 traces in power averaging (i.e., RMS) mode.</li> <li>- i) Compute power by integrating the spectrum across the OBW of the signal using the instrument’ s band power measurement function, with band limits set equal to the OBW band edges. If the instrument does not have a band power function, sum the spectrum levels (in power units) at intervals equal to the RBW extending across the entire OBW of the spectrum.</li> </ul>
Remark	
Result	<input checked="" type="checkbox"/> Pass <input type="checkbox"/> Fail

Test Data     Yes                       N/A

Test Plot     Yes (See below)             N/A

**Output Power measurement result**

Type	Test mode	CH	Frequency (MHz)	Conducted Power (dBm)	Limit (dBm)	Result
Output power	802.11b	Low	2412	15.13	30	Pass
		Mid	2437	<b>15.27</b>	30	Pass
		High	2462	15.27	30	Pass
	802.11g	Low	2412	<b>13.43</b>	30	Pass
		Mid	2437	13.21	30	Pass
		High	2462	13.13	30	Pass
	802.11n (20M)	Low	2412	13.40	30	Pass
		Mid	2437	<b>13.50</b>	30	Pass
		High	2462	13.05	30	Pass
	802.11n (40M)	Low	2422	<b>15.18</b>	30	Pass
		Mid	2437	14.99	30	Pass
		High	2452	14.63	30	Pass

### Test Plots

#### The Average Power

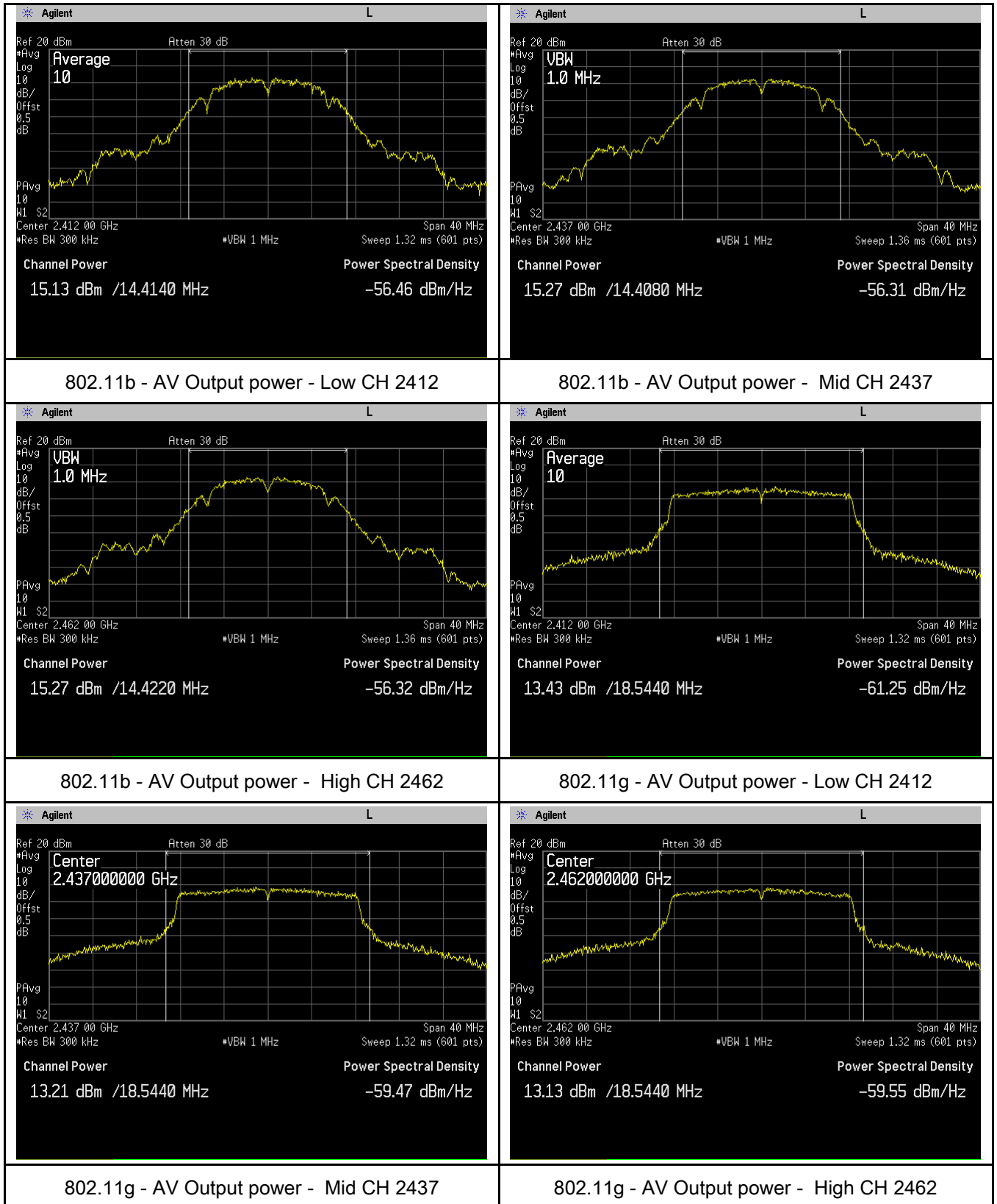

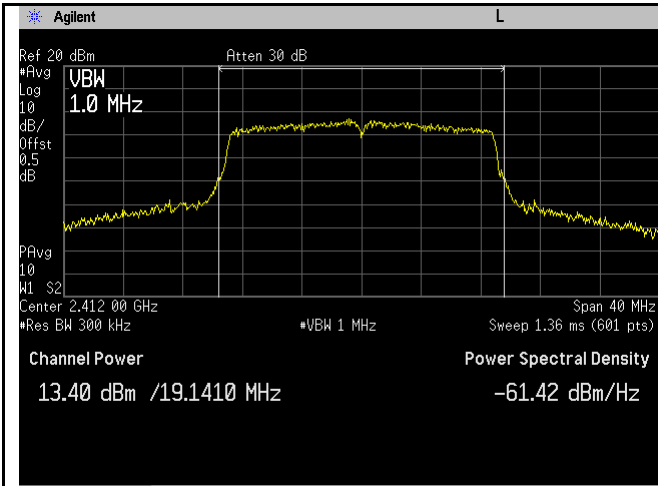

802.11n20 - AV Output power - Low CH 2412

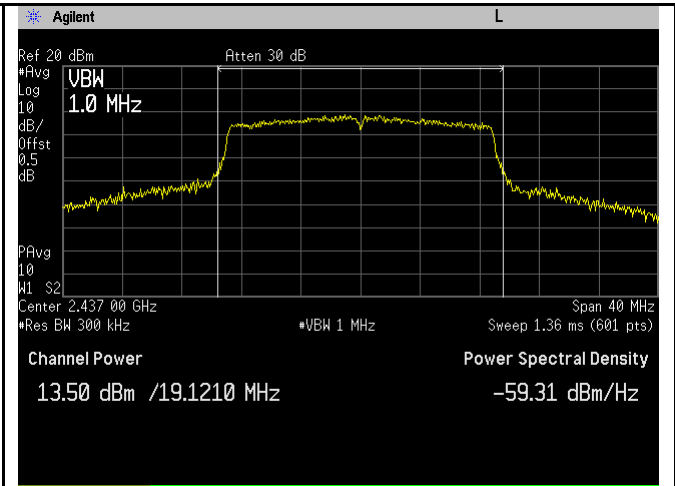

802.11n20 - AV Output power - Mid CH 2437

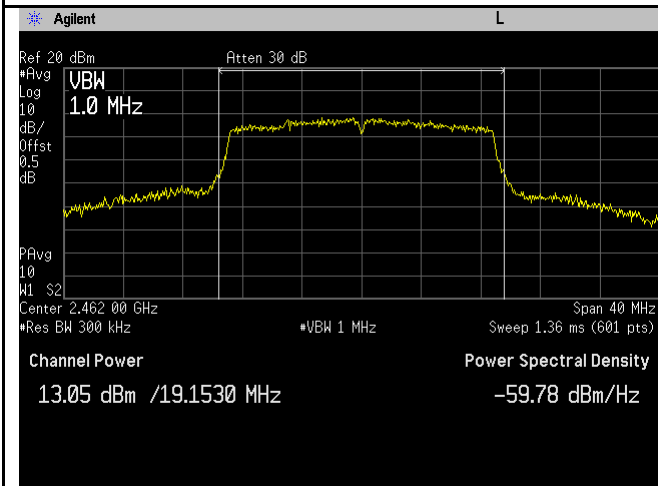

802.11n20 - AV Output power - High CH 2462

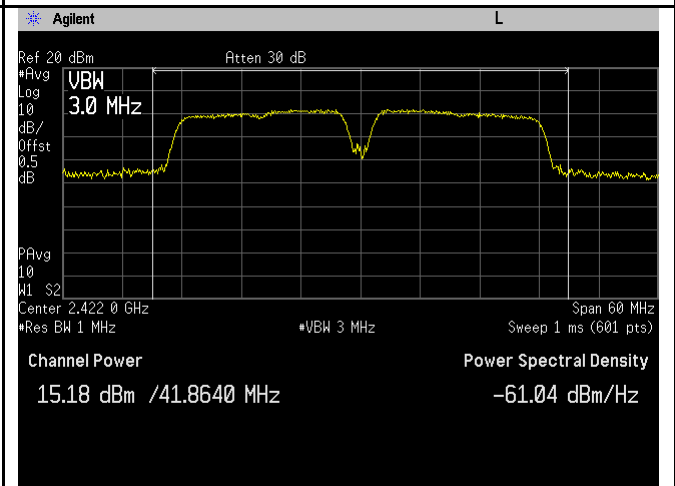

802.11n40 - AV Output power - Low CH 2422

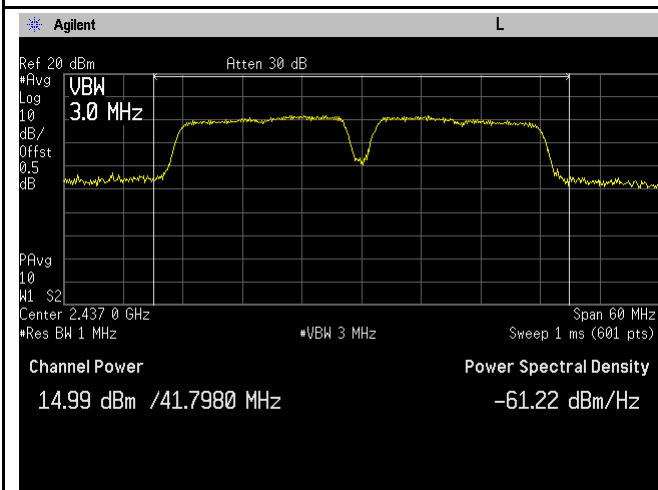

802.11n40 - AV Output power - Mid CH 2437

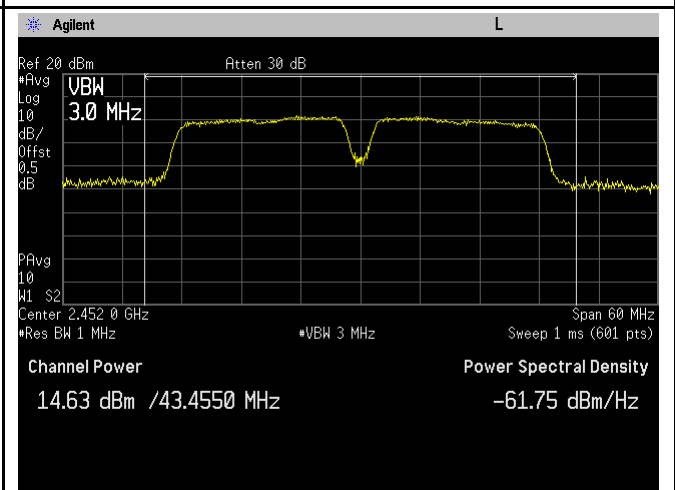

802.11n40 - AV Output power - High CH 2452

## 6.4 Power Spectral Density

Temperature	26 °C
Relative Humidity	57%
Atmospheric Pressure	1018mbar
Test date :	January 21, 2018
Tested By :	Aaron Liang

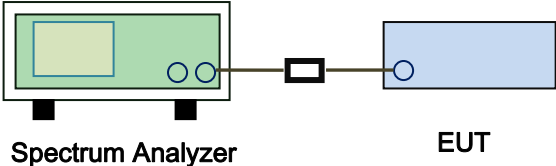
Spec	Item	Requirement	Applicable
§15.247(e)	a)	The power spectral density conducted from the intentional radiator to the antenna shall not be greater than 8 dBm in any 3 kHz band during any time interval of continuous transmission.	<input checked="" type="checkbox"/>
Test Setup	 <p style="text-align: center;">Spectrum Analyzer                      EUT</p>		
Test Procedure	<p>558074 D01 DTS MEAS Guidance v03r03, 10.2 power spectral density method power spectral density measurement procedure</p> <ul style="list-style-type: none"> <li>- a) Set analyzer center frequency to DTS channel center frequency.</li> <li>- b) Set the span to 1.5 times the DTS bandwidth.</li> <li>- c) Set the RBW to: <math>3 \text{ kHz} \leq \text{RBW} \leq 100 \text{ kHz}</math>.</li> <li>- d) Set the VBW <math>\geq 3 \times \text{RBW}</math>.</li> <li>- e) Detector = peak.</li> <li>- f) Sweep time = auto couple.</li> <li>- g) Trace mode = max hold.</li> <li>- h) Allow trace to fully stabilize.</li> <li>- i) Use the peak marker function to determine the maximum amplitude level within the RBW.</li> <li>- j) If measured value exceeds limit, reduce RBW (no less than 3 kHz) and repeat.</li> </ul>		
Remark			
Result	<input checked="" type="checkbox"/> Pass <input type="checkbox"/> Fail		

Test Data  Yes  N/A  
 Test Plot  Yes (See below)  N/A

**Power Spectral Density measurement result**

Type	Test mode	CH	Freq (MHz)	PSD	Limit (dBm)	Result
				(dBm)		
PSD	802.11b	Low	2412	-9.01	8	Pass
		Mid	2437	-8.10	8	Pass
		High	2462	-8.98	8	Pass
	802.11g	Low	2412	-13.57	8	Pass
		Mid	2437	-12.07	8	Pass
		High	2462	-12.95	8	Pass
	802.11n (20M)	Low	2412	-12.84	8	Pass
		Mid	2437	-12.62	8	Pass
		High	2462	-12.70	8	Pass
	802.11n (40M)	Low	2422	-12.27	8	Pass
		Mid	2437	-12.23	8	Pass
		High	2452	-12.33	8	Pass

### Test Plots

#### Power Spectral Density measurement result

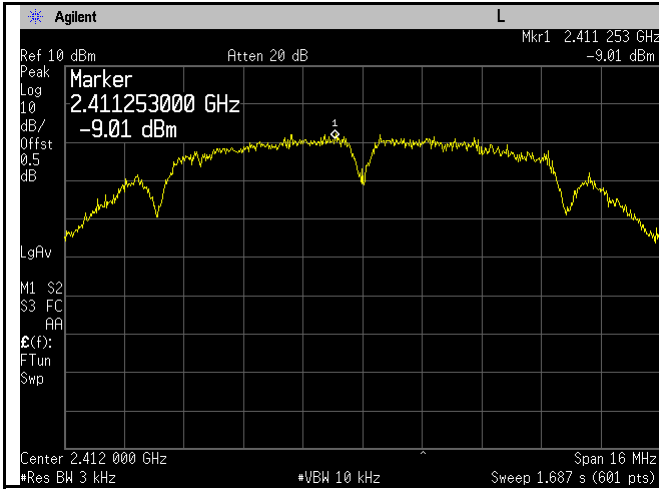

PSD - Low CH 2412 - 802.11b

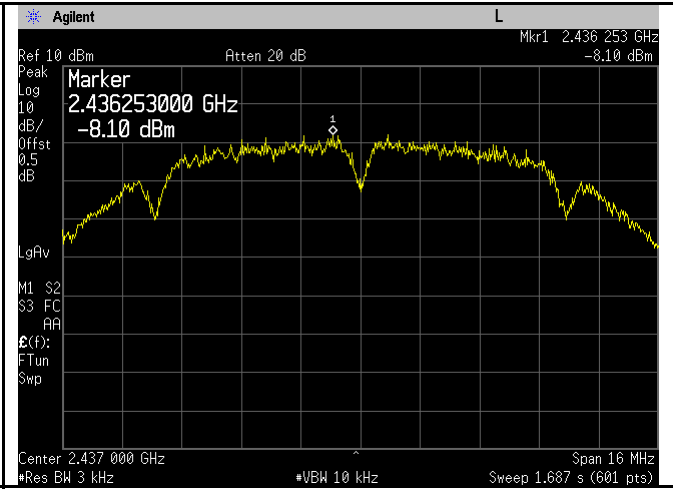

PSD - Mid CH 2437 - 802.11b

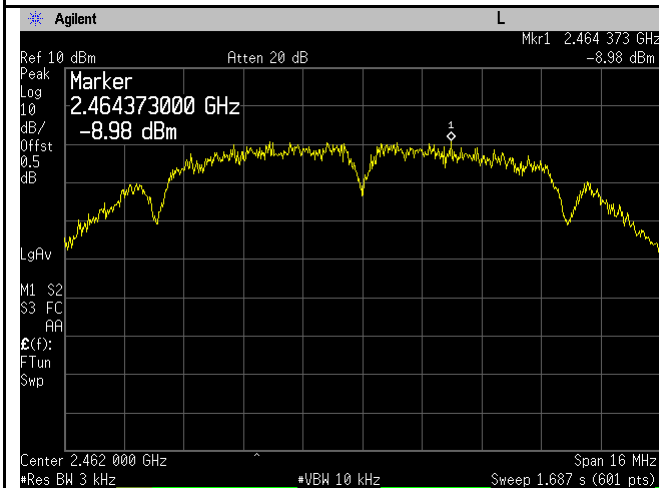

PSD - High CH 2462 - 802.11b

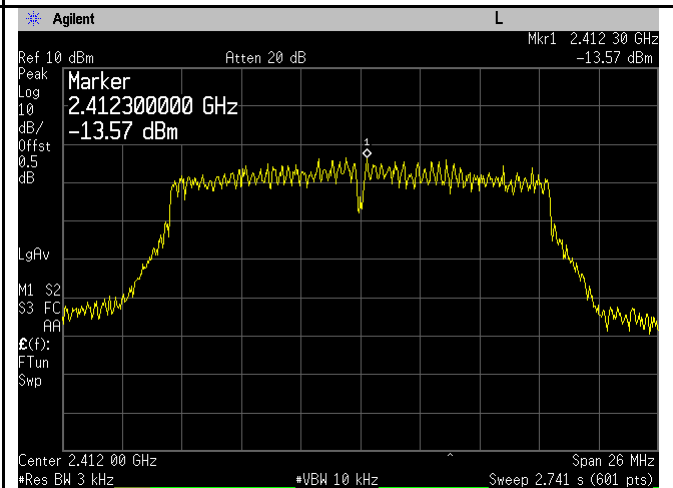

PSD - Low CH 2412 - 802.11g

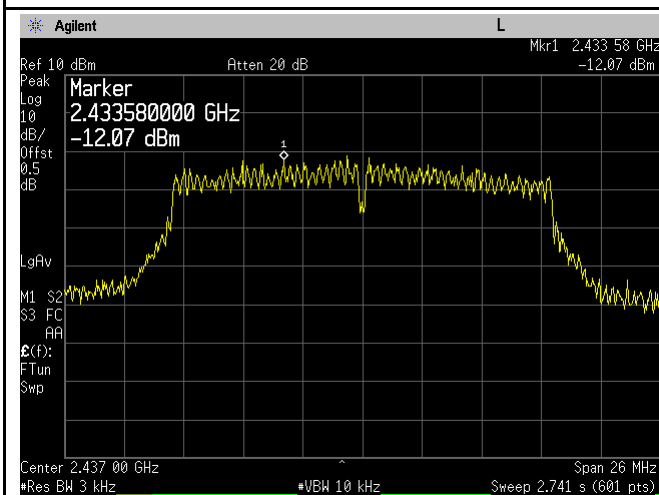

PSD - Mid CH 2437 - 802.11g

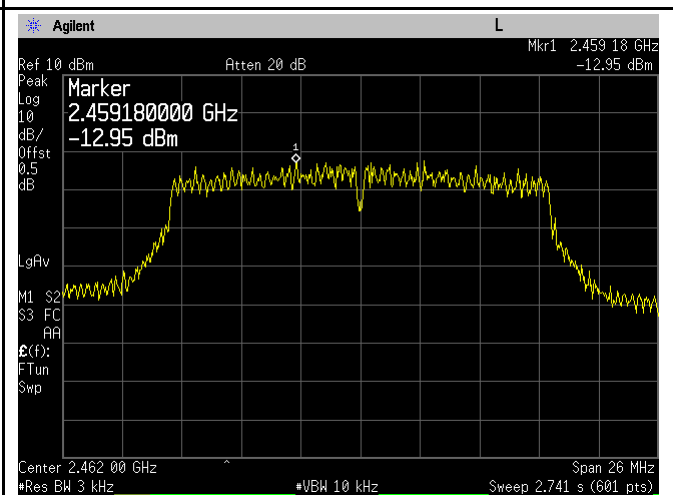

PSD - High CH 2462 - 802.11g



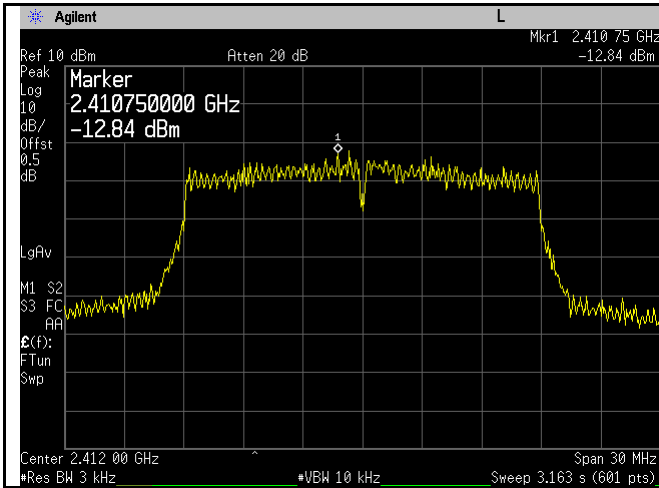

PSD - Low CH 2412 - 802.11n20

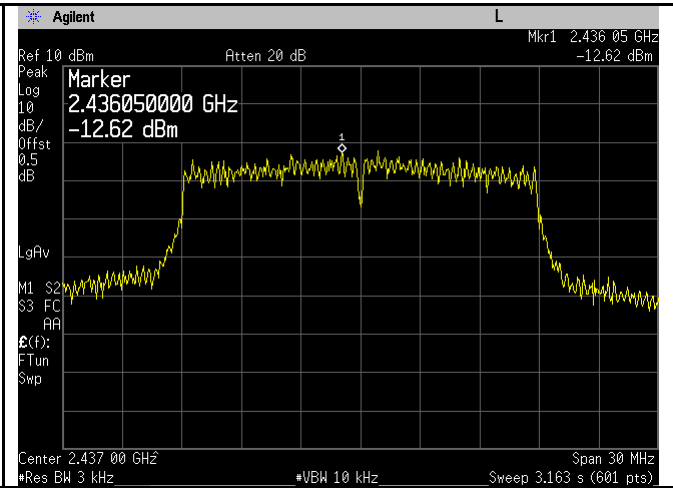

PSD - Mid CH 2437 - 802.11n20

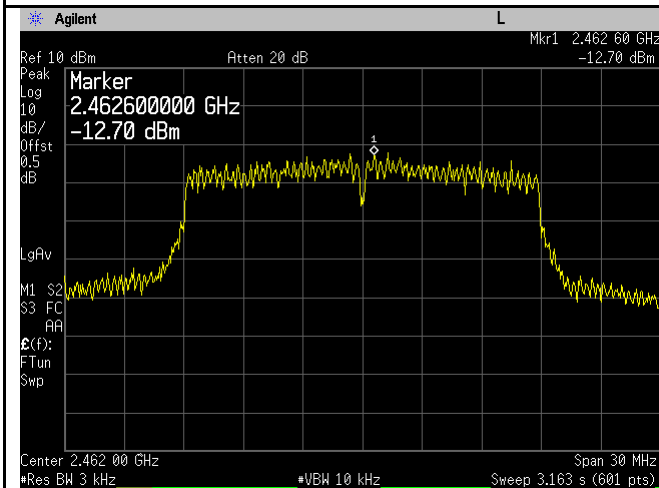

PSD - High CH 2472 - 802.11n20

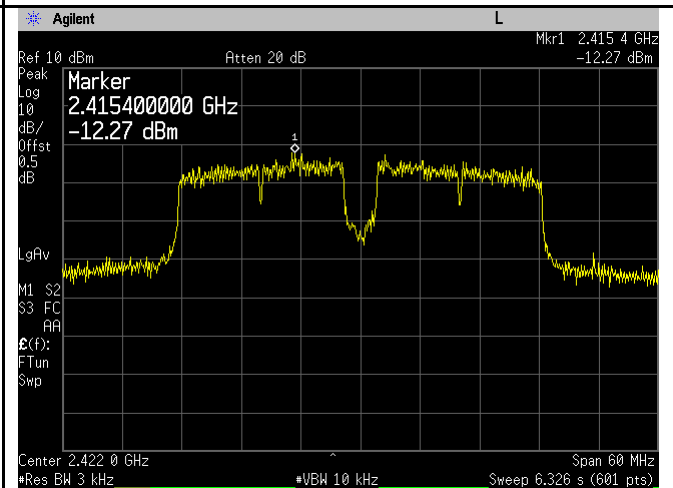

PSD - Low CH 2422 - 802.11n40

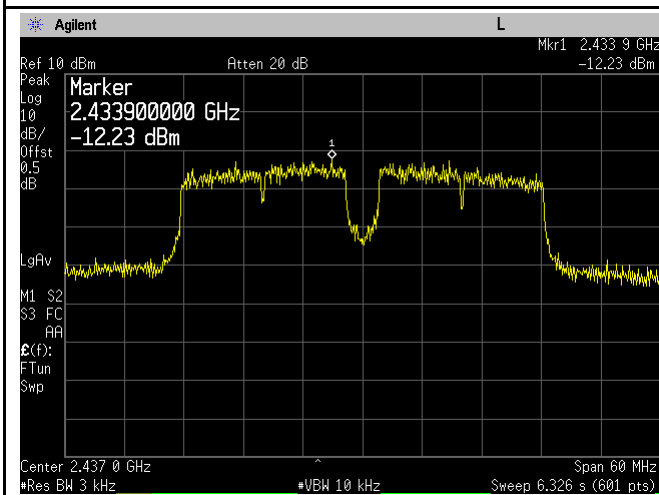

PSD - Mid CH 2437 - 802.11n40

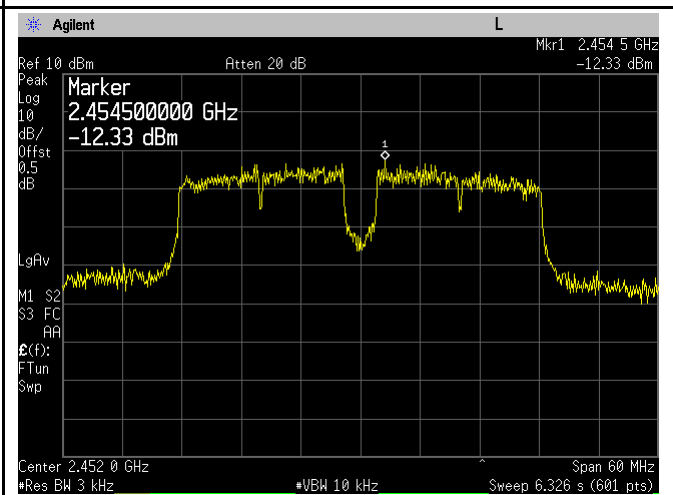

PSD - High CH 2452 - 802.11n40

## 6.5 Band-Edge & Unwanted Emissions into Restricted Frequency Bands

Temperature	25 °C
Relative Humidity	57%
Atmospheric Pressure	1018mbar
Test date :	January 19, 2018
Tested By :	Aaron Liang

### Requirement(s):

Spec	Item	Requirement	Applicable
§15.247(d)	a)	In any 100 kHz bandwidth outside the frequency band in which the spread spectrum or digitally modulated intentional radiator is operating, the radio frequency power that is produced by the intentional radiator shall be at least 20 dB below that in the 100 kHz bandwidth within the band that contains the highest level of the desired power, based on either an RF conducted or a radiated measurement, provided the transmitter demonstrates compliance with the peak conducted power limits.	<input checked="" type="checkbox"/>

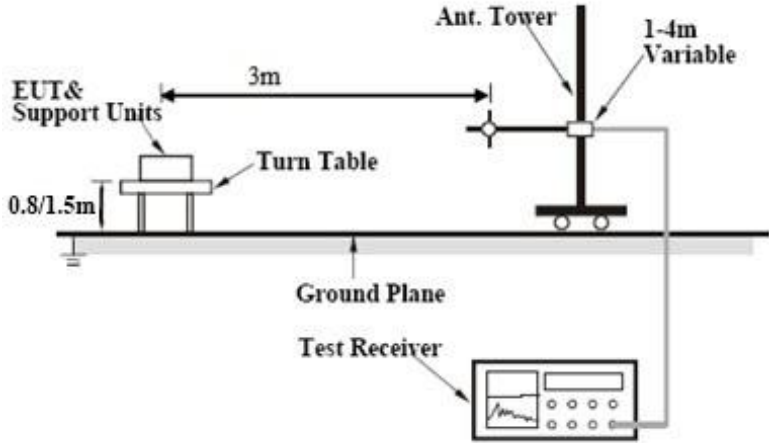
Test Setup	
------------	--

Test Procedure	<p>Radiated Method Only</p> <ul style="list-style-type: none"> <li>- 1. Check the calibration of the measuring instrument using either an internal calibrator or a known signal from an external generator.</li> <li>- 2. Position the EUT without connection to measurement instrument. Put it on the Rotated table and turn on the EUT and make it operate in transmitting mode. Then set it to Low Channel and High Channel within its operating range, and make sure the instrument is operated in its linear range.</li> </ul>
----------------	---

Test Report No.	18070046-FCC-R2
Page	27 of 66

	<ul style="list-style-type: none"> <li>- 3. First, set both RBW and VBW of spectrum analyzer to 100 kHz with a convenient frequency span including 100kHz bandwidth from band edge, check the emission of EUT, if pass then set Spectrum Analyzer as below:               <ul style="list-style-type: none"> <li>a. The resolution bandwidth and video bandwidth of test receiver/spectrum analyzer is 120 kHz for Quasi Peak detection at frequency below 1GHz.</li> <li>b. The resolution bandwidth of test receiver/spectrum analyzer is 1MHz and video bandwidth is 3MHz with Peak detection for Peak measurement at frequency above 1GHz.</li> <li>c. The resolution bandwidth of test receiver/spectrum analyzer is 1MHz and the video bandwidth is 10Hz with Peak detection for Average Measurement as below at frequency above 1GHz.</li> </ul> </li> <li>- 4. Measure the highest amplitude appearing on spectral display and set it as a reference level. Plot the graph with marking the highest point and edge frequency.</li> <li>- 5. Repeat above procedures until all measured frequencies were complete.</li> </ul>
Remark	
Result	<input checked="" type="checkbox"/> Pass <input type="checkbox"/> Fail

Test Data     Yes                       N/A  
 Test Plot      Yes (See below)             N/A

### Test Plots

#### Band Edge measurement result

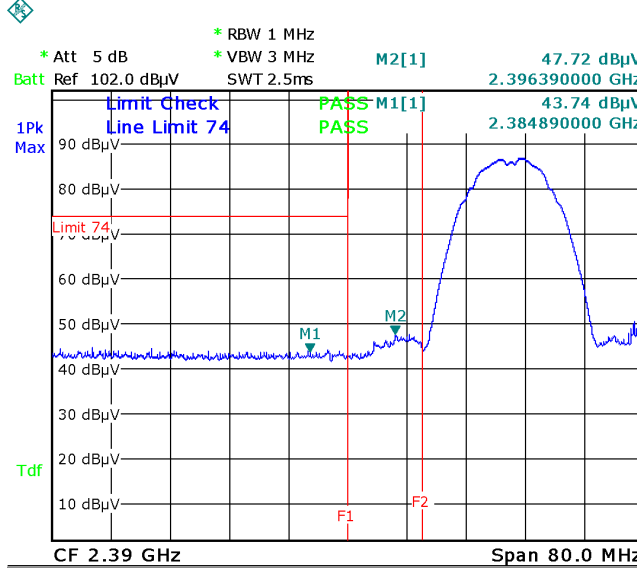
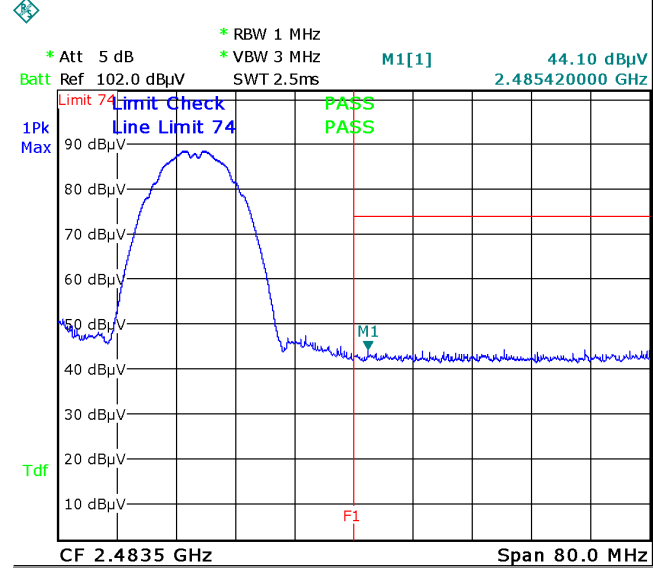
 <p>* RBW 1 MHz * VBW 3 MHz * Att 5 dB * Ref 102.0 dBµV * SWT 2.5ms</p> <p>M2[1] 47.72 dBµV 2.396390000 GHz</p> <p>Limit Check Line Limit 74 PASS M1[1] PASS 43.74 dBµV 2.384890000 GHz</p> <p>1Pk Max 90 dBµV 80 dBµV 70 dBµV 60 dBµV 50 dBµV 40 dBµV 30 dBµV 20 dBµV 10 dBµV</p> <p>Tdf</p> <p>CF 2.39 GHz Span 80.0 MHz</p> <p>Date: 19.JAN.2018 18:04:50</p>	 <p>* RBW 1 MHz * VBW 3 MHz * Att 5 dB * Ref 102.0 dBµV * SWT 2.5ms</p> <p>M1[1] 44.10 dBµV 2.485420000 GHz</p> <p>Limit Check Line Limit 74 PASS PASS</p> <p>1Pk Max 90 dBµV 80 dBµV 70 dBµV 60 dBµV 50 dBµV 40 dBµV 30 dBµV 20 dBµV 10 dBµV</p> <p>Tdf</p> <p>CF 2.4835 GHz Span 80.0 MHz</p> <p>Date: 19.JAN.2018 18:47:05</p>
<p>Band Edge, Left Side (Peak) - 802.11b</p> <p>Note: F1 is frequency 2390MHz; F2 is frequency 2400MHz</p>	<p>Band Edge, Right Side (Peak) - 802.11b</p> <p>Note: F1 is frequency 2483.5MHz</p>
<p>Note: (no need if PK value less than the AV limit)</p>	<p>Note: (no need if PK value less than the AV limit)</p>
<p>Band Edge, Left Side (Average) - 802.11b</p>	<p>Band Edge, Right Side (Average) - 802.11b</p>

Note: Both Horizontal and vertical polarities were investigated

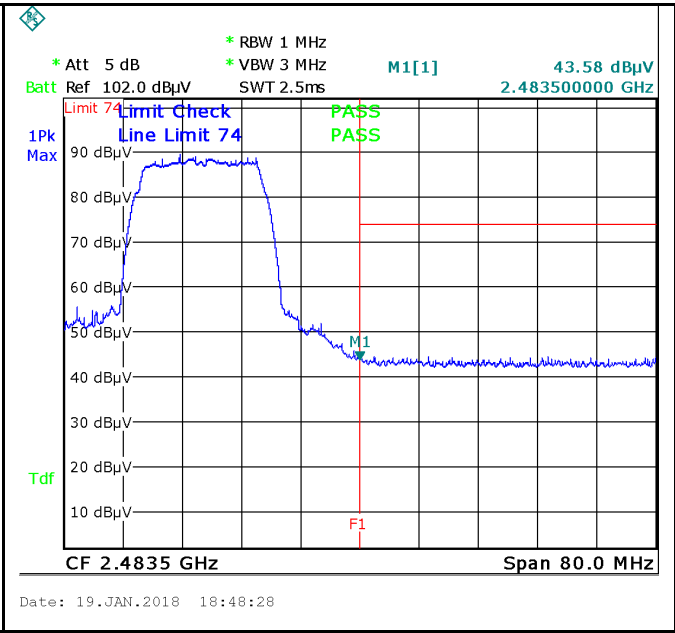
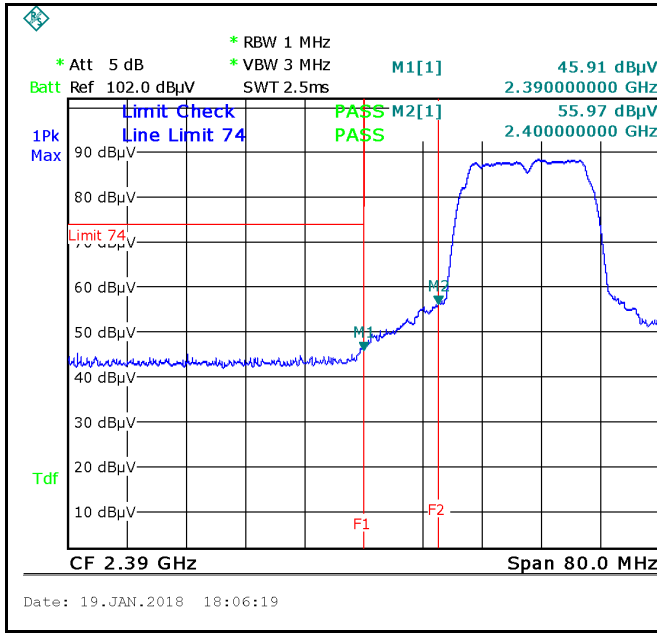

Band Edge, Left Side (Peak) - 802.11g  
**Note: F1 is frequency 2390MHz; F2 is frequency 2400MHz**

Band Edge, Right Side (Peak) - 802.11g  
**Note: F1 is frequency 2483.5MHz**

Note: (no need if PK value less than the AV limit)

Note: (no need if PK value less than the AV limit)

Band Edge, Left Side (Average) - 802.11g  
**Note: F1 is frequency 2390MHz; F2 is frequency 2400MHz**

Band Edge, Right Side (Average) - 802.11g  
**Note: F1 is frequency 2483.5MHz**

Note: Both Horizontal and vertical polarities were investigated

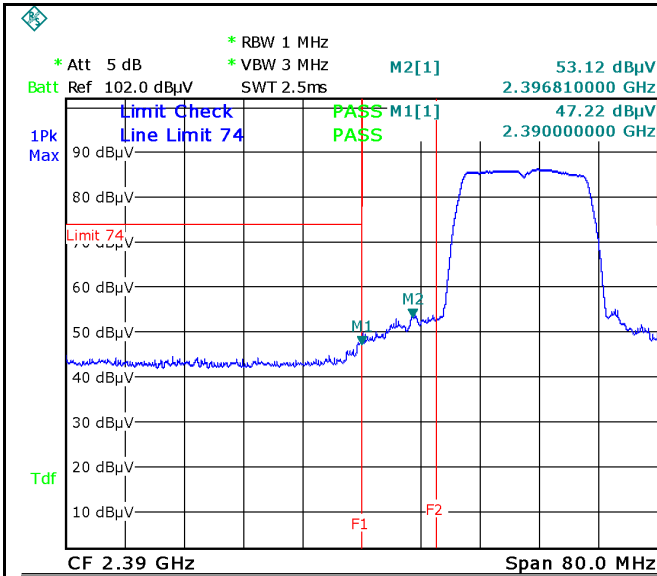

Date: 19.JAN.2018 18:41:16

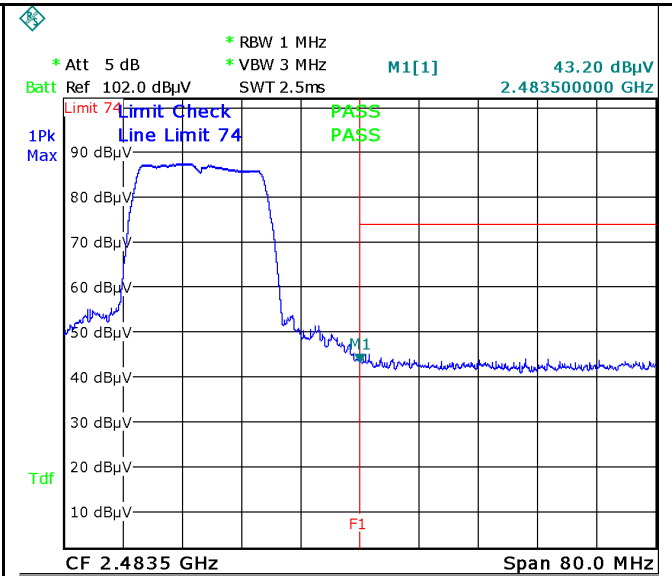

Date: 19.JAN.2018 18:49:39

Band Edge, Left Side (Peak) - 802.11n20  
**Note: F1 is frequency 2390MHz; F2 is frequency 2400MHz**

Band Edge, Right Side (Peak) - 802.11n20  
**Note: F1 is frequency 2483.5MHz**

Note: (no need if PK value less than the AV limit)

Note: (no need if PK value less than the AV limit)

Band Edge, Left Side (Average) - 802.11n20  
**Note: F1 is frequency 2390MHz; F2 is frequency 2400MHz**

Band Edge, Right Side (Average) - 802.11n20  
**Note: F1 is frequency 2483.5MHz**

Note: Both Horizontal and vertical polarities were investigated

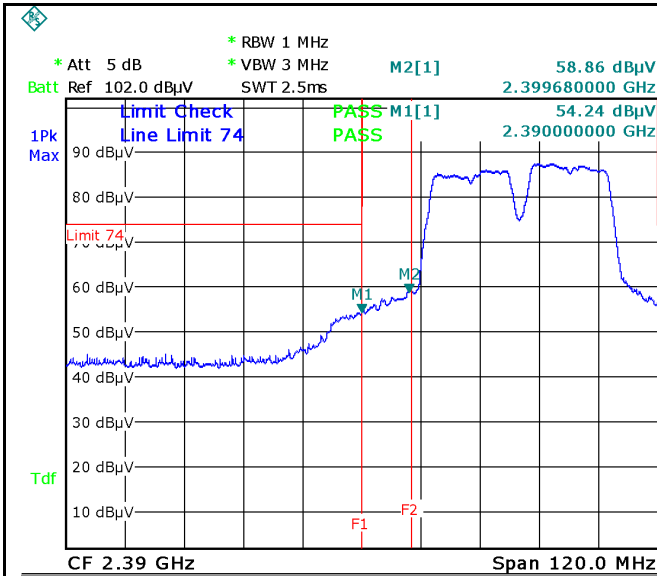

Date: 19.JAN.2018 18:42:44

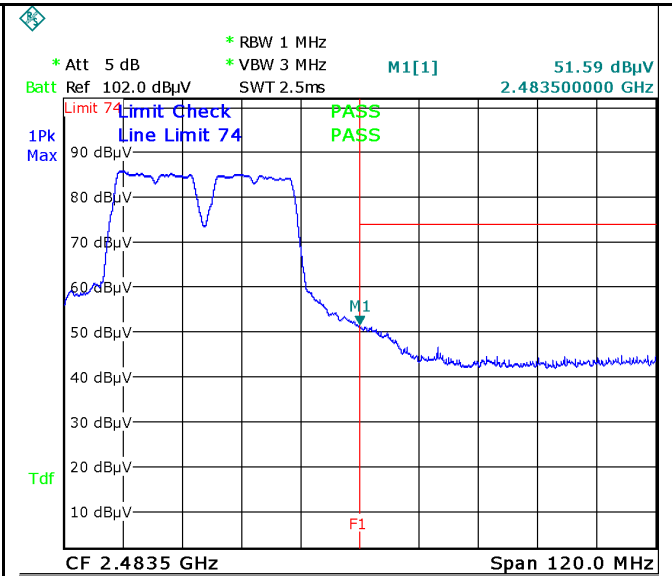

Date: 19.JAN.2018 18:45:28

Band Edge, Left Side (Peak) - 802.11n40

Note: F1 is frequency 2390MHz; F2 is frequency 2400MHz

Band Edge, Right Side (Peak) - 802.11n40

Note: F1 is frequency 2483.5MHz

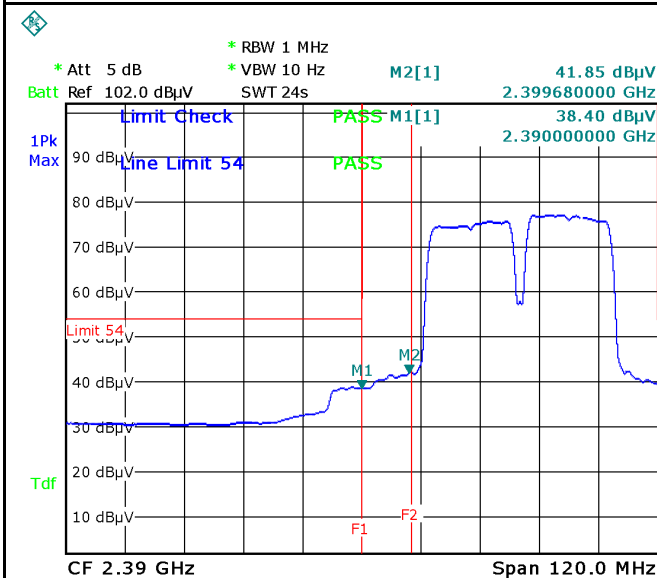

Date: 19.JAN.2018 18:43:33

Note: (no need if PK value less than the AV limit)

Band Edge, Left Side (Average) - 802.11n40

Note: F1 is frequency 2390MHz; F2 is frequency 2400MHz

Band Edge, Right Side (Average) - 802.11n40

Note: F1 is frequency 2483.5MHz

Note: Both Horizontal and vertical polarities were investigated

## 6.6 AC Power Line Conducted Emissions

Temperature	24 °C
Relative Humidity	53%
Atmospheric Pressure	1010mbar
Test date :	January 15, 2018
Tested By :	Aaron Liang

### Requirement(s):

Spec	Item	Requirement	Applicable														
47CFR§15.207, RSS210 (A8.1)	a)	For Low-power radio-frequency devices that is designed to be connected to the public utility (AC) power line, the radio frequency voltage that is conducted back onto the AC power line on any frequency or frequencies, within the band 150 kHz to 30 MHz, shall not exceed the limits in the following table, as measured using a 50 [mu] H/50 ohms line impedance stabilization network (LISN). The lower limit applies at the boundary between the frequencies ranges.	<input checked="" type="checkbox"/>														
		<table border="1"> <thead> <tr> <th rowspan="2">Frequency ranges (MHz)</th> <th colspan="2">Limit (dBµV)</th> </tr> <tr> <th>QP</th> <th>Average</th> </tr> </thead> <tbody> <tr> <td>0.15 ~ 0.5</td> <td>66 – 56</td> <td>56 – 46</td> </tr> <tr> <td>0.5 ~ 5</td> <td>56</td> <td>46</td> </tr> <tr> <td>5 ~ 30</td> <td>60</td> <td>50</td> </tr> </tbody> </table>		Frequency ranges (MHz)	Limit (dBµV)		QP	Average	0.15 ~ 0.5	66 – 56	56 – 46	0.5 ~ 5	56	46	5 ~ 30	60	50
		Frequency ranges (MHz)			Limit (dBµV)												
				QP	Average												
0.15 ~ 0.5	66 – 56	56 – 46															
0.5 ~ 5	56	46															
5 ~ 30	60	50															

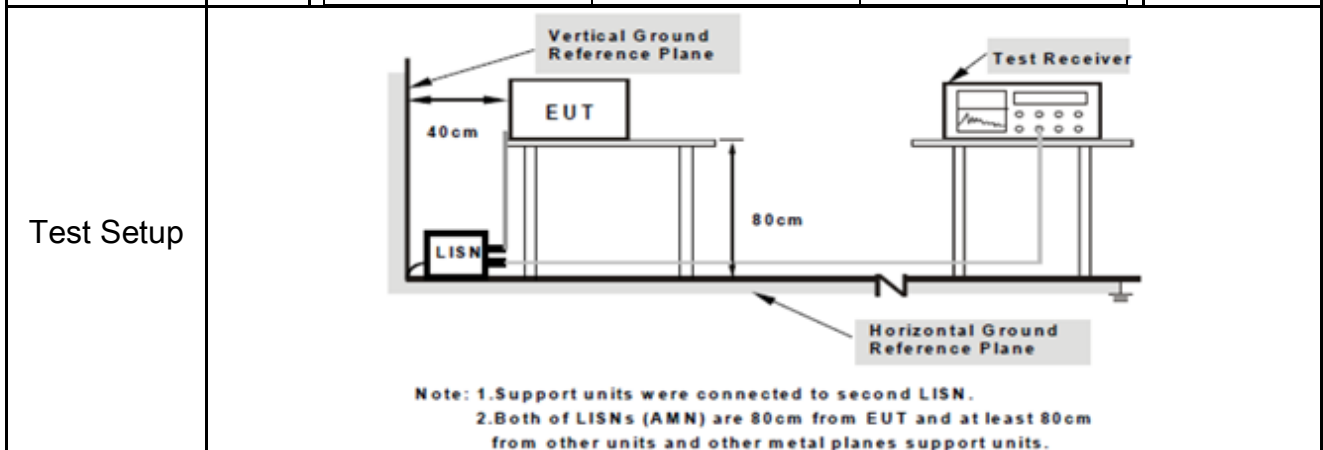

Procedure	<ol style="list-style-type: none"> <li>The EUT and supporting equipment were set up in accordance with the requirements of the standard on top of a 1.5m x 1m x 0.8m high, non-metallic table.</li> <li>The power supply for the EUT was fed through a 50W/50mH EUT LISN, connected to filtered mains.</li> <li>The RF OUT of the EUT LISN was connected to the EMI test receiver via a low-loss</li> </ol>
-----------	---



Test Report No.	18070046-FCC-R2
Page	33 of 66

	<p>coaxial cable.</p> <ol style="list-style-type: none"> <li>4. All other supporting equipment were powered separately from another main supply.</li> <li>5. The EUT was switched on and allowed to warm up to its normal operating condition.</li> <li>6. A scan was made on the NEUTRAL line (for AC mains) or Earth line (for DC power) over the required frequency range using an EMI test receiver.</li> <li>7. High peaks, relative to the limit line, The EMI test receiver was then tuned to the selected frequencies and the necessary measurements made with a receiver bandwidth setting of 10 kHz.</li> <li>8. Step 7 was then repeated for the LIVE line (for AC mains) or DC line (for DC power).</li> </ol>
Remark	
Result	<input checked="" type="checkbox"/> Pass <input type="checkbox"/> Fail

Test Data     Yes                       N/A

Test Plot     Yes (See below)               N/A

<b>Test Mode:</b>	<b>Transmitting Mode</b>
-------------------	--------------------------

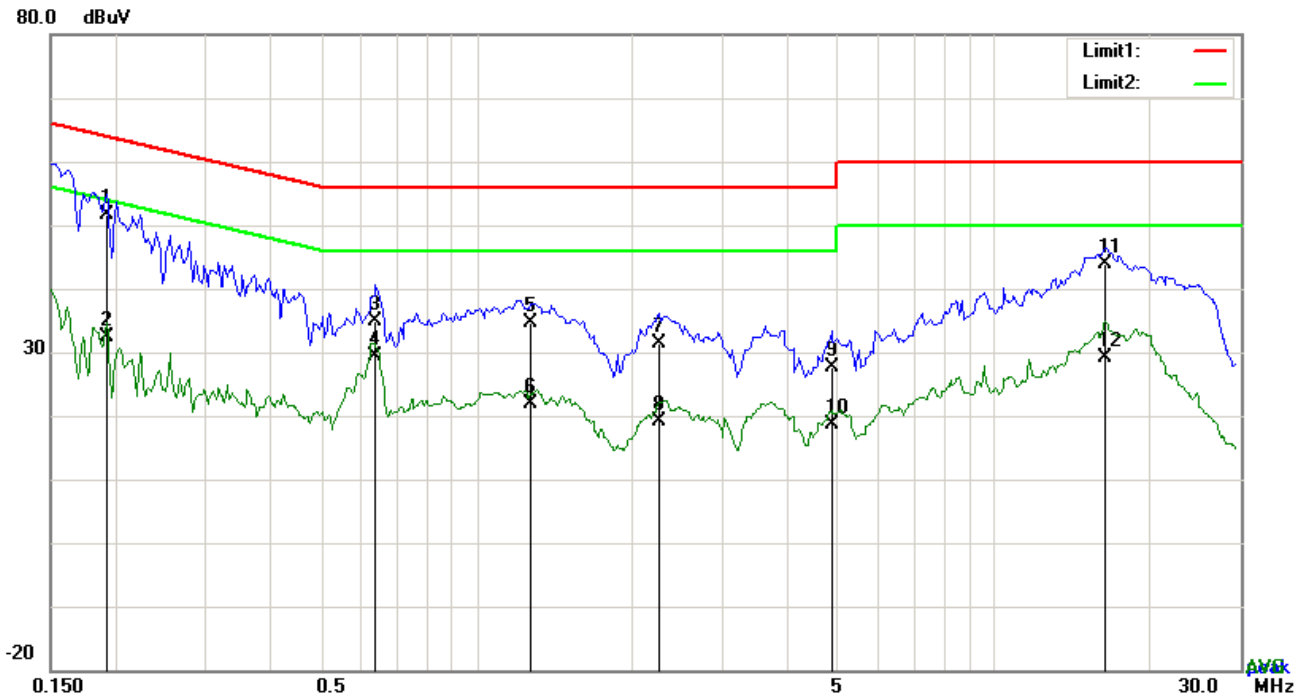

**Test Data**

**Phase Line Plot at 120Vac, 60Hz**

No.	P/L	Frequency (MHz)	Reading (dBµV)	Detector	Corrected (dB)	Result (dBµV)	Limit (dBµV)	Margin (dB)
1	L1	0.1929	41.64	QP	10.03	51.67	63.91	-12.24
2	L1	0.1929	22.46	AVG	10.03	32.49	53.91	-21.42
3	L1	0.6375	24.97	QP	10.03	35.00	56.00	-21.00
4	L1	0.6375	19.30	AVG	10.03	29.33	46.00	-16.67
5	L1	1.2732	24.54	QP	10.03	34.57	56.00	-21.43
6	L1	1.2732	11.94	AVG	10.03	21.97	46.00	-24.03
7	L1	2.2521	21.33	QP	10.05	31.38	56.00	-24.62
8	L1	2.2521	9.15	AVG	10.05	19.20	46.00	-26.80
9	L1	4.8720	17.65	QP	10.08	27.73	56.00	-28.27
10	L1	4.8720	8.65	AVG	10.08	18.73	46.00	-27.27
11	L1	16.4043	33.71	QP	10.25	43.96	60.00	-16.04
12	L1	16.4043	18.93	AVG	10.25	29.18	50.00	-20.82

<b>Test Mode:</b>	<b>Transmitting Mode</b>
-------------------	--------------------------

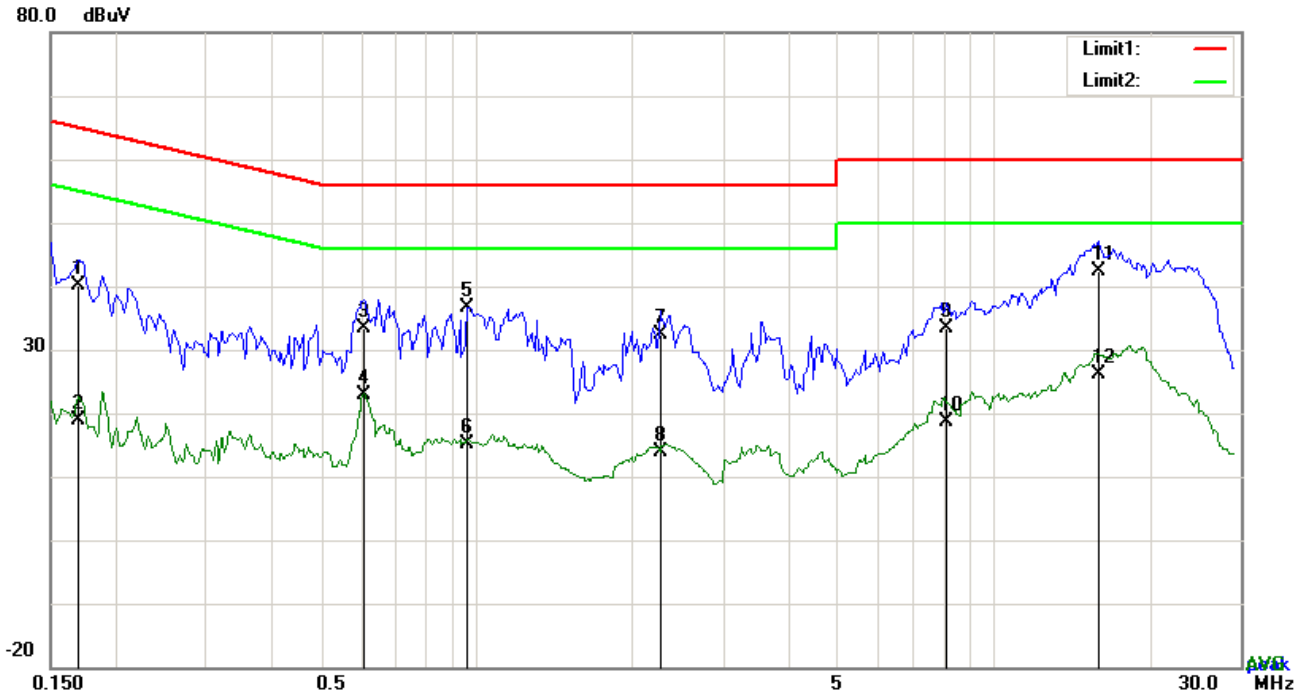

**Test Data**

**Phase Neutral Plot at 120Vac, 60Hz**

No.	P/L	Frequency (MHz)	Reading (dBµV)	Detector	Corrected (dB)	Result (dBµV)	Limit (dBµV)	Margin (dB)
1	N	0.1695	30.02	QP	10.02	40.04	64.98	-24.94
2	N	0.1695	8.97	AVG	10.02	18.99	54.98	-35.99
3	N	0.6063	23.35	QP	10.02	33.37	56.00	-22.63
4	N	0.6063	12.78	AVG	10.02	22.80	46.00	-23.20
5	N	0.9612	26.72	QP	10.03	36.75	56.00	-19.25
6	N	0.9612	5.12	AVG	10.03	15.15	46.00	-30.85
7	N	2.2638	22.27	QP	10.04	32.31	56.00	-23.69
8	N	2.2638	3.82	AVG	10.04	13.86	46.00	-32.14
9	N	8.0895	23.38	QP	10.11	33.49	60.00	-26.51
10	N	8.0895	8.49	AVG	10.11	18.60	50.00	-31.40
11	N	15.9675	32.28	QP	10.21	42.49	60.00	-17.51
12	N	15.9675	15.99	AVG	10.21	26.20	50.00	-23.80

<b>Test Mode:</b>	<b>Transmitting Mode</b>
-------------------	--------------------------

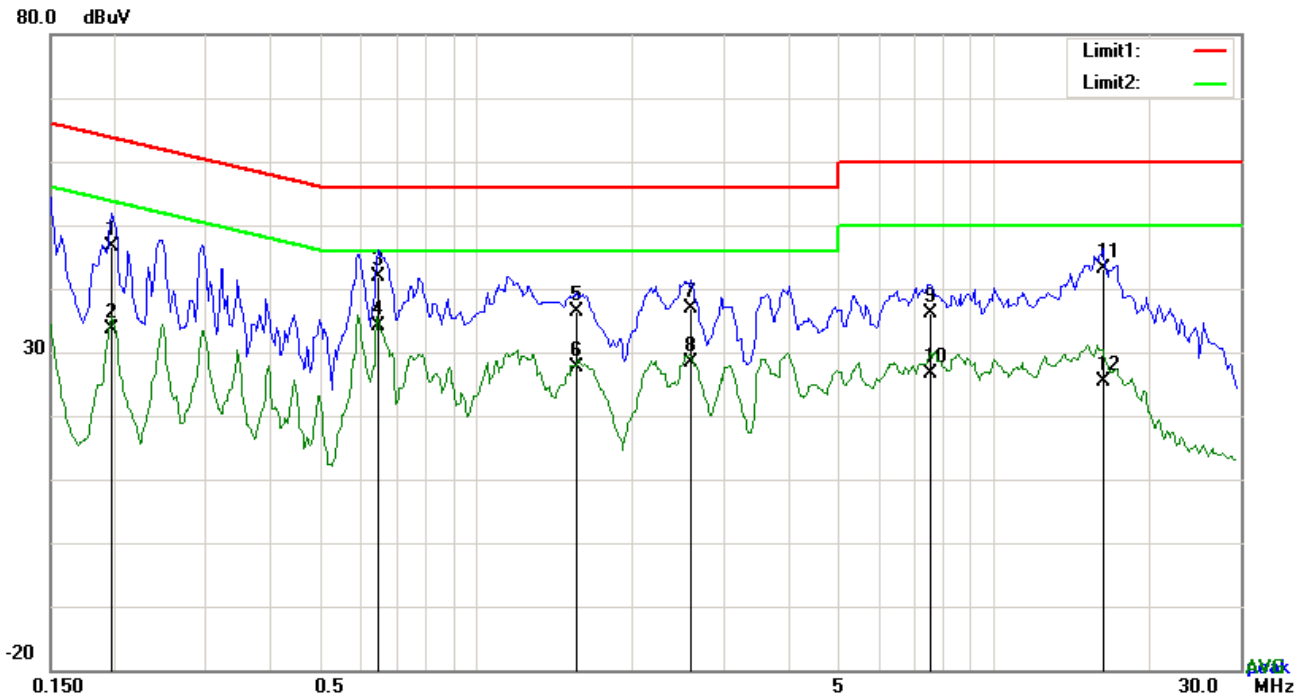

**Test Data**

**Phase Line Plot at 240Vac, 60Hz**

No.	P/L	Frequency (MHz)	Reading (dBµV)	Detector	Corrected (dB)	Result (dBµV)	Limit (dBµV)	Margin (dB)
1	L1	0.1968	36.61	QP	10.03	46.64	63.74	-17.10
2	L1	0.1968	23.66	AVG	10.03	33.69	53.74	-20.05
3	L1	0.6453	31.81	QP	10.03	41.84	56.00	-14.16
4	L1	0.6453	24.16	AVG	10.03	34.19	46.00	-11.81
5	L1	1.5618	26.30	QP	10.04	36.34	56.00	-19.66
6	L1	1.5618	17.55	AVG	10.04	27.59	46.00	-18.41
7	L1	2.5953	26.86	QP	10.05	36.91	56.00	-19.09
8	L1	2.5953	18.40	AVG	10.05	28.45	46.00	-17.55
9	L1	7.5279	25.92	QP	10.12	36.04	60.00	-23.96
10	L1	7.5279	16.40	AVG	10.12	26.52	50.00	-23.48
11	L1	16.2678	32.81	QP	10.24	43.05	60.00	-16.95
12	L1	16.2678	15.18	AVG	10.24	25.42	50.00	-24.58

<b>Test Mode:</b>	<b>Transmitting Mode</b>
-------------------	--------------------------

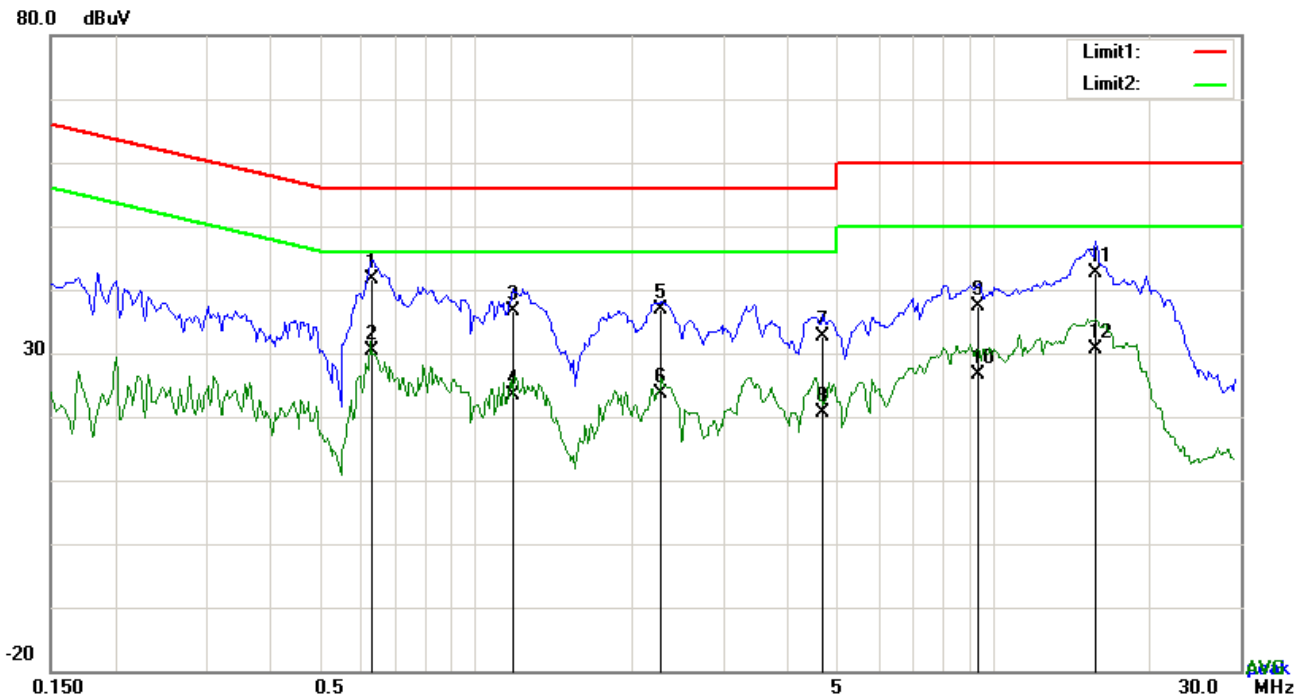

**Test Data**

**Phase Neutral Plot at 240Vac, 60Hz**

No.	P/L	Frequency (MHz)	Reading (dBµV)	Detector	Corrected (dB)	Result (dBµV)	Limit (dBµV)	Margin (dB)
1	N	0.6297	31.51	QP	10.02	41.53	56.00	-14.47
2	N	0.6297	20.26	AVG	10.02	30.28	46.00	-15.72
3	N	1.1757	26.66	QP	10.03	36.69	56.00	-19.31
4	N	1.1757	13.43	AVG	10.03	23.46	46.00	-22.54
5	N	2.2794	26.96	QP	10.04	37.00	56.00	-19.00
6	N	2.2794	13.64	AVG	10.04	23.68	46.00	-22.32
7	N	4.6848	22.45	QP	10.07	32.52	56.00	-23.48
8	N	4.6848	10.59	AVG	10.07	20.66	46.00	-25.34
9	N	9.3180	27.17	QP	10.13	37.30	60.00	-22.70
10	N	9.3180	16.44	AVG	10.13	26.57	50.00	-23.43
11	N	15.7179	32.38	QP	10.21	42.59	60.00	-17.41
12	N	15.7179	20.41	AVG	10.21	30.62	50.00	-19.38

## 6.7 Radiated Spurious Emissions & Restricted Band

Temperature	25 °C
Relative Humidity	57%
Atmospheric Pressure	1016mbar
Test date :	January 17, 2018
Tested By :	Aaron Liang

### Requirement(s):

Spec	Item	Requirement	Applicable																
47CFR§15.247(d), RSS210 (A8.5)	a)	<p>Except higher limit as specified elsewhere in other section, the emissions from the low-power radio-frequency devices shall not exceed the field strength levels specified in the following table and the level of any unwanted emissions shall not exceed the level of the fundamental emission. The tighter limit applies at the band edges</p> <table border="1"> <thead> <tr> <th>Frequency range (MHz)</th> <th>Field Strength (µV/m)</th> </tr> </thead> <tbody> <tr> <td>0.009~0.490</td> <td>2400/F(KHz)</td> </tr> <tr> <td>0.490~1.705</td> <td>24000/F(KHz)</td> </tr> <tr> <td>1.705~30.0</td> <td>30</td> </tr> <tr> <td>30 – 88</td> <td>100</td> </tr> <tr> <td>88 – 216</td> <td>150</td> </tr> <tr> <td>216 960</td> <td>200</td> </tr> <tr> <td>Above 960</td> <td>500</td> </tr> </tbody> </table>	Frequency range (MHz)	Field Strength (µV/m)	0.009~0.490	2400/F(KHz)	0.490~1.705	24000/F(KHz)	1.705~30.0	30	30 – 88	100	88 – 216	150	216 960	200	Above 960	500	<input checked="" type="checkbox"/>
	Frequency range (MHz)	Field Strength (µV/m)																	
	0.009~0.490	2400/F(KHz)																	
0.490~1.705	24000/F(KHz)																		
1.705~30.0	30																		
30 – 88	100																		
88 – 216	150																		
216 960	200																		
Above 960	500																		
b)	<p>For non-restricted band, In any 100 kHz bandwidth outside the frequency band in which the spread spectrum or digitally modulated intentional radiator is operating, the radio frequency power that is produced by the intentional radiator shall be at least 20 dB or 30dB below that in the 100 kHz bandwidth within the band that contains the highest level of the desired power, determined by the measurement method on output power to be used. Attenuation below the general limits specified in § 15.209(a) is not required</p> <p><input checked="" type="checkbox"/> 20 dB down      <input type="checkbox"/> 30 dB down</p>	<input checked="" type="checkbox"/>																	
c)	<p>or restricted band, emission must also comply with the radiated emission limits specified in 15.209</p>	<input checked="" type="checkbox"/>																	

<p>Test Setup</p>	
<p>Procedure</p>	<ol style="list-style-type: none"> <li>1. The EUT was switched on and allowed to warm up to its normal operating condition.</li> <li>2. The test was carried out at the selected frequency points obtained from the EUT characterization. Maximization of the emissions, was carried out by rotating the EUT, changing the antenna polarization, and adjusting the antenna height in the following manner:             <ol style="list-style-type: none"> <li>a. Vertical or horizontal polarization (whichever gave the higher emission level over a full rotation of the EUT) was chosen.</li> <li>b. The EUT was then rotated to the direction that gave the maximum emission.</li> <li>c. Finally, the antenna height was adjusted to the height that gave the maximum emission.</li> </ol> </li> <li>3. The resolution bandwidth and video bandwidth of test receiver/spectrum analyzer is 120 kHz for Quasi Peak detection at frequency below 1GHz.</li> <li>4. The resolution bandwidth of test receiver/spectrum analyzer is 1MHz and video bandwidth is 3MHz with Peak detection for Peak measurement at frequency above 1GHz.</li> </ol>

Test Report No.	18070046-FCC-R2
Page	40 of 66

	<p>The resolution bandwidth of test receiver/spectrum analyzer is 1MHz and the video bandwidth is 10Hz with Peak detection for Average Measurement as below at frequency above 1GHz.</p> <p>5. Steps 2 and 3 were repeated for the next frequency point, until all selected frequency points were measured.</p>
Remark	
Result	<input checked="" type="checkbox"/> Pass <input type="checkbox"/> Fail

Test Data     Yes                       N/A

Test Plot     Yes (See below)             N/A



**Test Result:**

<b>Test Mode:</b>	Transmitting Mode
-------------------	-------------------

Frequency range: 9KHz - 30MHz

Freq. (MHz)	Detection value	Factor (dB/m)	Reading (dBuV/m)	Result (dBuV/m)	Limit@3m (dBuV/m)	Margin (dB)
--	--	--	--	--	--	>20
--	--	--	--	--	--	>20

**Note:**

The amplitude of spurious emissions which are attenuated by more than 20dB below the permissible value has no need to be reported.

Distance extrapolation factor =  $40 \log (\text{specific distance}/\text{test distance})$ (dB);

Limit line = specific limits(dBuv) + distance extrapolation factor.

<b>Test Mode:</b>	<b>Transmitting Mode</b>
-------------------	--------------------------

**30MHz -1GHz**

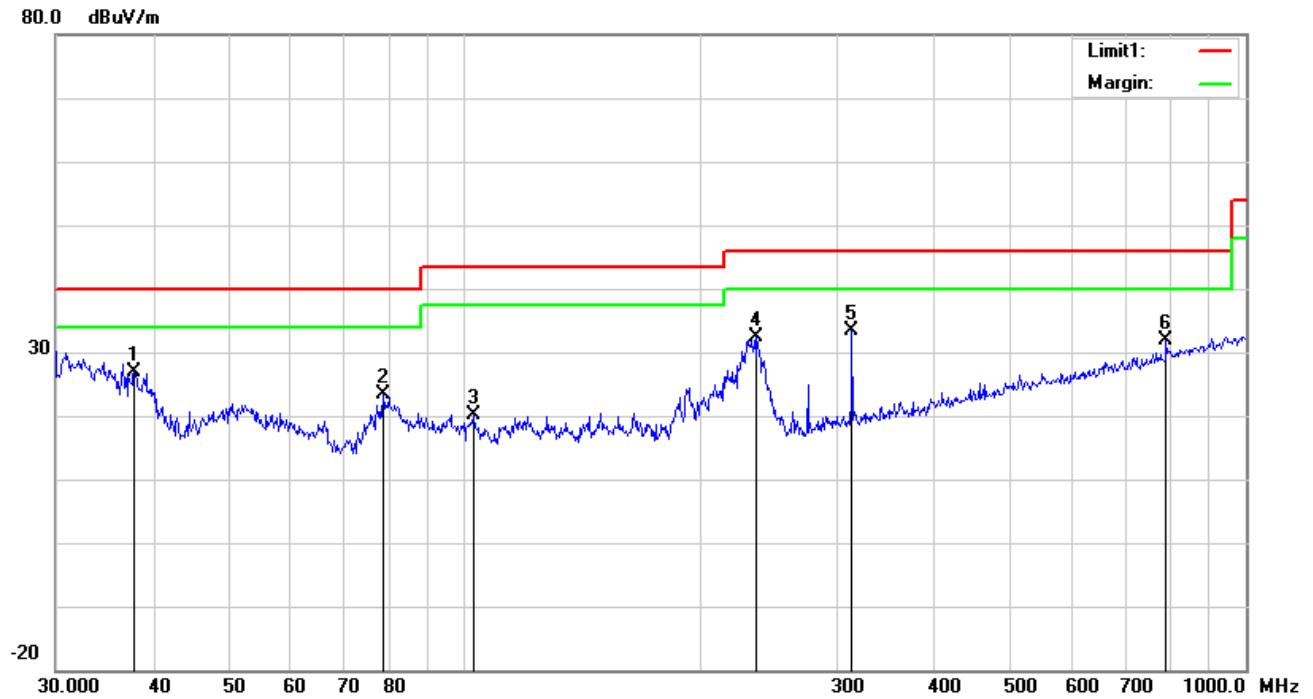

**Test Data**

**Vertical Polarity Plot @3m**

No.	P/L	Frequency	Reading	Detect or	Ant_F	PA_G	Cab_L	Result	Limit	Margin	Height	Degree
		(MHz)	(dBuV/m)		(dB/m)	(dB)	(dB)	(dBuV/m)	(dBuV/m)	(dB)	(cm)	( ° )
1	V	37.8121	32.80	peak	15.50	22.27	0.78	26.81	40.00	-13.19	100	258
2	V	78.6888	37.11	peak	7.63	22.41	1.03	23.36	40.00	-16.64	100	126
3	V	102.7192	30.41	peak	10.88	22.33	1.13	20.09	43.50	-23.41	200	281
4	V	236.6447	41.39	peak	11.59	22.31	1.66	32.33	46.00	-13.67	100	38
5	V	313.2760	39.95	peak	13.88	22.25	1.86	33.44	46.00	-12.56	100	274
6	V	790.6188	28.73	peak	21.29	21.17	2.94	31.79	46.00	-14.21	100	285

### 30MHz -1GHz

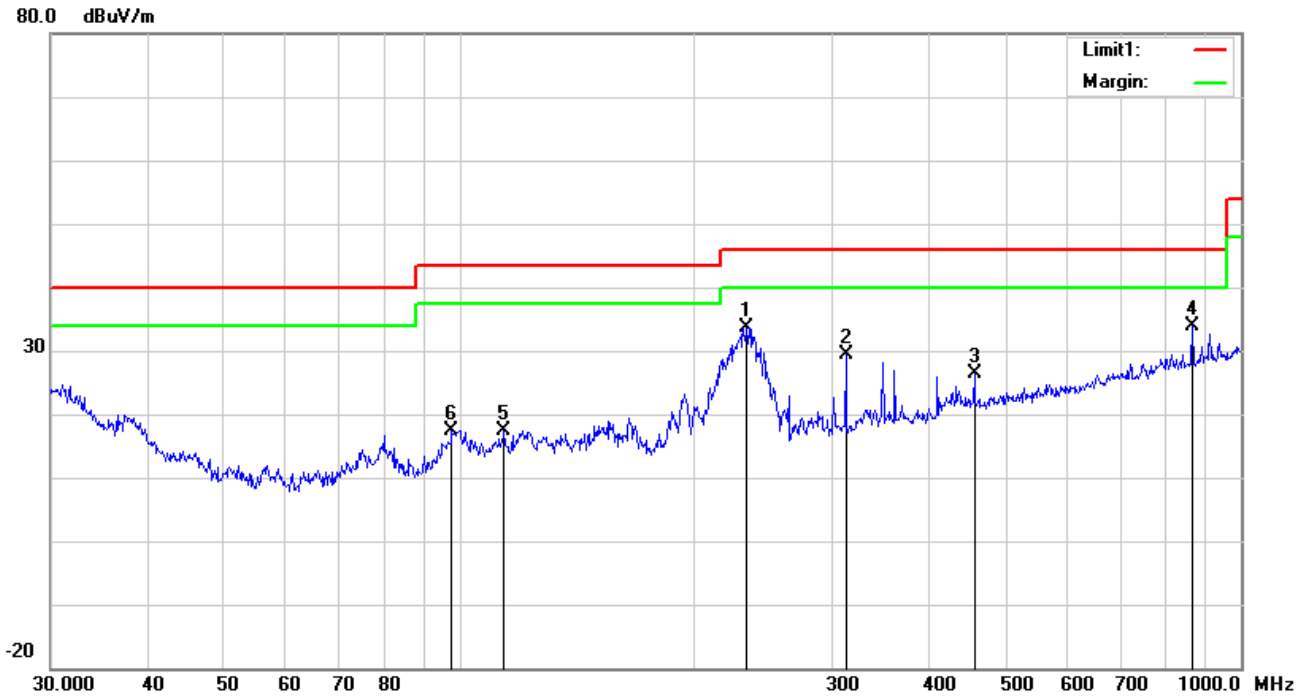

*Test Data*

### Horizontal Polarity Plot @3m

N o.	P/ L	Frequency (MHz)	Reading (dBuV/m )	Detect or	Ant_F (dB/m)	PA_G (dB)	Cab_ L (dB)	Result (dBuV/m)	Limit (dBuV/m)	Margin (dB)	Height (cm)	Degr ee ( )
1	H	233.3487	42.79	peak	11.63	22.32	1.65	33.75	46.00	-12.25	200	60
2	H	312.1794	35.85	peak	13.86	22.26	1.85	29.30	46.00	-16.70	100	264
3	H	455.9058	29.20	peak	16.82	21.90	2.16	26.28	46.00	-19.72	100	141
4	H	866.0879	29.90	peak	22.13	20.97	2.93	33.99	46.00	-12.01	100	126
5	H	114.1138	25.79	peak	12.87	22.35	1.17	17.48	43.50	-26.02	100	244
6	H	97.7983	28.86	peak	9.87	22.32	1.06	17.47	43.50	-26.03	100	73

### Above 1GHz

<b>Test Mode:</b>	<b>Transmitting Mode</b>
-------------------	--------------------------

#### Low Channel (2412 MHz) (b mode worst case)

Frequency (MHz)	S.A. Reading (dB $\mu$ V)	Detector (PK/AV)	Polarity (H/V)	Ant. Factor (dB/m)	Cable Loss (dB)	Pre-Amp. Gain (dB)	Cord Amp. (dB $\mu$ V/m)	Limit (dB $\mu$ V/m)	Margin (dB)
4824	47.89	AV	V	33.39	7.22	48.46	40.04	54	-13.96
4824	44.46	AV	H	33.39	7.22	48.46	36.61	54	-17.39
4824	66.6	PK	V	33.39	7.22	48.46	58.75	74	-15.25
4824	67.76	PK	H	33.39	7.22	48.46	59.91	74	-14.09
12959	26.46	AV	V	40.71	12.44	46.56	33.05	54	-20.95
12959	25.54	AV	H	40.71	12.44	46.56	32.13	54	-21.87
12959	46.03	PK	V	40.71	12.44	46.56	52.62	74	-21.38
12959	45.01	PK	H	40.71	12.44	46.56	51.6	74	-22.4

#### Middle Channel (2437 MHz) (b mode worst case)

Frequency (MHz)	S.A. Reading (dB $\mu$ V)	Detector (PK/AV)	Polarity (H/V)	Ant. Factor (dB/m)	Cable Loss (dB)	Pre-Amp. Gain (dB)	Cord Amp. (dB $\mu$ V/m)	Limit (dB $\mu$ V/m)	Margin (dB)
4874	48.66	AV	V	33.62	7.53	48.36	41.45	54	-12.55
4874	46.57	AV	H	33.62	7.53	48.36	39.36	54	-14.64
4874	70.6	PK	V	33.62	7.53	48.36	63.39	74	-10.61
4874	63.96	PK	H	33.62	7.53	48.36	56.75	74	-17.25
8843	29.49	AV	V	37.8	9.97	47.56	29.7	54	-24.3
8843	30.26	AV	H	37.8	9.97	47.56	30.47	54	-23.53
8843	50.7	PK	V	37.8	9.97	47.56	50.91	74	-23.09
8843	49.29	PK	H	37.8	9.97	47.56	49.5	74	-24.5

**High Channel (2462 MHz) (b mode worst case)**

Frequency (MHz)	S.A. Reading (dB $\mu$ V)	Detector (PK/AV)	Polarity (H/V)	Ant. Factor (dB/m)	Cable Loss (dB)	Pre-Amp. Gain (dB)	Cord Amp. (dB $\mu$ V/m)	Limit (dB $\mu$ V/m)	Margin (dB)
4924	46.27	AV	V	33.74	7.78	48.34	39.45	54	-14.55
4924	49.28	AV	H	33.74	7.78	48.34	42.46	54	-11.54
4924	69.39	PK	V	33.74	7.78	48.34	62.57	74	-11.43
4924	67.36	PK	H	33.74	7.78	48.34	60.54	74	-13.46
17926	18.78	AV	V	42.17	17.71	45.95	32.71	54	-21.29
17926	19.63	AV	H	42.17	17.71	45.95	33.56	54	-20.44
17926	38.99	PK	V	42.17	17.71	45.95	52.92	74	-21.08
17926	40.35	PK	H	42.17	17.71	45.95	54.28	74	-19.72

**Note:**

- 1, The testing has been conformed to  $10 \times 2462 \text{MHz} = 24,620 \text{MHz}$
- 2, All other emissions more than 30 dB below the limit
- 3, X-Axis, Y-Axis and Z-Axis were investigated. The results above show only the worst case.
- 4, The radiated spurious test above 18GHz is subcontracted to SIEMIC (Nanjing-China) Laboratories. and found 30dB below the limit at least.

## Annex A. TEST INSTRUMENT

Instrument	Model	Serial #	Cal Date	Cal Due	In use
<b>AC Line Conducted</b>					
EMI test receiver	ESCS30	8471241027	09/15/2017	09/14/2018	<input checked="" type="checkbox"/>
Line Impedance	LI-125A	191106	09/23/2017	09/22/2018	<input checked="" type="checkbox"/>
Line Impedance	LI-125A	191107	09/23/2017	09/22/2018	<input checked="" type="checkbox"/>
ISN	ISN T800	34373	09/23/2017	09/22/2018	<input type="checkbox"/>
Transient Limiter	LIT-153	531118	08/30/2017	08/29/2018	<input type="checkbox"/>
<b>RF conducted test</b>					
Agilent ESA-E SERIES	E4407B	MY45108319	09/15/2017	09/14/2018	<input checked="" type="checkbox"/>
Power Splitter	1#	1#	08/30/2017	08/29/2018	<input checked="" type="checkbox"/>
DC Power Supply	E3640A	MY40004013	09/15/2017	09/14/2018	<input checked="" type="checkbox"/>
<b>Radiated Emissions</b>					
EMI test receiver	ESL6	100262	09/15/2017	09/14/2018	<input checked="" type="checkbox"/>
Positioning Controller	UC3000	MF780208282	11/17/2017	11/16/2018	<input checked="" type="checkbox"/>
OPT 010 AMPLIFIER (0.1-1300MHz)	8447E	2727A02430	08/30/2017	08/29/2018	<input checked="" type="checkbox"/>
Microwave Preamplifier (1 ~ 26.5GHz)	8449B	3008A02402	03/23/2017	03/22/2018	<input checked="" type="checkbox"/>
Horn Antenna	BBHA9170	3145226D1	09/27/2017	09/26/2018	<input checked="" type="checkbox"/>
Active Antenna (9kHz-30MHz)	AL-130	121031	10/12/2017	10/11/2018	<input checked="" type="checkbox"/>
Bilog Antenna (30MHz~6GHz)	JB6	A110712	09/19/2017	09/18/2018	<input checked="" type="checkbox"/>
Double Ridge Horn Antenna (1 ~18GHz)	AH-118	71283	09/22/2017	09/21/2018	<input checked="" type="checkbox"/>
Universal Radio Communication Tester	CMU200	121393	09/23/2017	09/22/2018	<input checked="" type="checkbox"/>

## Annex B. EUT and Test Setup Photographs

### Annex B.i. Photograph: EUT External Photo

Whole Package View



Adapter View

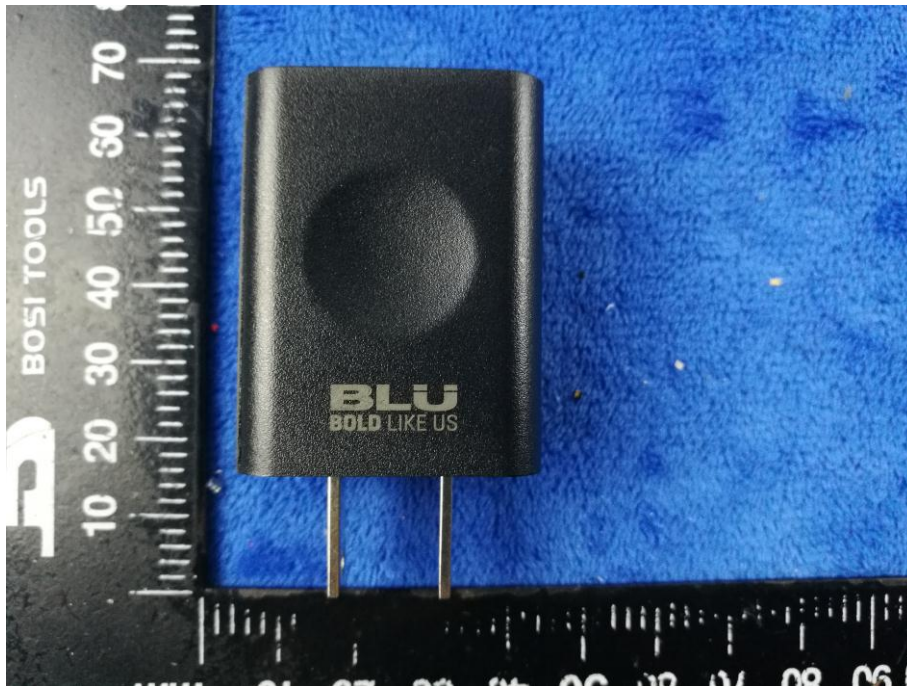

Label View

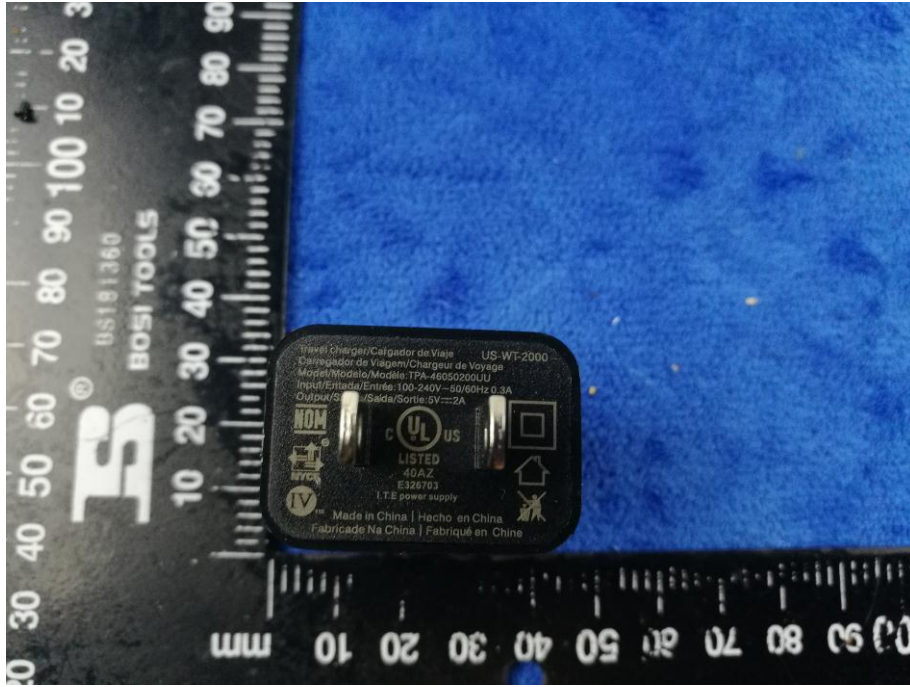

EUT - Front View





EUT - Rear View



EUT - Top View

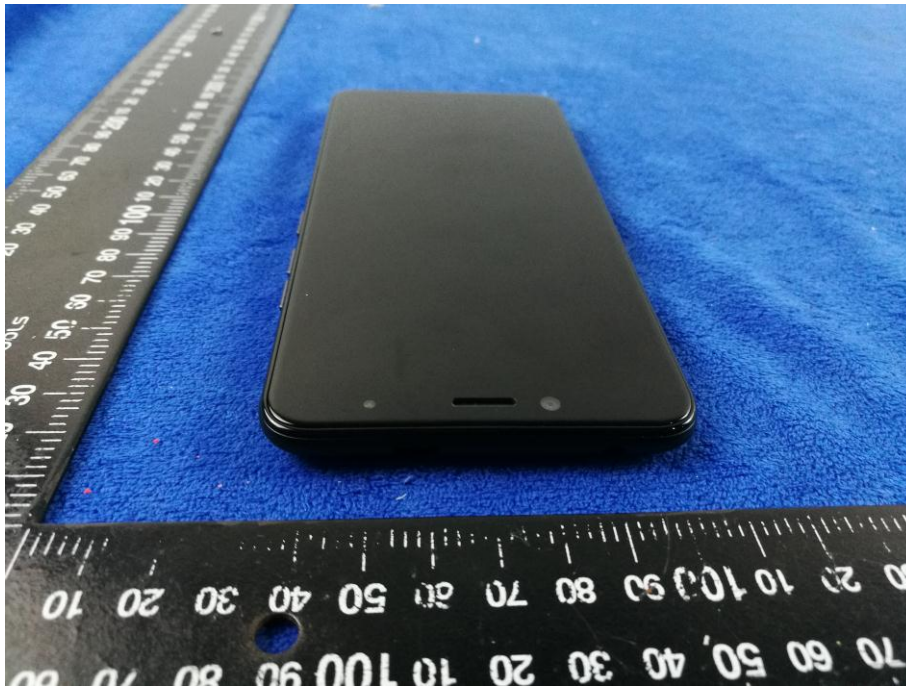

EUT - Bottom View

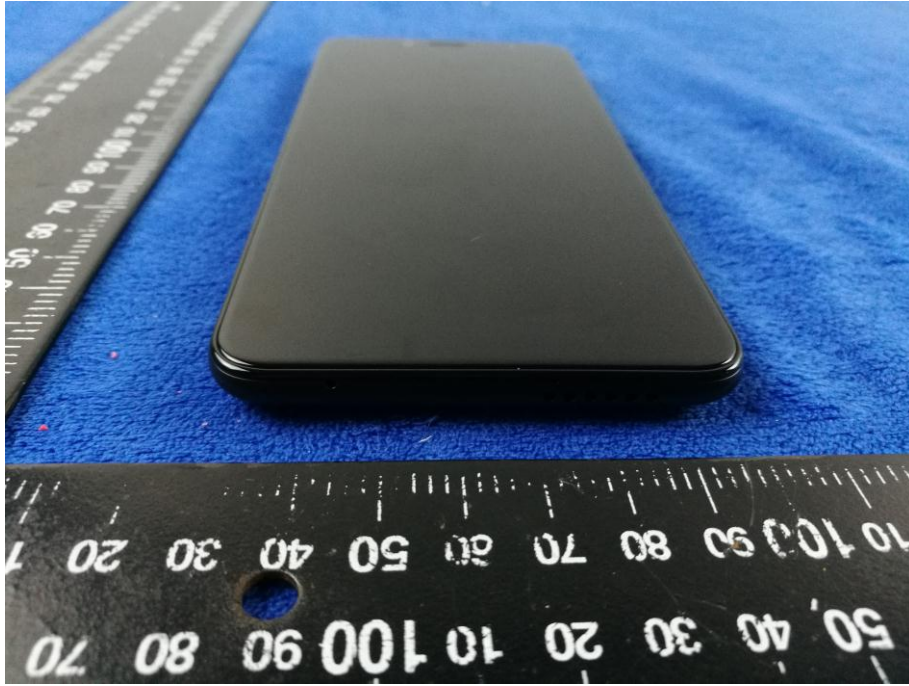

EUT - Left View

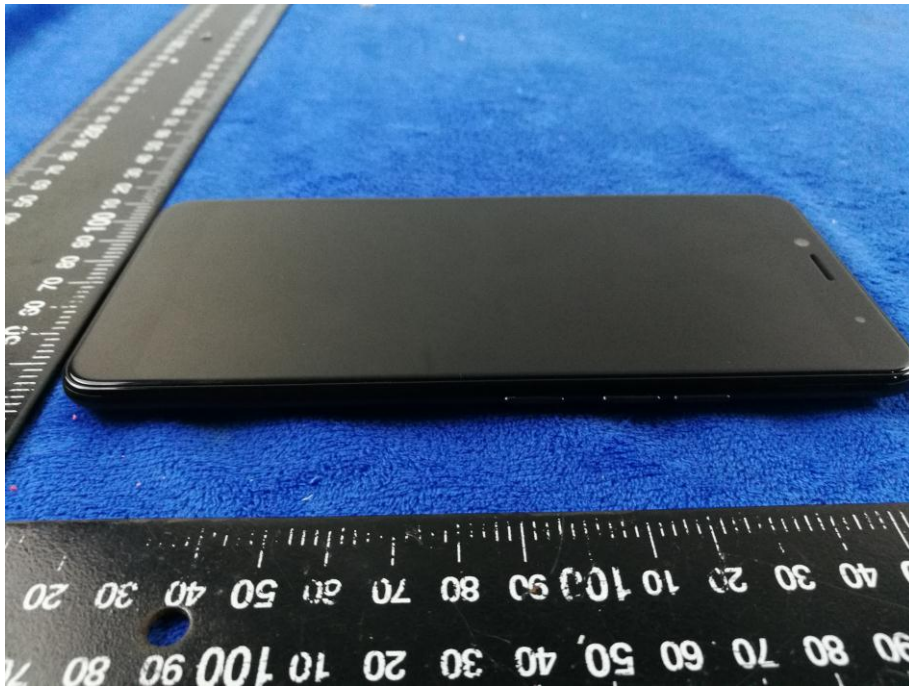

Test Report No.	18070046-FCC-R2
Page	51 of 66

EUT - Right View

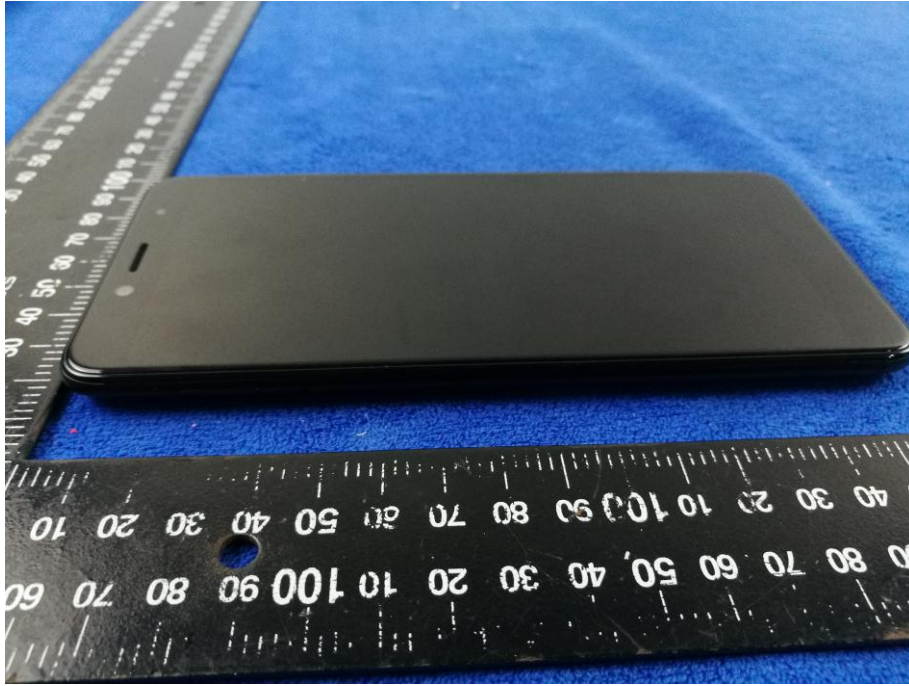

**Annex B.ii. Photograph: EUT Internal Photo**

Cover Off - Top View 1



Cover Off - Top View 2



Battery - Front View



Battery - Rear View



Mainboard with Shielding - Front View

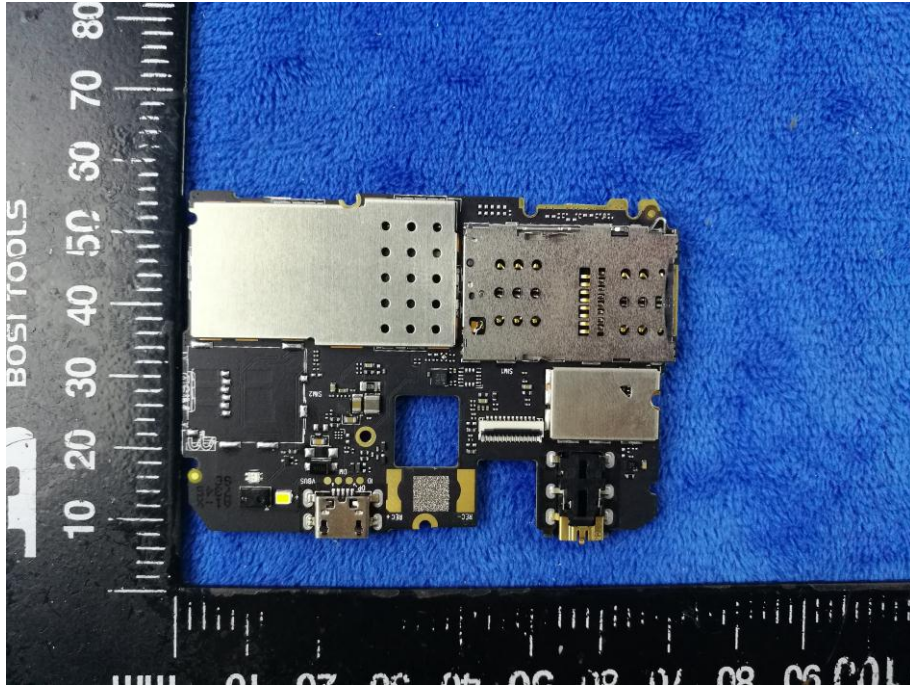

Mainboard with Shielding - Rear View



Mainboard without Shielding - Front View

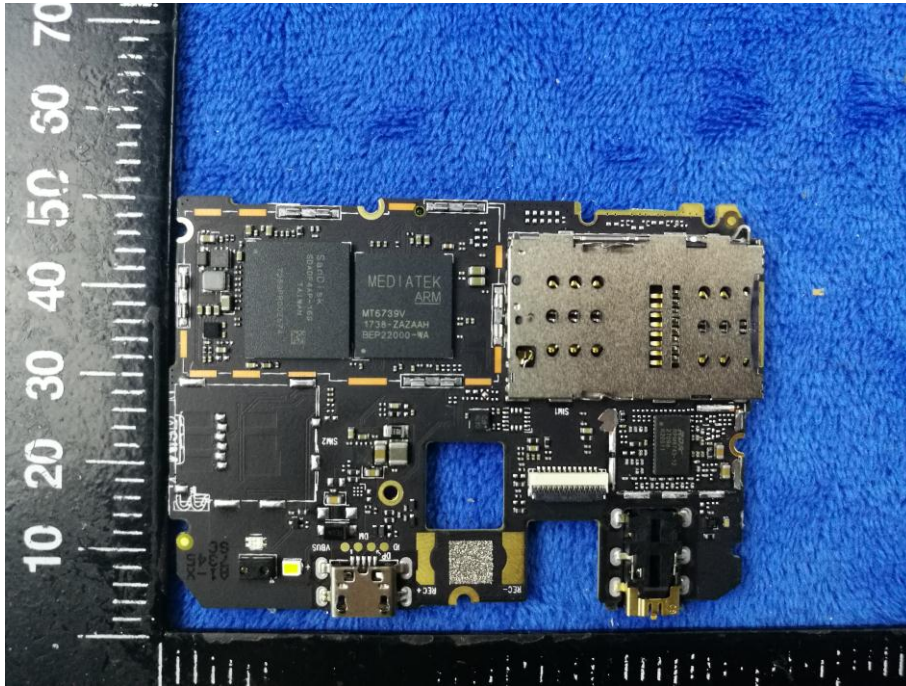

Mainboard without Shielding - Rear View

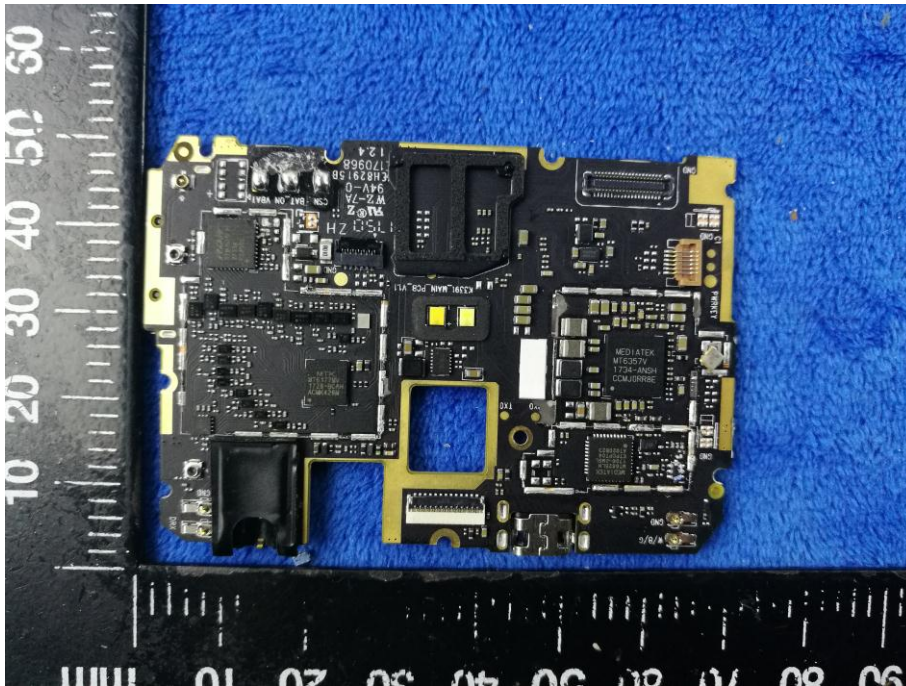

Smallboard – Front View

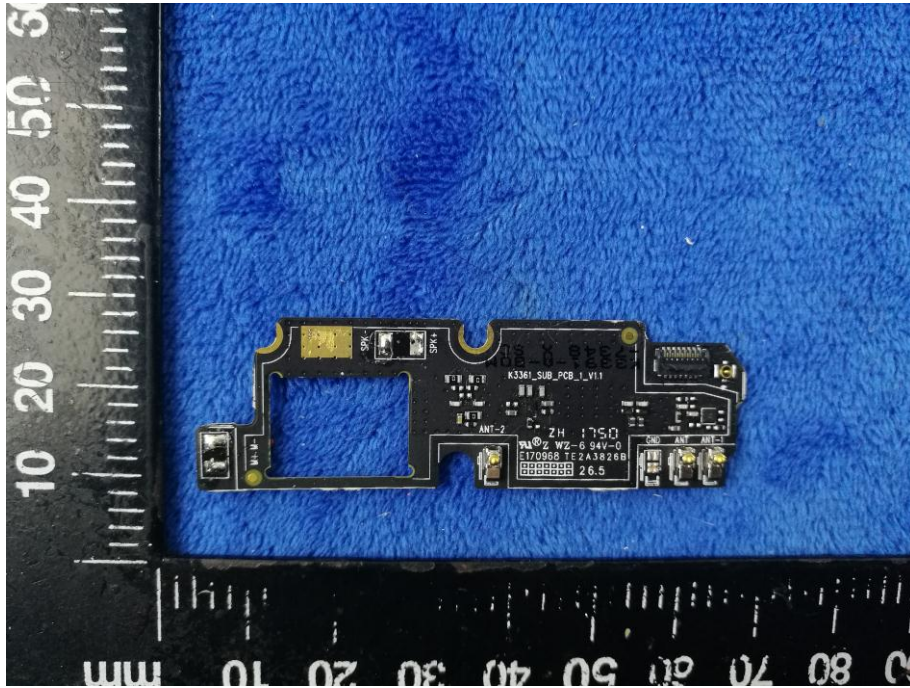

Smallboard – Rear View

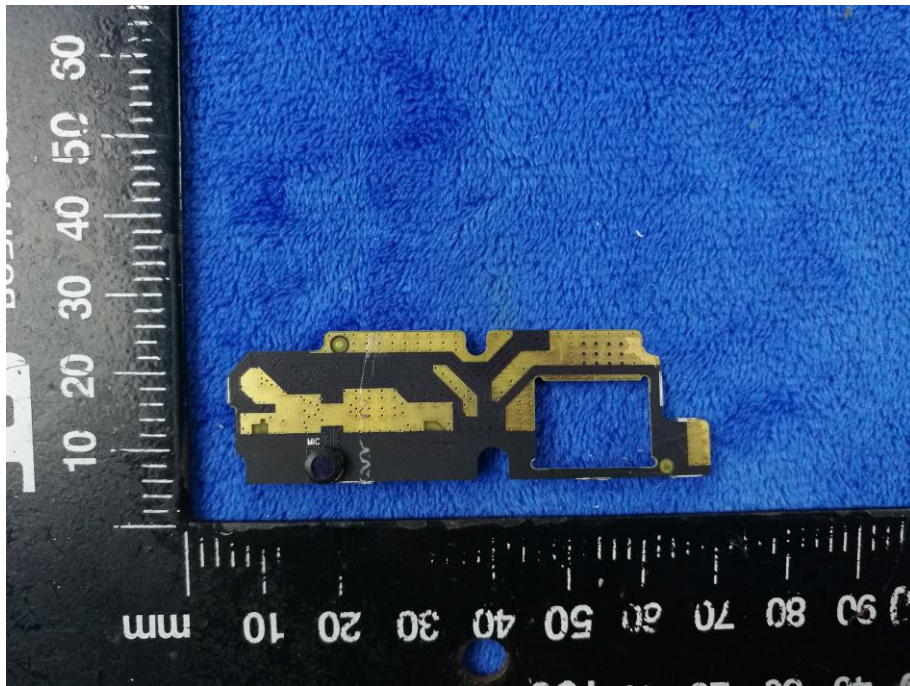



LCD – Front View

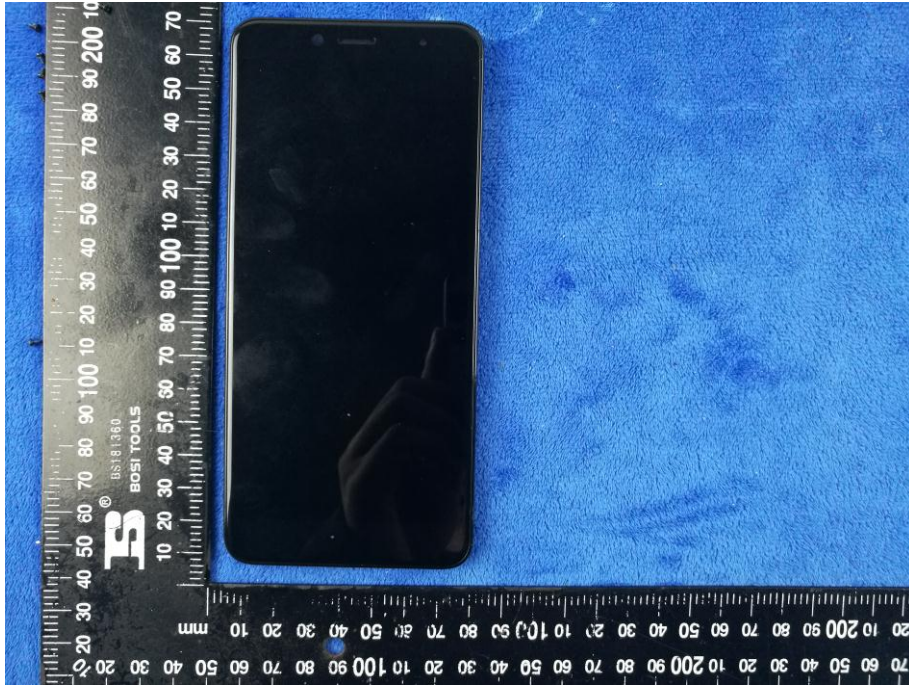

LCD – Rear View



GSM/PCS/UMTS-FDD/LTE Antenna View



WIFI/BT/BLE/GPS - Antenna View



RXD- Antenna View



**Annex B.iii. Photograph: Test Setup Photo**

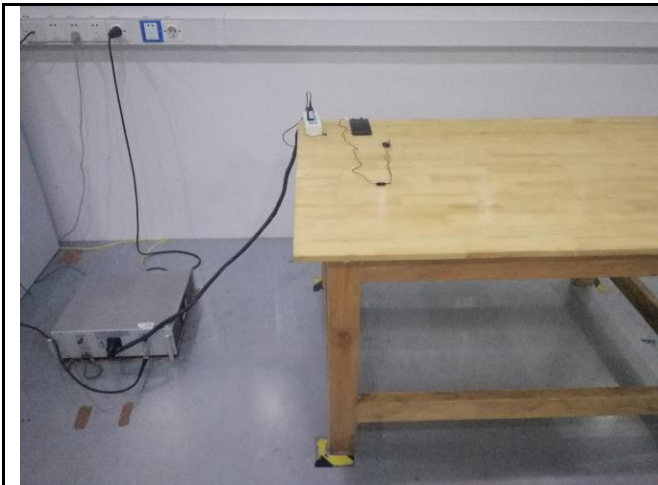

Conducted Emissions Test Setup Front View



Conducted Emissions Test Setup Side View

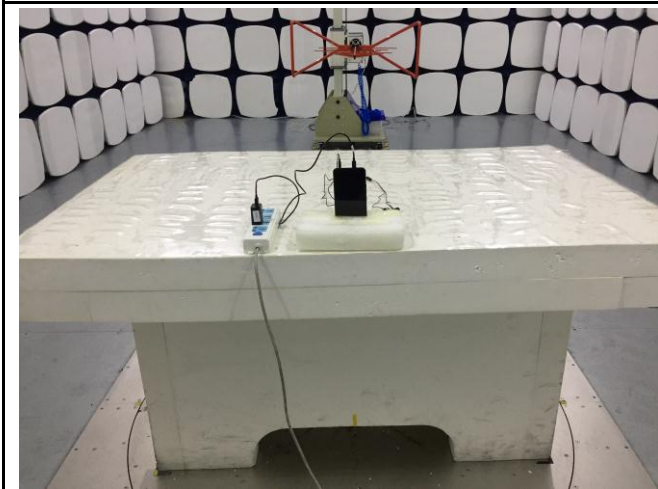

Radiated Spurious Emissions Test Setup Below 1GHz



Radiated Spurious Emissions Test Setup Above  
1GHz

## Annex C. TEST SETUP AND SUPPORTING EQUIPMENT

### Annex C.ii. TEST SET UP BLOCK

#### Block Configuration Diagram for AC Line Conducted Emissions

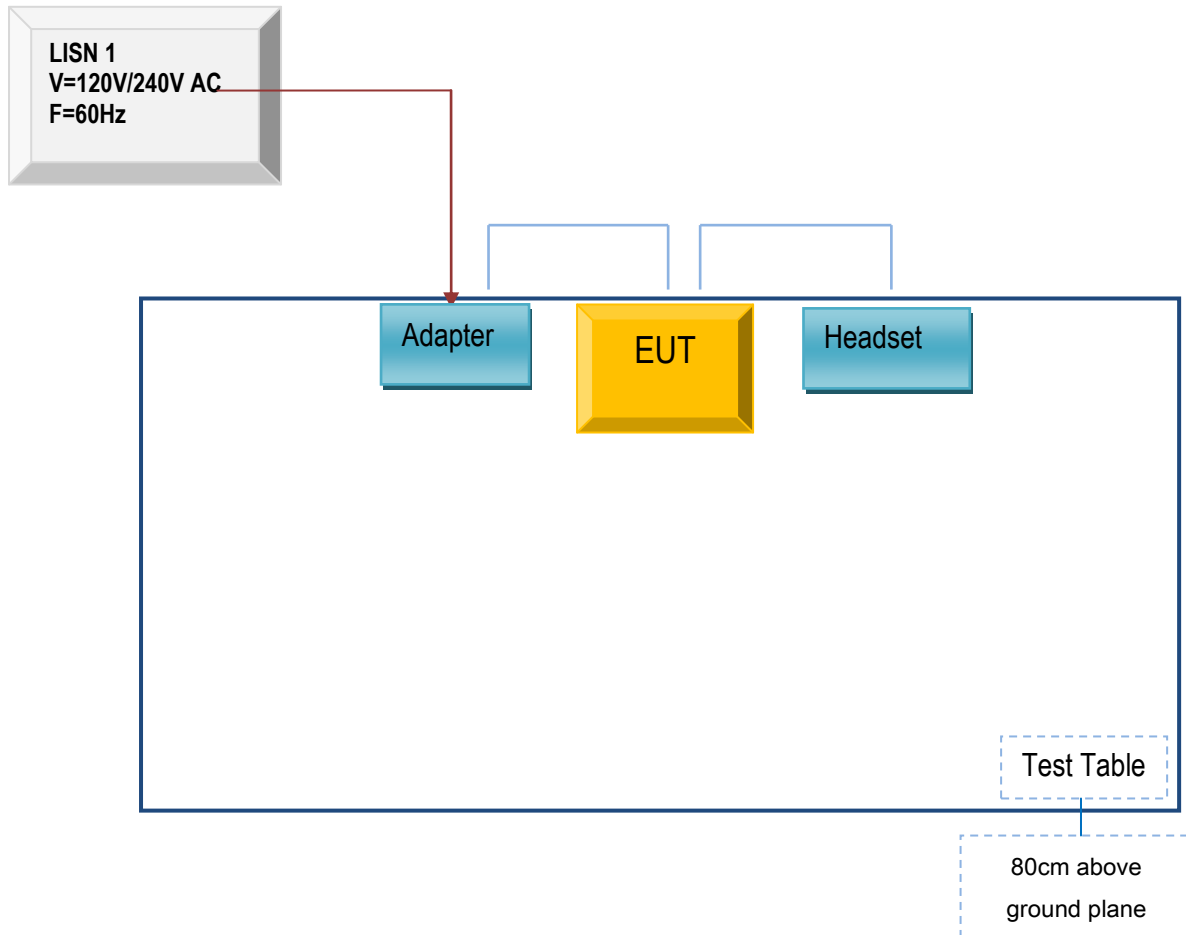

**Block Configuration Diagram for Radiated Emissions ( Below 1GHz ) .**

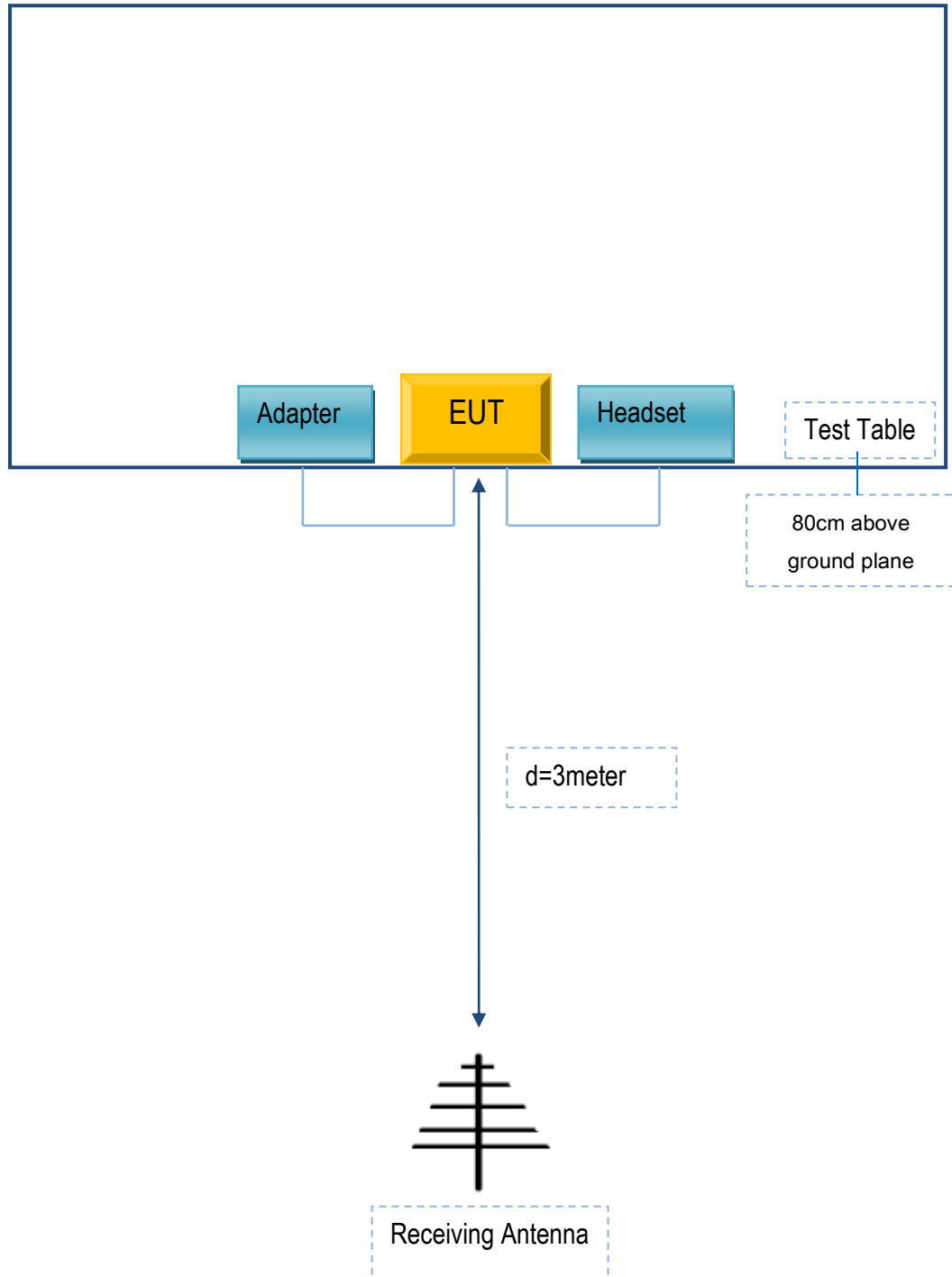

**Block Configuration Diagram for Radiated Emissions ( Above 1GHz ) .**

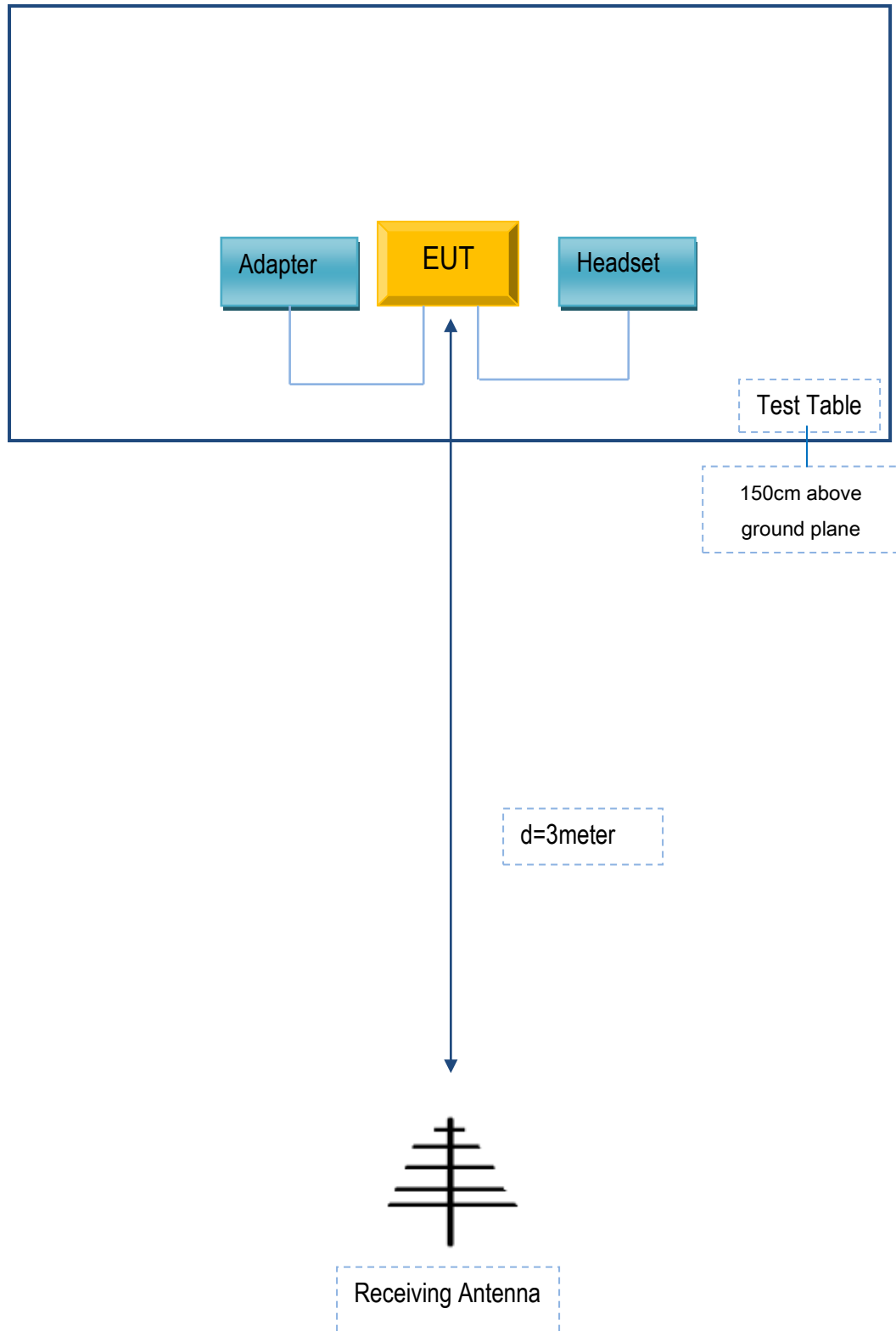

## Annex C. ii. SUPPORTING EQUIPMENT DESCRIPTION

The following is a description of supporting equipment and details of cables used with the EUT.

### Supporting Equipment:

Manufacturer	Equipment Description	Model	Serial No
BLU Products, Inc	Adapter	TPA-46050200UU	N/A
BLU Products, Inc	headset	VIVO ONE PLUS	N/A

### Supporting Cable:

Cable type	Shield Type	Ferrite Core	Length	Serial No
USB Cable	Un-shielding	No	0.8m	N/A



Test Report No.	18070046-FCC-R2
Page	65 of 66

## Annex D. User Manual / Block Diagram / Schematics / Partlist

Please see the attachment

Test Report No.	18070046-FCC-R2
Page	66 of 66

## Annex E. DECLARATION OF SIMILARITY

N/A