



FCC RF Test Report

APPLICANT : BLU Products, Inc.
EQUIPMENT : Mobile Phone
BRAND NAME : BLU
MODEL NAME : VIVO XI+
FCC ID : YHLBLUVIVOXIP
STANDARD : 47 CFR Part 2, 22(H), 24(E), 27(L), 27(M), 27(F), 27(H)
CLASSIFICATION : PCS Licensed Transmitter Held to Ear (PCE)

The product was received on May 31, 2018 and completely tested on Jun. 08, 2018. We, Sporton International (Shenzhen) Inc., would like to declare that the tested sample has been evaluated in accordance with the procedures given in ANSI C63.26-2015 and shown compliance with the applicable technical standards.

The test results in this report apply exclusively to the tested model / sample. Without written approval of Sporton International (Shenzhen) Inc., the test report shall not be reproduced except in full.



Approved by: Eric Shih / Manager

Sporton International (Shenzhen) Inc.

**1/F, 2/F, Bldg 5, Shiling Industrial Zone, Xinwei Village, Xili, Nanshan Shenzhen City
Guangdong Province 518055 China**



TABLE OF CONTENTS

REVISION HISTORY..... 3
SUMMARY OF TEST RESULT 4
1 GENERAL DESCRIPTION 6
1.1 Applicant 6
1.2 Manufacturer 6
1.3 Product Feature of Equipment Under Test..... 6
1.4 Product Specification of Equipment Under Test..... 7
1.5 Modification of EUT 7
1.6 Maximum ERP/EIRP Power, Frequency Tolerance, and Emission Designator 8
1.7 Testing Location 10
1.8 Applicable Standards..... 10
2 TEST CONFIGURATION OF EQUIPMENT UNDER TEST 11
2.1 Test Mode 11
2.2 Connection Diagram of Test System 15
2.3 Support Unit used in test configuration and system 15
2.4 Measurement Results Explanation Example 15
2.5 Frequency List of Low/Middle/High Channels 16
3 CONDUCTED TEST ITEMS 20
3.1 Measuring Instruments 20
3.2 Test Setup 20
3.3 Test Result of Conducted Test 20
3.4 Conducted Output Power and ERP/EIRP 21
3.5 Peak-to-Average Ratio 22
3.6 Occupied Bandwidth 23
3.7 Conducted Band Edge 24
3.8 Conducted Spurious Emission 26
3.9 Frequency Stability 27
4 RADIATED TEST ITEMS 28
4.1 Measuring Instruments 28
4.2 Test Setup 28
4.3 Test Result of Radiated Test 28
4.4 Radiated Spurious Emission 29
5 LIST OF MEASURING EQUIPMENT 30
6 UNCERTAINTY OF EVALUATION 31
APPENDIX A. TEST RESULTS OF CONDUCTED TEST
APPENDIX B. TEST RESULTS OF RADIATED TEST
APPENDIX C. TEST SETUP PHOTOGRAPHS



SUMMARY OF TEST RESULT

Report Section	FCC Rule	Description	Limit	Result	Remark
3.4	§2.1046	Conducted Output Power	Reporting Only	PASS	-
	§22.913(a)(5)	Effective Radiated Power (Band 5)	ERP < 7 Watt	PASS	-
	§27.50(b)(10) §27.50(c)(10)	Effective Radiated Power (Band 12) (Band 13) (Band 17)	ERP < 3 Watt	PASS	-
	§24.232(c) §27.50(h)(2)	Equivalent Isotropic Radiated Power (Band 2) (Band 7)	EIRP < 2Watt	PASS	-
	§27.50(d)(4)	Equivalent Isotropic Radiated Power (Band 4) (Band 66)	EIRP < 1Watt	PASS	-
3.5	§24.232(d)	Peak-to-Average Ratio	<13 dB	PASS	-
3.6	§2.1049	Occupied Bandwidth	Reporting Only	PASS	-
3.7	§2.1051 §22.917(a) §24.238(a) §27.53(c)(2)(4) §27.53(g) §27.53(h)	Conducted Band Edge Measurement (Band 2) (Band 4) (Band 5) (Band 12) (Band 13) (Band 17) (Band 66)	< 43+10log ₁₀ (P[Watts])	PASS	-
	§27.53(m)(4)	Conducted Band Edge Measurement (Band 7)	§27.53(m)(4)		
3.8	§2.1051 §22.917(a) §24.238(a) §27.53(c)(2) §27.53(g) §27.53(h)	Conducted Spurious Emission (Band 2) (Band 4) (Band 5) (Band 12) (Band 13) (Band 17) (Band 66)	< 43+10log ₁₀ (P[Watts])	PASS	-
	§2.1051 §27.53(m)(4)	Conducted Spurious Emission (Band 7)	< 55+10log ₁₀ (P[Watts])		
3.9	§2.1055 §22.355	Frequency Stability Temperature & Voltage	< 2.5 ppm for Part 22H	PASS	-
	§2.1055 §24.235 §27.54		Within Authorized Band		



Report Section	FCC Rule	Description	Limit	Result	Remark
4.4	§2.1053 §22.917(a) §24.238(a) §27.53(c)(2) §27.53(f) §27.53(g) §27.53(h)	Radiated Spurious Emission (Band 2) (Band 4) (Band 5) (Band 12) (Band 13) (Band 17) (Band 66)	$< 43+10\log_{10}(P[\text{Watts}])$	PASS	Under limit 8.61 dB at 7585.02 MHz
	§2.1053 §27.53(m)(4)	Radiated Spurious Emission (Band 7)	$< 55+10\log_{10}(P[\text{Watts}])$		



1 General Description

1.1 Applicant

BLU Products, Inc.
10814 NW 33rd St # 100 Doral, FL 33172, USA

1.2 Manufacturer

BLU Products, Inc.
10814 NW 33rd St # 100 Doral, FL 33172, USA

1.3 Product Feature of Equipment Under Test

Product Feature	
Equipment	Mobile Phone
Brand Name	BLU
Model Name	VIVO XI+
FCC ID	YHLBLUVIVOXIP
EUT supports Radios application	GSM/GPRS/EGPRS/WCDMA/HSPA/HSPA+/DC-HSDPA/LTE WLAN2.4GHz 802.11b/g/n HT20/HT40 Bluetooth BR/EDR/LE
IMEI Code	Conducted: 354147042328444/354147042378449 Radiation: 354147042328469/354147042378464
HW Version	Vivo XI+_Mainboard_P3
SW Version	Vivo XI+_2307
EUT Stage	Identical Prototype



1.4 Product Specification of Equipment Under Test

Standards-related Product Specification	
Tx Frequency	LTE Band 2 : 1850.7 MHz ~ 1909.3 MHz LTE Band 4 : 1710.7 MHz ~ 1754.3 MHz LTE Band 5 : 824.7 MHz ~ 848.3 MHz LTE Band 7 : 2502.5 MHz ~ 2567.5 MHz LTE Band 12 : 699.7 MHz ~ 715.3 MHz LTE Band 13 : 779.5 MHz ~ 784.5 MHz LTE Band 17 : 706.5 MHz ~ 713.5 MHz LTE Band 66 : 1710.7 MHz ~ 1779.3 MHz
Rx Frequency	LTE Band 2 : 1930.7 MHz ~ 1989.3 MHz LTE Band 4 : 2110.7 MHz ~ 2154.3 MHz LTE Band 5 : 869.7 MHz ~ 893.3 MHz LTE Band 7 : 2622.5MHz ~ 2687.5 MHz LTE Band 12 : 729.7 MHz ~ 745.3 MHz LTE Band 13 : 748.5 MHz ~ 753.5 MHz LTE Band 17 : 736.5 MHz ~ 743.5 MHz LTE Band 66 : 2110.7 MHz~ 2199.3 MHz
Bandwidth	LTE Band 2 : 1.4MHz / 3MHz / 5MHz / 10MHz / 15MHz / 20MHz LTE Band 4 : 1.4MHz / 3MHz / 5MHz / 10MHz / 15MHz / 20MHz LTE Band 5 : 1.4MHz / 3MHz / 5MHz / 10MHz LTE Band 7 : 5MHz/ 10MHz / 15MHz / 20MHz LTE Band 12 : 1.4MHz / 3MHz / 5MHz / 10MHz LTE Band 13 : 5MHz / 10MHz LTE Band 17 : 5MHz / 10MHz LTE Band 66 : 1.4MHz / 3MHz / 5MHz / 10MHz / 15MHz / 20MHz
Maximum Output Power to Antenna	LTE Band 2 : 23.06 dBm LTE Band 4 : 23.37 dBm LTE Band 5 : 23.19 dBm LTE Band 7 : 23.61 dBm LTE Band 12 : 23.43 dBm LTE Band 13 : 23.48 dBm LTE Band 17 : 23.42 dBm LTE Band 66 : 23.29 dBm
Antenna Gain	LTE Band 2 : -0.25 dBi LTE Band 4 : -0.27 dBi LTE Band 5 : -1.36 dBi LTE Band 7 : 0.70 dBi LTE Band 12 : -2.30 dBi LTE Band 13 : -2.28 dBi LTE Band 17 : -2.30 dBi LTE Band 66 : -0.39 dBi
Type of Modulation	QPSK / 16QAM

1.5 Modification of EUT

No modifications are made to the EUT during all test items.



1.6 Maximum ERP/EIRP Power, Frequency Tolerance, and Emission Designator

LTE Band 2		QPSK			16QAM		
BW (MHz)	Frequency Range (MHz)	Emission Designator (99%OBW)	Frequency Tolerance (ppm)	Maximum EIRP(W)	Emission Designator (99%OBW)	Frequency Tolerance (ppm)	Maximum EIRP(W)
1.4	1850.7 ~ 1909.3	1M09G7D	-	0.1897	1M10W7D	-	0.1596
3	1851.5 ~ 1908.5	2M73G7D	-	0.1905	2M73W7D	-	0.1633
5	1852.5 ~ 1907.5	4M51G7D	-	0.1905	4M52W7D	-	0.1618
10	1855.0 ~ 1905.0	9M09G7D	0.0151	0.1888	9M07W7D	-	0.1596
15	1857.5 ~ 1902.5	13M6G7D	-	0.1905	13M5W7D	-	0.1644
20	1860.0 ~ 1900.0	18M4G7D	-	0.1910	18M5W7D	-	0.1607
LTE Band 4		QPSK			16QAM		
BW (MHz)	Frequency Range (MHz)	Emission Designator (99%OBW)	Frequency Tolerance (ppm)	Maximum EIRP(W)	Emission Designator (99%OBW)	Frequency Tolerance (ppm)	Maximum EIRP(W)
1.4	1710.7 ~ 1754.3	1M09G7D	-	0.1977	1M09W7D	-	0.1663
3	1711.5 ~ 1753.5	2M71G7D	-	0.2009	2M71W7D	-	0.1667
5	1712.5 ~ 1752.5	4M51G7D	-	0.2028	4M51W7D	-	0.1663
10	1715.0 ~ 1750.0	9M09G7D	0.0013	0.1995	9M05W7D	-	0.1663
15	1717.5 ~ 1747.5	13M5G7D	-	0.2032	13M5W7D	-	0.1667
20	1720.0 ~ 1745.0	18M4G7D	-	0.2042	18M4W7D	-	0.1663
LTE Band 5		QPSK			16QAM		
BW (MHz)	Frequency Range (MHz)	Emission Designator (99%OBW)	Frequency Tolerance (ppm)	Maximum ERP(W)	Emission Designator (99%OBW)	Frequency Tolerance (ppm)	Maximum ERP(W)
1.4	824.7 ~ 848.3	1M09G7D	-	0.0910	1M10W7D	-	0.0787
3	825.5 ~ 847.5	2M71G7D	-	0.0927	2M70W7D	-	0.0787
5	826.5 ~ 846.5	4M51G7D	-	0.0920	4M52W7D	-	0.0789
10	829.0 ~ 844.0	9M09G7D	0.0013	0.0929	9M05W7D	-	0.0769
LTE Band 7		QPSK			16QAM		
BW (MHz)	Frequency Range (MHz)	Emission Designator (99%OBW)	Frequency Tolerance (ppm)	Maximum EIRP(W)	Emission Designator (99%OBW)	Frequency Tolerance (ppm)	Maximum EIRP(W)
5	2502.5 ~ 2567.5	4M52G7D	-	0.2679	4M52W7D	-	0.2213
10	2505.0 ~ 2565.0	9M07G7D	0.0109	0.2553	9M07W7D	-	0.2203
15	2507.5 ~ 2562.5	13M5G7D	-	0.2692	13M5W7D	-	0.2249
20	2510.0 ~ 2560.0	18M5G7D	-	0.2698	18M6W7D	-	0.2208



LTE Band 12		QPSK			16QAM		
BW (MHz)	Frequency Range (MHz)	Emission Designator (99%OBW)	Frequency Tolerance (ppm)	Maximum ERP(W)	Emission Designator (99%OBW)	Frequency Tolerance (ppm)	Maximum ERP(W)
1.4	699.7 ~ 715.3	1M09G7D	-	0.0782	1M10W7D	-	0.0659
3	700.5 ~ 714.5	2M72G7D	-	0.0785	2M72W7D	-	0.0667
5	701.5 ~ 713.5	4M51G7D	-	0.0787	4M51W7D	-	0.0673
10	704.0 ~ 711.0	9M07G7D	0.0020	0.0791	9M05W7D	-	0.0662
LTE Band 13		QPSK			16QAM		
BW (MHz)	Frequency Range (MHz)	Emission Designator (99%OBW)	Frequency Tolerance (ppm)	Maximum ERP(W)	Emission Designator (99%OBW)	Frequency Tolerance (ppm)	Maximum ERP(W)
5	779.5 ~ 784.5	4M53G7D	-	0.0802	4M51W7D	-	0.0692
10	782.0	9M07G7D	0.0019	0.0804	9M01W7D	-	0.0678
LTE Band 17		QPSK			16QAM		
BW (MHz)	Frequency Range (MHz)	Emission Designator (99%OBW)	Frequency Tolerance (ppm)	Maximum ERP(W)	Emission Designator (99%OBW)	Frequency Tolerance (ppm)	Maximum ERP(W)
5	706.5 ~ 713.5	4M53G7D	-	0.0787	4M51W7D	-	0.0671
10	709.0 ~ 711.0	9M09G7D	0.0042	0.0789	9M03W7D	-	0.0658
LTE Band 66		QPSK			16QAM		
BW (MHz)	Frequency Range (MHz)	Emission Designator (99%OBW)	Frequency Tolerance (ppm)	Maximum EIRP(W)	Emission Designator (99%OBW)	Frequency Tolerance (ppm)	Maximum EIRP(W)
1.4	1710.7 ~ 1779.3	1M09G7D	-	0.1941	1M09W7D	-	0.1626
3	1711.5 ~ 1778.5	2M72G7D	-	0.1945	2M70W7D	-	0.1622
5	1712.5 ~ 1777.5	4M51G7D	-	0.1941	4M50W7D	-	0.1618
10	1715.0 ~ 1775.0	9M05G7D	0.0070	0.1941	9M03W7D	-	0.1618
15	1717.5 ~ 1772.5	13M5G7D	-	0.1941	13M5W7D	-	0.1618
20	1720.0 ~ 1770.0	18M4G7D	-	0.1950	18M5W7D	-	0.1603



1.7 Testing Location

Sporton International (Shenzhen) Inc. is accredited to ISO 17025 by National Voluntary Laboratory Accreditation Program (NVLAP code: 600156-0) and the FCC designation No. are CN5018 and CN5019.

Test Site	Sporton International (Shenzhen) Inc.	
Test Site Location	1/F, 2/F, Bldg 5, Shiling Industrial Zone, Xinwei Village, Xili, Nanshan Shenzhen City Guangdong Province 518055 China TEL: +86-755-8637-9589 FAX: +86-755-8637-9595	
Test Site No.	Sporton Site No.	FCC Test Firm Registration No.
	TH01-SZ	251365

Test Site	Sporton International (Shenzhen) Inc.	
Test Site Location	No. 3 Bldg the third floor of south, Shahe River west, Fengzeyuan Warehouse, Nanshan District Shenzhen City Guangdong Province 518055 China TEL: +86-755-3320-2398	
Test Site No.	Sporton Site No.	FCC Test Firm Registration No.
	03CH01-SZ 03CH03-SZ	577730

Note: The test site complies with ANSI C63.4 2014 requirement.

1.8 Applicable Standards

According to the specifications of the manufacturer, the EUT must comply with the requirements of the following standards:

- 47 CFR Part 2, 22(H), 24(E), 27(L), 27(M), 27(F), 27(H)
- ANSI C63.26-2015
- FCC KDB 971168 D01 Power Meas License Digital Systems v03r01
- FCC KDB 412172 D01 Determining ERP and EIRP v01r01

Remark:

1. All test items were verified and recorded according to the standards and without any deviation during the test.
2. This EUT has also been tested and complied with the requirements of FCC Part 15, Subpart B, recorded in a separate test report.



2 Test Configuration of Equipment Under Test

2.1 Test Mode

Antenna port conducted and radiated test items listed below are performed according to KDB 971168 D01 Power Meas License Digital Systems v03r01 with maximum output power.

Radiated measurements are performed by rotating the EUT in three different orthogonal test planes to find the maximum emission.

Test Items	Band	Bandwidth (MHz)						Modulation		RB #			Test Channel		
		1.4	3	5	10	15	20	QPSK	16QAM	1	Half	Full	L	M	H
Max. Output Power	2	v	v	v	v	v	v	v	v	v	v	v	v	v	v
	4	v	v	v	v	v	v	v	v	v	v	v	v	v	v
	5	v	v	v	v	-	-	v	v	v	v	v	v	v	v
	7	-	-	v	v	v	v	v	v	v	v	v	v	v	v
	12	v	v	v	v	-	-	v	v	v	v	v	v	v	v
	13	-	-	v		-	-	v	v	v	v	v	v	v	v
	13	-	-		v	-	-	v	v	v	v	v		v	
	17	-	-	v	v	-	-	v	v	v	v	v	v	v	v
	66	v	v	v	v	v	v	v	v	v	v	v	v	v	v
Peak-to-Average Ratio	2						v	v	v	v		v	v	v	v
	4						v	v	v	v		v	v	v	v
	5				v	-	-	v	v	v		v	v	v	v
	7	-	-				v	v	v	v		v	v	v	v
	12				v	-	-	v	v	v		v	v	v	v
	13	-	-		v	-	-	v	v	v		v	v	v	v
	17	-	-		v	-	-	v	v	v		v	v	v	v
	66						v	v	v	v		v	v	v	v



Test Items	Band	Bandwidth (MHz)						Modulation		RB #			Test Channel		
		1.4	3	5	10	15	20	QPSK	16QAM	1	Half	Full	L	M	H
26dB and 99% Bandwidth	2	v	v	v	v	v	v	v	v			v	v	v	v
	4	v	v	v	v	v	v	v	v			v	v	v	v
	5	v	v	v	v	-	-	v	v			v	v	v	v
	7	-	-	v	v	v	v	v	v			v	v	v	v
	12	v	v	v	v	-	-	v	v			v	v	v	v
	13	-	-	v		-	-	v	v			v	v	v	v
	13	-	-		v	-	-	v	v			v		v	
	17	-	-	v	v	-	-	v	v			v	v	v	v
	66	v	v	v	v	v	v	v	v			v	v	v	v
Conducted Band Edge	2	v	v	v	v	v	v	v	v	v		v	v		v
	4	v	v	v	v	v	v	v	v	v		v	v		v
	5	v	v	v	v	-	-	v	v	v		v	v		v
	7	-	-	v	v	v	v	v	v	v		v	v		v
	12	v	v	v	v	-	-	v	v	v		v	v		v
	13	-	-	v		-	-	v	v	v		v	v		v
	13	-	-		v	-	-	v	v	v		v		v	
	17	-	-	v	v	-	-	v	v	v		v	v		v
	66	v	v	v	v	v	v	v	v	v		v	v		v



Test Items	Band	Bandwidth (MHz)						Modulation		RB #			Test Channel		
		1.4	3	5	10	15	20	QPSK	16QAM	1	Half	Full	L	M	H
Conducted Spurious Emission	2	v	v	v	v	v	v	v	v	v			v	v	v
	4	v	v	v	v	v	v	v	v	v			v	v	v
	5	v	v	v	v	-	-	v	v	v			v	v	v
	7	-	-	v	v	v	v	v	v	v			v	v	v
	12	v	v	v	v	-	-	v	v	v			v	v	v
	13	-	-	v		-	-	v	v	v			v	v	v
	13	-	-		v	-	-	v	v	v				v	
	17	-	-	v	v	-	-	v	v	v			v	v	v
	66	v	v	v	v	v	v	v	v	v			v	v	v
Frequency Stability	2				v			v				v		v	
	4				v			v				v		v	
	5				v	-	-	v				v		v	
	7	-	-		v			v				v		v	
	12				v	-	-	v				v		v	
	13	-	-		v	-	-	v				v		v	
	17	-	-		v	-	-	v				v		v	
	66				v			v				v		v	



Test Items	Band	Bandwidth (MHz)						Modulation		RB #			Test Channel		
		1.4	3	5	10	15	20	QPSK	16QAM	1	Half	Full	L	M	H
E.R.P./ E.I.R.P.	2	v	v	v	v	v	v	v	v	v			v	v	v
	4	v	v	v	v	v	v	v	v	v			v	v	v
	5	v	v	v	v	-	-	v	v	v			v	v	v
	7	-	-	v	v	v	v	v	v	v			v	v	v
	12	v	v	v	v	-	-	v	v	v			v	v	v
	13	-	-	v		-	-	v	v	v			v	v	v
	13	-	-		v	-	-	v	v	v				v	
	17	-	-	v	v	-	-	v	v	v			v	v	v
	66	v	v	v	v	v	v	v	v	v			v	v	v
Radiated Spurious Emission	2	v	v	v	v	v	v	v		v				v	
	4	v	v	v	v	v	v	v		v				v	
	5	v	v	v	v	-	-	v		v				v	
	7	-	-	v	v	v	v	v		v				v	
	12	v	v	v	v	-	-	v		v				v	
	13	-	-	v	v	-	-	v		v				v	
	17	-	-	v	v	-	-	v		v				v	
	66	v	v	v	v	v	v	v		v				v	
Note	<ol style="list-style-type: none"> The mark "v" means that this configuration is chosen for testing The mark "-" means that this bandwidth is not supported. The device is investigated from 30MHz to 10 times of fundamental signal for radiated spurious emission test under different RB size/offset and modulations in exploratory test. Subsequently, only the worst case emissions are reported. Wireless charging mode verify harmonic of worse case of adapter mode for RSE. 														

2.2 Connection Diagram of Test System

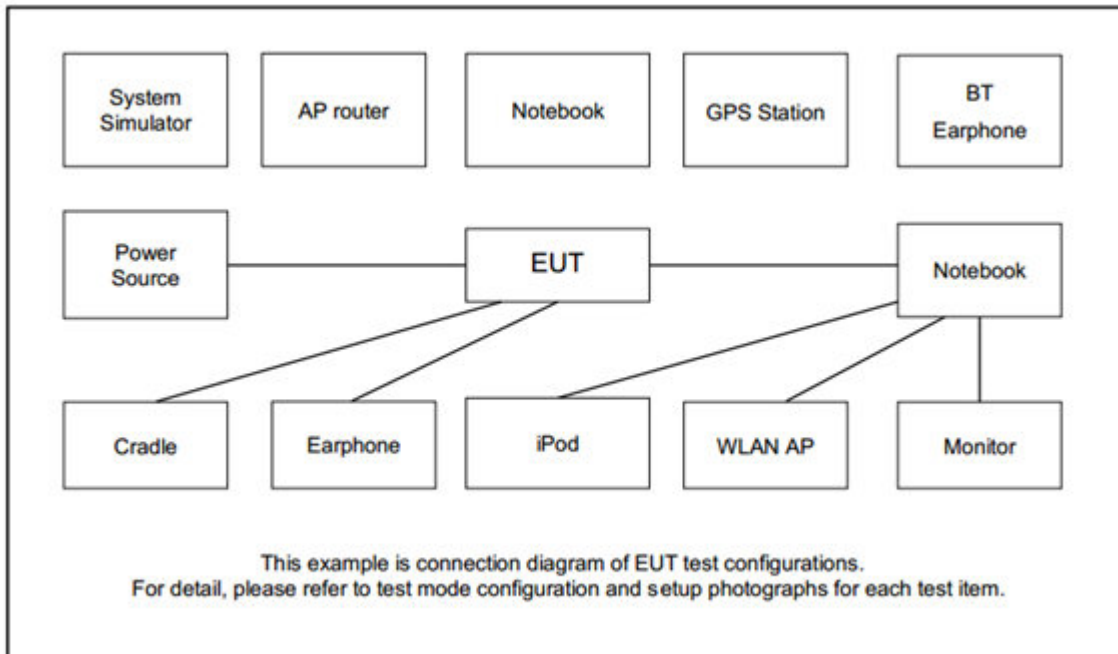

2.3 Support Unit used in test configuration and system

Item	Equipment	Trade Name	Model No.	FCC ID	Data Cable	Power Cord
1.	LTE Base Station	Anritsu	MT8820C	N/A	N/A	Unshielded, 1.8 m
2.	DC Power Supply	GW	GPS-3030D	N/A	N/A	Unshielded, 1.8 m
3.	wireless charger	Samsung	EP-NG930	N/A	N/A	N/A

2.4 Measurement Results Explanation Example

For all conducted test items:

The offset level is set in the spectrum analyzer to compensate the RF cable loss and attenuator factor between EUT conducted output port and spectrum analyzer. With the offset compensation, the spectrum analyzer reading level is exactly the EUT RF output level.

The spectrum analyzer offset is derived from RF cable loss and attenuator factor.

Offset = RF cable loss + attenuator factor.

Following shows an offset computation example with cable loss 4.5dB and 10dB attenuator.

Example :

$$\begin{aligned} \text{Offset(dB)} &= \text{RF cable loss(dB)} + \text{attenuator factor(dB)}. \\ &= 4.5 + 10 = 14.5(\text{dB}) \end{aligned}$$



2.5 Frequency List of Low/Middle/High Channels

LTE Band 2 Channel and Frequency List				
BW [MHz]	Channel/Frequency(MHz)	Lowest	Middle	Highest
20	Channel	18700	18900	19100
	Frequency	1860	1880	1900
15	Channel	18675	18900	19125
	Frequency	1857.5	1880	1902.5
10	Channel	18650	18900	19150
	Frequency	1855	1880	1905
5	Channel	18625	18900	19175
	Frequency	1852.5	1880	1907.5
3	Channel	18615	18900	19185
	Frequency	1851.5	1880	1908.5
1.4	Channel	18607	18900	19193
	Frequency	1850.7	1880	1909.3

LTE Band 4 Channel and Frequency List				
BW [MHz]	Channel/Frequency(MHz)	Lowest	Middle	Highest
20	Channel	20050	20175	20300
	Frequency	1720	1732.5	1745
15	Channel	20025	20175	20325
	Frequency	1717.5	1732.5	1747.5
10	Channel	20000	20175	20350
	Frequency	1715	1732.5	1750
5	Channel	19975	20175	20375
	Frequency	1712.5	1732.5	1752.5
3	Channel	19965	20175	20385
	Frequency	1711.5	1732.5	1753.5
1.4	Channel	19957	20175	20393
	Frequency	1710.7	1732.5	1754.3



LTE Band 5 Channel and Frequency List				
BW [MHz]	Channel/Frequency(MHz)	Lowest	Middle	Highest
10	Channel	20450	20525	20600
	Frequency	829	836.5	844
5	Channel	20425	20525	20625
	Frequency	826.5	836.5	846.5
3	Channel	20415	20525	20635
	Frequency	825.5	836.5	847.5
1.4	Channel	20407	20525	20643
	Frequency	824.7	836.5	848.3

LTE Band 7 Channel and Frequency List				
BW [MHz]	Channel/Frequency(MHz)	Lowest	Middle	Highest
20	Channel	20850	21100	21350
	Frequency	2510	2535	2560
15	Channel	20825	21100	21375
	Frequency	2507.5	2535	2562.5
10	Channel	20800	21100	21400
	Frequency	2505	2535	2565
5	Channel	20775	21100	21425
	Frequency	2502.5	2535	2567.5



LTE Band 12 Channel and Frequency List				
BW [MHz]	Channel/Frequency(MHz)	Lowest	Middle	Highest
10	Channel	23060	23095	23130
	Frequency	704	707.5	711
5	Channel	23035	23095	23155
	Frequency	701.5	707.5	713.5
3	Channel	23025	23095	23165
	Frequency	700.5	707.5	714.5
1.4	Channel	23017	23095	23173
	Frequency	699.7	707.5	715.3

LTE Band 13 Channel and Frequency List				
BW [MHz]	Channel/Frequency(MHz)	Lowest	Middle	Highest
10	Channel	-	23230	-
	Frequency	-	782	-
5	Channel	23205	23230	23255
	Frequency	779.5	782	784.5

LTE Band 17 Channel and Frequency List				
BW [MHz]	Channel/Frequency(MHz)	Lowest	Middle	Highest
10	Channel	23780	23790	23800
	Frequency	709	710	711
5	Channel	23755	23790	23825
	Frequency	706.5	710	713.5



LTE Band 66 Channel and Frequency List				
BW [MHz]	Channel/Frequency(MHz)	Lowest	Middle	Highest
20	Channel	132072	132322	132572
	Frequency	1720	1745	1770
15	Channel	132047	132322	132597
	Frequency	1717.5	1745	1772.5
10	Channel	132022	132322	132622
	Frequency	1715	1745	1775
5	Channel	131997	132322	132647
	Frequency	1712.5	1745	1777.5
3	Channel	131987	132322	132657
	Frequency	1711.5	1745	1778.5
1.4	Channel	131979	132322	132665
	Frequency	1710.7	1745	1779.3

3 Conducted Test Items

3.1 Measuring Instruments

See list of measuring instruments of this test report.

3.2 Test Setup

3.2.1 Conducted Output Power

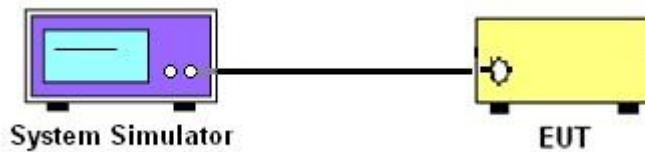

3.2.2 Peak-to-Average Ratio, Occupied Bandwidth ,Conducted Band-Edge and Conducted Spurious Emission

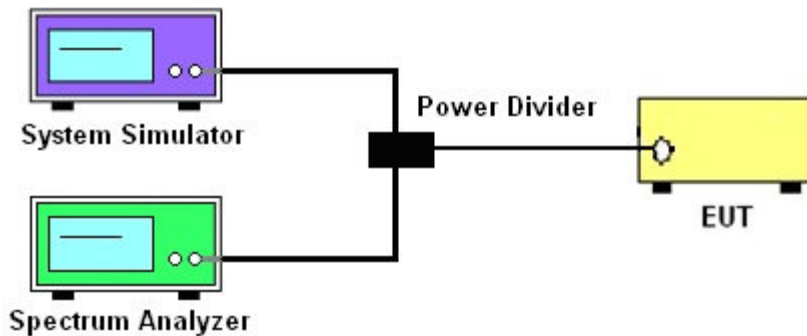

3.2.3 Frequency Stability

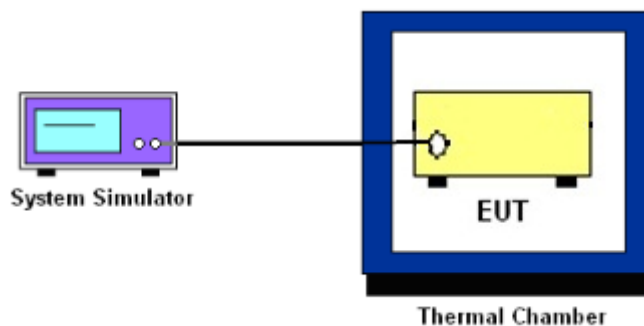

3.3 Test Result of Conducted Test

Please refer to Appendix A.



3.4 Conducted Output Power and ERP/EIRP

3.4.1 Description of the Conducted Output Power Measurement and ERP/EIRP Measurement

A system simulator was used to establish communication with the EUT. Its parameters were set to force the EUT transmitting at maximum output power. The measured power in the radio frequency on the transmitter output terminals shall be reported.

The ERP of mobile transmitters must not exceed 7 Watts for LTE Band 5.

The ERP of mobile transmitters must not exceed 3 Watts for LTE Band 12, Band 13 and Band 17.

The EIRP of mobile transmitters must not exceed 2 Watts for LTE Band 2 and Band 7.

The EIRP of mobile transmitters must not exceed 1 Watts for LTE Band 4 and Band 66.

According to KDB 412172 D01 Power Approach,

$EIRP = P_T + G_T - L_C$, $ERP = EIRP - 2.15$, where

P_T = transmitter output power in dBm

G_T = gain of the transmitting antenna in dBi

L_C = signal attenuation in the connecting cable between the transmitter and antenna in dB

3.4.2 Test Procedures

1. The testing follows ANSI C63.26 Section 5.2
2. The transmitter output port was connected to the system simulator.
3. Set EUT at maximum power through the system simulator.
4. Select lowest, middle, and highest channels for each band and different modulation.
5. Measure and record the power level from the system simulator.



3.5 Peak-to-Average Ratio

3.5.1 Description of the PAR Measurement

Power Complementary Cumulative Distribution Function (CCDF) curves provide a means for characterizing the power peaks of a digitally modulated signal on a statistical basis. A CCDF curve depicts the probability of the peak signal amplitude exceeding the average power level. Most contemporary measurement instrumentation include the capability to produce CCDF curves for an input signal provided that the instrument's resolution bandwidth can be set wide enough to accommodate the entire input signal bandwidth. In measuring transmissions in this band using an average power technique, the peak-to-average ratio (PAR) of the transmission may not exceed 13 dB.

3.5.2 Test Procedures

1. The testing follows ANSI C63.26 Section 5.2.3.4 (CCDF).
2. The EUT was connected to spectrum and system simulator via a power divider.
3. Set the CCDF (Complementary Cumulative Distribution Function) option in spectrum analyzer.
4. The highest RF powers were measured and recorded the maximum PAPR level associated with a probability of 0.1 %.
5. Record the deviation as Peak to Average Ratio.



3.6 Occupied Bandwidth

3.6.1 Description of Occupied Bandwidth Measurement

The occupied bandwidth is the width of a frequency band such that, below the lower and above the upper frequency limits, the mean powers emitted are each equal to a specified percentage 0.5% of the total mean transmitted power.

The 26 dB emission bandwidth is defined as the frequency range between two points, one above and one below the carrier frequency, at which the spectral density of the emission is attenuated 26 dB below the maximum in-band spectral density of the modulated signal. Spectral density (power per unit bandwidth) is to be measured with a detector of resolution bandwidth equal to approximately 1.0% of the emission bandwidth.

3.6.2 Test Procedures

1. The testing follows ANSI C63.26 Section 5.4
2. The EUT was connected to spectrum analyzer and system simulator via a power divider.
3. The spectrum analyzer center frequency is set to the nominal EUT channel center frequency. The span range for the spectrum analyzer shall be between two and five times the anticipated OBW.
4. The nominal resolution bandwidth (RBW) shall be in the range of 1 to 5 % of the anticipated OBW, and the VBW shall be at least 3 times the RBW.
5. Set the detection mode to peak, and the trace mode to max hold.
6. Determine the reference value: Set the EUT to transmit a modulated signal. Allow the trace to stabilize. Set the spectrum analyzer marker to the highest level of the displayed trace.
(this is the reference value)
7. Determine the “-26 dB down amplitude” as equal to (Reference Value – X).
8. Place two markers, one at the lowest and the other at the highest frequency of the envelope of the spectral display such that each marker is at or slightly below the “-X dB down amplitude” determined in step 6. If a marker is below this “-X dB down amplitude” value it shall be placed as close as possible to this value. The OBW is the positive frequency difference between the two markers.
9. Use the 99 % power bandwidth function of the spectrum analyzer and report the measured bandwidth.



3.7 Conducted Band Edge

3.7.1 Description of Conducted Band Edge Measurement

22.917(a)

For operations in the 824 – 849 MHz band, the FCC limit is $43 + 10\log_{10}(P[\text{Watts}])$ dB below the transmitter power P(Watts) in a 100kHz bandwidth. However, in the 1MHz bands immediately outside and adjacent to the licensee's frequency block, a resolution bandwidth of at least one percent of the emission bandwidth of the fundamental emission of the transmitter may be employed.

24.238 (a)

For operations in the 1850-1910 and 1930-1990 MHz band, the FCC limit is $43 + 10\log_{10}(P[\text{Watts}])$ dB below the transmitter power P(Watts) in a 1MHz bandwidth. However, in the 1 MHz bands immediately outside and adjacent to the frequency block a resolution bandwidth of at least one percent of the emission bandwidth of the fundamental emission of the transmitter may be employed.

27.53 (c)

For operations in the 776-788 MHz band, the FCC limit is $43 + 10\log_{10}(P[\text{Watts}])$ dB below the transmitter power P(Watts) in a 100 kHz bandwidth. However, in the 100 kHz bands immediately outside and adjacent to the frequency block, a resolution bandwidth of at least 30 kHz may be employed. In addition, the power of any unwanted emissions in any 6.25 kHz bandwidth for all frequencies between 763-775 MHz and 793-806 MHz shall be attenuated below the transmitter power, P (dBW), by at least $65 + 10 \log_{10} p(\text{watts})$, dB, for mobile and portable equipment.

27.53 (g)

For operations in the 600MHz band and 698 -746 MHz band, the FCC limit is $43 + 10\log_{10}(P[\text{Watts}])$ dB below the transmitter power P(Watts) in a 100 kHz bandwidth. However, in the 100 kilohertz bands immediately outside and adjacent to a licensee's frequency block, a resolution bandwidth of at least 30 kHz may be employed.

27.53 (h)

For operations in the 1710 – 1755 MHz band, the FCC limit is $43 + 10\log_{10}(P[\text{Watts}])$ dB below the transmitter power P(Watts) in a 1 MHz bandwidth. However, in the 1MHz bands immediately outside and adjacent to the licensee's frequency block, a resolution bandwidth of at least one percent of the emission bandwidth of the fundamental emission of the transmitter may be employed.



27.53(m)(4)

For mobile digital stations, the attenuation factor shall be not less than $40 + 10 \log (P)$ dB on all frequencies between the channel edge and 5 megahertz from the channel edge, $43 + 10 \log (P)$ dB on all frequencies between 5 megahertz and X megahertz from the channel edge, and $55 + 10 \log (P)$ dB on all frequencies more than X megahertz from the channel edge, where X is the greater of 6 megahertz or the actual emission bandwidth as defined in paragraph (m)(6) of this section. In addition, the attenuation factor shall not be less that $43 + 10 \log (P)$ dB on all frequencies between 2490.5 MHz and 2496 MHz and $55 + 10 \log (P)$ dB at or below 2490.5 MHz. Mobile Satellite Service licensees operating on frequencies below 2495 MHz may also submit a documented interference complaint against BRS licensees operating on channel BRS Channel 1 on the same terms and conditions as adjacent channel BRS or EBS licensees.

3.7.2 Test Procedures

1. The testing follows ANSI C63.26 section 5.7
2. The EUT was connected to spectrum analyzer and system simulator via a power divider.
3. The band edges of low and high channels for the highest RF powers were measured.
4. Set RBW $\geq 1\%$ EBW in the 1MHz band immediately outside and adjacent to the band edge.
5. Beyond the 1 MHz band from the band edge, RBW=1MHz was used.
6. Set spectrum analyzer with RMS detector.
7. The RF fundamental frequency should be excluded against the limit line in the operating frequency band.
8. Checked that all the results comply with the emission limit line.

Example:

$$\begin{aligned} &\text{The limit line is derived from } 43 + 10\log(P)\text{dB below the transmitter power } P(\text{Watts}) \\ &= P(\text{W}) - [43 + 10\log(P)] \text{ (dB)} \\ &= [30 + 10\log(P)] \text{ (dBm)} - [43 + 10\log(P)] \text{ (dB)} = -13\text{dBm}. \end{aligned}$$

9. For LTE Band 7, the other 40 dB, and 55 dB have additionally applied same calculation above.



3.8 Conducted Spurious Emission

3.8.1 Description of Conducted Spurious Emission Measurement

The power of any emission outside of the authorized operating frequency ranges must be lower than the transmitter power (P) by a factor of at least $43 + 10 \log (P)$ dB.

For Band 7:

The power of any emission outside of the authorized operating frequency ranges must be lower than the transmitter power (P) by a factor of at least $55 + 10 \log (P)$ dB.

It is measured by means of a calibrated spectrum analyzer and scanned from 30 MHz up to a frequency including its 10th harmonic.

3.8.2 Test Procedures

1. The testing follows ANSI C63.26 section 5.7
2. The EUT was connected to spectrum analyzer and system simulator via a power divider.
3. The RF output of EUT was connected to the spectrum analyzer by RF cable and attenuator. The path loss was compensated to the results for each measurement.
4. The middle channel for the highest RF power within the transmitting frequency was measured.
5. The conducted spurious emission for the whole frequency range was taken.
6. Make the measurement with the spectrum analyzer's RBW = 1MHz, VBW = 3MHz.
7. Set spectrum analyzer with RMS detector.
8. Taking the record of maximum spurious emission.
9. The RF fundamental frequency should be excluded against the limit line in the operating frequency band.
10. The limit line is derived from $43 + 10\log(P)$ dB below the transmitter power P(Watts)
 $= P(W) - [43 + 10\log(P)]$ (dB)
 $= [30 + 10\log(P)]$ (dBm) - $[43 + 10\log(P)]$ (dB)
 $= -13$ dBm.
11. For Band 7
The limit line is derived from $55 + 10\log(P)$ dB below the transmitter power P(Watts)
 $= P(W) - [55 + 10\log(P)]$ (dB)
 $= [30 + 10\log(P)]$ (dBm) - $[55 + 10\log(P)]$ (dB)
 $= -25$ dBm.



3.9 Frequency Stability

3.9.1 Description of Frequency Stability Measurement

The frequency stability shall be measured by variation of ambient temperature and variation of primary supply voltage to ensure that the fundamental emission stays within the authorized frequency block. The frequency stability of the transmitter shall be maintained within $\pm 0.00025\%$ ($\pm 2.5\text{ppm}$) of the center frequency.

3.9.2 Test Procedures for Temperature Variation

1. The testing follows ANSI C63.26 section 5.6.4
2. The EUT was set up in the thermal chamber and connected with the system simulator.
3. With power OFF, the temperature was decreased to -30°C and the EUT was stabilized before testing. Power was applied and the maximum change in frequency was recorded within one minute.
4. With power OFF, the temperature was raised in 10°C step up to 50°C . The EUT was stabilized at each step for at least half an hour. Power was applied and the maximum frequency change was recorded within one minute.

3.9.3 Test Procedures for Voltage Variation

1. The testing follows ANSI C63.26 section 5.6.5
2. The EUT was placed in a temperature chamber at $20\pm 5^{\circ}\text{C}$ and connected with the system simulator.
3. The power supply voltage to the EUT was varied from 85% to 115% of the nominal value for other than hand carried battery equipment.
4. For hand carried, battery powered equipment, reduce the primary ac or dc supply voltage to the battery operating end point, which shall be specified by the manufacturer.
5. The variation in frequency was measured for the worst case.

4 Radiated Test Items

4.1 Measuring Instruments

See list of measuring instruments of this test report.

4.2 Test Setup

4.2.1 For radiated test from 30MHz to 1GHz



4.2.2 For radiated test above 1GHz

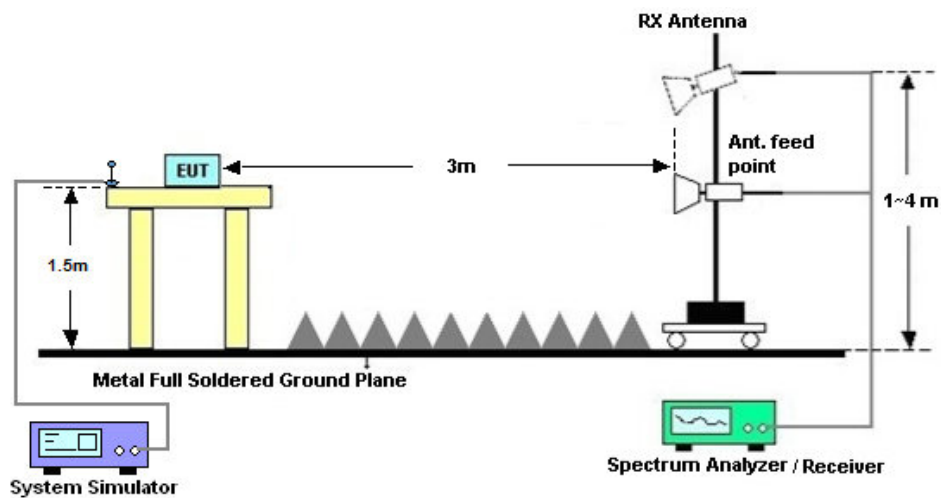

4.3 Test Result of Radiated Test

Please refer to Appendix B.



4.4 Radiated Spurious Emission

4.4.1 Description of Radiated Spurious Emission

The radiated spurious emission was measured by substitution method according to ANSI C63.26. The power of any emission outside of the authorized operating frequency ranges must be attenuated below the transmitter power (P) by a factor of at least $43 + 10 \log (P)$ dB.

For Band 7

The power of any emission outside of the authorized operating frequency ranges must be attenuated below the transmitter power (P) by a factor of at least $55 + 10 \log (P)$ dB.

For LTE Band 13

For operations in the 746-758 MHz, 775-788 MHz, and 805-806 MHz bands, emissions in the band 1559-1610 MHz shall be limited to -70 dBW/MHz equivalent isotropically radiated power (EIRP) for wideband signals, and -80 dBW EIRP for discrete emissions of less than 700 Hz bandwidth.

The spectrum is scanned from 30 MHz up to a frequency including its 10th harmonic.

4.4.2 Test Procedures

1. The testing follows ANSI C63.26 Section 5.5
2. The EUT was placed on a turntable with 0.8 meter height for frequency below 1GHz and 1.5 meter height for frequency above 1GHz respectively above ground.
3. The EUT was set 3 meters from the receiving antenna mounted on the antenna tower.
4. The table was rotated 360 degrees to determine the position of the highest spurious emission.
5. The height of the receiving antenna is varied between 1m to 4m to search the maximum spurious emission for both horizontal and vertical polarizations.
6. During the measurement, the system simulator parameters were set to force the EUT transmitting at maximum output power.
7. Make the measurement with the spectrum analyzer's RBW = 1MHz, VBW = 3MHz, taking the record of maximum spurious emission.
8. A horn antenna was substituted in place of the EUT and was driven by a signal generator.
9. Tune the output power of signal generator to the same emission level with EUT maximum spurious emission.
10. $EIRP (dBm) = S.G. Power - Tx Cable Loss + Tx Antenna Gain$
11. $ERP (dBm) = EIRP - 2.15$
12. The RF fundamental frequency should be excluded against the limit line in the operating frequency band.
The limit line is derived from $43 + 10\log(P)$ dB below the transmitter power P(Watts)
13. For Band 7:
The limit line is derived from $55 + 10\log(P)$ dB below the transmitter power P(Watts)



5 List of Measuring Equipment

Instrument	Manufacturer	Model No.	Serial No.	Characteristics	Calibration Date	Test Date	Due Date	Remark
Spectrum Analyzer	R&S	FSV40	101078	9kHz~40GHz	Apr. 19, 2018	Jun. 04, 2018~ Jun. 08, 2018	Apr. 18, 2019	Conducted (TH01-SZ)
Thermal Chamber	Ten Billion Hongzhangroup	LP-150U	H2014081803	-40~+150°C	Jul. 20, 2017	Jun. 04, 2018~ Jun. 08, 2018	Jul. 19, 2018	Conducted (TH01-SZ)
EMI Test Receiver&SA	Agilent	N9038A	MY52260185	20Hz~26.5GHz	Apr. 19, 2018	Jun. 06, 2018~ Jun. 08, 2018	Apr. 18, 2019	Radiation (03CH01-SZ)
HF Amplifier	KEYSIGHT	83017A	MY53270104	0.5GHz~26.5Ghz	Oct. 19, 2017	Jun. 06, 2018~ Jun. 08, 2018	Oct. 18, 2018	Radiation (03CH01-SZ)
Bilog Antenna	TeseQ	CBL6112D	35408	30MHz-2GHz	Apr. 19, 2018	Jun. 06, 2018~ Jun. 08, 2018	Apr. 18, 2019	Radiation (03CH01-SZ)
Double Ridge Horn Antenna	ETS Lindgren	3117	119436	1GHz~18GHz	Jul. 28, 2017	Jun. 06, 2018~ Jun. 08, 2018	Jul. 27, 2018	Radiation (03CH01-SZ)
SHF-EHF Horn	com-power	AH-840	101071	18Ghz-40GHz	Jun. 16, 2017	Jun. 06, 2018~ Jun. 08, 2018	Jun. 15, 2018	Radiation (03CH01-SZ)
LF Amplifier	Burgeon	BPA-530	102209	0.01~3000Mhz	Apr. 19, 2018	Jun. 06, 2018~ Jun. 08, 2018	Apr. 18, 2019	Radiation (03CH01-SZ)
HF Amplifier	MITEQ	AMF-7D-001018 00-30-10P-R	1707137	1GHz~18GHz	Oct. 19, 2017	Jun. 06, 2018~ Jun. 08, 2018	Oct. 18, 2018	Radiation (03CH01-SZ)
HF Amplifier	MITEQ	TTA1840-35-HG	1871923	18GHz~40GHz	Jul. 18, 2017	Jun. 06, 2018~ Jun. 08, 2018	Jul. 17, 2018	Radiation (03CH01-SZ)
AC Power Source	Chroma	61601	616010001985	N/A	NCR	Jun. 06, 2018~ Jun. 08, 2018	NCR	Radiation (03CH01-SZ)
Turn Table	EM	EM1000	N/A	0~360 degree	NCR	Jun. 06, 2018~ Jun. 08, 2018	NCR	Radiation (03CH01-SZ)
Antenna Mast	EM	EM1000	N/A	1 m~4 m	NCR	Jun. 06, 2018~ Jun. 08, 2018	NCR	Radiation (03CH01-SZ)
EMI Test Receiver&SA	KEYSIGHT	N9038A	MY54450083	20Hz~8.4GHz	Apr. 19, 2018	Jun. 06, 2018~ Jun. 08, 2018	Apr. 18, 2019	Radiation (03CH03-SZ)
EXA Spectrum Analyzer	KEYSIGHT	N9010A	MY55150246	10Hz~44GHz;	Apr. 19, 2018	Jun. 06, 2018~ Jun. 08, 2018	Apr. 18, 2019	Radiation (03CH03-SZ)
Bilog Antenna	TeseQ	CBL6112D	35408	30MHz-2GHz	Apr. 19, 2018	Jun. 06, 2018~ Jun. 08, 2018	Apr. 18, 2019	Radiation (03CH03-SZ)
Double Ridge Horn Antenna	SCHWARZBECK	BBHA9120D	9120D-1355	1GHz~18GHz	Jul. 09, 2017	Jun. 06, 2018~ Jun. 08, 2018	Jul. 08, 2018	Radiation (03CH03-SZ)
Amplifier	Burgeon	BPA-530	102210	0.01Hz ~3000MHz	Oct. 19, 2017	Jun. 06, 2018~ Jun. 08, 2018	Oct. 18, 2018	Radiation (03CH03-SZ)
HF Amplifier	MITEQ	TTA1840-35-HG	1871923	18GHz~40GHz	Jul. 18, 2017	Jun. 06, 2018~ Jun. 08, 2018	Jul. 17, 2018	Radiation (03CH03-SZ)
SHF-EHF Horn	com-power	AH-840	101071	18Ghz-40GHz	Jun. 16, 2017	Jun. 06, 2018~ Jun. 08, 2018	Jun. 15, 2018	Radiation (03CH03-SZ)
Amplifier	Agilent Technologies	83017A	MY39501302	500MHz~26.5GHz	Dec. 27, 2017	Jun. 06, 2018~ Jun. 08, 2018	Dec. 26, 2018	Radiation (03CH03-SZ)
AC Power Source	Chroma	61601	616010001985	N/A	NCR	Jun. 06, 2018~ Jun. 08, 2018	NCR	Radiation (03CH03-SZ)
Turn Table	EM	EM1000	N/A	0~360 degree	NCR	Jun. 06, 2018~ Jun. 08, 2018	NCR	Radiation (03CH03-SZ)
Antenna Mast	EM	EM1000	N/A	1 m~4 m	NCR	Jun. 06, 2018~ Jun. 08, 2018	NCR	Radiation (03CH03-SZ)

NCR: No Calibration Required



6 Uncertainty of Evaluation

Uncertainty of Radiated Emission Measurement (30 MHz ~ 1000 MHz) for 03CH01-SZ

Measuring Uncertainty for a Level of Confidence of 95% (U = 2Uc(y))	2.5 dB
---	--------

Uncertainty of Radiated Emission Measurement (1 GHz ~ 18 GHz) for 03CH01-SZ

Measuring Uncertainty for a Level of Confidence of 95% (U = 2Uc(y))	3.5 dB
---	--------

Uncertainty of Radiated Emission Measurement (18 GHz ~ 40 GHz) for 03CH01-SZ

Measuring Uncertainty for a Level of Confidence of 95% (U = 2Uc(y))	4.0 dB
---	--------

Uncertainty of Radiated Emission Measurement (30 MHz ~ 1000 MHz) for 03CH03-SZ

Measuring Uncertainty for a Level of Confidence of 95% (U = 2Uc(y))	3.0 dB
---	--------

Uncertainty of Radiated Emission Measurement (1 GHz ~ 18 GHz) for 03CH03-SZ

Measuring Uncertainty for a Level of Confidence of 95% (U = 2Uc(y))	3.6 dB
---	--------

Uncertainty of Radiated Emission Measurement (18 GHz ~ 40 GHz) for 03CH03-SZ

Measuring Uncertainty for a Level of Confidence of 95% (U = 2Uc(y))	3.8 dB
---	--------



Appendix A. Test Results of Conducted Test

Conducted Output Power(Average power)

LTE Band 2 Maximum Average Power [dBm]						
BW [MHz]	RB Size	RB Offset	Mod	Lowest	Middle	Highest
20	1	0	QPSK	22.86	22.82	22.83
20	1	49		23.00	23.06	22.98
20	1	99		22.67	22.67	22.70
20	50	0		21.96	22.16	22.11
20	50	24		21.94	22.15	22.01
20	50	50		21.84	22.10	21.96
20	100	0		21.90	22.05	22.02
20	1	0	16-QAM	22.09	22.14	22.10
20	1	49		22.27	22.31	22.28
20	1	99		21.99	21.98	21.98
20	50	0		20.93	20.97	21.11
20	50	24		20.96	20.95	21.03
20	50	50		20.85	20.84	20.98
20	100	0		20.89	20.91	21.04
15	1	0	QPSK	22.88	22.87	22.87
15	1	37		23.02	23.01	23.05
15	1	74		22.73	22.76	22.78
15	36	0		21.98	21.98	22.05
15	36	20		21.92	21.95	22.01
15	36	39		21.88	21.90	21.94
15	75	0		21.92	21.94	22.02
15	1	0	16-QAM	22.10	22.16	22.19
15	1	37		22.30	22.41	22.33
15	1	74		22.05	22.09	22.06
15	36	0		20.94	20.97	21.02
15	36	20		20.90	20.94	20.99
15	36	39		20.87	20.86	20.97
15	75	0		20.89	20.92	21.03



LTE Band 2 Maximum Average Power [dBm]						
BW [MHz]	RB Size	RB Offset	Mod	Lowest	Middle	Highest
10	1	0	QPSK	22.87	22.87	22.88
10	1	25		22.97	23.01	22.98
10	1	49		22.78	22.82	22.82
10	25	0		21.95	21.97	21.97
10	25	12		21.91	21.93	21.98
10	25	25		21.88	21.91	21.96
10	50	0		21.93	21.94	22.01
10	1	0	16-QAM	22.11	22.19	22.16
10	1	25		22.15	22.28	22.25
10	1	49		22.05	22.09	22.08
10	25	0		20.91	20.97	21.00
10	25	12		20.90	20.98	21.02
10	25	25		20.88	20.91	20.98
10	50	0		20.89	20.94	21.03
5	1	0	QPSK	22.79	22.77	22.78
5	1	12		23.05	23.03	23.00
5	1	24		22.70	22.74	22.77
5	12	0		21.92	21.90	21.93
5	12	7		21.93	21.96	22.00
5	12	13		21.91	21.96	21.97
5	25	0		21.90	21.91	21.93
5	1	0	16-QAM	22.05	22.09	22.06
5	1	12		22.29	22.32	22.34
5	1	24		21.98	22.02	22.05
5	12	0		20.88	20.91	20.95
5	12	7		20.91	20.97	21.02
5	12	13		20.90	20.95	20.98
5	25	0		20.88	20.92	20.96



LTE Band 2 Maximum Average Power [dBm]						
BW [MHz]	RB Size	RB Offset	Mod	Lowest	Middle	Highest
3	1	0	QPSK	22.88	22.90	22.89
3	1	8		23.03	23.01	23.05
3	1	14		22.85	22.87	22.90
3	8	0		21.94	21.93	21.95
3	8	4		21.95	21.96	21.98
3	8	7		21.88	21.90	21.94
3	15	0		21.92	21.90	21.94
3	1	0	16-QAM	22.15	22.22	22.15
3	1	8		22.28	22.38	22.32
3	1	14		22.09	22.20	22.13
3	8	0		20.98	20.99	21.02
3	8	4		20.99	21.03	21.05
3	8	7		20.94	20.96	21.00
3	15	0		20.90	20.95	20.97
1.4	1	0	QPSK	22.84	22.85	22.85
1.4	1	3		23.00	23.00	23.00
1.4	1	5		22.86	22.83	22.86
1.4	3	0		22.95	22.98	22.97
1.4	3	1		23.02	23.02	23.03
1.4	3	3		22.99	22.98	22.99
1.4	6	0		21.96	21.95	21.98
1.4	1	0	16-QAM	22.07	22.13	22.11
1.4	1	3		22.22	22.28	22.24
1.4	1	5		22.07	22.15	22.09
1.4	3	0		21.91	21.96	21.95
1.4	3	1		21.98	21.99	22.01
1.4	3	3		21.97	21.99	21.99
1.4	6	0		21.02	21.02	21.09



LTE Band 4 Maximum Average Power [dBm]						
BW [MHz]	RB Size	RB Offset	Mod	Lowest	Middle	Highest
20	1	0	QPSK	23.04	23.08	23.06
20	1	49		23.27	23.37	23.25
20	1	99		22.91	22.93	22.87
20	50	0		22.34	22.35	22.25
20	50	24		22.33	22.30	22.26
20	50	50		22.21	22.24	22.15
20	100	0		22.27	22.28	22.18
20	1	0	16-QAM	22.32	22.36	22.41
20	1	49		22.43	22.47	22.48
20	1	99		22.24	22.25	22.20
20	50	0		21.31	21.29	21.25
20	50	24		21.29	21.30	21.24
20	50	50		21.17	21.22	21.16
20	100	0		21.23	21.25	21.20
15	1	0	QPSK	23.13	23.11	23.13
15	1	37		23.34	23.30	23.35
15	1	74		22.99	23.00	22.97
15	36	0		22.31	22.30	22.26
15	36	20		22.32	22.28	22.25
15	36	39		22.27	22.25	22.18
15	75	0		22.29	22.27	22.21
15	1	0	16-QAM	22.38	22.48	22.46
15	1	37		22.48	22.49	22.49
15	1	74		22.31	22.34	22.27
15	36	0		21.26	21.27	21.24
15	36	20		21.25	21.25	21.23
15	36	39		21.21	21.22	21.17
15	75	0		21.25	21.25	21.19



LTE Band 4 Maximum Average Power [dBm]						
BW [MHz]	RB Size	RB Offset	Mod	Lowest	Middle	Highest
10	1	0	QPSK	23.15	23.17	23.11
10	1	25		23.27	23.26	23.24
10	1	49		23.09	23.09	23.01
10	25	0		22.30	22.26	22.28
10	25	12		22.30	22.26	22.25
10	25	25		22.27	22.24	22.15
10	50	0		22.30	22.27	22.23
10	1	0	16-QAM	22.39	22.46	22.47
10	1	25		22.42	22.47	22.48
10	1	49		22.35	22.40	22.34
10	25	0		21.26	21.27	21.28
10	25	12		21.27	21.26	21.22
10	25	25		21.24	21.24	21.17
10	50	0		21.25	21.27	21.25
5	1	0	QPSK	23.03	23.04	23.01
5	1	12		23.29	23.34	23.28
5	1	24		23.01	23.00	22.93
5	12	0		22.20	22.20	22.20
5	12	7		22.27	22.25	22.20
5	12	13		22.24	22.23	22.17
5	25	0		22.23	22.19	22.16
5	1	0	16-QAM	22.30	22.37	22.34
5	1	12		22.46	22.45	22.48
5	1	24		22.28	22.33	22.28
5	12	0		21.17	21.18	21.20
5	12	7		21.23	21.24	21.20
5	12	13		21.19	21.22	21.16
5	25	0		21.20	21.22	21.17



LTE Band 4 Maximum Average Power [dBm]						
BW [MHz]	RB Size	RB Offset	Mod	Lowest	Middle	Highest
3	1	0	QPSK	23.13	23.14	23.10
3	1	8		23.29	23.30	23.22
3	1	14		23.12	23.11	23.06
3	8	0		22.21	22.23	22.15
3	8	4		22.25	22.24	22.20
3	8	7		22.21	22.18	22.14
3	15	0		22.22	22.21	22.16
3	1	0	16-QAM	22.38	22.45	22.42
3	1	8		22.49	22.45	22.44
3	1	14		22.40	22.45	22.40
3	8	0		21.25	21.27	21.22
3	8	4		21.28	21.29	21.23
3	8	7		21.23	21.24	21.18
3	15	0		21.19	21.22	21.18
1.4	1	0	QPSK	23.03	23.05	23.01
1.4	1	3		23.17	23.19	23.11
1.4	1	5		23.03	23.04	23.01
1.4	3	0		23.15	23.18	23.10
1.4	3	1		23.19	23.23	23.15
1.4	3	3		23.17	23.20	23.12
1.4	6	0		22.20	22.21	22.17
1.4	1	0	16-QAM	22.31	22.38	22.35
1.4	1	3		22.44	22.42	22.48
1.4	1	5		22.32	22.39	22.33
1.4	3	0		22.13	22.18	22.11
1.4	3	1		22.21	22.26	22.17
1.4	3	3		22.17	22.23	22.16
1.4	6	0		21.24	21.29	21.25



LTE Band 5 Maximum Average Power [dBm]						
BW [MHz]	RB Size	RB Offset	Mod	Lowest	Middle	Highest
10	1	0	QPSK	23.01	22.95	22.99
10	1	25		23.17	23.19	23.16
10	1	49		22.96	22.96	22.94
10	25	0		21.94	22.15	22.06
10	25	12		22.06	22.07	22.08
10	25	25		22.04	22.04	21.98
10	50	0		22.03	22.10	22.05
10	1	0	16-QAM	22.35	22.14	22.34
10	1	25		22.30	22.35	22.37
10	1	49		22.15	22.31	22.19
10	25	0		20.98	21.10	21.10
10	25	12		21.07	21.07	21.09
10	25	25		21.02	21.05	21.02
10	50	0		21.02	21.07	21.10
5	1	0	QPSK	22.93	22.87	22.88
5	1	12		23.14	23.15	23.11
5	1	24		22.85	22.87	22.84
5	12	0		21.96	22.05	22.04
5	12	7		22.08	22.10	22.06
5	12	13		22.07	22.02	22.01
5	25	0		22.02	22.03	21.99
5	1	0	16-QAM	22.27	22.11	22.19
5	1	12		22.48	22.42	22.37
5	1	24		22.10	22.23	22.15
5	12	0		21.02	21.05	21.01
5	12	7		21.10	21.08	21.05
5	12	13		21.08	21.05	21.01
5	25	0		21.03	21.05	20.98



LTE Band 5 Maximum Average Power [dBm]						
BW [MHz]	RB Size	RB Offset	Mod	Lowest	Middle	Highest
3	1	0	QPSK	23.02	22.97	22.94
3	1	8		23.18	23.13	23.10
3	1	14		23.00	22.97	22.94
3	8	0		22.01	22.03	22.01
3	8	4		22.05	22.06	22.06
3	8	7		22.03	22.01	21.99
3	15	0		22.03	22.01	22.02
3	1	0	16-QAM	22.40	22.23	22.21
3	1	8		22.47	22.45	22.35
3	1	14		22.26	22.33	22.26
3	8	0		21.13	21.08	21.05
3	8	4		21.14	21.13	21.08
3	8	7		21.12	21.09	21.04
3	15	0		21.07	21.02	21.05
1.4	1	0	QPSK	22.95	22.90	22.87
1.4	1	3		23.08	23.03	23.03
1.4	1	5		22.94	22.91	22.89
1.4	3	0		23.06	23.02	23.00
1.4	3	1		23.10	23.06	23.04
1.4	3	3		23.07	23.05	23.01
1.4	6	0		22.03	22.01	22.03
1.4	1	0	16-QAM	22.32	22.20	22.09
1.4	1	3		22.47	22.34	22.28
1.4	1	5		22.27	22.22	22.11
1.4	3	0		22.14	22.01	21.96
1.4	3	1		22.15	22.06	22.03
1.4	3	3		22.11	22.05	22.02
1.4	6	0		21.15	21.11	21.12



LTE Band 7 Maximum Average Power [dBm]						
BW [MHz]	RB Size	RB Offset	Mod	Lowest	Middle	Highest
20	1	0	QPSK	23.22	23.24	23.23
20	1	49		23.50	23.61	23.48
20	1	99		23.26	23.29	23.21
20	50	0		22.38	22.49	22.56
20	50	24		22.50	22.54	22.52
20	50	50		22.52	22.53	22.51
20	100	0		22.42	22.56	22.51
20	1	0	16-QAM	22.41	22.41	22.43
20	1	49		22.70	22.74	22.72
20	1	99		22.41	22.52	22.45
20	50	0		21.31	21.49	21.54
20	50	24		21.43	21.55	21.52
20	50	50		21.44	21.54	21.53
20	100	0		21.35	21.46	21.50
15	1	0	QPSK	23.30	23.32	23.36
15	1	37		23.59	23.60	23.55
15	1	74		23.34	23.40	23.33
15	36	0		22.40	22.49	22.48
15	36	20		22.48	22.54	22.51
15	36	39		22.50	22.53	22.48
15	75	0		22.47	22.50	22.50
15	1	0	16-QAM	22.48	22.51	22.50
15	1	37		22.74	22.79	22.82
15	1	74		22.53	22.62	22.50
15	36	0		21.33	21.46	21.45
15	36	20		21.39	21.51	21.49
15	36	39		21.41	21.51	21.46
15	75	0		21.39	21.47	21.50



LTE Band 7 Maximum Average Power [dBm]						
BW [MHz]	RB Size	RB Offset	Mod	Lowest	Middle	Highest
10	1	0	QPSK	23.30	22.89	22.98
10	1	25		23.37	23.34	23.34
10	1	49		23.33	23.34	23.21
10	25	0		22.40	22.45	22.48
10	25	12		22.43	22.41	22.50
10	25	25		22.50	22.54	22.50
10	50	0		22.46	22.55	22.51
10	1	0	16-QAM	22.49	22.52	22.51
10	1	25		22.66	22.73	22.70
10	1	49		22.51	22.59	22.49
10	25	0		21.34	21.51	21.48
10	25	12		21.38	21.50	21.51
10	25	25		21.44	21.53	21.51
10	50	0		21.40	21.55	21.51
5	1	0	QPSK	23.26	23.30	23.26
5	1	12		23.49	23.58	23.53
5	1	24		23.33	23.32	23.27
5	12	0		22.44	22.43	22.41
5	12	7		22.43	22.48	22.48
5	12	13		22.46	22.47	22.44
5	25	0		22.40	22.44	22.41
5	1	0	16-QAM	22.43	22.47	22.45
5	1	12		22.73	22.75	22.70
5	1	24		22.42	22.51	22.40
5	12	0		21.30	21.41	21.38
5	12	7		21.36	21.48	21.47
5	12	13		21.38	21.45	21.41
5	25	0		21.35	21.46	21.45



LTE Band 12 Maximum Average Power [dBm]						
BW [MHz]	RB Size	RB Offset	Mod	Lowest	Middle	Highest
10	1	0	QPSK	23.17	23.18	23.22
10	1	25		23.37	23.43	23.31
10	1	49		23.28	23.27	23.30
10	25	0		22.38	22.31	22.32
10	25	12		22.31	22.32	22.33
10	25	25		22.39	22.42	22.24
10	50	0		22.39	22.40	22.27
10	1	0	16-QAM	22.44	22.48	22.53
10	1	25		22.66	22.64	22.58
10	1	49		22.56	22.51	22.54
10	25	0		21.40	21.31	21.29
10	25	12		21.34	21.37	21.33
10	25	25		21.41	21.40	21.22
10	50	0		21.40	21.38	21.26
5	1	0	QPSK	23.12	23.16	23.11
5	1	12		23.41	23.24	23.39
5	1	24		23.15	23.18	23.20
5	12	0		22.26	22.26	22.35
5	12	7		22.34	22.34	22.34
5	12	13		22.30	22.34	22.28
5	25	0		22.27	22.27	22.30
5	1	0	16-QAM	22.44	22.41	22.34
5	1	12		22.71	22.73	22.64
5	1	24		22.47	22.44	22.44
5	12	0		21.26	21.29	21.30
5	12	7		21.35	21.35	21.30
5	12	13		21.31	21.36	21.24
5	25	0		21.30	21.30	21.29



LTE Band 12 Maximum Average Power [dBm]						
BW [MHz]	RB Size	RB Offset	Mod	Lowest	Middle	Highest
3	1	0	QPSK	23.24	23.27	23.19
3	1	8		23.39	23.35	23.40
3	1	14		23.27	23.26	23.25
3	8	0		22.27	22.28	22.28
3	8	4		22.29	22.30	22.33
3	8	7		22.23	22.29	22.28
3	15	0		22.25	22.28	22.30
3	1	0	16-QAM	22.55	22.57	22.42
3	1	8		22.69	22.69	22.66
3	1	14		22.53	22.55	22.52
3	8	0		21.35	21.36	21.31
3	8	4		21.36	21.39	21.38
3	8	7		21.30	21.37	21.37
3	15	0		21.26	21.31	21.27
1.4	1	0	QPSK	23.20	23.20	23.18
1.4	1	3		23.31	23.30	23.35
1.4	1	5		23.18	23.20	23.20
1.4	3	0		23.32	23.33	23.33
1.4	3	1		23.36	23.34	23.36
1.4	3	3		23.35	23.35	23.38
1.4	6	0		22.29	22.32	22.33
1.4	1	0	16-QAM	22.48	22.52	22.42
1.4	1	3		22.60	22.64	22.60
1.4	1	5		22.44	22.50	22.45
1.4	3	0		22.32	22.32	22.31
1.4	3	1		22.36	22.37	22.35
1.4	3	3		22.31	22.35	22.34
1.4	6	0		21.35	21.40	21.39



LTE Band 13 Maximum Average Power [dBm]						
BW [MHz]	RB Size	RB Offset	Mod	Lowest	Middle	Highest
10	1	0	QPSK		23.26	
10	1	25			23.48	
10	1	49			23.31	
10	25	0			22.31	
10	25	12			22.37	
10	25	25			22.43	
10	50	0			22.36	
10	1	0	16-QAM		22.58	
10	1	25			22.74	
10	1	49			22.64	
10	25	0			21.36	
10	25	12			21.37	
10	25	25			21.46	
10	50	0			21.39	
5	1	0	QPSK	23.16	23.20	23.18
5	1	12		23.47	23.46	23.47
5	1	24		23.24	23.26	23.24
5	12	0		22.32	22.32	22.37
5	12	7		22.39	22.38	22.42
5	12	13		22.39	22.38	22.40
5	25	0		22.33	22.33	22.32
5	1	0	16-QAM	22.50	22.53	22.51
5	1	12		22.81	22.82	22.83
5	1	24		22.55	22.60	22.54
5	12	0		21.33	21.35	21.38
5	12	7		21.42	21.39	21.43
5	12	13		21.39	21.39	21.43
5	25	0		21.35	21.35	21.38



LTE Band 17 Maximum Average Power [dBm]						
BW [MHz]	RB Size	RB Offset	Mod	Lowest	Middle	Highest
10	1	0	QPSK	23.19	23.22	23.21
10	1	25		23.39	23.42	23.32
10	1	49		23.26	23.25	23.29
10	25	0		22.26	22.27	22.29
10	25	12		22.34	22.36	22.30
10	25	25		22.32	22.24	22.21
10	50	0		22.28	22.29	22.27
10	1	0	16-QAM	22.48	22.54	22.52
10	1	25		22.63	22.60	22.56
10	1	49		22.52	22.49	22.51
10	25	0		21.29	21.28	21.26
10	25	12		21.32	21.32	21.29
10	25	25		21.31	21.23	21.18
10	50	0		21.28	21.25	21.23
5	1	0	QPSK	23.11	23.15	23.13
5	1	12		23.41	23.39	23.41
5	1	24		23.16	23.16	23.16
5	12	0		22.25	22.28	22.32
5	12	7		22.32	22.32	22.30
5	12	13		22.34	22.33	22.28
5	25	0		22.31	22.27	22.28
5	1	0	16-QAM	22.39	22.45	22.38
5	1	12		22.72	22.64	22.64
5	1	24		22.46	22.41	22.44
5	12	0		21.25	21.26	21.30
5	12	7		21.33	21.32	21.27
5	12	13		21.34	21.31	21.26
5	25	0		21.32	21.25	21.25



LTE Band 66 Maximum Average Power [dBm]						
BW [MHz]	RB Size	RB Offset	Mod	Lowest	Middle	Highest
20	1	0	QPSK	23.01	23.07	23.02
20	1	49		23.22	23.29	23.27
20	1	99		22.89	22.95	22.92
20	50	0		22.26	22.35	22.27
20	50	24		22.25	22.31	22.22
20	50	50		22.20	22.24	22.23
20	100	0		22.20	22.31	22.25
20	1	0	16-QAM	22.28	22.42	22.35
20	1	49		22.44	22.42	22.44
20	1	99		22.17	22.27	22.17
20	50	0		21.24	21.35	21.17
20	50	24		21.23	21.31	21.21
20	50	50		21.16	21.24	21.12
20	100	0		21.17	21.30	21.13
15	1	0	QPSK	23.07	23.07	23.15
15	1	37		23.27	23.26	23.24
15	1	74		22.96	22.98	23.05
15	36	0		22.29	22.22	22.35
15	36	20		22.25	22.22	22.35
15	36	39		22.20	22.17	22.30
15	75	0		22.23	22.19	22.35
15	1	0	16-QAM	22.34	22.37	22.48
15	1	37		22.42	22.46	22.46
15	1	74		22.23	22.29	22.37
15	36	0		21.23	21.21	21.34
15	36	20		21.18	21.21	21.33
15	36	39		21.15	21.14	21.27
15	75	0		21.19	21.19	21.32



LTE Band 66 Maximum Average Power [dBm]						
BW [MHz]	RB Size	RB Offset	Mod	Lowest	Middle	Highest
10	1	0	QPSK	23.11	23.07	23.20
10	1	25		23.20	23.24	23.27
10	1	49		23.03	23.02	23.10
10	25	0		22.31	22.25	22.41
10	25	12		22.27	22.24	22.37
10	25	25		22.23	22.21	22.35
10	50	0		22.28	22.27	22.41
10	1	0	16-QAM	22.38	22.42	22.41
10	1	25		22.48	22.44	22.46
10	1	49		22.29	22.33	22.44
10	25	0		21.27	21.23	21.41
10	25	12		21.25	21.23	21.39
10	25	25		21.21	21.22	21.34
10	50	0		21.25	21.24	21.42
5	1	0	QPSK	23.05	23.02	23.13
5	1	12		23.23	23.26	23.27
5	1	24		23.00	22.99	23.05
5	12	0		22.21	22.14	22.26
5	12	7		22.27	22.24	22.32
5	12	13		22.26	22.20	22.29
5	25	0		22.24	22.17	22.27
5	1	0	16-QAM	22.28	22.34	22.48
5	1	12		22.48	22.46	22.45
5	1	24		22.25	22.29	22.38
5	12	0		21.16	21.16	21.26
5	12	7		21.25	21.22	21.33
5	12	13		21.22	21.20	21.29
5	25	0		21.21	21.18	21.32



LTE Band 66 Maximum Average Power [dBm]						
BW [MHz]	RB Size	RB Offset	Mod	Lowest	Middle	Highest
3	1	0	QPSK	23.14	23.13	23.23
3	1	8		23.28	23.24	23.24
3	1	14		23.10	23.11	23.17
3	8	0		22.23	22.17	22.26
3	8	4		22.25	22.24	22.29
3	8	7		22.20	22.17	22.23
3	15	0		22.23	22.19	22.25
3	1	0	16-QAM	22.38	22.45	22.43
3	1	8		22.42	22.49	22.47
3	1	14		22.34	22.43	22.49
3	8	0		21.23	21.25	21.33
3	8	4		21.26	21.27	21.34
3	8	7		21.23	21.24	21.32
3	15	0		21.21	21.20	21.26
1.4	1	0	QPSK	23.07	23.09	23.14
1.4	1	3		23.20	23.22	23.27
1.4	1	5		23.07	23.05	23.16
1.4	3	0		23.17	23.18	23.25
1.4	3	1		23.22	23.23	23.25
1.4	3	3		23.21	23.19	23.27
1.4	6	0		22.24	22.21	22.29
1.4	1	0	16-QAM	22.29	22.39	22.48
1.4	1	3		22.46	22.50	22.45
1.4	1	5		22.31	22.36	22.47
1.4	3	0		22.16	22.21	22.28
1.4	3	1		22.22	22.25	22.34
1.4	3	3		22.21	22.23	22.30
1.4	6	0		21.28	21.31	21.37



ERP/EIRP

LTE Band 2 (GT - LC = -0.25 dBi) QPSK									
Bandwidth	1.4M			3M			5M		
Channel	18607	18900	19193	18615	18900	19185	18625	18900	19175
	(Low)	(Mid)	(High)	(Low)	(Mid)	(High)	(Low)	(Mid)	(High)
Frequency	1850.7	1880	1909.3	1851.5	1880	1908.5	1852.5	1880	1907.5
(MHz)									
Conducted Power (dBm)	23.02	23.02	23.03	23.03	23.01	23.05	23.05	23.03	23.00
Conducted Power (Watts)	0.2004	0.2004	0.2009	0.2009	0.2000	0.2018	0.2018	0.2009	0.1995
EIRP(dBm)	22.77	22.77	22.78	22.78	22.76	22.80	22.80	22.78	22.75
EIRP(Watts)	0.1892	0.1892	0.1897	0.1897	0.1888	0.1905	0.1905	0.1897	0.1884

LTE Band 2 (GT - LC = -0.25 dBi) QPSK									
Bandwidth	10M			15M			20M		
Channel	18650	18900	19150	18675	18900	19125	18650	18900	19100
	(Low)	(Mid)	(High)	(Low)	(Mid)	(High)	(Low)	(Mid)	(High)
Frequency	1855	1880	1905	1857.5	1880	1902.5	1860	1880	1900
(MHz)									
Conducted Power (dBm)	22.97	23.01	22.98	23.02	23.01	23.05	23.00	23.06	22.98
Conducted Power (Watts)	0.1982	0.2000	0.1986	0.2004	0.2000	0.2018	0.1995	0.2023	0.1986
EIRP(dBm)	22.72	22.76	22.73	22.77	22.76	22.80	22.75	22.81	22.73
EIRP(Watts)	0.1871	0.1888	0.1875	0.1892	0.1888	0.1905	0.1884	0.1910	0.1875



LTE Band 2 (GT - LC = -0.25 dBi) 16QAM									
Bandwidth	1.4M			3M			5M		
Channel	18607	18900	19193	18615	18900	19185	18625	18900	19175
	(Low)	(Mid)	(High)	(Low)	(Mid)	(High)	(Low)	(Mid)	(High)
Frequency (MHz)	1850.7	1880	1909.3	1851.5	1880	1908.5	1852.5	1880	1907.5
Conducted Power (dBm)	22.22	22.28	22.24	22.28	22.38	22.32	22.29	22.32	22.34
Conducted Power (Watts)	0.1667	0.1690	0.1675	0.1690	0.1730	0.1706	0.1694	0.1706	0.1714
EIRP(dBm)	21.97	22.03	21.99	22.03	22.13	22.07	22.04	22.07	22.09
EIRP(Watts)	0.1574	0.1596	0.1581	0.1596	0.1633	0.1611	0.1600	0.1611	0.1618

LTE Band 2 (GT - LC = -0.25 dBi) 16QAM									
Bandwidth	10M			15M			20M		
Channel	18650	18900	19150	18675	18900	19125	18650	18900	19100
	(Low)	(Mid)	(High)	(Low)	(Mid)	(High)	(Low)	(Mid)	(High)
Frequency (MHz)	1855	1880	1905	1857.5	1880	1902.5	1860	1880	1900
Conducted Power (dBm)	22.15	22.28	22.25	22.30	22.41	22.33	22.27	22.31	22.28
Conducted Power (Watts)	0.1641	0.1690	0.1679	0.1698	0.1742	0.1710	0.1687	0.1702	0.1690
EIRP(dBm)	21.90	22.03	22.00	22.05	22.16	22.08	22.02	22.06	22.03
EIRP(Watts)	0.1549	0.1596	0.1585	0.1603	0.1644	0.1614	0.1592	0.1607	0.1596



LTE Band 4 (GT - LC = -0.27 dBi) QPSK									
Bandwidth	1.4M			3M			5M		
Channel	19957	20175	20393	19965	20175	20385	19975	20175	20375
	(Low)	(Mid)	(High)	(Low)	(Mid)	(High)	(Low)	(Mid)	(High)
Frequency (MHz)	1710.7	1732.5	1754.3	1711.5	1732.5	1753.5	1712.5	1732.5	1752.5
Conducted Power (dBm)	23.19	23.23	23.15	23.29	23.30	23.22	23.29	23.34	23.28
Conducted Power (Watts)	0.2084	0.2104	0.2065	0.2133	0.2138	0.2099	0.2133	0.2158	0.2128
EIRP(dBm)	22.92	22.96	22.88	23.02	23.03	22.95	23.02	23.07	23.01
EIRP(Watts)	0.1959	0.1977	0.1941	0.2004	0.2009	0.1972	0.2004	0.2028	0.2000

LTE Band 4 (GT - LC = -0.27 dBi) QPSK									
Bandwidth	10M			15M			20M		
Channel	20000	20175	20350	20025	20175	20325	20050	20175	20300
	(Low)	(Mid)	(High)	(Low)	(Mid)	(High)	(Low)	(Mid)	(High)
Frequency (MHz)	1715	1732.5	1750	1717.5	1732.5	1747.5	1720	1732.5	1745
Conducted Power (dBm)	23.27	23.26	23.24	23.34	23.30	23.35	23.27	23.37	23.25
Conducted Power (Watts)	0.2123	0.2118	0.2109	0.2158	0.2138	0.2163	0.2123	0.2173	0.2113
EIRP(dBm)	23.00	22.99	22.97	23.07	23.03	23.08	23.00	23.10	22.98
EIRP(Watts)	0.1995	0.1991	0.1982	0.2028	0.2009	0.2032	0.1995	0.2042	0.1986



LTE Band 4 (GT - LC = -0.27 dBi) 16QAM									
Bandwidth	1.4M			3M			5M		
Channel	19957	20175	20393	19965	20175	20385	19975	20175	20375
	(Low)	(Mid)	(High)	(Low)	(Mid)	(High)	(Low)	(Mid)	(High)
Frequency (MHz)	1710.7	1732.5	1754.3	1711.5	1732.5	1753.5	1712.5	1732.5	1752.5
Conducted Power (dBm)	22.44	22.42	22.48	22.49	22.45	22.44	22.46	22.45	22.48
Conducted Power (Watts)	0.1754	0.1746	0.1770	0.1774	0.1758	0.1754	0.1762	0.1758	0.1770
EIRP(dBm)	22.17	22.15	22.21	22.22	22.18	22.17	22.19	22.18	22.21
EIRP(Watts)	0.1648	0.1641	0.1663	0.1667	0.1652	0.1648	0.1656	0.1652	0.1663

LTE Band 4 (GT - LC = -0.27 dBi) 16QAM									
Bandwidth	10M			15M			20M		
Channel	20000	20175	20350	20025	20175	20325	20050	20175	20300
	(Low)	(Mid)	(High)	(Low)	(Mid)	(High)	(Low)	(Mid)	(High)
Frequency (MHz)	1715	1732.5	1750	1717.5	1732.5	1747.5	1720	1732.5	1745
Conducted Power (dBm)	22.42	22.47	22.48	22.48	22.49	22.49	22.43	22.47	22.48
Conducted Power (Watts)	0.1746	0.1766	0.1770	0.1770	0.1774	0.1774	0.1750	0.1766	0.1770
EIRP(dBm)	22.15	22.20	22.21	22.21	22.22	22.22	22.16	22.20	22.21
EIRP(Watts)	0.1641	0.1660	0.1663	0.1663	0.1667	0.1667	0.1644	0.1660	0.1663



LTE Band 5 (GT - LC = -1.36 dBi) QPSK									
Bandwidth	1.4M			3M			5M		
Channel	20407	20525	20643	20415	20525	20635	20425	20525	20625
	(Low)	(Mid)	(High)	(Low)	(Mid)	(High)	(Low)	(Mid)	(High)
Frequency (MHz)	824.7	836.5	848.3	825.5	836.5	847.5	826.5	836.5	846.5
Conducted Power (dBm)	23.10	23.06	23.04	23.18	23.13	23.10	23.14	23.15	23.11
Conducted Power (Watts)	0.2042	0.2023	0.2014	0.2080	0.2056	0.2042	0.2061	0.2065	0.2046
ERP(dBm)	19.59	19.55	19.53	19.67	19.62	19.59	19.63	19.64	19.60
ERP(Watts)	0.0910	0.0902	0.0897	0.0927	0.0916	0.0910	0.0918	0.0920	0.0912

LTE Band 5 (GT - LC = -1.36 dBi) QPSK			
Bandwidth	10M		
Channel	20450	20525	20600
	(Low)	(Mid)	(High)
Frequency (MHz)	829	836.5	844
Conducted Power (dBm)	23.17	23.19	23.16
Conducted Power (Watts)	0.2075	0.2084	0.2070
ERP(dBm)	19.66	19.68	19.65
ERP(Watts)	0.0925	0.0929	0.0923



LTE Band 5 (GT - LC = -1.36 dBi) 16QAM									
Bandwidth	1.4M			3M			5M		
Channel	20407	20525	20643	20415	20525	20635	20425	20525	20625
	(Low)	(Mid)	(High)	(Low)	(Mid)	(High)	(Low)	(Mid)	(High)
Frequency (MHz)	824.7	836.5	848.3	825.5	836.5	847.5	826.5	836.5	846.5
Conducted Power (dBm)	22.47	22.34	22.28	22.47	22.45	22.35	22.48	22.42	22.37
Conducted Power (Watts)	0.1766	0.1714	0.1690	0.1766	0.1758	0.1718	0.1770	0.1746	0.1726
ERP(dBm)	18.96	18.83	18.77	18.96	18.94	18.84	18.97	18.91	18.86
ERP(Watts)	0.0787	0.0764	0.0753	0.0787	0.0783	0.0766	0.0789	0.0778	0.0769

LTE Band 5 (GT - LC = -1.36 dBi) 16QAM			
Bandwidth	10M		
Channel	20450	20525	20600
	(Low)	(Mid)	(High)
Frequency (MHz)	829	836.5	844
Conducted Power (dBm)	22.30	22.35	22.37
Conducted Power (Watts)	0.1698	0.1718	0.1726
ERP(dBm)	18.79	18.84	18.86
ERP(Watts)	0.0757	0.0766	0.0769



LTE Band 7 (GT - LC = 0.70 dBi) QPSK			
Bandwidth	5M		
Channel	20775	21100	21425
	(Low)	(Mid)	(High)
Frequency	2502.5	2535	2567.5
(MHz)			
Conducted Power (dBm)	23.49	23.58	23.53
Conducted Power (Watts)	0.2234	0.2280	0.2254
EIRP(dBm)	24.19	24.28	24.23
EIRP(Watts)	0.2624	0.2679	0.2649

LTE Band 7 (GT - LC = 0.70 dBi) QPSK									
Bandwidth	10M			15M			20M		
Channel	20800	21100	21400	20825	21100	21375	20850	21100	21350
	(Low)	(Mid)	(High)	(Low)	(Mid)	(High)	(Low)	(Mid)	(High)
Frequency	2505	2535	2565	2507.5	2535	2562.5	2510	2535	2560
(MHz)									
Conducted Power (dBm)	23.37	23.34	23.34	23.59	23.60	23.55	23.50	23.61	23.48
Conducted Power (Watts)	0.2173	0.2158	0.2158	0.2286	0.2291	0.2265	0.2239	0.2296	0.2228
EIRP(dBm)	24.07	24.04	24.04	24.29	24.30	24.25	24.20	24.31	24.18
EIRP(Watts)	0.2553	0.2535	0.2535	0.2685	0.2692	0.2661	0.2630	0.2698	0.2618



LTE Band 7 (GT - LC = 0.70 dBi) 16QAM			
Bandwidth	5M		
Channel	20775	21100	21425
	(Low)	(Mid)	(High)
Frequency	2502.5	2535	2567.5
(MHz)			
Conducted Power (dBm)	22.73	22.75	22.70
Conducted Power (Watts)	0.1875	0.1884	0.1862
EIRP(dBm)	23.43	23.45	23.40
EIRP(Watts)	0.2203	0.2213	0.2188

LTE Band 7 (GT - LC = 0.70 dBi) 16QAM									
Bandwidth	10M			15M			20M		
Channel	20800	21100	21400	20825	21100	21375	20850	21100	21350
	(Low)	(Mid)	(High)	(Low)	(Mid)	(High)	(Low)	(Mid)	(High)
Frequency	2505	2535	2565	2507.5	2535	2562.5	2510	2535	2560
(MHz)									
Conducted Power (dBm)	22.66	22.73	22.70	22.74	22.79	22.82	22.70	22.74	22.72
Conducted Power (Watts)	0.1845	0.1875	0.1862	0.1879	0.1901	0.1914	0.1862	0.1879	0.1871
EIRP(dBm)	23.36	23.43	23.40	23.44	23.49	23.52	23.40	23.44	23.42
EIRP(Watts)	0.2168	0.2203	0.2188	0.2208	0.2234	0.2249	0.2188	0.2208	0.2198



LTE Band 12 (GT - LC = -2.30 dBi) QPSK									
Bandwidth	1.4M			3M			5M		
Channel	23017	23095	23173	23025	23095	23165	23035	23095	23155
	(Low)	(Mid)	(High)	(Low)	(Mid)	(High)	(Low)	(Mid)	(High)
Frequency (MHz)	699.7	707.5	715.3	700.5	707.5	714.5	701.5	707.5	713.5
Conducted Power (dBm)	23.35	23.35	23.38	23.39	23.35	23.40	23.41	23.24	23.39
Conducted Power (Watts)	0.2163	0.2163	0.2178	0.2183	0.2163	0.2188	0.2193	0.2109	0.2183
ERP(dBm)	18.90	18.90	18.93	18.94	18.90	18.95	18.96	18.79	18.94
ERP(Watts)	0.0776	0.0776	0.0782	0.0783	0.0776	0.0785	0.0787	0.0757	0.0783

LTE Band 12 (GT - LC = -2.30 dBi) QPSK			
Bandwidth	10M		
Channel	23060	23095	23130
	(Low)	(Mid)	(High)
Frequency (MHz)	704	707.5	711
Conducted Power (dBm)	23.37	23.43	23.31
Conducted Power (Watts)	0.2173	0.2203	0.2143
ERP(dBm)	18.92	18.98	18.86
ERP(Watts)	0.0780	0.0791	0.0769



LTE Band 12 (GT - LC = -2.30 dBi) 16QAM									
Bandwidth	1.4M			3M			5M		
Channel	23017	23095	23173	23025	23095	23165	23035	23095	23155
	(Low)	(Mid)	(High)	(Low)	(Mid)	(High)	(Low)	(Mid)	(High)
Frequency (MHz)	699.7	707.5	715.3	700.5	707.5	714.5	701.5	707.5	713.5
Conducted Power (dBm)	22.60	22.64	22.60	22.69	22.69	22.66	22.71	22.73	22.64
Conducted Power (Watts)	0.1820	0.1837	0.1820	0.1858	0.1858	0.1845	0.1866	0.1875	0.1837
ERP(dBm)	18.15	18.19	18.15	18.24	18.24	18.21	18.26	18.28	18.19
ERP(Watts)	0.0653	0.0659	0.0653	0.0667	0.0667	0.0662	0.0670	0.0673	0.0659

LTE Band 12 (GT - LC = -2.30 dBi) 16QAM			
Bandwidth	10M		
Channel	23060	23095	23130
	(Low)	(Mid)	(High)
Frequency (MHz)	704	707.5	711
Conducted Power (dBm)	22.66	22.64	22.58
Conducted Power (Watts)	0.1845	0.1837	0.1811
ERP(dBm)	18.21	18.19	18.13
ERP(Watts)	0.0662	0.0659	0.0650



LTE Band 13 (GT - LC = -2.28 dBi) QPSK						
Bandwidth	5M			10M		
Channel	23205	23230	23255	23230		
	(Low)	(Mid)	(High)	-	(Mid)	-
Frequency	779.5	782	784.5	-	782	-
(MHz)						
Conducted Power (dBm)	23.47	23.46	23.47	-	23.48	-
Conducted Power (Watts)	0.2223	0.2218	0.2223	-	0.2228	-
ERP(dBm)	19.04	19.03	19.04	-	19.05	-
ERP(Watts)	0.0802	0.0800	0.0802	-	0.0804	-

LTE Band 13 (GT - LC = -2.28 dBi) 16QAM						
Bandwidth	5M			10M		
Channel	23205	23230	23255	23230		
	(Low)	(Mid)	(High)	-	(Mid)	-
Frequency	779.5	782	784.5	-	782	-
(MHz)						
Conducted Power (dBm)	22.81	22.82	22.83	-	22.74	-
Conducted Power (Watts)	0.1910	0.1914	0.1919	-	0.1879	-
ERP(dBm)	18.38	18.39	18.40	-	18.31	-
ERP(Watts)	0.0689	0.0690	0.0692	-	0.0678	-



LTE Band 17 (GT - LC = -2.30 dBi) QPSK						
Bandwidth	5M			10M		
Channel	23755	23790	23825	23780	23790	23800
	(Low)	(Mid)	(High)	(Low)	(Mid)	(High)
Frequency (MHz)	706.5	710	713.5	709	710	711
Conducted Power (dBm)	23.41	23.39	23.41	23.39	23.42	23.32
Conducted Power (Watts)	0.2193	0.2183	0.2193	0.2183	0.2198	0.2148
ERP(dBm)	18.96	18.94	18.96	18.94	18.97	18.87
ERP(Watts)	0.0787	0.0783	0.0787	0.0783	0.0789	0.0771

LTE Band 17 (GT - LC = -2.30 dBi) 16QAM						
Bandwidth	5M			10M		
Channel	23755	23790	23825	23780	23790	23800
	(Low)	(Mid)	(High)	(Low)	(Mid)	(High)
Frequency (MHz)	706.5	710	713.5	709	710	711
Conducted Power (dBm)	22.72	22.64	22.64	22.63	22.60	22.56
Conducted Power (Watts)	0.1871	0.1837	0.1837	0.1832	0.1820	0.1803
ERP(dBm)	18.27	18.19	18.19	18.18	18.15	18.11
ERP(Watts)	0.0671	0.0659	0.0659	0.0658	0.0653	0.0647



LTE Band 66 (GT - LC = -0.39 dBi) QPSK									
Bandwidth	1.4M			3M			5M		
Channel	131979	132322	132665	131987	132322	132657	131997	132322	132647
	(Low)	(Mid)	(High)	(Low)	(Mid)	(High)	(Low)	(Mid)	(High)
Frequency (MHz)	1710.7	1745	1779.3	1711.5	1745	1778.5	1712.5	1745	1777.5
Conducted Power (dBm)	23.20	23.22	23.27	23.28	23.24	23.24	23.23	23.26	23.27
Conducted Power (Watts)	0.2089	0.2099	0.2123	0.2128	0.2109	0.2109	0.2104	0.2118	0.2123
EIRP(dBm)	22.81	22.83	22.88	22.89	22.85	22.85	22.84	22.87	22.88
EIRP(Watts)	0.1910	0.1919	0.1941	0.1945	0.1928	0.1928	0.1923	0.1936	0.1941

LTE Band 66 (GT - LC = -0.39 dBi) QPSK									
Bandwidth	10M			15M			20M		
Channel	132022	132322	132622	132047	132322	132597	132072	132322	132572
	(Low)	(Mid)	(High)	(Low)	(Mid)	(High)	(Low)	(Mid)	(Mid)
Frequency (MHz)	1715	1745	1775	1717.5	1745	1772.5	1720	1745	1770
Conducted Power (dBm)	23.20	23.24	23.27	23.27	23.26	23.24	23.22	23.29	23.27
Conducted Power (Watts)	0.2089	0.2109	0.2123	0.2123	0.2118	0.2109	0.2099	0.2133	0.2123
EIRP(dBm)	22.81	22.85	22.88	22.88	22.87	22.85	22.83	22.90	22.88
EIRP(Watts)	0.1910	0.1928	0.1941	0.1941	0.1936	0.1928	0.1919	0.1950	0.1941



LTE Band 66 (GT - LC = -0.39 dBi) 16QAM									
Bandwidth	1.4M			3M			5M		
Channel	131979	132322	132665	131987	132322	132657	131997	132322	132647
	(Low)	(Mid)	(High)	(Low)	(Mid)	(High)	(Low)	(Mid)	(High)
Frequency (MHz)	1710.7	1745	1779.3	1711.5	1745	1778.5	1712.5	1745	1777.5
Conducted Power (dBm)	22.46	22.50	22.45	22.42	22.49	22.47	22.48	22.46	22.45
Conducted Power (Watts)	0.1762	0.1778	0.1758	0.1746	0.1774	0.1766	0.1770	0.1762	0.1758
EIRP(dBm)	22.07	22.11	22.06	22.03	22.10	22.08	22.09	22.07	22.06
EIRP(Watts)	0.1611	0.1626	0.1607	0.1596	0.1622	0.1614	0.1618	0.1611	0.1607

LTE Band 66 (GT - LC = -0.39 dBi) 16QAM									
Bandwidth	10M			15M			20M		
Channel	132022	132322	132622	132047	132322	132597	132072	132322	132572
	(Low)	(Mid)	(High)	(Low)	(Mid)	(High)	(Low)	(Mid)	(Mid)
Frequency (MHz)	1715	1745	1775	1717.5	1745	1772.5	1720	1745	1770
Conducted Power (dBm)	22.48	22.44	22.46	22.34	22.37	22.48	22.44	22.42	22.44
Conducted Power (Watts)	0.1770	0.1754	0.1762	0.1714	0.1726	0.1770	0.1754	0.1746	0.1754
EIRP(dBm)	22.09	22.05	22.07	21.95	21.98	22.09	22.05	22.03	22.05
EIRP(Watts)	0.1618	0.1603	0.1611	0.1567	0.1578	0.1618	0.1603	0.1596	0.1603



Peak-to-Average Ratio

Mode	LTE Band 2 / 20MHz				
Mod.	QPSK		16QAM		Limit: 13dB
RB Size	1RB	Full RB	1RB	Full RB	Result
Lowest CH	4.58	5.19	5.39	5.94	PASS
Middle CH	5.07	5.19	6.26	6.14	
Highest CH	4.78	5.13	5.97	6.00	

Mode	LTE Band 4 / 20MHz				
Mod.	QPSK		16QAM		Limit: 13dB
RB Size	1RB	Full RB	1RB	Full RB	Result
Lowest CH	4.09	4.84	5.22	5.77	PASS
Middle CH	4.43	5.01	5.59	5.86	
Highest CH	4.78	5.13	5.62	6.09	

Mode	LTE Band 5 / 10MHz				
Mod.	QPSK		16QAM		Limit: 13dB
RB Size	1RB	Full RB	1RB	Full RB	Result
Lowest CH	4.78	4.96	6.12	5.83	PASS
Middle CH	3.97	5.28	4.72	6.03	
Highest CH	5.30	5.28	6.09	6.17	

Mode	LTE Band 7 / 20MHz				
Mod.	QPSK		16QAM		Limit: 13dB
RB Size	1RB	Full RB	1RB	Full RB	Result
Lowest CH	4.06	4.64	4.90	5.57	PASS
Middle CH	4.17	4.70	4.90	5.65	
Highest CH	3.74	4.70	4.58	5.71	



Mode	LTE Band 12 / 10MHz				
Mod.	QPSK		16QAM		Limit: 13dB
RB Size	1RB	Full RB	1RB	Full RB	Result
Lowest CH	4.75	5.36	5.88	6.20	PASS
Middle CH	5.01	5.28	5.71	6.17	
Highest CH	5.10	5.22	6.12	6.06	

Mode	LTE Band 13 / 10MHz				
Mod.	QPSK		16QAM		Limit: 13dB
RB Size	1RB	Full RB	1RB	Full RB	Result
Lowest CH	-	-	-	-	PASS
Middle CH	5.01	5.48	6.14	6.35	
Highest CH	-	-	-	-	

Mode	LTE Band 17 / 10MHz				
Mod.	QPSK		16QAM		Limit: 13dB
RB Size	1RB	Full RB	1RB	Full RB	Result
Lowest CH	4.75	5.13	5.91	5.88	PASS
Middle CH	5.07	5.19	6.38	5.91	
Highest CH	5.10	4.96	6.26	5.88	

Mode	LTE Band 66 / 20MHz				
Mod.	QPSK		16QAM		Limit: 13dB
RB Size	1RB	Full RB	1RB	Full RB	Result
Lowest CH	4.84	4.78	4.72	5.71	PASS
Middle CH	4.52	5.10	5.83	6.00	
Highest CH	4.70	5.04	5.62	6.00	



LTE Band 2 / 20MHz / QPSK

Lowest Channel / 1RB

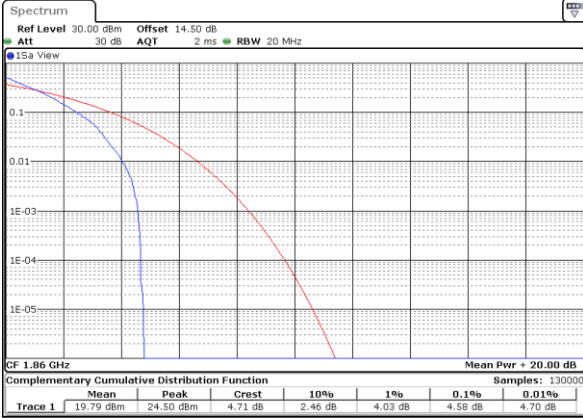

Date: 5 JUN 2018 04:03:28

Lowest Channel / Full RB

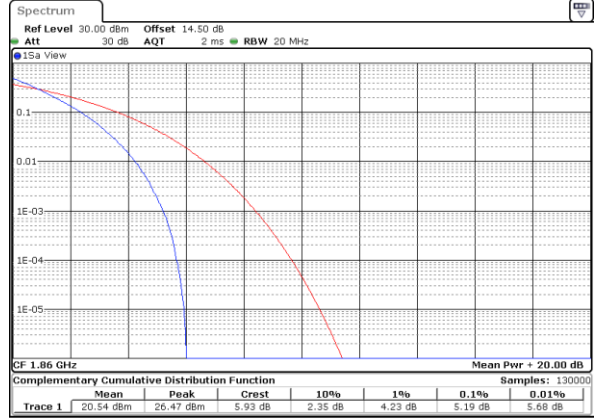

Date: 5 JUN 2018 04:02:52

Middle Channel / 1RB

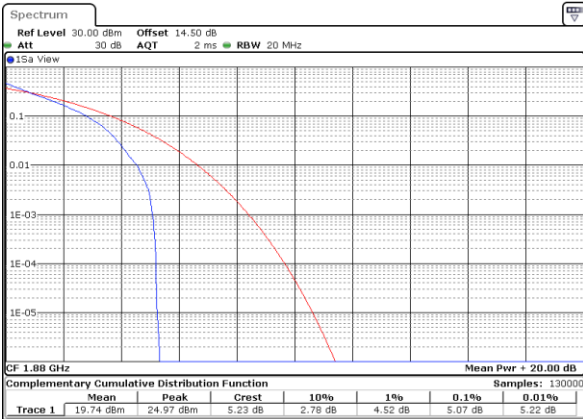

Date: 5 JUN 2018 04:03:48

Middle Channel / Full RB

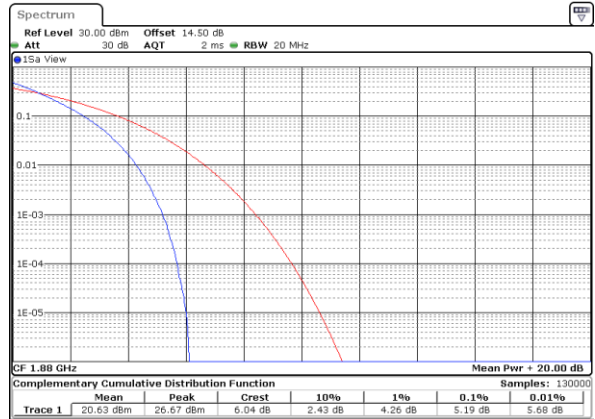

Date: 5 JUN 2018 04:03:09

Highest Channel / 1RB

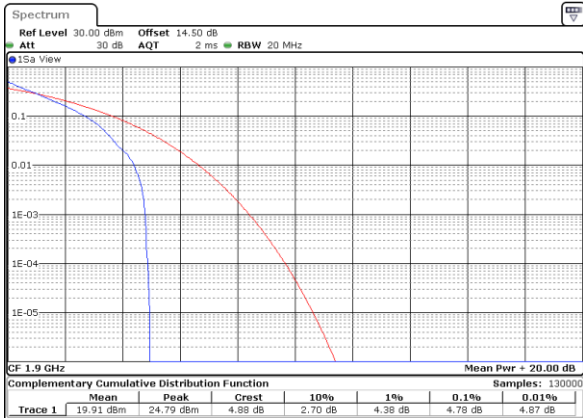

Date: 5 JUN 2018 04:07:13

Highest Channel / Full RB

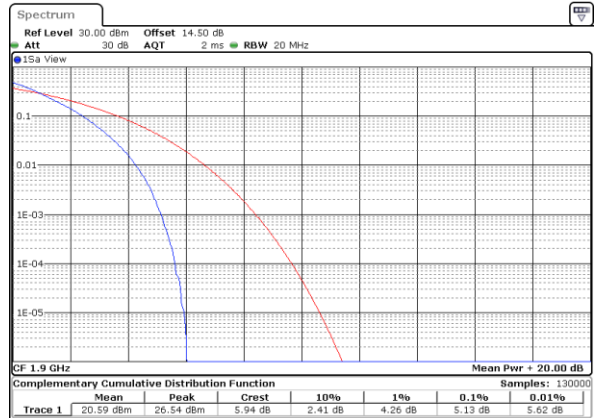

Date: 5 JUN 2018 04:03:18



LTE Band 2 / 20MHz / 16QAM

Lowest Channel / 1RB

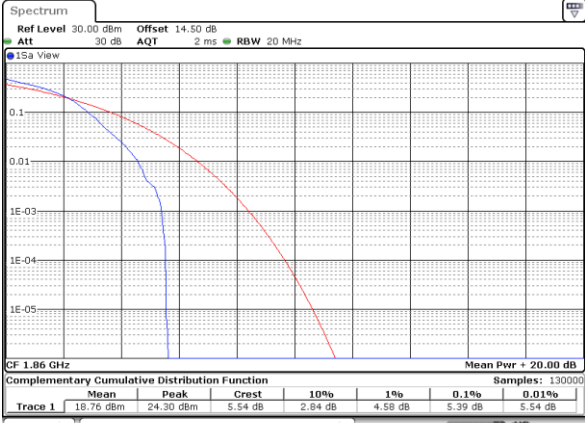

Date: 5 JUN 2018 03:54:44

Lowest Channel / Full RB

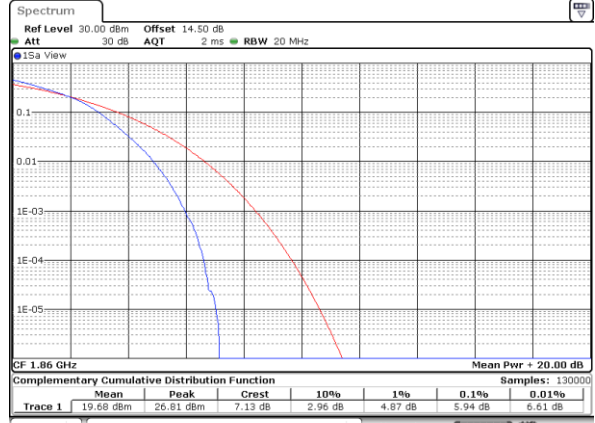

Date: 5 JUN 2018 03:54:53

Middle Channel / 1RB

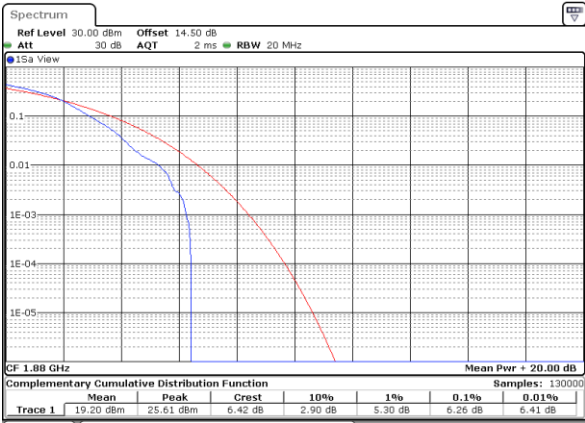

Date: 5 JUN 2018 03:55:08

Middle Channel / Full RB

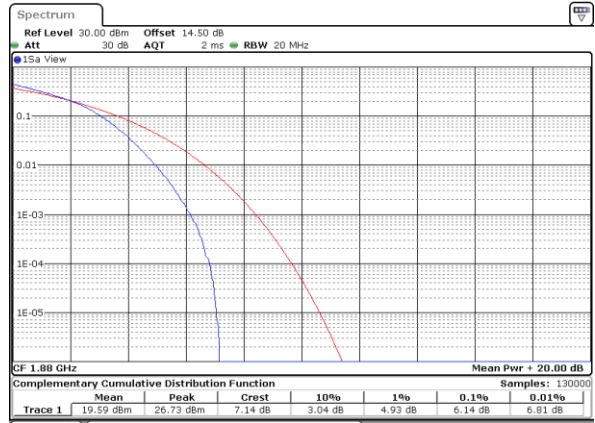

Date: 5 JUN 2018 03:55:36

Highest Channel / 1RB

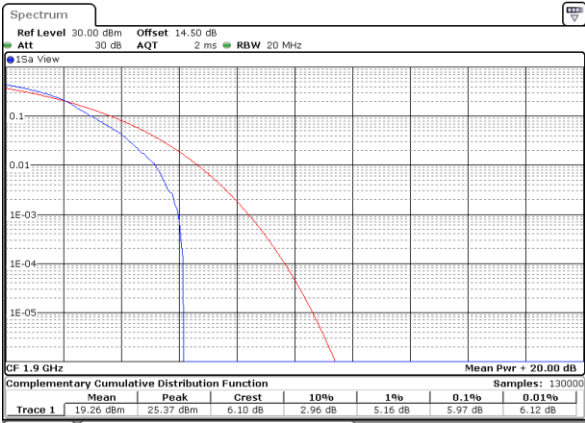

Date: 5 JUN 2018 03:55:48

Highest Channel / Full RB

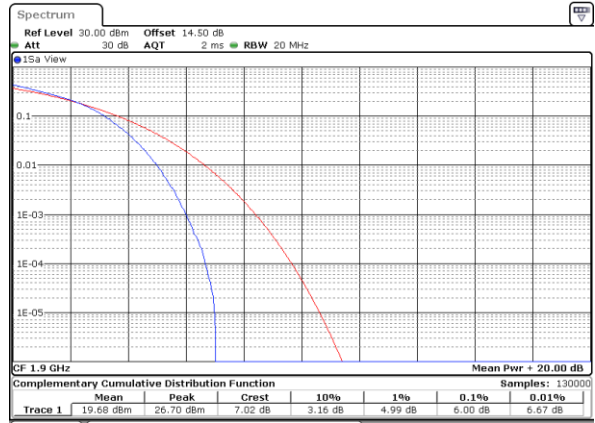

Date: 5 JUN 2018 03:56:00



LTE Band 4 / 20MHz / QPSK

Lowest Channel / 1RB

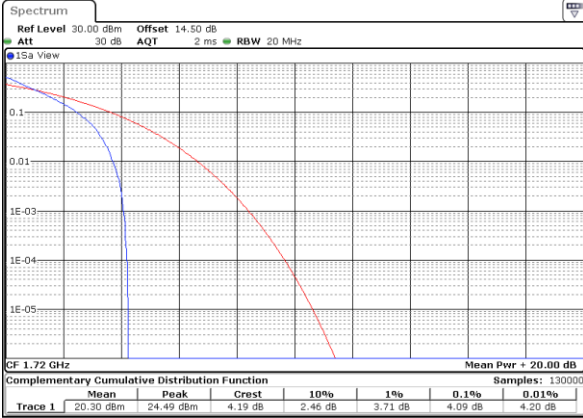

Date: 5 JUN 2018 10:13:36

Lowest Channel / Full RB

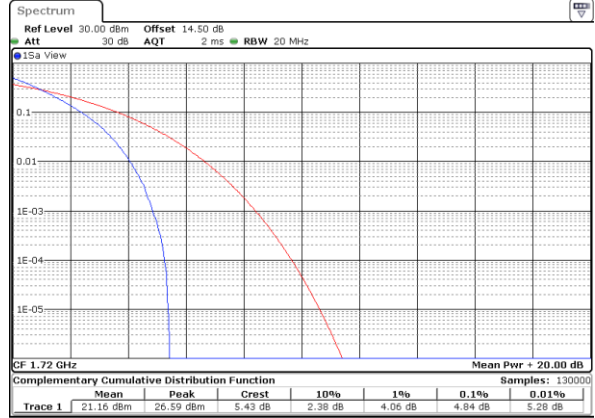

Date: 5 JUN 2018 10:13:45

Middle Channel / 1RB

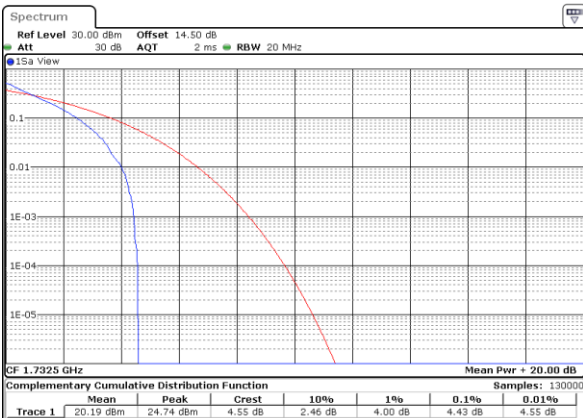

Date: 5 JUN 2018 10:13:55

Middle Channel / Full RB

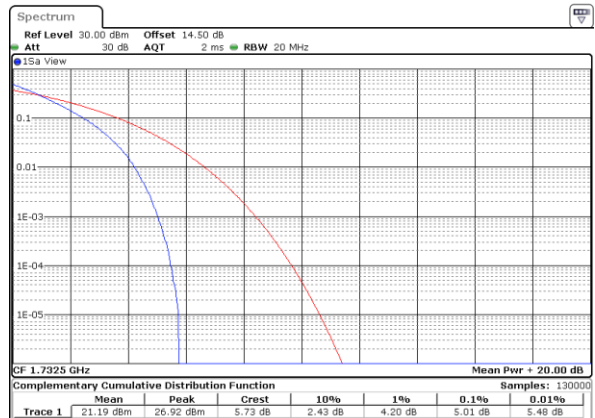

Date: 5 JUN 2018 10:14:05

Highest Channel / 1RB



Date: 5 JUN 2018 10:14:15

Highest Channel / Full RB



Date: 5 JUN 2018 10:14:24



LTE Band 4 / 20MHz / 16QAM

Lowest Channel / 1RB

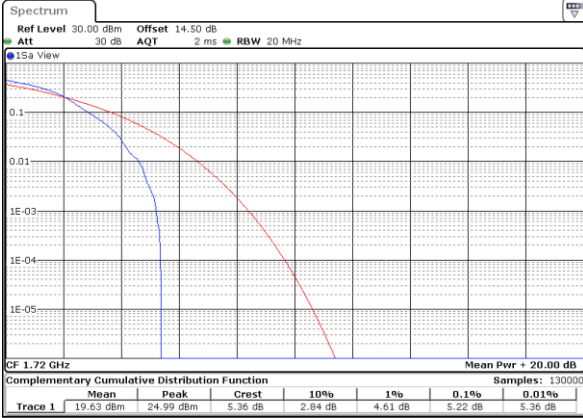

Date: 5 JUN 2018 10:11:40

Lowest Channel / Full RB

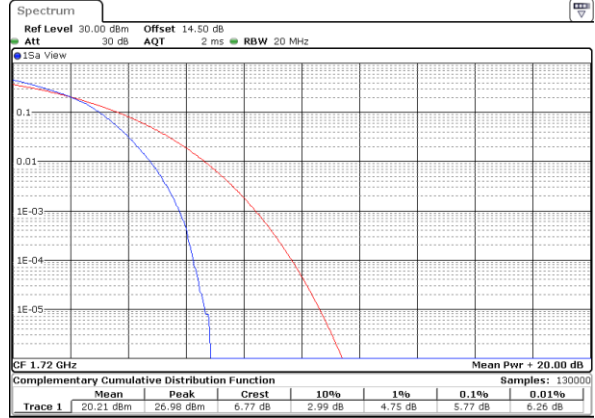

Date: 5 JUN 2018 10:11:49

Middle Channel / 1RB

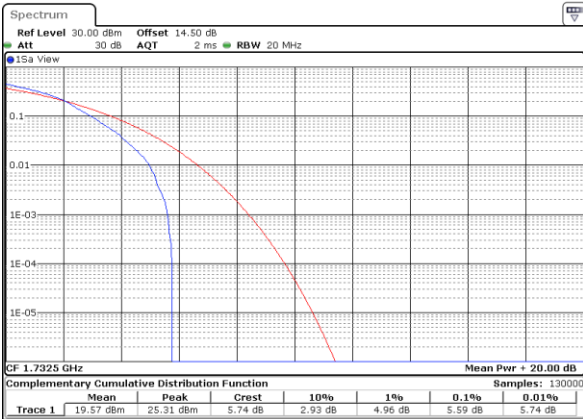

Date: 5 JUN 2018 10:11:58

Middle Channel / Full RB

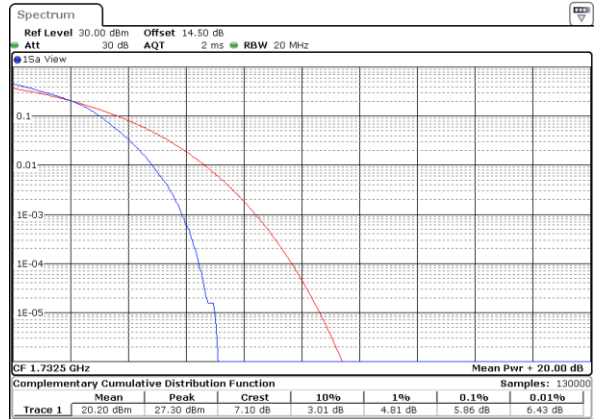

Date: 5 JUN 2018 10:12:09

Highest Channel / 1RB

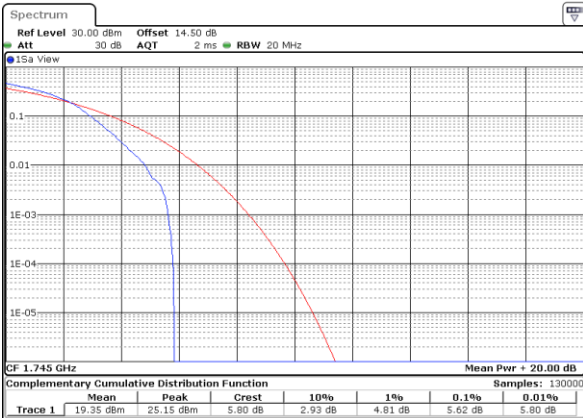

Date: 5 JUN 2018 10:12:21

Highest Channel / Full RB

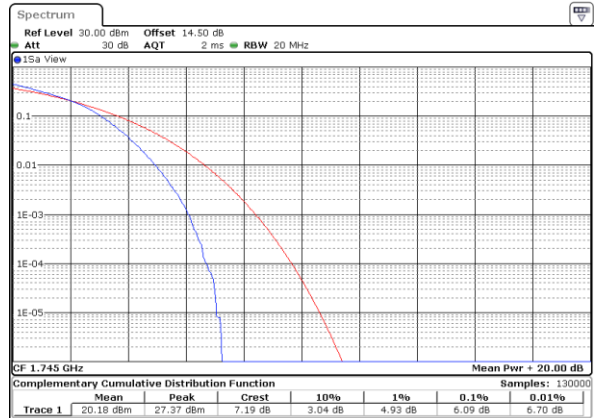

Date: 5 JUN 2018 10:13:22



LTE Band 5 / 10MHz / QPSK

Lowest Channel / 1RB

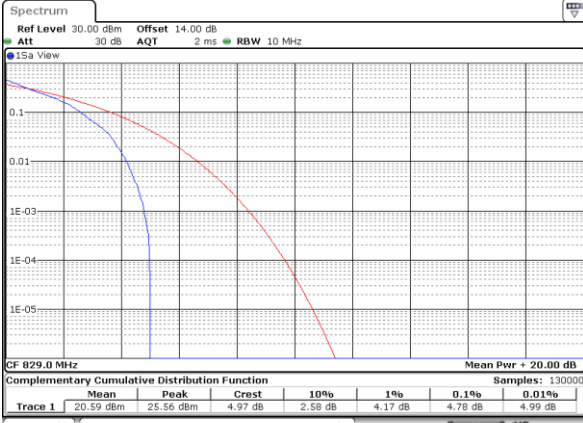

Date: 5 JUN 2018 05:54:33

Lowest Channel / Full RB

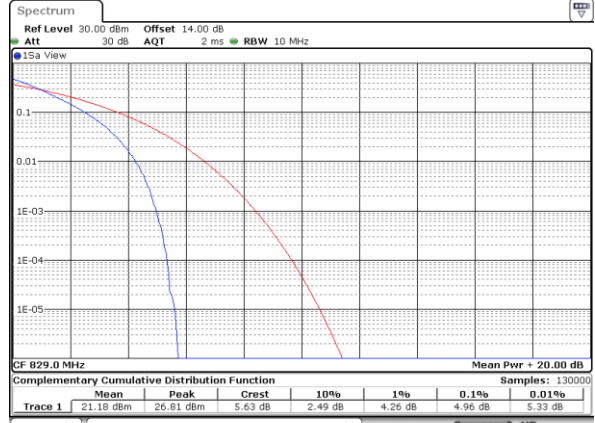

Date: 5 JUN 2018 05:53:35

Middle Channel / 1RB

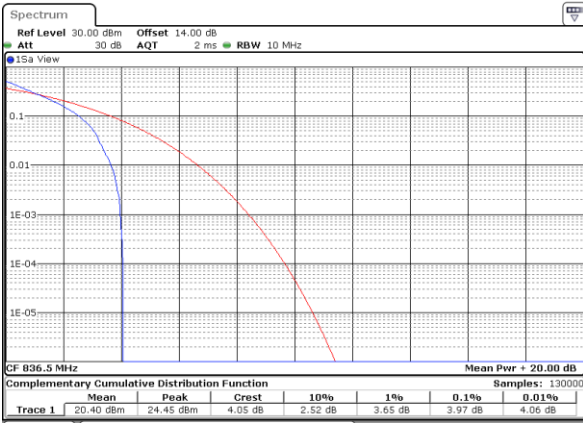

Date: 5 JUN 2018 05:54:57

Middle Channel / Full RB

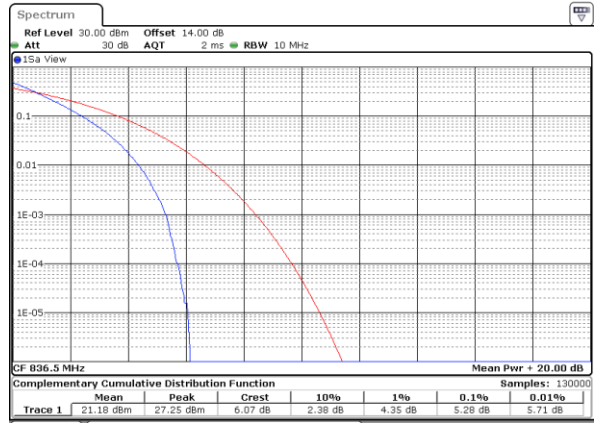

Date: 5 JUN 2018 05:53:44

Highest Channel / 1RB

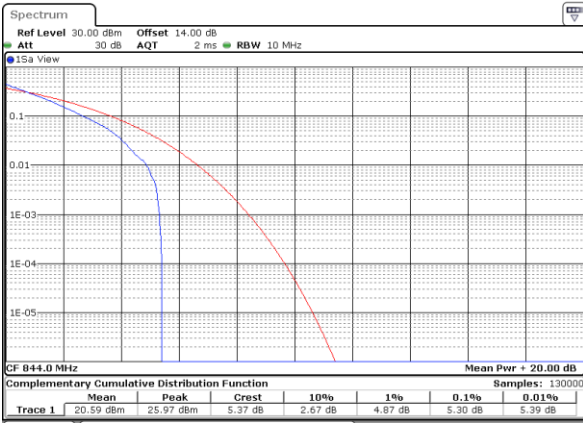

Date: 5 JUN 2018 05:56:03

Highest Channel / Full RB

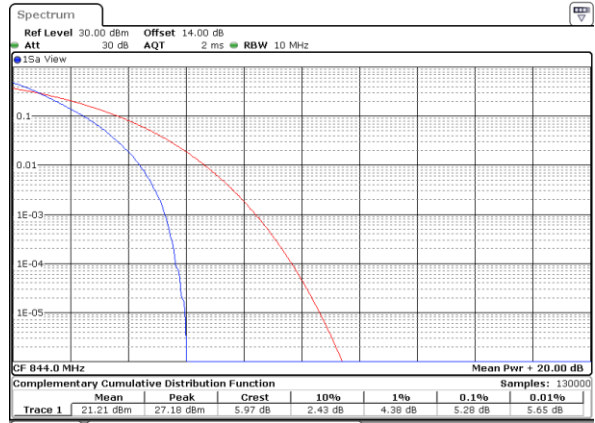

Date: 5 JUN 2018 05:54:16



LTE Band 5 / 10MHz / 16QAM

Lowest Channel / 1RB

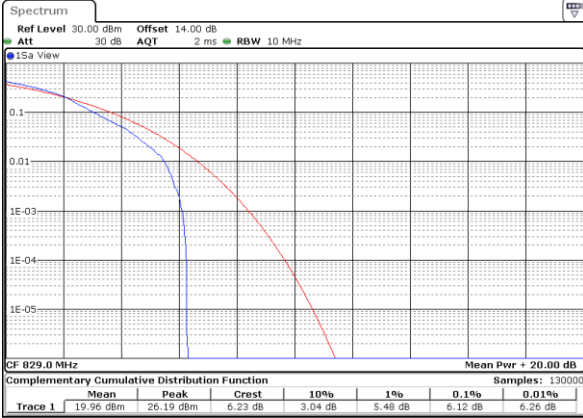

Date: 5 JUN 2018 05:51:58

Lowest Channel / Full RB

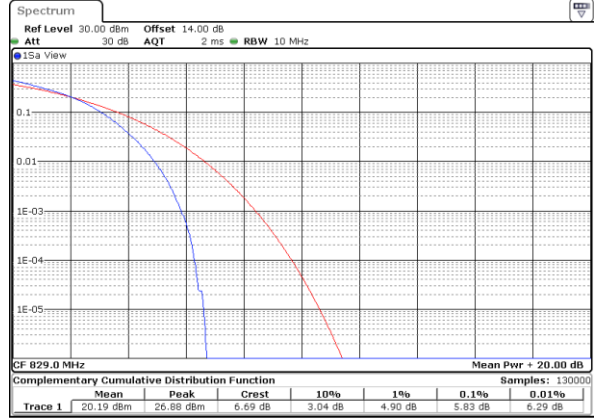

Date: 5 JUN 2018 05:52:08

Middle Channel / 1RB

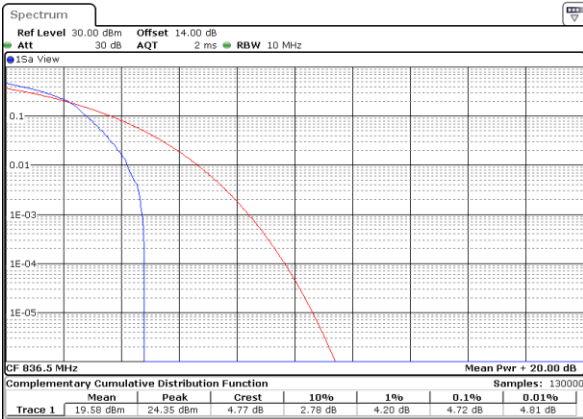

Date: 5 JUN 2018 05:52:32

Middle Channel / Full RB

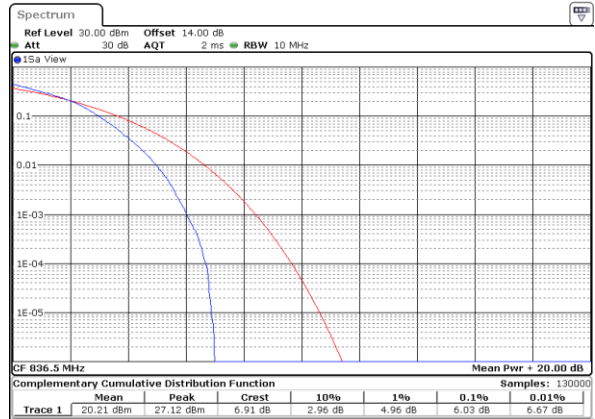

Date: 5 JUN 2018 05:52:47

Highest Channel / 1RB



Date: 5 JUN 2018 05:52:59

Highest Channel / Full RB

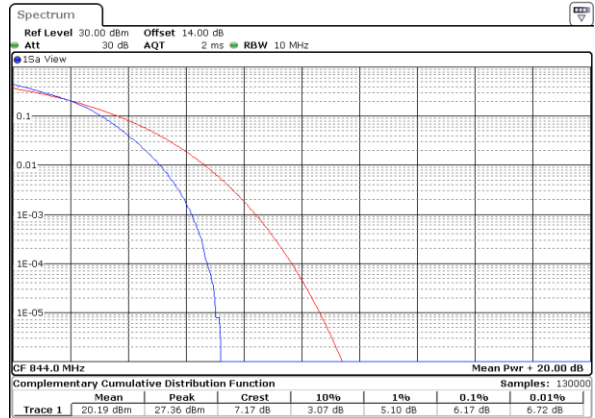

Date: 5 JUN 2018 05:53:10



LTE Band 7 / 20MHz / QPSK

Lowest Channel / 1RB

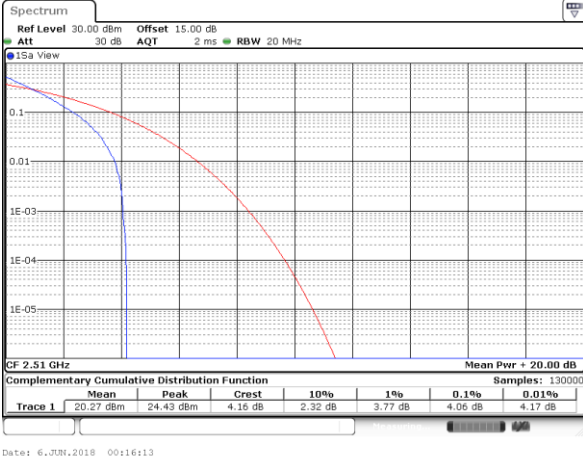

Date: 6 JUN 2018 00:16:13

Lowest Channel / Full RB

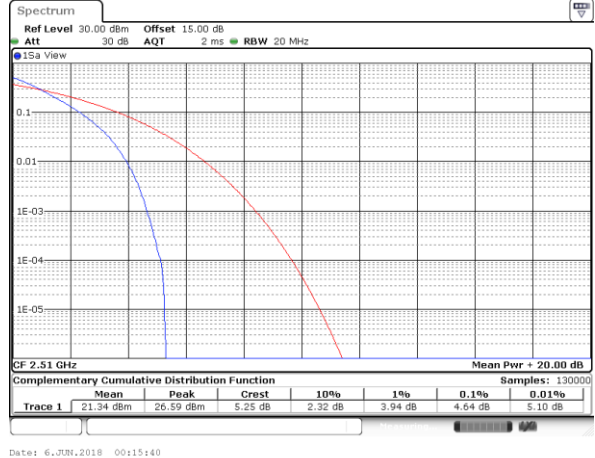

Date: 6 JUN 2018 00:15:40

Middle Channel / 1RB

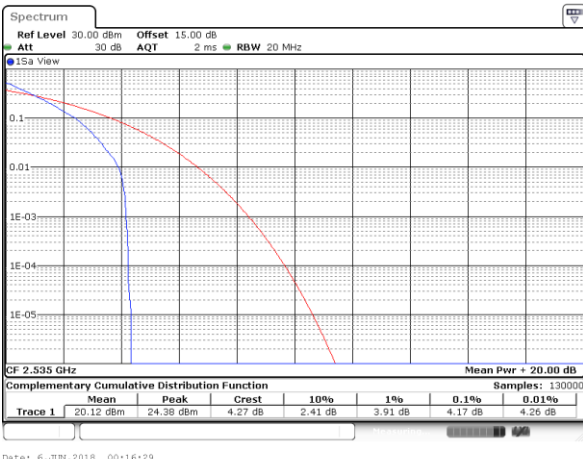

Date: 6 JUN 2018 00:16:20

Middle Channel / Full RB

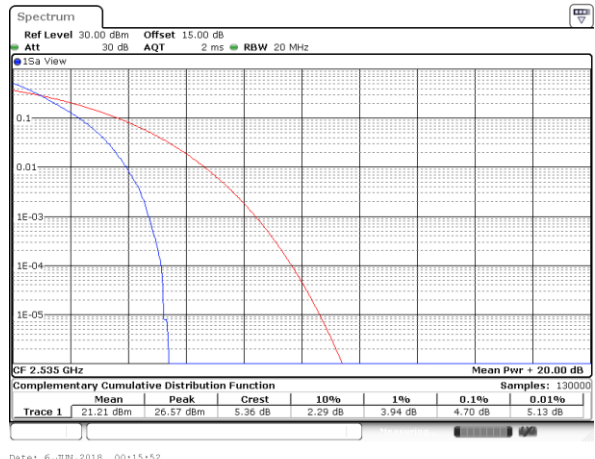

Date: 6 JUN 2018 00:15:52

Highest Channel / 1RB

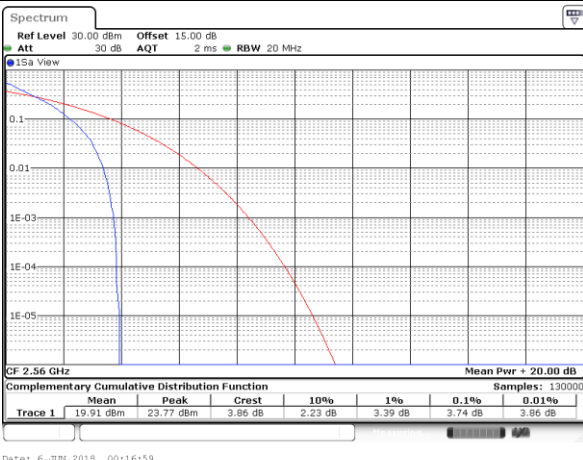

Date: 6 JUN 2018 00:16:59

Highest Channel / Full RB

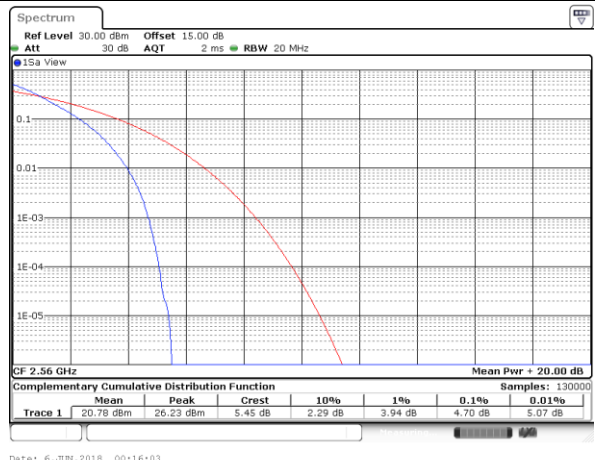

Date: 6 JUN 2018 00:16:03



LTE Band 7 / 20MHz / 16QAM

Lowest Channel / 1RB

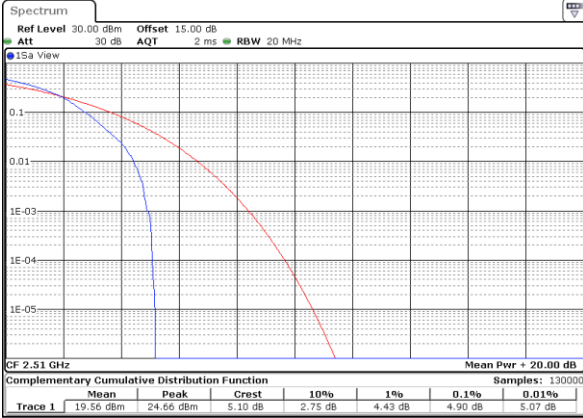

Date: 6 JUN 2018 00:18:18

Lowest Channel / Full RB

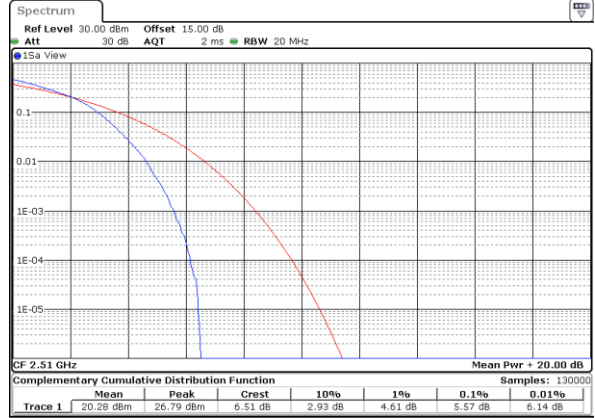

Date: 6 JUN 2018 00:17:12

Middle Channel / 1RB

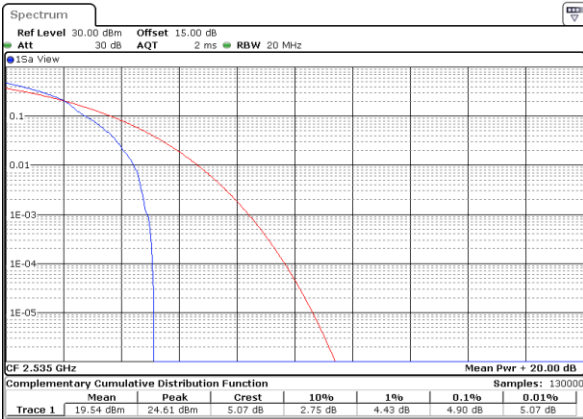

Date: 6 JUN 2018 00:18:29

Middle Channel / Full RB

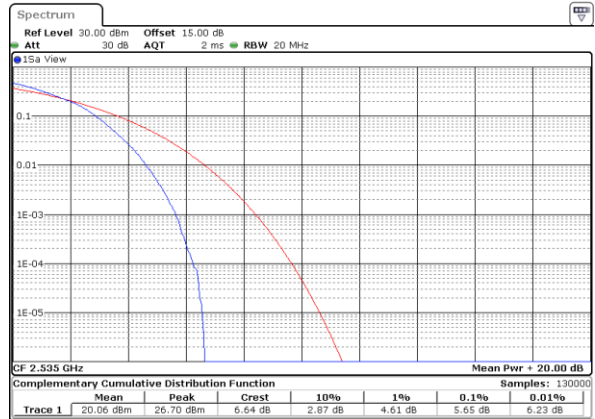

Date: 6 JUN 2018 00:17:24

Highest Channel / 1RB

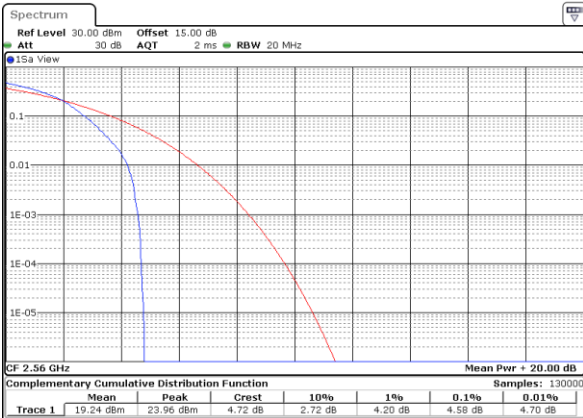

Date: 6 JUN 2018 00:18:46

Highest Channel / Full RB

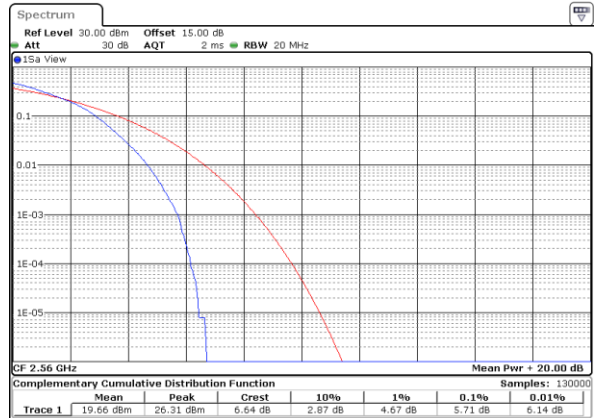

Date: 6 JUN 2018 00:18:08



LTE Band 12 / 10MHz / QPSK

Lowest Channel / 1RB

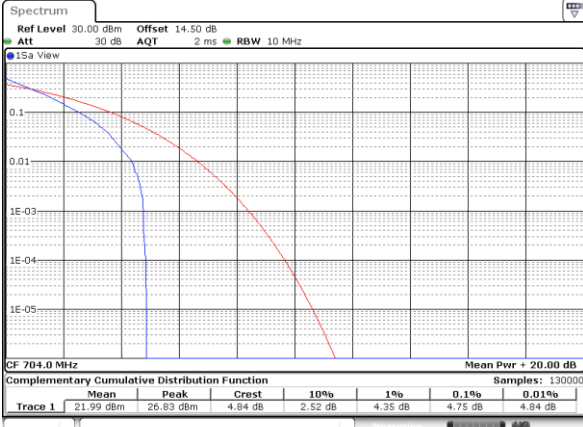

Date: 6 JUN 2018 22:11:48

Lowest Channel / Full RB

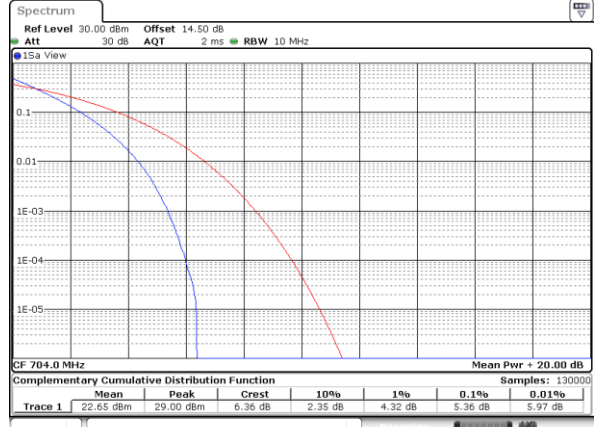

Date: 6 JUN 2018 22:12:07

Middle Channel / 1RB

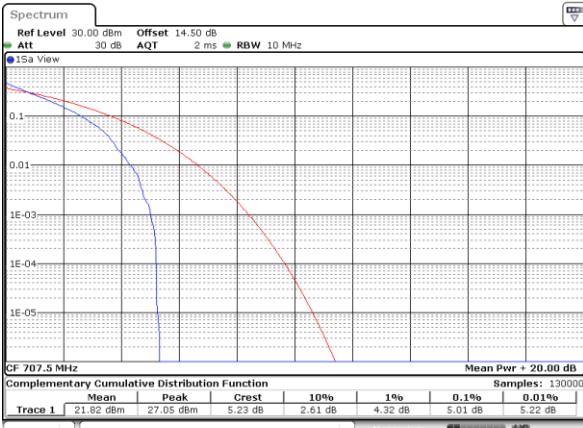

Date: 6 JUN 2018 22:13:01

Middle Channel / Full RB

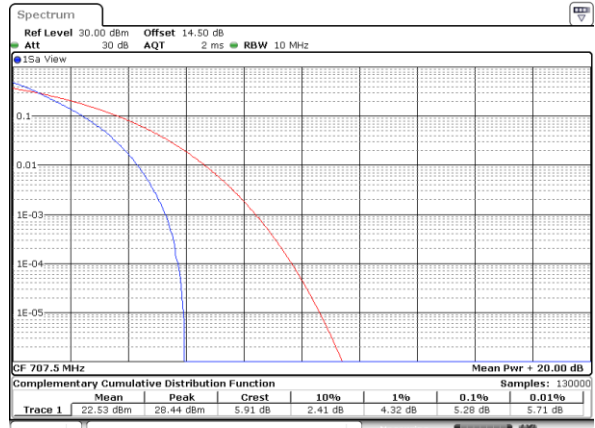

Date: 6 JUN 2018 22:13:11

Highest Channel / 1RB

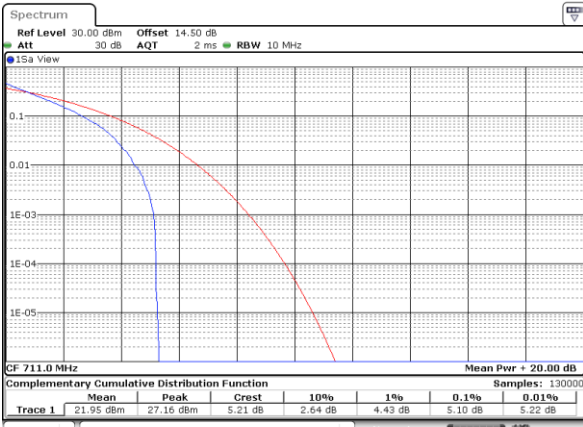

Date: 6 JUN 2018 22:15:32

Highest Channel / Full RB

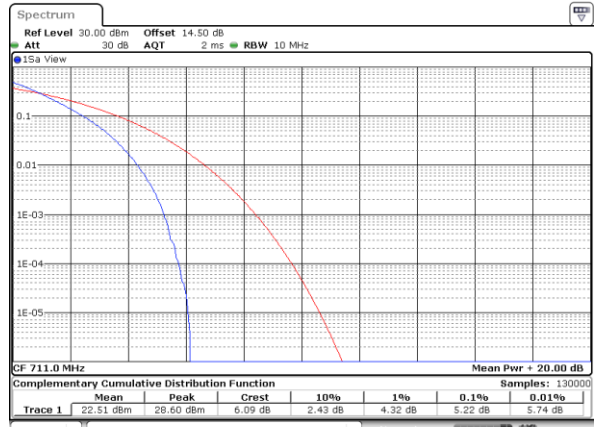

Date: 6 JUN 2018 22:15:47



LTE Band 12 / 10MHz / 16QAM

Lowest Channel / 1RB

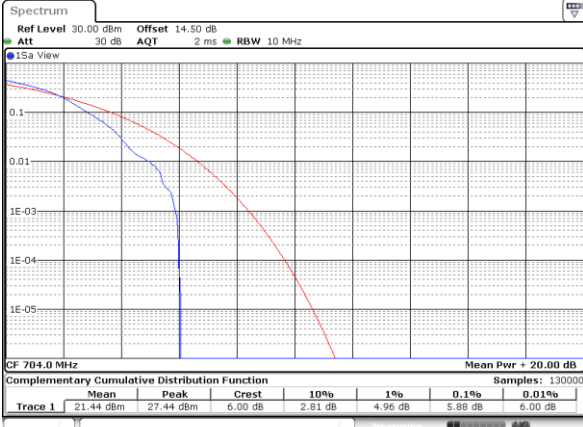

Date: 6 JUN 2018 22:02:04

Lowest Channel / Full RB

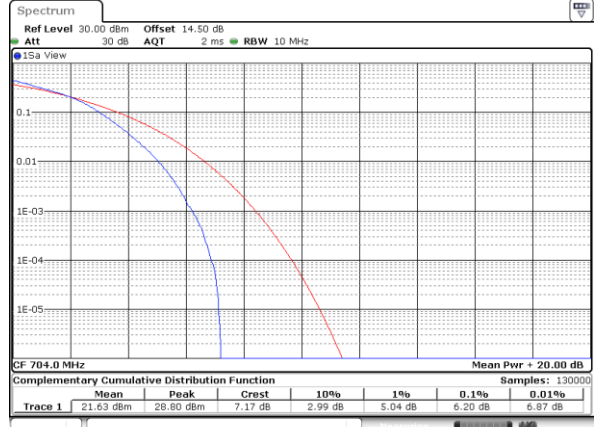

Date: 6 JUN 2018 22:02:19

Middle Channel / 1RB

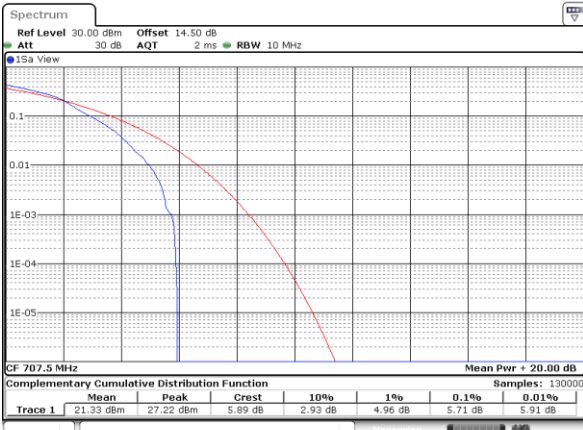

Date: 6 JUN 2018 22:07:19

Middle Channel / Full RB

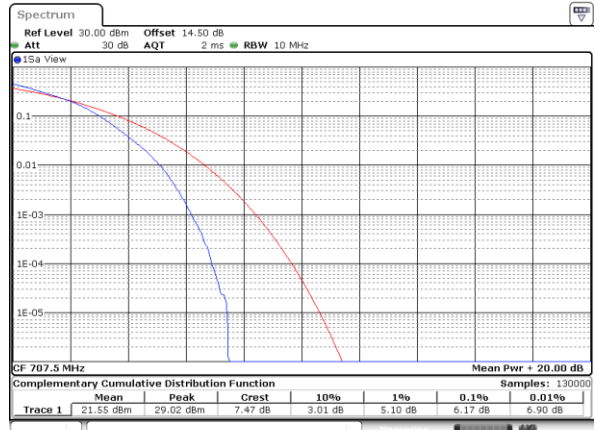

Date: 6 JUN 2018 22:08:15

Highest Channel / 1RB

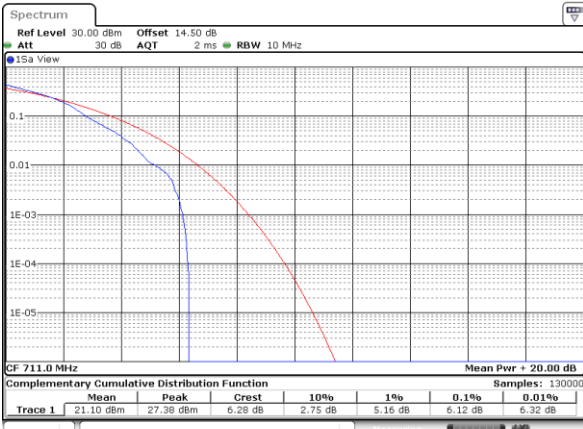

Date: 6 JUN 2018 22:08:28

Highest Channel / Full RB

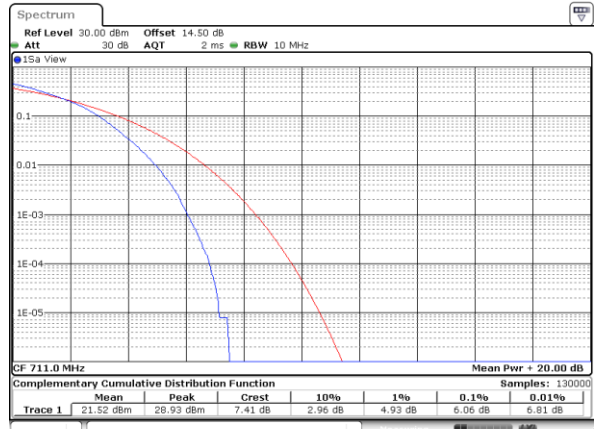

Date: 6 JUN 2018 22:08:37



LTE Band 13 / 10MHz / QPSK

Middle Channel/ 1RB

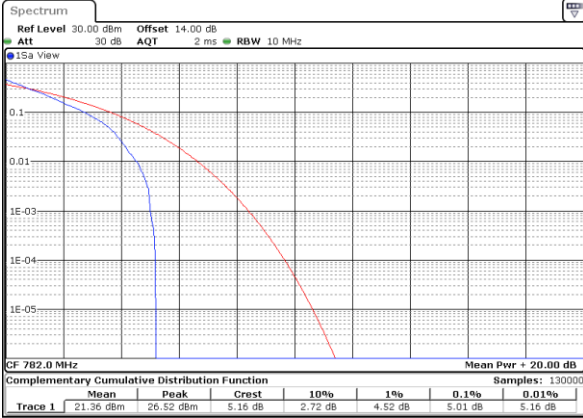

Date: 7 JUN 2018 10:11:32

Middle Channel / Full RB

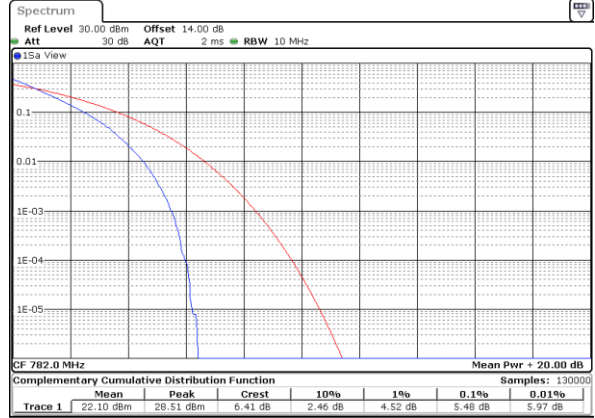

Date: 7 JUN 2018 10:12:25

LTE Band 13 / 10MHz / 16QAM

Middle Channel/ 1RB

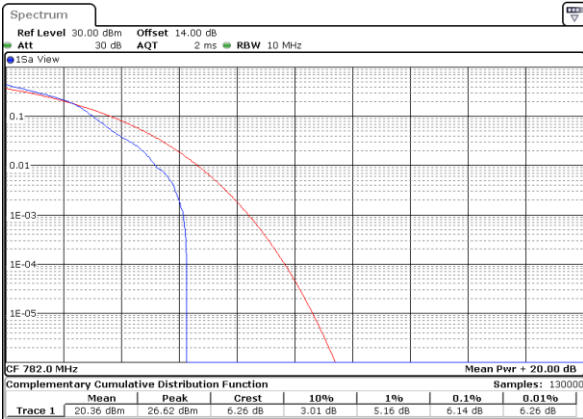

Date: 7 JUN 2018 09:45:27

Middle Channel / Full RB

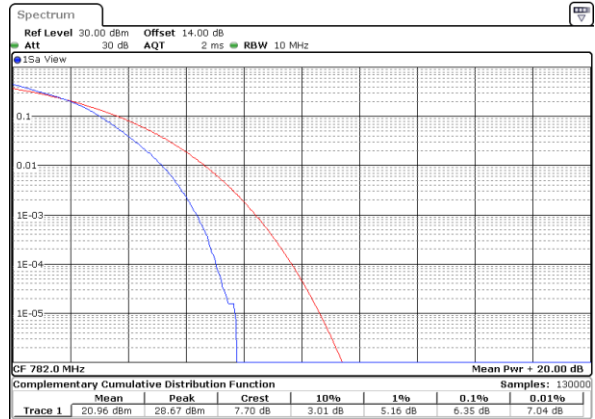

Date: 7 JUN 2018 10:11:18



LTE Band 17 / 10MHz / QPSK

Lowest Channel / 1RB

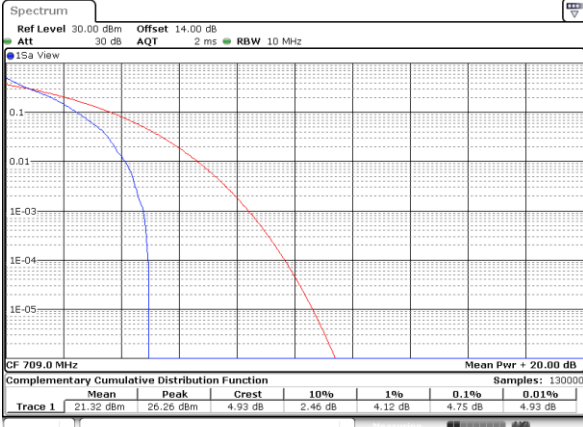

Date: 7 JUN 2018 16:29:39

Lowest Channel / Full RB

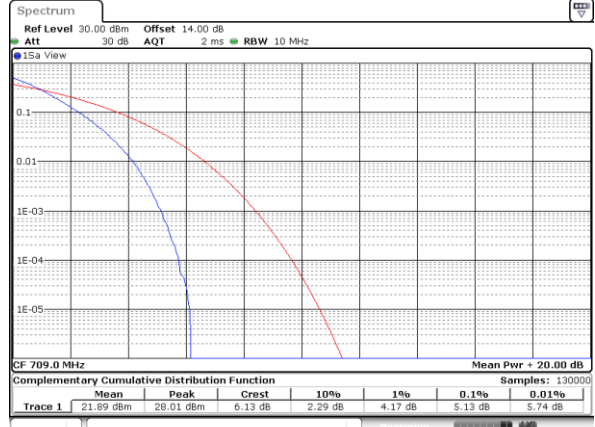

Date: 7 JUN 2018 16:31:23

Middle Channel / 1RB

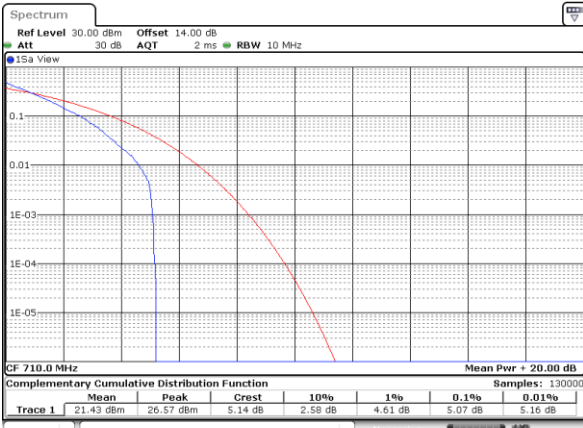

Date: 7 JUN 2018 16:38:43

Middle Channel / Full RB

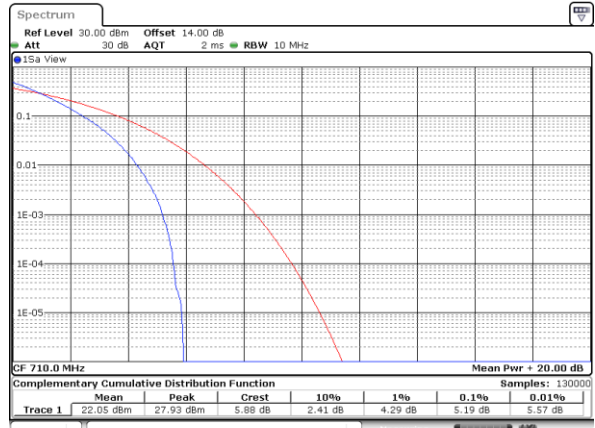

Date: 7 JUN 2018 16:41:43

Highest Channel / 1RB

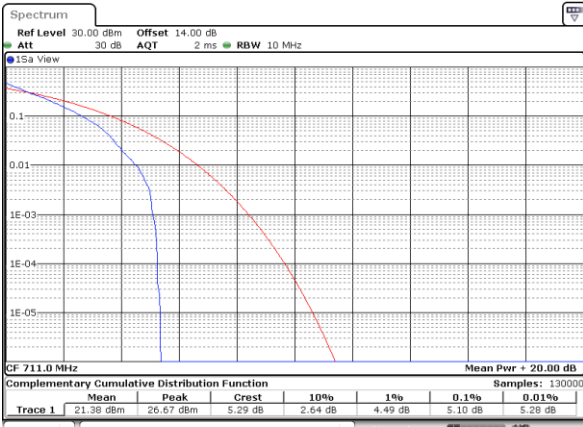

Date: 7 JUN 2018 16:42:15

Highest Channel / Full RB

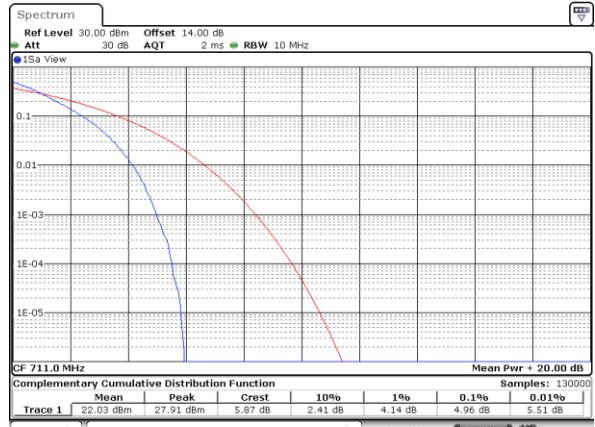

Date: 7 JUN 2018 16:55:05



LTE Band 17 / 10MHz / 16QAM

Lowest Channel / 1RB

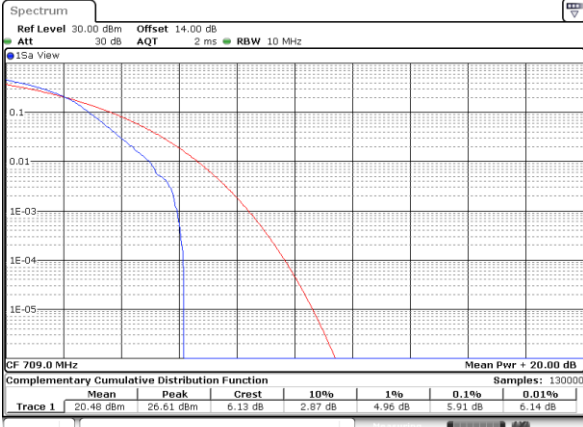

Date: 7 JUN 2018 15:44:36

Lowest Channel / Full RB

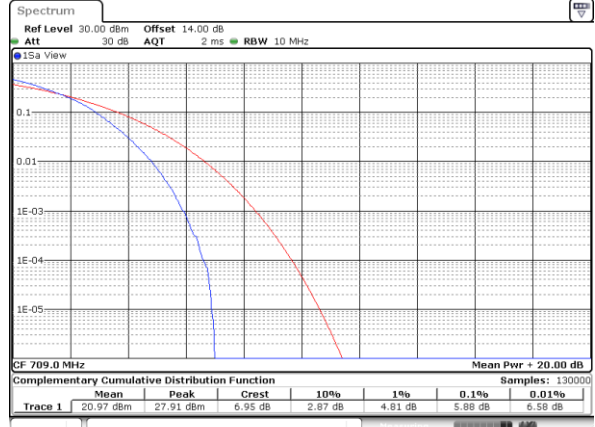

Date: 7 JUN 2018 15:50:03

Middle Channel / 1RB

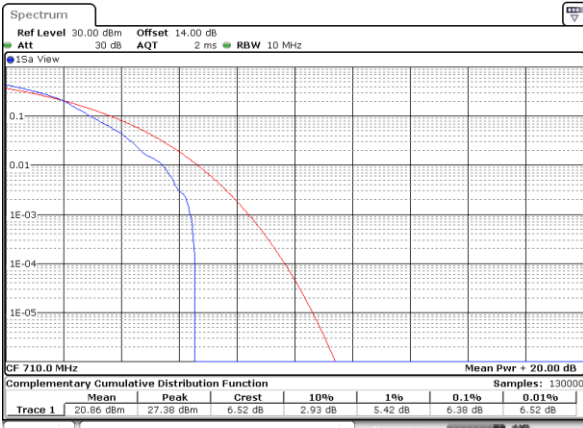

Date: 7 JUN 2018 15:57:52

Middle Channel / Full RB

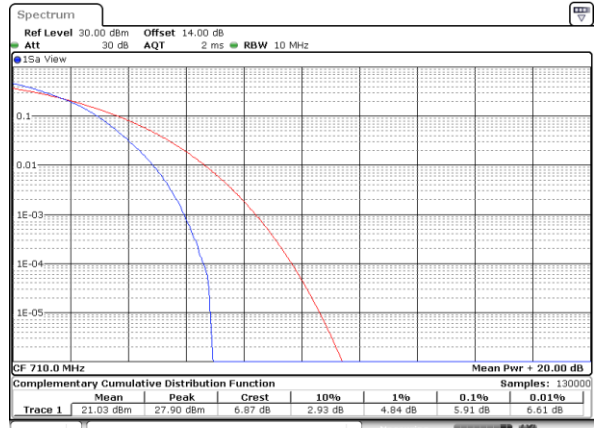

Date: 7 JUN 2018 16:05:35

Highest Channel / 1RB

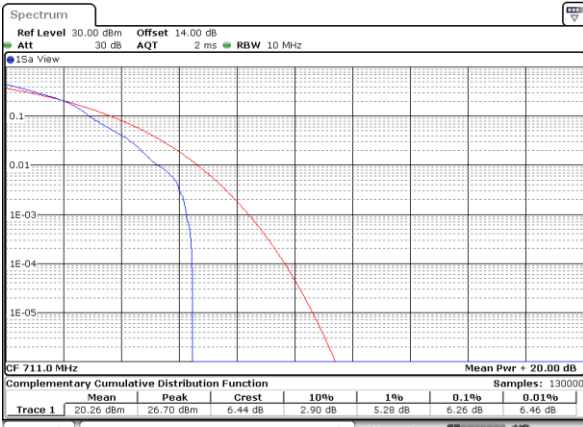

Date: 7 JUN 2018 16:13:35

Highest Channel / Full RB

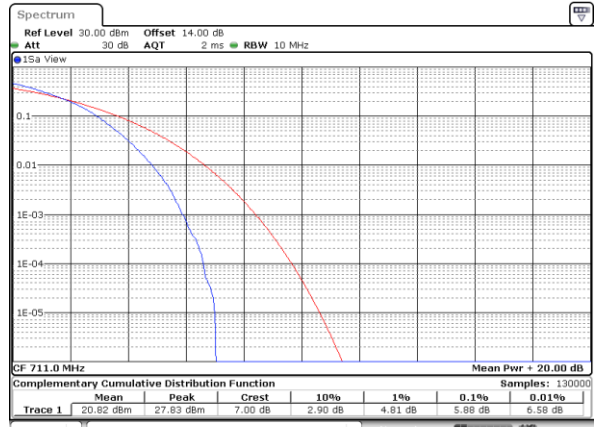

Date: 7 JUN 2018 16:26:45



LTE Band 66 / 20MHz / QPSK

Lowest Channel / 1RB

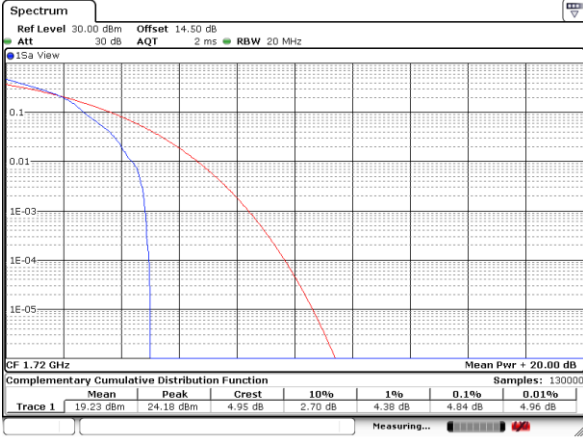

Date: 8 JUN 2018 14:39:56

Lowest Channel / Full RB

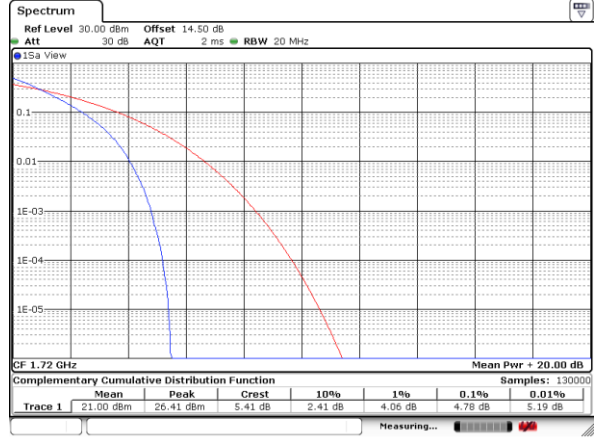

Date: 8 JUN 2018 14:37:52

Middle Channel / 1RB

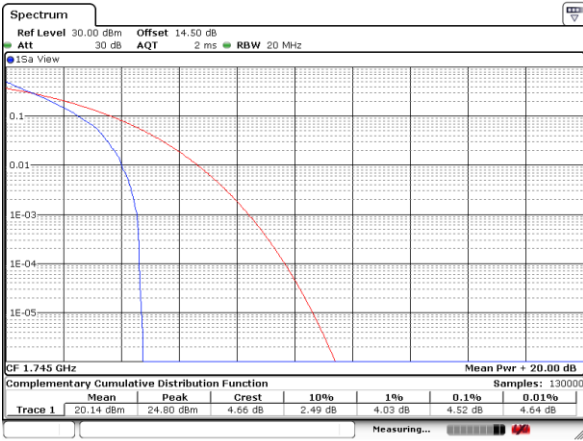

Date: 8 JUN 2018 14:49:12

Middle Channel / Full RB

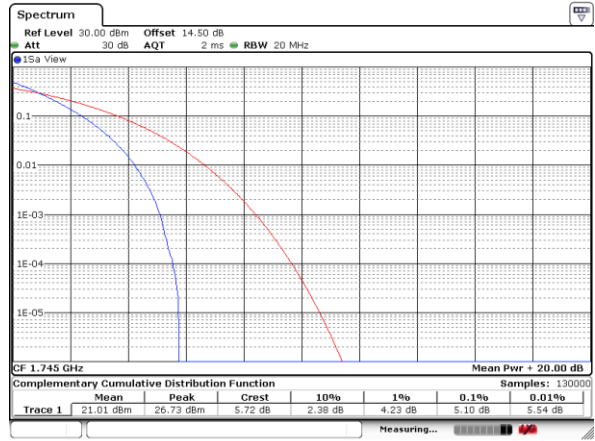

Date: 8 JUN 2018 14:51:51

Highest Channel / 1RB

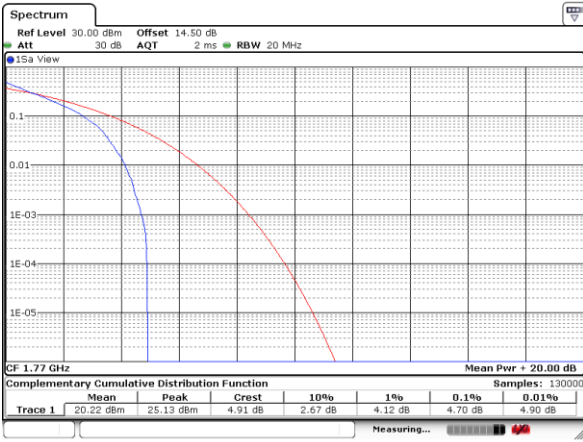

Date: 8 JUN 2018 14:54:42

Highest Channel / Full RB

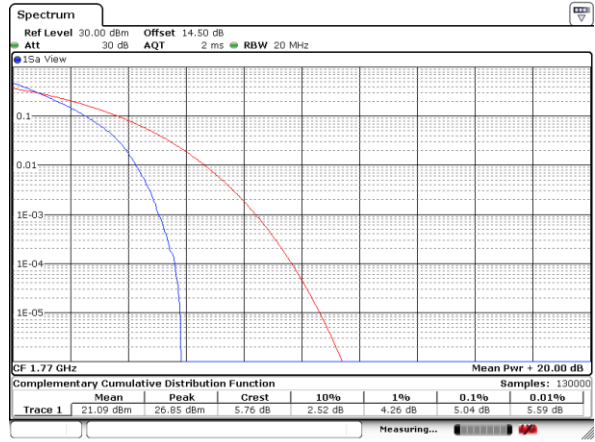

Date: 8 JUN 2018 14:54:12



LTE Band 66 / 20MHz / 16QAM

Lowest Channel / 1RB

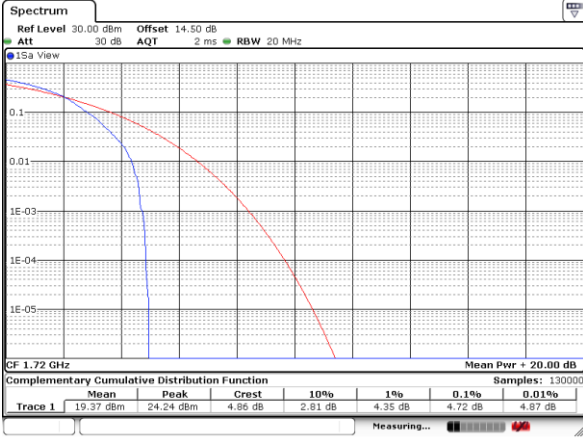

Date: 8 JUN 2018 14:43:55

Lowest Channel / Full RB

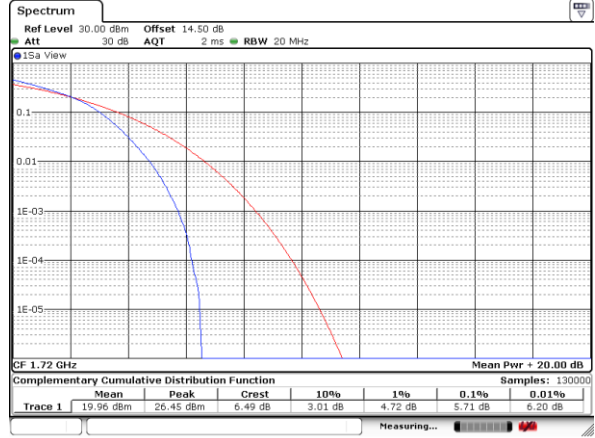

Date: 8 JUN 2018 14:43:31

Middle Channel / 1RB

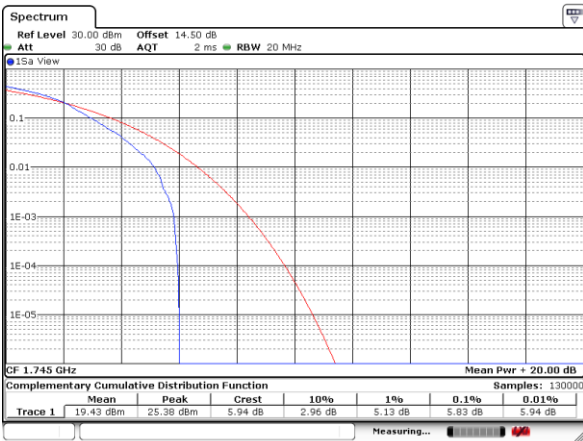

Date: 8 JUN 2018 14:48:17

Middle Channel / Full RB

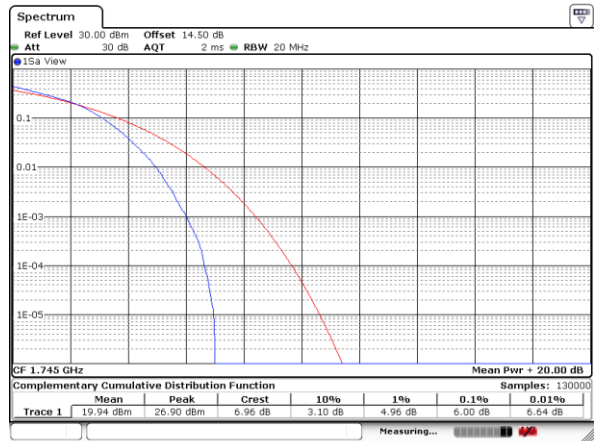

Date: 8 JUN 2018 14:52:42

Highest Channel / 1RB

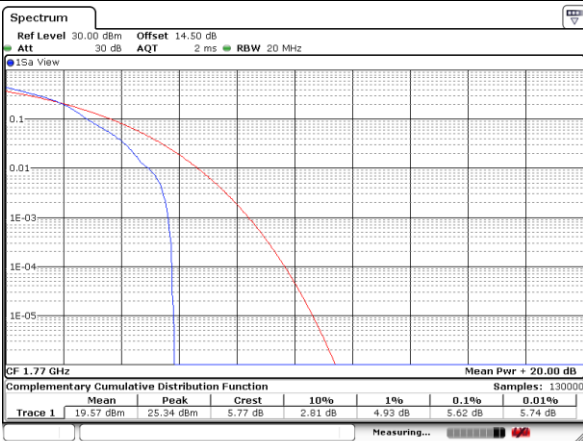

Date: 8 JUN 2018 14:56:39

Highest Channel / Full RB



Date: 8 JUN 2018 14:52:45



26dB Bandwidth

Mode	LTE Band 2 : 26dB BW(MHz)											
	1.4MHz		3MHz		5MHz		10MHz		15MHz		20MHz	
Mod.	QPSK	16QAM	QPSK	16QAM	QPSK	16QAM	QPSK	16QAM	QPSK	16QAM	QPSK	16QAM
Lowest CH	1.250	1.284	2.955	2.925	4.935	5.075	10.05	10.11	14.775	14.625	20.659	20.22
Middle CH	1.253	1.290	2.931	2.943	5.055	4.985	9.89	9.71	14.086	14.685	20.46	20.22
Highest CH	1.270	1.256	2.961	2.979	5.025	5.115	9.99	10.09	14.116	14.595	20.38	20.18

Mode	LTE Band 4 : 26dB BW(MHz)											
	1.4MHz		3MHz		5MHz		10MHz		15MHz		20MHz	
Mod.	QPSK	16QAM	QPSK	16QAM	QPSK	16QAM	QPSK	16QAM	QPSK	16QAM	QPSK	16QAM
Lowest CH	1.276	1.278	2.985	2.961	5.005	5.045	9.91	9.93	14.775	14.236	20.699	20.02
Middle CH	1.248	1.276	2.961	2.943	5.015	4.885	9.81	9.89	14.116	14.505	20.46	20.10
Highest CH	1.278	1.264	2.949	2.973	5.015	5.085	9.67	9.89	14.715	14.535	20.34	20.22

Mode	LTE Band 5 : 26dB BW(MHz)											
	1.4MHz		3MHz		5MHz		10MHz		15MHz		20MHz	
Mod.	QPSK	16QAM	QPSK	16QAM	QPSK	16QAM	QPSK	16QAM	QPSK	16QAM	QPSK	16QAM
Lowest CH	1.284	1.284	2.985	2.949	5.095	4.985	10.19	10.01	-	-	-	-
Middle CH	1.259	1.234	2.943	2.943	5.075	4.955	9.81	10.15	-	-	-	-
Highest CH	1.239	1.301	2.925	2.955	5.125	4.945	9.79	9.83	-	-	-	-

Mode	LTE Band 7 : 26dB BW(MHz)											
	1.4MHz		3MHz		5MHz		10MHz		15MHz		20MHz	
Mod.	QPSK	16QAM	QPSK	16QAM	QPSK	16QAM	QPSK	16QAM	QPSK	16QAM	QPSK	16QAM
Lowest CH	-	-	-	-	5.095	5.165	10.01	9.91	14.326	14.266	20.14	20.10
Middle CH	-	-	-	-	5.195	4.995	9.67	9.83	14.416	14.745	20.14	20.26
Highest CH	-	-	-	-	4.885	4.935	9.89	9.83	14.775	14.565	20.46	20.739



Mode	LTE Band 12 : 26dB BW(MHz)											
BW	1.4MHz		3MHz		5MHz		10MHz		15MHz		20MHz	
Mod.	QPSK	16QAM	QPSK	16QAM	QPSK	16QAM	QPSK	16QAM	QPSK	16QAM	QPSK	16QAM
Lowest CH	1.290	1.301	2.943	2.961	5.095	4.995	10.15	9.87	-	-	-	-
Middle CH	1.267	1.309	2.955	2.949	5.015	5.025	9.77	9.85	-	-	-	-
Highest CH	1.287	1.287	2.967	2.973	5.065	5.055	9.91	10.01	-	-	-	-

Mode	LTE Band 13 : 26dB BW(MHz)											
BW	1.4MHz		3MHz		5MHz		10MHz		15MHz		20MHz	
Mod.	QPSK	16QAM	QPSK	16QAM	QPSK	16QAM	QPSK	16QAM	QPSK	16QAM	QPSK	16QAM
Lowest CH	-	-	-	-	5.115	5.135	-	-	-	-	-	-
Middle CH	-	-	-	-	5.115	4.935	9.75	9.99	-	-	-	-
Highest CH	-	-	-	-	4.995	5.085	-	-	-	-	-	-

Mode	LTE Band 17 : 26dB BW(MHz)											
BW	1.4MHz		3MHz		5MHz		10MHz		15MHz		20MHz	
Mod.	QPSK	16QAM	QPSK	16QAM	QPSK	16QAM	QPSK	16QAM	QPSK	16QAM	QPSK	16QAM
Lowest CH	-	-	-	-	5.045	5.025	9.77	9.73	-	-	-	-
Middle CH	-	-	-	-	4.925	5.015	9.95	9.99	-	-	-	-
Highest CH	-	-	-	-	4.925	4.955	9.89	9.77	-	-	-	-

Mode	LTE Band 66 : 26dB BW(MHz)											
BW	1.4MHz		3MHz		5MHz		10MHz		15MHz		20MHz	
Mod.	QPSK	16QAM	QPSK	16QAM	QPSK	16QAM	QPSK	16QAM	QPSK	16QAM	QPSK	16QAM
Lowest CH	1.278	1.287	2.955	2.967	5.005	4.995	9.75	9.81	14.655	14.535	20.26	20.30
Middle CH	1.259	1.276	2.949	2.967	5.085	4.955	9.69	9.93	14.535	14.865	20.06	20.34
Highest CH	1.262	1.250	2.937	2.919	5.055	5.055	9.85	9.65	15.435	14.685	20.14	20.34



LTE Band 2

Lowest Channel / 1.4MHz / QPSK

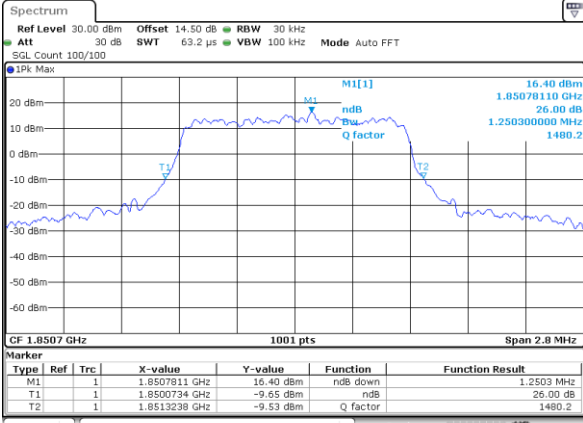

Date: 4 JUN 2018 22:22:17

Lowest Channel / 1.4MHz / 16QAM

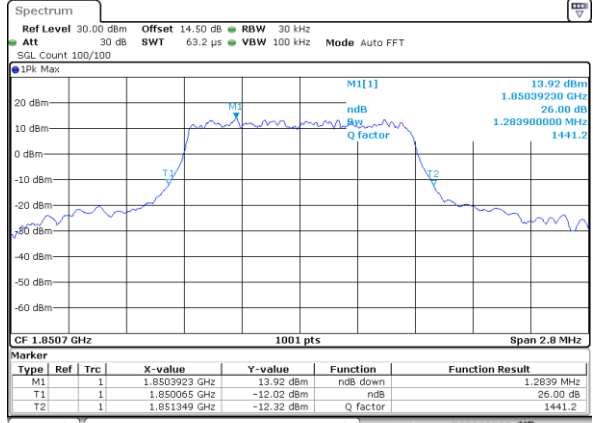

Date: 4 JUN 2018 22:22:47

Middle Channel / 1.4MHz / QPSK

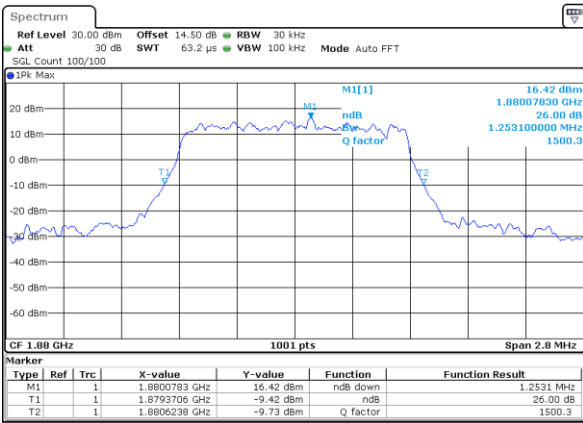

Date: 4 JUN 2018 22:22:48

Middle Channel / 1.4MHz / 16QAM

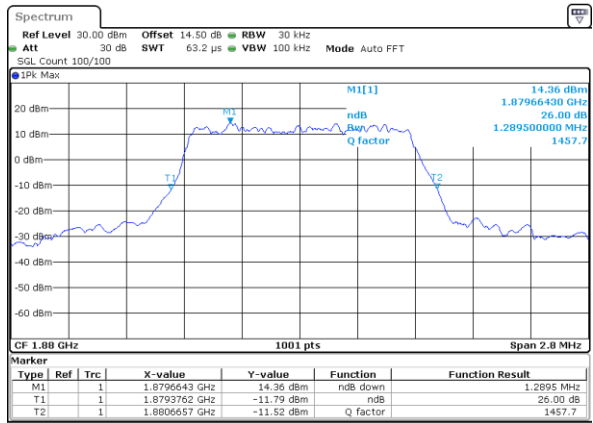

Date: 4 JUN 2018 22:22:58

Highest Channel / 1.4MHz / QPSK

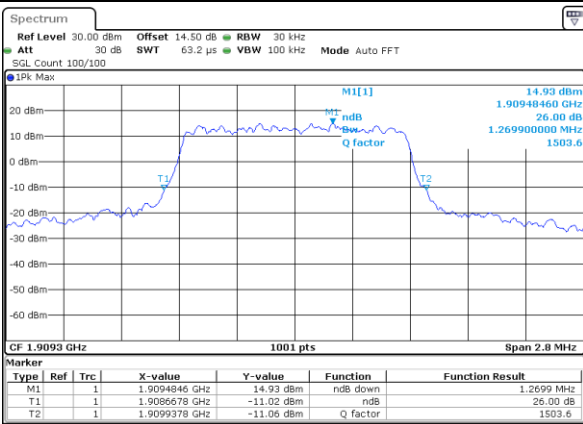

Date: 4 JUN 2018 22:32:20

Highest Channel / 1.4MHz / 16QAM

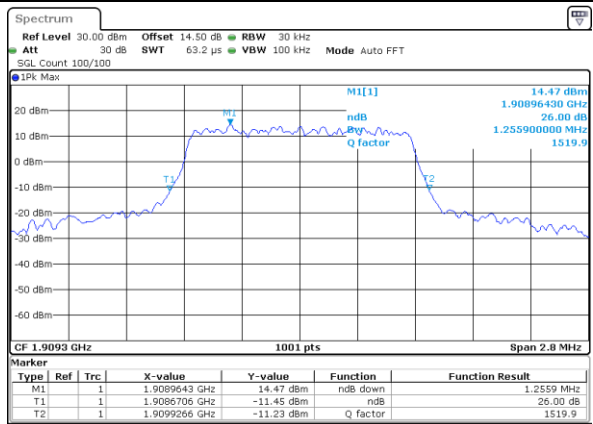

Date: 4 JUN 2018 22:32:30



LTE Band 2

Lowest Channel / 3MHz / QPSK

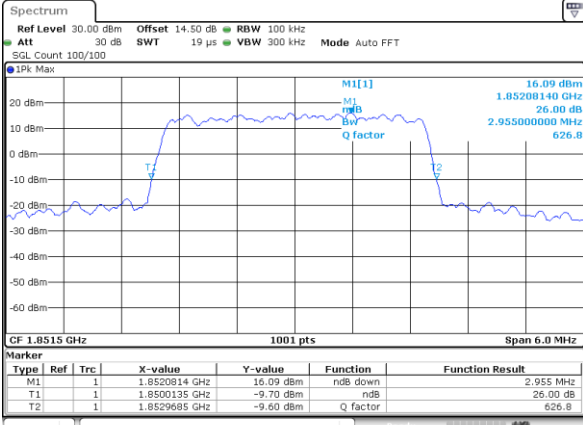

Date: 4 JUN 2018 22:48:18

Lowest Channel / 3MHz / 16QAM

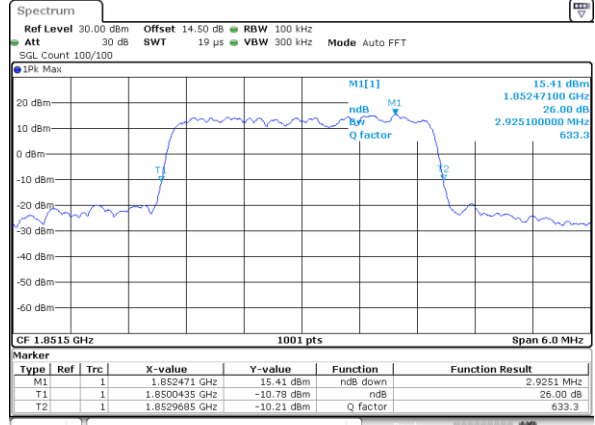

Date: 4 JUN 2018 22:48:28

Middle Channel / 3MHz / QPSK

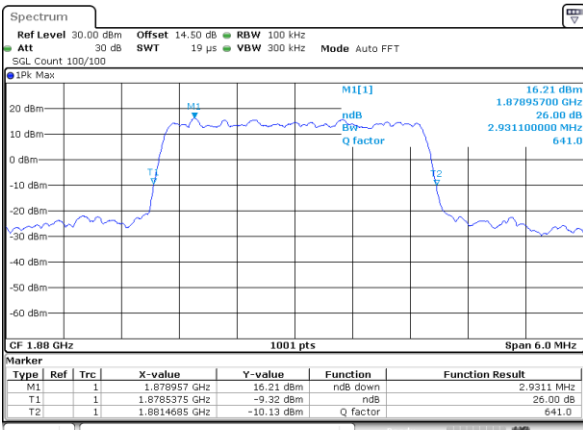

Date: 4 JUN 2018 22:55:31

Middle Channel / 3MHz / 16QAM

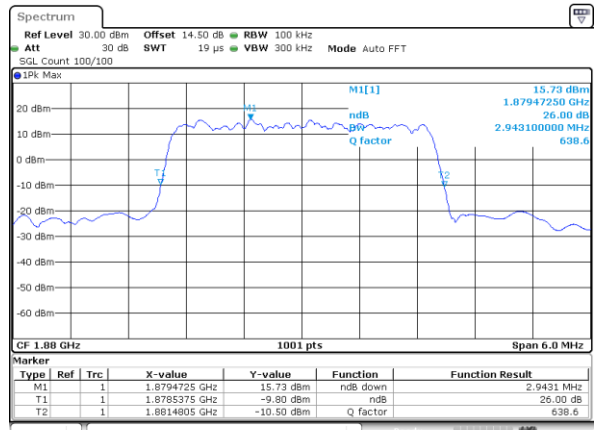

Date: 4 JUN 2018 22:55:41

Highest Channel / 3MHz / QPSK

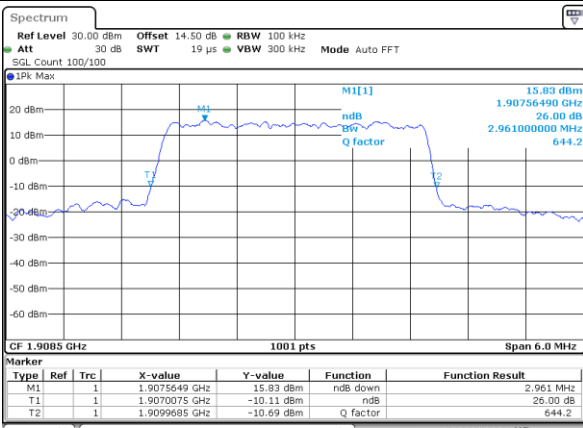

Date: 4 JUN 2018 22:58:04

Highest Channel / 3MHz / 16QAM

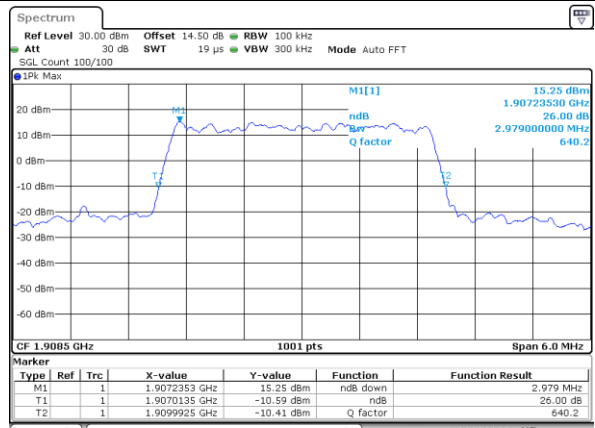

Date: 4 JUN 2018 22:58:14