

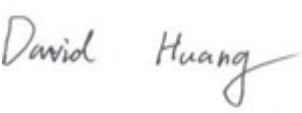

# RF TEST REPORT



Report No.: 17071380-FCC-R3

Supersede Report No.: N/A

Applicant	BLU Products, Inc	
Product Name	Mobile Phone	
Model No.	VIVO ONE	
Serial No.	N/A	
Test Standard	FCC Part 15.247: 2016, ANSI C63.10: 2013	
Test Date	December 12 to January 11, 2018	
Issue Date	January 12, 2018	
Test Result	<input checked="" type="checkbox"/> Pass <input type="checkbox"/> Fail	
Equipment complied with the specification	<input checked="" type="checkbox"/>	
Equipment did not comply with the specification	<input type="checkbox"/>	
		
Aaron Liang Test Engineer	David Huang Checked By	
<p>This test report may be reproduced in full only Test result presented in this test report is applicable to the tested sample only</p>		

Issued by:

**SIEMIC (SHENZHEN-CHINA) LABORATORIES**

Zone A, Floor 1, Building 2 Wan Ye Long Technology Park

South Side of Zhoushi Road, Bao' an District, Shenzhen, Guangdong China 518108

Phone: +86 0755 2601 4629801 Email: [China@siemic.com.cn](mailto:China@siemic.com.cn)

## Laboratories Introduction

SIEMIC, headquartered in the heart of Silicon Valley, with superior facilities in US and Asia, is one of the leading independent testing and certification facilities providing customers with one-stop shop services for Compliance Testing and Global Certifications.



In addition to testing and certification, SIEMIC provides initial design reviews and compliance management throughout a project. Our extensive experience with China, Asia Pacific, North America, European, and International compliance requirements, assures the fastest, most cost effective way to attain regulatory compliance for the global markets.

### Accreditations for Conformity Assessment

Country/Region	Scope
USA	EMC, RF/Wireless, SAR, Telecom
Canada	EMC, RF/Wireless, SAR, Telecom
Taiwan	EMC, RF, Telecom, SAR, Safety
Hong Kong	RF/Wireless, SAR, Telecom
Australia	EMC, RF, Telecom, SAR, Safety
Korea	EMI, EMS, RF, SAR, Telecom, Safety
Japan	EMI, RF/Wireless, SAR, Telecom
Singapore	EMC, RF, SAR, Telecom
Europe	EMC, RF, SAR, Telecom, Safety

Test Report	17071380-FCC-R3
Page	3 of 69

This page has been left blank intentionally.

# CONTENTS

1. REPORT REVISION HISTORY .....	5
2. CUSTOMER INFORMATION.....	5
3. TEST SITE INFORMATION .....	5
4. EQUIPMENT UNDER TEST (EUT) INFORMATION .....	6
5. TEST SUMMARY .....	9
6. MEASUREMENTS, EXAMINATION AND DERIVED RESULTS.....	10
6.1 ANTENNA REQUIREMENT .....	10
6.2 CHANNEL SEPARATION.....	11
6.3 20DB BANDWIDTH .....	15
6.4 PEAK OUTPUT POWER .....	19
6.5 NUMBER OF HOPPING CHANNEL .....	23
6.6 TIME OF OCCUPANCY (DWELL TIME).....	25
6.7 BAND EDGE & RESTRICTED BAND .....	29
6.8 AC POWER LINE CONDUCTED EMISSIONS.....	37
6.9 RADIATED EMISSIONS & RESTRICTED BAND.....	43
ANNEX A. TEST INSTRUMENT.....	50
ANNEX B. EUT AND TEST SETUP PHOTOGRAPHS.....	51
ANNEX C. TEST SETUP AND SUPPORTING EQUIPMENT.....	64
ANNEX D. USER MANUAL / BLOCK DIAGRAM / SCHEMATICS / PARTLIST .....	68
ANNEX E. DECLARATION OF SIMILARITY .....	69

## 1. Report Revision History

Report No.	Report Version	Description	Issue Date
17071380-FCC-R3	NONE	Original	January 12, 2018

## 2. Customer information

Applicant Name	BLU Products, Inc
Applicant Add	10814 NW 33rd St # 100 Doral, FL 33172, USA
Manufacturer	BLU Products, Inc
Manufacturer Add	10814 NW 33rd St # 100 Doral, FL 33172, USA

## 3. Test site information

Test Lab A:

Lab performing tests	SIEMIC (Shenzhen-China) LABORATORIES
Lab Address	Zone A, Floor 1, Building 2 Wan Ye Long Technology Park South Side of Zhoushi Road, Bao' an District, Shenzhen, Guangdong China 518108
FCC Test Site No.	535293
IC Test Site No.	4842E-1
Test Software	Radiated Emission Program-To Shenzhen v2.0

Test Lab B:

Lab performing tests	SIEMIC (Nanjing-China) Laboratories
Lab Address	2-1 Longcang Avenue Yuhua Economic and Technology Development Park, Nanjing, China
FCC Test Site No.	694825
IC Test Site No.	4842B-1
Test Software	EZ_EMG(ver.lcp-03A1)

Note: We just perform Radiated Spurious Emission above 18GHz in the test Lab. B.

## 4. Equipment under Test (EUT) Information

Description of EUT:	Mobile Phone
Main Model:	VIVO ONE
Serial Model:	N/A
Date EUT received:	December 11, 2017
Test Date(s):	December 12 to January 11, 2018
Equipment Category :	DSS
Antenna Gain:	GSM850: -2.53dBi PCS1900: -1.31dBi UMTS-FDD Band V: -2dBi UMTS-FDD Band IV: -0.18dBi UMTS-FDD Band II: -1.74dBi LTE Band II: -1.31dBi LTE Band IV: -2.64dBi LTE Band VII: -0.27dBi LTE Band XII: -2.53dBi LTE Band XVII: -3.19dBi Bluetooth/BLE: 0.46dBi WIFI: 0.46dBi GPS: 0.05dBi
Antenna Type:	PIFA Antenna
Type of Modulation:	GSM / GPRS: GMSK EGPRS: GMSK,8PSK UMTS-FDD: QPSK LTE Band: QPSK, 16QAM 802.11b/g/n: DSSS, OFDM Bluetooth: GFSK, $\pi$ /4DQPSK, 8DPSK BLE: GFSK GPS: BPSK



Test Report	17071380-FCC-R3
Page	8 of 69

---

Trade Name : BLU

GPRS/EGPRS Multi-slot class 8/10/11/12

FCC ID: YHLBLUVIVOONE



## 5. Test Summary

The product was tested in accordance with the following specifications.

All testing has been performed according to below product classification:

FCC Rules	Description of Test	Result
§15.203	Antenna Requirement	Compliance
§15.247(a)(1)	Channel Separation	Compliance
§15.247(a)(1)	20 dB Bandwidth	Compliance
§15.247(b)(1)	Peak Output Power	Compliance
§15.247(a)(1)(iii)	Number of Hopping Channel	Compliance
§15.247(a)(1)(iii)	Time of Occupancy (Dwell Time)	Compliance
§15.247(d)	Band Edge& Restricted Band	Compliance
§15.207(a)	AC Line Conducted Emissions	Compliance
§15.205, §15.209, §15.247(d)	Radiated Emissions& Restricted Band	Compliance

### Measurement Uncertainty

Emissions		
Test Item	Description	Uncertainty
Band Edge& Restricted Band and Radiated Emissions& Restricted Band	Confidence level of approximately 95% (in the case where distributions are normal), with a coverage factor of 2 (for EUTs < 0.5m X 0.5m X 0.5m)	+5.6dB/-4.5dB
-	-	-

## 6. Measurements, Examination And Derived Results

### 6.1 Antenna Requirement

#### **Applicable Standard**

According to § 15.203, an intentional radiator shall be designed to ensure that no antenna other than that furnished by the responsible party shall be used with the device. The use of a permanently attached antenna or of an antenna that uses a unique coupling to the intentional radiator shall be considered sufficient to comply with the provisions of this section. The manufacturer may design the unit so that a broken antenna can be replaced by the user, but the user of a standard antenna jack or electrical connector is prohibited. The structure and application of the EUT were analyzed to determine compliance with section §15.203 of the rules. §15.203 state that the subject device must meet the following criteria:

- a. Antenna must be permanently attached to the unit.
- b. Antenna must use a unique type of connector to attach to the EUT.

Unit must be professionally installed, and installer shall be responsible for verifying that the correct antenna is employed with the unit.

And according to FCC 47 CFR section 15.247 (b), if the transmitting antennas of directional gain greater than 6dBi are used, the power shall be reduced by the amount in dB that the directional gain of the antenna exceeds 6 dBi.

#### **Antenna Connector Construction**

The EUT has 2 antennas:

A permanently attached PIFA antenna for Bluetooth/BLE/WIF/GPS, the gain is 0.46dBi for Bluetooth/BLE/WIFI, the gain is 0.05dBi for GPS.

A permanently attached PIFA antenna for GSM/PCS/UMTS/ LTE Band II/IV/VII/XII/XVII, the gain is -2.53dBi for GSM850, -1.31dBi for PCS1900, -2dBi for UMTS-FDD Band V, -0.18dBi for UMTS-FDD Band IV, the gain is -1.74dBi for UMTS-FDD Band II, the gain is -1.31dBi LTE Band II, -2.64dBi for LTE Band IV, -0.27dBi for LTE Band VII, -2.53dBi for XII, -3.19dBi for XVII.

**The antenna meets up with the ANTENNA REQUIREMENT.**

**Result:** Compliance.

## 6.2 Channel Separation

Temperature	22 °C
Relative Humidity	53%
Atmospheric Pressure	1008mbar
Test date :	January 02, 2018
Tested By :	Aaron Liang

### Requirement(s):

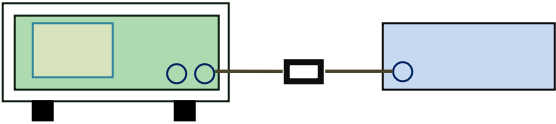
Spec	Item	Requirement	Applicable
§ 15.247(a)(1)	a)	Channel Separation < 20dB BW and 20dB BW < 25KHz ; Channel Separation Limit=25KHz Chanel Separation < 20dB BW and 20dB BW > 25kHz ; Channel Separation Limit=2/3 20dB BW	<input checked="" type="checkbox"/>
Test Setup	 <p style="text-align: center;">Spectrum Analyzer                      EUT</p>		
Test Procedure	<p>The test follows FCC Public Notice DA 00-705 Measurement Guidelines. Use the following spectrum analyzer settings:</p> <ul style="list-style-type: none"> <li>- The EUT must have its hopping function enabled</li> <li>- Span = wide enough to capture the peaks of two adjacent channels</li> <li>- Resolution (or IF) Bandwidth (RBW) ≥ 1% of the span</li> <li>- Video (or Average) Bandwidth (VBW) ≥ RBW</li> <li>- Sweep = auto</li> <li>- Detector function = peak</li> <li>- Trace = max hold</li> <li>- Allow the trace to stabilize. Use the marker-delta function to determine the separation between the peaks of the adjacent channels. The limit is specified in one of the subparagraphs of this Section. Submit this plot.</li> </ul>		

Remark	
Result	<input checked="" type="checkbox"/> Pass <input type="checkbox"/> Fail

Test Data  Yes  N/A

Test Plot  Yes (See below)  N/A

### Channel Separation measurement result

Type/ Modulation	CH	CH Frequency (MHz)	CH Separation (MHz)	Limit (MHz)	Result
CH Separation GFSK	Low Channel	2402	1.008	0.937	Pass
	Adjacency Channel	2403			
	Mid Channel	2440	1.008	0.938	Pass
	Adjacency Channel	2441			
	High Channel	2480	1.002	0.866	Pass
	Adjacency Channel	2479			
CH Separation $\pi/4$ DQPSK	Low Channel	2402	1.002	0.887	Pass
	Adjacency Channel	2403			
	Mid Channel	2440	1.002	0.905	Pass
	Adjacency Channel	2441			
	High Channel	2480	1.005	0.894	Pass
	Adjacency Channel	2479			
CH Separation 8DPSK	Low Channel	2402	1.002	0.909	Pass
	Adjacency Channel	2403			
	Mid Channel	2440	1.005	0.889	Pass
	Adjacency Channel	2441			
	High Channel	2480	1.002	0.888	Pass
	Adjacency Channel	2479			

## Test Plots

### Channel Separation measurement result

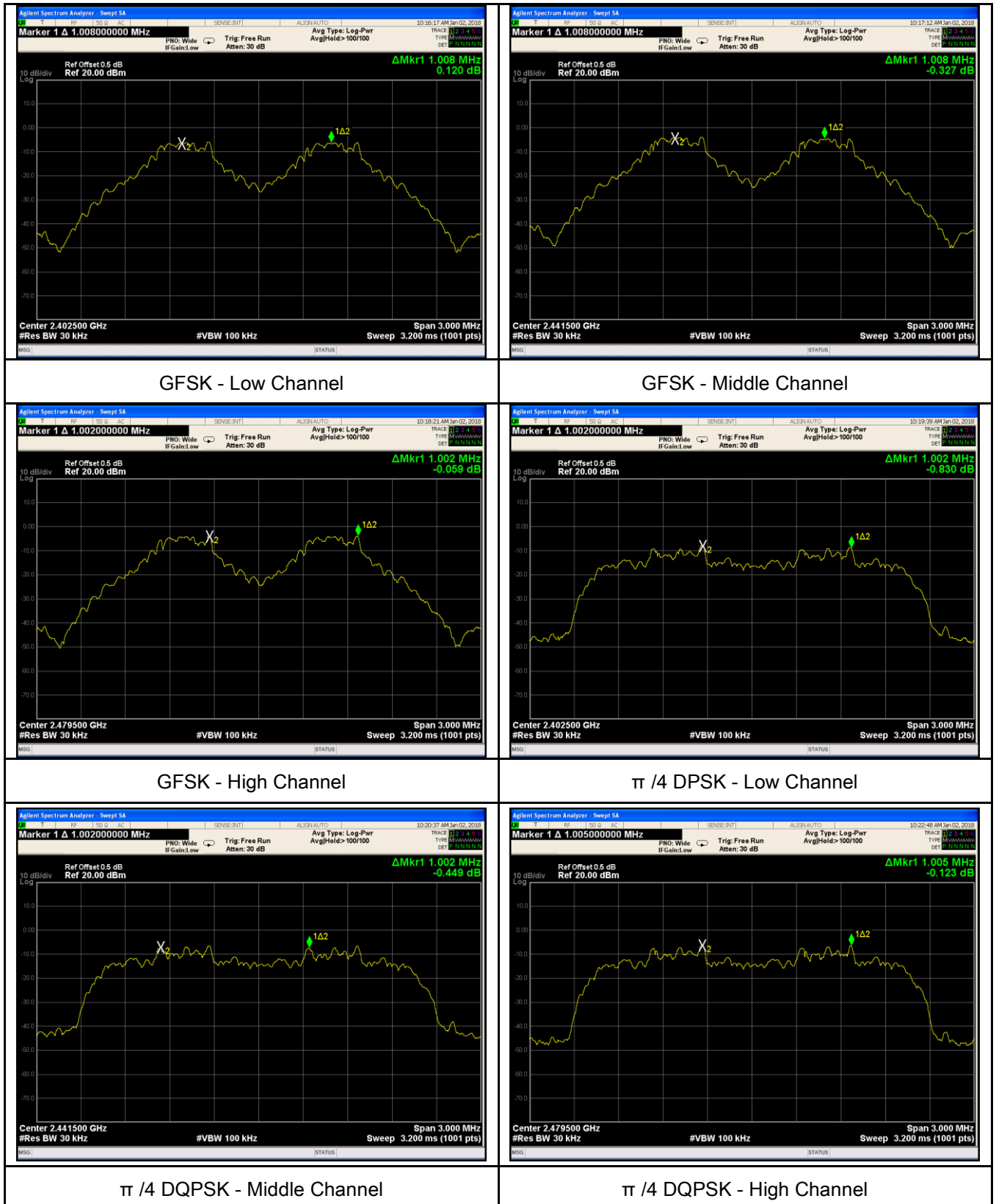



8DPSK - Low Channel

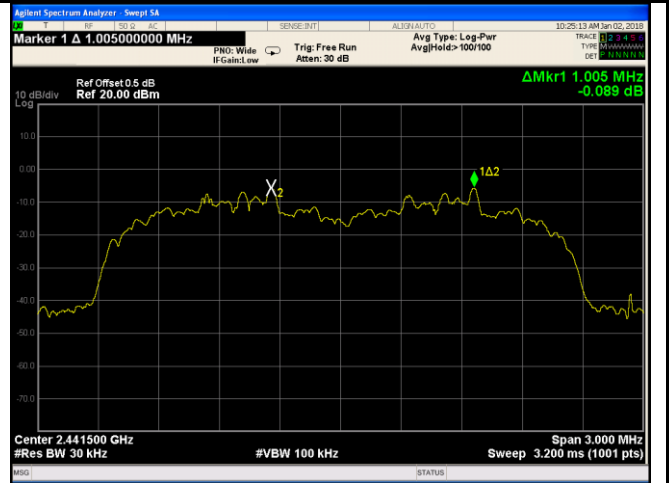

8DPSK - Middle Channel



8DPSK - High Channel

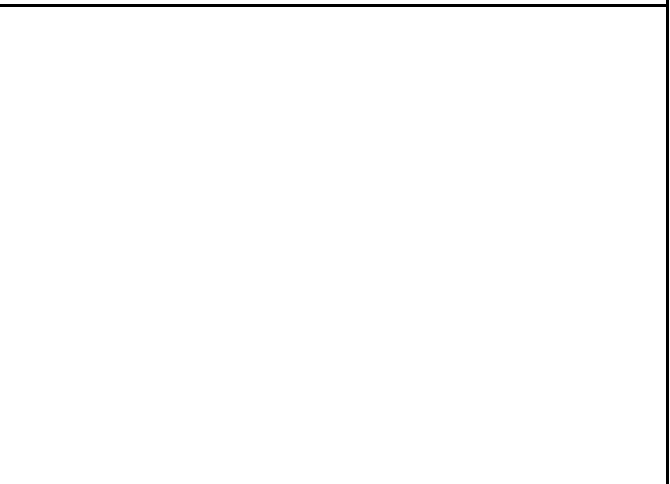

### 6.3 20dB Bandwidth

Temperature	22 °C
Relative Humidity	53%
Atmospheric Pressure	1008mbar
Test date :	January 02, 2018
Tested By :	Aaron Liang

#### Requirement(s):

Spec	Item	Requirement	Applicable
§15.247(a) (1)	a)	Frequency hopping systems shall have hopping channel carrier frequencies separated by a minimum of 25 kHz or the 20 dB bandwidth of the hopping channel, whichever is greater.	<input checked="" type="checkbox"/>

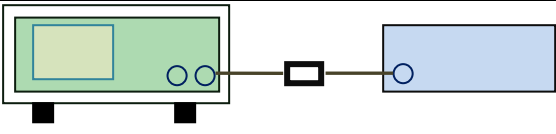
Test Setup	 <p style="text-align: center;">Spectrum Analyzer                      EUT</p>
------------	--

Test Procedure	<p>The test follows FCC Public Notice DA 00-705 Measurement Guidelines. Use the following spectrum analyzer settings:</p> <ul style="list-style-type: none"> <li>- Span = approximately 2 to 3 times the 20 dB bandwidth, centered on a hopping channel</li> <li>- RBW <math>\geq</math> 1% of the 20 dB bandwidth</li> <li>- VBW <math>\geq</math> RBW</li> <li>- Sweep = auto</li> <li>- Detector function = peak</li> <li>- Trace = max hold.</li> <li>- The EUT should be transmitting at its maximum data rate. Allow the trace to stabilize. Use the marker-to-peak function to set the marker to the peak of the emission. Use the marker-delta function to measure 20 dB down one side of the emission. Reset the marker-delta function, and move the marker to the other side of the emission, until it is (as close as possible to) even with the reference</li> </ul>
----------------	--

	marker level. The marker-delta reading at this point is the 20 dB bandwidth of the emission. If this value varies with different modes of operation (e.g., data rate, modulation format, etc.), repeat this test for each variation. The limit is specified in one of the subparagraphs of this Section. Submit this plot(s).
Remark	
Result	<input checked="" type="checkbox"/> Pass <input type="checkbox"/> Fail

Test Data  Yes  N/A

Test Plot  Yes (See below)  N/A

#### Measurement result

Modulation	CH	CH Frequency (MHz)	20dB Bandwidth (MHz)	99% Occupied Bandwidth (MHz)
GFSK	Low	2402	0.9371	0.8995
	Mid	2441	0.9376	0.8883
	High	2480	0.8664	0.8685
$\pi$ /4 DQPSK	Low	2402	1.330	1.1945
	Mid	2441	1.357	1.2212
	High	2480	1.341	1.2078
8-DPSK	Low	2402	1.364	1.2288
	Mid	2441	1.333	1.2072
	High	2480	1.332	1.2080



## Test Plots

### 20dB Bandwidth measurement result

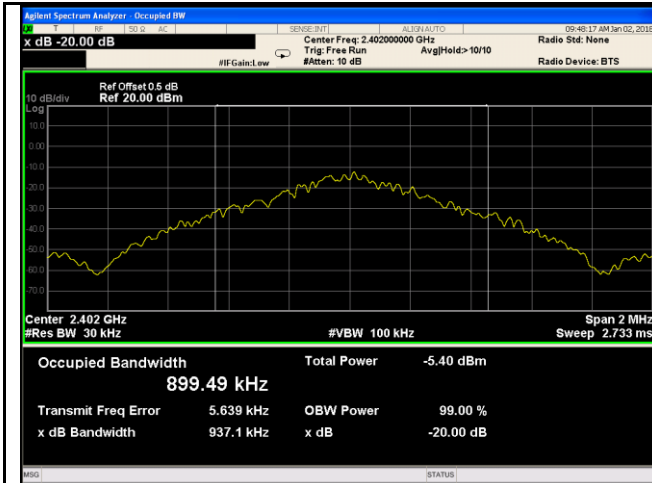

GFSK - Low Channel

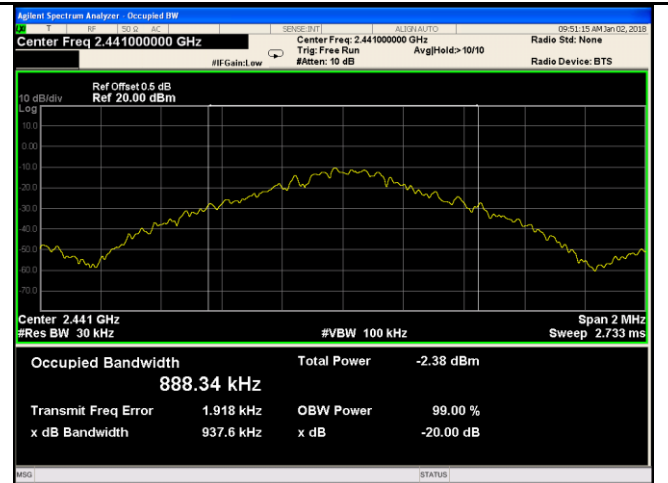

GFSK - Middle Channel

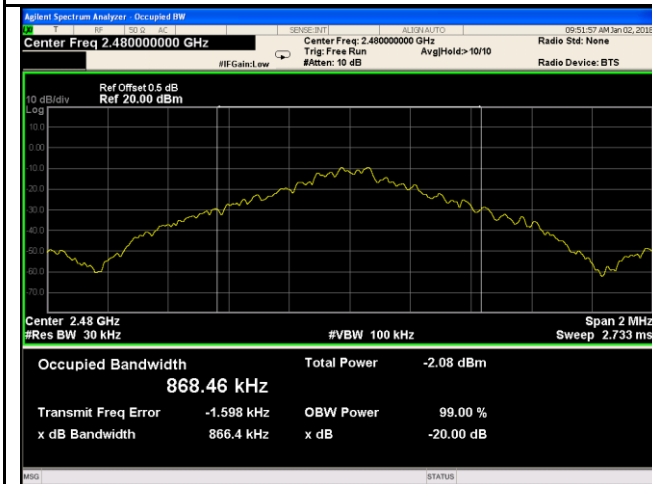

GFSK - High Channel

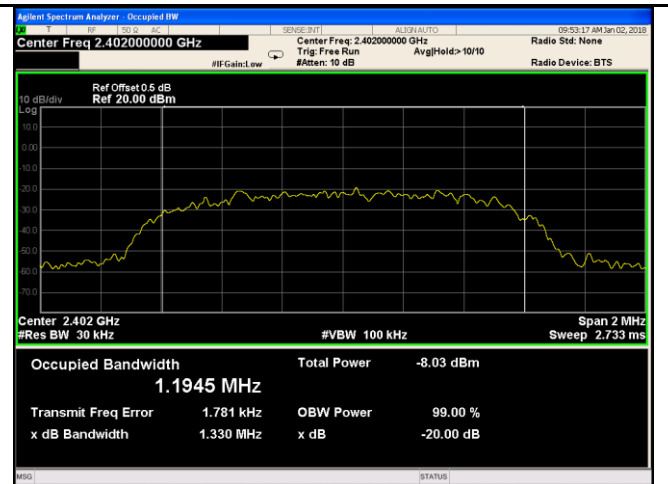

$\pi/4$  DPSK - Low Channel

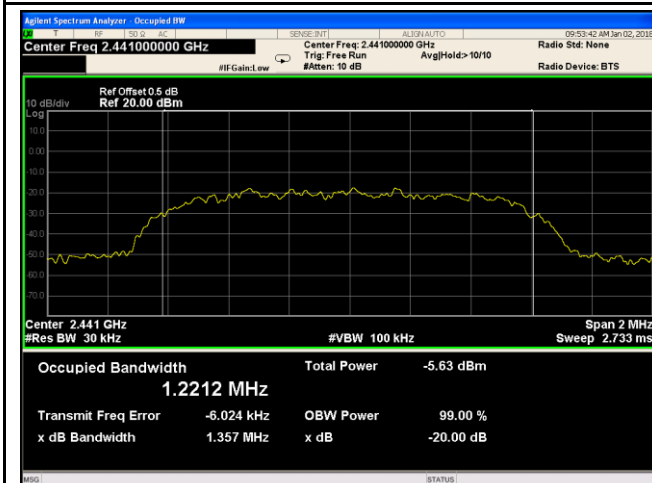

$\pi/4$  DQPSK - Middle Channel

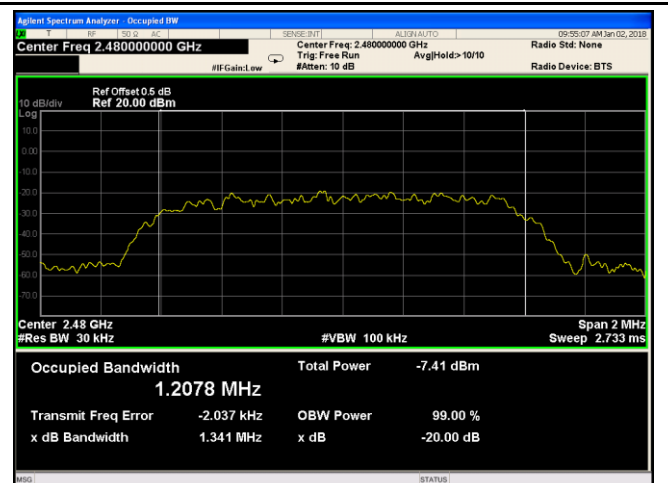

$\pi/4$  DQPSK - High Channel

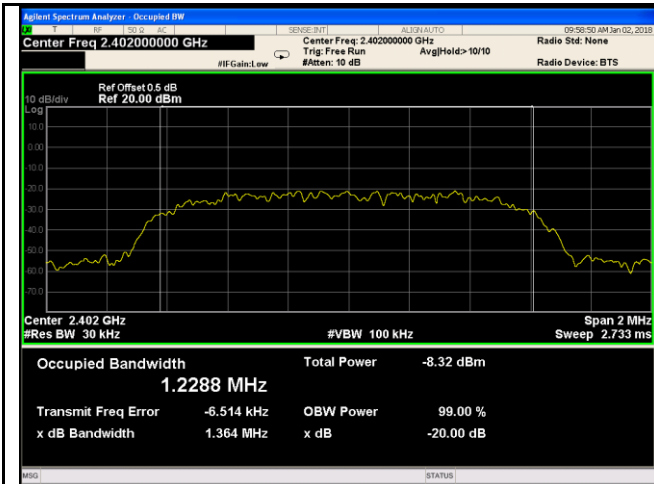

8DPSK - Low Channel

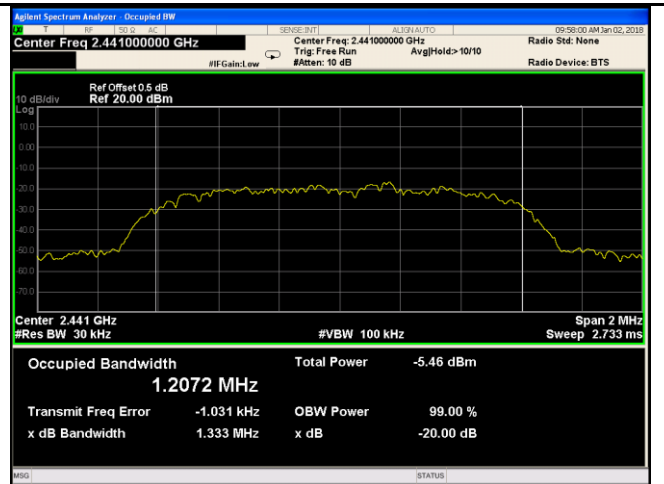

8DPSK - Middle Channel

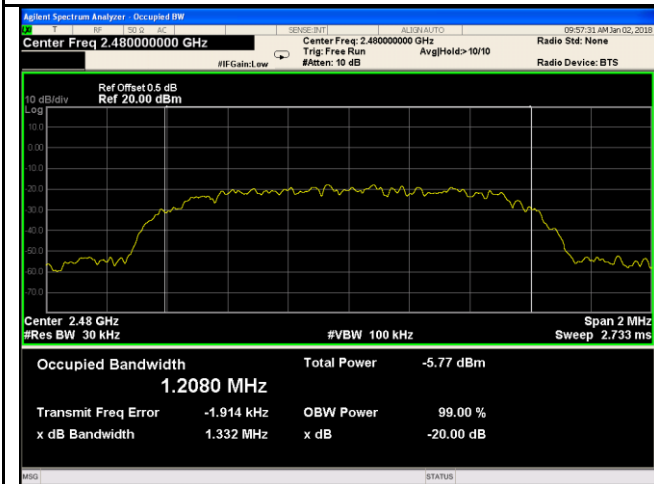

8DPSK - High Channel

## 6.4 Peak Output Power

Temperature	22 °C
Relative Humidity	53%
Atmospheric Pressure	1008mbar
Test date :	January 02, 2018
Tested By :	Aaron Liang

### Requirement(s):

Spec	Item	Requirement	Applicable
§15.247(b) (3)	a)	FHSS in 2400-2483.5MHz with $\geq 75$ channels: $\leq 1$ Watt	<input checked="" type="checkbox"/>
	b)	FHSS in 5725-5850MHz: $\leq 1$ Watt	<input type="checkbox"/>
	c)	For all other FHSS in the 2400-2483.5MHz band: $\leq 0.125$ Watt.	<input checked="" type="checkbox"/>
	d)	FHSS in 902-928MHz with $\geq 50$ channels: $\leq 1$ Watt	<input type="checkbox"/>
	e)	FHSS in 902-928MHz with $\geq 25$ & $< 50$ channels: $\leq 0.25$ Watt	<input type="checkbox"/>
	f)	DTS in 902-928MHz, 2400-2483.5MHz: $\leq 1$ Watt	<input type="checkbox"/>

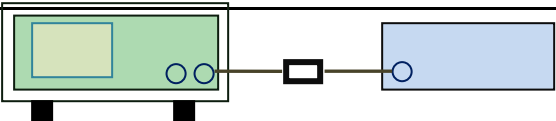
Test Setup	 <p style="text-align: center;">Spectrum Analyzer                      EUT</p>
------------	--

Test Procedure	<p>The test follows FCC Public Notice DA 00-705 Measurement Guidelines.</p> <p><u>Use the following spectrum analyzer settings:</u></p> <ul style="list-style-type: none"> <li>- Span = approximately 5 times the 20 dB bandwidth, centered on a hopping channel</li> <li>- RBW &gt; the 20 dB bandwidth of the emission being measured</li> <li>- VBW <math>\geq</math> RBW</li> <li>- Sweep = auto</li> <li>- Detector function = peak</li> <li>- Trace = max hold</li> <li>- Allow the trace to stabilize.</li> </ul>
----------------	--

	- Use the marker-to-peak function to set the marker to the peak of the emission. The indicated level is the peak output power (see the note above regarding external attenuation and cable loss). The limit is specified in one of the subparagraphs of this Section. Submit this plot. A peak responding power meter may be used instead of a spectrum analyzer.
Remark	
Result	<input checked="" type="checkbox"/> Pass <input type="checkbox"/> Fail

Test Data  Yes  N/A  
 Test Plot  Yes (See below)  N/A

**Peak Output Power measurement result**

Type	Modulation	CH	Frequency (MHz)	Conducted Power (dBm)	Limit (mW)	Result
Output power	GFSK	Low	2402	-1.401	1000	Pass
		Mid	2441	-1.596	1000	Pass
		High	2480	-1.629	1000	Pass
	$\pi/4$ DQPSK	Low	2402	-2.534	125	Pass
		Mid	2441	-2.292	125	Pass
		High	2480	-2.415	125	Pass
	8-DPSK	Low	2402	-2.436	125	Pass
		Mid	2441	-2.294	125	Pass
		High	2480	-2.407	125	Pass

## Test Plots

### Output Power measurement result

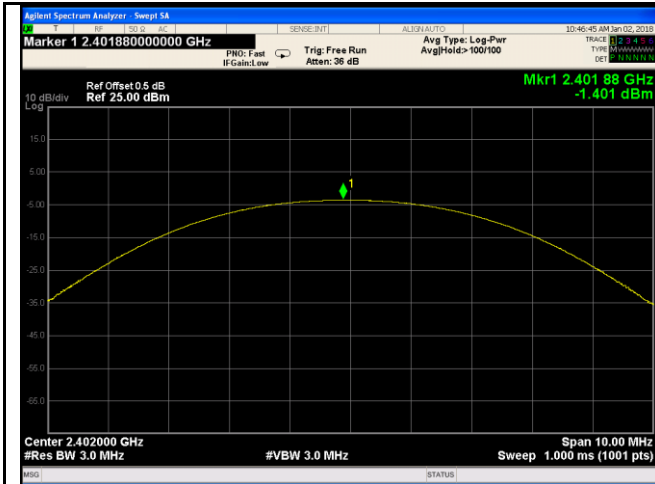

GFSK Output power - Low CH 2402

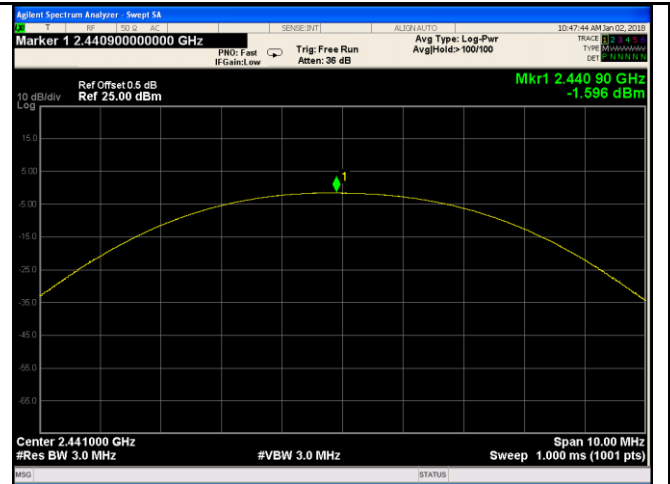

GFSK Output power - Mid CH 2441

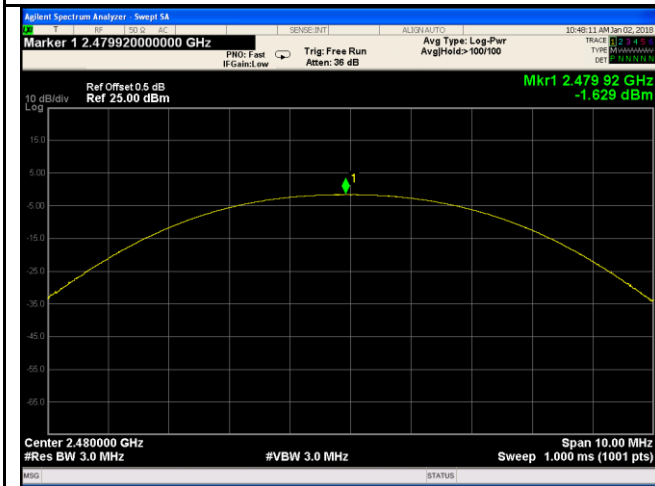

GFSK Output power - High CH 2480

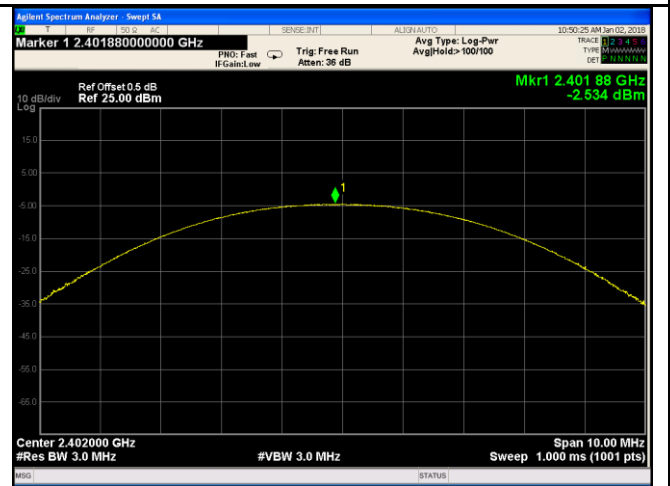

$\pi/4$  DQPSK Output power - Low CH 2402

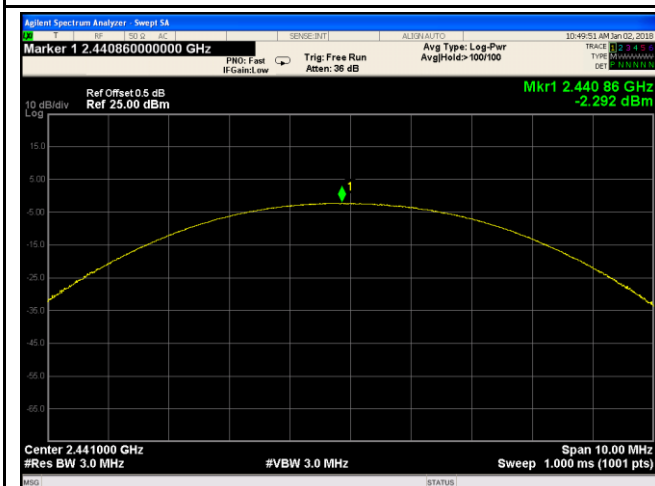

$\pi/4$  DQPSK Output power - Mid CH 2441

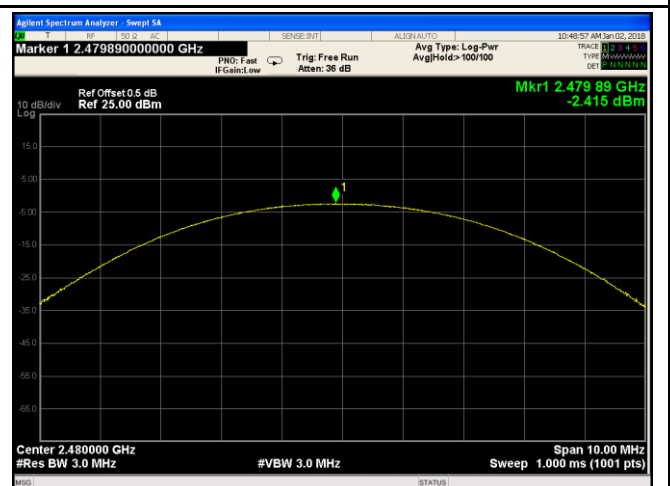

$\pi/4$  DQPSK Output power - High CH 2480

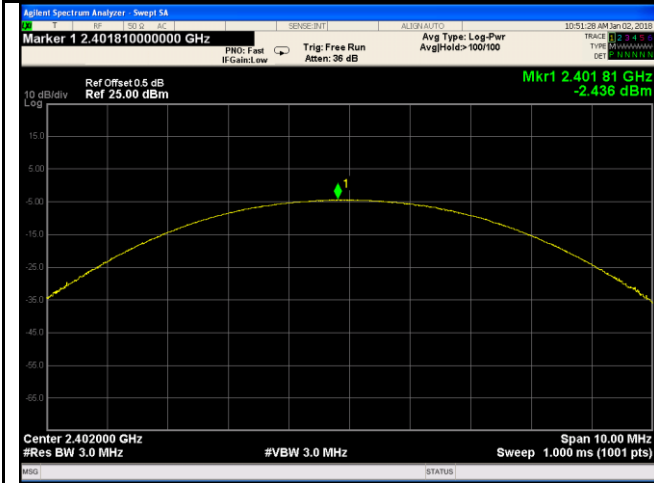

8DPSK Output power - Low CH 2402

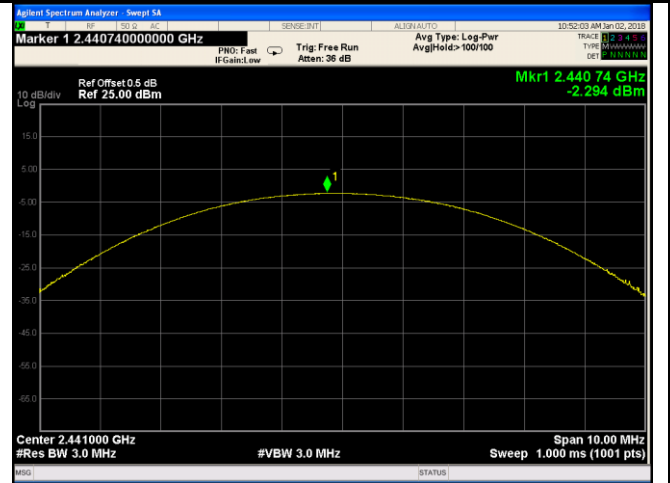

8DPSK Output power - Mid CH 2441

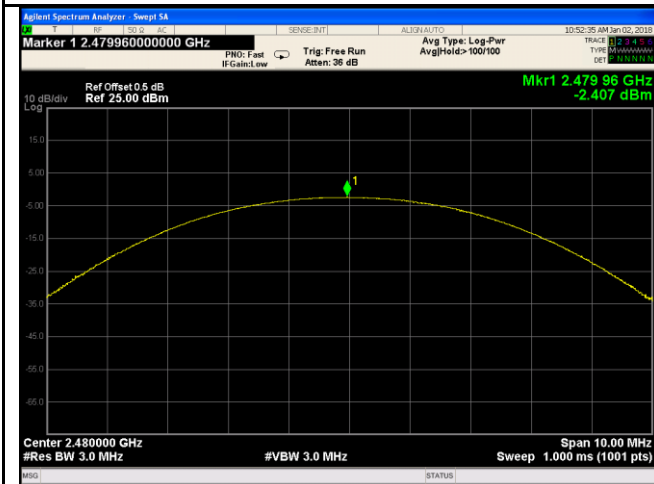

8DPSK Output power - High CH 2480

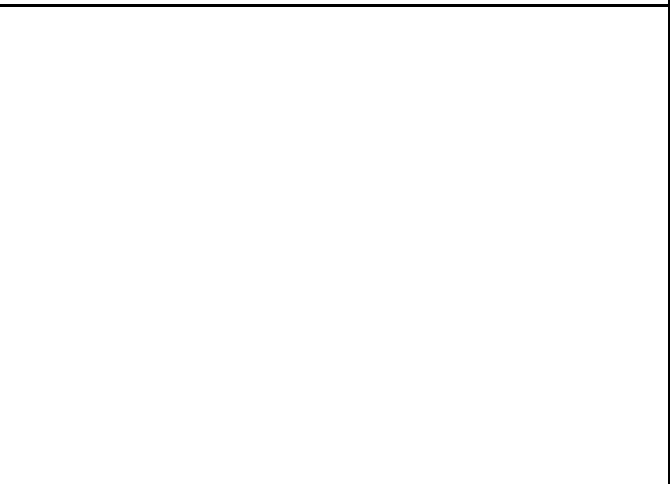

## 6.5 Number of Hopping Channel

Temperature	22 °C
Relative Humidity	53%
Atmospheric Pressure	1008mbar
Test date :	January 02, 2018
Tested By :	Aaron Liang

### Requirement(s):

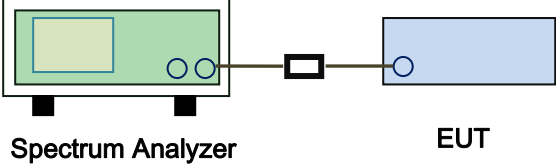
Spec	Item	Requirement	Applicable
§15.247(a) (1)(iii)	a)	FHSS in 2400-2483.5MHz ≥ 15 channels	<input checked="" type="checkbox"/>
Test Setup	 <p style="text-align: center;">Spectrum Analyzer                      EUT</p>		
Test Procedure	<p>The test follows FCC Public Notice DA 00-705 Measurement Guidelines.  <u>Use the following spectrum analyzer settings:</u>            The EUT must have its hopping function enabled.</p> <ul style="list-style-type: none"> <li>- Span = the frequency band of operation</li> <li>- RBW ≥ 1% of the span</li> <li>- VBW ≥ RBW</li> <li>- Sweep = auto</li> <li>- Detector function = peak</li> <li>- Trace = max hold</li> <li>- Allow trace to fully stabilize.</li> <li>- It may prove necessary to break the span up to sections, in order to clearly show all of the hopping frequencies. The limit is specified in one of the subparagraphs of this Section. Submit this plot(s).</li> </ul>		
Remark			
Result	<input checked="" type="checkbox"/> Pass <input type="checkbox"/> Fail		

Test Data     Yes                       N/A  
 Test Plot     Yes (See below)                       N/A

### Number of Hopping Channel measurement result

Type	Modulation	Frequency Range	Number of Hopping Channel	Limit
Number of Hopping Channel	GFSK	2400-2483.5	79	15
	$\pi/4$ DQPSK	2400-2483.5	79	15
	8-DPSK	2400-2483.5	79	15

### Test Plots

#### Number of Hopping Channels measurement result

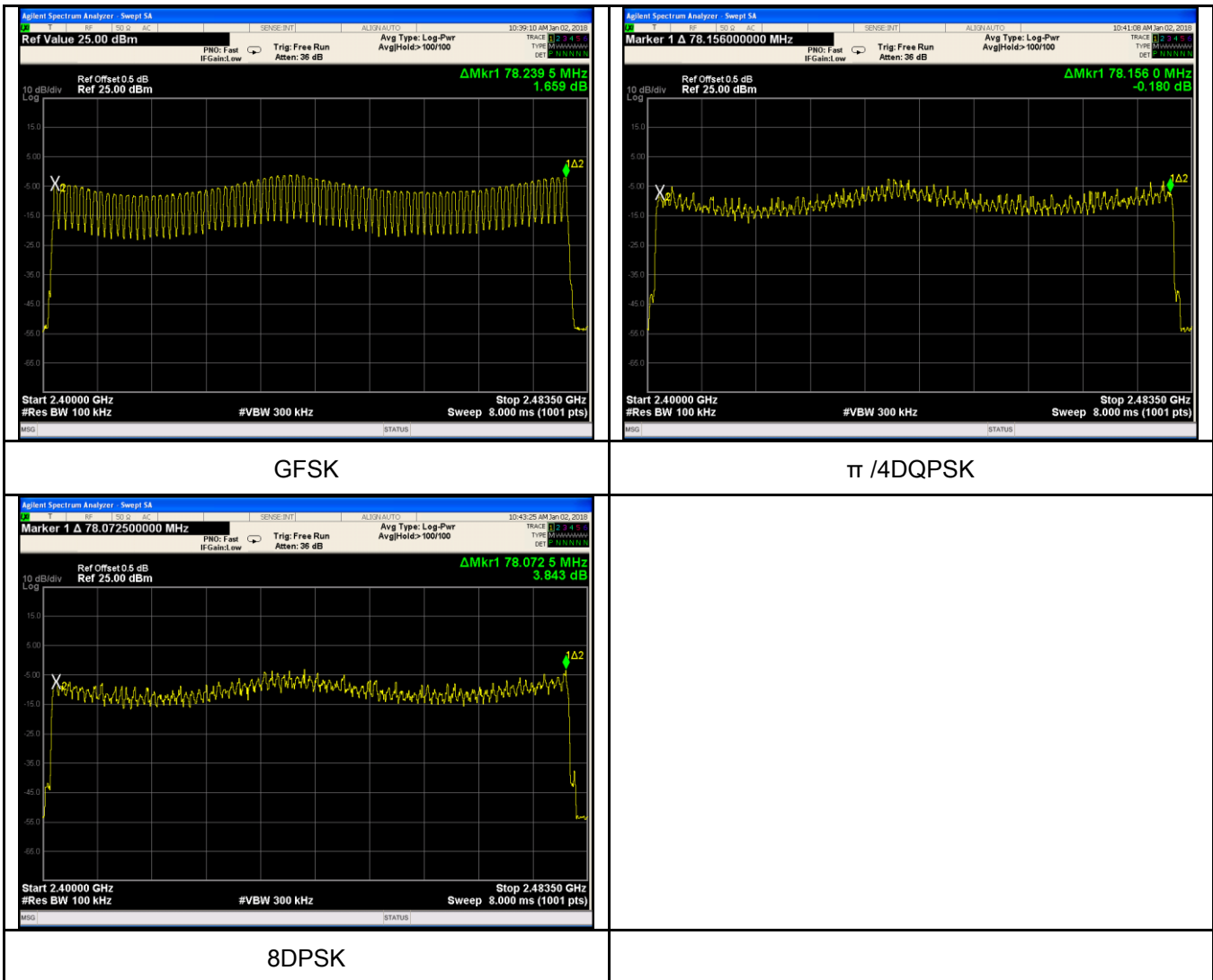



## 6.6 Time of Occupancy (Dwell Time)

Temperature	22 °C
Relative Humidity	53%
Atmospheric Pressure	1008mbar
Test date :	January 02, 2018
Tested By :	Aaron Liang

### Requirement(s):

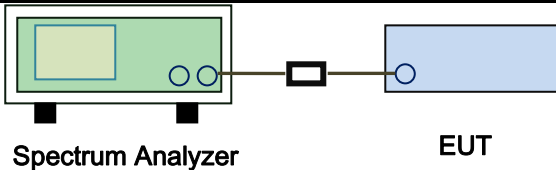
Spec	Item	Requirement	Applicable
§15.247(a) (1)(iii)	a)	Dwell Time < 0.4s	<input checked="" type="checkbox"/>
Test Setup	 <p style="text-align: center;">Spectrum Analyzer                      EUT</p>		
Test Procedure	<p>The test follows FCC Public Notice DA 00-705 Measurement Guidelines.  <u>Use the following spectrum analyzer</u></p> <ul style="list-style-type: none"> <li>- Span = zero span, centered on a hopping channel</li> <li>- RBW = 1 MHz</li> <li>- VBW ≥ RBW</li> <li>- Sweep = as necessary to capture the entire dwell time per hopping channel</li> <li>- Detector function = peak</li> <li>- Trace = max hold</li> <li>- use the marker-delta function to determine the dwell time</li> </ul>		
Remark			
Result	<input checked="" type="checkbox"/> Pass <input type="checkbox"/> Fail		

Test Data     Yes                       N/A  
 Test Plot     Yes (See below)                       N/A

**Dwell Time measurement result**

Type	Modulation	CH	Pulse Width (ms)	Dwell Time (ms)	Limit (ms)	Result
Dwell Time	GFSK	Low	2.933	312.853	400	Pass
		Mid	2.929	312.427	400	Pass
		High	2.955	315.200	400	Pass
	π /4 DQPSK	Low	2.963	316.053	400	Pass
		Mid	2.980	317.867	400	Pass
		High	2.963	316.053	400	Pass
	8-DPSK	Low	2.933	312.853	400	Pass
		Mid	2.975	317.333	400	Pass
		High	2.983	318.187	400	Pass
Note: Dwell time=Pulse Time (ms) × (1600 ÷ 6 ÷ 79) ×31.6						

### Test Plots

#### Dwell Time measurement result

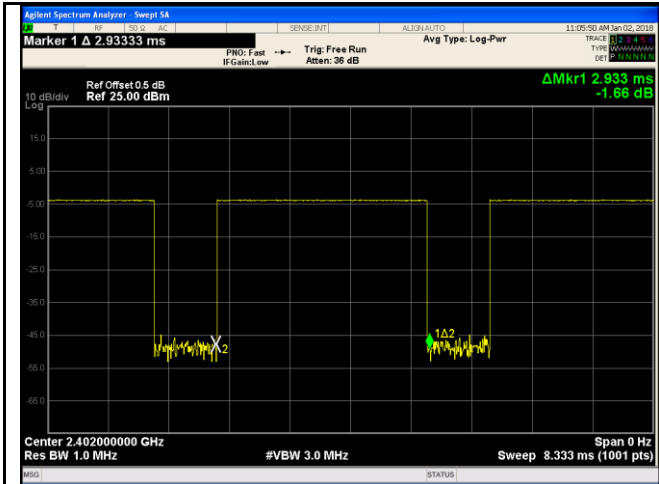

GFSK - Low CH 2402

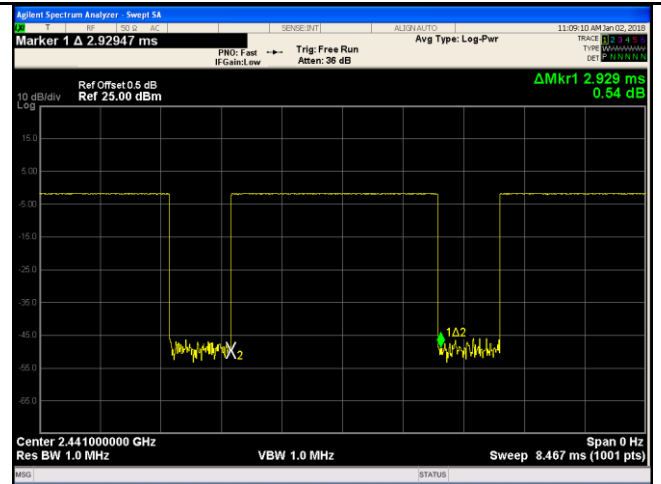

GFSK - Mid CH 2441

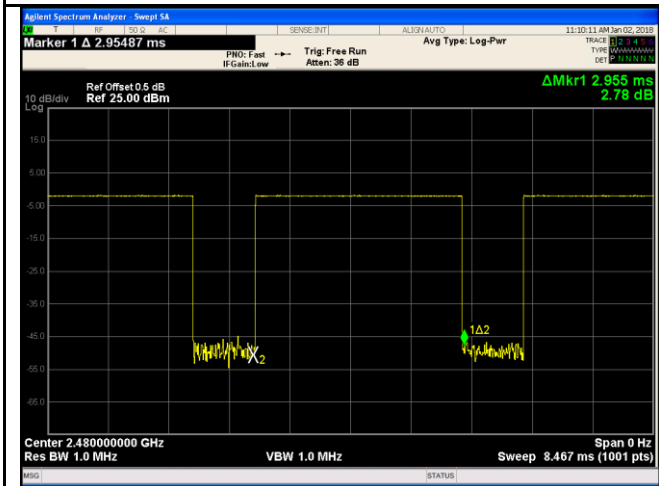

GFSK - High CH 2480

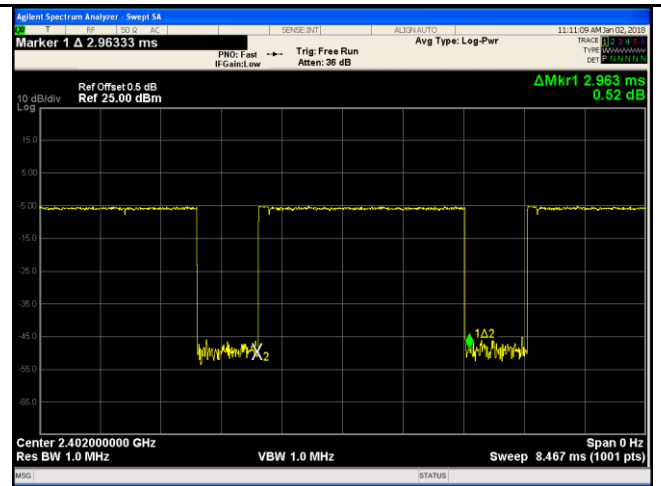

$\pi/4$  DQPSK - Low CH 2402

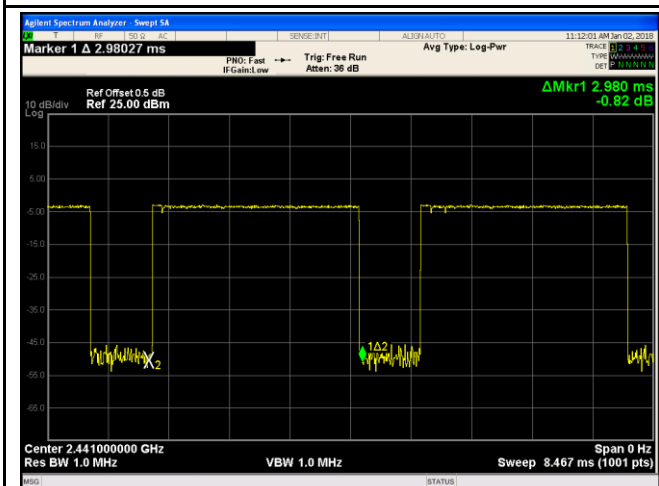

$\pi/4$  DQPSK - Mid CH 2441

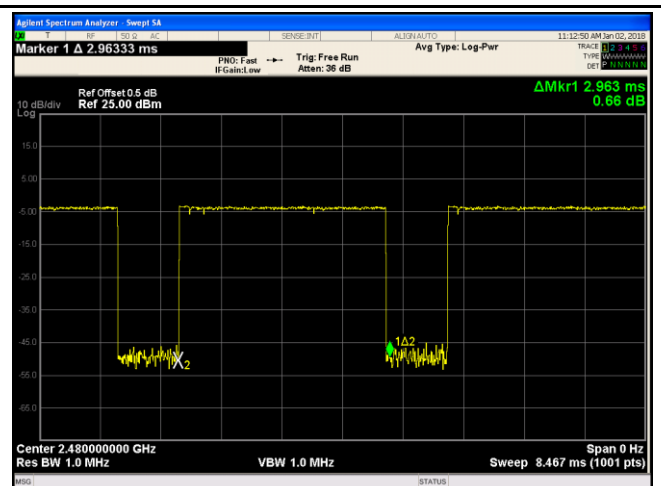

$\pi/4$  DQPSK - High CH 2480

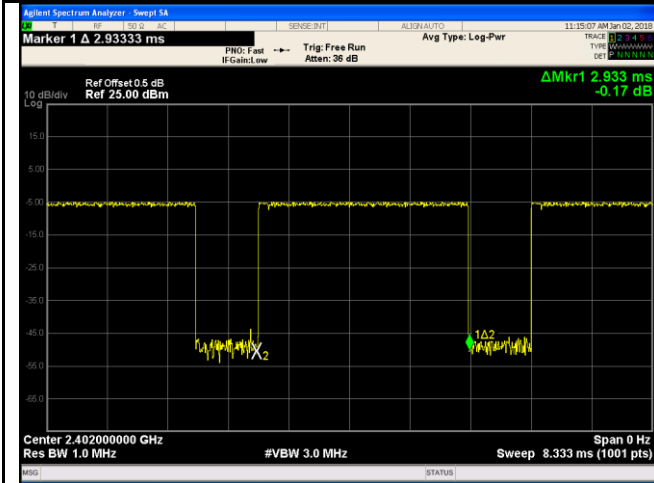

8DPSK - Low CH 2402

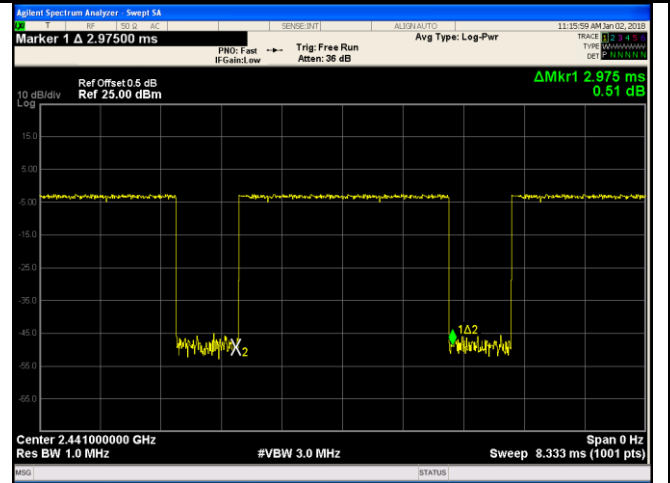

8DPSK - Mid CH 2441

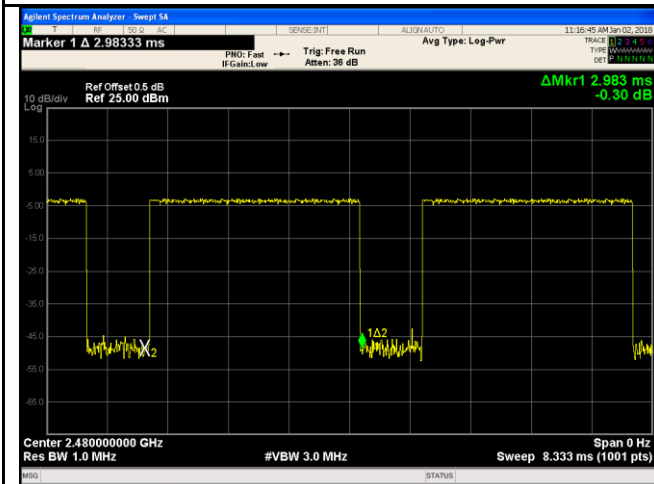

8DPSK - High CH 2480

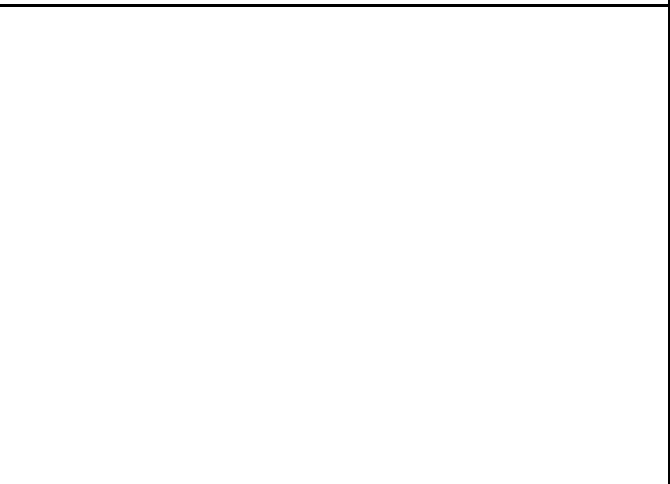

## 6.7 Band Edge & Restricted Band

Temperature	22 °C
Relative Humidity	53%
Atmospheric Pressure	1008mbar
Test date :	January 02, 2018
Tested By :	Aaron Liang

### Requirement(s):

Spec	Item	Requirement	Applicable
§15.247(a) (1)(iii)	a)	In any 100 kHz bandwidth outside the frequency band in which the spread spectrum or digitally modulated intentional radiator is operating, the radio frequency power that is produced by the intentional radiator shall be at least 20 dB below that in the 100 kHz bandwidth within the band that contains the highest level of the desired power, based on either an RF conducted or a radiated measurement, provided the transmitter demonstrates compliance with the peak conducted power limits. □	<input checked="" type="checkbox"/>

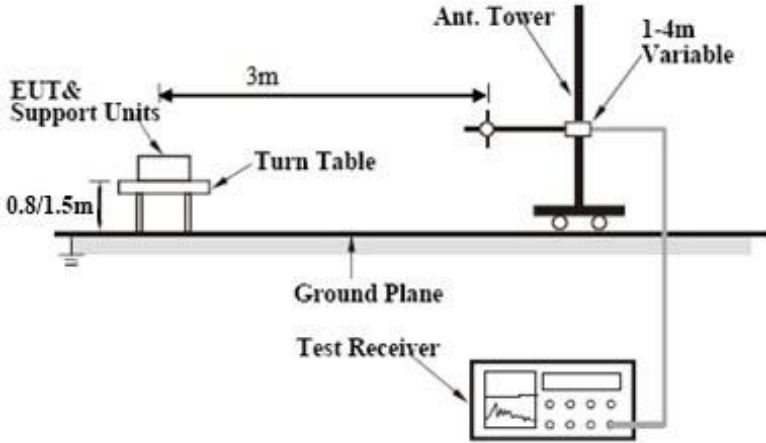
Test Setup	
------------	--

Test Procedure	<p>The test follows FCC Public Notice DA 00-705 Measurement Guidelines. Radiated Method Only</p> <ul style="list-style-type: none"> <li>- 1. Check the calibration of the measuring instrument using either an internal calibrator or a known signal from an external generator.</li> <li>- 2. Position the EUT without connection to measurement instrument. Put it on the Rotated table and turn on the EUT and make it operate in transmitting mode. Then set it to Low Channel and High Channel within its operating range,</li> </ul>
----------------	--

	<p>and make sure the instrument is operated in its linear range.</p> <ul style="list-style-type: none"> <li>- 3. First, set both RBW and VBW of spectrum analyzer to 100 kHz with a convenient frequency span including 100kHz bandwidth from band edge, check the emission of EUT, if pass then set Spectrum Analyzer as below: <ul style="list-style-type: none"> <li>a. The resolution bandwidth and video bandwidth of test receiver/spectrum analyzer is 120 kHz for Quasiy Peak detection at frequency below 1GHz.</li> <li>b. The resolution bandwidth of test receiver/spectrum analyzer is 1MHz and video bandwidth is 3MHz with Peak detection for Peak measurement at frequency above 1GHz.</li> <li>c. The resolution bandwidth of test receiver/spectrum analyzer is 1MHz and the video bandwidth is 10Hz with Peak detection for Average Measurement as below at frequency above 1GHz.</li> </ul> </li> <li>- 4. Measure the highest amplitude appearing on spectral display and set it as a reference level. Plot the graph with marking the highest point and edge frequency.</li> <li>- 5. Repeat above procedures until all measured frequencies were complete.</li> </ul>
Remark	
Result	<input checked="" type="checkbox"/> Pass <input type="checkbox"/> Fail

**Test Data**     Yes                       N/A  
**Test Plot**     Yes (See below)       N/A

### Test Plots

#### GFSK Mode:

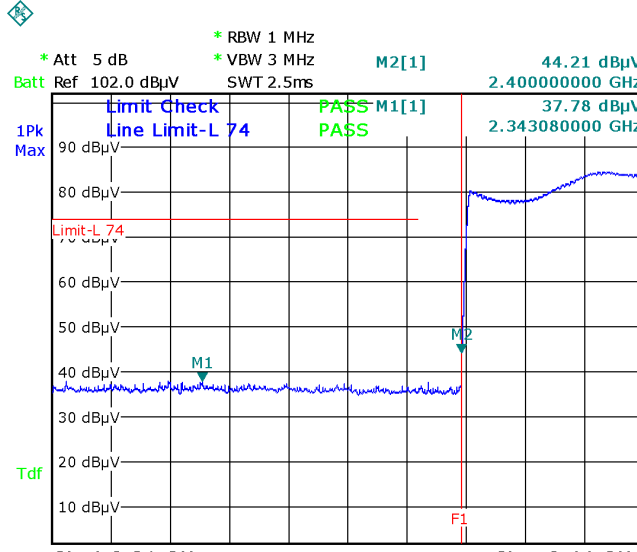
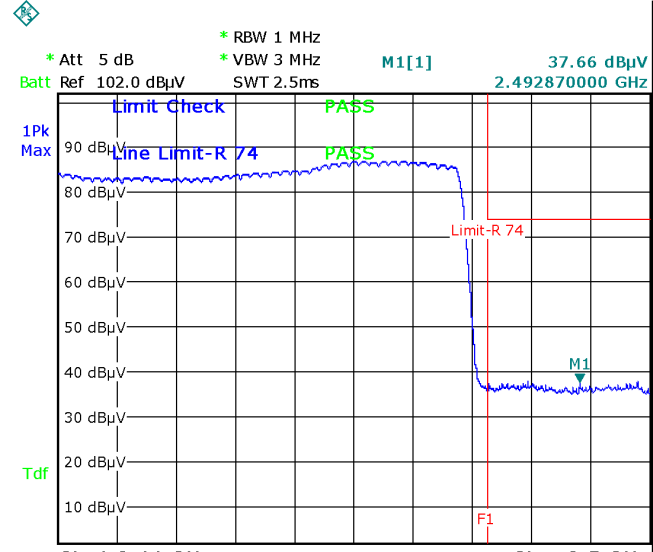
 <p>* RBW 1 MHz * Att 5 dB * VBW 3 MHz Batt Ref 102.0 dBµV SWT 2.5ms</p> <p>M2[1] 44.21 dBµV 2.400000000 GHz 37.78 dBµV 2.343080000 GHz</p> <p>Limit Check Line Limit-L 74 PASS M1[1] PASS</p> <p>1Pk Max 90 dBµV 80 dBµV 70 dBµV 60 dBµV 50 dBµV 40 dBµV 30 dBµV 20 dBµV 10 dBµV</p> <p>Tdf</p> <p>Start 2.31 GHz Stop 2.44 GHz</p> <p>Date: 2.JAN.2018 09:58:44</p>	 <p>* RBW 1 MHz * Att 5 dB * VBW 3 MHz Batt Ref 102.0 dBµV SWT 2.5ms</p> <p>M1[1] 37.66 dBµV 2.492870000 GHz</p> <p>Limit Check Line Limit-R 74 PASS</p> <p>1Pk Max 90 dBµV 80 dBµV 70 dBµV 60 dBµV 50 dBµV 40 dBµV 30 dBµV 20 dBµV 10 dBµV</p> <p>Tdf</p> <p>Start 2.44 GHz Stop 2.5 GHz</p> <p>Date: 2.JAN.2018 09:57:14</p>
<p align="center"><b>GFSK-Hopping Left Side-PK</b></p> <p align="center"><b>Note: F1 is frequency 2400MHz</b></p>	<p align="center"><b>GFSK-Hopping Right Side-PK</b></p> <p align="center"><b>Note: F1 is frequency 2483.5MHz</b></p>
<p align="center">Note: (no need if PK value less than the AV limit)</p>	<p align="center">Note: (no need if PK value less than the AV limit)</p>
<p align="center">GFSK-Hopping Left Side-AV</p>	<p align="center">GFSK-Hopping Right Side-AV</p>

Note: Both Horizontal and vertical polarities were investigated.

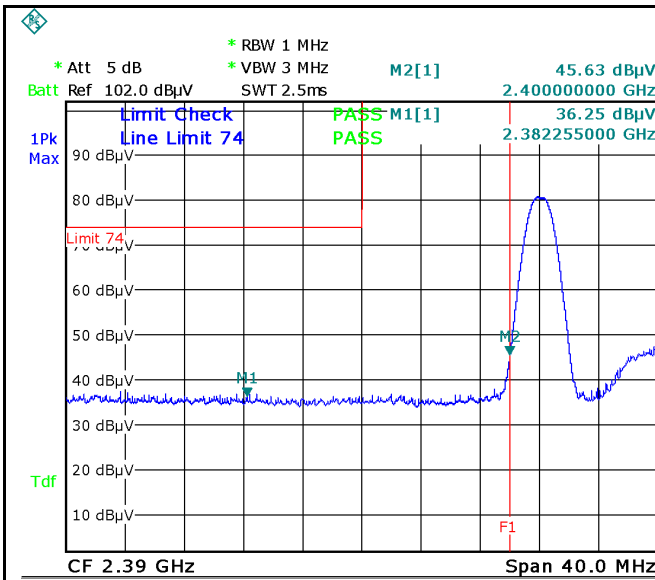

Date: 2.JAN.2018 09:50:11

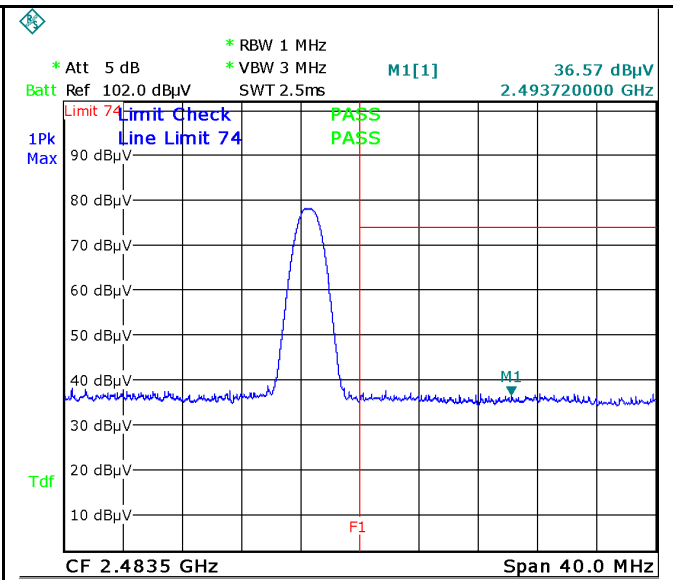

Date: 2.JAN.2018 09:52:35

GFSK-Left Side-PK

Note: F1 is frequency 2400MHz

GFSK-Right Side-PK

Note: F1 is frequency 2483.5MHz

Note: (no need if PK value less than the AV limit)

Note: (no need if PK value less than the AV limit)

GFSK-Left Side-AV

GFSK-Right Side-AV

Note: Both Horizontal and vertical polarities were investigated.



**$\pi$  / 4 DQPSK Mode:**

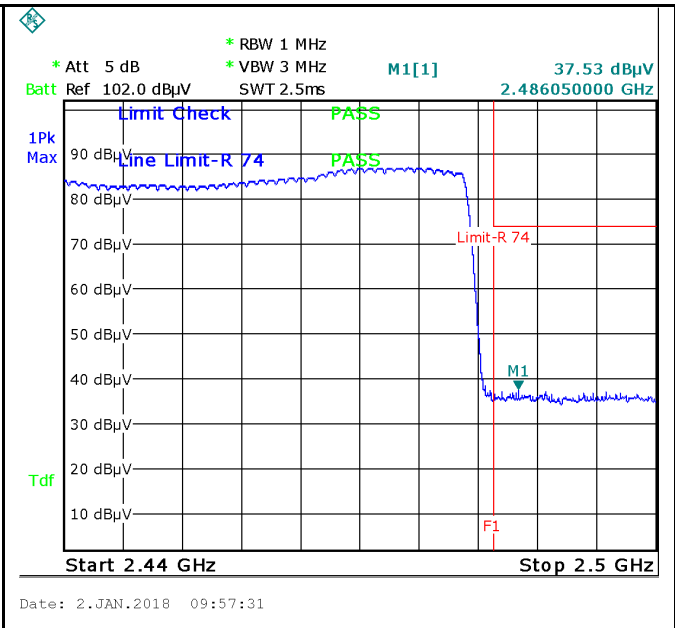
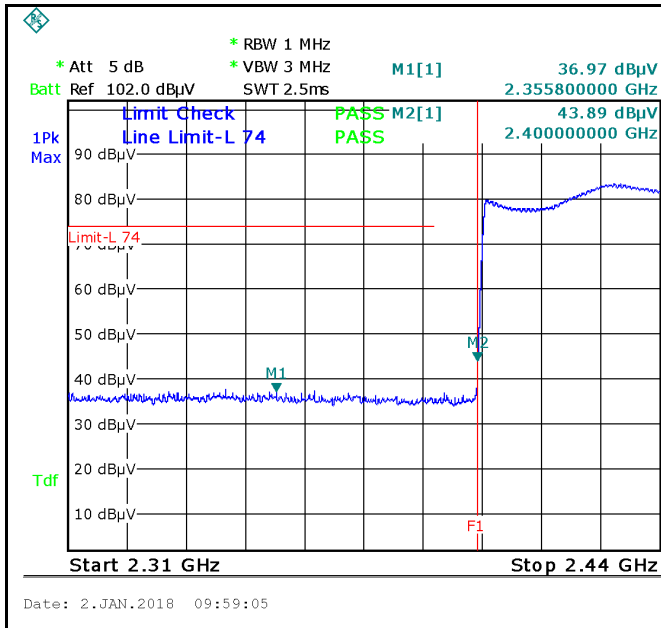

**$\pi$  / 4 DQPSK-Hopping Left Side-PK**  
**Note: F1 is frequency 2400MHz**

**$\pi$  / 4 DQPSK-Hopping Right Side-PK**  
**Note: F1 is frequency 2483.5MHz**

Note: (no need if PK value less than the AV limit)

Note: (no need if PK value less than the AV limit)

**$\pi$  / 4 DQPSK-Hopping Left-AV**

**$\pi$  / 4 DQPSK-Hopping Right-AV**

Note: Both Horizontal and vertical polarities were investigated.

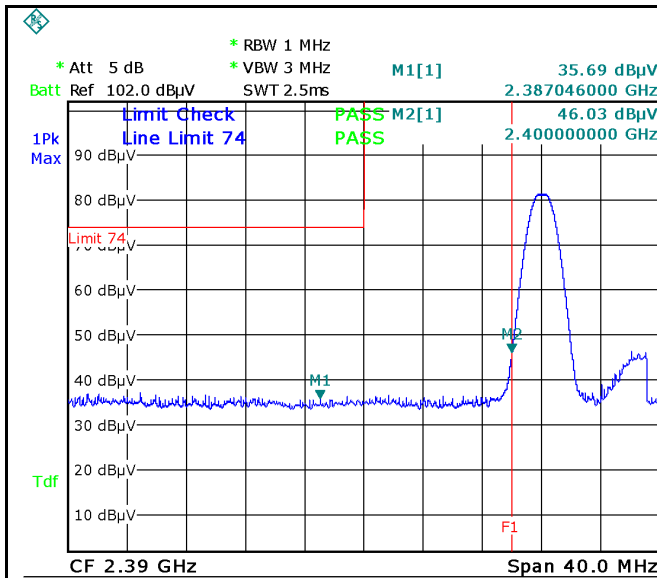

Date: 2.JAN.2018 09:50:28

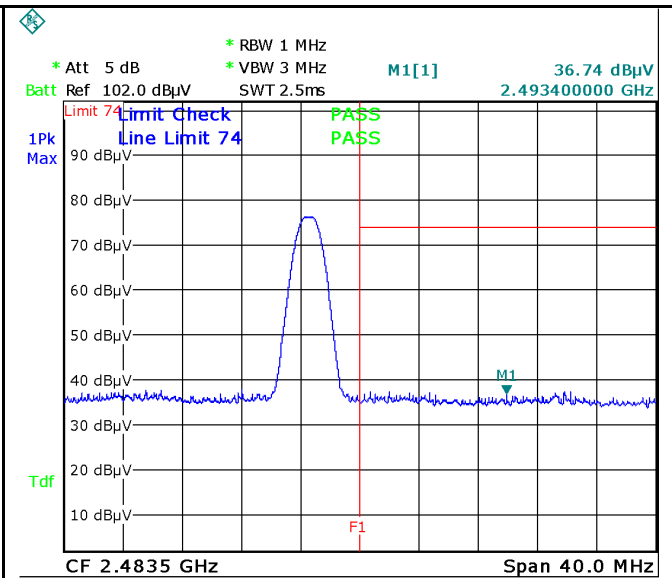

Date: 2.JAN.2018 09:52:51

$\pi$  /4 DQPSK-Left Side-PK

Note: F1 is frequency 2400MHz

$\pi$  /4 DQPSK-Right Side-PK

Note: F1 is frequency 2483.5MHz

Note: (no need if PK value less than the AV limit)

Note: (no need if PK value less than the AV limit)

$\pi$  /4 DQPSK-Left Side-AV

$\pi$  /4 DQPSK-Right Side-AV

Note: Both Horizontal and vertical polarities were investigated.

**8-DPSK Mode:**

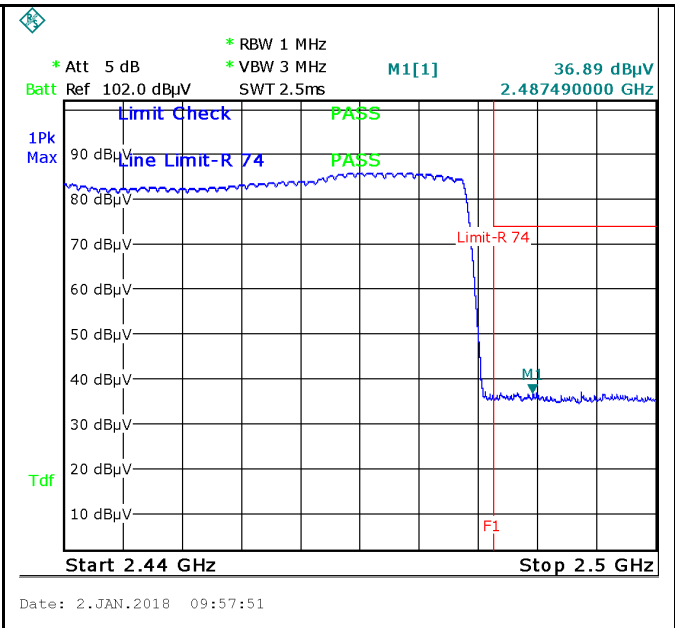
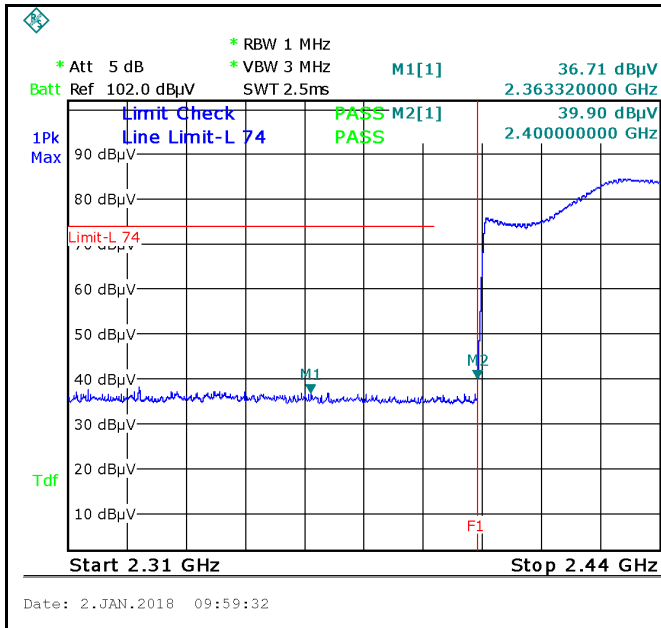

**8DPSK-Hopping Left Side-PK**  
**Note: F1 is frequency 2400MHz**

**8DPSK-Hopping Right Side-PK**  
**Note: F1 is frequency 2483.5MHz**

Note: (no need if PK value less than the AV limit)

Note: (no need if PK value less than the AV limit)

**8DPSK-Hopping Left-AV**

**8DPSK-Hopping Right-AV**

Note: Both Horizontal and vertical polarities were investigated.

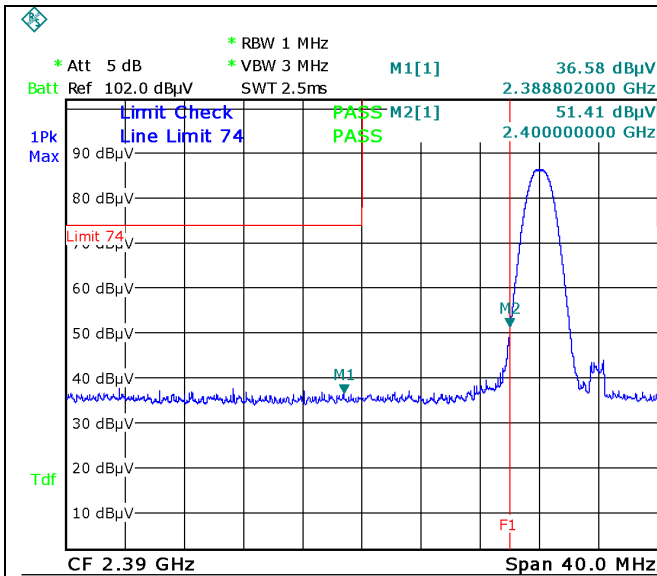

Date: 2.JAN.2018 09:50:46

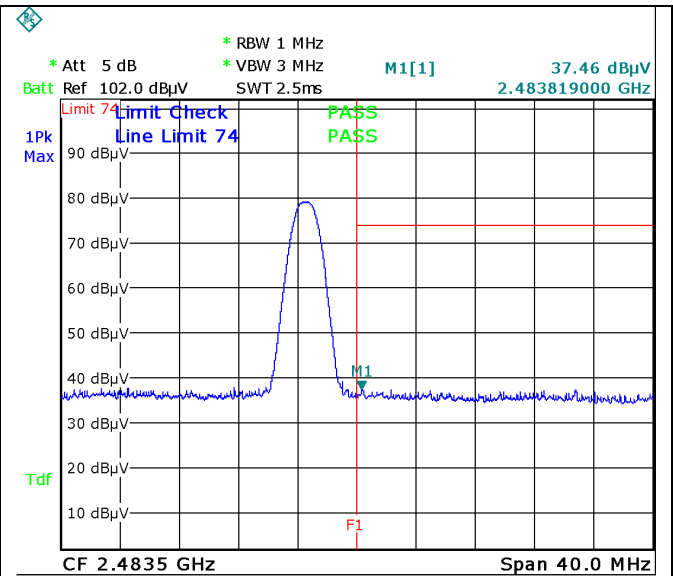

Date: 2.JAN.2018 09:53:12

8DPSK-Left Side-PK

Note: F1 is frequency 2400MHz

8DPSK-Right Side-PK

Note: F1 is frequency 2483.5MHz

Note: (no need if PK value less than the AV limit)

Note: (no need if PK value less than the AV limit)

8DPSK-Left Side-AV

8DPSK-Right Side-AV

Note: Both Horizontal and vertical polarities were investigated.

## 6.8 AC Power Line Conducted Emissions

Temperature	24 °C
Relative Humidity	53%
Atmospheric Pressure	1010mbar
Test date :	December 15, 2017
Tested By :	Aaron Liang

### Requirement(s):

Spec	Item	Requirement	Applicable														
47CFR§15.207, RSS210 (A8.1)	a)	For Low-power radio-frequency devices that is designed to be connected to the public utility (AC) power line, the radio frequency voltage that is conducted back onto the AC power line on any frequency or frequencies, within the band 150 kHz to 30 MHz, shall not exceed the limits in the following table, as measured using a 50 [mu]H/50 ohms line impedance stabilization network (LISN). The lower limit applies at the boundary between the frequencies ranges.	<input checked="" type="checkbox"/>														
		<table border="1"> <thead> <tr> <th rowspan="2">Frequency ranges (MHz)</th> <th colspan="2">Limit (dBµV)</th> </tr> <tr> <th>QP</th> <th>Average</th> </tr> </thead> <tbody> <tr> <td>0.15 ~ 0.5</td> <td>66 – 56</td> <td>56 – 46</td> </tr> <tr> <td>0.5 ~ 5</td> <td>56</td> <td>46</td> </tr> <tr> <td>5 ~ 30</td> <td>60</td> <td>50</td> </tr> </tbody> </table>		Frequency ranges (MHz)	Limit (dBµV)		QP	Average	0.15 ~ 0.5	66 – 56	56 – 46	0.5 ~ 5	56	46	5 ~ 30	60	50
		Frequency ranges (MHz)			Limit (dBµV)												
				QP	Average												
0.15 ~ 0.5	66 – 56	56 – 46															
0.5 ~ 5	56	46															
5 ~ 30	60	50															

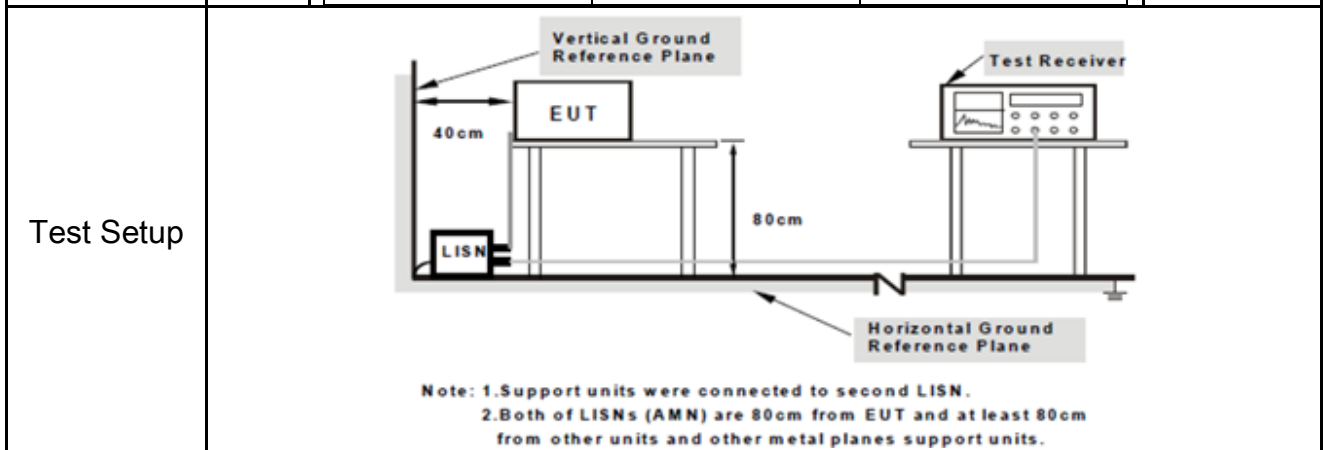

Procedure	<ol style="list-style-type: none"> <li>The EUT and supporting equipment were set up in accordance with the requirements of the standard on top of a 1.5m x 1m x 0.8m high, non-metallic table.</li> <li>The power supply for the EUT was fed through a 50W/50mH EUT LISN, connected to filtered mains.</li> <li>The RF OUT of the EUT LISN was connected to the EMI test receiver via a low-loss</li> </ol>
-----------	---

Test Report	17071380-FCC-R3
Page	38 of 69

	<p>coaxial cable.</p> <ol style="list-style-type: none"> <li>4. All other supporting equipment were powered separately from another main supply.</li> <li>5. The EUT was switched on and allowed to warm up to its normal operating condition.</li> <li>6. A scan was made on the NEUTRAL line (for AC mains) or Earth line (for DC power) over the required frequency range using an EMI test receiver.</li> <li>7. High peaks, relative to the limit line, The EMI test receiver was then tuned to the selected frequencies and the necessary measurements made with a receiver bandwidth setting of 10 kHz.</li> <li>8. Step 7 was then repeated for the LIVE line (for AC mains) or DC line (for DC power).</li> </ol>
Remark	
Result	<input checked="" type="checkbox"/> Pass <input type="checkbox"/> Fail

Test Data  Yes  N/A  
 Test Plot  Yes (See below)  N/A

<b>Test Mode:</b>	<b>Bluetooth Mode</b>
-------------------	-----------------------

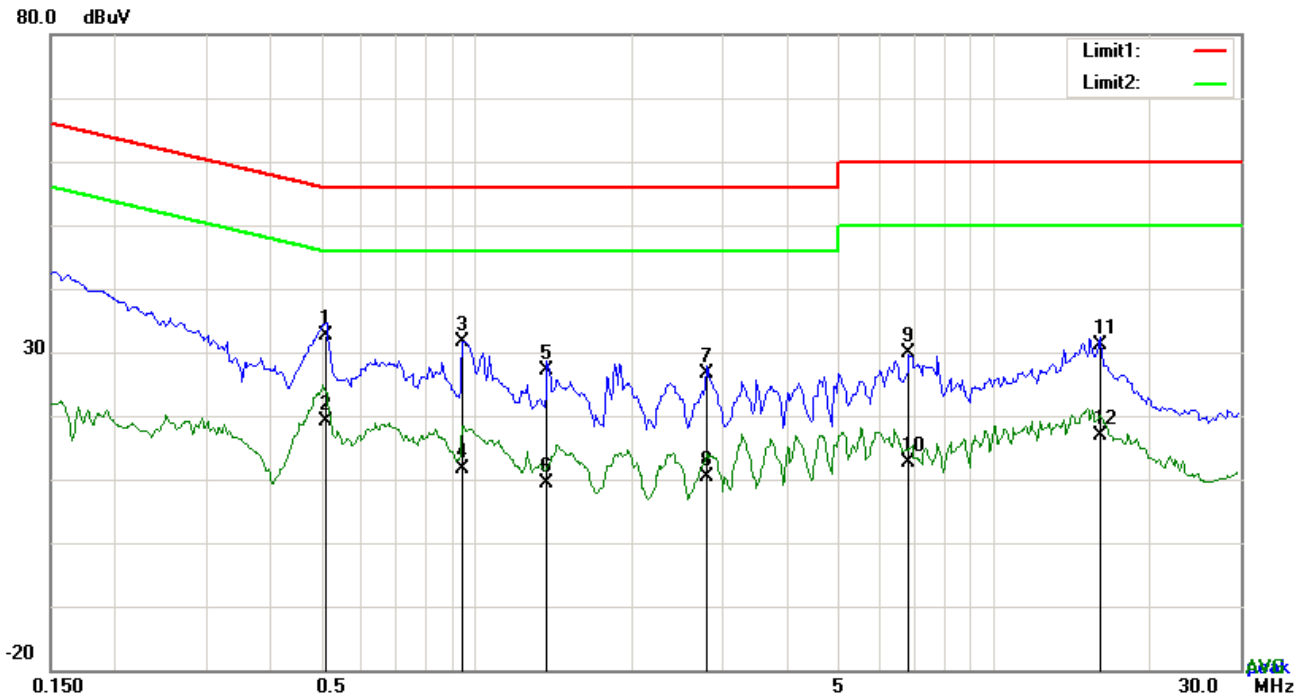

**Test Data**

**Phase Line Plot at 120Vac, 60Hz**

No.	P/L	Frequency	Reading	Detector	Corrected	Result	Limit	Margin
		(MHz)	(dBuV)		(dB)	(dBuV)	(dBuV)	(dB)
1	L1	0.5127	22.60	QP	10.03	32.63	56.00	-23.37
2	L1	0.5127	9.18	AVG	10.03	19.21	46.00	-26.79
3	L1	0.9417	21.55	QP	10.03	31.58	56.00	-24.42
4	L1	0.9417	1.48	AVG	10.03	11.51	46.00	-34.49
5	L1	1.3707	17.20	QP	10.03	27.23	56.00	-28.77
6	L1	1.3707	-0.67	AVG	10.03	9.36	46.00	-36.64
7	L1	2.7825	16.47	QP	10.05	26.52	56.00	-29.48
8	L1	2.7825	0.40	AVG	10.05	10.45	46.00	-35.55
9	L1	6.8532	19.73	QP	10.11	29.84	60.00	-30.16
10	L1	6.8532	2.51	AVG	10.11	12.62	50.00	-37.38
11	L1	16.0923	20.92	QP	10.24	31.16	60.00	-28.84
12	L1	16.0923	6.76	AVG	10.24	17.00	50.00	-33.00

<b>Test Mode:</b>	<b>Bluetooth Mode</b>
-------------------	-----------------------

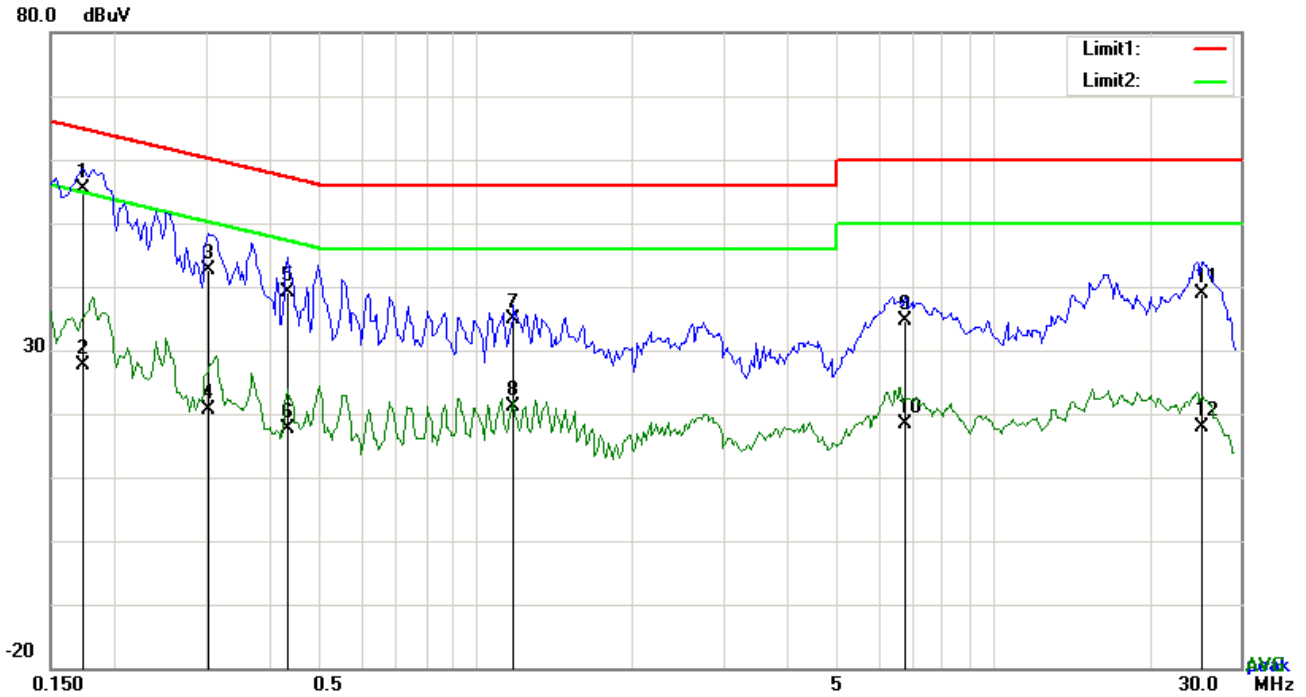

**Test Data**

**Phase Neutral Plot at 120Vac, 60Hz**

No.	P/L	Frequency	Reading	Detector	Corrected	Result	Limit	Margin
		(MHz)	(dBuV)		(dB)	(dBuV)	(dBuV)	(dB)
1	N	0.1734	45.29	QP	10.02	55.31	64.80	-9.49
2	N	0.1734	17.49	AVG	10.02	27.51	54.80	-27.29
3	N	0.3021	32.51	QP	10.02	42.53	60.18	-17.65
4	N	0.3021	10.67	AVG	10.02	20.69	50.18	-29.49
5	N	0.4308	29.12	QP	10.02	39.14	57.24	-18.10
6	N	0.4308	7.50	AVG	10.02	17.52	47.24	-29.72
7	N	1.1835	24.91	QP	10.03	34.94	56.00	-21.06
8	N	1.1835	11.04	AVG	10.03	21.07	46.00	-24.93
9	N	6.7557	24.51	QP	10.09	34.60	60.00	-25.40
10	N	6.7557	8.40	AVG	10.09	18.49	50.00	-31.51
11	N	25.3197	28.65	QP	10.35	39.00	60.00	-21.00
12	N	25.3197	7.64	AVG	10.35	17.99	50.00	-32.01



<b>Test Mode:</b>	<b>Bluetooth Mode</b>
-------------------	-----------------------

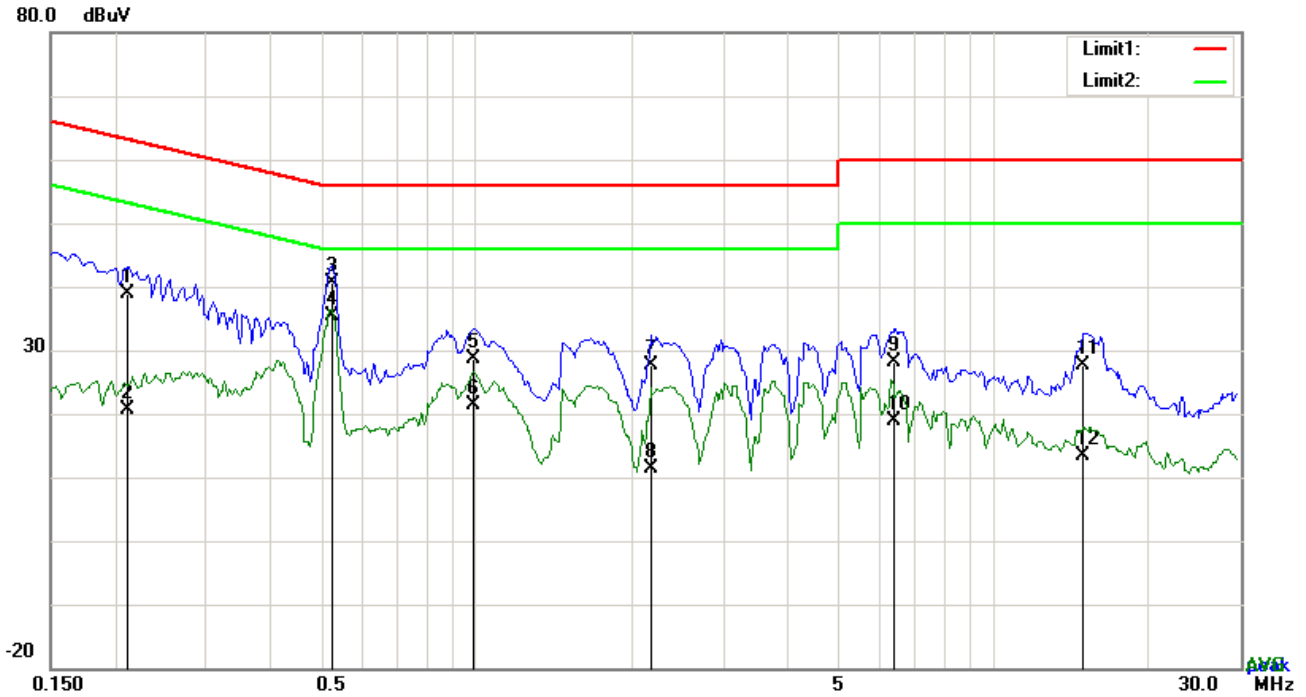

**Test Data**

**Phase Line Plot at 240Vac, 60Hz**

No.	P/L	Frequency	Reading	Detector	Corrected	Result	Limit	Margin
		(MHz)	(dBuV)		(dB)	(dBuV)	(dBuV)	(dB)
1	L1	0.2124	28.86	QP	10.03	38.89	63.11	-24.22
2	L1	0.2124	10.71	AVG	10.03	20.74	53.11	-32.37
3	L1	0.5244	30.55	QP	10.03	40.58	56.00	-15.42
4	L1	0.5244	25.23	AVG	10.03	35.26	46.00	-10.74
5	L1	0.9846	18.61	QP	10.03	28.64	56.00	-27.36
6	L1	0.9846	11.35	AVG	10.03	21.38	46.00	-24.62
7	L1	2.1780	17.50	QP	10.04	27.54	56.00	-28.46
8	L1	2.1780	1.36	AVG	10.04	11.40	46.00	-34.60
9	L1	6.4515	18.00	QP	10.10	28.10	60.00	-31.90
10	L1	6.4515	8.71	AVG	10.10	18.81	50.00	-31.19
11	L1	14.8950	17.48	QP	10.22	27.70	60.00	-32.30
12	L1	14.8950	3.05	AVG	10.22	13.27	50.00	-36.73

<b>Test Mode:</b>	<b>Bluetooth Mode</b>
-------------------	-----------------------

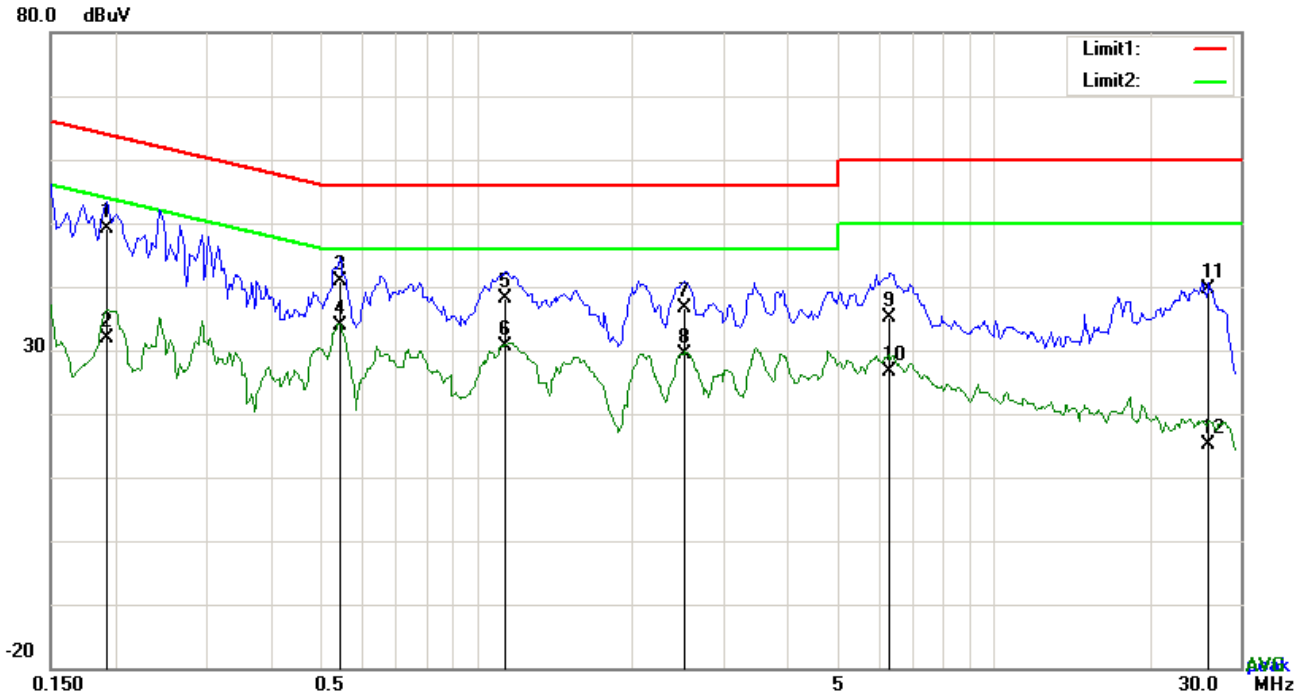

**Test Data**

**Phase Neutral Plot at 240Vac, 60Hz**

No.	P/L	Frequency	Reading	Detector	Corrected	Result	Limit	Margin
		(MHz)	(dBuV)		(dB)	(dBuV)	(dBuV)	(dB)
1	N	0.1929	39.14	QP	10.02	49.16	63.91	-14.75
2	N	0.1929	21.78	AVG	10.02	31.80	53.91	-22.11
3	N	0.5439	30.82	QP	10.02	40.84	56.00	-15.16
4	N	0.5439	23.78	AVG	10.02	33.80	46.00	-12.20
5	N	1.1406	28.20	QP	10.03	38.23	56.00	-17.77
6	N	1.1406	20.62	AVG	10.03	30.65	46.00	-15.35
7	N	2.5290	26.55	QP	10.05	36.60	56.00	-19.40
8	N	2.5290	19.40	AVG	10.05	29.45	46.00	-16.55
9	N	6.2877	25.15	QP	10.09	35.24	60.00	-24.76
10	N	6.2877	16.44	AVG	10.09	26.53	50.00	-23.47
11	N	26.0178	29.35	QP	10.36	39.71	60.00	-20.29
12	N	26.0178	4.88	AVG	10.36	15.24	50.00	-34.76

## 6.9 Radiated Emissions & Restricted Band

Temperature	24 °C
Relative Humidity	55%
Atmospheric Pressure	1008mbar
Test date :	December 13, 2017
Tested By :	Aaron Liang

### Requirement(s):

Spec	Item	Requirement	Applicable																
47CFR§15.205, §15.209, §15.247(d)	a)	Except higher limit as specified elsewhere in other section, the emissions from the low-power radio-frequency devices shall not exceed the field strength levels specified in the following table and the level of any unwanted emissions shall not exceed the level of the fundamental emission. The tighter limit applies at the band edges	<input checked="" type="checkbox"/>																
		<table border="1"> <thead> <tr> <th>Frequency range (MHz)</th> <th>Field Strength (<math>\mu\text{V}/\text{m}</math>)</th> </tr> </thead> <tbody> <tr> <td>0.009~0.490</td> <td>2400/F(KHz)</td> </tr> <tr> <td>0.490~1.705</td> <td>24000/F(KHz)</td> </tr> <tr> <td>1.705~30.0</td> <td>30</td> </tr> <tr> <td>30 – 88</td> <td>100</td> </tr> <tr> <td>88 – 216</td> <td>150</td> </tr> <tr> <td>216 960</td> <td>200</td> </tr> <tr> <td>Above 960</td> <td>500</td> </tr> </tbody> </table>		Frequency range (MHz)	Field Strength ( $\mu\text{V}/\text{m}$ )	0.009~0.490	2400/F(KHz)	0.490~1.705	24000/F(KHz)	1.705~30.0	30	30 – 88	100	88 – 216	150	216 960	200	Above 960	500
		Frequency range (MHz)		Field Strength ( $\mu\text{V}/\text{m}$ )															
		0.009~0.490		2400/F(KHz)															
		0.490~1.705		24000/F(KHz)															
		1.705~30.0		30															
		30 – 88		100															
		88 – 216		150															
216 960	200																		
Above 960	500																		

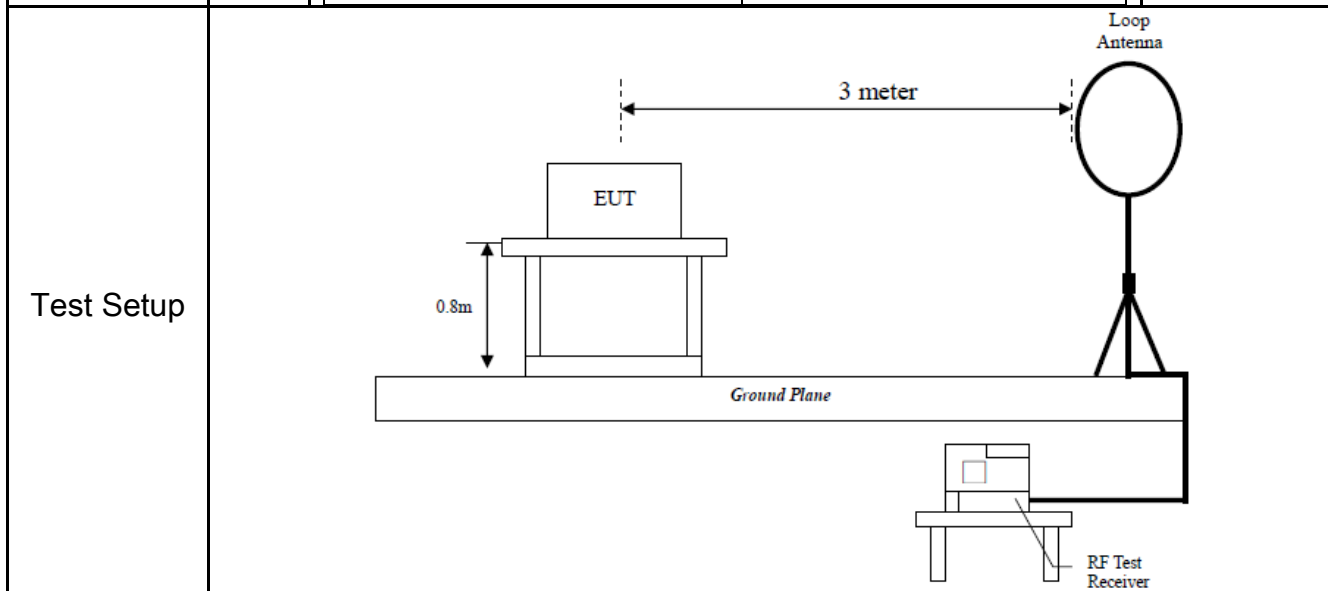

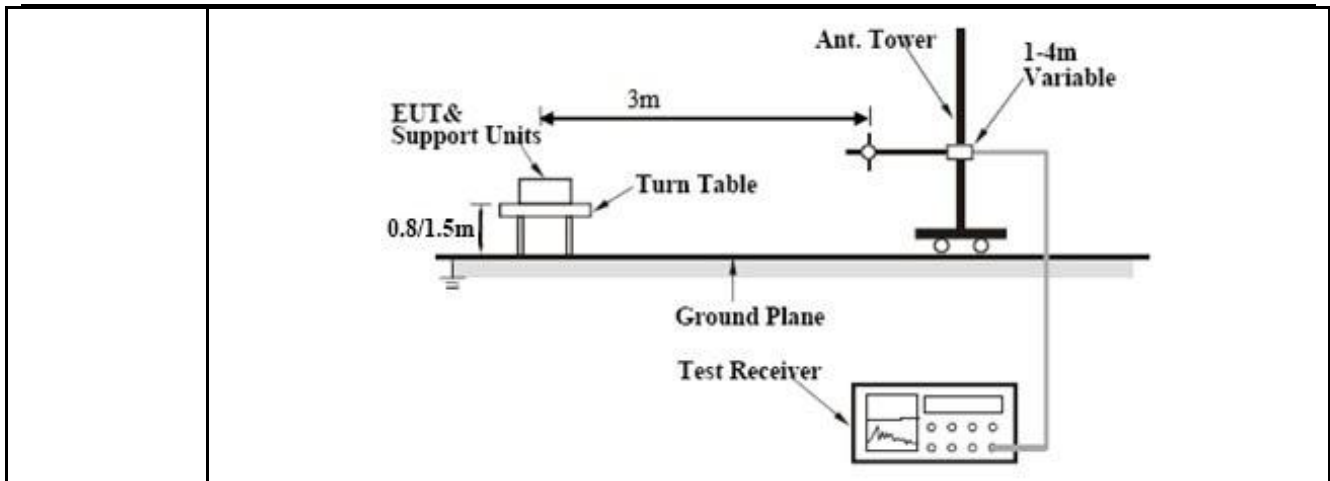

**Procedure**

- The EUT was switched on and allowed to warm up to its normal operating condition.
- The test was carried out at the selected frequency points obtained from the EUT characterization. Maximization of the emissions, was carried out by rotating the EUT, changing the antenna polarization, and adjusting the antenna height in the following manner:
  - Vertical or horizontal polarization (whichever gave the higher emission level over a full rotation of the EUT) was chosen.
  - The EUT was then rotated to the direction that gave the maximum emission.
  - Finally, the antenna height was adjusted to the height that gave the maximum emission.
- The resolution bandwidth and video bandwidth of test receiver/spectrum analyzer is 120 kHz for Quasi Peak detection at frequency below 1GHz.
- The resolution bandwidth of test receiver/spectrum analyzer is 1MHz and video bandwidth is 3MHz with Peak detection for Peak measurement at frequency above 1GHz.  
The resolution bandwidth of test receiver/spectrum analyzer is 1MHz and the video bandwidth is 10Hz with Peak detection for Average Measurement as below at frequency above 1GHz.
- Steps 2 and 3 were repeated for the next frequency point, until all selected frequency points were measured.

**Remark**

**Result**  Pass  Fail

**Test Data**  Yes  N/A

**Test Plot**  Yes (See below)  N/A

**Test Result:**

<b>Test Mode:</b>	Transmitting Mode
-------------------	-------------------

Frequency range: 9KHz - 30MHz

Freq. (MHz)	Detection value	Factor (dB/m)	Reading (dBuV/m)	Result (dBuV/m)	Limit@3m (dBuV/m)	Margin (dB)
--	--	--	--	--	--	>20
--	--	--	--	--	--	>20

**Note:**

The amplitude of spurious emissions which are attenuated by more than 20dB below the permissible value has no need to be reported.

Distance extrapolation factor =  $40 \log (\text{specific distance}/\text{test distance})(\text{dB})$ ;

Limit line = specific limits(dBuv) + distance extrapolation factor.

**Test Mode:** Bluetooth Mode

**30MHz -1GHz**

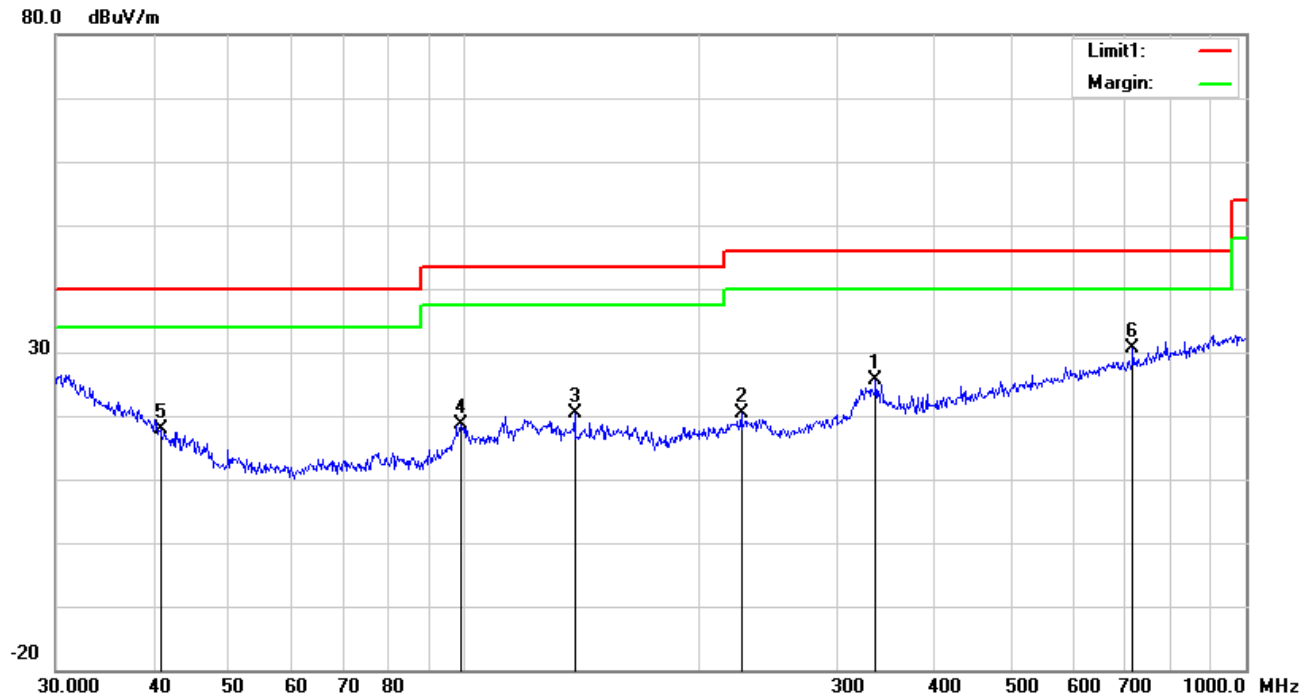

**Test Data**

**Horizontal Polarity Plot @3m**

No.	P/L	Frequency (MHz)	Reading (dBuV/m)	Detect or	Ant_F (dB/m)	PA_G (dB)	Cab_L (dB)	Result (dBuV/m)	Limit (dBuV/m)	Margin (dB)	Height (cm)	Degr ee ( )
1	H	336.0352	31.59	peak	14.36	22.19	1.97	25.73	46.00	-20.27	100	90
2	H	226.0994	29.41	peak	11.73	22.33	1.62	20.43	46.00	-25.57	100	316
3	H	138.3873	28.74	peak	12.70	22.41	1.26	20.29	43.50	-23.21	100	128
4	H	99.1797	29.54	peak	10.20	22.32	1.10	18.52	43.50	-24.98	100	102
5	H	40.8446	26.13	peak	13.34	22.28	0.78	17.97	40.00	-22.03	100	85
6	H	716.6820	28.86	peak	20.40	21.32	2.65	30.59	46.00	-15.41	100	251

### 30MHz -1GHz

80.0 dBuV/m

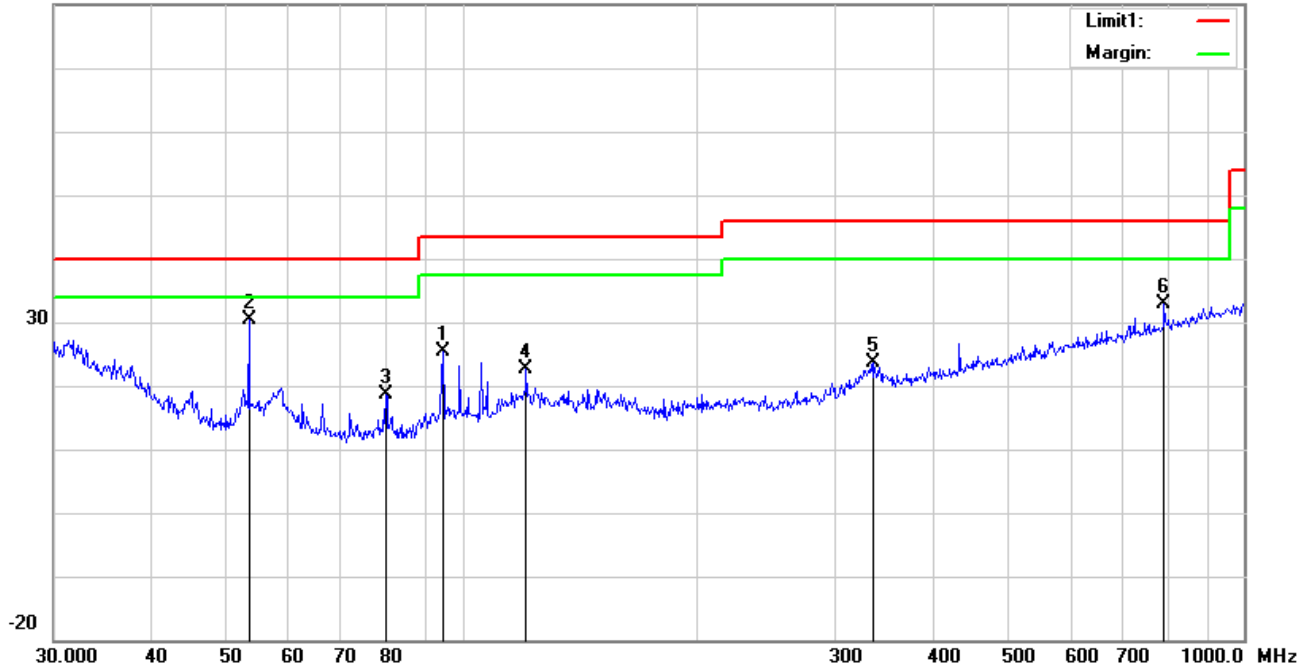

### Test Data

#### Vertical Polarity Plot @3m

No.	P/L	Frequency (MHz)	Reading (dBuV/m)	Detect or	Ant_F (dB/m)	PA_G (dB)	Cab_L (dB)	Result (dBuV/m)	Limit (dBuV/m)	Margin (dB)	Height (cm)	Degr ee ( )
1	V	94.4284	37.66	peak	9.06	22.32	0.99	25.39	43.50	-18.11	100	301
2	V	53.3179	43.83	peak	8.04	22.39	0.79	30.27	40.00	-9.73	100	342
3	V	79.8003	32.44	peak	7.60	22.42	1.05	18.67	40.00	-21.33	100	185
4	V	120.6991	30.08	peak	13.85	22.36	1.16	22.73	43.50	-20.77	100	316
5	V	336.0352	29.54	peak	14.36	22.19	1.97	23.68	46.00	-22.32	100	307
6	V	790.6188	29.93	peak	21.29	21.17	2.94	32.99	46.00	-13.01	100	172

### Above 1GHz

<b>Test Mode:</b>	<b>Transmitting Mode</b>
-------------------	--------------------------

#### Low Channel: GFSK Mode (Worst Case) (2402 MHz)

Frequency (MHz)	S.A. Reading (dB $\mu$ V)	Detector (PK/AV)	Polarity (H/V)	Ant. Factor (dB/m)	Cable Loss (dB)	Pre-Amp. Gain (dB)	Cord. Amp. (dB $\mu$ V/m)	Limit (dB $\mu$ V/m)	Margin (dB)
4804	47.19	AV	V	33.39	7.22	48.46	39.34	54	-14.66
4804	43.41	AV	H	33.39	7.22	48.46	35.56	54	-18.44
4804	65.78	PK	V	33.39	7.22	48.46	57.93	74	-16.07
4804	66.56	PK	H	33.39	7.22	48.46	58.71	74	-15.29
13440	18.53	AV	V	40.95	13.47	47.05	25.9	54	-28.1
13440	20.33	AV	H	40.95	13.47	47.05	27.7	54	-26.3
13440	40.22	PK	V	40.95	13.47	47.05	47.59	74	-26.41
13440	40.11	PK	H	40.95	13.47	47.05	47.48	74	-26.52

#### Middle Channel: GFSK Mode (Worst Case) (2441 MHz)

Frequency (MHz)	S.A. Reading (dB $\mu$ V)	Detector (PK/AV)	Polarity (H/V)	Ant. Factor (dB/m)	Cable Loss (dB)	Pre-Amp. Gain (dB)	Cord. Amp. (dB $\mu$ V/m)	Limit (dB $\mu$ V/m)	Margin (dB)
4882	49.77	AV	V	33.62	7.53	48.36	42.56	54	-11.44
4882	43.54	AV	H	33.62	7.53	48.36	36.33	54	-17.67
4882	66.32	PK	V	33.62	7.53	48.36	59.11	74	-14.89
4882	63.83	PK	H	33.62	7.53	48.36	56.62	74	-17.38
13502	30.56	AV	V	40.14	12.86	46.05	37.51	54	-16.49
13502	28.49	AV	H	40.14	12.86	46.05	35.44	54	-18.56
13502	46.85	PK	V	40.14	12.86	46.05	53.8	74	-20.2
13502	47.82	PK	H	40.14	12.86	46.05	54.77	74	-19.23



**High Channel: GFSK Mode (Worst Case) (2480 MHz)**

Frequency (MHz)	S.A. Reading (dB $\mu$ V)	Detector (PK/AV)	Polarity (H/V)	Ant. Factor (dB/m)	Cable Loss (dB)	Pre-Amp. Gain (dB)	Cord. Amp. (dB $\mu$ V/m)	Limit (dB $\mu$ V/m)	Margin (dB)
4960	43.47	AV	V	33.89	7.86	48.31	36.91	54	-17.09
4960	48.72	AV	H	33.89	7.86	48.31	42.16	54	-11.84
4960	71.33	PK	V	33.89	7.86	48.31	64.77	74	-9.23
4960	63.63	PK	H	33.89	7.86	48.31	57.07	74	-16.93
17917	20.77	AV	V	43.15	19.4	44.12	39.2	54	-14.8
17917	20.08	AV	H	43.15	19.4	44.12	38.51	54	-15.49
17917	41.2	PK	V	43.15	19.4	44.12	59.63	74	-14.37
17917	42.26	PK	H	43.15	19.4	44.12	60.69	74	-13.31

**Note:**

1, The testing has been conformed to  $10 \times 2480 \text{ MHz} = 24,800 \text{ MHz}$

2, All other emissions more than 30 dB below the limit

3, X-Axis, Y-Axis and Z-Axis were investigated. The results above show only the worst case.

4, The radiated spurious test above 18GHz is subcontracted to SIEMIC (Nanjing-China) Laboratories. and found 30dB below the limit at least.

## Annex A. TEST INSTRUMENT

Instrument	Model	Serial #	Cal Date	Cal Due	In use
<b>AC Line Conducted</b>					
EMI test receiver	ESCS30	8471241027	09/15/2017	09/14/2018	<input checked="" type="checkbox"/>
Line Impedance	LI-125A	191106	09/23/2017	09/22/2018	<input checked="" type="checkbox"/>
Line Impedance	LI-125A	191107	09/23/2017	09/22/2018	<input checked="" type="checkbox"/>
ISN	ISN T800	34373	09/23/2017	09/22/2018	<input type="checkbox"/>
Transient Limiter	LIT-153	531118	08/30/2017	08/29/2018	<input type="checkbox"/>
<b>RF conducted test</b>					
Agilent ESA-E SERIES	E4407B	MY45108319	09/15/2017	09/14/2018	<input checked="" type="checkbox"/>
Power Splitter	1#	1#	08/30/2017	08/29/2018	<input checked="" type="checkbox"/>
DC Power Supply	E3640A	MY40004013	09/15/2017	09/14/2018	<input checked="" type="checkbox"/>
<b>Radiated Emissions</b>					
EMI test receiver	ESL6	100262	09/15/2017	09/14/2018	<input checked="" type="checkbox"/>
Positioning Controller	UC3000	MF780208282	11/17/2017	11/16/2018	<input checked="" type="checkbox"/>
OPT 010 AMPLIFIER (0.1-1300MHz)	8447E	2727A02430	08/30/2017	08/29/2018	<input checked="" type="checkbox"/>
Microwave Preamplifier (1 ~ 26.5GHz)	8449B	3008A02402	03/23/2017	03/22/2018	<input checked="" type="checkbox"/>
Horn Antenna	BBHA9170	3145226D1	09/27/2017	09/26/2018	<input checked="" type="checkbox"/>
Active Antenna (9kHz-30MHz)	AL-130	121031	10/12/2017	10/11/2018	<input checked="" type="checkbox"/>
Bilog Antenna (30MHz~6GHz)	JB6	A110712	09/19/2017	09/18/2018	<input checked="" type="checkbox"/>
Double Ridge Horn Antenna (1 ~18GHz)	AH-118	71283	09/22/2017	09/21/2018	<input checked="" type="checkbox"/>
Universal Radio Communication Tester	CMU200	121393	09/23/2017	09/22/2018	<input checked="" type="checkbox"/>

## Annex B. EUT And Test Setup Photographs

### Annex B.i. Photograph: EUT External Photo

Whole Package View



Adapter View 1



Adapter View 2



EUT - Front View

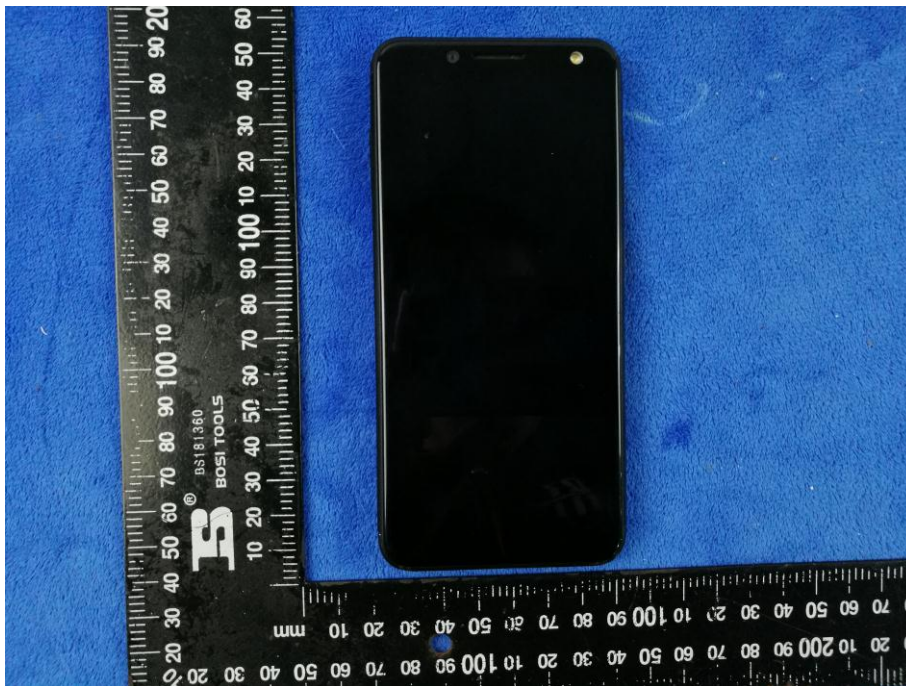

EUT - Rear View



EUT - Top View



EUT - Bottom View



EUT - Left View

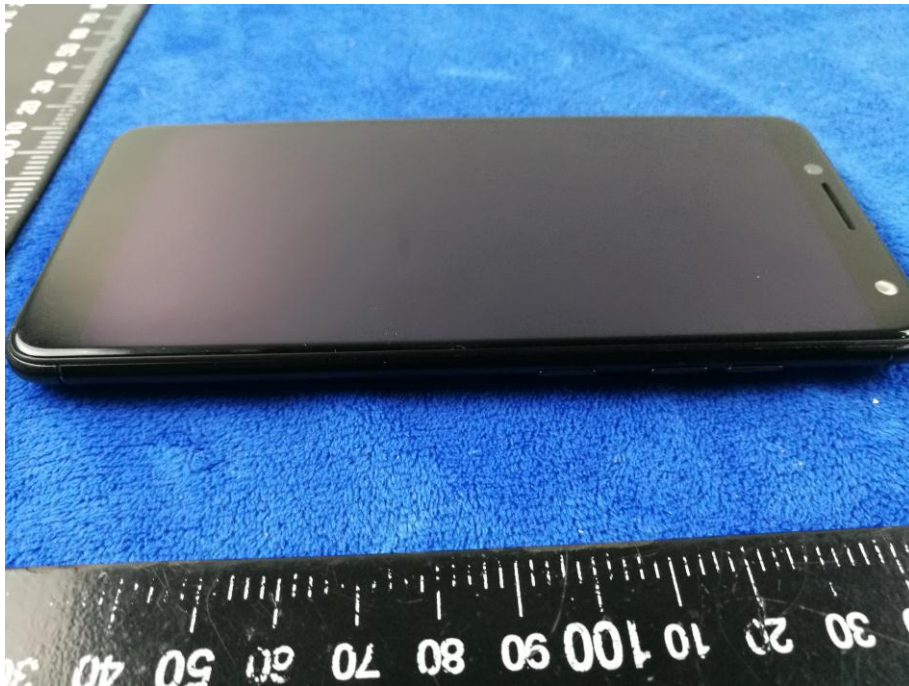

EUT - Right View

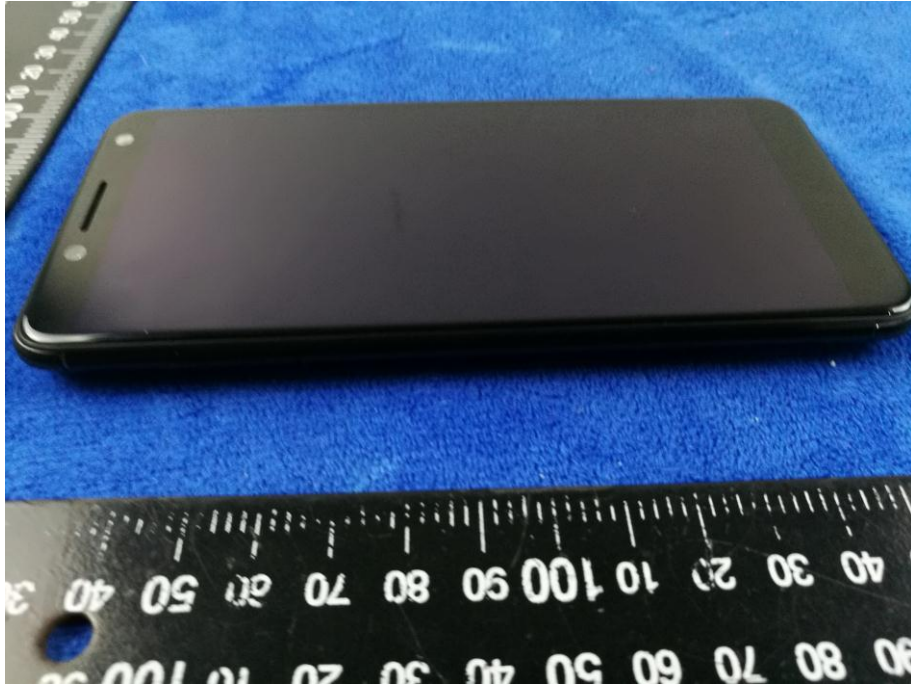

**Annex B.ii. Photograph: EUT Internal Photo**

Cover Off - Top View 1



Cover Off - Top View 2





Battery - Front View



Battery - Rear View

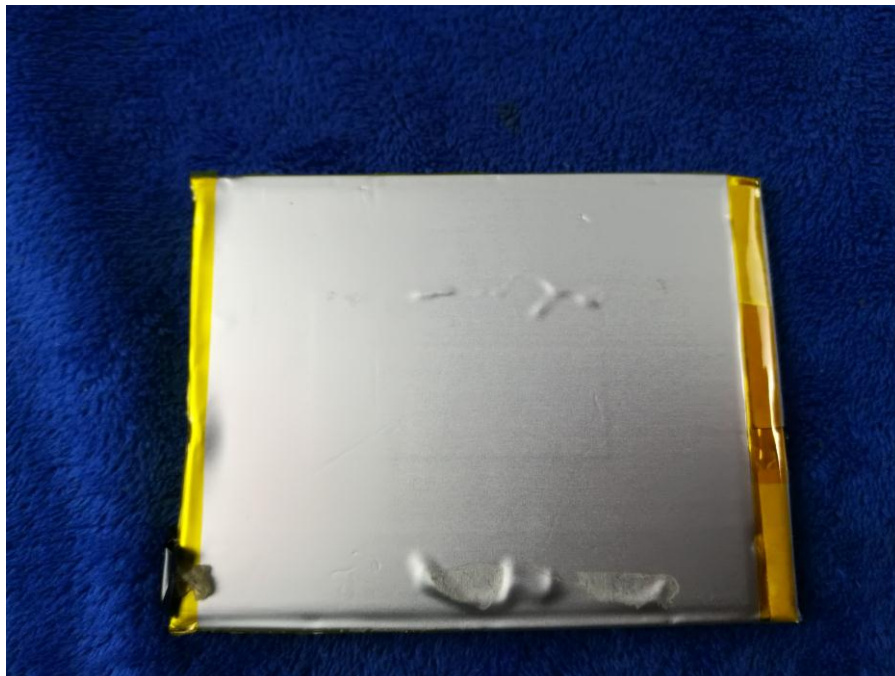

Mainboard with Shielding - Front View



Mainboard without Shielding - Rear View



Smallboard – Front View

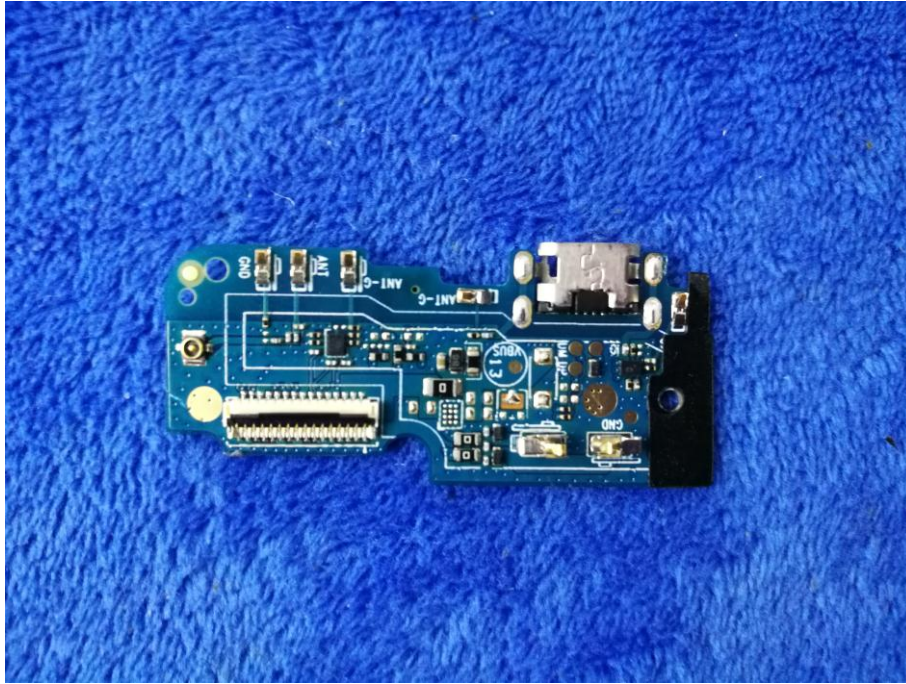

Smallboard – Rear View



LCD – Front View



LCD – Rear View



GSM/PCS/UMTS-FDD/LTE Antenna View

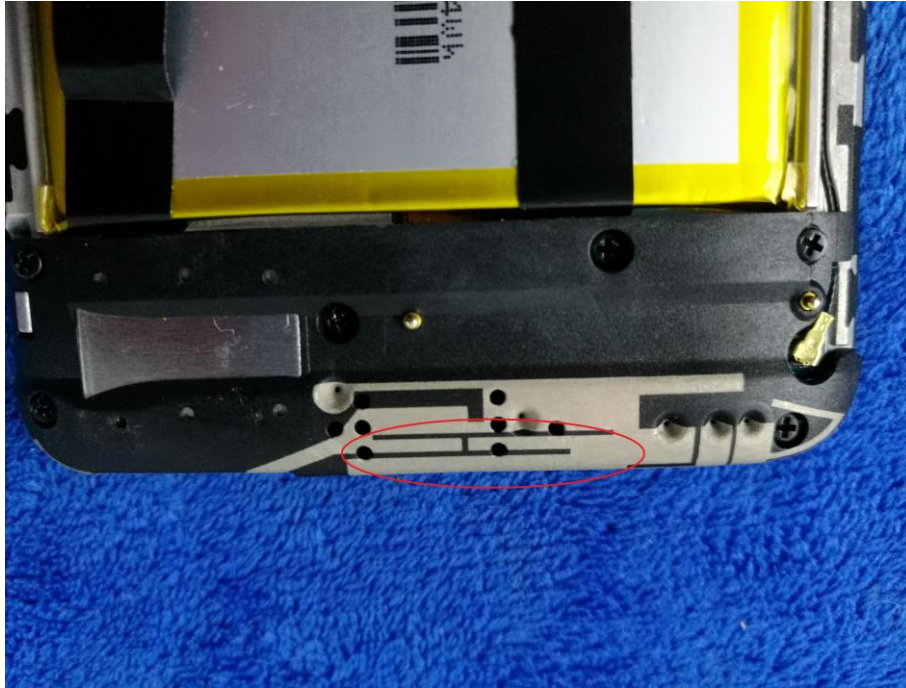

WIFI/BT/BLE/GPS - Antenna View



RXD- Antenna View

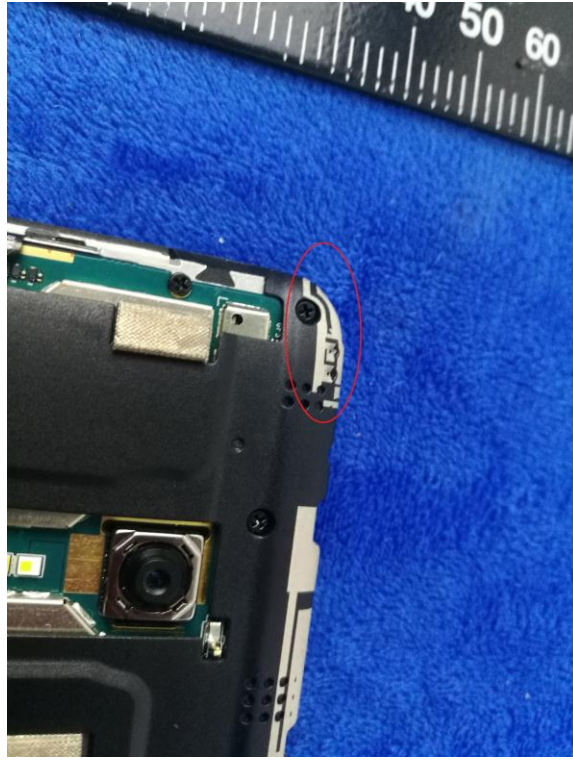

**Annex B.iii. Photograph: Test Setup Photo**



Conducted Emissions Test Setup Front View



Conducted Emissions Test Setup Side View

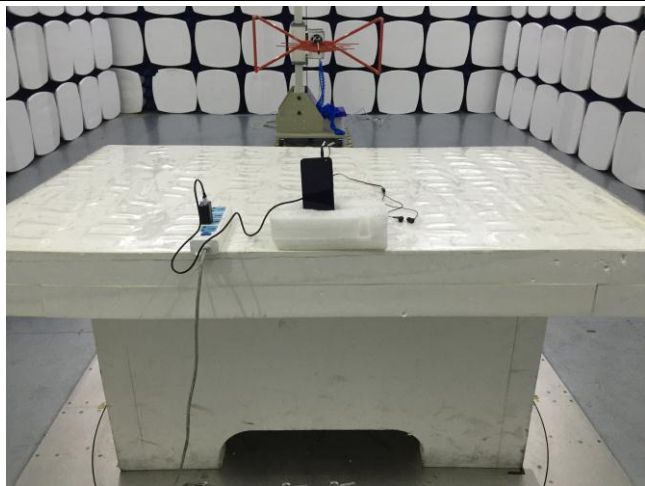

Radiated Spurious Emissions Test Setup Below 1GHz



Radiated Spurious Emissions Test Setup Above  
1GHz

## Annex C. TEST SETUP AND SUPPORTING EQUIPMENT

### Annex C.ii. TEST SET UP BLOCK

#### Block Configuration Diagram for AC Line Conducted Emissions

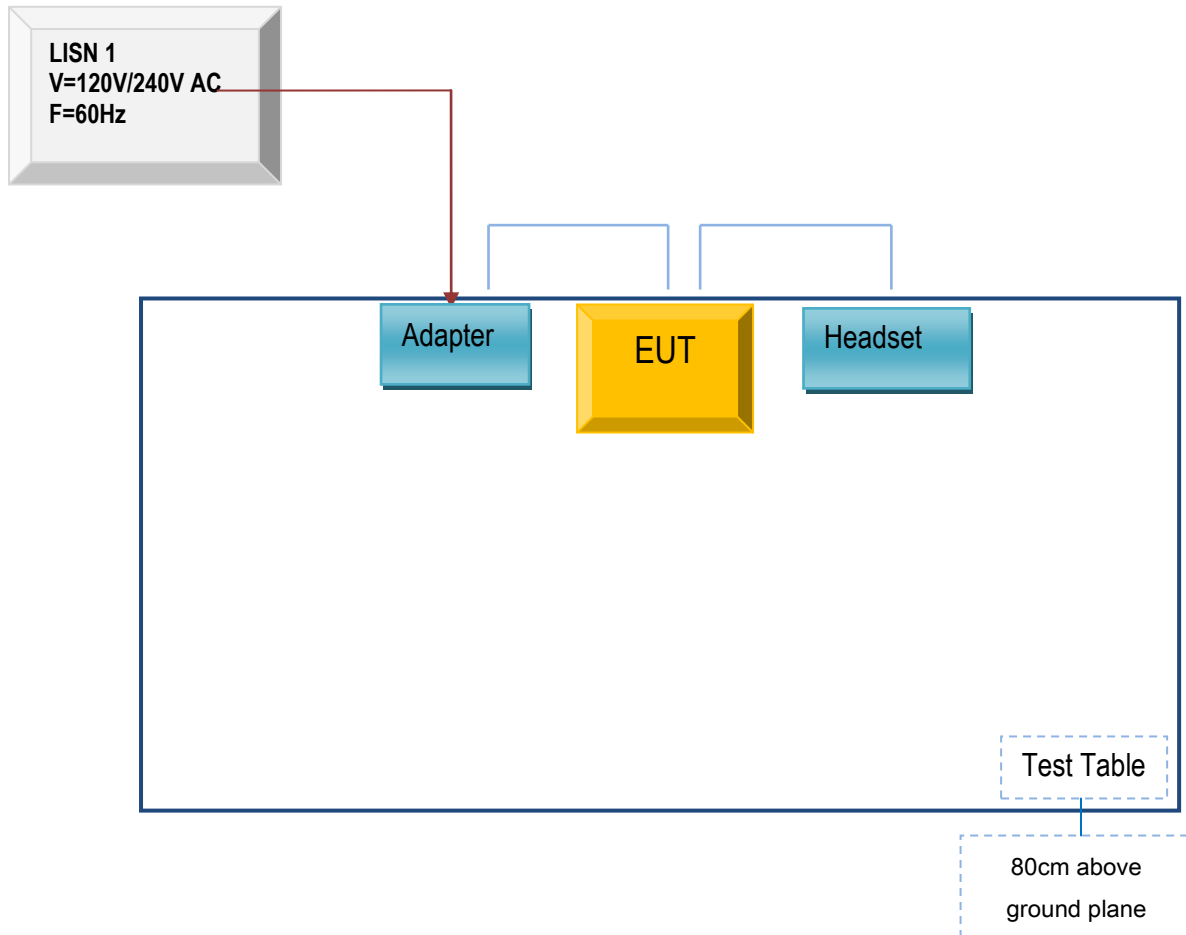



Block Configuration Diagram for Radiated Emissions ( Below 1GHz ) .

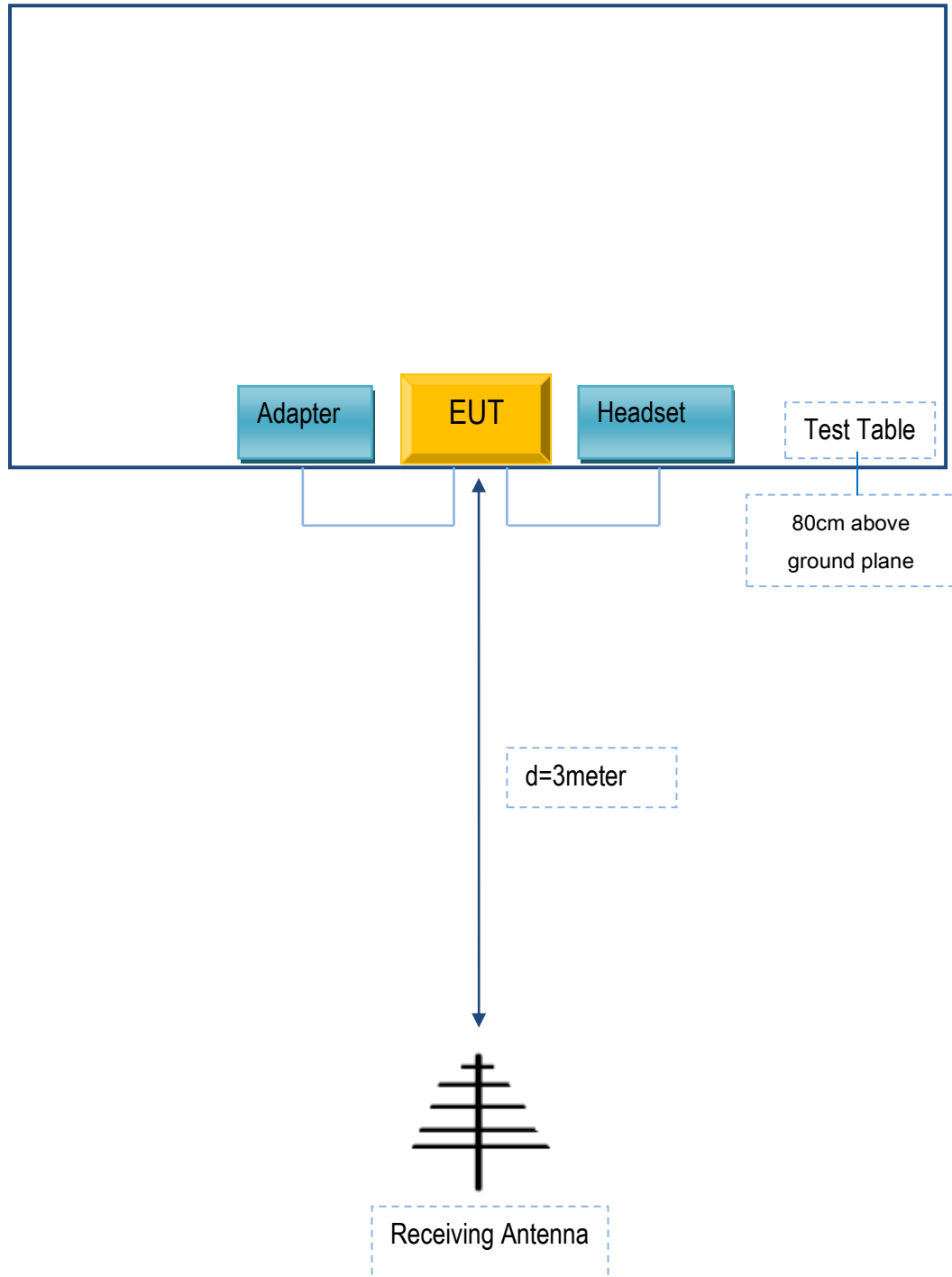

**Block Configuration Diagram for Radiated Emissions ( Above 1GHz ) .**

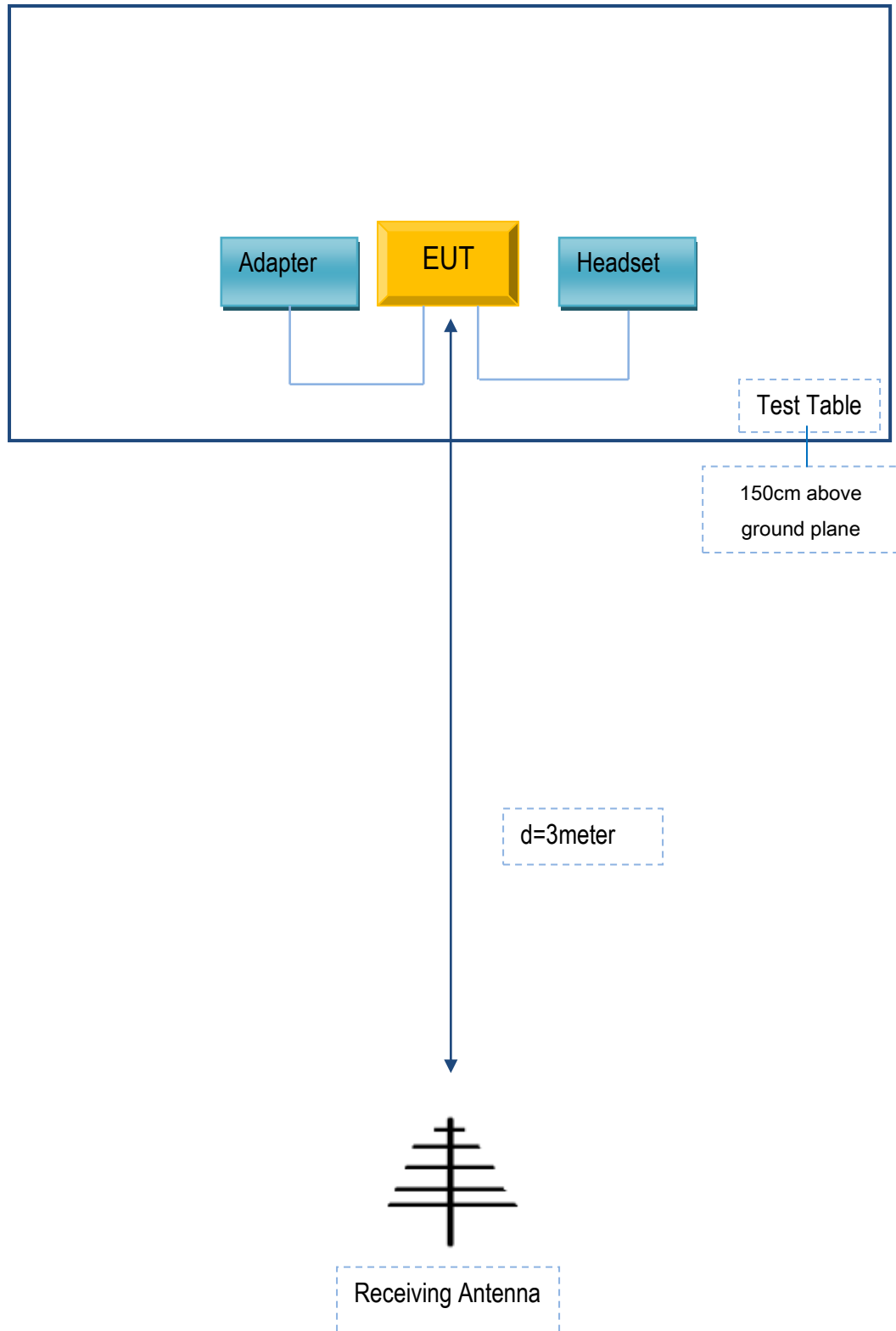

## Annex C. ii. SUPPORTING EQUIPMENT DESCRIPTION

The following is a description of supporting equipment and details of cables used with the EUT.

### Supporting Equipment:

Manufacturer	Equipment Description	Model	Serial No
BLU Products, Inc	Adapter	TPA-46050150UU	N/A
BLU Products, Inc	headset	VIVO ONE	N/A

### Supporting Cable:

Cable type	Shield Type	Ferrite Core	Length	Serial No
USB Cable	Un-shielding	No	0.8m	N/A

Test Report	17071380-FCC-R3
Page	68 of 69

**Annex D. User Manual / Block Diagram / Schematics / Partlist**

Please see the attachment

Test Report	17071380-FCC-R3
Page	69 of 69

## Annex E. DECLARATION OF SIMILARITY

N/A