



FCC SAR TEST REPORT

Report No.: STS2201226H01

Issued for

BLU Products, Inc.

10814 NW 33rd St # 100 Doral, FL 33172, USA

Product Name:	Mobile Phone
Brand Name:	BLU
Model Name:	STUDIO X5 MAX
Series Model:	N/A
FCC ID:	YHLBLUSTX5MX
Test Standard:	ANSI/IEEE Std. C95.1
	FCC 47 CFR Part 2 (2.1093)
	IEEE 1528: 2013
Max. Report SAR (1g):	Head: 0.794 W/kg
	Body: 0.779 W/kg

Any reproduction of this document must be done in full. No single part of this document may be reproduced without permission from STS, All Test Data Presented in this report is only applicable to presented Test sample.

ShenZhen STS Test Services Co.,Ltd.

A 1/F, Building B, Zhuoke Science Park, No.190 Chongqing Road, HepingShequ, Fuyong Sub-District, Bao'an District, Shenzhen, Guang Dong, China

TEL: +86-755 3688 6288 FAX: +86-755 3688 6277 E-mail:sts@stsapp.com

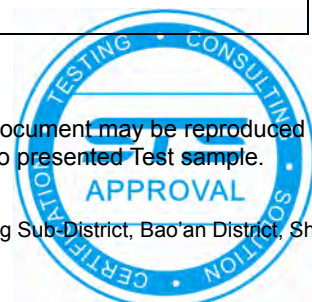



Test Report Certification

Applicant's name : BLU Products, Inc.
 Address : 10814 NW 33rd St # 100 Doral, FL 33172, USA
Manufacturer's Name : BLU Products, Inc.
 Address : 10814 NW 33rd St # 100 Doral, FL 33172, USA

Product description

Product name : Mobile Phone
 Brand name : BLU
 Model name : STUDIO X5 MAX
 Series Model..... : N/A

Standards : ANSI/IEEE Std. C95.1-1992
 FCC 47 CFR Part 2 (2.1093)
 IEEE 1528: 2013

The device was tested by Shenzhen STS Test Services Co., Ltd. in accordance with the measurement methods and procedures specified in KDB 865664 The test results in this report apply only to the tested sample of the stated device/equipment. Other similar device/equipment will not necessarily produce the same results due to production tolerance and measurement uncertainties.

Date of Test :
 Date (s) of performance of tests : 15 Feb. 2022 ~ 02 Mar. 2022
 Date of Issue..... : 30 Mar. 2022
 Test Result..... : **Pass**

Testing Engineer : Shi fan-long
 (Shifan. Long)

Technical Manager : Sean she
 (Sean she)

Authorized Signatory : Bovey Yang
 (Bovey Yang)





Table of Contents

1. General Information	5
1.1 EUT Description	5
1.2 Test Environment	7
1.3 Test Factory	7
2. Test Standards and Limits	8
3. SAR Measurement System	9
3.1 Definition of Specific Absorption Rate (SAR)	9
3.2 SAR System	9
4. Tissue Simulating Liquids	12
4.1 Simulating Liquids Parameter Check	12
5. SAR System Validation	15
5.1 Validation System	15
5.2 Validation Result	15
6. SAR Evaluation Procedures	16
7. EUT Antenna Location Sketch	17
7.1 SAR test exclusion consider table	18
8. EUT Test Position	25
8.1 Define Two Imaginary Lines on the Handset	25
8.2 Hotspot mode exposure position condition	26
9. Uncertainty	27
9.1 Measurement Uncertainty	27
10. Conducted Power Measurement	28
10.1 Test Result	28
11. EUT and Test Setup Photo	49
11.1 EUT Photo	49
11.2 Setup Photo	52
12. SAR Result Summary	58
12.1 Head SAR	58
12.2 Body-worn and Hotspot SAR	62
13. Equipment List	69
Appendix A. System Validation Plots	70
Appendix B. SAR Test Plots	88
Appendix C. Probe Calibration and Dipole Calibration Report	122



Revision History

Rev.	Issue Date	Report No.	Effect Page	Contents
00	30 Mar. 2022	STS2201226H01	ALL	Initial Issue





1. General Information

Environmental evaluation measurements of specific absorption rate (SAR) distributions in emulated human head and body tissues exposed to radio frequency (RF) radiation from wireless portable devices for compliance with the rules and regulations of the U.S. Federal Communications Commission (FCC).

1.1 EUT Description

Product Name	Mobile Phone
Brand Name	BLU
Model Name	STUDIO X5 MAX
Series Model	N/A
Model Difference	N/A
Battery	Rated Voltage:3.8V Charge Limit Voltage:4.35V Capacity: 2700mAh
Device Category	Portable
Product stage	Production unit
RF Exposure Environment	General Population / Uncontrolled
IMEI	IMEI 1: 359588046382819/78 IMEI 2: 359588046382700/78
Hardware Version	HCT-M896MB-A2
Software Version	BLU_S0630WW_V11.0.G.01.01_GENERIC_11-01-20221436
Frequency Range	GSM 850: 824 MHz ~ 849 MHz PCS1900: 1850 MHz ~ 1910 MHz WCDMA Band II: 1850 MHz ~ 1910 MHz WCDMA Band IV:1710 MHz ~ 1755 MHz WCDMA Band V: 824 MHz ~ 849 MHz LTE Band 2: 1850 MHz ~ 1910 MHz LTE Band 4: 1710 MHz ~ 1755 MHz LTE Band 5: 824 MHz ~ 849 MHz LTE Band 7:2500 MHz ~ 2570 MHz LTE Band 12: 699 MHz ~ 716 MHz LTE Band 17: 704 MHz ~ 716 MHz LTE Band 66: 1710 MHz ~ 1780 MHz WLAN802.11b/g/n20: 2412 MHz ~ 2462 MHz WLAN 802.11n40: 2422 MHz ~ 2452 MHz WLAN 802.11a/n20/n40: 5150 ~ 5250 MHz WLAN 802.11a/n20/n40: 5250 ~ 5350 MHz WLAN 802.11a/n20/n40: 5470 ~ 5725 MHz WLAN 802.11a/n20/n40: 5725 ~ 5850 MHz Bluetooth: 2402 MHz to 2480 MHz



	Band	Mode	Head (W/kg)	Body Worn and Hotspot(W/kg)
Max. Reported SAR(1g): (Limit:1.6W/kg)	PCE	GSM 850	0.471	0.343
	PCE	GSM 1900	0.794	0.704
	PCE	WCDMA Band II	0.286	0.779
	PCE	WCDMA Band IV	0.408	0.691
	PCE	WCDMA Band V	0.773	0.531
	PCE	LTE Band 2	0.150	0.407
	PCE	LTE Band 4	0.130	0.331
	PCE	LTE Band 5	0.271	0.293
	PCE	LTE Band 7	0.045	0.063
	PCE	LTE Band 12	0.169	0.403
	PCE	LTE Band 17	0.245	0.370
	PCE	LTE Band 66	0.115	0.296
	DTS	2.4G WLAN	0.589	0.248
	DSS	BT	0.032	0.042
	NII	5.3G WLAN	0.060	0.054
NII	5.6G WLAN	0.074	0.072	
NII	5.8G WLAN	0.063	0.055	
1-g Sum SAR			1.383	1.027
FCC Equipment Class	Licensed Portable Transmitter Held to Ear (PCE) Part 15 Spread Spectrum Transmitter (DSS) Digital Transmission System (DTS) Unlicensed National Information Infrastructure TX(NII)			
Operating Mode:	GSM: GSM Voice; GPRS/EGPRS Class 12 WCDMA: RMC, HSDPA, HSUPA Release 6 LTE: QPSK, 16QAM WLAN: 802.11 a/b/g/n20/n40 Bluetooth: GFSK +π/4DQPSK+8DPSK BLE: GFSK			
Antenna Specification:	GSM/WCDMA/LTE: PIFA Antenna Bluetooth: PIFA Antenna WLAN: PIFA Antenna			
SIM Card	Support dual-SIM, dual standby, the multiple SIM card with two lines cannot transmitting at the same time			
Hotspot Mode	Support			
DTM Mode	Not Support			
Note:	<p>1. The dual SIM card mobile has 2 SIM slots and supports dual SIM dual standby. The WWAN radio transmission will be enabled by either one SIM at a time (Single active)</p> <p>2. After pre-scan two SIM cards power, we found test result of the SIM1 was the worse, so we chose SIM1 card to perform all tests.</p> <p>3. The EUT battery must be fully charged and checked periodically during the test to ascertain uniform power</p>			



1.2 Test Environment

Ambient conditions in the SAR laboratory:

Items	Required
Temperature (°C)	18-25
Humidity (%RH)	30-70

1.3 Test Factory

ShenZhen STS Test Services Co.,Ltd.

A 1/F, Building B, Zhuoke Science Park, No.190 Chongqing Road, HepingShequ, Fuyong Sub-District, Bao'an District, Shenzhen, Guang Dong, China

FCC test Firm Registration No.: 625569

IC Registration No.: 12108A

A2LA Certificate No.: 4338.01





2. Test Standards and Limits

No.	Identity	Document Title
1	47 CFR Part 2	Frequency Allocations and Radio Treaty Matters; General Rules and Regulations
2	ANSI/IEEE Std. C95.1-1992	IEEE Standard for Safety Levels with Respect to Human Exposure to Radio Frequency Electromagnetic Fields, 3 kHz to 300 GHz
3	IEEE Std. 1528-2013	Recommended Practice for Determining the Peak Spatial-Average Specific Absorption Rate (SAR) in the Human Head from Wireless Communications Devices: Measurement Techniques
4	FCC KDB 447498 D04 v01	RF Exposure Procedures and Equipment Authorization Policies for Mobile and Portable Devices
5	FCC KDB 865664 D01 v01r04	SAR Measurement 100 MHz to 6 GHz
6	FCC KDB 865664 D02 v01r02	RF Exposure Reporting
7	FCC KDB 941225 D01 v03r01	SAR Measurement Procedures for 3G Devices
8	FCC KDB 941225 D05 v02r05	SAR for LTE Devices
9	FCC KDB 941225 D06 v02r01	Hotspot Mode SAR
10	FCC KDB 648474 D04 v01r03	SAR Evaluation Considerations for Wireless Handsets
11	FCC KDB 248227 D01 Wi-Fi SAR v02r02	SAR Considerations for 802.11 Devices

(A). Limits for Occupational/Controlled Exposure (W/kg)

Whole-Body	Partial-Body	Hands, Wrists, Feet and Ankles
0.4	8.0	20.0

(B). Limits for General Population/Uncontrolled Exposure (W/kg)

Whole-Body	Partial-Body	Hands, Wrists, Feet and Ankles
0.08	1.6	4.0

NOTE: Whole-Body SAR is averaged over the entire body, partial-body SAR is averaged over any 1 gram of tissue defined as a tissue volume in the shape of a cube. SAR for hands, wrists, feet and ankles is averaged over any 10 grams of tissue defined as a tissue volume in the shape of a cube.

Population/Uncontrolled Environments:

Are defined as locations where there is the exposure of individuals who have no knowledge or control of their exposure.

Occupational/Controlled Environments:

Are defined as locations where there is exposure that may be incurred by people who are aware of the potential for exposure, (i.e. as a result of employment or occupation).

<p>NOTE</p> <p>GENERAL POPULATION/UNCONTROLLED EXPOSURE</p> <p>PARTIAL BODY LIMIT</p> <p>1.6 W/kg</p>

3. SAR Measurement System

3.1 Definition of Specific Absorption Rate (SAR)

SAR is related to the rate at which energy is absorbed per unit mass in an object exposed to a radio field. The SAR distribution in a biological body is complicated and is usually carried out by experimental techniques or numerical modeling. The standard recommends limits for two tiers of groups, occupational/controlled and general population/uncontrolled, based on a person's awareness and ability to exercise control over his or her exposure. In general, occupational/controlled exposure limits are higher than the limits for general population/uncontrolled.

The SAR definition is the time derivative (rate) of the incremental energy (dW) absorbed by (dissipated in) an incremental mass (dm) contained in a volume element (dv) of a given density (ρ). The equation description is as below:

$$SAR = \frac{d}{dt} \left(\frac{dW}{dm} \right) = \frac{d}{dt} \left(\frac{dW}{\rho dv} \right)$$

SAR is expressed in units of Watts per kilogram (W/kg) SAR measurement can be related to the electrical field in the tissue by

$$SAR = \frac{\sigma E^2}{\rho}$$

Where: σ is the conductivity of the tissue,
ρ is the mass density of the tissue and E is the RMS electrical field strength.

3.2 SAR System

MVG SAR System Diagram:

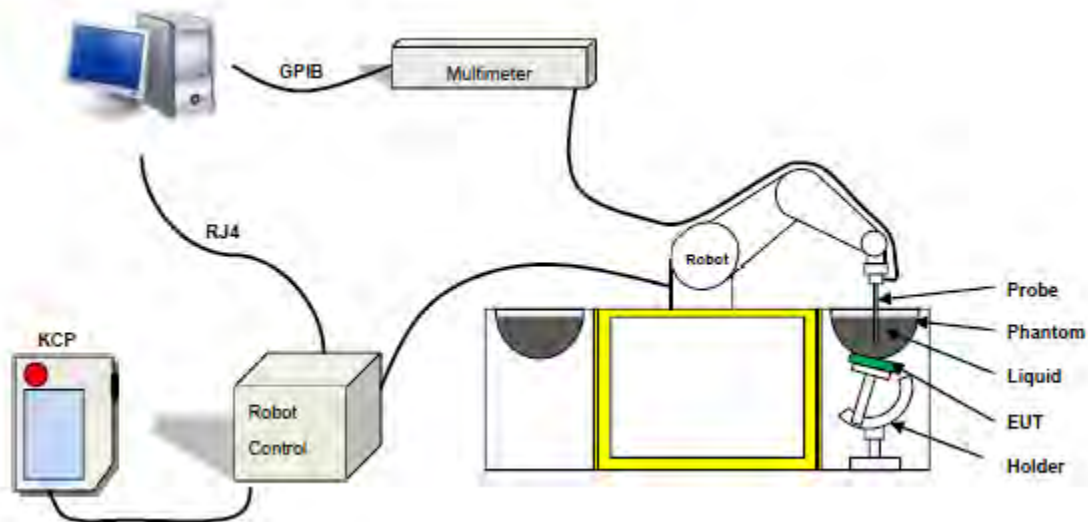

COMOSAR is a system that is able to determine the SAR distribution inside a phantom of human being according to different standards. The COMOSAR system consists of the following items:

- Main computer to control all the system
- 6 axis robot
- Data acquisition system
- Miniature E-field probe
- Phone holder
- Head simulating tissue

The following figure shows the system.



The EUT under test operating at the maximum power level is placed in the phone holder, under the phantom, which is filled with head simulating liquid. The E-Field probe measures the electric field inside the phantom. The Open SAR software computes the results to give a SAR value in a 1g or 10g mass.

3.2.1 Probe

For the measurements the Specific Dosimetric E-Field Probe SN 07/21 EPGO352 with following specifications is used

- Probe Length: 330 mm
- Length of Individual Dipoles: 2 mm
- Maximum external diameter: 8 mm
- Probe Tip External Diameter: 2.5 mm
- Distance between dipole/probe extremity: 1 mm
- Dynamic range: 0.01-100 W/kg
- Probe linearity: 3%
- Axial Isotropy: < 0.10 dB
- Spherical Isotropy: < 0.10 dB
- Calibration range: 150 MHz to 6 GHz for head & body simulating liquid.
- Angle between probe axis (evaluation axis) and surface normal line: less than 30°

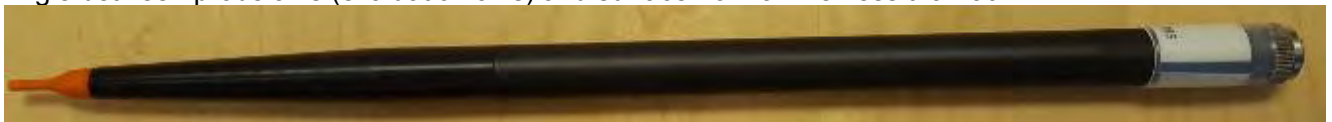

Figure 1-MVG COMOSAR Dosimetric E field Dipole

3.2.2 Phantom

For the measurements the Specific Anthropomorphic Mannequin (SAM) defined by the IEEE SCC-34/SC2 group is used. The phantom is a polyurethane shell integrated in a wooden table. The thickness of the phantom amounts to 2mm +/- 0.2mm. It enables the dosimetric evaluation of left and right phone usage and includes an additional flat phantom part for the simplified performance check. The phantom set-up includes a cover, which prevents the evaporation of the liquid.

SN 32/14 SAM115



SN 32/14 SAM116



3.2.3 Device Holder



The SAR in the phantom is approximately inversely proportional to the square of the distance between the source and the liquid surface. For a source at 5 mm distance, a positioning uncertainty of ± 0.5 mm would produce a SAR uncertainty of ± 20 %. Accurate device positioning is therefore crucial for accurate and repeatable measurements. The positions in which the devices must be measured are defined by the standards.

4. Tissue Simulating Liquids



4. Tissue Simulating Liquids

4.1 Simulating Liquids Parameter Check

The head tissue dielectric parameters recommended by the IEEE SCC-34/SC-2 in P1528 have been incorporated in the following table. These head parameters are derived from planar layer models simulating the highest expected SAR for the dielectric properties and tissue thickness variations in a human head. Other head and body tissue parameters that have not been specified in P1528 are derived from the tissue dielectric parameters computed from the 4-Cole-Cole equations described in Reference [12] and extrapolated according to the head parameters specified in P1528.

Head Tissue

Frequency (MHz)	cellulose	DGBE	HEC	NaCl	Preventol	Sugar	X100	Water	Conductivity	Permittivity
	%	%	%	%	%	%	%	%	σ	ϵ_r
750	0.2	/	/	1.4	0.2	57.0	/	41.1	0.89	41.9
835	0.2	/	/	1.4	0.2	57.9	/	40.3	0.90	41.5
900	0.2	/	/	1.4	0.2	57.9	/	40.3	0.97	41.5
1800	/	44.5	/	0.3	/	/	30.45	55.2	1.4	40.0
1900	/	44.5	/	0.3	/	/	30.45	55.2	1.4	40.0
2000	/	44.5	/	0.3	/	/	/	55.2	1.4	40.0
2450	/	44.9	/	0.1	/	/	/	55.0	1.80	39.2
2600	/	45.0	/	0.1	/	/	/	54.9	1.96	39.0

Body Tissue

Frequency (MHz)	cellulose	DGBE	HEC	NaCl	Preventol	Sugar	X100	Water	Conductivity	Permittivity
	%	%	%	%	%	%	%	%	σ	ϵ_r
750	0.2	/	/	0.9	0.1	47.2	/	51.7	0.96	55.5
835	0.2	/	/	0.9	0.1	48.2	/	50.8	0.97	55.2
900	0.2	/	/	0.9	0.1	48.2	/	50.8	1.05	55.0
1800	/	29.4	/	0.4	/	/	30.45	70.2	1.52	53.3
1900	/	29.4	/	0.4	/	/	30.45	70.2	1.52	53.3
2000	/	29.4	/	0.4	/	/	/	70.2	1.52	53.3
2450	/	31.3	/	0.1	/	/	/	68.6	1.95	52.7
2600	/	31.7	/	0.1	/	/	/	68.2	2.16	52.3

Tissue dielectric parameters for head and body phantoms				
Frequency	ϵ_r		σ S/m	
	Head	Body	Head	Body
	300	45.3	58.2	0.87
450	43.5	56.7	0.87	0.94
900	41.5	55.0	0.97	1.05
1450	40.5	54.0	1.20	1.30
1800	40.0	53.3	1.40	1.52
2450	39.2	52.7	1.80	1.95
3000	38.5	52.0	2.40	2.73
5800	35.3	48.2	5.27	6.00



LIQUID MEASUREMENT RESULTS

Date	Ambient		Simulating Liquid		Parameters	Target	Measured	Deviation %	Limited %
	Temp. [°C]	Humidity %	Frequency	Temp. [°C]					
2022/2/15	20.2	51	704 MHz	19.9	Permittivity	42.11	42.98	2.07	±5
					Conductivity	0.89	0.91	2.25	±5
2022/2/15	21.0	55	709 MHz	20.7	Permittivity	42.11	40.39	-4.08	±5
					Conductivity	0.89	0.89	0.00	±5
2022/2/15	21.9	40	710 MHz	21.6	Permittivity	42.11	42.00	-0.26	±5
					Conductivity	0.89	0.90	1.12	±5
2022/2/15	20.6	55	750 MHz	20.3	Permittivity	41.9	42.77	2.08	±5
					Conductivity	0.89	0.95	6.74	±5
2022/2/16	23.1	53	824.2 MHz	22.7	Permittivity	41.55	42.50	2.29	±5
					Conductivity	0.9	0.84	-6.67	±5
2022/2/16	22.8	56	826.4 MHz	22.5	Permittivity	41.54	42.66	2.70	±5
					Conductivity	0.9	0.86	-4.44	±5
2022/2/16	22.4	56	835 MHz	22.1	Permittivity	41.5	40.85	-1.57	±5
					Conductivity	0.9	0.93	3.33	±5
2022/2/16	23.1	46	836.5 MHz	22.9	Permittivity	41.5	43.18	4.05	±5
					Conductivity	0.9	0.90	0.00	±5
2022/2/16	22.6	56	836.6 MHz	22.3	Permittivity	41.5	40.48	-2.46	±5
					Conductivity	0.9	0.93	3.33	±5
2022/2/16	20.2	58	846.6 MHz	19.9	Permittivity	41.5	42.89	3.35	±5
					Conductivity	0.91	0.90	-1.10	±5
2022/2/18	22.3	49	1720 MHz	22.0	Permittivity	40.11	40.40	0.72	±5
					Conductivity	1.35	1.37	1.48	±5
2022/2/18	22.5	59	1745 MHz	22.3	Permittivity	40.08	41.25	2.92	±5
					Conductivity	1.37	1.30	-5.11	±5
2022/2/18	20.7	49	1752.4 MHz	20.5	Permittivity	40.07	40.74	1.67	±5
					Conductivity	1.37	1.39	1.46	±5
2022/2/18	20.2	53	1800 MHz	19.9	Permittivity	40	40.04	0.10	±5
					Conductivity	1.4	1.41	0.71	±5
2022/2/21	22.2	44	1852.4 MHz	21.9	Permittivity	40	40.17	0.43	±5
					Conductivity	1.4	1.39	-0.71	±5
2022/2/21	23.1	51	1860 MHz	22.7	Permittivity	40	40.23	0.57	±5
					Conductivity	1.4	1.40	0.00	±5



2022/2/21	21.4	57	1880 MHz	21.1	Permittivity	40	40.51	1.28	±5
					Conductivity	1.4	1.46	4.29	±5
2022/2/21	23.4	46	1900 MHz	23.1	Permittivity	40	41.06	2.65	±5
					Conductivity	1.4	1.37	-2.14	±5
2022/2/21	20.5	47	1907.6 MHz	20.2	Permittivity	40	38.85	-2.88	±5
					Conductivity	1.4	1.42	1.43	±5
2022/2/23	20.1	41	2402 MHz	19.8	Permittivity	39.27	39.23	-0.10	±5
					Conductivity	1.77	1.81	2.26	±5
2022/2/23	21.8	44	2437 MHz	21.5	Permittivity	39.26	38.60	-1.68	±5
					Conductivity	1.77	1.75	-1.13	±5
2022/2/23	21.4	45	2450 MHz	21.2	Permittivity	39.2	39.38	0.46	±5
					Conductivity	1.8	1.83	1.67	±5
2022/2/23	23.3	48	2560 MHz	23.0	Permittivity	39.05	39.41	0.92	±5
					Conductivity	1.92	1.92	0.00	±5
2022/2/23	21.8	53	2600 MHz	21.5	Permittivity	39	38.31	-1.77	±5
					Conductivity	1.96	1.89	-3.57	±5
2022/3/02	21.8	58	5300 MHz	21.5	Permittivity	35.9	35.06	-2.34	±5
					Conductivity	4.76	4.70	-1.26	±5
2022/3/02	21.7	41	5510 MHz	21.4	Permittivity	35.68	36.63	2.66	±5
					Conductivity	4.96	5.00	0.81	±5
2022/3/02	20.5	50	5500 MHz	20.2	Permittivity	35.68	36.80	3.14	±5
					Conductivity	4.96	4.96	0.00	±5
2022/3/02	20.2	52	5600 MHz	19.9	Permittivity	35.55	36.08	1.49	±5
					Conductivity	5.07	5.04	-0.59	±5
2022/3/02	22.4	52	5785MHz	22.1	Permittivity	35.32	34.50	-2.32	±5
					Conductivity	5.25	5.23	-0.38	±5
2022/3/02	21.0	41	5800MHz	20.7	Permittivity	35.3	36.37	3.03	±5
					Conductivity	5.27	5.31	0.76	±5

5. SAR System Validation

5.1 Validation System

Each MVG system is equipped with one or more system validation kits. These units, together with the predefined measurement procedures within the MVG software, enable the user to conduct the system performance check and system validation. System kit includes a dipole, and dipole device holder.

The system check verifies that the system operates within its specifications. It's performed daily or before every SAR measurement. The system check uses normal SAR measurement in the flat section of the phantom with a matched dipole at a specified distance. The system validation setup is shown as below.

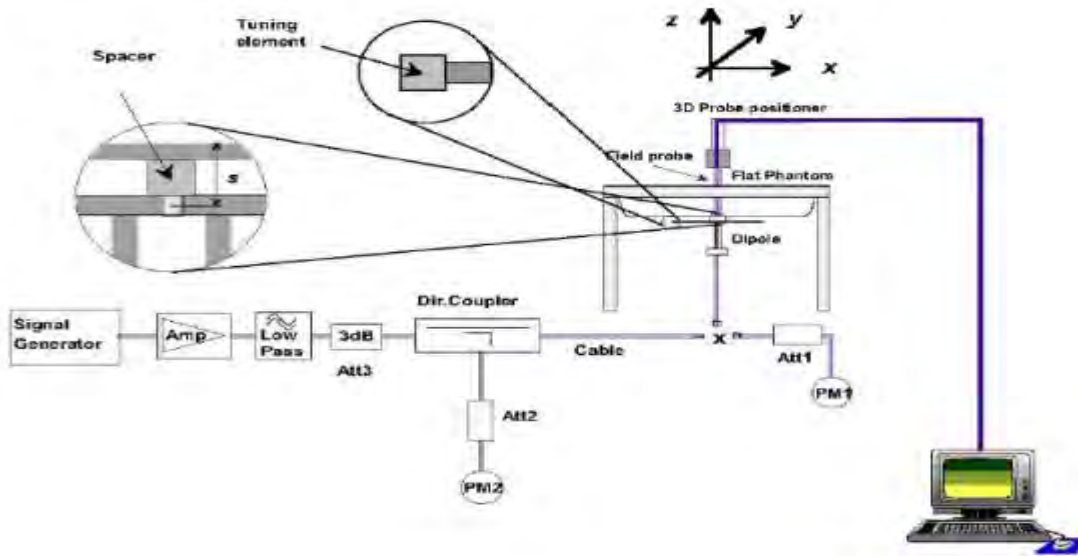

5.2 Validation Result

Comparing to the original SAR value provided by MVG, the validation data should be within its specification of 10 %.

Date	Freq.	Power	Tested Value	Normalized SAR	Target SAR	Tolerance	Limit
	(MHz)	(mW)	(W/Kg)	(W/kg)	1g(W/kg)	(%)	(%)
2022/2/15	750	100	0.832	8.32	8.49	-2.00	10
2022/2/16	835	100	0.946	9.46	9.56	-1.05	10
2022/2/18	1800	100	3.816	38.16	38.40	-0.63	10
2022/2/21	1900	100	3.954	39.54	39.70	-0.40	10
2022/2/23	2450	100	5.261	52.61	52.40	0.40	10
2022/2/23	2600	100	5.512	55.12	55.30	-0.33	10
2022/3/02	5300	100	16.654	166.54	166.40	0.08	10
2022/3/02	5600	100	17.343	173.43	173.80	-0.21	10
2022/3/02	5800	100	18.079	180.79	181.20	-0.23	10

Note:

1. The tolerance limit of System validation $\pm 10\%$.
2. The dipole input power (forward power) was 100 mW.
3. The results are normalized to 1 W input power.



6. SAR Evaluation Procedures

The procedure for assessing the average SAR value consists of the following steps:

The following steps are used for each test position

- Establish a call with the maximum output power with a base station simulator. The connection between the mobile and the base station simulator is established via air interface
- Measurement of the local E-field value at a fixed location. This value serves as a reference value for calculating a possible power drift.
- Measurement of the SAR distribution with a grid of 8 to 16mm * 8 to 16 mm and a constant distance to the inner surface of the phantom. Since the sensors cannot directly measure at the inner phantom surface, the values between the sensors and the inner phantom surface are extrapolated. With these values the area of the maximum SAR is calculated by an interpolation scheme.
- Around this point, a cube of 30 * 30 * 30 mm or 32 * 32 * 32 mm is assessed by measuring 5 or 8 * 5 or 8*4 or 5 mm. With these data, the peak spatial-average SAR value can be calculated.

➤ Area Scan & Zoom Scan



First Area Scan is used to locate the approximate location(s) of the local peak SAR value(s). The measurement grid within an Area Scan is defined by the grid extent, grid step size and grid offset. Next, in order to determine the EM field distribution in a three-dimensional spatial extension, Zoom Scan is required. The Zoom Scan is performed around the highest E-field value to determine the averaged SAR-distribution over 10 g. Area scan and zoom scan resolution setting follows KDB 865664 D01 quoted below. When the 1-g SAR of the highest peak is within 2 dB of the SAR limit, additional zoom scans are required for other peaks within 2 dB of the highest peak that have not been included in any zoom scan to ensure there is no increase in SAR.

7. EUT Antenna Location Sketch

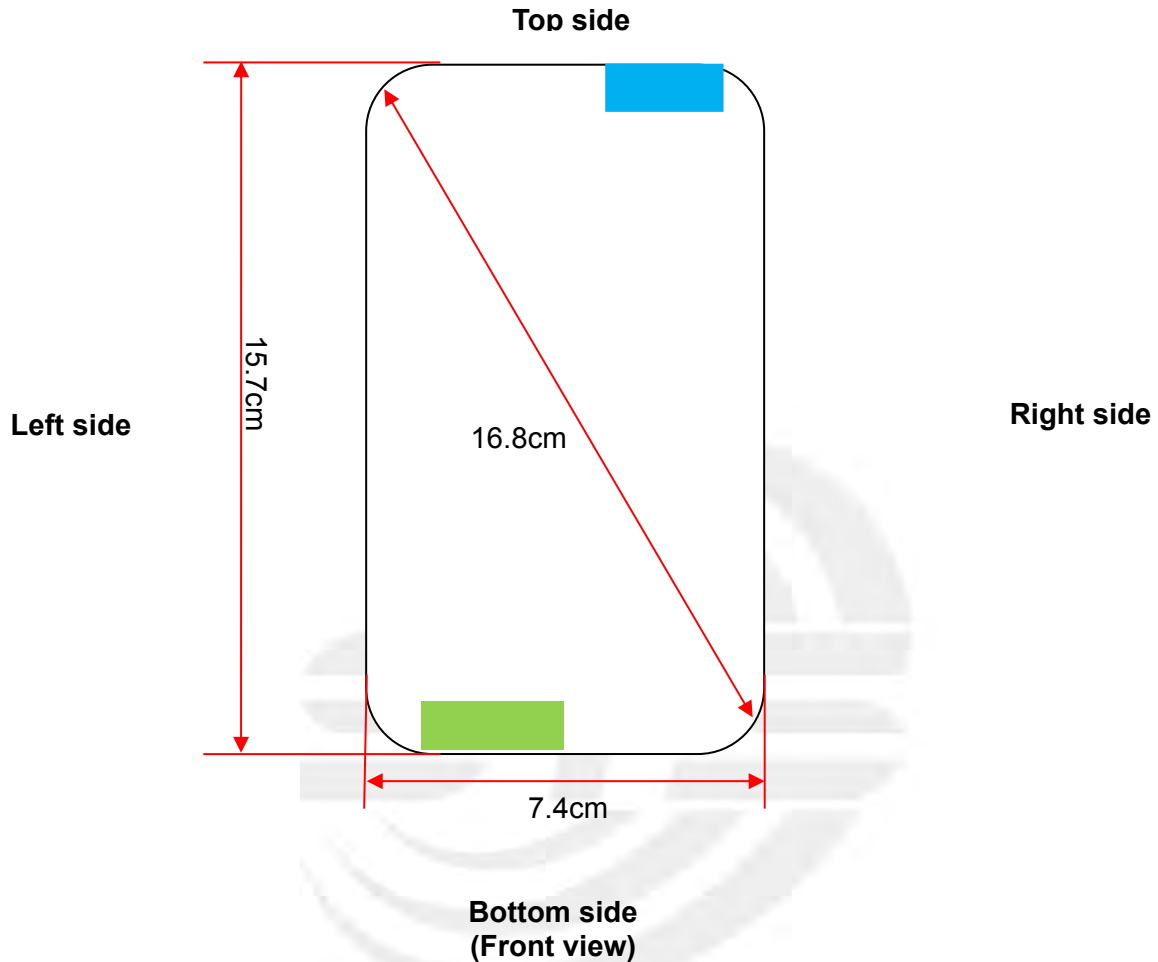
It is a Mobile Phone, support GSM/WCDMA/LTE/WLAN/BT mode.



Antenna Separation Distance(cm)						
ANT	Back Side	Front Side	Left Side	Right Side	Top Side	Bottom Side
WLAN/BT	≤0.5	≤0.5	5.5	0.9	≤0.5	14.9
WWAN	≤0.5	≤0.5	≤0.5	1.4	13.8	≤0.5

-  WLAN/BT Antenna
-  WWAN Antenna

Note 1: The antenna information refer the manufacturer provide report, applicable only to the tested sample identified in the report.



7.1 SAR test exclusion consider table

The WWAN/WLAN/BT SAR evaluation of Maximum power (dBm) summing tolerance.

Exposure Position	Wireless Interface	GSM850	PCS1900	WCDMA 2	WCDMA 4
	Calculated Frequency(GHz)	0.8242	1.88	1.8524	1.7524
	Maximum Turn-up power (dBm)	29.5	28	22	23.5
	Maximum rated power(mW)	891.25	630.96	158.49	223.87
Back Side	Separation distance (cm)	≤0.5	≤0.5	≤0.5	≤0.5
	exclusion threshold(mW)	9.42	3.39	3.43	3.59
	Testing required?	YES	YES	YES	YES
Front Side	Separation distance (cm)	≤0.5	≤0.5	≤0.5	≤0.5
	exclusion threshold(mW)	9.42	3.39	3.43	3.59
	Testing required?	YES	YES	YES	YES
Left Side	Separation distance (cm)	≤0.5	≤0.5	≤0.5	≤0.5
	exclusion threshold(mW)	9.42	3.39	3.43	3.59
	Testing required?	YES	YES	YES	YES
Right Side	Separation distance (cm)	1.4	1.4	1.4	1.4
	exclusion threshold(mW)	40.03	22.66	22.86	23.60
	Testing required?	YES	YES	YES	YES
Top Side	Separation distance (cm)	13.8	13.8	13.8	13.8
	exclusion threshold(mW)	998.07	1543.31	1545.16	1552.08
	Testing required?	NO	NO	NO	NO
Bottom Side	Separation distance (cm)	≤0.5	≤0.5	≤0.5	≤0.5
	exclusion threshold(mW)	9.42	3.39	3.43	3.59
	Testing required?	YES	YES	YES	YES



Exposure Position	Wireless Interface	WCDMA 5	LTE Band 2	LTE Band 4	LTE Band 5
	Calculated Frequency(GHz)	0.8366	1.86	1.72	0.829
	Maximum Turn-up power (dBm)	23	21.5	22.5	23.5
	Maximum rated power(mW)	199.53	141.25	177.83	223.87
Back Side	Separation distance (cm)	≤0.5	≤0.5	≤0.5	≤0.5
	exclusion threshold(mW)	9.22	3.42	3.64	9.34
	Testing required?	YES	YES	YES	YES
Front Side	Separation distance (cm)	≤0.5	≤0.5	≤0.5	≤0.5
	exclusion threshold(mW)	9.22	3.42	3.64	9.34
	Testing required?	YES	YES	YES	YES
Left Side	Separation distance (cm)	≤0.5	≤0.5	≤0.5	≤0.5
	exclusion threshold(mW)	9.22	3.42	3.64	9.34
	Testing required?	YES	YES	YES	YES
Right Side	Separation distance (cm)	1.4	1.4	1.4	1.4
	exclusion threshold(mW)	39.60	22.80	23.86	39.86
	Testing required?	YES	YES	YES	YES
Top Side	Separation distance (cm)	13.8	13.8	13.8	13.8
	exclusion threshold(mW)	1009.43	1544.65	1554.42	1002.47
	Testing required?	NO	NO	NO	NO
Bottom Side	Separation distance (cm)	≤0.5	≤0.5	≤0.5	≤0.5
	exclusion threshold(mW)	9.22	3.42	3.64	9.34
	Testing required?	YES	YES	YES	YES



Exposure Position	Wireless Interface	LTE Band 7	LTE Band 12	LTE Band 17	LTE Band 66
		Calculated Frequency(GHz)	2.56	0.704	0.71
	Maximum Turn-up power (dBm)	21	22.5	20.4	22.5
	Maximum rated power(mW)	125.89	177.83	109.65	177.83
Back Side	Separation distance (cm)	≤0.5	≤0.5	≤0.5	≤0.5
	exclusion threshold(mW)	2.65	11.75	11.61	3.64
	Testing required?	YES	YES	YES	YES
Front Side	Separation distance (cm)	≤0.5	≤0.5	≤0.5	≤0.5
	exclusion threshold(mW)	2.65	11.75	11.61	3.64
	Testing required?	YES	YES	YES	YES
Left Side	Separation distance (cm)	≤0.5	≤0.5	≤0.5	≤0.5
	exclusion threshold(mW)	2.65	11.75	11.61	3.64
	Testing required?	YES	YES	YES	YES
Right Side	Separation distance (cm)	1.4	1.4	1.4	1.4
	exclusion threshold(mW)	18.96	44.93	44.65	23.86
	Testing required?	YES	YES	YES	YES
Top Side	Separation distance (cm)	13.8	13.8	13.8	13.8
	exclusion threshold(mW)	1505.40	885.62	891.34	1554.42
	Testing required?	NO	NO	NO	NO
Bottom Side	Separation distance (cm)	≤0.5	≤0.5	≤0.5	≤0.5
	exclusion threshold(mW)	2.65	11.75	11.61	3.64
	Testing required?	YES	YES	YES	YES



Exposure Position	Wireless Interface	BT	2.4G WLAN	5.2G WLAN
	Calculated Frequency(GHz)	2.402	2437	5.18
	Maximum Turn-up power (dBm)	8	19	10.5
	Maximum rated power(mW)	6.31	79.43	11.22
Back Side	Separation distance (cm)	≤0.5	≤0.5	≤0.5
	exclusion threshold(mW)	2.79	0.01	1.51
	Testing required?	YES	YES	YES
Front Side	Separation distance (cm)	≤0.5	≤0.5	≤0.5
	exclusion threshold(mW)	2.79	0.01	1.51
	Testing required?	YES	YES	YES
Left Side	Separation distance (cm)	5.5	5.5	5.5
	exclusion threshold(mW)	264.03	37.92	212.86
	Testing required?	NO	YES	NO
Right Side	Separation distance (cm)	0.9	0.9	0.9
	exclusion threshold(mW)	8.51	0.08	5.07
	Testing required?	NO	YES	YES
Top Side	Separation distance (cm)	≤0.5	≤0.5	≤0.5
	exclusion threshold(mW)	2.79	0.01	1.51
	Testing required?	YES	YES	YES
Bottom Side	Separation distance (cm)	14.9	14.9	14.9
	exclusion threshold(mW)	1750.22	1124.41	1666.32
	Testing required?	NO	NO	NO



Exposure Position	Wireless Interface	5.3G WLAN	5.6G WLAN	5.8G WLAN
	Calculated Frequency(GHz)	5.3	5.51	5.785
	Maximum Turn-up power (dBm)	11	10	9
	Maximum rated power(mW)	12.59	10.00	7.94
Back Side	Separation distance (cm)	≤0.5	≤0.5	≤0.5
	exclusion threshold(mW)	1.48	1.43	1.38
	Testing required?	YES	YES	YES
Front Side	Separation distance (cm)	≤0.5	≤0.5	≤0.5
	exclusion threshold(mW)	1.48	1.43	1.38
	Testing required?	YES	YES	YES
Left Side	Separation distance (cm)	5.5	5.5	5.5
	exclusion threshold(mW)	211.50	209.21	206.37
	Testing required?	NO	NO	NO
Right Side	Separation distance (cm)	0.9	0.9	0.9
	exclusion threshold(mW)	4.99	4.86	4.71
	Testing required?	YES	YES	YES
Top Side	Separation distance (cm)	≤0.5	≤0.5	≤0.5
	exclusion threshold(mW)	1.48	1.43	1.38
	Testing required?	YES	YES	YES
Bottom Side	Separation distance (cm)	14.9	14.9	14.9
	exclusion threshold(mW)	1663.88	1659.75	1654.59
	Testing required?	NO	NO	NO

Note:

1. maximum power is the source-based time-average power and represents the maximum RF output power among production units.
2. Per KDB 447498 D04, for larger devices, the test separation distance of adjacent Side configuration is determined by the closest separation between the antenna and the user.
3. Per KDB 447498 D04, if the maximum time-averaged power available does not exceed 1 mW. This stand-alone SAR exemption test.



4. Per KDB 447498 D04, the available maximum time-averaged power or effective radiated power (ERP), whichever is greater, is less than or equal to the threshold P_{th} (mW) described in the following formula. This method shall only be used at separation distances (cm) from 0.5 centimeters to 40 centimeters and at frequencies from 0.3 GHz to 6 GHz (inclusive). P_{th} is given by:

$$P_{th} \text{ (mW)} = \begin{cases} ERP_{20 \text{ cm}} (d/20 \text{ cm})^x & d \leq 20 \text{ cm} \\ ERP_{20 \text{ cm}} & 20 \text{ cm} < d \leq 40 \text{ cm} \end{cases}$$

Where

$$x = -\log_{10} \left(\frac{60}{ERP_{20 \text{ cm}} \sqrt{f}} \right) \text{ and } f \text{ is in GHz;}$$

and

$$ERP_{20 \text{ cm}} \text{ (mW)} = \begin{cases} 2040f & 0.3 \text{ GHz} \leq f < 1.5 \text{ GHz} \\ 3060 & 1.5 \text{ GHz} \leq f \leq 6 \text{ GHz} \end{cases}$$

d = the separation distance (cm);

5. Per KDB 447498 D04, An alternative to the SAR-based exemption is using below table and the minimum separation distance (R in meters) from the body of a nearby person for the frequency (f in MHz) at which the source operates, the ERP (watts) is no more than the calculated value prescribed for that frequency. For the exemption in below table to apply, R must be at least $\lambda/2\pi$, where λ is the free-space operating wavelength in meters. If the ERP of a single RF source is not easily obtained, then the available maximum time-averaged power may be used in lieu of ERP if the physical dimensions of the radiating structure(s) do not exceed the electrical length of $\lambda/4$ or if the antenna gain is less than that of a half-wave dipole (1.64 linear value).

RF Source frequency (MHz)	Threshold ERP(watts)
0.3-1.34	1,920 R ² .
1.34-30	3,450 R ² /f ² .
30-300	3.83 R ² .
300-1,500	0.0128 R ² f.
1,500-100,000	19.2R ² .



6. Per KDB 248227 D01, choose the highest output power channel to test SAR and determine further SAR exclusion 8. for each frequency band, testing at higher data rates and higher order modulations is not required when the maximum average output power for each of each of these configurations is less than 1/4db higher than those measured at the lower data rate than 11b mode, thus the SAR can be excluded.
7. Per KDB 616217 D04, SAR evaluation for the front surface of tablet display screens are generally not necessary.
8. Per KDB 248227, as maximum rated power for U-NII-2A > U-NII-1, U-NII-2A was chosen for SAR evaluation. Based on the measurements obtained, SAR measurements on U-NII-1 are not required as highest reported SAR from U-NII-2A band is $\leq 1.2\text{W/Kg}$.



8. EUT Test Position

This EUT was tested in Right Cheek, Right Titled, Left Cheek, Left Titled, Front Face and Rear Face.

8.1 Define Two Imaginary Lines on the Handset

(1) The vertical centerline passes through two points on the front side of the handset: the midpoint of the width w_t of the handset at the level of the acoustic output, and the midpoint of the width w_b of the handset.
 (2) The horizontal line is perpendicular to the vertical centerline and passes through the center of the acoustic output. The horizontal line is also tangential to the face of the handset at point A.
 (3) The two lines intersect at point A. Note that for many handsets, point A coincides with the center of the acoustic output; however, the acoustic output may be located elsewhere on the horizontal line. Also note that the vertical centerline is not necessarily to the front face of the handset, especially for clamshell handsets, handsets with flip covers, and other irregularly shaped handsets.

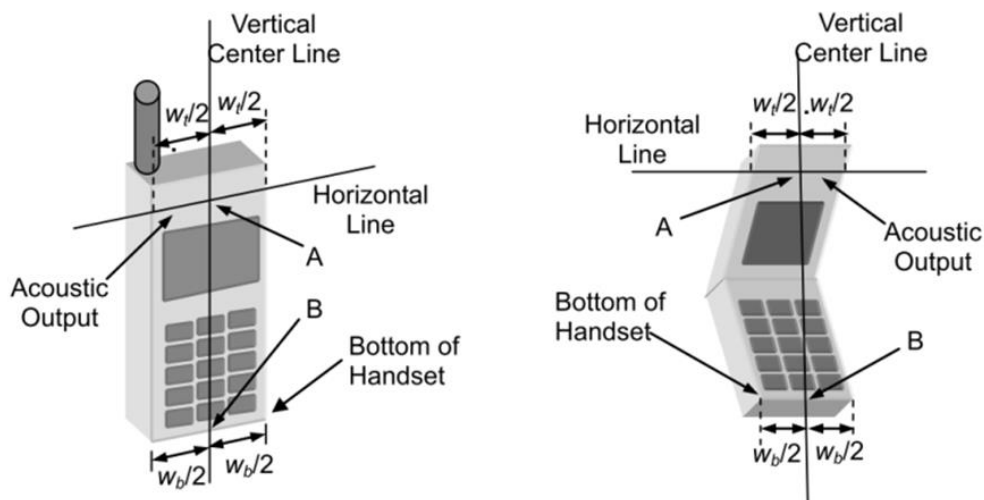

Cheek Position

1) To position the device with the vertical center line of the body of the device and the horizontal line crossing the center piece in a plane parallel to the sagittal plane of the phantom. While maintaining the device in this plane, align the vertical center line with the reference plane containing the ear and mouth reference point (M: Mouth, RE: Right Ear, and LE: Left Ear) and align the center of the ear piece with the line RE-LE.

2) To move the device towards the phantom with the ear piece aligned with the line LE-RE until the phone touched the ear. While maintaining the device in the reference plane and maintaining the phone contact with ear, move the bottom of the phone until any point on the front side is in contact with the cheek of the phantom or until contact with the ear is lost

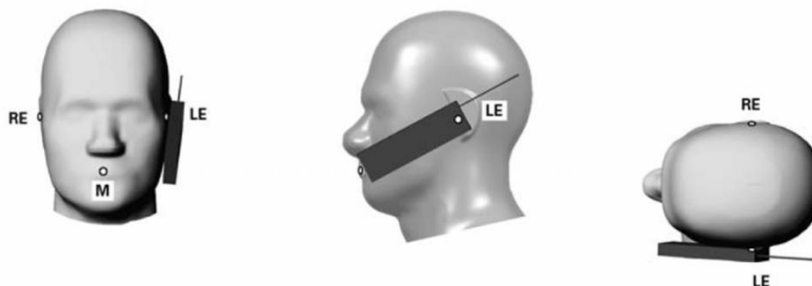

Title Position

- (1) To position the device in the “cheek” position described above.
- (2) While maintaining the device in the reference plane described above and pivoting against the ear, moves it outward away from the mouth by an angle of 15 degrees or until with the ear is lost.

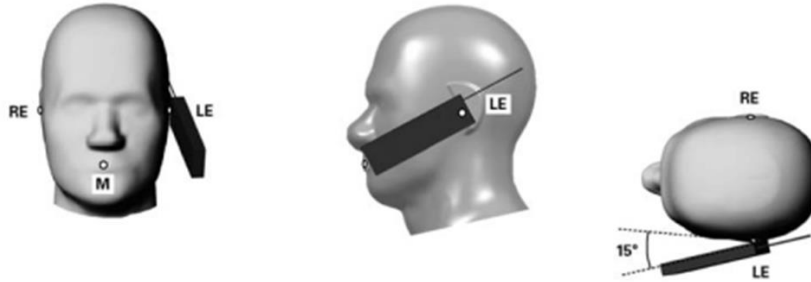

Body-worn Position Conditions:

Body-worn accessory exposure is typically related to voice mode operations when handsets are carried in body-worn accessories. The body-worn accessory procedures in KDB Publication 447498 D01 should be used to test for body-worn accessory SAR compliance, without a headset connected to it. When the same wireless transmission configuration is used for testing body-worn accessory and hotspot mode SAR, respectively, in voice and data mode, SAR results for the most conservative *test separation distance* configuration may be used to support both SAR conditions. When the *reported SAR* for a body-worn accessory, measured without a headset connected to the handset, is > 1.2 W/kg, the highest *reported SAR* configuration for that wireless mode and frequency band should be repeated for the body-worn accessory with a headset attached to the handset.

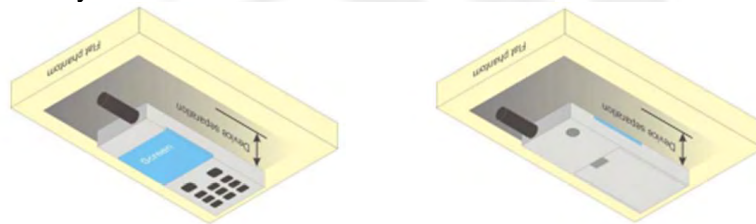

8.2 Hotspot mode exposure position condition

For handsets that support hotspot mode operations, with wireless router capabilities and various web browsing function, the relevant hand and body exposure condition are tested according to the hotspot SAR procedures in KDB 941225. A test separation distance of 10 mm is required between the phantom and all surface and Sides with a transmitting antenna located within 25 mm from that surface or Side. When form factor of a handset is smaller than 9cm x 5cm, a test separation distance of 5mm (instead of 10mm) is required for testing hotspot mode. When the separate distance required for body-worn accessory testing is larger than or equal to that tested for hotspot mode, in the same wireless mode and for the same surface of the phone, the hotspot mode SAR data may be used to support body-worn accessory SAR compliance for that particular configuration (surface).

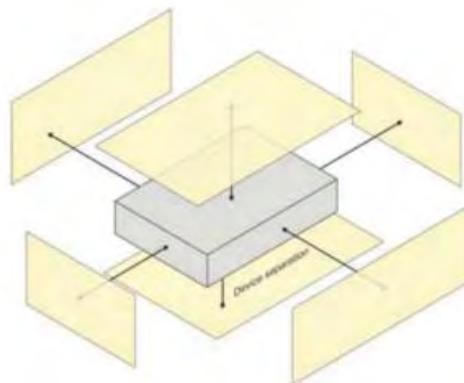



9. Uncertainty

9.1 Measurement Uncertainty

The following measurement uncertainty levels have been estimated for tests performed on the EUT as specified in IEEE 1528: 2013. This uncertainty represents an expanded uncertainty expressed at approximately the 95% confidence level using a coverage factor of k=2.

Uncertainty Component	Tol (+-%)	Prob. Dist.	Div.	Ci (1g)	Ci (10g)	1g Ui (+-%)	10g Ui (+-%)	vi
Measurement System								
Probe calibration	5.86	N	1	1	1	5.86	5.86	∞
Axial Isotropy	0.16	R	$\sqrt{3}$	$\sqrt{0.5}$	$\sqrt{0.5}$	0.07	0.07	∞
Hemispherical Isotropy	1.06	R	$\sqrt{3}$	$\sqrt{0.5}$	$\sqrt{0.5}$	0.43	0.43	∞
Boundary effect	1	R	$\sqrt{3}$	1	1	0.58	0.58	∞
Linearity	1.27	R	$\sqrt{3}$	1	1	0.73	0.73	∞
System detection limits	1.23	R	$\sqrt{3}$	1	1	0.71	0.71	∞
Modulation response	3.6	R	$\sqrt{3}$	1	1	3.60	3.60	∞
Readout Electronics	0.28	N	1	1	1	0.28	0.28	∞
Response Time	0.19	R	$\sqrt{3}$	1	1	0.11	0.11	∞
Integration Time	1.47	R	$\sqrt{3}$	1	1	0.85	0.85	∞
RF ambient conditions-Noise	3.5	R	$\sqrt{3}$	1	1	2.02	2.02	∞
RF ambient conditions-reflections	3.2	R	$\sqrt{3}$	1	1	1.85	1.85	∞
Probe positioner mechanical tolerance	1.4	R	$\sqrt{3}$	1	1	0.81	0.81	∞
Probe positioning with respect to phantom shell	1.4	R	$\sqrt{3}$	1	1	0.81	0.81	∞
Post-processing	2.3	R	$\sqrt{3}$	1	1	1.33	1.33	∞
Test sample Related								
Test sample positioning	3.1	N	1	1	1	3.10	3.10	∞
Device holder uncertainty	3.8	N	1	1	1	3.80	3.80	∞
SAR drift measurement	4.8	R	$\sqrt{3}$	1	1	2.77	2.77	∞
SAR scaling	2	R	$\sqrt{3}$	1	1	1.15	1.15	∞
Phantom and tissue parameters								
Phantom uncertainty (shape and thickness uncertainty)	4	R	$\sqrt{3}$	1	1	2.31	2.31	∞
Uncertainty in SAR correction for deviations in permittivity and conductivity	2	N	1	1	0.84	2.00	1.68	∞
Liquid conductivity (temperature uncertainty)	2.5	R	$\sqrt{3}$	0.78	0.71	1.95	1.78	∞
Liquid conductivity (measured)	4	N	1	0.78	0.71	0.92	1.04	M
Liquid permittivity (temperature uncertainty)	2.5	R	$\sqrt{3}$	0.23	0.26	1.95	1.78	∞
Liquid permittivity (measured)	5	N	1	0.23	0.26	1.15	1.30	M
Combined Standard Uncertainty		RSS				10.60	10.51	
Expanded Uncertainty (95% Confidence interval)		K=2				21.21	21.03	



10. Conducted Power Measurement

10.1 Test Result

Burst Average Power (dBm)						
Band	GSM 850			PCS 1900		
Channel	128	190	251	512	661	810
Frequency (MHz)	824.2	836.6	848.8	1850.2	1880.0	1909.8
GSM(GMSK, 1-Slot)	30.79	30.75	30.71	28.78	28.85	28.63
GPRS (GMSK, 1-Slot)	30.48	30.46	30.55	28.72	28.81	28.60
GPRS (GMSK, 2-Slot)	30.01	30.04	30.12	28.27	28.38	28.17
GPRS (GMSK, 3-Slot)	29.59	29.56	29.63	27.81	27.95	27.68
GPRS (GMSK, 4-Slot)	29.19	29.14	29.13	27.37	27.53	27.27
EGPRS(8PSK, 1-Slot)	26.36	26.47	26.53	27.60	27.50	27.00
EGPRS(8PSK, 2-Slot)	25.60	25.68	25.81	26.82	26.73	26.25
EGPRS(8PSK, 3-Slot)	24.80	24.95	25.10	26.11	25.98	25.52
EGPRS(8PSK, 4-Slot)	24.09	24.19	24.35	25.40	25.24	24.76

Remark: GPRS, CS4 coding scheme. EGPRS, MCS5 coding scheme.
 Multi-Slot Class 8, Support Max 4 downlink, 1 uplink, 5 working link
 Multi-Slot Class 10, Support Max 4 downlink, 2 uplink, 5 working link
 Multi-Slot Class 12, Support Max 4 downlink, 4 uplink, 5 working link

Frame- Average Power(dBm)						
Band	GSM 850			PCS 1900		
Channel	128	190	251	512	661	810
Frequency (MHz)	824.2	836.6	848.8	1850.2	1880.0	1909.8
GSM(GMSK, 1-Slot)	21.76	21.72	21.68	19.75	19.82	19.60
GPRS (GMSK, 1-Slot)	21.45	21.43	21.52	19.69	19.78	19.57
GPRS (GMSK, 2-Slot)	23.99	24.02	24.10	22.25	22.36	22.15
GPRS (GMSK, 3-Slot)	25.33	25.30	25.37	23.55	23.69	23.42
GPRS (GMSK, 4-Slot)	26.18	26.13	26.12	24.36	24.52	24.26
EGPRS(8PSK, 1-Slot)	17.33	17.44	17.50	18.57	18.47	17.97
EGPRS(8PSK, 2-Slot)	19.58	19.66	19.79	20.80	20.71	20.23
EGPRS(8PSK, 3-Slot)	20.54	20.69	20.84	21.85	21.72	21.26
EGPRS(8PSK, 4-Slot)	21.08	21.18	21.34	22.39	22.23	21.75

Remark :

- SAR testing was performed on the maximum frame-averaged power mode.
- The frame-averaged power is linearly proportion to the slot number configured and it is linearly scaled the maximum

Burst - averaged power based on time slots. The calculated method is shown as below:
 Frame-averaged power = Burst averaged power (1 TX Slot) – 9.03 dB
 Frame-averaged power = Burst averaged power (2 TX Slots) – 6.02 dB
 Frame-averaged power = Burst averaged power (3 TX Slots) - 4.26 dB
 Frame-averaged power = Burst averaged power (4 TX Slots) – 3.01 dB



WCDMA

Band	WCDMA Band 2			WCDMA Band 4			WCDMA Band 5		
Channel	9262	9400	9538	1312	1413	1513	4132	4183	4233
Frequency (MHz)	1852.4	1880	1907.6	1712.6	1740	1752.4	826.4	836.6	846.6
AMR 12.2Kbps	23.40	23.17	23.07	21.98	22.29	22.77	23.71	23.73	23.64
RMC 12.2Kbps	23.43	23.24	23.11	22.02	22.36	22.82	23.74	23.77	23.69
HSDPA Subtest-1	23.35	23.07	22.95	22.00	22.20	22.35	23.64	23.36	23.30
HSDPA Subtest-2	22.94	22.60	22.47	21.58	21.74	21.92	23.14	22.86	22.86
HSDPA Subtest-3	22.61	22.12	22.00	21.17	21.33	21.58	22.70	22.44	22.49
HSDPA Subtest-4	22.19	21.77	21.62	20.80	21.01	21.12	22.23	22.08	22.04
HSUPA Subtest-1	23.22	22.82	21.87	20.96	21.32	21.80	23.32	22.73	22.63
HSUPA Subtest-2	22.26	21.87	20.89	20.05	20.41	20.82	22.45	21.77	21.65
HSUPA Subtest-3	22.17	21.38	20.44	19.99	19.92	20.45	22.26	21.36	21.16
HSUPA Subtest-4	21.68	20.90	19.95	19.53	19.42	20.12	21.77	21.03	20.77
HSUPA Subtest-5	20.19	19.46	18.53	18.04	18.02	18.64	20.28	19.59	19.35

According to 3GPP 25.101 sub-clause 6.2.2, the maximum output power is allowed to be reduced by following the table.

Table 6.1A: UE maximum output power with HS-DPCCH and E-DCH

UE Transmit Channel Configuration	CM(db)	MPR(db)
For all combinations of ,DPDCH,DPCCH HS-DPDCH,E-DPDCH and E-DPCCH	$0 \leq CM \leq 3.5$	MAX(CM-1,0)
Note: CM=1 for $\beta_c/\beta_d=12/15$, $\beta_{hs}/\beta_c=24/15$.For all other combinations of DPDCH, DPCCH, HS-DPCCH, E-DPDCH and E-DPCCH the MPR is based on the relative CM difference.		

The device supports MPR to solve linearity issues (ACLR or SEM) due to the higher peak-to average ratios (PAR) of the HSUPA signal. This prevents saturating the full range of the TX DAC inside of device and provides a reduced power output to the RF transceiver chip according to the Cubic Metric (a function of the combinations of DPDCH, DPCCH, HS-DPCCH, E-DPDCH and E-DPCCH).

When E-DPDCH channels are present the beta gains on those channels are reduced firsts to try to get the power under the allowed limit. If the beta gains are lowered as far as possible, then a hard limiting is applied at the maximum allowed level.

The SW currently recalculates the cubic metric every time the beta gains on the E-DPDCH are reduced. The cubic metric will likely get lower each time this is done .However, there is no reported reduction of maximum output power in the HSUPA mode since the device also provides a compensation for the power back-off by increasing the gain of TX_AGC in the transceiver (PA) device.

The end effect is that the DUT output power is identical to the case where there is no MPR in the device.

**2.4G WLAN**

2.4GWIFI				
Mode	Channel Number	Frequency (MHz)	Average Power (dBm)	Output Power (mW)
802.11b	1	2412	18.31	67.76
	7	2437	18.68	73.79
	11	2462	18.19	65.92
802.11g	1	2412	13.13	20.58
	7	2437	13.24	21.10
	11	2462	13.94	24.79
802.11 n-HT20	1	2412	14.17	26.09
	7	2437	13.90	24.52
	11	2462	14.06	25.44
802.11 n-HT40	3	2422	14.10	25.69
	6	2437	14.24	26.53
	9	2452	13.96	24.87

Bluetooth

BT				
Mode	Channel Number	Frequency (MHz)	Average Power (dBm)	Output Power (mW)
GFSK(1Mbps)	0	2402	7.92	6.19
	39	2441	7.81	6.04
	78	2480	7.65	5.82
$\pi/4$ -QPSK(2Mbps)	0	2402	2.45	1.76
	39	2441	2.38	1.73
	78	2480	2.30	1.70
8DPSK(3Mbps)	0	2402	6.92	4.92
	39	2441	6.65	4.62
	78	2480	6.57	4.54

BLE

BLE				
Mode	Channel Number	Frequency (MHz)	Average Power (dBm)	Output Power (mW)
GFSK(1Mbps)	0	2402	8.56	7.17
	19	2440	8.44	6.98
	39	2480	8.18	6.57

**WLAN (5.3Gband)**

5.3G WLAN				
Mode	Channel Number	Frequency (MHz)	Output Power (dBm)	Output Power (mW)
802.11a	52	5260	10.26	10.61
	60	5300	10.23	10.53
	64	5320	9.66	9.24
802.11 n-HT20	52	5260	10.54	11.33
	60	5300	10.54	11.33
	64	5320	9.83	9.62
802.11 n-HT40	54	5270	10.42	11.03
	62	5310	10.37	10.90

WLAN (5.6Gband)

5.6G WLAN				
Mode	Channel Number	Frequency (MHz)	Output Power (dBm)	Output Power (mW)
802.11a	100	5500	9.30	8.51
	116	5580	8.63	7.29
	140	5700	8.09	6.44
802.11 n-HT20	100	5500	9.42	8.74
	116	5580	8.93	7.81
	140	5700	8.28	6.72
802.11 n-HT40	102	5510	9.43	8.77
	110	5550	8.78	7.55
	134	5670	8.22	6.64

WLAN (5.8Gband)

5.8G WLAN				
Mode	Channel Number	Frequency (MHz)	Output Power (dBm)	Output Power (mW)
802.11a	149	5745	7.74	5.94
	157	5785	8.11	6.47
	165	5825	7.91	6.18
802.11 n-HT20	149	5745	7.95	6.23
	157	5785	8.38	6.88
	165	5825	8.13	6.50
802.11 n-HT40	151	5755	7.86	6.11
	159	5795	8.07	6.41



LTE Conducted Power

General Note:

1. Anritsu CMW500 base station simulator was used to setup the connection with EUT; the frequency band, channel bandwidth, RB allocation configuration, modulation type are set in the base station simulator to configure EUT transmitting at maximum power and at different configurations which are requested to be reported to FCC, for conducted power measurement and SAR testing.
2. Per KDB 941225 D05, when a properly configured base station simulator is used for the SAR and power measurements, spectrum plots for each RB allocation and offset configuration is not required.
3. Per KDB 941225 D05, start with the largest channel bandwidth and measure SAR for QPSK with 1 RB allocation, using the RB offset and required test channel combination with the highest maximum output power for RB offsets at the upper Side, middle and lower Side of each required test channel.
4. Per KDB 941225 D05, 50% RB allocation for QPSK SAR testing follows 1RB QPSK allocation procedure.
5. Per KDB 941225 D05, For QPSK with 100% RB allocation, SAR is not required when the highest maximum output power for 100 % RB allocation is less than the highest maximum output power in 50% and 1 RB allocations and the highest reported SAR for 1 RB and 50% RB allocation are ≤ 0.8 W/kg. Otherwise, SAR is measured for the highest output power channel; and if the reported SAR is > 1.45 W/kg, the remaining required test channels must also be tested.
6. Per KDB 941225 D05, 16QAM output power for each RB allocation configuration is $>$ not $\frac{1}{2}$ dB higher than the same configuration in QPSK and the reported SAR for the QPSK configuration is ≤ 1.45 W/kg; Per KDB 941225 D05, 16QAM SAR testing is not required.
7. Per KDB 941225 D05, Smaller bandwidth output power for each RB allocation configuration is $>$ not $\frac{1}{2}$ dB higher than the same configuration in the largest supported bandwidth, and the reported SAR for the largest supported bandwidth is ≤ 1.45 W/kg; Per KDB 941225 D05, smaller bandwidth SAR testing is not required.



LTE Band 2

LTE Band 2 Maximum Average Power [dBm]						
BW [MHz]	RB Size	RB Offset	Mod	Lowest	Middle	Highest
1.4	1	0	QPSK	20.70	20.54	20.49
1.4	1	2		20.69	20.37	20.34
1.4	1	5		20.53	20.31	20.16
1.4	3	0		20.41	20.15	20.02
1.4	3	1		20.35	19.99	19.91
1.4	3	3		20.21	19.94	19.85
1.4	6	0		20.06	19.92	19.77
1.4	1	0	16-QAM	20.60	20.47	20.43
1.4	1	2		20.50	20.37	20.32
1.4	1	5		20.48	20.30	20.15
1.4	3	0		20.30	20.02	19.90
1.4	3	1		20.34	19.82	19.90
1.4	3	3		20.04	19.75	19.82
1.4	6	0		19.88	19.77	19.77
3	1	0	QPSK	20.48	20.38	20.75
3	1	7		20.33	20.35	20.61
3	1	14		20.22	20.21	20.48
3	8	0		20.14	20.04	20.43
3	8	3		20.07	19.86	20.33
3	8	7		20.01	19.69	20.29
3	15	0		19.98	19.68	20.09
3	1	0	16-QAM	20.30	20.22	20.71
3	1	7		20.24	20.21	20.51
3	1	14		20.21	20.10	20.39
3	8	0		20.03	19.92	20.33
3	8	3		19.96	19.82	20.22
3	8	7		19.82	19.51	20.25
3	15	0		19.90	19.52	20.00



LTE BAND 2

LTE Band 2 Maximum Average Power [dBm]						
BW [MHz]	RB Size	RB Offset	Mod	Lowest	Middle	Highest
5	1	0	QPSK	20.55	20.64	20.31
5	1	12		20.39	20.49	20.26
5	1	24		20.39	20.36	20.08
5	12	0		20.32	20.32	20.00
5	12	6		20.14	20.32	19.83
5	12	13		20.12	20.18	19.78
5	25	0		20.08	20.08	19.75
5	1	0		16-QAM	20.47	20.49
5	1	12	20.24		20.44	20.18
5	1	24	20.33		20.22	19.97
5	12	0	20.31		20.17	19.96
5	12	6	19.97		20.15	19.78
5	12	13	20.05		20.04	19.70
5	25	0	19.90		19.96	19.71
10	1	0	QPSK		20.71	20.89
10	1	24		20.71	20.82	20.77
10	1	49		20.65	20.77	20.60
10	25	0		20.54	20.72	20.40
10	25	12		20.52	20.56	20.29
10	25	25		20.46	20.39	20.11
10	50	0		20.41	20.20	20.02
10	1	0		16-QAM	20.66	20.70
10	1	24	20.54		20.73	20.71
10	1	49	20.50		20.72	20.46
10	25	0	20.44		20.52	20.34
10	25	12	20.37		20.40	20.22
10	25	25	20.26		20.33	19.98
10	50	0	20.26		20.11	19.84



LTE BAND 2

LTE Band 2 Maximum Average Power [dBm]						
BW [MHz]	RB Size	RB Offset	Mod	Lowest	Middle	Highest
15	1	0	QPSK	20.48	20.76	20.97
15	1	37		20.40	20.70	20.85
15	1	74		20.22	20.67	20.78
15	36	0		20.15	20.65	20.64
15	36	18		20.07	20.63	20.59
15	36	39		19.98	20.53	20.43
15	75	0		19.95	20.52	20.43
15	1	0	16-QAM	20.34	20.58	20.84
15	1	38		20.29	20.63	20.83
15	1	74		20.11	20.47	20.61
15	36	0		20.07	20.48	20.52
15	36	18		19.98	20.62	20.48
15	36	39		19.97	20.34	20.38
15	75	0		19.75	20.45	20.36
20	1	0	QPSK	21.04	20.78	20.80
20	1	50		21.00	20.63	20.77
20	1	99		20.92	20.49	20.71
20	50	0		20.78	20.38	20.55
20	50	25		20.74	20.24	20.48
20	50	50		20.70	20.12	20.37
20	100	0		20.67	20.04	20.17
20	1	0	16-QAM	21.01	20.72	20.67
20	1	50		20.95	20.46	20.62
20	1	99		20.91	20.41	20.58
20	50	0		20.75	20.22	20.49
20	50	25		20.74	20.11	20.41
20	50	50		20.65	19.98	20.27
20	100	0		20.48	19.85	20.05



LTE BAND 4

LTE Band 4 Maximum Average Power [dBm]						
BW [MHz]	RB Size	RB Offset	Mod	Lowest	Middle	Highest
1.4	1	0	QPSK	21.55	21.38	21.23
1.4	1	2		21.47	21.29	21.21
1.4	1	5		21.37	21.18	21.15
1.4	3	0		21.29	21.00	20.98
1.4	3	1		21.16	20.85	20.90
1.4	3	3		20.98	20.82	20.89
1.4	6	0		20.97	20.79	20.88
1.4	1	0	16-QAM	21.51	21.34	21.23
1.4	1	2		21.43	21.26	21.05
1.4	1	5		21.17	21.01	20.99
1.4	3	0		21.20	20.91	20.95
1.4	3	1		20.96	20.84	20.81
1.4	3	3		20.88	20.80	20.79
1.4	6	0		20.92	20.66	20.70
3	1	0	QPSK	21.82	21.84	21.69
3	1	7		21.71	21.83	21.68
3	1	14		21.51	21.73	21.63
3	8	0		21.33	21.67	21.55
3	8	3		21.17	21.58	21.47
3	8	7		21.17	21.51	21.28
3	15	0		21.06	21.45	21.10
3	1	0	16-QAM	21.65	21.75	21.58
3	1	7		21.51	21.64	21.52
3	1	14		21.45	21.54	21.60
3	8	0		21.24	21.49	21.44
3	8	4		21.15	21.39	21.40
3	8	7		21.05	21.46	21.20
3	15	0		20.98	21.37	20.96



LTE BAND 4

LTE Band 4 Maximum Average Power [dBm]						
BW [MHz]	RB Size	RB Offset	Mod	Lowest	Middle	Highest
5	1	0	QPSK	21.68	21.93	21.92
5	1	12		21.55	21.85	21.81
5	1	24		21.42	21.79	21.78
5	12	0		21.38	21.76	21.62
5	12	6		21.25	21.69	21.60
5	12	13		21.24	21.61	21.44
5	25	0		21.09	21.42	21.41
5	1	0	16-QAM	21.52	21.83	21.81
5	1	12		21.47	21.77	21.75
5	1	24		21.31	21.70	21.58
5	12	0		21.25	21.58	21.62
5	12	6		21.24	21.56	21.40
5	12	13		21.13	21.47	21.40
5	25	0		21.05	21.24	21.31
10	1	0	QPSK	21.99	21.97	21.76
10	1	24		21.90	21.82	21.64
10	1	49		21.74	21.71	21.46
10	25	0		21.67	21.68	21.40
10	25	12		21.64	21.64	21.37
10	25	25		21.63	21.55	21.22
10	50	0		21.59	21.46	21.16
10	1	0	16-QAM	21.97	21.78	21.59
10	1	24		21.88	21.80	21.61
10	1	49		21.69	21.54	21.37
10	25	0		21.48	21.66	21.27
10	25	12		21.53	21.59	21.21
10	25	25		21.52	21.45	21.07
10	50	0		21.50	21.46	21.12



LTE BAND 4

LTE Band 4 Maximum Average Power [dBm]						
BW [MHz]	RB Size	RB Offset	Mod	Lowest	Middle	Highest
15	1	0	QPSK	21.54	21.74	21.75
15	1	37		21.46	21.66	21.60
15	1	74		21.31	21.64	21.40
15	36	0		21.14	21.61	21.38
15	36	19		20.96	21.57	21.27
15	36	39		20.84	21.47	21.14
15	75	0		20.64	21.40	21.01
15	1	0	16-QAM	21.40	21.65	21.69
15	1	38		21.46	21.50	21.52
15	1	75		21.24	21.58	21.39
15	36	0		20.95	21.42	21.30
15	36	19		20.94	21.40	21.26
15	36	39		20.74	21.41	21.03
15	75	0		20.50	21.37	21.01
20	1	0	QPSK	22.05	21.82	22.04
20	1	50		21.96	21.71	21.92
20	1	99		21.85	21.69	21.90
20	50	0		21.85	21.66	21.87
20	50	25		21.81	21.61	21.76
20	50	50		21.71	21.43	21.72
20	100	0		21.53	21.37	21.61
20	1	0	16-QAM	21.89	21.63	21.89
20	1	50		21.91	21.70	21.90
20	1	99		21.78	21.67	21.89
20	50	0		21.77	21.52	21.76
20	50	25		21.64	21.44	21.68
20	50	50		21.62	21.34	21.66
20	100	0		21.48	21.24	21.56



LTE BAND 5

LTE Band 5 Maximum Average Power [dBm]						
BW [MHz]	RB Size	RB Offset	Mod	Lowest	Middle	Highest
1.4	1	0	QPSK	22.41	22.46	22.57
1.4	1	2		22.40	22.42	22.38
1.4	1	5		22.33	22.27	22.30
1.4	3	0		22.23	22.15	22.22
1.4	3	1		22.22	22.07	22.10
1.4	3	2		22.18	22.02	21.98
1.4	6	0		22.06	21.90	21.97
1.4	1	0	16-QAM	22.36	22.42	22.49
1.4	1	2		22.27	22.25	22.36
1.4	1	5		22.33	22.21	22.14
1.4	3	0		22.23	22.12	22.07
1.4	3	1		22.21	21.90	22.01
1.4	3	2		22.15	21.94	21.82
1.4	6	0		22.02	21.87	21.79
3	1	0	QPSK	22.88	22.63	22.66
3	1	7		22.72	22.52	22.47
3	1	14		22.63	22.35	22.38
3	8	0		22.59	22.17	22.31
3	8	4		22.48	22.11	22.18
3	8	7		22.43	22.04	22.12
3	15	0		22.33	21.93	21.97
3	1	0	16-QAM	22.76	22.49	22.52
3	1	7		22.70	22.45	22.37
3	1	14		22.61	22.23	22.18
3	8	0		22.42	22.00	22.15
3	8	4		22.47	21.93	22.00
3	8	7		22.28	21.98	22.11
3	15	0		22.15	21.79	21.79



LTE BAND 5

LTE Band 5 Maximum Average Power [dBm]						
BW [MHz]	RB Size	RB Offset	Mod	Lowest	Middle	Highest
5	1	0	QPSK	22.36	22.38	22.87
5	1	12		22.27	22.38	22.69
5	1	24		22.24	22.26	22.67
5	12	0		22.09	22.11	22.52
5	12	6		21.96	21.97	22.36
5	12	11		21.92	21.78	22.24
5	25	0		21.83	21.72	22.18
5	1	0	16-QAM	22.21	22.32	22.76
5	1	12		22.08	22.30	22.55
5	1	24		22.11	22.22	22.55
5	12	0		21.94	22.03	22.38
5	12	6		21.82	21.81	22.26
5	12	11		21.72	21.70	22.09
5	25	0		21.75	21.63	22.09
10	1	0	QPSK	22.90	23.18	22.89
10	1	24		22.84	23.08	22.85
10	1	49		22.75	23.06	22.66
10	25	0		22.60	23.01	22.56
10	25	12		22.46	22.93	22.50
10	25	24		22.30	22.81	22.31
10	50	0		22.13	22.74	22.17
10	1	0	16-QAM	22.84	23.16	22.69
10	1	24		22.72	23.02	22.84
10	1	49		22.73	22.86	22.47
10	25	0		22.54	22.91	22.45
10	25	12		22.31	22.83	22.30
10	25	24		22.30	22.79	22.13
10	50	0		21.99	22.60	22.05



LTE BAND 7

LTE Band 7 Maximum Average Power [dBm]						
BW [MHz]	RB Size	RB Offset	Mod	Lowest	Middle	Highest
5	1	0	QPSK	20.22	20.12	19.76
5	1	12		20.12	20.01	19.70
5	1	24		19.98	20.00	19.54
5	12	0		19.97	19.95	19.54
5	12	6		19.94	19.93	19.41
5	12	11		19.91	19.88	19.24
5	25	0		19.85	19.82	19.22
5	1	0	16-QAM	20.15	20.01	19.60
5	1	12		19.97	19.82	19.51
5	1	24		19.84	19.84	19.45
5	12	0		19.83	19.87	19.53
5	12	6		19.87	19.90	19.25
5	12	11		19.81	19.71	19.06
5	25	0		19.69	19.62	19.02
10	1	0	QPSK	19.39	19.65	19.52
10	1	24		19.27	19.53	19.37
10	1	49		19.18	19.43	19.26
10	25	0		19.17	19.27	19.11
10	25	12		19.15	19.17	19.05
10	25	24		19.08	18.99	18.89
10	50	0		18.89	18.81	18.86
10	1	0	16-QAM	19.25	19.46	19.45
10	1	24		19.22	19.53	19.34
10	1	49		18.98	19.39	19.16
10	25	0		19.00	19.20	19.01
10	25	12		19.04	19.11	19.02
10	25	24		18.96	18.90	18.72
10	50	0		18.78	18.80	18.69



LTE BAND 7

LTE Band 7 Maximum Average Power [dBm]						
BW [MHz]	RB Size	RB Offset	Mod	Lowest	Middle	Highest
15	1	0	QPSK	19.81	19.89	19.79
15	1	37		19.68	19.82	19.60
15	1	74		19.56	19.78	19.58
15	36	0		19.52	19.74	19.43
15	36	18		19.46	19.66	19.24
15	36	39		19.44	19.60	19.24
15	75	0		19.42	19.55	19.11
15	1	0		16-QAM	19.76	19.82
15	1	38	19.54		19.72	19.42
15	1	75	19.38		19.68	19.43
15	36	0	19.42		19.56	19.39
15	36	18	19.29		19.57	19.10
15	36	39	19.30		19.42	19.06
15	75	0	19.38		19.44	18.94
20	1	0	QPSK		20.48	20.39
20	1	49		20.45	20.28	20.48
20	1	99		20.37	20.14	20.45
20	50	0		20.22	19.95	20.39
20	50	24		20.03	19.82	20.33
20	50	49		19.93	19.79	20.22
20	100	0		19.81	19.60	20.19
20	1	0		16-QAM	20.37	20.39
20	1	49	20.32		20.08	20.37
20	1	99	20.35		19.99	20.41
20	50	0	20.15		19.88	20.27
20	50	24	19.89		19.63	20.24
20	50	49	19.86		19.78	20.05
20	100	0	19.68		19.45	20.14



LTE BAND 12

LTE Band 12 Maximum Average Power [dBm]						
BW [MHz]	RB Size	RB Offset	Mod	Lowest	Middle	Highest
1.4	1	0	QPSK	21.07	21.25	21.27
1.4	1	2		21.06	21.17	21.17
1.4	1	5		20.99	21.15	21.05
1.4	3	0		20.80	21.09	21.00
1.4	3	1		20.69	20.99	20.93
1.4	3	2		20.61	20.93	20.85
1.4	6	0		20.43	20.82	20.74
1.4	1	0	16-QAM	20.96	21.24	21.13
1.4	1	2		20.99	21.14	21.13
1.4	1	5		20.85	21.03	20.96
1.4	3	0		20.64	20.91	20.91
1.4	3	1		20.52	20.80	20.86
1.4	3	2		20.43	20.83	20.76
1.4	6	0		20.29	20.63	20.71
3	1	0	QPSK	21.23	21.15	21.27
3	1	7		21.15	21.14	21.12
3	1	14		21.03	21.08	20.98
3	8	0		20.90	20.95	20.96
3	8	4		20.84	20.82	20.86
3	8	7		20.77	20.68	20.81
3	15	0		20.77	20.68	20.79
3	1	0	16-QAM	21.09	21.06	21.12
3	1	7		21.01	21.08	20.97
3	1	14		20.98	20.97	20.92
3	8	0		20.81	20.79	20.84
3	8	4		20.71	20.71	20.74
3	8	7		20.61	20.59	20.63
3	15	0		20.75	20.51	20.63



LTE BAND 12

LTE Band 12 Maximum Average Power [dBm]						
BW [MHz]	RB Size	RB Offset	Mod	Lowest	Middle	Highest
5	1	0	QPSK	21.70	21.67	21.84
5	1	12		21.64	21.57	21.68
5	1	24		21.53	21.54	21.60
5	12	0		21.49	21.40	21.43
5	12	6		21.32	21.22	21.37
5	12	11		21.14	21.05	21.32
5	25	0		21.05	20.93	21.25
5	1	0		16-QAM	21.62	21.50
5	1	12	21.58		21.46	21.67
5	1	24	21.51		21.51	21.56
5	12	0	21.36		21.26	21.38
5	12	6	21.23		21.18	21.23
5	12	11	20.97		20.92	21.18
5	25	0	20.98		20.89	21.14
10	1	0	QPSK		22.08	21.92
10	1	24		21.99	21.83	21.59
10	1	49		21.85	21.79	21.57
10	25	0		21.78	21.74	21.50
10	25	12		21.59	21.62	21.42
10	25	24		21.54	21.56	21.25
10	50	0		21.35	21.39	21.20
10	1	0		16-QAM	21.93	21.91
10	1	24	21.90		21.74	21.42
10	1	49	21.84		21.60	21.43
10	25	0	21.77		21.68	21.43
10	25	12	21.44		21.44	21.32
10	25	24	21.37		21.51	21.18
10	50	0	21.32		21.32	21.01



LTE BAND 17

LTE Band 17 Maximum Average Power [dBm]						
BW [MHz]	RB Size	RB Offset	Mod	Lowest	Middle	Highest
5	1	0	QPSK	19.23	19.41	19.81
5	1	12		19.12	19.38	19.77
5	1	24		19.02	19.21	19.61
5	12	0		18.96	19.07	19.50
5	12	6		18.79	19.03	19.36
5	12	11		18.69	18.86	19.26
5	25	0		18.61	18.67	19.22
5	1	0	16-QAM	19.08	19.23	19.79
5	1	12		19.12	19.28	19.73
5	1	24		19.00	19.08	19.50
5	12	0		18.85	18.93	19.33
5	12	6		18.69	18.96	19.24
5	12	11		18.63	18.68	19.17
5	25	0		18.46	18.54	19.05
10	1	0	QPSK	20.18	20.20	19.45
10	1	24		20.15	20.09	19.35
10	1	49		20.15	20.08	19.32
10	25	0		20.14	20.05	19.26
10	25	12		20.14	19.86	19.17
10	25	24		20.04	19.69	19.04
10	50	0		19.94	19.56	18.97
10	1	0	16-QAM	20.10	20.15	19.33
10	1	24		20.14	20.04	19.35
10	1	49		19.95	19.94	19.31
10	25	0		20.09	19.96	19.18
10	25	12		20.12	19.70	19.01
10	25	24		20.00	19.59	18.94
10	50	0		19.77	19.40	18.79



LTE BAND 66

LTE Band 66 Maximum Average Power [dBm]						
BW [MHz]	RB Size	RB Offset	Mod	Lowest	Middle	Highest
1.4	1	0	QPSK	21.43	21.83	21.52
1.4	1	2		21.35	21.63	21.39
1.4	1	5		21.17	21.49	21.24
1.4	3	0		21.12	21.43	21.14
1.4	3	1		21.08	21.32	21.01
1.4	3	2		20.91	21.14	20.85
1.4	6	0		20.90	21.04	20.83
1.4	1	0		16-QAM	21.23	21.74
1.4	1	2	21.15		21.57	21.29
1.4	1	5	21.03		21.30	21.06
1.4	3	0	21.04		21.35	21.08
1.4	3	1	21.06		21.31	20.90
1.4	3	2	20.88		20.94	20.70
1.4	6	0	20.73		20.99	20.69
3	1	0	QPSK		21.97	21.67
3	1	7		21.83	21.63	21.81
3	1	14		21.73	21.56	21.81
3	8	0		21.55	21.53	21.69
3	8	4		21.47	21.45	21.56
3	8	7		21.32	21.44	21.54
3	15	0		21.30	21.29	21.47
3	1	0		16-QAM	21.89	21.63
3	1	7	21.71		21.53	21.71
3	1	14	21.57		21.56	21.65
3	8	0	21.40		21.43	21.53
3	8	4	21.38		21.37	21.44
3	8	7	21.15		21.37	21.44
3	15	0	21.30		21.11	21.40



LTE Band 66 Maximum Average Power [dBm]						
BW [MHz]	RB Size	RB Offset	Mod	Lowest	Middle	Highest
5	1	0	QPSK	21.97	22.05	21.58
5	1	12		21.78	22.01	21.52
5	1	24		21.70	21.97	21.43
5	12	0		21.65	21.82	21.29
5	12	6		21.54	21.67	21.19
5	12	11		21.37	21.60	21.15
5	25	0		21.32	21.48	21.04
5	1	0	16-QAM	21.86	21.87	21.42
5	1	12		21.78	21.91	21.49
5	1	24		21.61	21.83	21.24
5	12	0		21.57	21.68	21.12
5	12	6		21.39	21.49	21.00
5	12	11		21.18	21.45	20.99
5	25	0		21.31	21.29	20.94
10	1	0	QPSK	22.04	22.06	22.26
10	1	24		21.93	21.93	22.08
10	1	49		21.79	21.93	22.03
10	25	0		21.76	21.89	21.91
10	25	12		21.61	21.82	21.87
10	25	24		21.45	21.69	21.72
10	50	0		21.36	21.69	21.55
10	1	0	16-QAM	21.91	22.05	22.21
10	1	24		21.93	21.89	21.99
10	1	49		21.68	21.73	21.89
10	25	0		21.69	21.70	21.83
10	25	12		21.61	21.65	21.81
10	25	24		21.26	21.67	21.58
10	50	0		21.28	21.52	21.50



LTE Band 66 Maximum Average Power [dBm]						
BW [MHz]	RB Size	RB Offset	Mod	Lowest	Middle	Highest
15	1	0	QPSK	22.11	22.07	21.66
15	1	37		22.09	21.99	21.55
15	1	74		22.08	21.90	21.42
15	36	0		22.04	21.85	21.39
15	36	18		21.99	21.78	21.32
15	36	39		21.96	21.69	21.28
15	75	0		21.88	21.60	21.22
15	1	0	16-QAM	21.97	22.05	21.57
15	1	38		22.06	21.98	21.46
15	1	75		21.99	21.82	21.26
15	36	0		21.88	21.70	21.30
15	36	18		21.85	21.60	21.22
15	36	39		21.83	21.50	21.08
15	75	0		21.75	21.48	21.07
20	1	0	QPSK	22.48	22.18	21.78
20	1	49		22.30	22.07	21.64
20	1	99		22.26	21.89	21.62
20	50	0		22.18	21.86	21.61
20	50	24		22.10	21.79	21.57
20	50	49		21.91	21.67	21.39
20	100	0		21.77	21.55	21.21
20	1	0	16-QAM	22.37	22.05	21.64
20	1	49		22.21	21.95	21.60
20	1	99		22.14	21.84	21.47
20	50	0		22.12	21.85	21.50
20	50	24		22.06	21.74	21.54
20	50	49		21.83	21.64	21.26
20	100	0		21.69	21.40	21.17

11. EUT and Test Setup Photo

11.1 EUT Photo

Front side



Back side





Top side

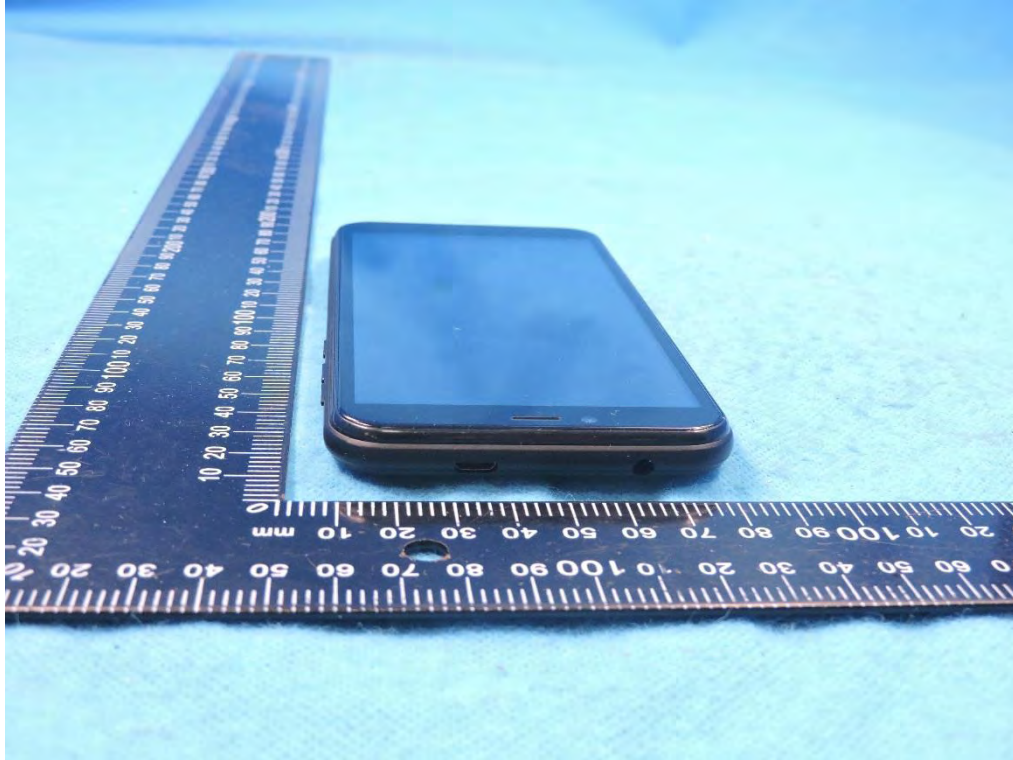

Bottom side

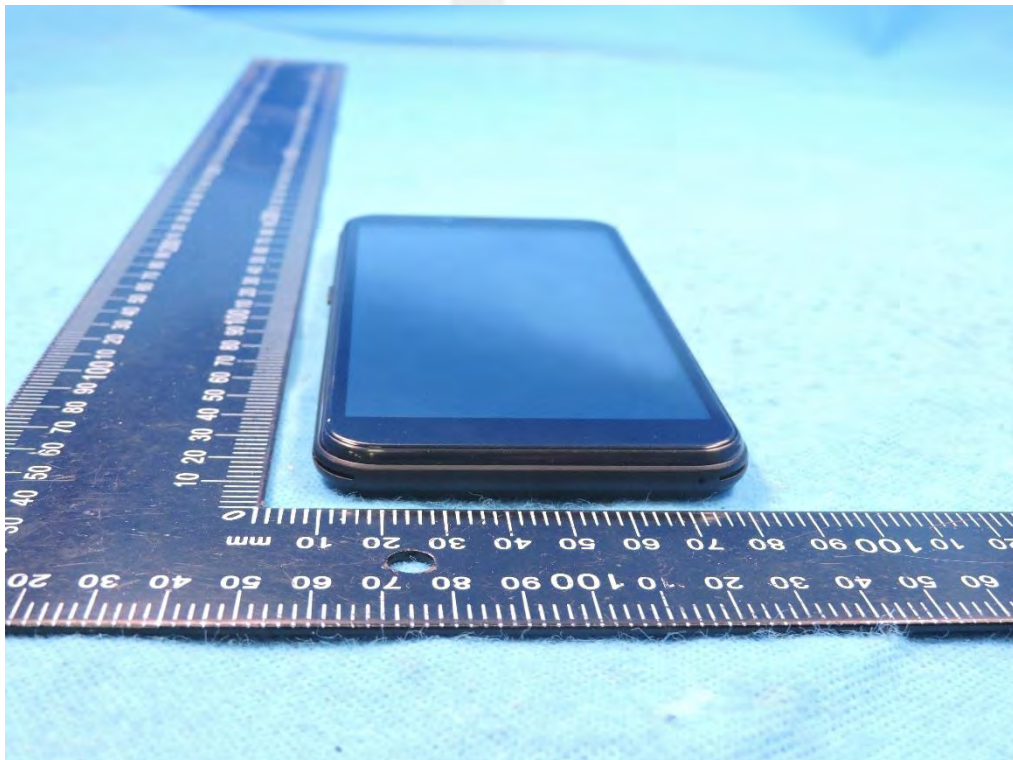



Left side

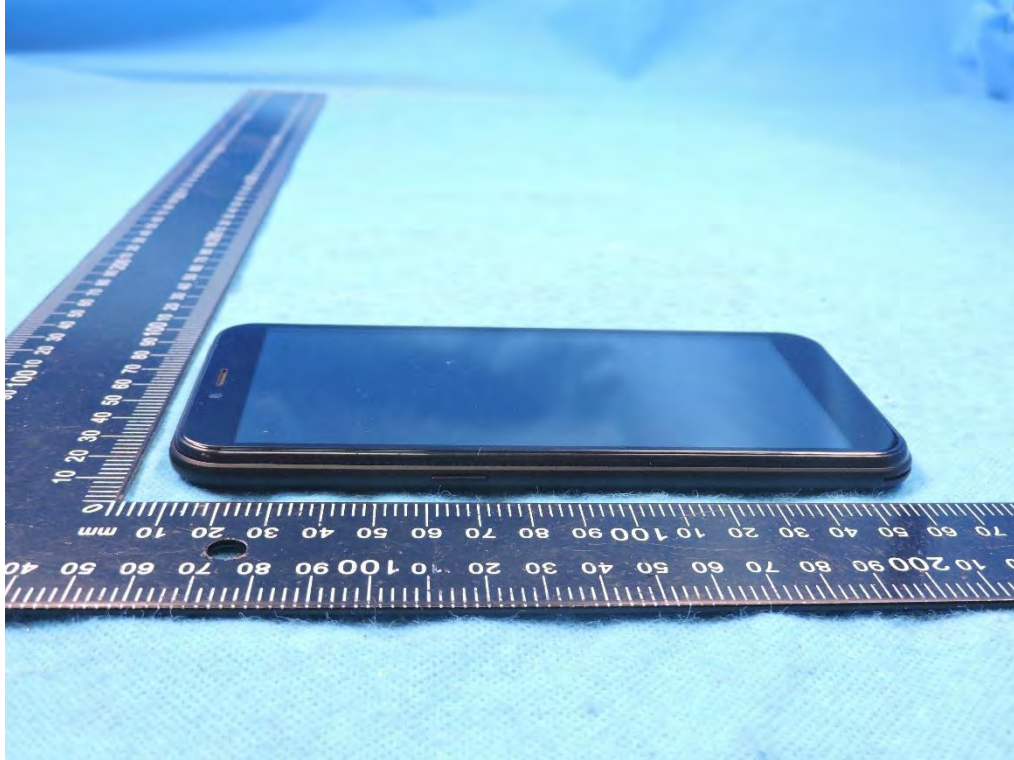

Right side

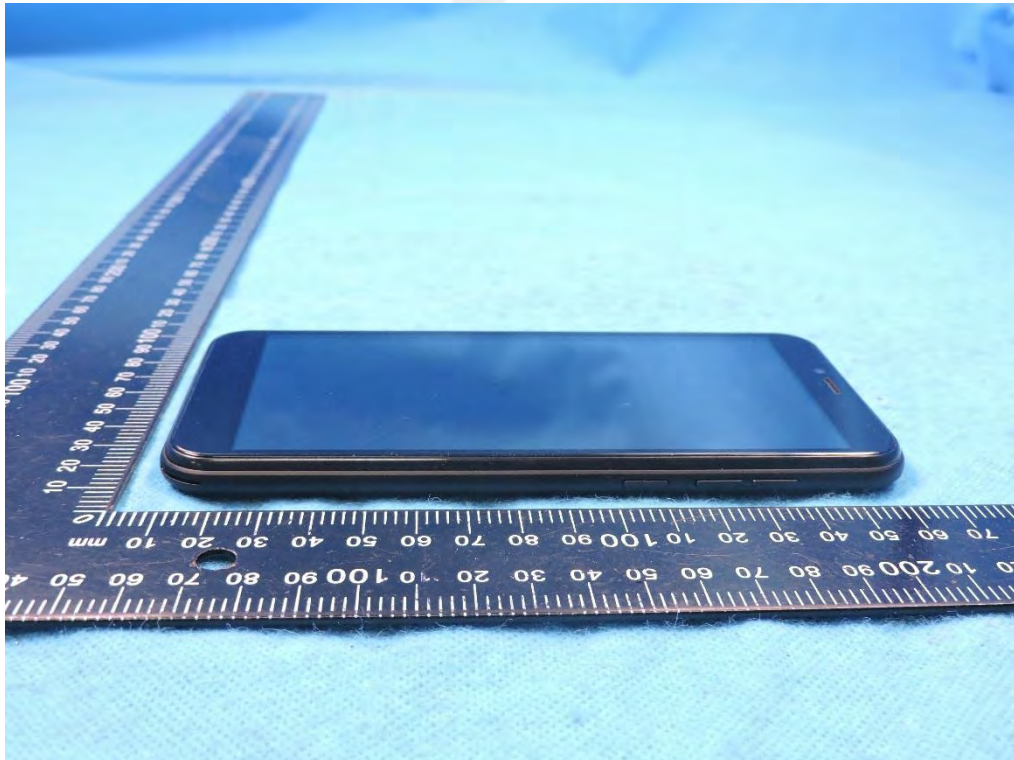



11.2 Setup Photo

Right Touch

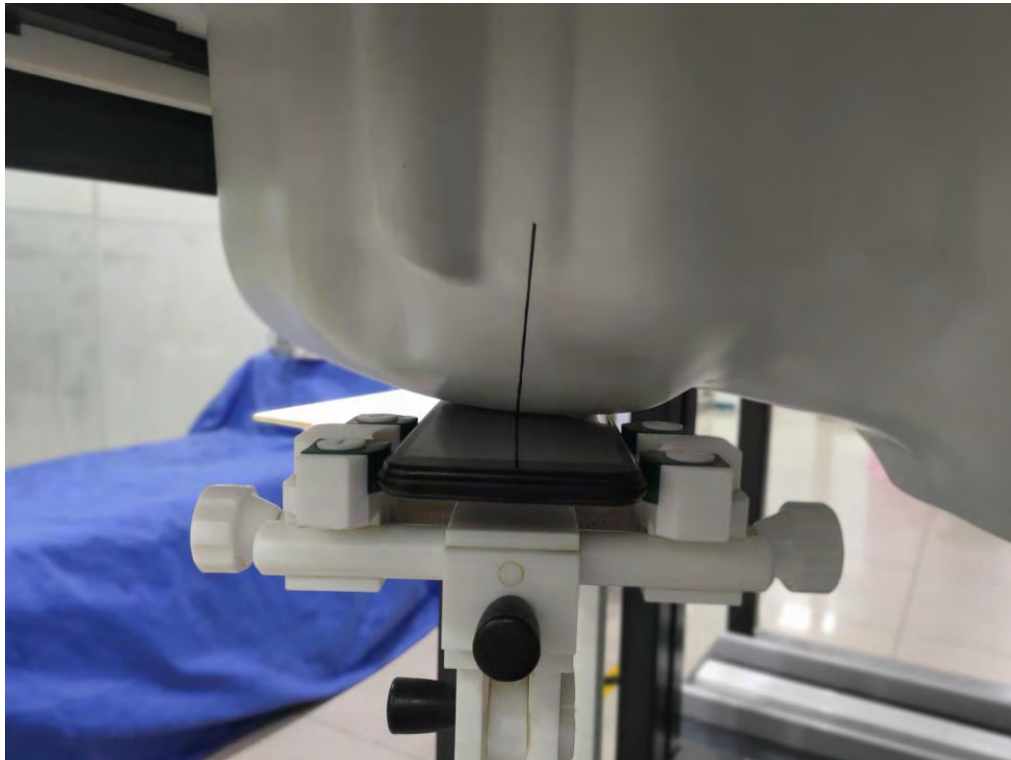

Right Tilt



Left Touch

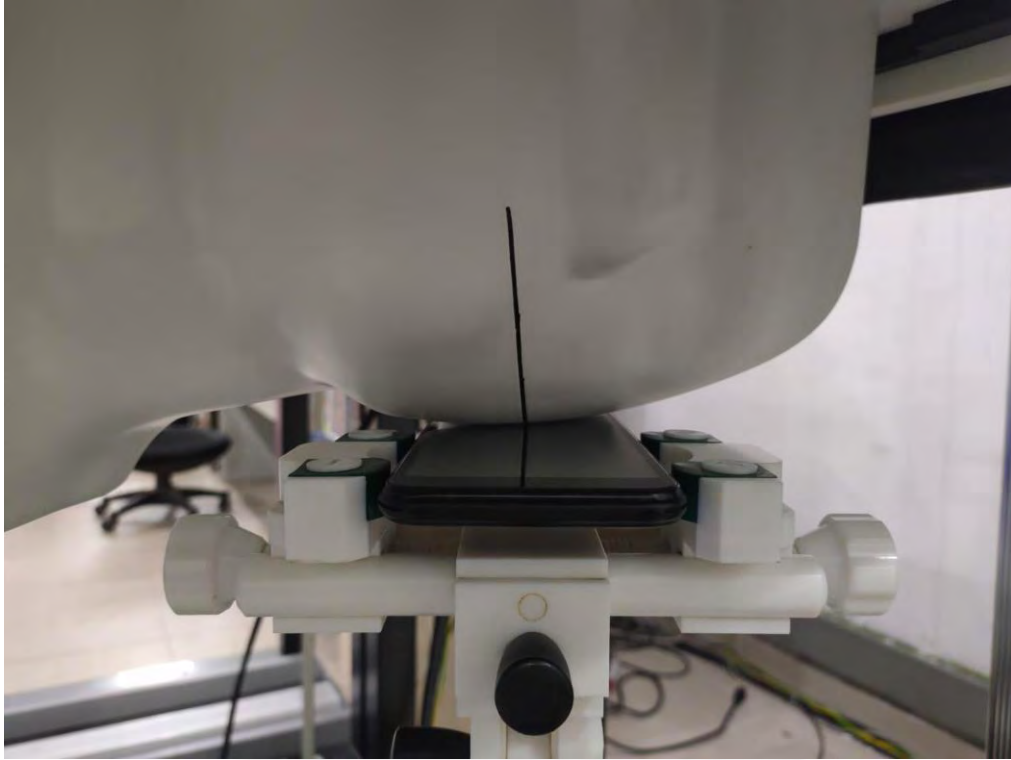

Left Tilt

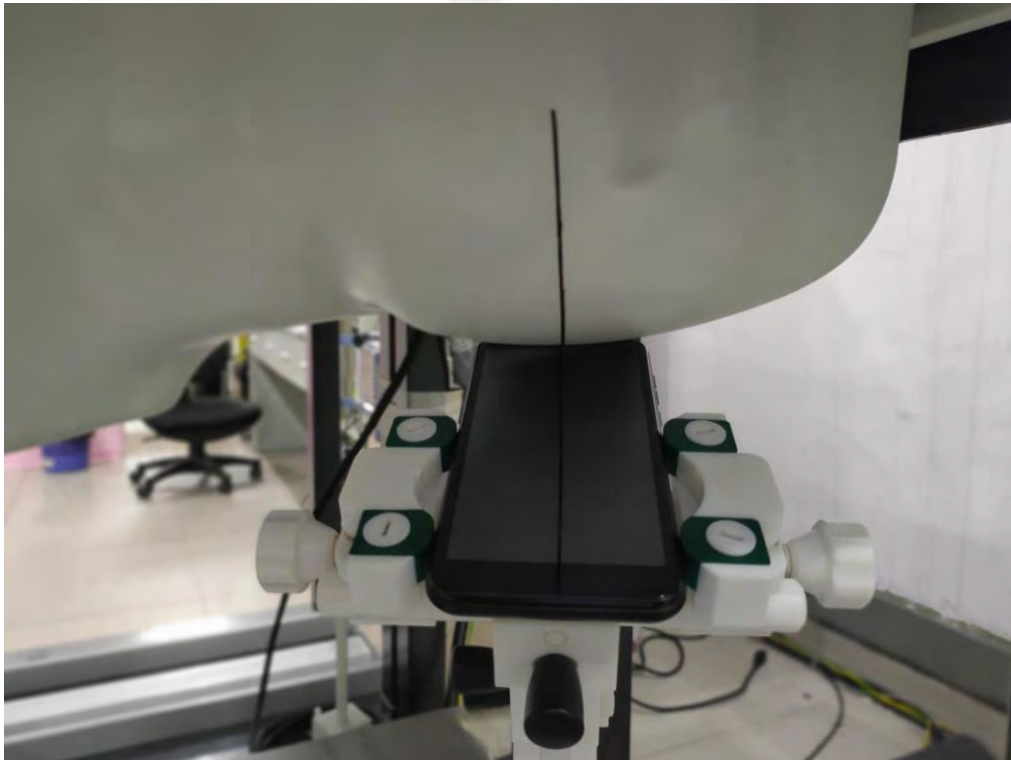

Body Front side(separation distance is 10mm)

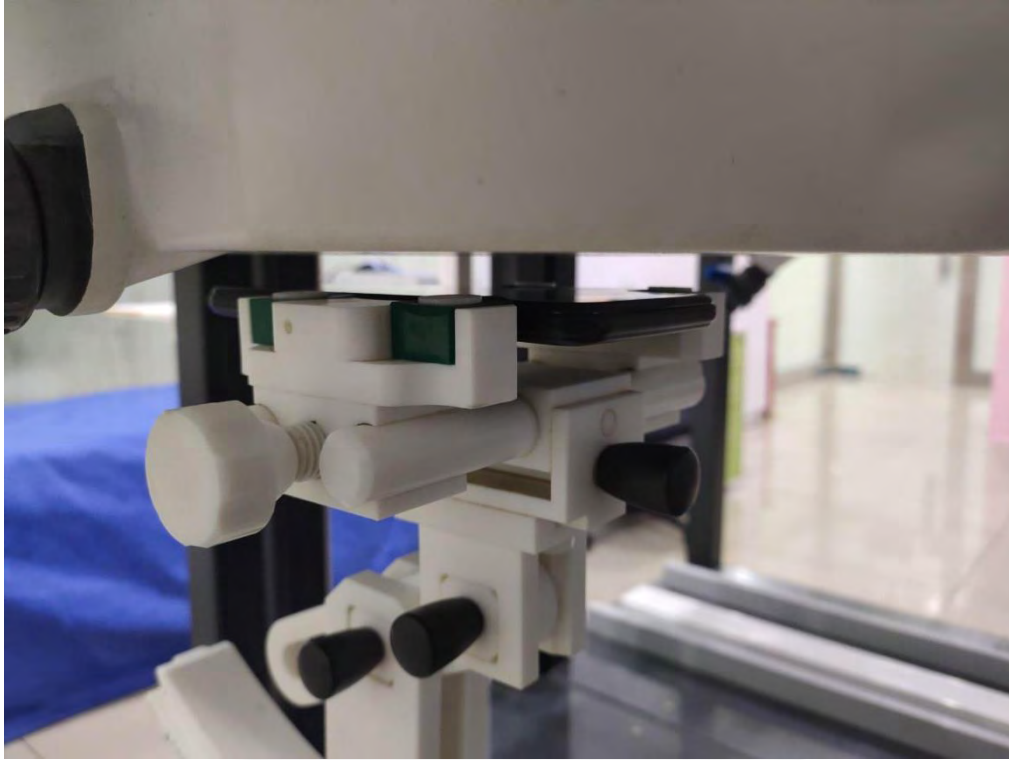

Body Back side(separation distance is 10mm)

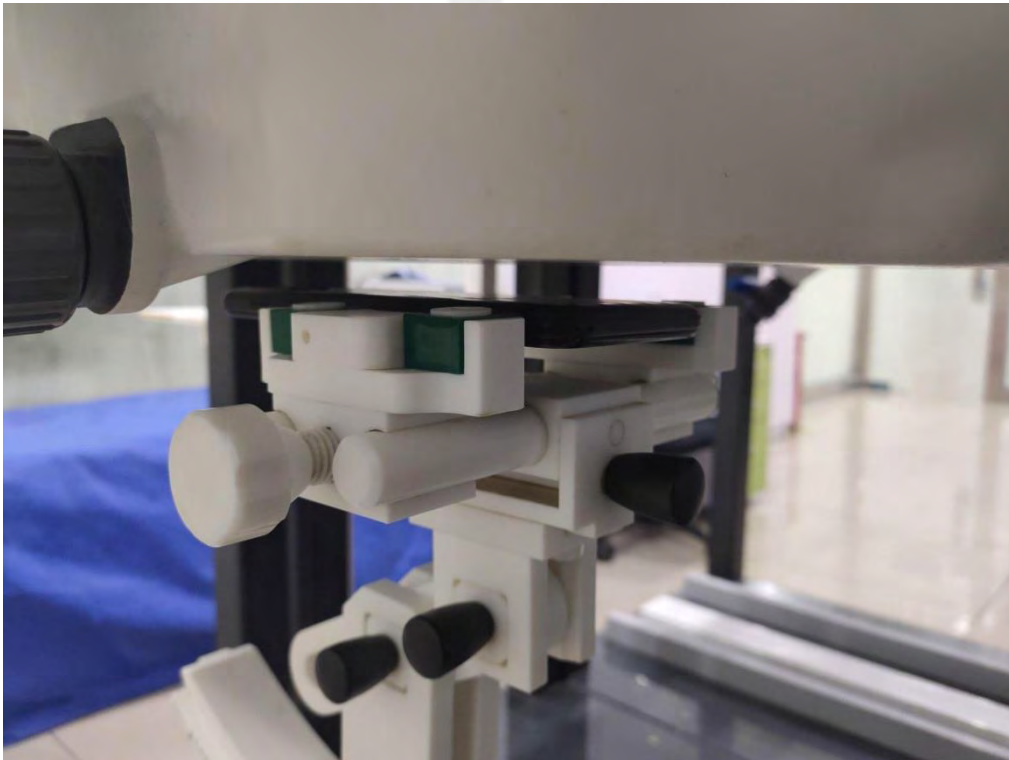

Body Left side(separation distance is 10mm)

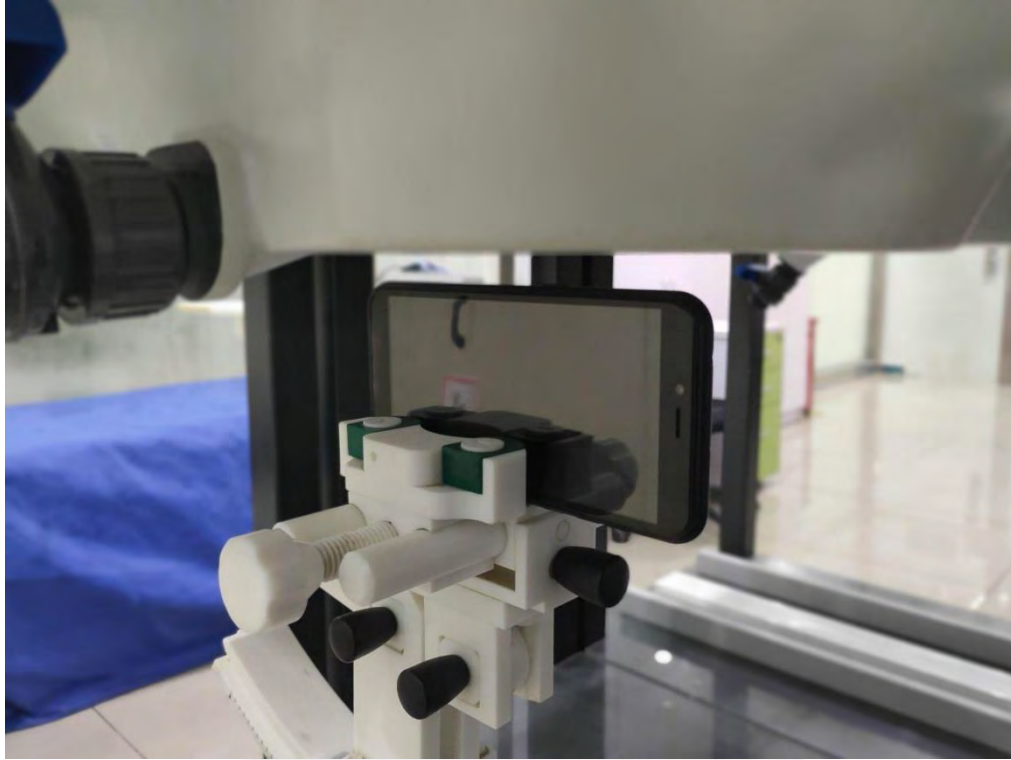

Body Right side(separation distance is 10mm)

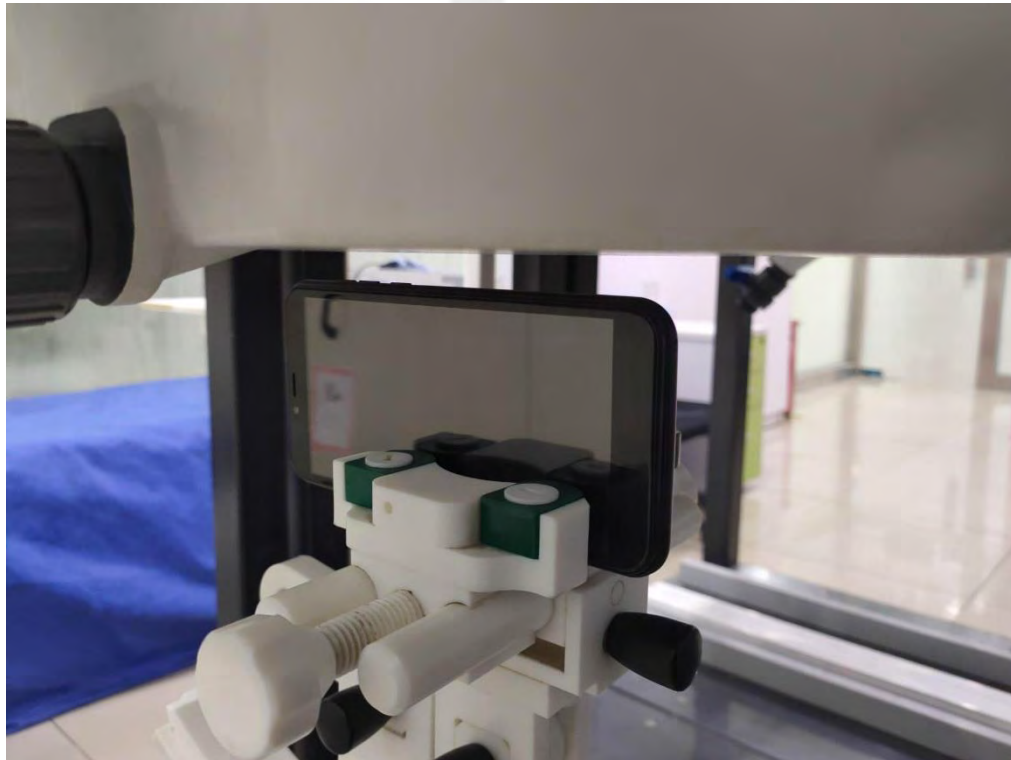

Body Bottom side(separation distance is 10mm)



Body Top side(separation distance is 10mm)

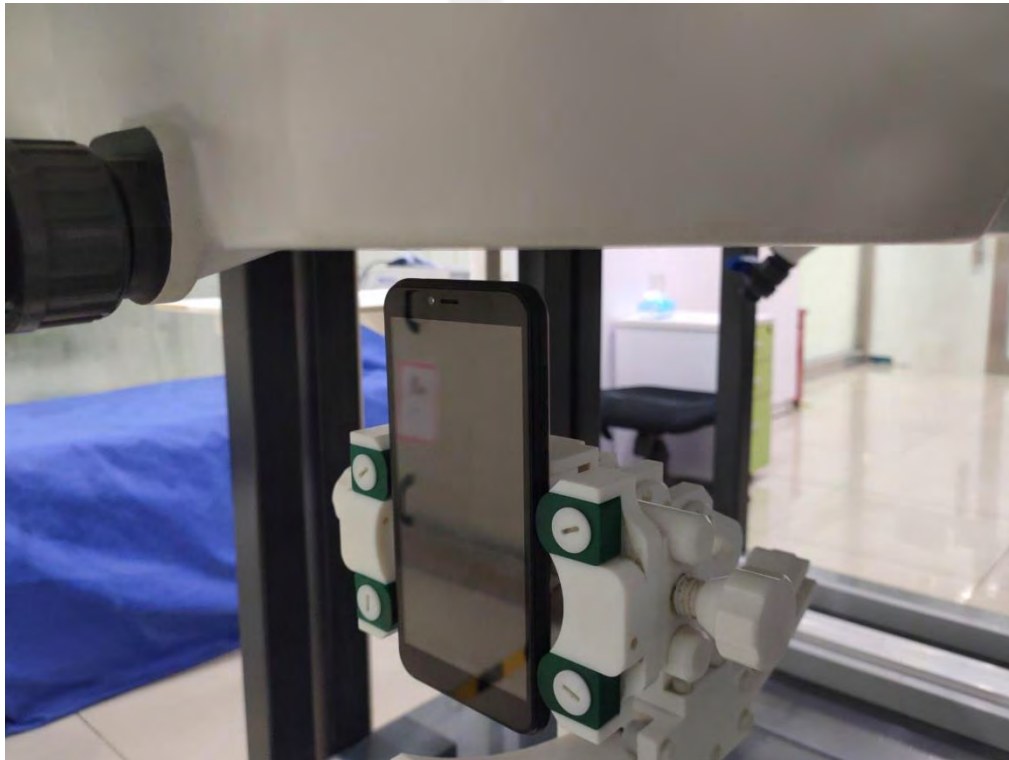



Liquid depth (15 cm)





12. SAR Result Summary

12.1 Head SAR

Band	Model	Test Position	Freq.	SAR (1g) (W/kg)	Power Drift(%)	Max.Turn-up Power(dBm)	Meas.Output Power(dBm)	Scaled SAR (W/Kg)	Meas.No.
GSM850	GPRS Data-4 Slot	Right Cheek	824.2	0.422	3.66	29.50	29.19	0.453	/
		Right Tilt	824.2	0.212	1.49	29.50	29.19	0.228	/
		Left Cheek	824.2	0.439	-3.54	29.50	29.19	0.471	1
		Left Tilt	824.2	0.231	0.94	29.50	29.19	0.248	/
GSM1900	GPRS Data-4 Slot	Right Cheek	1880	0.407	0.27	28.00	27.53	0.454	/
		Right Tilt	1880	0.245	-0.26	28.00	27.53	0.273	/
		Left Cheek	1880	0.713	-1.62	28.00	27.53	0.794	3
		Left Tilt	1880	0.421	-1.08	28.00	27.53	0.469	/
WCDMA Band 2	RMC	Right Cheek	1852.4	0.241	-2.91	23.50	23.43	0.245	/
		Right Tilt	1852.4	0.124	0.81	23.50	23.43	0.126	/
		Left Cheek	1852.4	0.281	-1.69	23.50	23.43	0.286	5
		Left Tilt	1852.4	0.135	-3.52	23.50	23.43	0.137	/
WCDMA Band 4	RMC	Right Cheek	1752.4	0.325	1.45	23.00	22.82	0.339	/
		Right Tilt	1752.4	0.124	-0.78	23.00	22.82	0.129	/
		Left Cheek	1752.4	0.391	-3.46	23.00	22.82	0.408	7
		Left Tilt	1752.4	0.136	-2.09	23.00	22.82	0.142	/
WCDMA Band 5	RMC	Right Cheek	836.6	0.695	-0.99	24.00	23.77	0.733	/
		Right Tilt	836.6	0.254	-3.20	24.00	23.77	0.268	/
		Left Cheek	826.4	0.655	-2.51	24.00	23.74	0.695	/
		Left Cheek	836.6	0.733	2.24	24.00	23.77	0.773	9
		Left Cheek	846.6	0.632	-0.73	24.00	23.69	0.679	/
		Left Tilt	836.6	0.412	-3.87	24.00	23.77	0.434	/



Band	BW (MHz)	Mod.	RB Size	RB offset	Test Position	Freq.	Result 1g (W/Kg)	Power Drift(%)	Max. Turn-up Power (dBm)	Meas. Output Power (dBm)	Scaled SAR (W/Kg)	Meas. No.
LTE Band 2	20M	QPSK	1	0	Right Cheek	1860	0.069	-3.69	21.5	21.04	0.077	/
			50	0	Right Cheek	1860	0.054	3.88	21.5	20.78	0.064	/
			1	0	Right Tilt	1860	0.032	3.20	21.5	21.04	0.036	/
			50	0	Right Tilt	1860	0.041	-0.16	21.5	20.78	0.048	/
			1	0	Left Cheek	1860	0.135	-1.86	21.5	21.04	0.150	11
			50	0	Left Cheek	1860	0.124	0.23	21.5	20.78	0.146	/
			1	0	Left Tilt	1860	0.088	-3.15	21.5	21.04	0.098	/
			50	0	Left Tilt	1860	0.075	-0.14	21.5	20.78	0.089	/
LTE Band 4	20M	QPSK	1	0	Right Cheek	1720	0.098	3.89	22.5	22.05	0.109	/
			50	0	Right Cheek	1745	0.089	-2.27	22.5	21.87	0.103	/
			1	0	Right Tilt	1720	0.054	-1.20	22.5	22.05	0.060	/
			50	0	Right Tilt	1745	0.042	-1.90	22.5	21.87	0.049	/
			1	0	Left Cheek	1720	0.117	-1.52	22.5	22.05	0.130	13
			50	0	Left Cheek	1745	0.102	-1.28	22.5	21.87	0.118	/
			1	0	Left Tilt	1720	0.055	1.19	22.5	22.05	0.061	/
			50	0	Left Tilt	1745	0.062	-1.84	22.5	21.87	0.072	/
LTE Band 5	10M	QPSK	1	0	Right Cheek	836.5	0.245	3.05	23.5	23.18	0.264	/
			25	0	Right Cheek	836.5	0.223	-3.56	23.5	23.01	0.250	/
			1	0	Right Tilt	836.5	0.124	2.09	23.5	23.18	0.133	/
			25	0	Right Tilt	836.5	0.125	-2.04	23.5	23.01	0.140	/
			1	0	Left Cheek	836.5	0.252	2.38	23.5	23.18	0.271	15
			25	0	Left Cheek	836.5	0.241	3.38	23.5	23.01	0.270	/
			1	0	Left Tilt	836.5	0.121	0.12	23.5	23.18	0.130	/
			25	0	Left Tilt	836.5	0.132	1.42	23.5	23.01	0.148	/
LTE Band 7	20M	QPSK	1	0	Right Cheek	2560	0.035	-0.16	21	20.62	0.038	/
			50	0	Right Cheek	2560	0.036	2.39	21	20.39	0.041	/
			1	0	Right Tilt	2560	0.014	-3.07	21	20.62	0.015	/
			50	0	Right Tilt	2560	0.021	-2.71	21	20.39	0.024	/
			1	0	Left Cheek	2560	0.041	-3.77	21	20.62	0.045	17
			50	0	Left Cheek	2560	0.038	1.96	21	20.39	0.044	/
			1	0	Left Tilt	2560	0.012	2.96	21	20.62	0.013	/
			50	0	Left Tilt	2560	0.014	3.77	21	20.39	0.016	/



LTE Band 12	10M	QPSK	1	0	Right Cheek	704	0.124	1.39	22.5	22.08	0.137	/
			25	0	Right Cheek	704	0.114	3.36	22.5	21.78	0.135	/
			1	0	Right Tilt	704	0.045	3.58	22.5	22.08	0.050	/
			25	0	Right Tilt	704	0.052	1.35	22.5	21.78	0.061	/
			1	0	Left Cheek	704	0.153	-0.30	22.5	22.08	0.169	19
			25	0	Left Cheek	704	0.135	2.25	22.5	21.78	0.159	/
			1	0	Left Tilt	704	0.098	-2.73	22.5	22.08	0.108	/
			25	0	Left Tilt	704	0.074	-1.90	22.5	21.78	0.087	/
LTE Band 17	10M	QPSK	1	0	Right Cheek	710	0.221	-0.78	20.4	20.2	0.231	/
			25	0	Right Cheek	709	0.214	1.82	20.4	20.14	0.227	/
			1	0	Right Tilt	710	0.085	2.55	20.4	20.2	0.089	/
			25	0	Right Tilt	709	0.102	-0.47	20.4	20.14	0.108	/
			1	0	Left Cheek	710	0.234	0.86	20.4	20.2	0.245	21
			25	0	Left Cheek	709	0.221	3.48	20.4	20.14	0.235	/
			1	0	Left Tilt	710	0.121	3.65	20.4	20.2	0.127	/
			25	0	Left Tilt	709	0.132	2.32	20.4	20.14	0.140	/
LTE Band 66	20M	QPSK	1	0	Right Cheek	1720	0.102	-1.88	22.5	22.48	0.102	/
			50	0	Right Cheek	1720	0.098	-2.30	22.5	22.18	0.105	/
			1	0	Right Tilt	1720	0.047	-2.28	22.5	22.48	0.047	/
			50	0	Right Tilt	1720	0.051	-3.06	22.5	22.18	0.055	/
			1	0	Left Cheek	1720	0.114	0.81	22.5	22.48	0.115	23
			50	0	Left Cheek	1720	0.099	-2.97	22.5	22.18	0.107	/
			1	0	Left Tilt	1720	0.052	-1.37	22.5	22.48	0.052	/
			50	0	Left Tilt	1720	0.048	-3.38	22.5	22.18	0.052	/



Band	Model	Test Position	Freq.	SAR (1g) (W/kg)	Power Drift(%)	Max.Turn-up Power(dBm)	Meas.Output Power(dBm)	Scaled SAR (W/Kg)	Meas.No.
2.4G WLAN	802.11b	Right Cheek	2437	0.547	1.99	19.00	18.68	0.589	25
		Right Tilt	2437	0.354	-1.45	19.00	18.68	0.381	/
		Left Cheek	2437	0.201	-3.89	19.00	18.68	0.216	/
		Left Tilt	2437	0.12	0.58	19.00	18.68	0.129	/
BT	GFSK	Right Cheek	2402	0.01	-2.07	8.00	7.92	0.010	/
		Right Tilt	2402	0.005	1.45	8.00	7.92	0.005	/
		Left Cheek	2402	0.031	3.03	8.00	7.92	0.032	27
		Left Tilt	2402	0.004	2.71	8.00	7.92	0.004	/
5.3G WLAN	802.11 n-HT20	Right Cheek	5300	0.048	2.79	11.00	10.54	0.053	/
		Right Tilt	5300	0.023	-0.55	11.00	10.54	0.026	/
		Left Cheek	5300	0.054	-1.97	11.00	10.54	0.060	29
		Left Tilt	5300	0.021	-0.88	11.00	10.54	0.023	/
5.6G WLAN	802.11 n-HT40	Right Cheek	5510	0.058	-0.40	10.00	9.43	0.066	/
		Right Tilt	5510	0.047	-2.10	10.00	9.43	0.054	/
		Left Cheek	5510	0.065	-2.38	10.00	9.43	0.074	31
		Left Tilt	5510	0.036	-1.87	10.00	9.43	0.041	/
5.8G WLAN	802.11 n-HT20	Right Cheek	5785	0.044	-2.15	9.00	8.38	0.051	/
		Right Tilt	5785	0.021	2.80	9.00	8.38	0.024	/
		Left Cheek	5785	0.055	-3.37	9.00	8.38	0.063	33
		Left Tilt	5785	0.032	3.37	9.00	8.38	0.037	/

Note:

1. Per KDB 447498 D04, the reported SAR is the measured SAR value adjusted for maximum tune-up tolerance.
 - a. Tune-up scaling Factor = tune-up limit power (mW) / EUT RF power (mW), where tune-up limit is the maximum rated power among all production units.
 - b. Scaled SAR(W/kg)= Measured SAR(W/kg)*Tune-up Scaling Factor
2. Per KDB 248227- When the highest reported SAR for DSSS is adjusted by the ratio of OFDM to DSSS specified maximum output power and the adjusted SAR is ≤ 1.2 W/kg. (The highest reported SAR for DSSS is adjusted by the ratio of OFDM to DSSS specified maximum output power was **0.198** W/Kg for Head)
3. Per KDB 865664 D01, Repeated measurement is not required when the original highest measured SAR is <0.80 W/kg



12.2 Body-worn and Hotspot SAR

Band	Model	Test Position	Freq.	SAR (1g) (W/kg)	Power Drift(%)	Max.Turn-up Power(dBm)	Meas.Output Power(dBm)	Scaled SAR (W/Kg)	Meas.No.
GSM850	GPRS Data-4 Slot	Front Side	824.2	0.152	0.52	29.50	29.19	0.163	/
		Back Side	824.2	0.319	-0.86	29.50	29.19	0.343	2
		Left Side	824.2	0.214	-0.26	29.50	29.19	0.230	/
		Right Side	824.2	0.223	3.00	29.50	29.19	0.239	/
		Bottom Side	824.2	0.125	2.69	29.50	29.19	0.134	/
GSM1900	GPRS Data-4 Slot	Front Side	1880	0.632	-2.93	28.00	27.53	0.704	4
		Back Side	1880	0.392	-1.43	28.00	27.53	0.437	/
		Left Side	1880	0.421	-1.63	28.00	27.53	0.469	/
		Right Side	1880	0.332	0.71	28.00	27.53	0.370	/
		Bottom Side	1880	0.256	0.08	28.00	27.53	0.285	/
WCDMA Band 2	RMC	Front Side	1852.4	0.767	-3.06	23.50	23.43	0.779	6
		Front Side	1880	0.556	-2.11	23.50	23.24	0.590	/
		Front Side	1907.6	0.564	2.58	23.50	23.11	0.617	/
		Back Side	1852.4	0.501	2.38	23.50	23.43	0.509	/
		Left Side	1852.4	0.414	-1.84	23.50	23.43	0.421	/
		Right Side	1852.4	0.420	3.07	23.50	23.43	0.427	/
		Bottom Side	1852.4	0.447	1.61	23.50	23.43	0.454	/
WCDMA Band 4	RMC	Front Side	1752.4	0.663	-1.27	23.00	22.82	0.691	8
		Back Side	1752.4	0.562	2.25	23.00	22.82	0.586	/
		Left Side	1752.4	0.365	-0.69	23.00	22.82	0.380	/
		Right Side	1752.4	0.314	0.16	23.00	22.82	0.327	/
		Bottom Side	1752.4	0.251	3.63	23.00	22.82	0.262	/
WCDMA Band 5	RMC	Front Side	836.6	0.504	1.98	24.00	23.77	0.531	10
		Back Side	836.6	0.412	3.29	24.00	23.77	0.434	/
		Left Side	836.6	0.325	-0.49	24.00	23.77	0.343	/
		Right Side	836.6	0.354	1.69	24.00	23.77	0.373	/
		Bottom Side	836.6	0.336	-0.44	24.00	23.77	0.354	/



Band	BW (MHz)	Mod.	RB Size	RB offset	Test Position	Freq.	Result 1g (W/Kg)	Power Drift(%)	Max. Turn-up Power(dBm)	Meas. Output Power(dBm)	Scaled SAR (W/Kg)	Meas.No.
LTE Band 2	20M	QPSK	1	0	Front side	1860	0.366	3.02	21.5	21.04	0.407	12
			50	0	Front side	1860	0.325	-1.11	21.5	20.78	0.384	/
			1	0	Back Side	1860	0.223	-1.61	21.5	21.04	0.248	/
			50	0	Back Side	1860	0.214	3.63	21.5	20.78	0.253	/
			1	0	Left Side	1860	0.124	-0.24	21.5	21.04	0.138	/
			50	0	Left Side	1860	0.135	0.91	21.5	20.78	0.159	/
			1	0	Right Side	1860	0.114	-3.44	21.5	21.04	0.127	/
			50	0	Right Side	1860	0.111	-3.99	21.5	20.78	0.131	/
			1	0	Bottom Side	1860	0.133	1.80	21.5	21.04	0.148	/
			50	0	Bottom Side	1860	0.158	0.00	21.5	20.78	0.186	/
LTE Band 4	20M	QPSK	1	0	Front side	1720	0.298	-2.54	22.5	22.05	0.331	14
			50	0	Front side	1745	0.254	-2.64	22.5	21.87	0.294	/
			1	0	Back Side	1720	0.212	-2.91	22.5	22.05	0.235	/
			50	0	Back Side	1745	0.195	-1.26	22.5	21.87	0.225	/
			1	0	Left Side	1720	0.142	-1.63	22.5	22.05	0.158	/
			50	0	Left Side	1745	0.135	-1.97	22.5	21.87	0.156	/
			1	0	Right Side	1720	0.147	-3.29	22.5	22.05	0.163	/
			50	0	Right Side	1745	0.136	-3.37	22.5	21.87	0.157	/
			1	0	Bottom Side	1720	0.125	1.15	22.5	22.05	0.139	/
			50	0	Bottom Side	1745	0.128	3.82	22.5	21.87	0.148	/
LTE Band 5	10M	QPSK	1	0	Front side	836.5	0.185	0.83	23.5	23.18	0.199	/
			25	0	Front side	836.5	0.174	2.25	23.5	23.01	0.195	/
			1	0	Back Side	836.5	0.272	-2.55	23.5	23.18	0.293	16
			25	0	Back Side	836.5	0.241	3.88	23.5	23.01	0.270	/
			1	0	Left Side	836.5	0.154	-3.76	23.5	23.18	0.166	/
			25	0	Left Side	836.5	0.125	3.91	23.5	23.01	0.140	/
			1	0	Right Side	836.5	0.145	-0.90	23.5	23.18	0.156	/
			25	0	Right Side	836.5	0.132	-0.87	23.5	23.01	0.148	/
			1	0	Bottom Side	836.5	0.147	0.74	23.5	23.18	0.158	/
			25	0	Bottom Side	836.5	0.136	-0.09	23.5	23.01	0.152	/
LTE Band 7	10M	QPSK	1	0	Front side	2560	0.058	3.18	21	20.62	0.063	18
			50	0	Front side	2560	0.047	-2.83	21	20.39	0.054	/
			1	0	Back Side	2560	0.055	1.08	21	20.62	0.060	/
			50	0	Back Side	2560	0.042	-2.55	21	20.39	0.048	/
			1	0	Left Side	2560	0.032	3.00	21	20.62	0.035	/



			50	0	Left Side	2560	0.036	3.88	21	20.39	0.041	/
			1	0	Right Side	2560	0.025	-2.62	21	20.62	0.027	/
			50	0	Right Side	2560	0.021	3.42	21	20.39	0.024	/
			1	0	Bottom Side	2560	0.026	-0.16	21	20.62	0.028	/
			50	0	Bottom Side	2560	0.027	-1.29	21	20.39	0.031	/
LTE Band 12	10M	QPSK	1	0	Front side	704	0.228	0.53	22.5	22.08	0.251	/
			25	0	Front side	704	0.214	-2.91	22.5	21.78	0.253	/
			1	0	Back Side	704	0.366	0.65	22.5	22.08	0.403	20
			25	0	Back Side	704	0.341	2.48	22.5	21.78	0.402	/
			1	0	Left Side	704	0.254	-2.89	22.5	22.08	0.280	/
			25	0	Left Side	704	0.232	-1.11	22.5	21.78	0.274	/
			1	0	Right Side	704	0.214	3.84	22.5	22.08	0.236	/
			25	0	Right Side	704	0.198	0.46	22.5	21.78	0.234	/
			1	0	Bottom Side	704	0.185	-0.89	22.5	22.08	0.204	/
			25	0	Bottom Side	704	0.142	2.53	22.5	21.78	0.168	/
LTE Band 17	10M	QPSK	1	0	Front side	710	0.325	-3.40	20.4	20.2	0.340	/
			25	0	Front side	709	0.332	3.66	20.4	20.14	0.352	/
			1	0	Back Side	710	0.353	0.65	20.4	20.2	0.370	22
			25	0	Back Side	709	0.341	-2.34	20.4	20.14	0.362	/
			1	0	Left Side	710	0.156	-0.84	20.4	20.2	0.163	/
			25	0	Left Side	709	0.174	1.62	20.4	20.14	0.185	/
			1	0	Right Side	710	0.158	2.73	20.4	20.2	0.165	/
			25	0	Right Side	709	0.135	0.90	20.4	20.14	0.143	/
			1	0	Bottom Side	710	0.145	-3.99	20.4	20.2	0.152	/
			25	0	Bottom Side	709	0.125	-2.99	20.4	20.14	0.133	/
LTE Band 66	20M	QPSK	1	0	Front side	1720	0.295	3.57	22.5	22.48	0.296	24
			50	0	Front side	1720	0.257	-1.55	22.5	22.18	0.277	/
			1	0	Back Side	1720	0.226	1.96	22.5	22.48	0.227	/
			50	0	Back Side	1720	0.254	2.50	22.5	22.18	0.273	/
			1	0	Left Side	1720	0.125	3.93	22.5	22.48	0.126	/
			50	0	Left Side	1720	0.132	1.64	22.5	22.18	0.142	/
			1	0	Right Side	1720	0.145	3.97	22.5	22.48	0.146	/
			50	0	Right Side	1720	0.136	-0.04	22.5	22.18	0.146	/
			1	0	Bottom Side	1720	0.158	0.38	22.5	22.48	0.159	/
			50	0	Bottom Side	1720	0.147	1.74	22.5	22.18	0.158	/



Band	Model	Test Position	Freq.	SAR (1g) (W/kg)	Power Drift(%)	Max.Turn-up Power(dBm)	Meas.Output Power(dBm)	Scaled SAR (W/Kg)	Meas.No.
2.4GHz WLAN	802.11b	Front Side	2437	0.219	2.30	19.00	18.68	0.236	/
		Back Side	2437	0.23	-2.12	19.00	18.68	0.248	26
		Left Side	2437	0.154	-0.15	19.00	18.68	0.166	/
		Right Side	2437	0.132	3.70	19.00	18.68	0.142	/
		Top Side	2437	0.122	-1.65	19.00	18.68	0.131	/
BT	GFSK	Front Side	2402	0.041	-2.06	8.00	7.92	0.042	28
		Back Side	2402	0.013	-2.80	8.00	7.92	0.013	/
		Top Side	2402	0.011	-3.69	8.00	7.92	0.011	/
5.3GHz WLAN	802.11 n-HT20	Front Side	5300	0.049	-3.79	11.00	10.54	0.054	30
		Back Side	5300	0.048	3.55	11.00	10.54	0.053	/
		Right Side	5300	0.025	-3.92	11.00	10.54	0.028	/
		Top Side	5300	0.021	-0.26	11.00	10.54	0.023	/
		Bottom Side	5300	0.032	2.80	11.00	10.54	0.036	/
5.6GHz WLAN	802.11 n-HT40	Front Side	5510	0.038	-0.34	10.00	9.43	0.043	/
		Back Side	5510	0.063	-1.35	10.00	9.43	0.072	32
		Right Side	5510	0.042	2.91	10.00	9.43	0.048	/
		Top Side	5510	0.041	-2.63	10.00	9.43	0.047	/
		Bottom Side	5510	0.035	-0.33	10.00	9.43	0.040	/
5.8GHz WLAN	802.11 n-HT20	Front Side	5785	0.041	3.81	9.00	8.38	0.047	/
		Back Side	5785	0.048	3.94	9.00	8.38	0.055	34
		Right Side	5785	0.035	-1.86	9.00	8.38	0.040	/
		Top Side	5785	0.036	-0.89	9.00	8.38	0.042	/
		Bottom Side	5785	0.041	-3.87	9.00	8.38	0.047	/

Note:

- The test separation of all above table is 10mm.
- Per KDB 447498 D04, the reported SAR is the measured SAR value adjusted for maximum tune-up tolerance.
 - Tune-up scaling Factor = tune-up limit power (mW) / EUT RF power (mW), where tune-up limit is the maximum rated power among all production units.
 - Scaled SAR(W/kg)= Measured SAR(W/kg)*Tune-up Scaling Factor
- Per KDB 248227- When the highest reported SAR for DSSS is adjusted by the ratio of OFDM to DSSS specified maximum output power and the adjusted SAR is ≤ 1.2 W/kg. (The highest reported SAR for DSSS is adjusted by the ratio of OFDM to DSSS specified maximum output power was **0.006** W/Kg for Body)
- When the user enables the personal Wireless router functions for the handsets, actual operations include simultaneous transmission of both the Wi-Fi transmitting frequency and thus cannot be evaluated for SAR under actual use conditions. The "Portable Hotspot" feature on the handset was NOT activated, to ensure the SAR measurements were evaluated for a single transmission frequency RF signal.

**Simultaneous Multi-band Transmission Evaluation:**

Application Simultaneous Transmission information:

Position	Simultaneous State
Head	1. GSM + 2.4GHz WLAN/5G WLAN
	2. GSM + Bluetooth
	3. WCDMA + 2.4GHz WLAN/5G WLAN
	4. WCDMA + Bluetooth
	5. LTE + 2.4GHz WLAN/5G WLAN
	6. LTE + Bluetooth
Body	1. GSM + 2.4GHz WLAN/5G WLAN
	2. GSM + Bluetooth
	3. WCDMA + 2.4GHz WLAN/5G WLAN
	4. WCDMA + Bluetooth
	5. LTE + 2.4GHz WLAN/5G WLAN
	6. LTE + Bluetooth

NOTE:

1. Bluetooth and WLAN can't simultaneous transmission at the same time.
2. For simultaneous transmission at head and body exposure position, 2 transmitters simultaneous transmission was the worst state.
3. If the test separation distance is <5mm, 5mm is used for excluded SAR calculation.
4. KDB 447498 Appendix E, when standalone SAR test exclusion applies to an antenna that transmits simultaneously with other antennas, the standalone SAR must be estimated according to following to determine simultaneous transmission SAR test exclusion:
 $SAR_{est} = 1.6 \cdot P_{ant} / P_{th}$ [W/kg].
 P_{ant} is maximum time-averaged power or effective radiated power (ERP), whichever is greater, and P_{th} is defined in Formula KDB 447498 (B.2).



Simultaneous Mode	Position	Mode	Max. 1-g SAR	1-g Sum SAR
			(W/kg)	(W/kg)
GSM + 2.4G WLAN	Head	GSM	0.794	1.383
		2.4G WLAN	0.589	
	Body	GSM	0.704	0.952
		2.4G WLAN	0.248	
GSM + Bluetooth	Head	GSM	0.794	0.826
		Bluetooth	0.032	
	Body	GSM	0.704	0.746
		Bluetooth	0.042	
GSM + 5G WLAN	Head	GSM	0.794	0.869
		5G WLAN	0.074	
	Body	GSM	0.704	0.776
		5G WLAN	0.072	
WCDMA + 2.4G WLAN	Head	WCDMA	0.773	1.362
		2.4G WLAN	0.589	
	Body	WCDMA	0.779	1.027
		2.4G WLAN	0.248	
WCDMA + Bluetooth	Head	WCDMA	0.773	0.804
		Bluetooth	0.032	
	Body	WCDMA	0.779	0.821
		Bluetooth	0.042	
WCDMA + 5G WLAN	Head	WCDMA	0.773	0.847
		5G WLAN	0.074	
	Body	WCDMA	0.779	0.851
		5G WLAN	0.072	
LTE + 2.4G WLAN	Head	LTE	0.271	0.860
		2.4G WLAN	0.589	
	Body	LTE	0.407	0.654
		2.4G WLAN	0.248	
LTE + Bluetooth	Head	LTE	0.271	0.303
		Bluetooth	0.032	
	Body	LTE	0.407	0.449
		Bluetooth	0.042	



LTE + 5G WLAN	Head	LTE	0.271	0.345
		5G WLAN	0.074	
	Body	LTE	0.407	0.479
		5G WLAN	0.072	

Simultaneous transmission SAR test exclusion is determined for each operating configuration and exposure condition according to the reported standalone SAR of each applicable simultaneous transmitting antenna.

When the sum of SAR 1g of all simultaneously transmitting antennas in an operating mode and exposure condition combination is within the SAR limit (SAR-1g 1.6 W/kg), the simultaneous transmission SAR is not required. When the sum of SAR 1g is greater than the SAR limit (SAR-1g 1.6 W/kg), SAR test exclusion is determined by the SPLSR.





13. Equipment List

Kind of Equipment	Manufacturer	Type No.	Serial No.	Last Calibration	Calibrated Until
750MHz Dipole	MVG	SID750	SN 30/14 DIP0G750-331	2020.07.14	2023.07.13
835MHz Dipole	MVG	SID835	SN 30/14 DIP0G835-332	2020.07.14	2023.07.13
1800MHz Dipole	MVG	SID1800	SN 30/14 DIP1G800-329	2020.07.14	2023.07.13
1900MHz Dipole	MVG	SID1900	SN 30/14 DIP1G900-333	2020.07.14	2023.07.13
2450MHz Dipole	MVG	SID2450	SN 30/14 DIP2G450-335	2020.07.14	2023.07.13
2600MHz Dipole	MVG	SID2600	SN 30/14 DIP2G600-336	2020.07.14	2023.07.13
Waveguide	MVG	SWG5500	SN 13/14 WGA32	2020.07.14	2023.07.13
E-Field Probe	MVG	SSE2	SN 07/21 EPMO352	2022.02.28	2023.02.27
Dielectric Probe Kit	MVG	SCLMP	SN 32/14 OCPG67	2021.11.23	2022.11.22
Antenna	MVG	ANTA3	SN 07/13 ZNTA52	N/A	N/A
Phantom1	MVG	SAM	SN 32/14 SAM115	N/A	N/A
Phantom2	MVG	SAM	SN 32/14 SAM116	N/A	N/A
Phone holder	MVG	N/A	SN 32/14 MSH97	N/A	N/A
Laptop holder	MVG	N/A	SN 32/14 LSH29	N/A	N/A
Attenuator	Agilent	99899	DC-18GHz	N/A	N/A
Directional coupler	Narda	4226-20	3305	N/A	N/A
Network Analyzer	Agilent	8753ES	US38432810	2021.09.29	2022.09.28
Multi Meter	Keithley	Multi Meter 2000	4050073	2021.10.08	2022.10.07
Signal Generator	Agilent	N5182A	MY50140530	2021.09.30	2022.09.29
Wireless Communication Test Set	Agilent	8960-E5515C	MY48360751	2021.09.30	2022.09.29
Wireless Communication Test Set	R&S	CMW500	117239	2021.09.30	2022.09.29
Power Amplifier	DESAY	ZHL-42W	9638	2021.10.09	2022.10.08
Power Meter	R&S	NRP	100510	2021.09.29	2022.09.28
Power Sensor	R&S	NRP-Z11	101919	2021.09.29	2022.09.28
Temperature hygrometer	SuWei	SW-108	N/A	2021.10.09	2022.10.08
Thermograph	Elitech	RC-4	S/N EF7176501537	2021.10.09	2022.10.08

Appendix A. System Validation Plots

System Performance Check Data (750MHz)

Type: Phone measurement (Complete)

Area scan resolution: dx=8mm, dy=8mm

Zoom scan resolution: dx=8mm, dy=8mm, dz=5mm

Date of measurement: 2022-02-15

Experimental conditions

Phantom	Validation plane
Device Position	-
Band	750MHz
Channels	-
Signal	CW
Frequency (MHz)	750MHz
Relative permittivity	42.77
Conductivity (S/m)	0.95
Probe	SN 07/21 EPGO352
ConvF	1.58
Crest factor	1:1

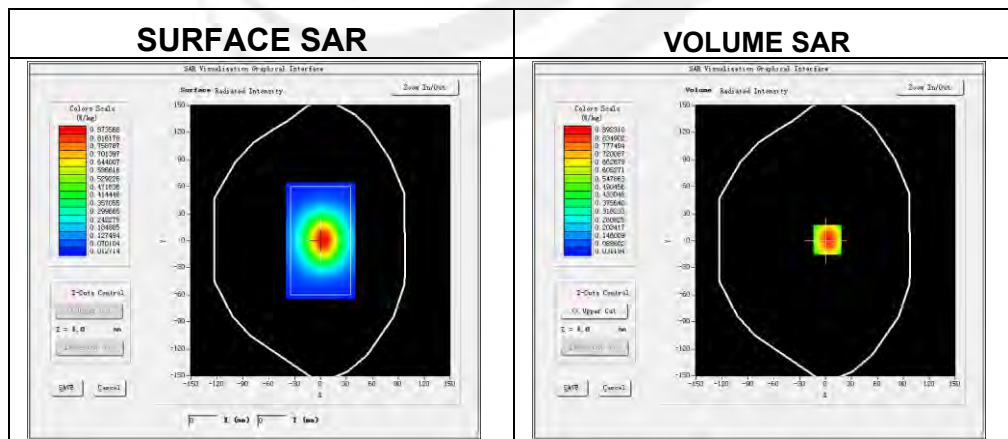

Maximum location: X=2.00, Y=1.00

SAR 10g (W/Kg)	0.544147
SAR 1g (W/Kg)	0.843605

Z Axis Scan

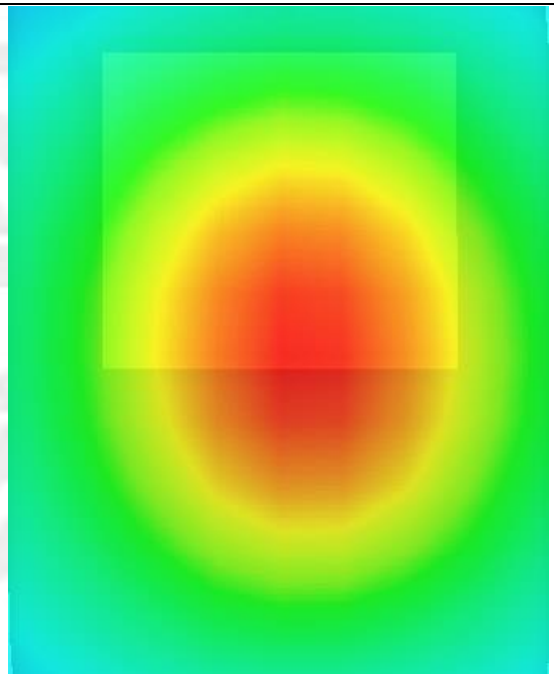
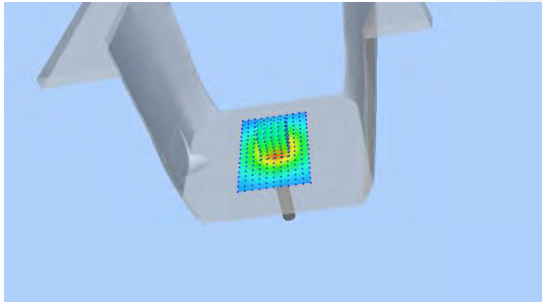
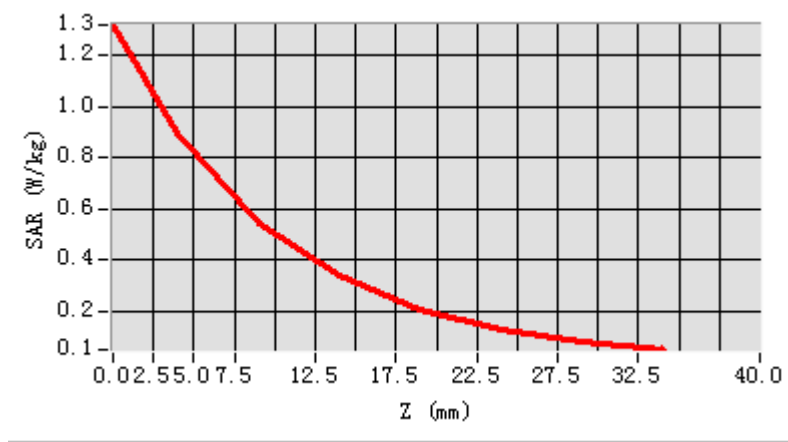

System Performance Check Data (835MHz)

Type: Phone measurement (Complete)

Area scan resolution: dx=8mm, dy=8mm

Zoom scan resolution: dx=8mm, dy=8mm, dz=5mm

Date of measurement: 2022-02-16

Experimental conditions

Phantom	Validation plane
Device Position	-
Band	835MHz
Channels	-
Signal	CW
Frequency (MHz)	835MHz
Relative permittivity	40.85
Conductivity (S/m)	0.93
Probe	SN 07/21 EPG0352
ConvF:	1.57
Crest factor:	1:1

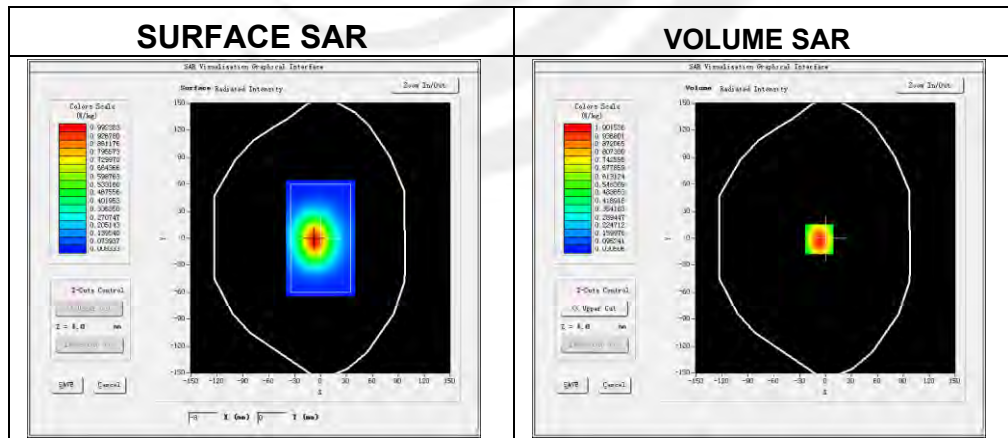

Maximum location: X=-7.00, Y=-1.00

SAR 10g (W/Kg)	0.630364
SAR 1g (W/Kg)	0.982854

Z Axis Scan

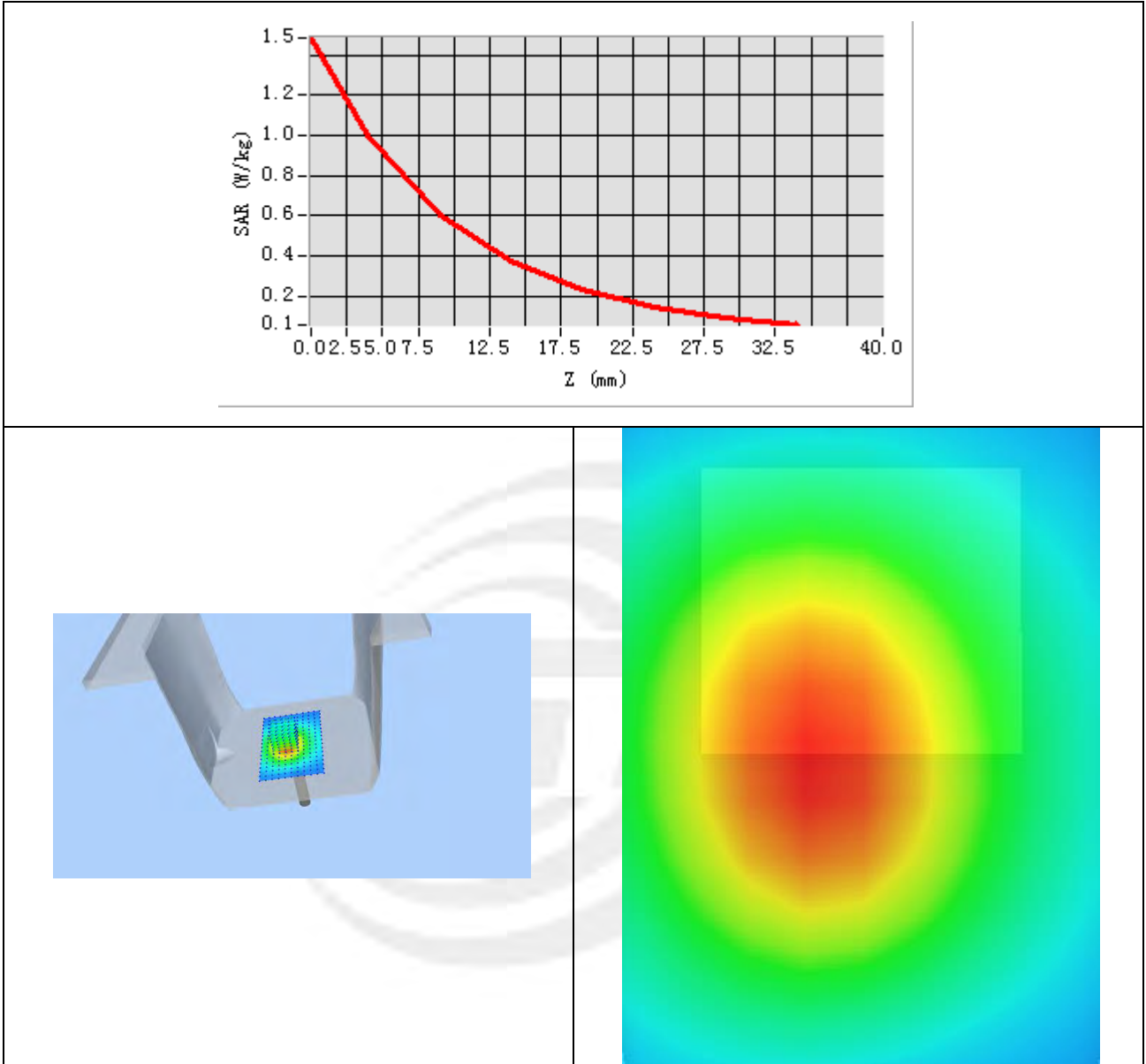

System Performance Check Data(1800MHz)

Type: Phone measurement (Complete)
 Area scan resolution: dx=8mm, dy=8mm
 Zoom scan resolution: dx=8mm, dy=8mm, dz=5mm
 Date of measurement: 2022-02-18

Experimental conditions.

Phantom	Validation plane
Device Position	-
Band	1800MHz
Channels	-
Signal	CW
Frequency (MHz)	1800MHz
Relative permittivity	40.04
Conductivity (S/m)	1.41
Probe	SN 07/21 EPGO352
ConvF	1.60
Crest factor:	1:1

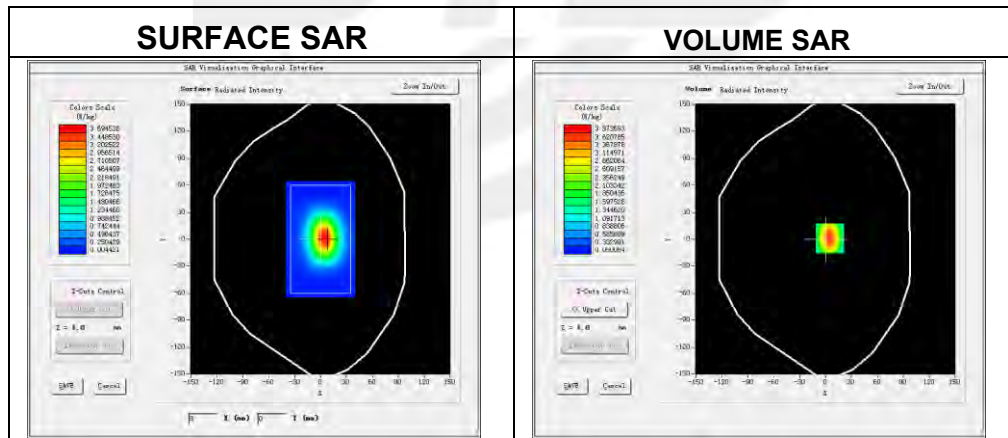

Maximum location: X=5.00, Y=1.00

SAR 10g (W/Kg)	2.024738
SAR 1g (W/Kg)	3.814203

Z Axis Scan

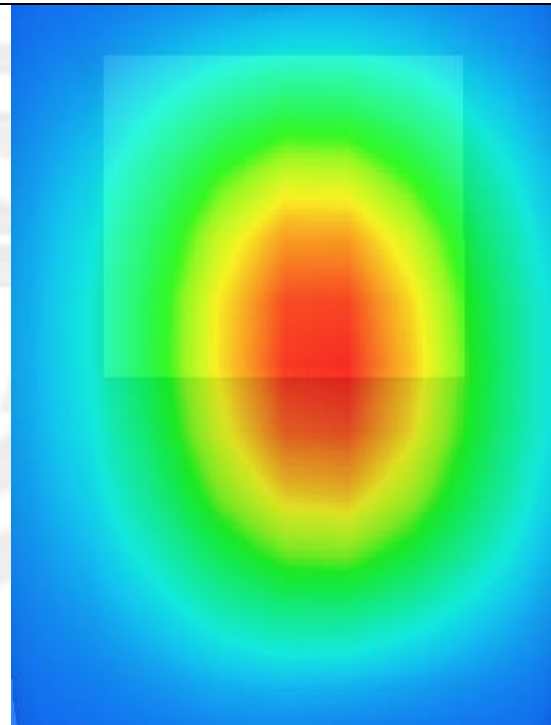
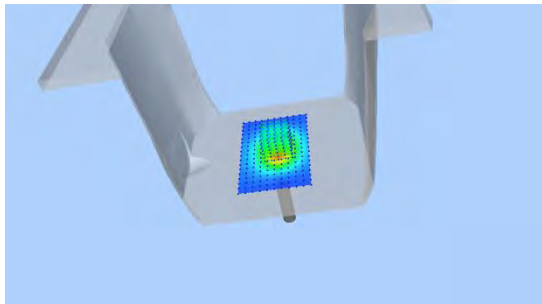
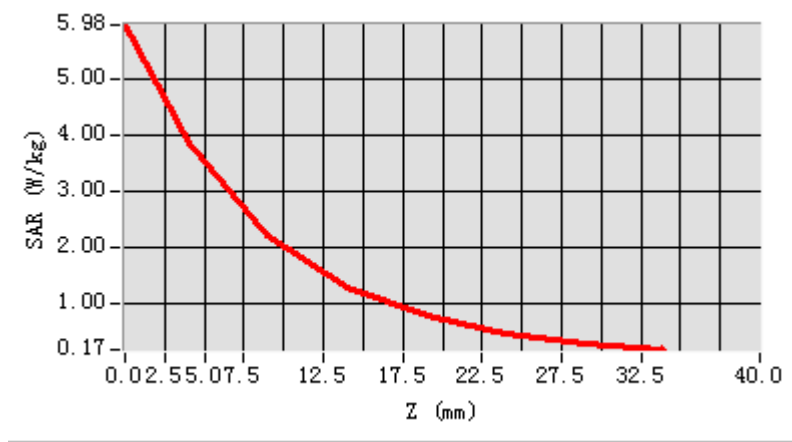



System Performance Check Data (1900MHz)

Type: Phone measurement (Complete)
 Area scan resolution: dx=8mm, dy=8mm
 Zoom scan resolution: dx=8mm, dy=8mm, dz=5mm
 Date of measurement: 2022-02-21

Experimental conditions.

Phantom	Validation plane
Device Position	-
Band	1900MHz
Channels	-
Signal	CW
Frequency (MHz)	1900MHz
Relative permittivity	41.06
Conductivity (S/m)	1.37
Probe	SN 07/21 EPGO352
ConvF:	1.78
Crest factor:	1:1

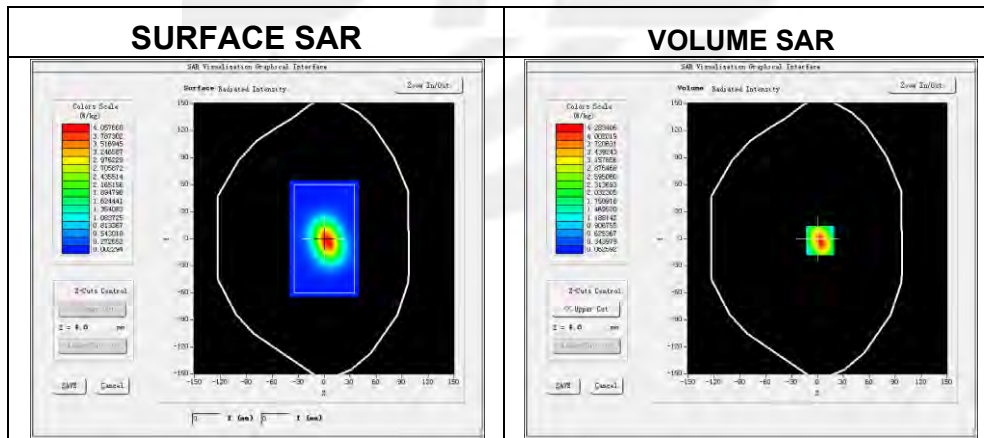

Maximum location: X=3.00, Y=-2.00

SAR 10g (W/Kg)	2.044227
SAR 1g (W/Kg)	3.991846

Z Axis Scan

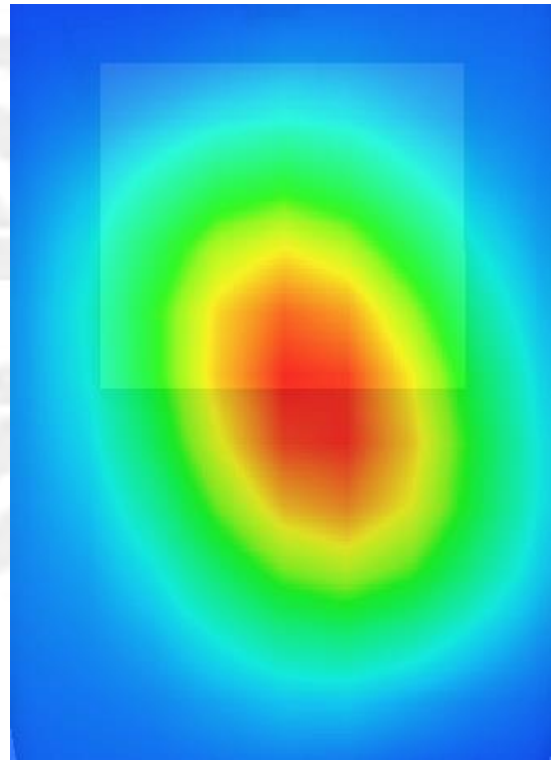
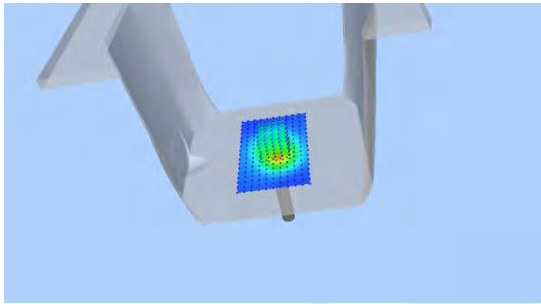
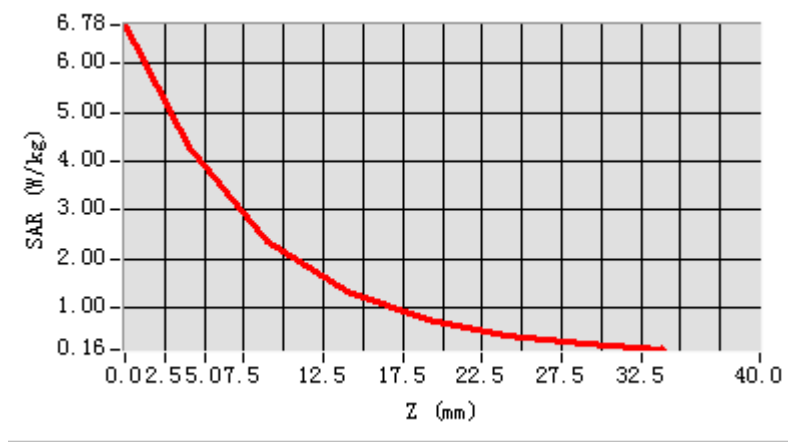

System Performance Check Data (2450MHz)

Type: Phone measurement (Complete)
 Area scan resolution: dx=8mm, dy=8mm
 Zoom scan resolution: dx=8mm, dy=8mm, dz=5mm
 Date of measurement: 2022-02-23

Experimental conditions.

Device Position	Validation plane
Band	2450 MHz
Channels	-
Signal	CW
Frequency (MHz)	2450
Relative permittivity	39.38
Conductivity (S/m)	1.83
Probe	SN 07/21 EPGO352
ConvF	1.75
Crest factor:	1:1

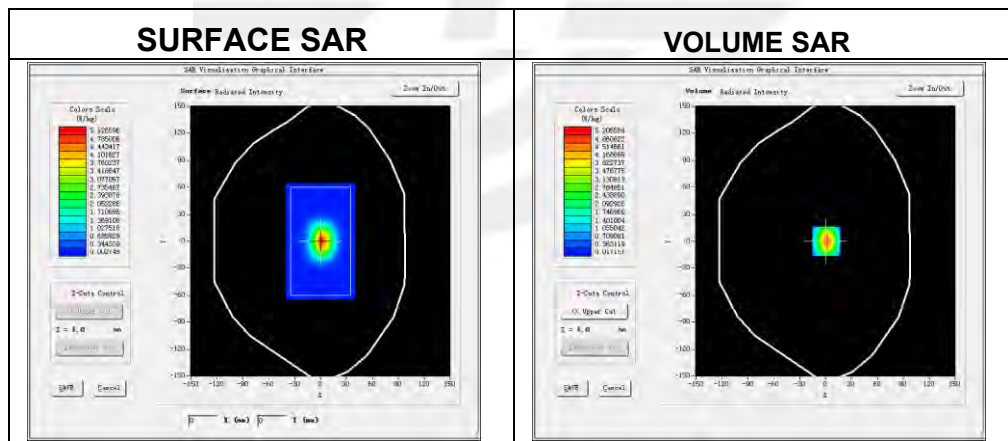

Maximum location: X=1.00, Y=0.00

SAR 10g (W/Kg)	2.387625
SAR 1g (W/Kg)	5.255114

Z Axis Scan

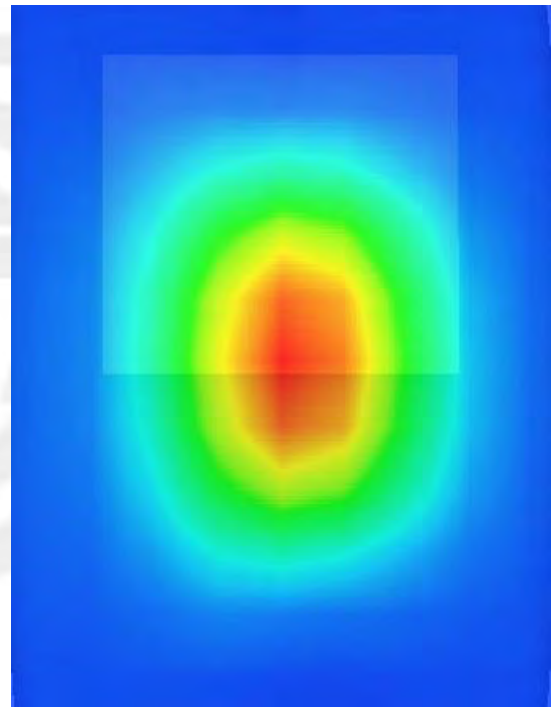
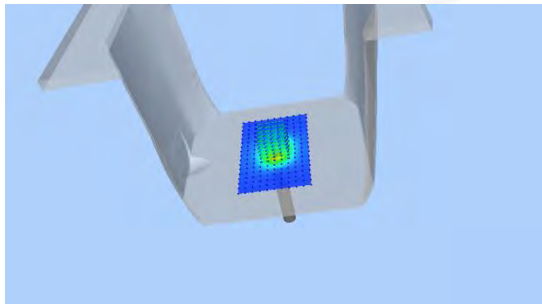
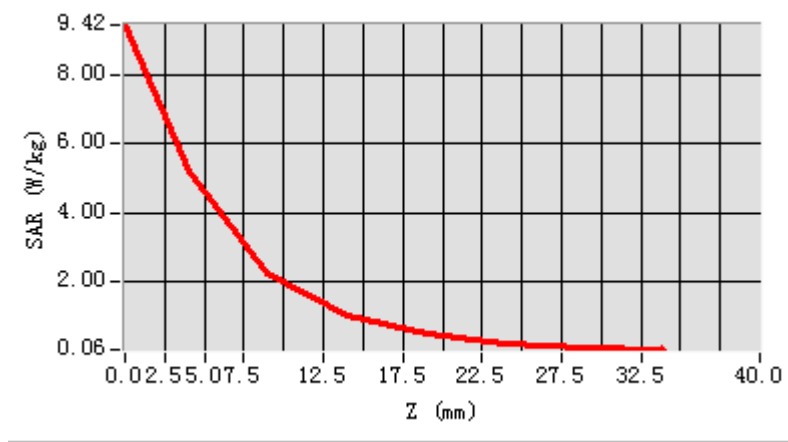

System Performance Check Data(2600MHz)

Type: Phone measurement (Complete)

Area scan resolution: dx=8mm,dy=8mm

Zoom scan resolution: dx=8mm, dy=8mm, dz=5mm

Date of measurement: 2022-02-23

Experimental conditions.

Device Position	Validation plane
Band	2600 MHz
Channels	-
Signal	CW
Frequency (MHz)	2600
Relative permittivity	38.31
Conductivity (S/m)	1.89
Probe	SN 07/21 EPGO352
ConvF	1.63
Crest factor:	1:1

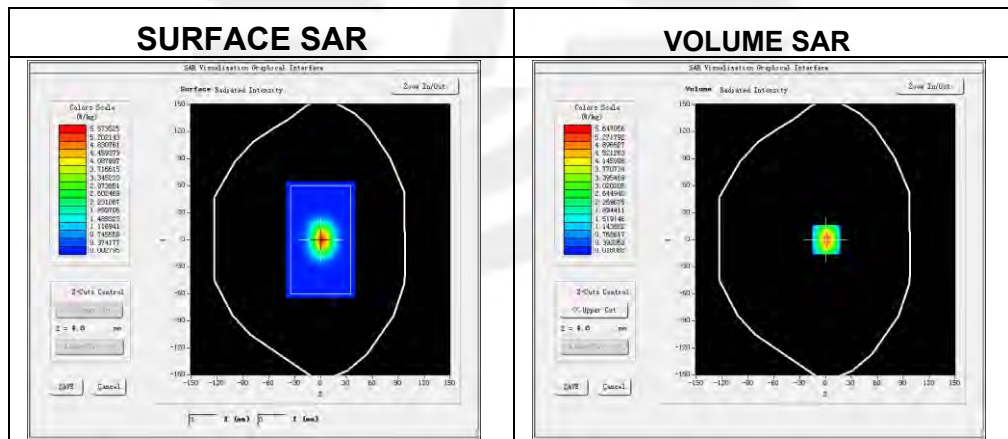

Maximum location: X=1.00, Y=0.00

SAR 10g (W/Kg)	2.502584
SAR 1g (W/Kg)	5.553925

Z Axis Scan

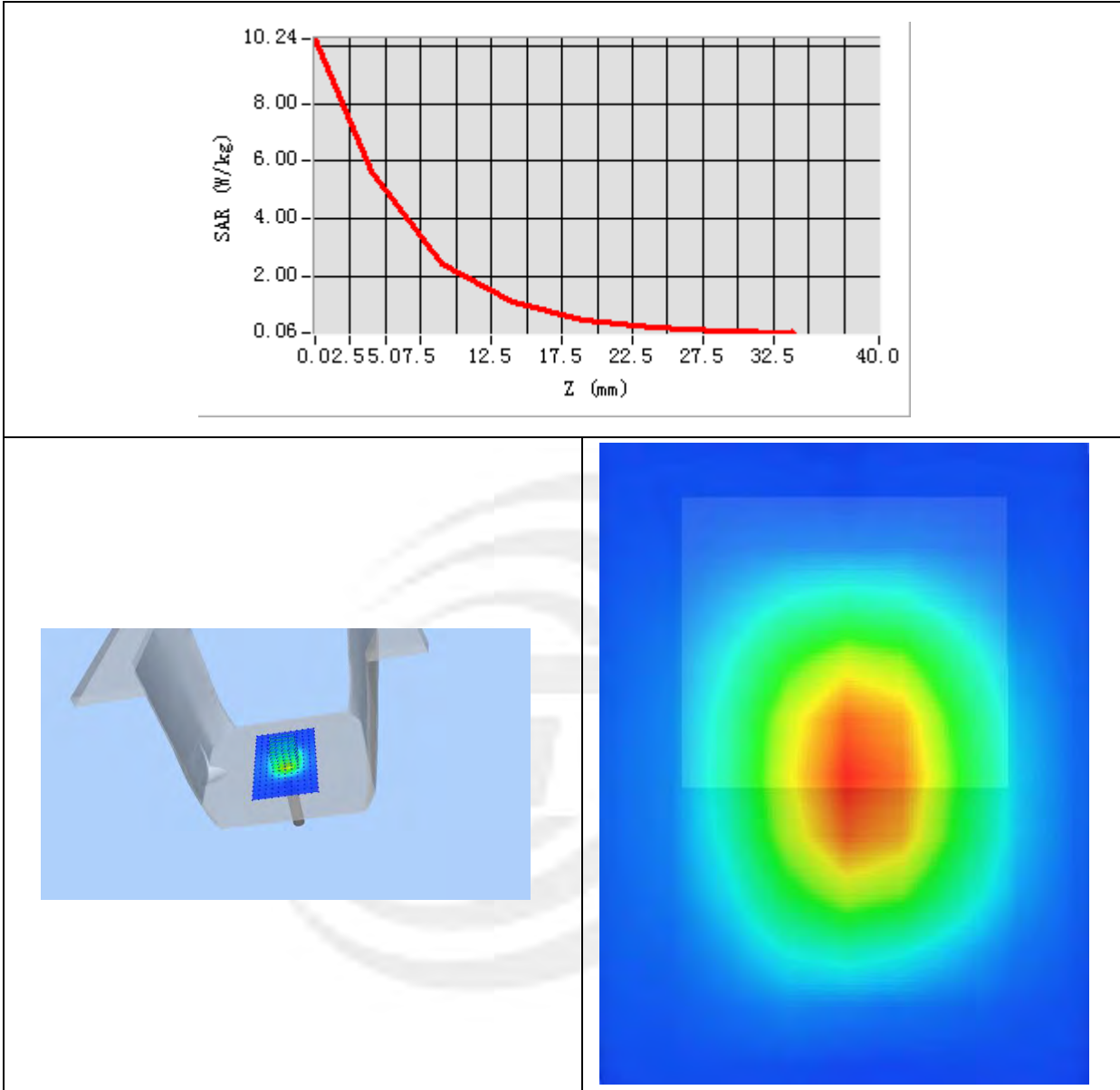

System Performance Check Data (5300MHz)

Type: Dipole measurement (Complete)

Area scan resolution: dx=8mm,dy=8mm

Zoom scan resolution: dx=4mm, dy=4mm, dz=2mm

Date of measurement: 2022-03-02

Experimental conditions.

Device Position	Validation plane
Band	5300 MHz
Channels	-
Signal	CW
Frequency (MHz)	5300
Relative permittivity	35.06
Conductivity (S/m)	4.70
Probe	SN 07/21 EPGO352
ConvF	1.65
Crest factor:	1:1

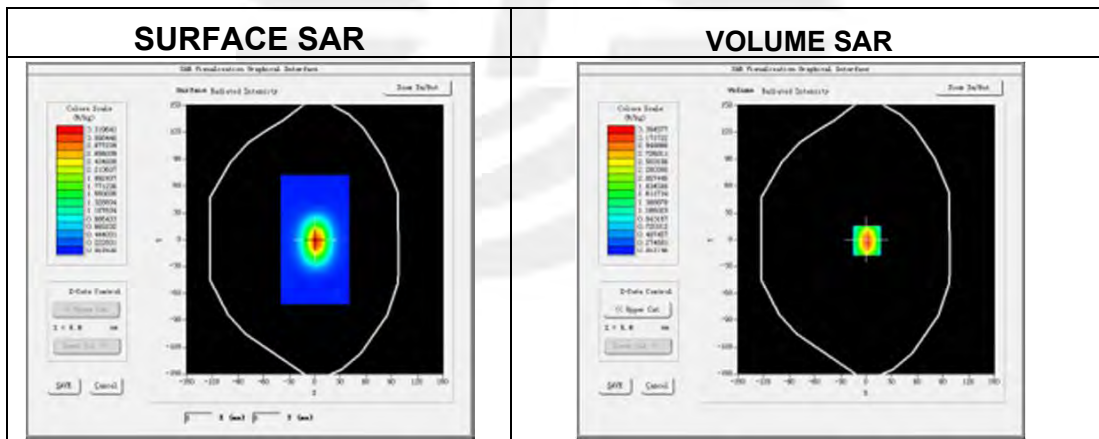

Maximum location: X=7.00, Y=2.00

SAR 10g (W/Kg)	6.156106
SAR 1g (W/Kg)	16.639738

Z Axis Scan

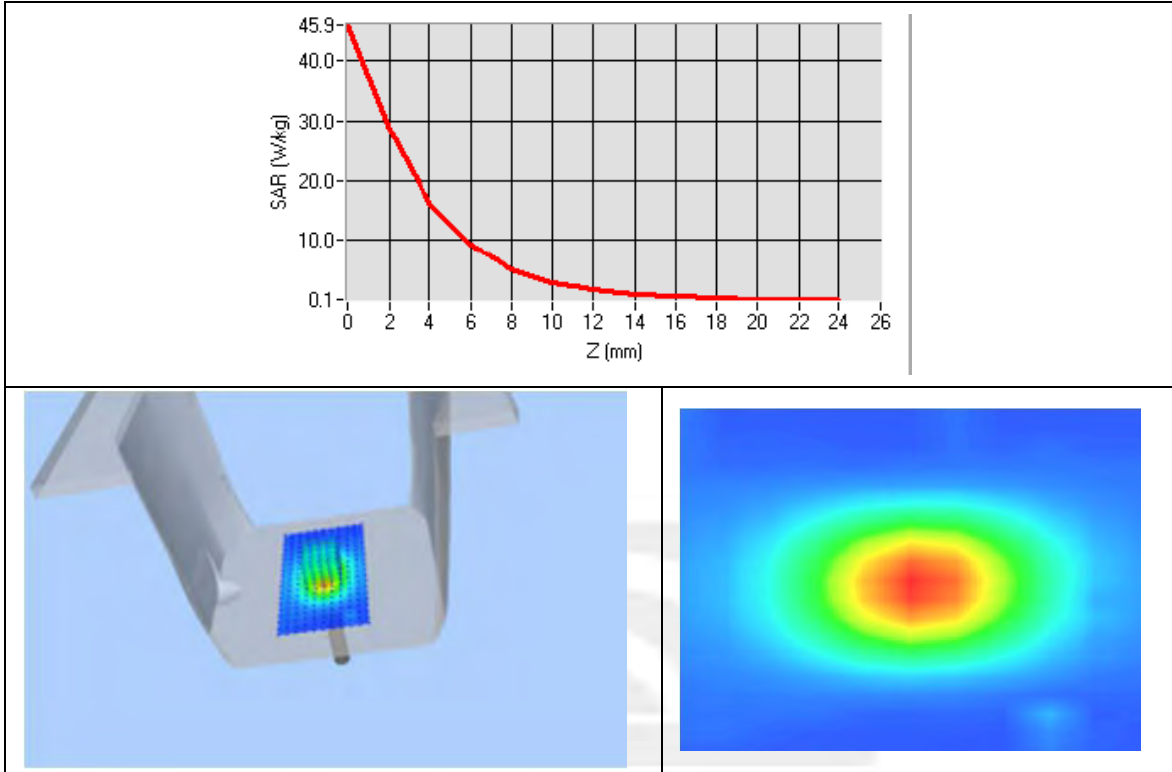

System Performance Check Data (5600MHz)

Type: Dipole measurement (Complete)

Area scan resolution: dx=8mm,dy=8mm

Zoom scan resolution: dx=8mm, dy=8mm, dz=5mm

Date of measurement: 2022-03-02

Experimental conditions.

Device Position	Validation plane
Band	5600 MHz
Channels	-
Signal	CW
Frequency (MHz)	5600
Relative permittivity	36.08
Conductivity (S/m)	5.04
Probe	SN 07/21 EPGO352
ConvF	1.64
Crest factor:	1:1

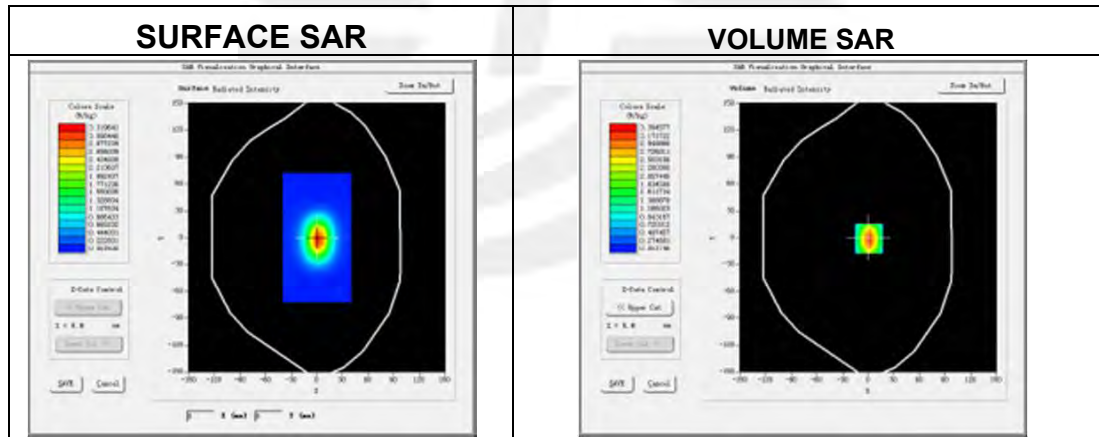

Maximum location: X=7.00, Y=2.00

SAR 10g (W/Kg)	5.682373
SAR 1g (W/Kg)	17.374169

Z Axis Scan

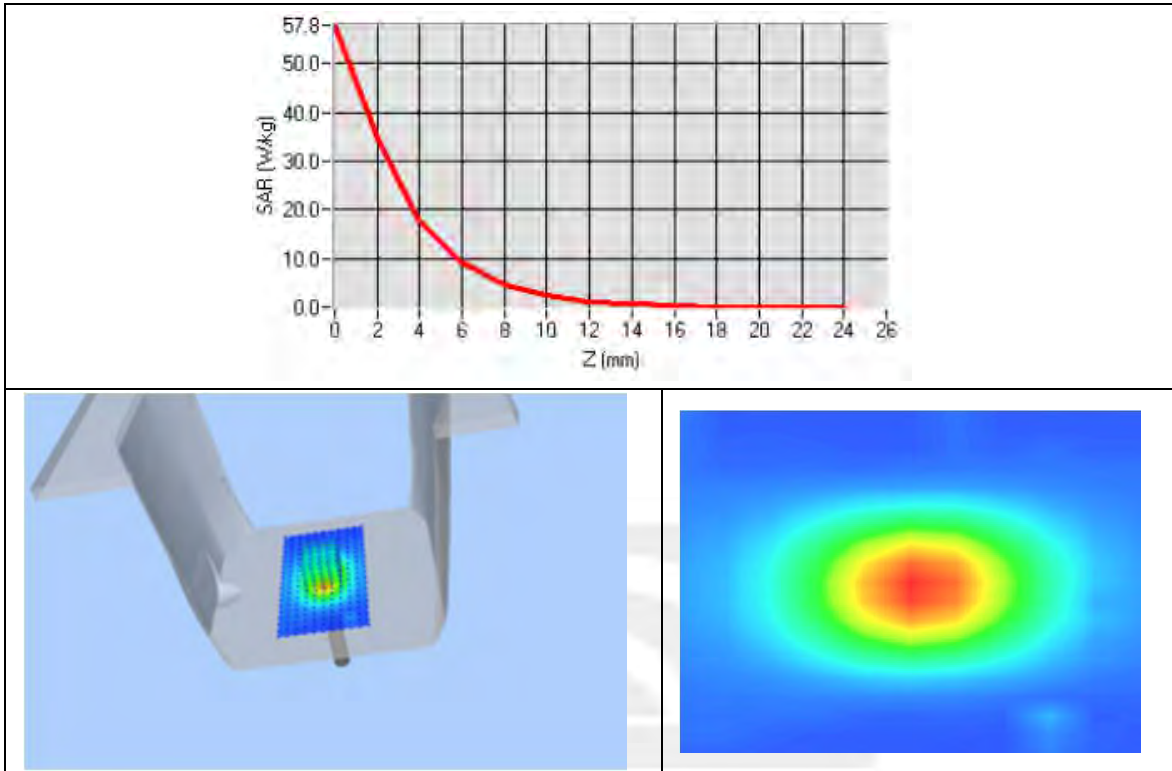

System Performance Check Data (5800MHz)

Type: Dipole measurement (Complete)

Area scan resolution: dx=8mm,dy=8mm

Zoom scan resolution: dx=8mm, dy=8mm, dz=5mm

Date of measurement: 2022-03-02

Experimental conditions.

Device Position	Validation plane
Band	5800 MHz
Channels	-
Signal	CW
Frequency (MHz)	5800
Relative permittivity	36.37
Conductivity (S/m)	5.31
Probe	SN 07/21 EPGO352
ConvF	1.64
Crest factor:	1:1

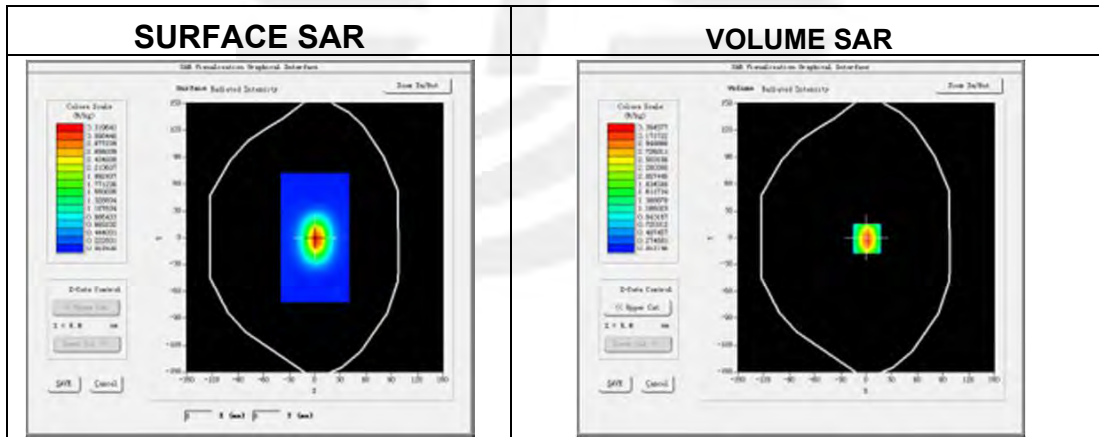

Maximum location: X=7.00, Y=2.00

SAR 10g (W/Kg)	6.115380
SAR 1g (W/Kg)	18.122185

Z Axis Scan

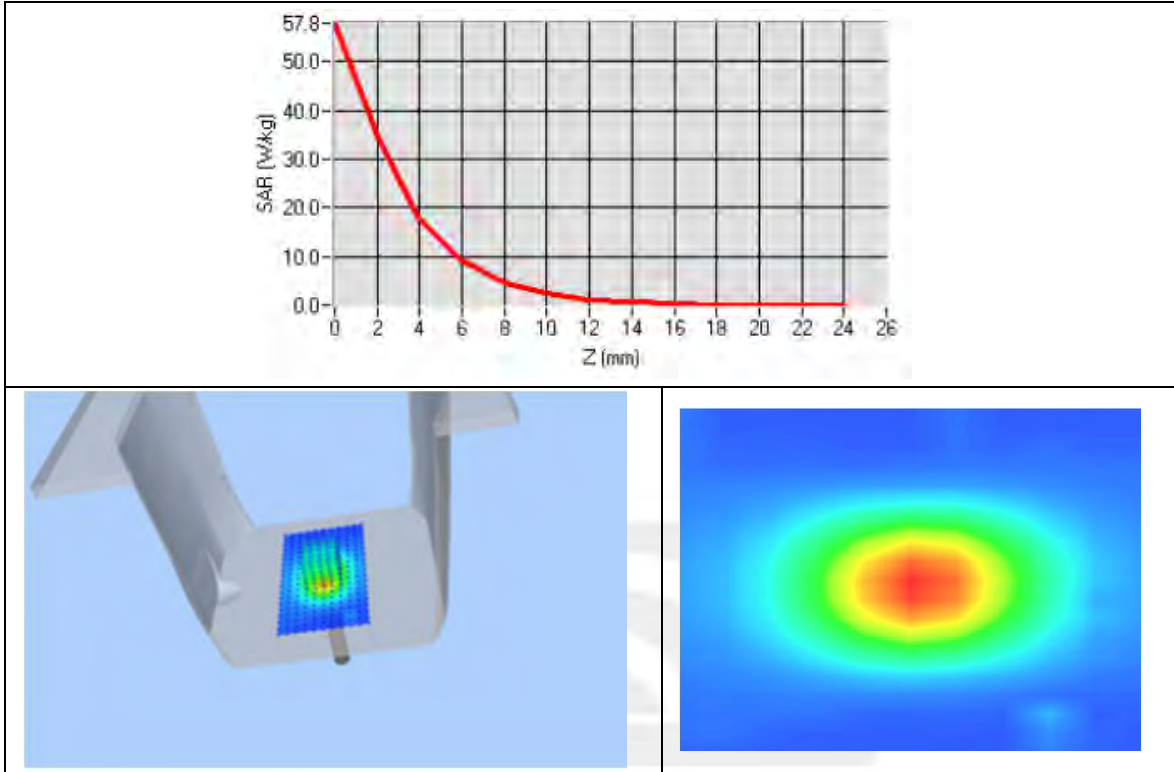

Appendix B. SAR Test Plots

Plot 1: DUT: Mobile Phone; EUT Model: STUDIO X5 MAX

Test Date	2022-02-16
Probe	SN 07/21 EPGO352
Area Scan	dx=8mm, dy=8mm, h= 5.00 mm
Zoom Scan	5x5x7, dx=8mm, dy=8mm, dz=5mm, Complete/ndx=8mm, dy=8mm, h= 5.00 mm
Phantom	Left Cheek
Device Position	Cheek
Band	GPRS 850
Signal	Duty Cycle: 2.00 (Crest factor: 2.0)
Frequency (MHz)	824.2
Relative permittivity (real part)	42.50
Conductivity (S/m)	0.84

Maximum location: X=-50.00, Y=-30.00

SAR Peak: 0.62 W/kg

SAR 10g (W/Kg)	0.310034
SAR 1g (W/Kg)	0.438672

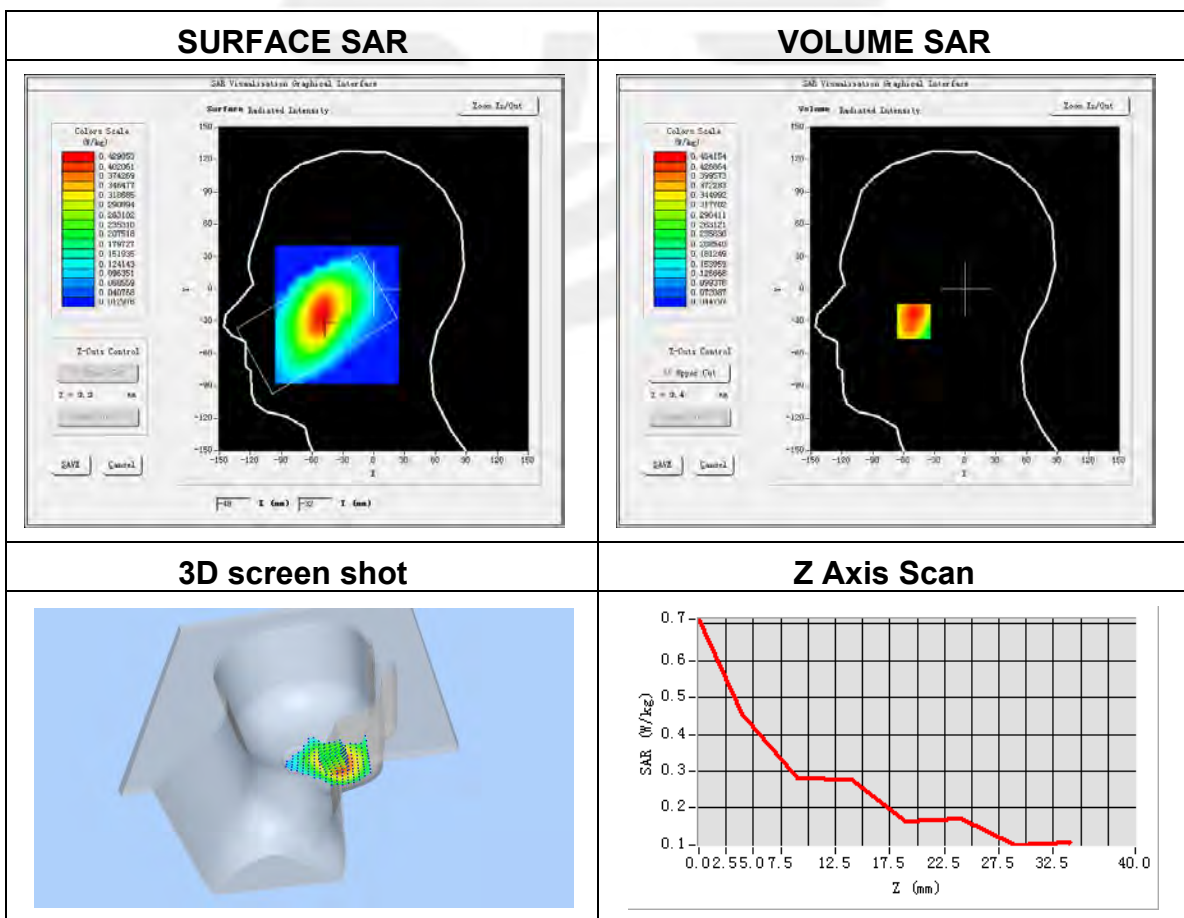

Plot 2: DUT: Mobile Phone; EUT Model: STUDIO X5 MAX

Test Date	2022-02-16
Probe	SN 07/21 EPGO352
Area Scan	dx=8mm, dy=8mm, h= 5.00 mm
Zoom Scan	5x5x7, dx=8mm, dy=8mm, dz=5mm, Complete/ndx=8mm, dy=8mm, h= 5.00 mm
Phantom	Validation plane
Device Position	Back Side
Band	GPRS 850
Signal	Duty Cycle: 2.00 (Crest factor: 2.0)
Frequency (MHz)	824.2
Relative permittivity (real part)	42.50
Conductivity (S/m)	0.84

Maximum location: X=21.00, Y=-25.00

SAR Peak: 0.44 W/kg

SAR 10g (W/Kg)	0.231926
SAR 1g (W/Kg)	0.318904

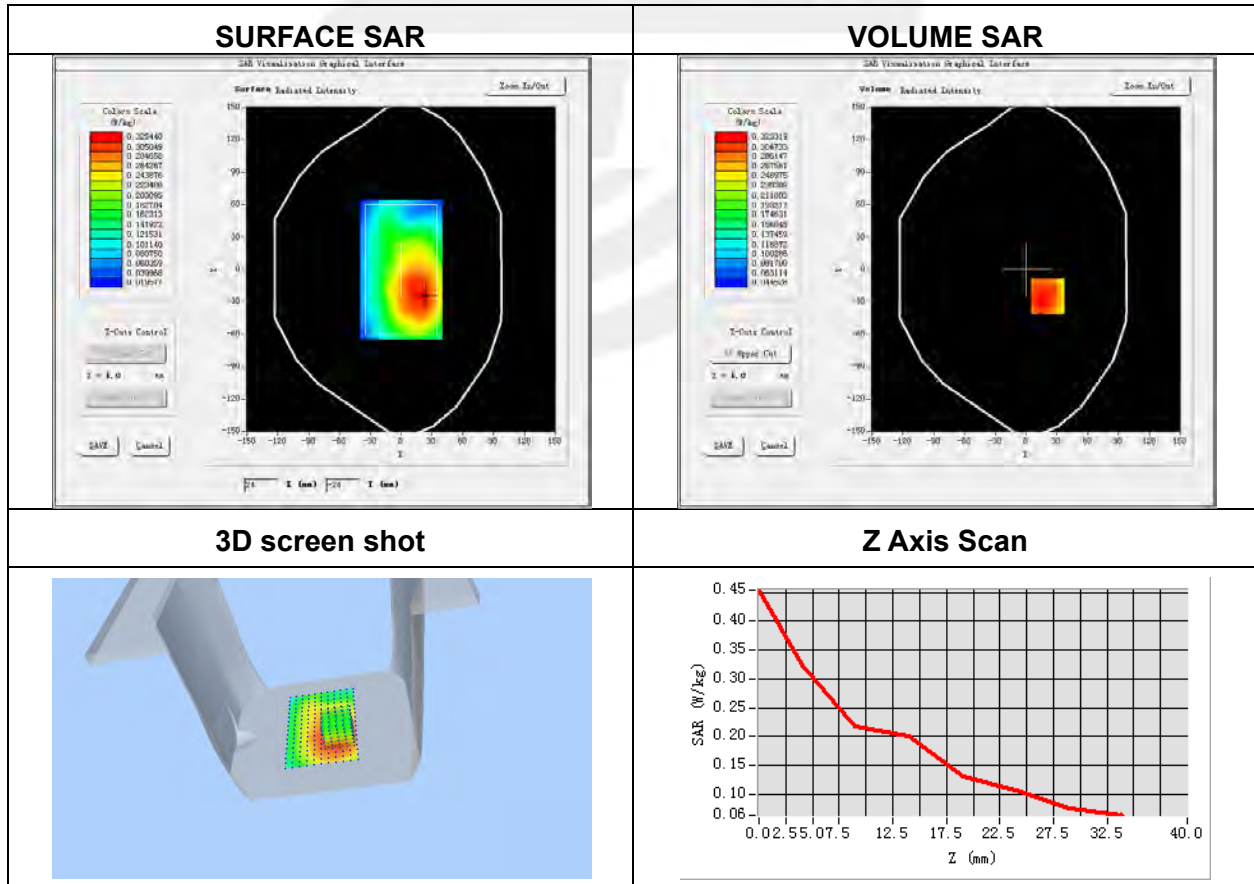

Plot 3: DUT: Mobile Phone; EUT Model: STUDIO X5 MAX

Test Date	2022-02-21
Probe	SN 07/21 EPGO352
Area Scan	dx=8mm, dy=8mm, h= 5.00 mm
Zoom Scan	5x5x7, dx=8mm, dy=8mm, dz=5mm, Complete/ndx=8mm, dy=8mm, h= 5.00 mm
Phantom	Left head
Device Position	Cheek
Band	GPRS 1900
Signal	Duty Cycle: 2.00 (Crest factor: 2.0)
Frequency (MHz)	1880
Relative permittivity (real part)	40.51
Conductivity (S/m)	1.46

Maximum location: X=-56.00, Y=-57.00

SAR Peak: 1.04 W/kg

SAR 10g (W/Kg)	0.438436
SAR 1g (W/Kg)	0.713274

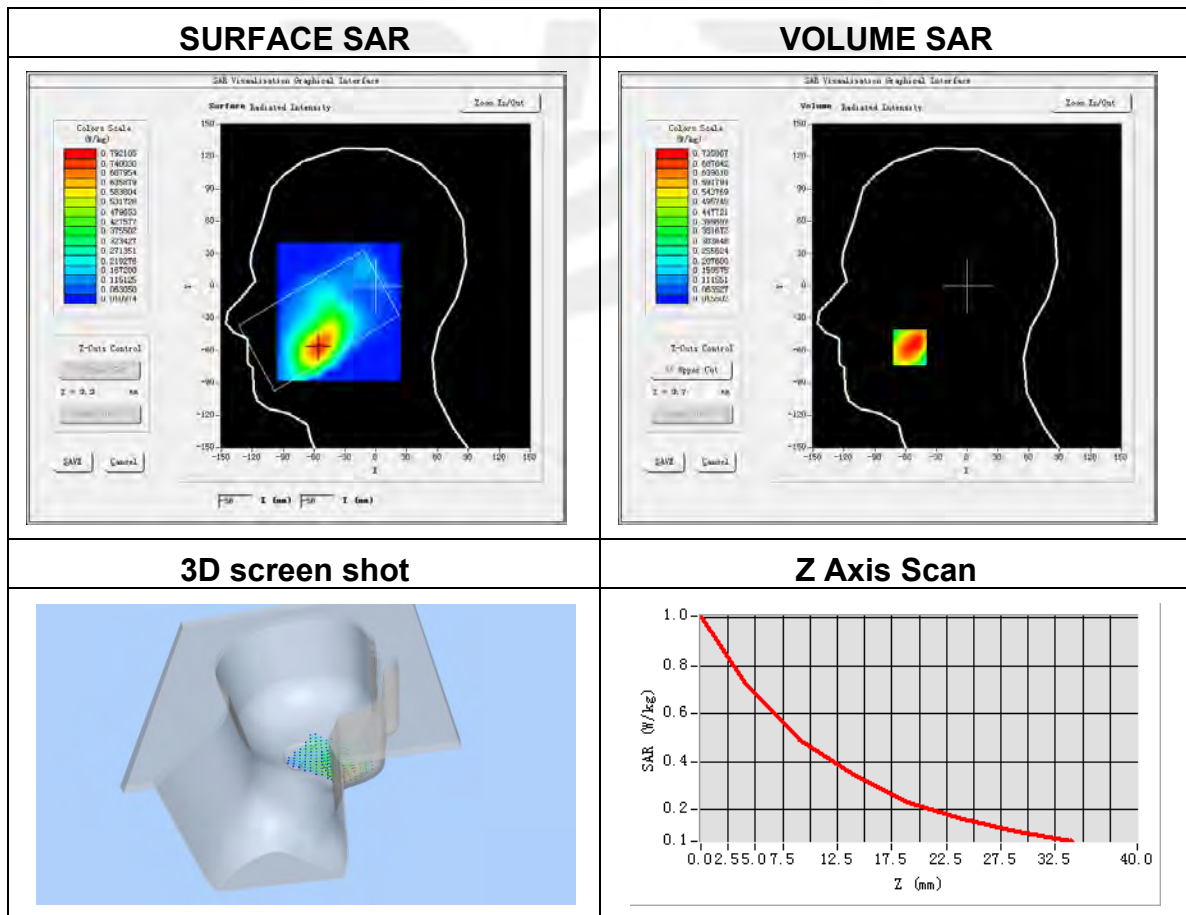

Plot 4: DUT: Mobile Phone; EUT Model: STUDIO X5 MAX

Test Date	2022-02-21
Probe	SN 07/21 EPGO352
Area Scan	dx=8mm, dy=8mm, h= 5.00 mm
Zoom Scan	5x5x7, dx=8mm, dy=8mm, dz=5mm, Complete/ndx=8mm, dy=8mm, h= 5.00 mm
Phantom	Validation plane
Device Position	Front Side
Band	GPRS 1900
Signal	Duty Cycle: 2.00 (Crest factor: 2.0)
Frequency (MHz)	1880
Relative permittivity (real part)	40.51
Conductivity (S/m)	1.46

Maximum location: X=-9.00, Y=-64.00

SAR Peak: 0.98 W/kg

SAR 10g (W/Kg)	0.365778
SAR 1g (W/Kg)	0.632042

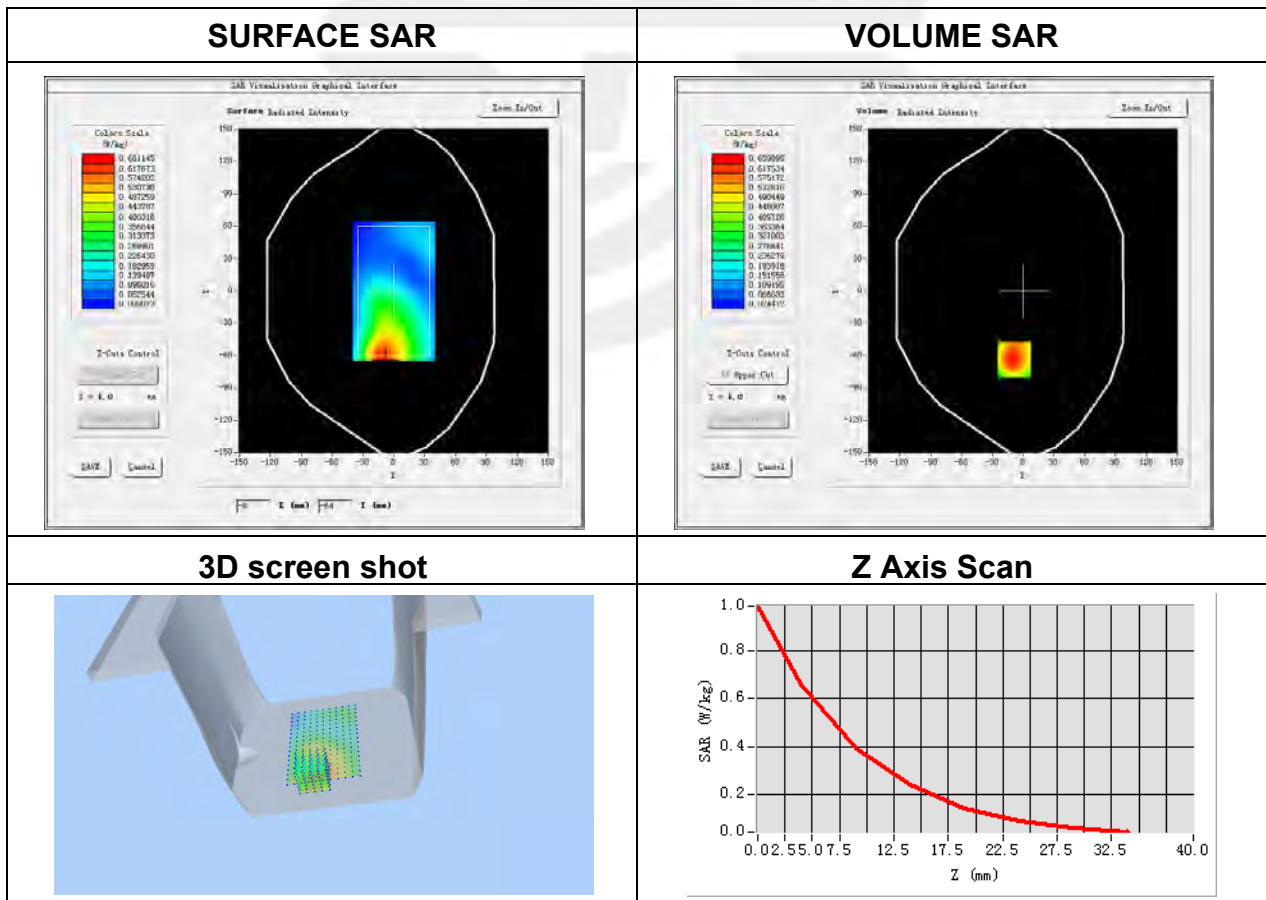

Plot 5: DUT: Mobile Phone; EUT Model: STUDIO X5 MAX

Test Date	2022-02-21
Probe	SN 07/21 EPGO352
Area Scan	dx=8mm, dy=8mm, h= 5.00 mm
Zoom Scan	5x5x7, dx=8mm, dy=8mm, dz=5mm, Complete/ndx=8mm, dy=8mm, h= 5.00 mm
Phantom	Left head
Device Position	Cheek
Band	WCDMA II
Signal	WCDMA (Crest factor: 1.0)
Frequency (MHz)	1852.4
Relative permittivity (real part)	40.17
Conductivity (S/m)	1.39

Maximum location: X=-55.00, Y=-56.00

SAR Peak: 0.41 W/kg

SAR 10g (W/Kg)	0.170239
SAR 1g (W/Kg)	0.281177

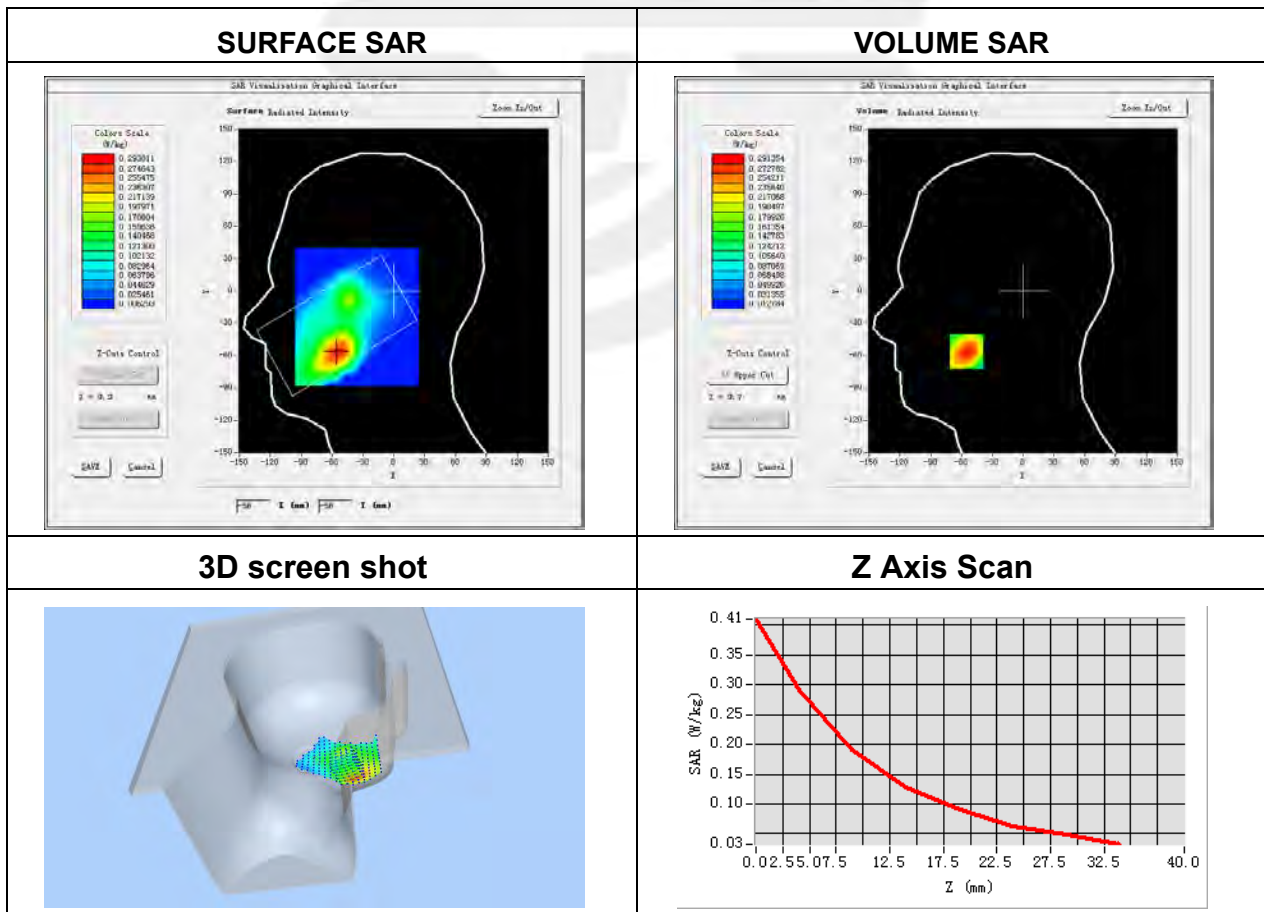

Plot 6: DUT: Mobile Phone; EUT Model: STUDIO X5 MAX

Test Date	2022-02-21
Probe	SN 07/21 EPGO352
ConvF	1.84
Area Scan	dx=8mm, dy=8mm, h= 5.00 mm
Zoom Scan	5x5x7, dx=8mm, dy=8mm, dz=5mm, Complete/ndx=8mm, dy=8mm, h= 5.00 mm
Phantom	Validation plane
Device Position	Front Side
Band	WCDMA II
Signal	WCDMA (Crest factor: 1.0)
Frequency (MHz)	1852.4
Relative permittivity (real part)	40.17
Conductivity (S/m)	1.39

Maximum location: X=-22.00, Y=-14.00

SAR Peak: 1.18 W/kg

SAR 10g (W/Kg)	0.438029
SAR 1g (W/Kg)	0.767447

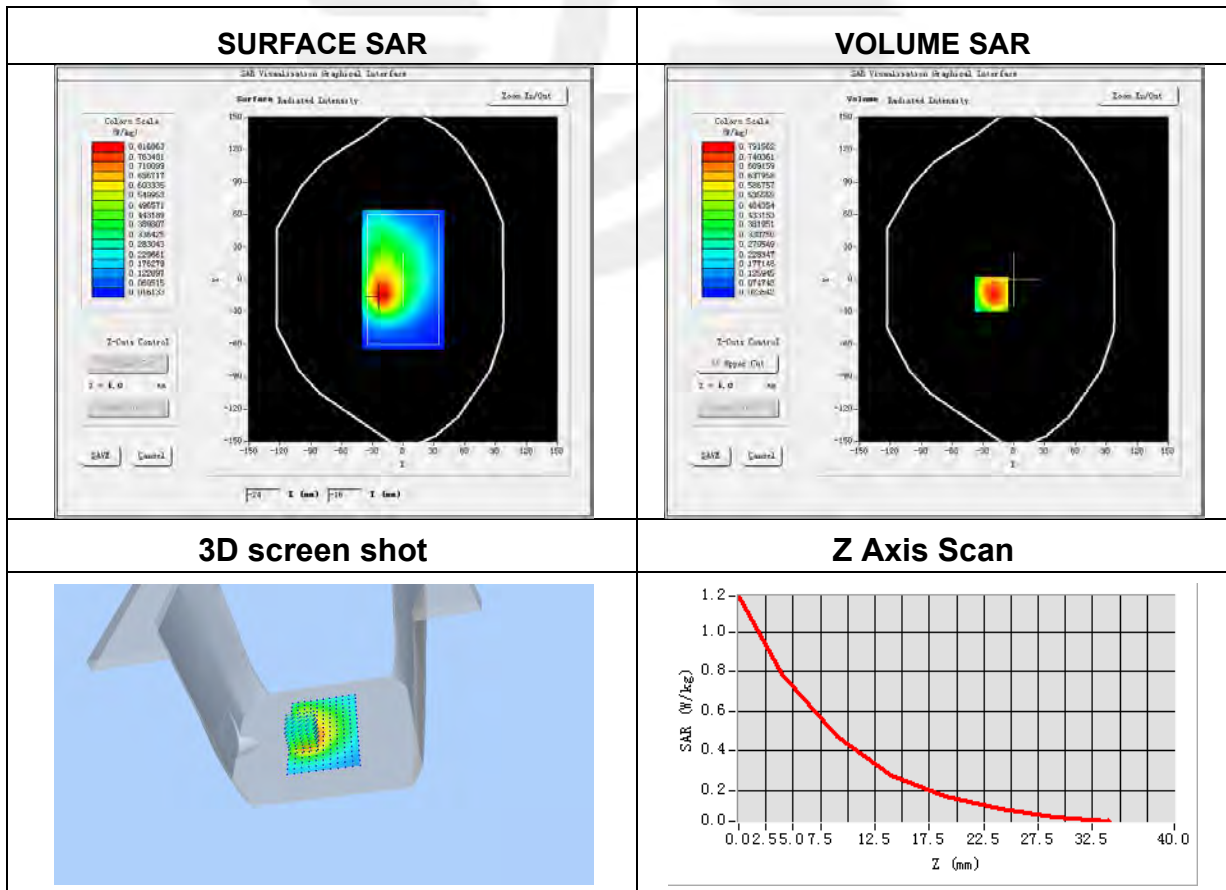

Plot 7: DUT: Mobile Phone; EUT Model: STUDIO X5 MAX

Test Date	2022-02-16
Probe	SN 07/21 EPG0352
Area Scan	dx=8mm, dy=8mm, h= 5.00 mm
Zoom Scan	5x5x7, dx=8mm, dy=8mm, dz=5mm, Complete/ndx=8mm, dy=8mm, h= 5.00 mm
Phantom	Left head
Device Position	Cheek
Band	WCDMA V
Signal	WCDMA (Crest factor: 1.0)
Frequency (MHz)	836.6
Relative permittivity (real part)	40.48
Conductivity (S/m)	0.93

Maximum location: X=-49.00, Y=-32.00

SAR Peak: 1.98 W/kg

SAR 10g (W/Kg)	0.342682
SAR 1g (W/Kg)	0.732769

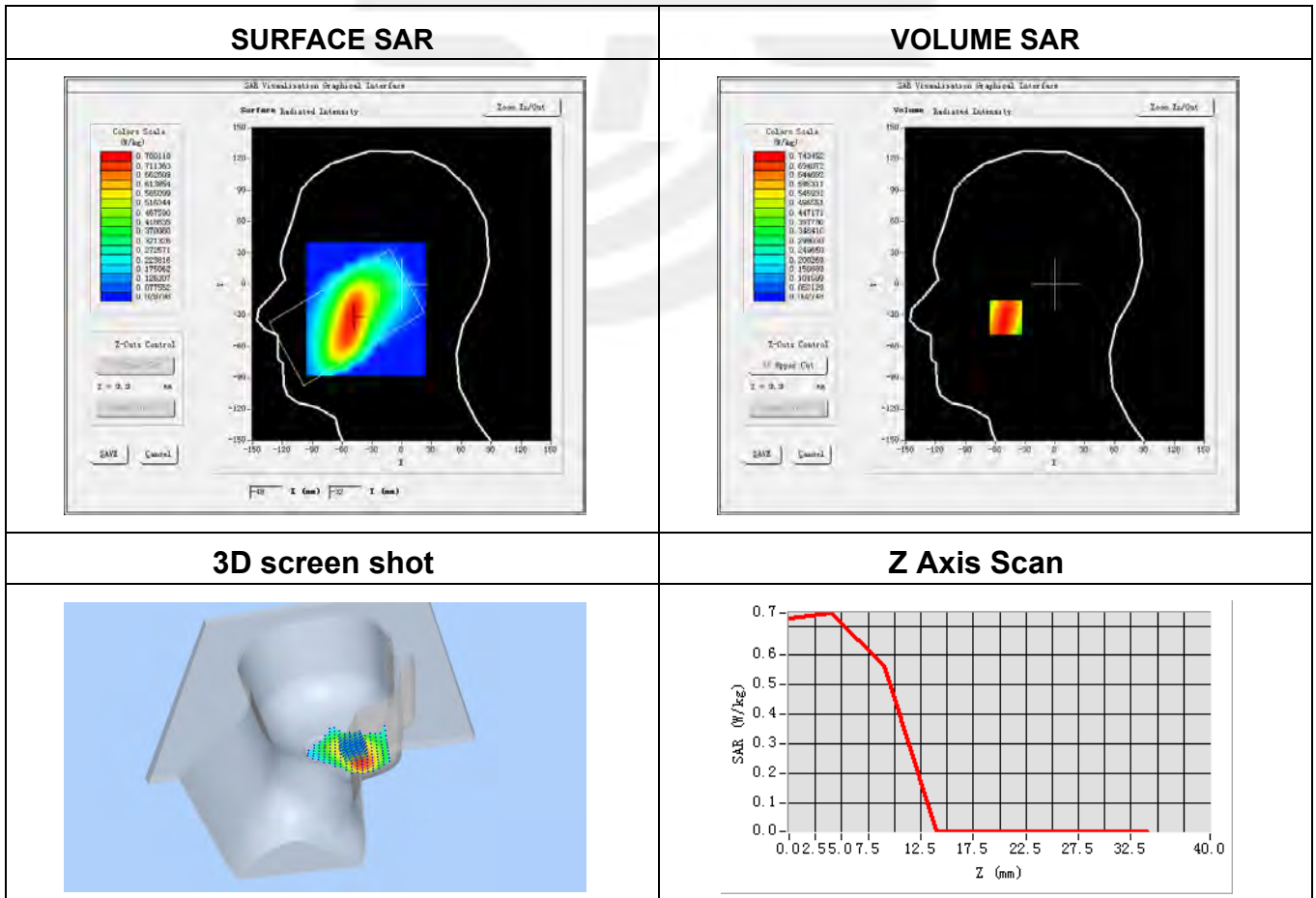

Plot 8: DUT: Mobile Phone; EUT Model: STUDIO X5 MAX

Test Date	2022-02-16
Probe	SN 07/21 EPGO352
ConvF	1.60
Area Scan	dx=8mm, dy=8mm, h= 5.00 mm
Zoom Scan	5x5x7, dx=8mm, dy=8mm, dz=5mm, Complete/ndx=8mm, dy=8mm, h= 5.00 mm
Phantom	Validation plane
Device Position	Front Side
Band	WCDMA V
Signal	WCDMA (Crest factor: 1.0)
Frequency (MHz)	836.6
Relative permittivity (real part)	40.48
Conductivity (S/m)	0.93

Maximum location: X=11.00, Y=22.00

SAR Peak: 0.64 W/kg

SAR 10g (W/Kg)	0.373810
SAR 1g (W/Kg)	0.503606

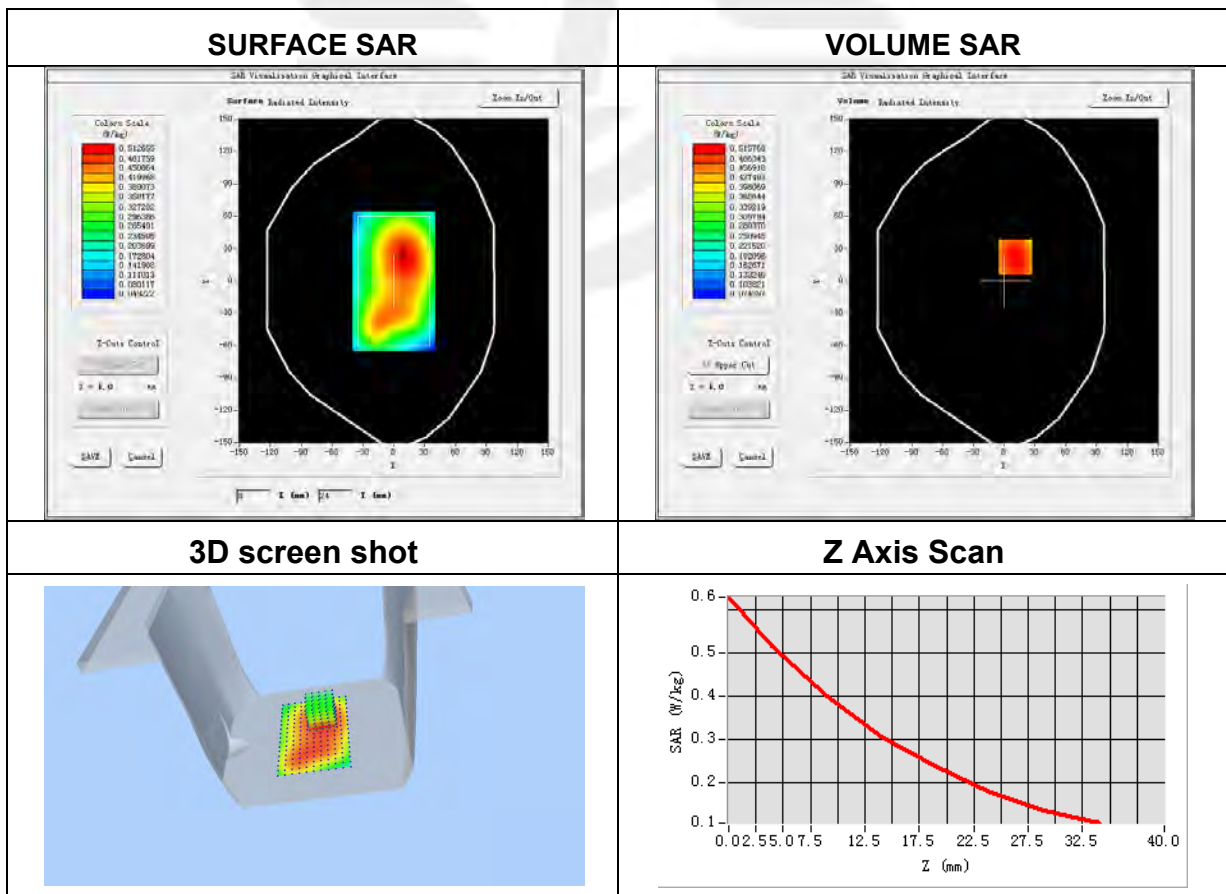

Plot 9: DUT: Mobile Phone; EUT Model: STUDIO X5 MAX

Test Date	2022-02-18
Probe	SN 07/21 EPG0352
Area Scan	dx=8mm, dy=8mm, h= 5.00 mm
Zoom Scan	5x5x7, dx=8mm, dy=8mm, dz=5mm, Complete/ndx=8mm, dy=8mm, h= 5.00 mm
Phantom	Left Cheek
Device Position	Cheek
Band	WCDMA IV
Signal	WCDMA (Crest factor: 1.0)
Frequency (MHz)	1752.4
Relative permittivity (real part)	40.74
Conductivity (S/m)	1.39

Maximum location: X=-56.00, Y=-57.00

SAR Peak: 0.57 W/kg

SAR 10g (W/Kg)	0.239102
SAR 1g (W/Kg)	0.391190

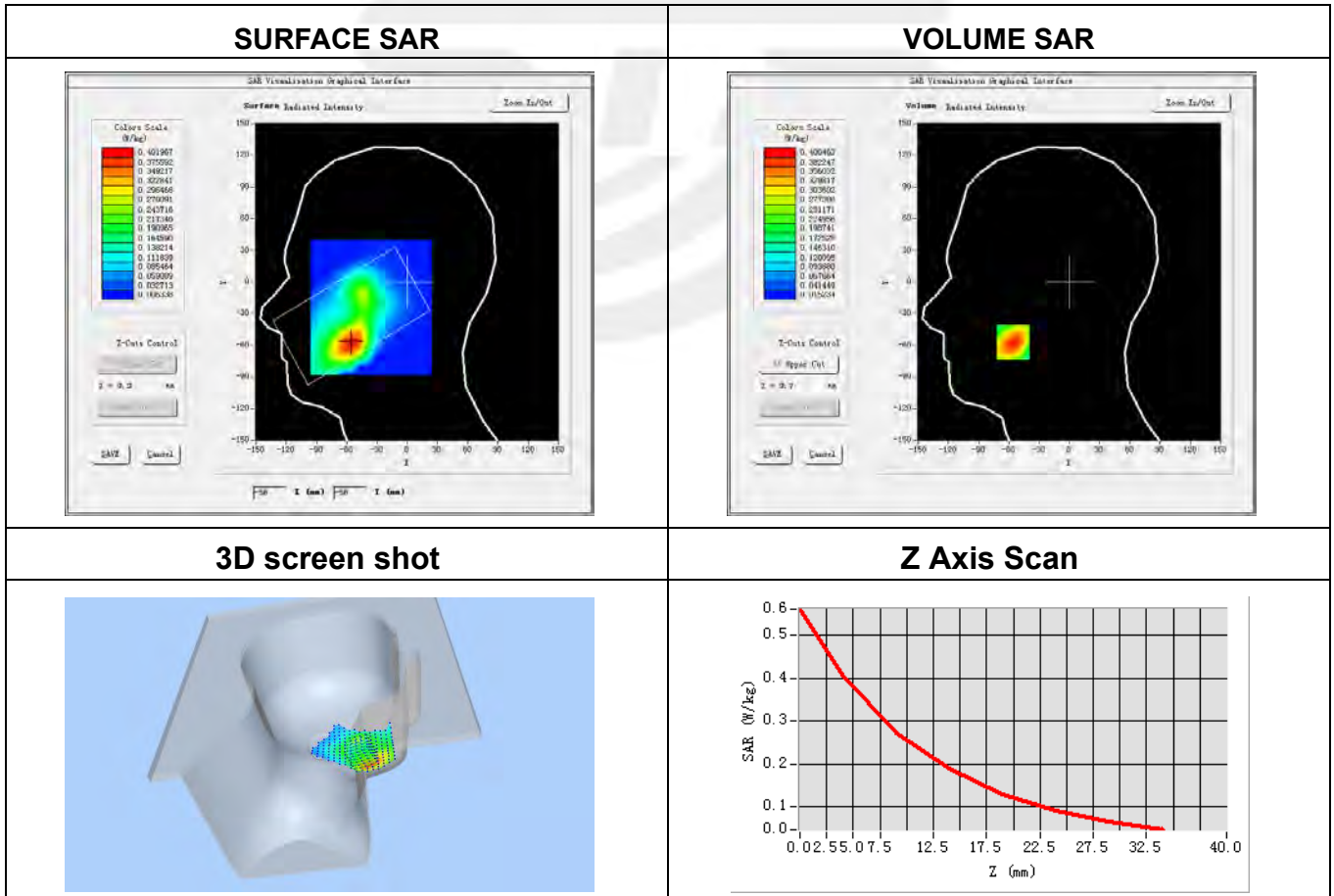

Plot 10: DUT: Mobile Phone; EUT Model: STUDIO X5 MAX

Test Date	2022-02-18
Probe	SN 07/21 EPGO352
Area Scan	dx=8mm, dy=8mm, h= 5.00 mm
Zoom Scan	5x5x7, dx=8mm, dy=8mm, dz=5mm, Complete/ndx=8mm, dy=8mm, h= 5.00 mm
Phantom	Validation plane
Device Position	Front Side
Band	WCDMA IV
Signal	WCDMA (Crest factor: 1.0)
Frequency (MHz)	1752.4
Relative permittivity (real part)	40.74
Conductivity (S/m)	1.39

Maximum location: X=-19.00, Y=-6.00

SAR Peak: 1.00 W/kg

SAR 10g (W/Kg)	0.396837
SAR 1g (W/Kg)	0.662865

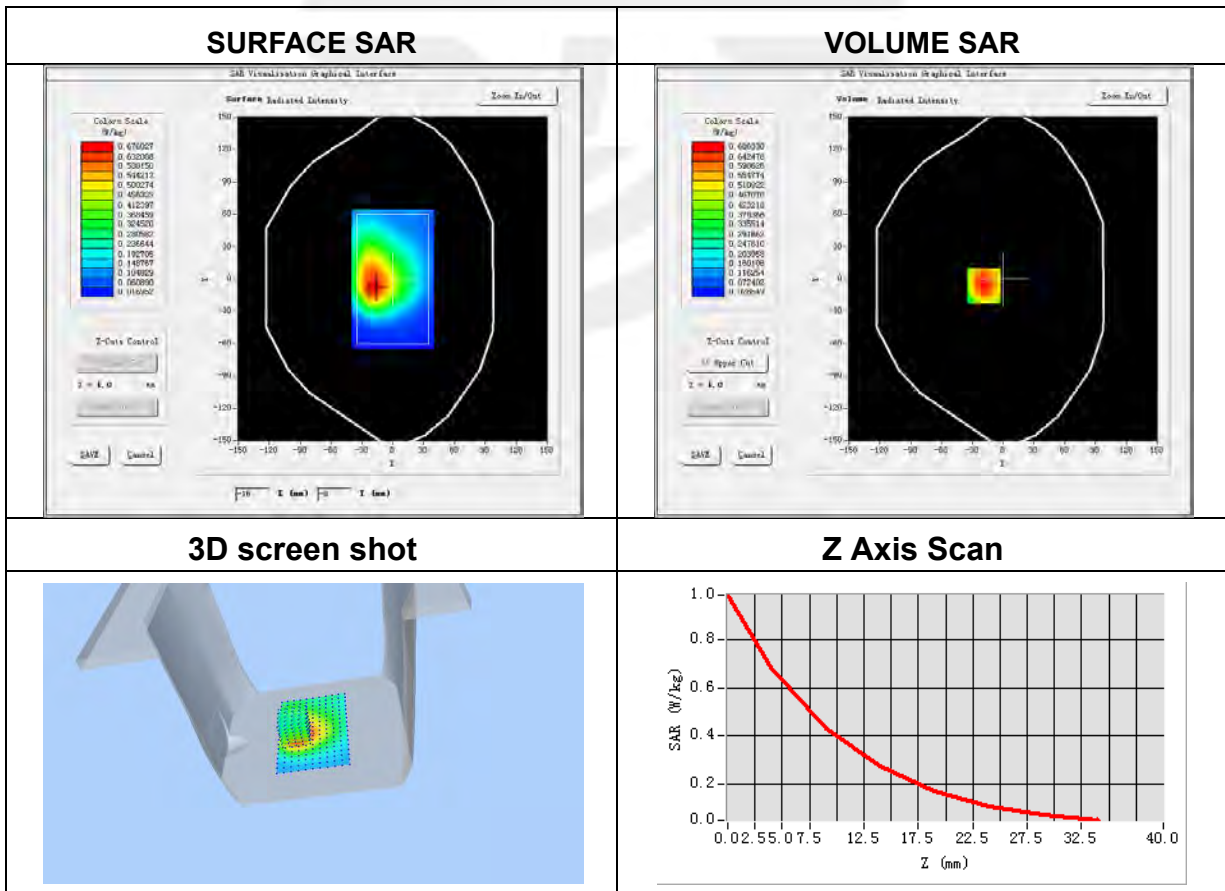

Plot 11: DUT: Mobile Phone; EUT Model: STUDIO X5 MAX

Test Date	2022-02-21
Probe	SN 07/21 EPGO352
Area Scan	dx=8mm, dy=8mm, h= 5.00 mm
Zoom Scan	5x5x7, dx=8mm, dy=8mm, dz=5mm, Complete/ndx=8mm, dy=8mm, h= 5.00 mm
Phantom	Left head
Device Position	Cheek
Band	LTE Band 2 (RB 1)
Signal	LTE (Crest factor: 1.0)
Frequency (MHz)	1860
Relative permittivity (real part)	40.23
Conductivity (S/m)	1.40

Maximum location: X=-61.00, Y=-59.00

SAR Peak: 0.20 W/kg

SAR 10g (W/Kg)	0.087258
SAR 1g (W/Kg)	0.135353

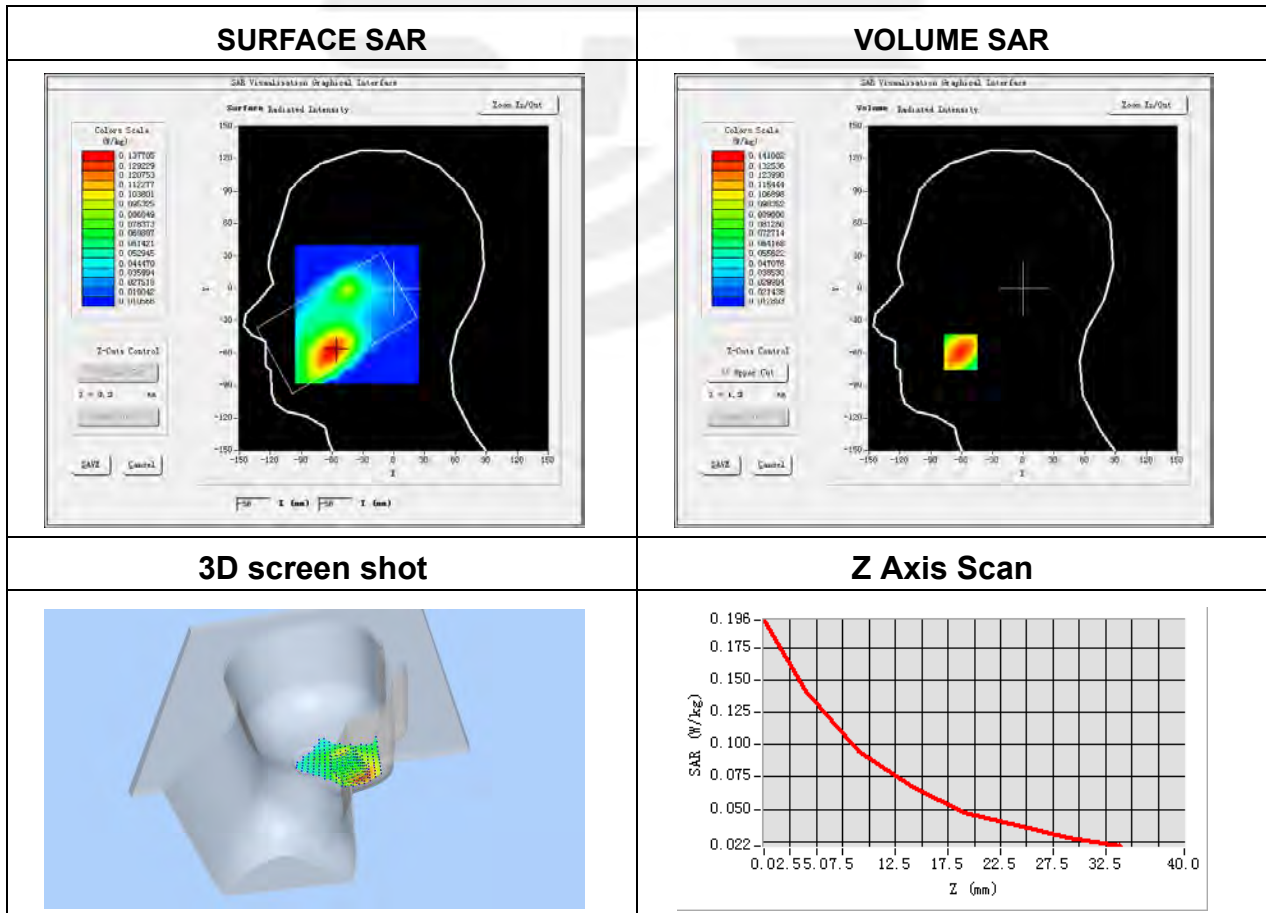

Plot 12: DUT: Mobile Phone; EUT Model: STUDIO X5 MAX

Test Date	2022-02-21
Probe	SN 07/21 EPGO352
Area Scan	dx=8mm, dy=8mm, h= 5.00 mm
Zoom Scan	5x5x7, dx=8mm, dy=8mm, dz=5mm, Complete/ndx=8mm, dy=8mm, h= 5.00 mm
Phantom	Validation plane
Device Position	Front side
Band	LTE Band 2(RB 1)
Signal	LTE (Crest factor: 1.0)
Frequency (MHz)	1860
Relative permittivity (real part)	40.23
Conductivity (S/m)	1.40

Maximum location: X=-22.00, Y=-7.00

SAR Peak: 0.57 W/kg

SAR 10g (W/Kg)	0.211978
SAR 1g (W/Kg)	0.366105

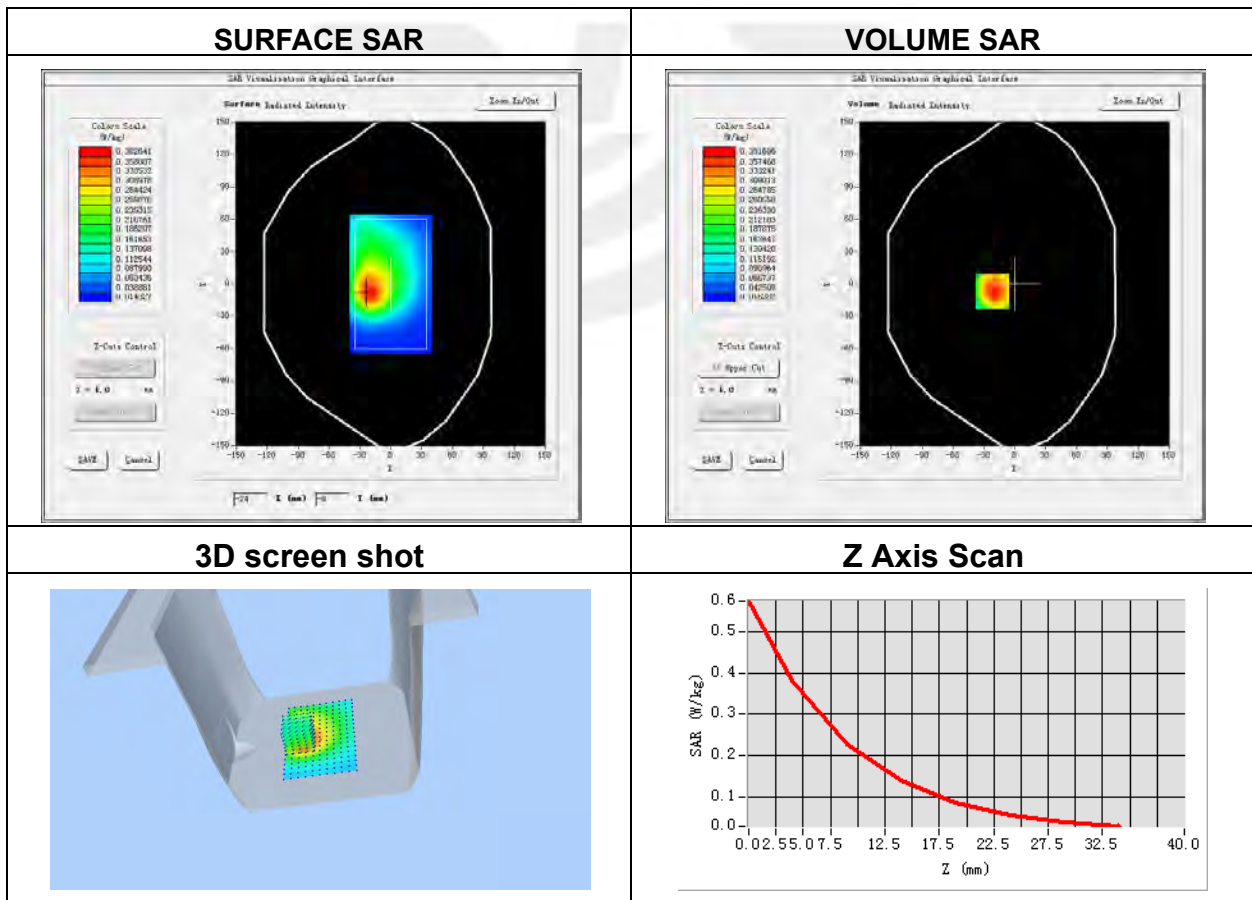

Plot 13: DUT: Mobile Phone; EUT Model: STUDIO X5 MAX

Test Date	2022-02-18
Probe	SN 07/21 EPGO352
Area Scan	dx=8mm, dy=8mm, h= 5.00 mm
Zoom Scan	5x5x7, dx=8mm, dy=8mm, dz=5mm, Complete/ndx=8mm, dy=8mm, h= 5.00 mm
Phantom	Left head
Band	LTE Band 4 (RB 1)
Signal	LTE (Crest factor: 1.0)
Frequency (MHz)	1720
Relative permittivity (real part)	40.40
Conductivity (S/m)	1.37

Maximum location: X=-56.00, Y=-58.00

SAR Peak: 0.17 W/kg

SAR 10g (W/Kg)	0.077513
SAR 1g (W/Kg)	0.117199

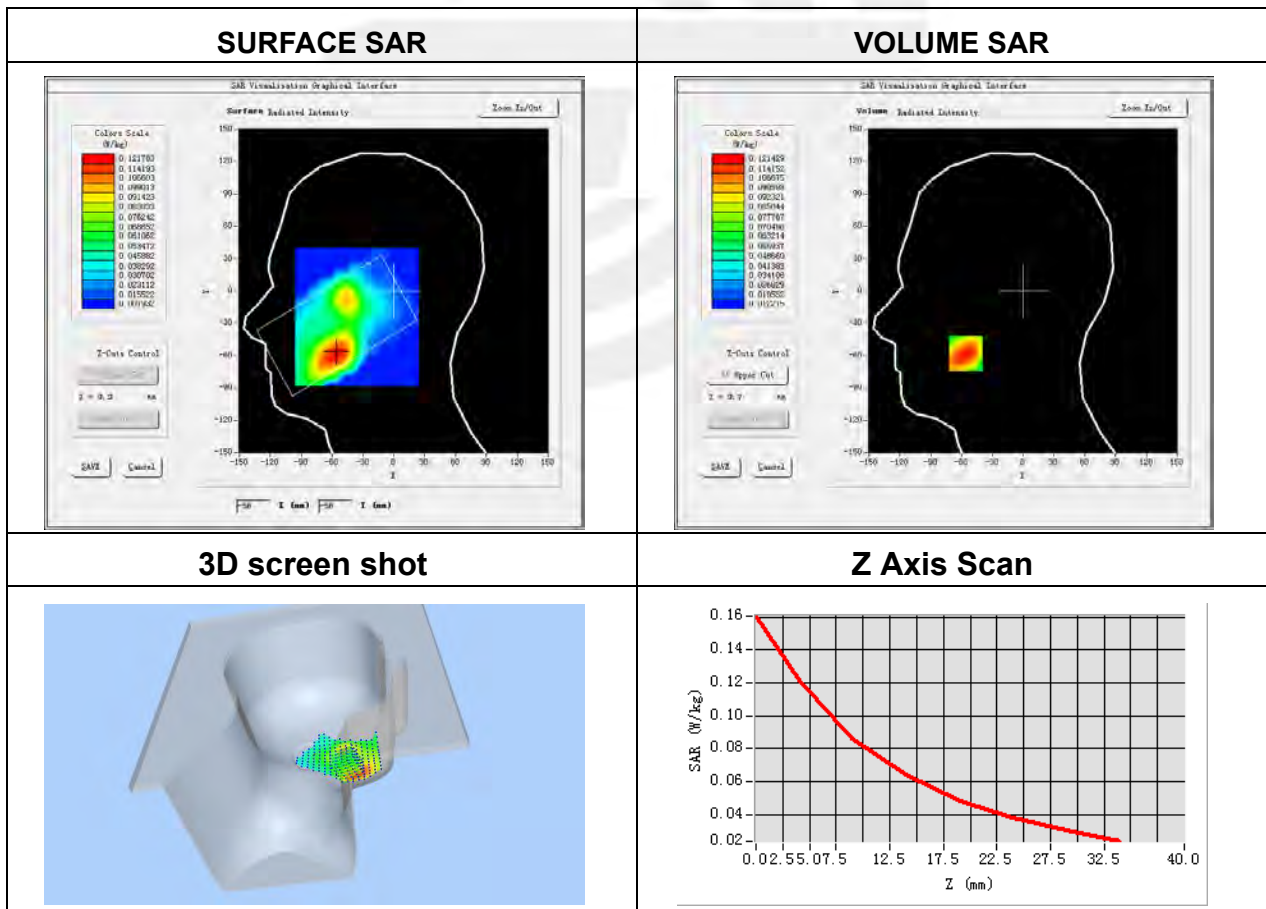

Plot 14: DUT: Mobile Phone; EUT Model: STUDIO X5 MAX

Test Date	2022-02-18
Probe	SN 07/21 EPGO352
Area Scan	dx=8mm, dy=8mm, h= 5.00 mm
Zoom Scan	5x5x7, dx=8mm, dy=8mm, dz=5mm, Complete/ndx=8mm, dy=8mm, h= 5.00 mm
Phantom	Validation plane
Device Position	Front side
Band	LTE Band 4 (RB 1)
Signal	LTE (Crest factor: 1.0)
Frequency (MHz)	1720
Relative permittivity (real part)	40.40
Conductivity (S/m)	1.37

Maximum location: X=-16.00, Y=-6.00

SAR Peak: 0.46 W/kg

SAR 10g (W/Kg)	0.180723
SAR 1g (W/Kg)	0.297653

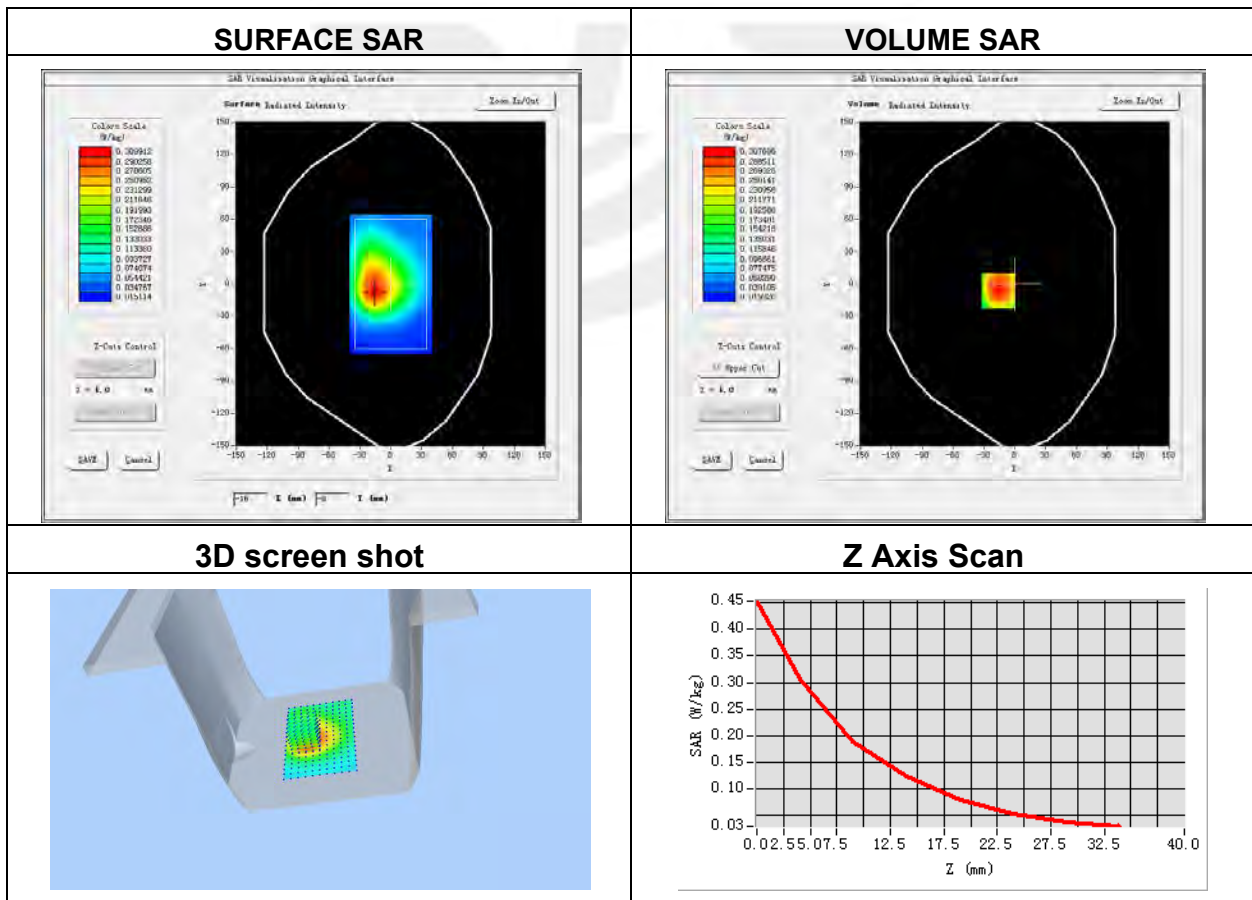

Plot 15: DUT: Mobile Phone; EUT Model: STUDIO X5 MAX

Test Date	2022-02-16
Probe	SN 07/21 EPGO352
Area Scan	dx=8mm, dy=8mm, h= 5.00 mm
Zoom Scan	5x5x7, dx=8mm, dy=8mm, dz=5mm, Complete/ndx=8mm, dy=8mm, h= 5.00 mm
Phantom	Left Cheek
Device Position	Cheek
Band	LTE Band 5 (RB 1)
Signal	LTE (Crest factor: 1.0)
Frequency (MHz)	836.5
Relative permittivity (real part)	43.18
Conductivity (S/m)	0.90

Maximum location: X=-50.00, Y=-17.00

SAR Peak: 0.32 W/kg

SAR 10g (W/Kg)	0.186171
SAR 1g (W/Kg)	0.251681

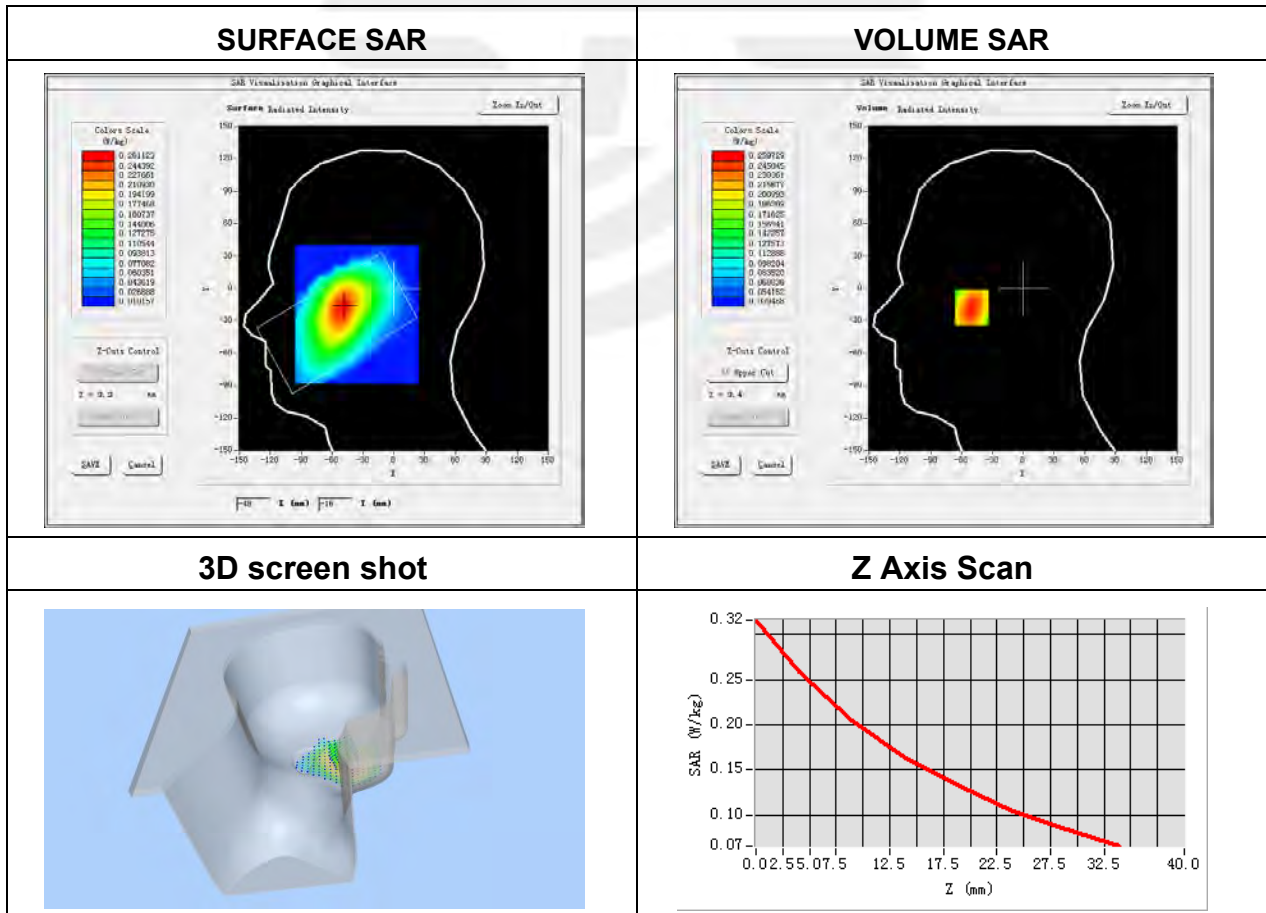

Plot 16: DUT: Mobile Phone; EUT Model: STUDIO X5 MAX

Test Date	2022-02-16
Probe	SN 07/21 EPGO352
Area Scan	dx=8mm, dy=8mm, h= 5.00 mm
Zoom Scan	5x5x7, dx=8mm, dy=8mm, dz=5mm, Complete/ndx=8mm, dy=8mm, h= 5.00 mm
Phantom	Validation plane
Device Position	Back Side
Band	LTE Band 5 (RB 1)
Signal	LTE (Crest factor: 1.0)
Frequency (MHz)	836.5
Relative permittivity (real part)	43.18
Conductivity (S/m)	0.90

Maximum location: X=17.00, Y=34.00

SAR Peak: 0.34 W/kg

SAR 10g (W/Kg)	0.203837
SAR 1g (W/Kg)	0.272065

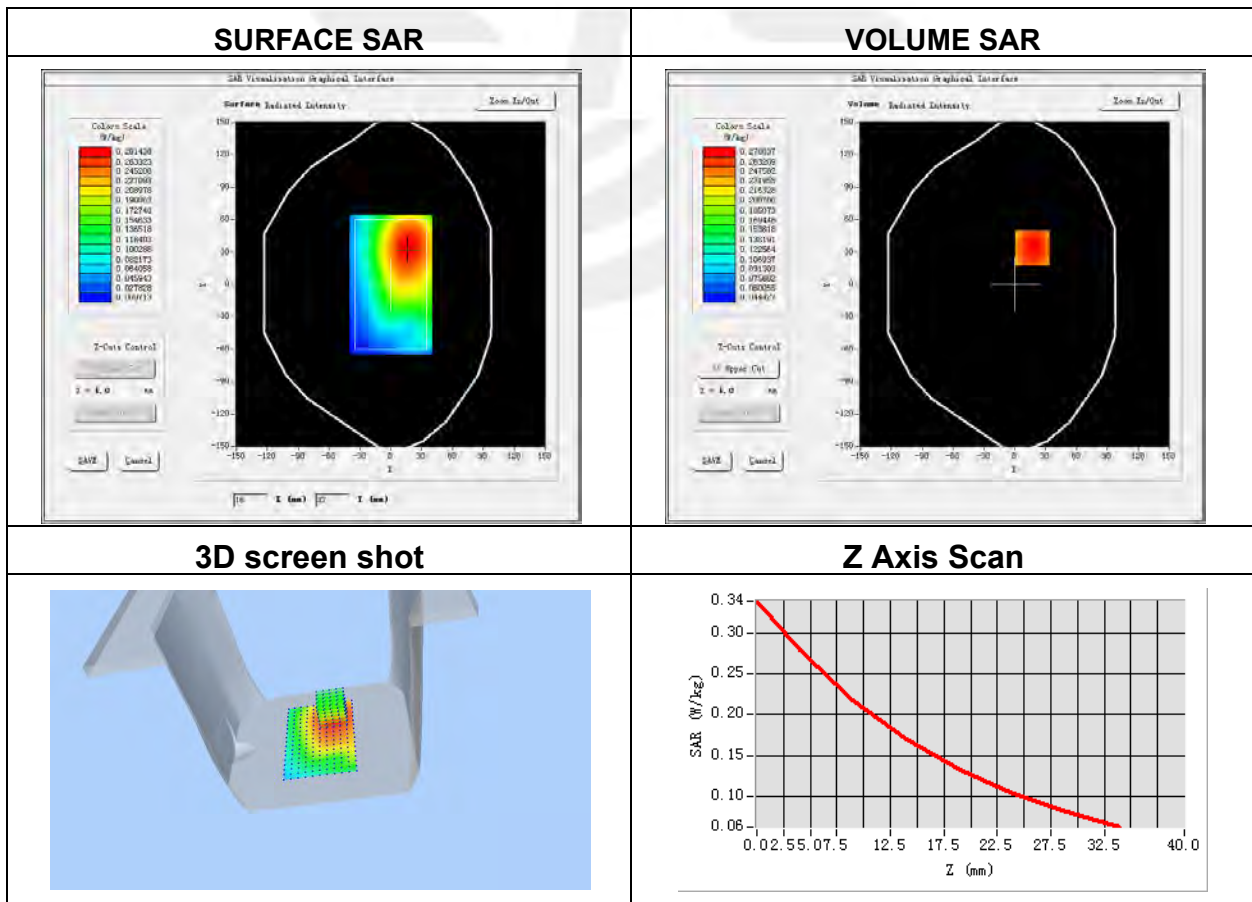

Plot 17: DUT: Mobile Phone; EUT Model: STUDIO X5 MAX

Test Date	2022-02-23
Probe	SN 07/21 EPGO352
Area Scan	dx=8mm, dy=8mm, h= 5.00 mm
Zoom Scan	5x5x7, dx=8mm, dy=8mm, dz=5mm, Complete/ndx=8mm, dy=8mm, h= 5.00 mm
Phantom	Left Cheek
Device Position	Cheek
Band	LTE Band 7 (RB 1)
Signal	LTE (Crest factor: 1.0)
Frequency (MHz)	2560
Relative permittivity (real part)	39.41
Conductivity (S/m)	1.92

Maximum location: X=-48.00, Y=-47.00

SAR Peak: 0.06 W/kg

SAR 10g (W/Kg)	0.029516
SAR 1g (W/Kg)	0.041134

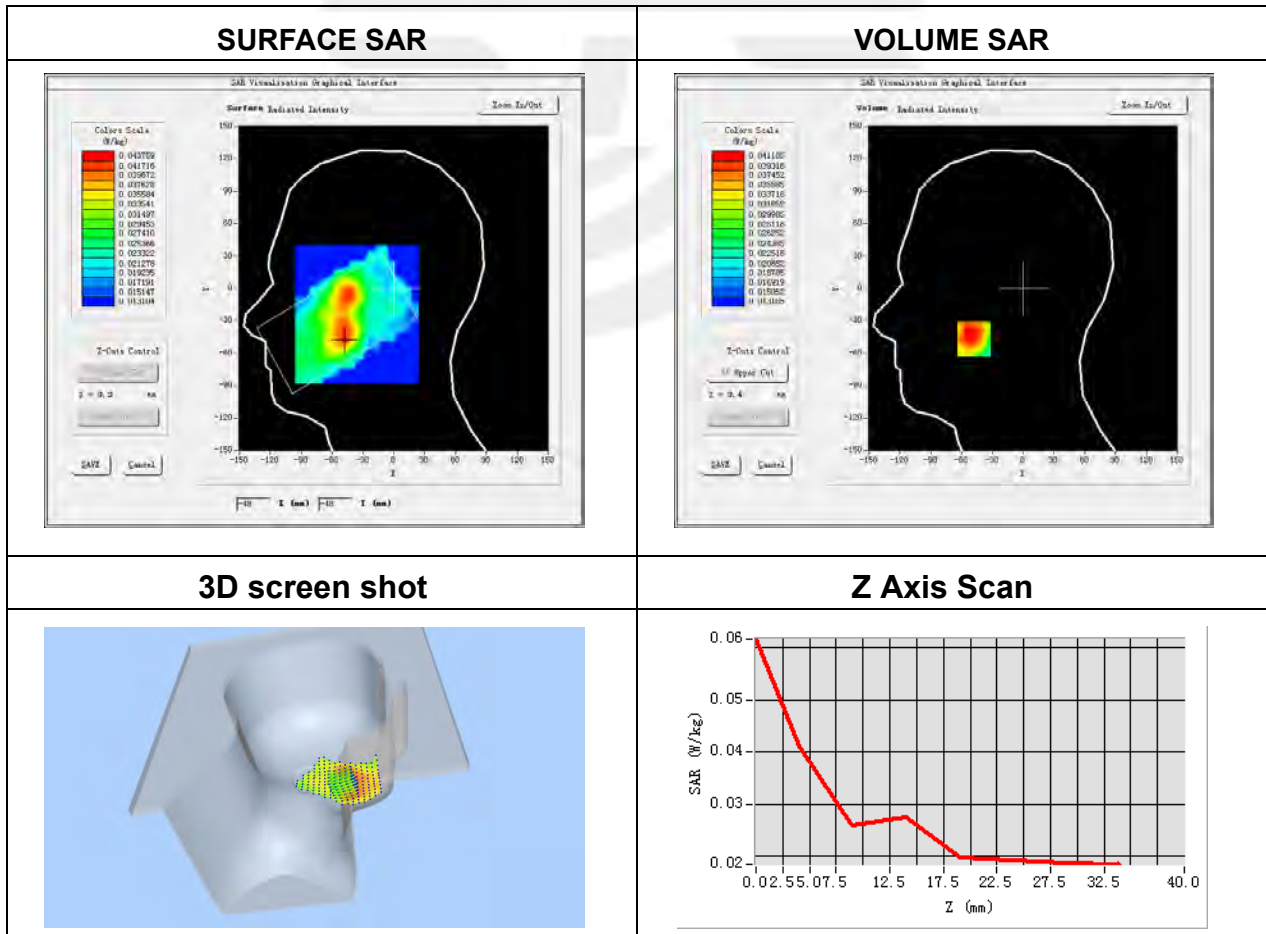

Plot 18: DUT: Mobile Phone; EUT Model: STUDIO X5 MAX

Test Date	2022-02-23
Probe	SN 07/21 EPGO352
Area Scan	dx=8mm, dy=8mm, h= 5.00 mm
Zoom Scan	5x5x7, dx=8mm, dy=8mm, dz=5mm, Complete/ndx=8mm, dy=8mm, h= 5.00 mm
Phantom	Validation plane
Device Position	Front side
Band	LTE Band 7 (RB 1)
Signal	LTE (Crest factor: 1.0)
Frequency (MHz)	2560
Relative permittivity (real part)	39.41
Conductivity (S/m)	1.92

Maximum location: X=14.00, Y=-6.00

SAR Peak: 0.08 W/kg

SAR 10g (W/Kg)	0.039022
SAR 1g (W/Kg)	0.058079

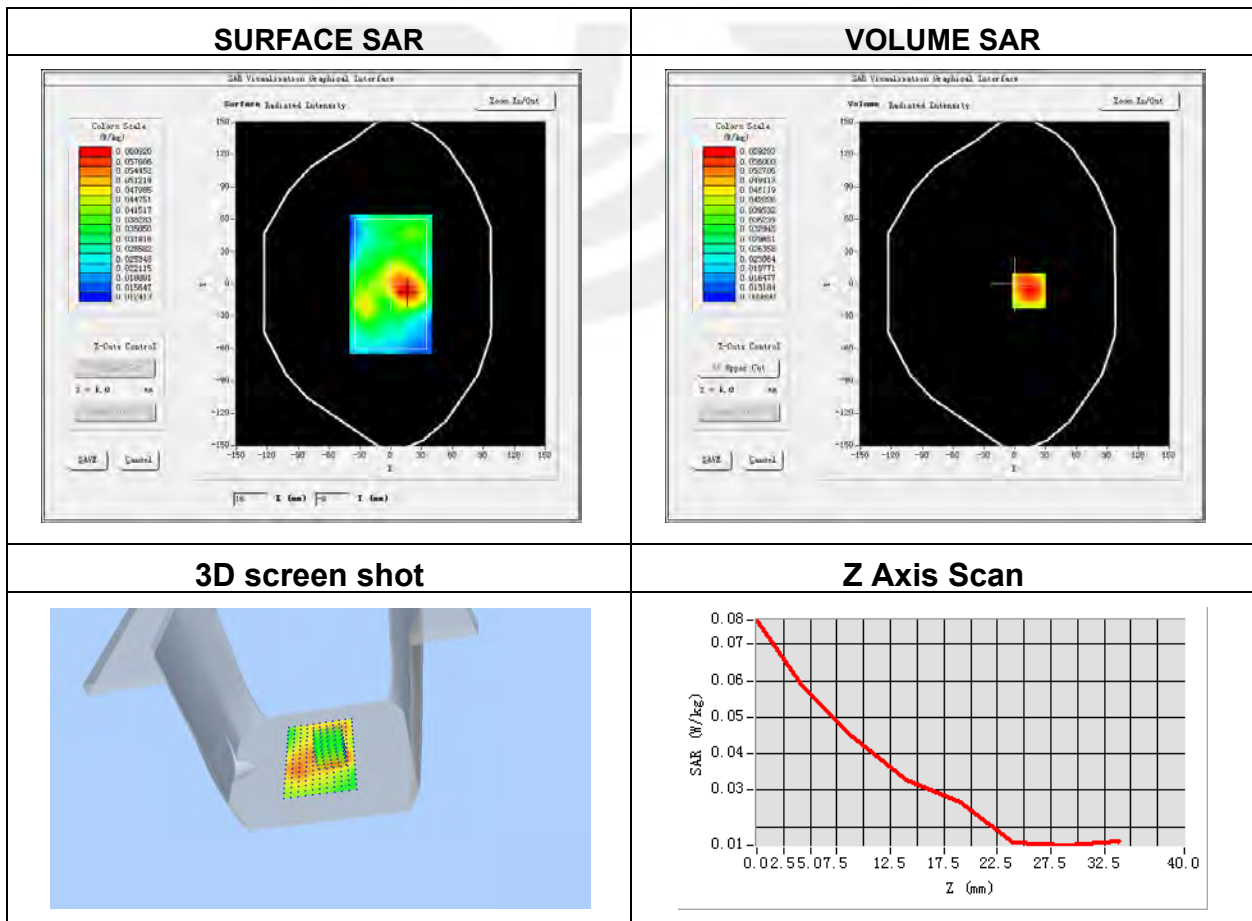

Plot 19: DUT: Mobile Phone; EUT Model: STUDIO X5 MAX

Test Date	2022-02-15
Probe	SN 07/21 EPGO352
Area Scan	dx=8mm, dy=8mm, h= 5.00 mm
Zoom Scan	5x5x7, dx=8mm, dy=8mm, dz=5mm, Complete/ndx=8mm, dy=8mm, h= 5.00 mm
Phantom	Left Cheek
Device Position	Cheek
Band	LTE Band 12 (RB 1)
Signal	LTE (Crest factor: 1.0)
Frequency (MHz)	704
Relative permittivity (real part)	42.98
Conductivity (S/m)	0.91

Maximum location: X=-53.00, Y=-31.00

SAR Peak: 0.19 W/kg

SAR 10g (W/Kg)	0.115942
SAR 1g (W/Kg)	0.153037

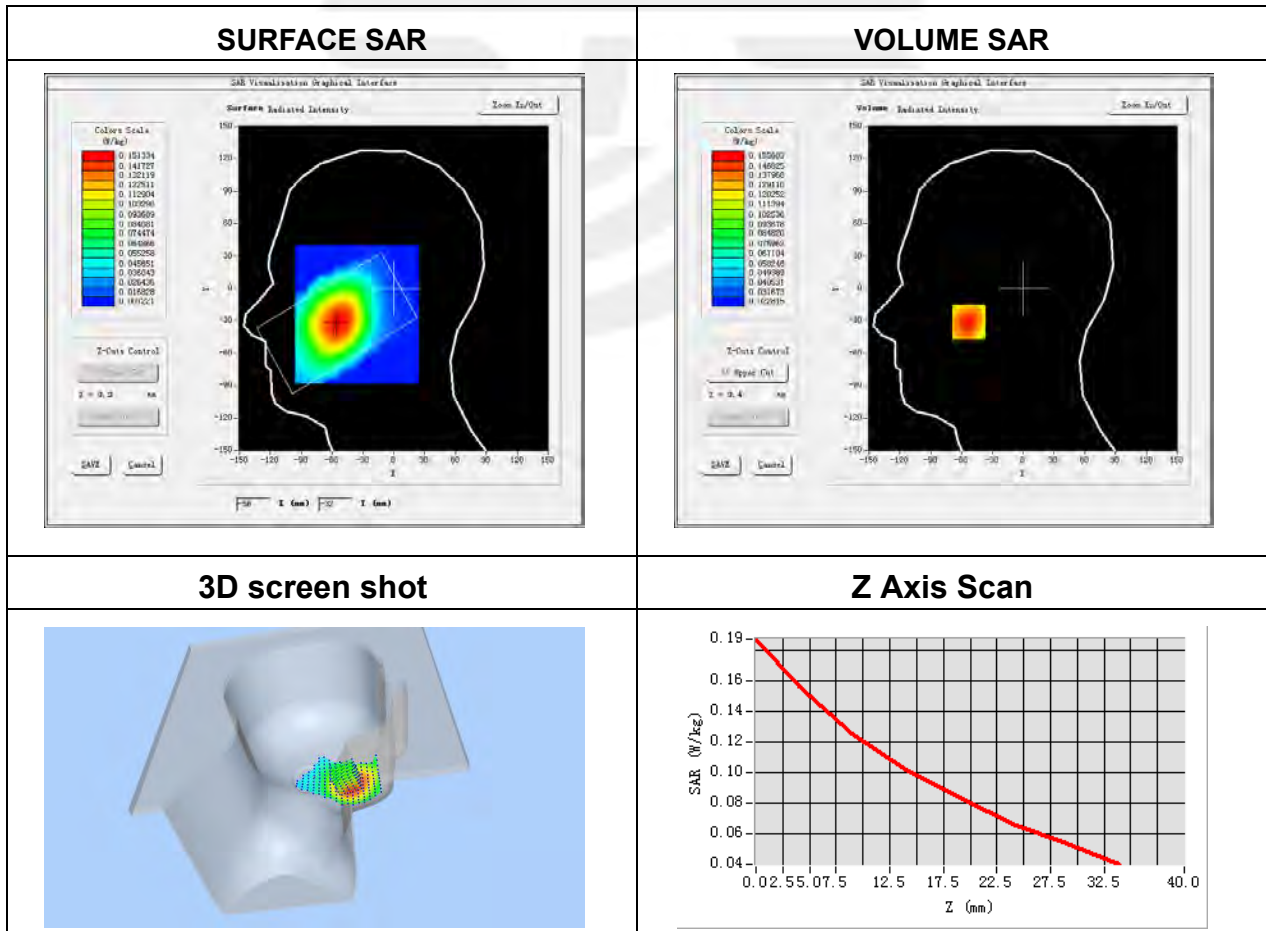

Plot 20: DUT: Mobile Phone; EUT Model: STUDIO X5 MAX

Test Date	2022-02-15
Probe	SN 07/21 EPGO352
Area Scan	dx=8mm, dy=8mm, h= 5.00 mm
Zoom Scan	5x5x7, dx=8mm, dy=8mm, dz=5mm, Complete/ndx=8mm, dy=8mm, h= 5.00 mm
Phantom	Validation plane
Device Position	Back Side
Band	LTE Band 12 (RB 1)
Signal	LTE (Crest factor: 1.0)
Frequency (MHz)	704
Relative permittivity (real part)	42.98
Conductivity (S/m)	0.91

Maximum location: X=6.00, Y=31.00

SAR Peak: 0.45 W/kg

SAR 10g (W/Kg)	0.272818
SAR 1g (W/Kg)	0.365865

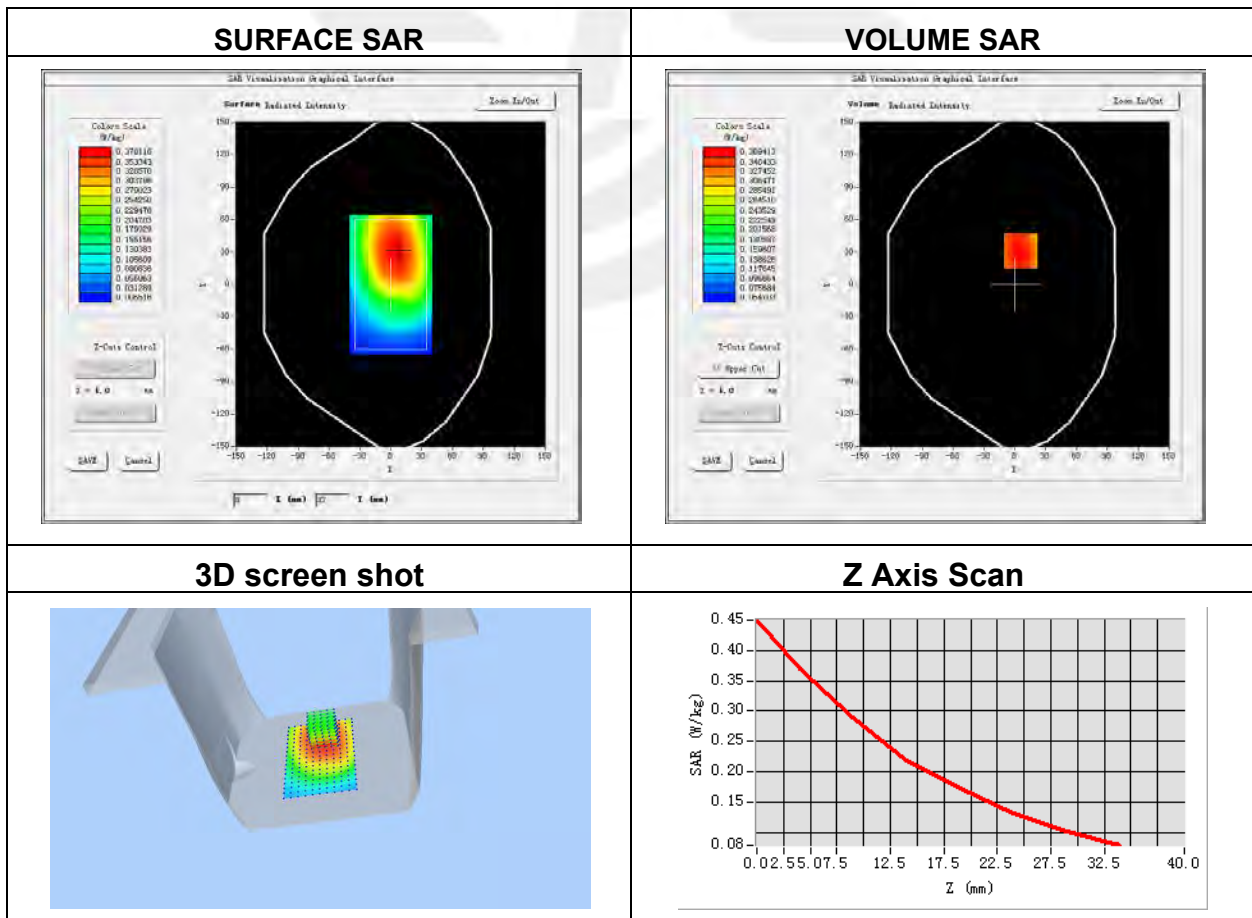

Plot 21: DUT: Mobile Phone; EUT Model: STUDIO X5 MAX

Test Date	2022-02-15
Probe	SN 07/21 EPGO352
Area Scan	dx=8mm, dy=8mm, h= 5.00 mm
Zoom Scan	5x5x7, dx=8mm, dy=8mm, dz=5mm, Complete/ndx=8mm, dy=8mm, h= 5.00 mm
Phantom	Left Cheek
Device Position	Cheek
Band	LTE Band 17 (RB 1)
Signal	LTE (Crest factor: 1.0)
Frequency (MHz)	710
Relative permittivity (real part)	42.00
Conductivity (S/m)	0.90

Maximum location: X=-50.00, Y=-20.00

SAR Peak: 0.29 W/kg

SAR 10g (W/Kg)	0.173440
SAR 1g (W/Kg)	0.234115

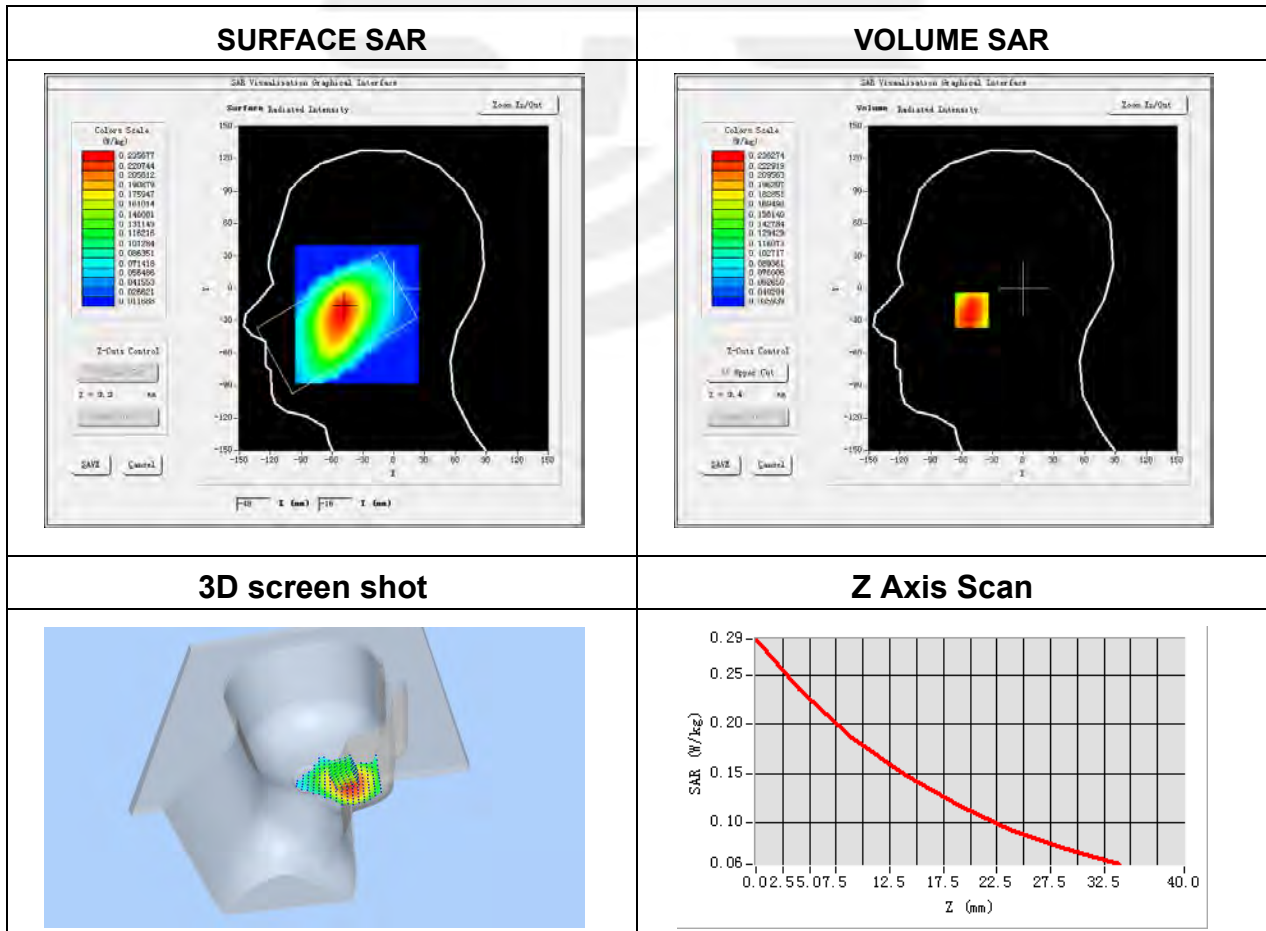

Plot 22: DUT: Mobile Phone; EUT Model: STUDIO X5 MAX

Test Date	2022-02-15
Probe	SN 07/21 EPGO352
Area Scan	dx=8mm, dy=8mm, h= 5.00 mm
Zoom Scan	5x5x7, dx=8mm, dy=8mm, dz=5mm, Complete/ndx=8mm, dy=8mm, h= 5.00 mm
Phantom	Validation plane
Device Position	Back Side
Band	LTE Band 17 (RB 1)
Signal	LTE (Crest factor: 1.0)
Frequency (MHz)	710
Relative permittivity (real part)	42.00
Conductivity (S/m)	0.90

Maximum location: X=5.00, Y=31.00

SAR Peak: 0.43 W/kg

SAR 10g (W/Kg)	0.264049
SAR 1g (W/Kg)	0.352514

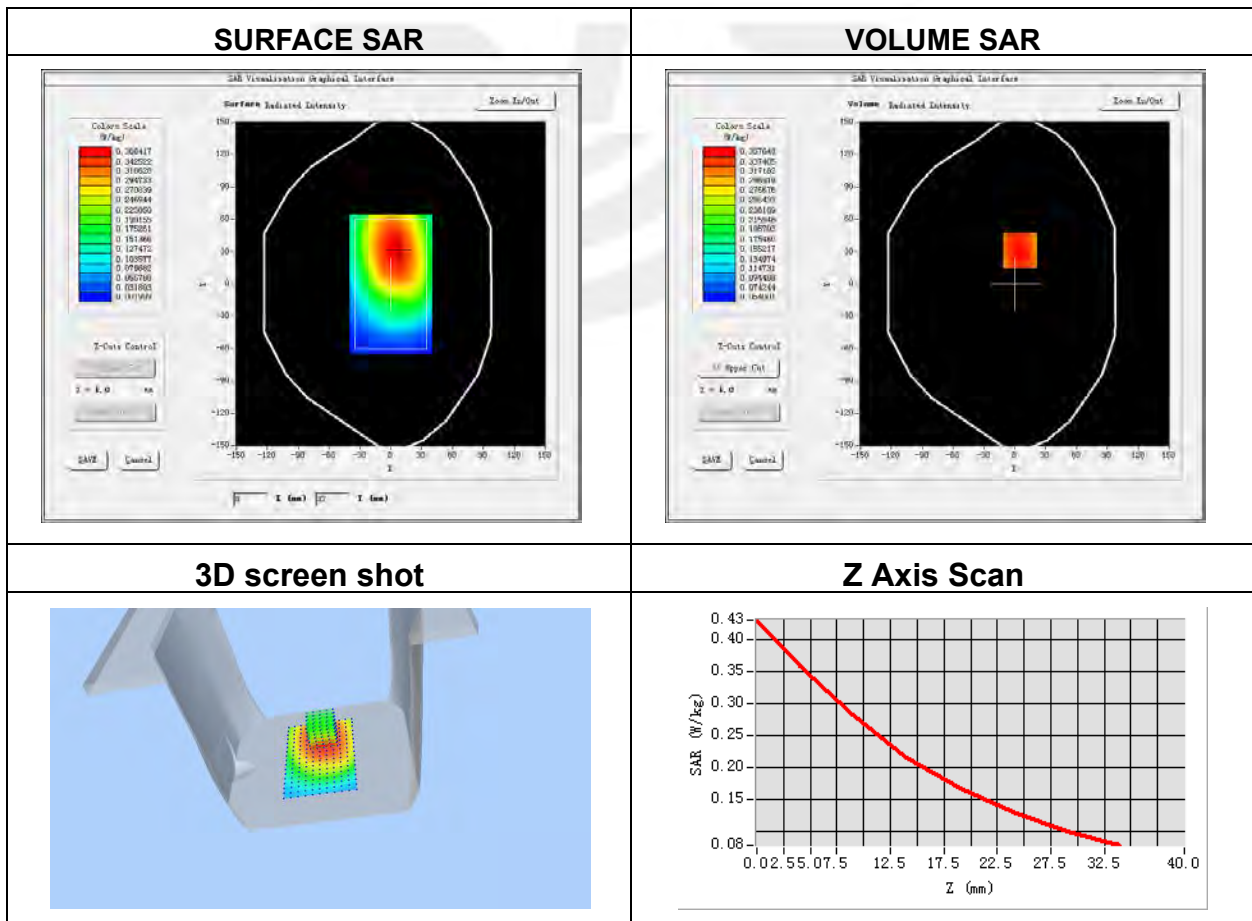

Plot 23: DUT: Mobile Phone; EUT Model: STUDIO X5 MAX

Test Date	2022-02-18
Probe	SN 07/21 EPGO352
Area Scan	dx=8mm, dy=8mm, h= 5.00 mm
Zoom Scan	5x5x7, dx=8mm, dy=8mm, dz=5mm, Complete/ndx=8mm, dy=8mm, h= 5.00 mm
Phantom	Left head
Device Position	Cheek
Band	LTE Band 66 (RB 1)
Signal	LTE (Crest factor: 1.0)
Frequency (MHz)	1720
Relative permittivity (real part)	40.4
Conductivity (S/m)	1.37

Maximum location: X=-56.00, Y=-57.00

SAR Peak: 0.16 W/kg

SAR 10g (W/Kg)	0.075320
SAR 1g (W/Kg)	0.114373

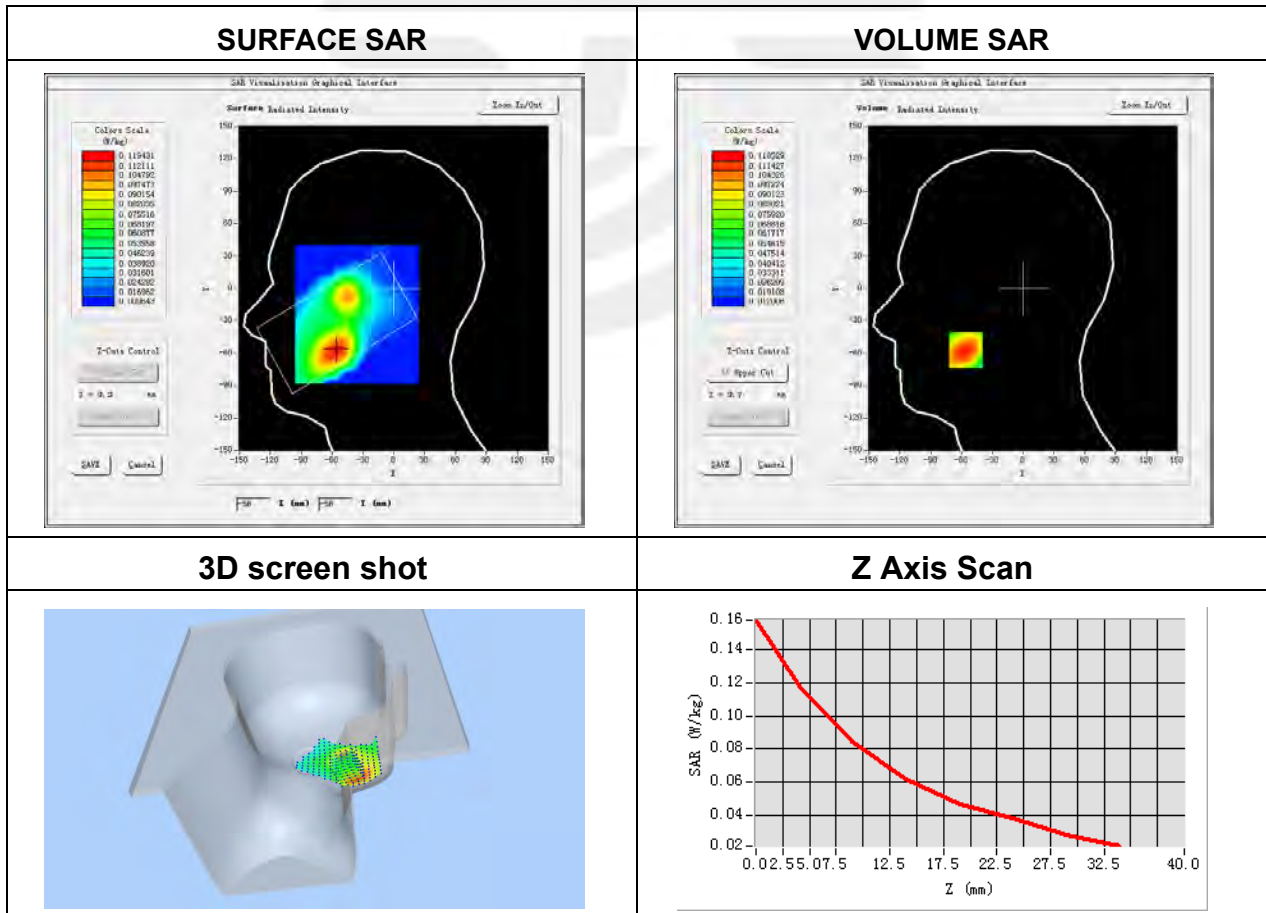

Plot 24: DUT: Mobile Phone; EUT Model: STUDIO X5 MAX

Test Date	2022-02-18
Probe	SN 07/21 EPGO352
Area Scan	dx=8mm, dy=8mm, h= 5.00 mm
Zoom Scan	5x5x7, dx=8mm, dy=8mm, dz=5mm, Complete/ndx=8mm, dy=8mm, h= 5.00 mm
Phantom	Validation plane
Device Position	Front side
Band	LTE Band 66 (RB 1)
Signal	LTE (Crest factor: 1.0)
Frequency (MHz)	1720
Relative permittivity (real part)	40.4
Conductivity (S/m)	1.37

Maximum location: X=-15.00, Y=-7.00

SAR Peak: 0.45 W/kg

SAR 10g (W/Kg)	0.180933
SAR 1g (W/Kg)	0.294777

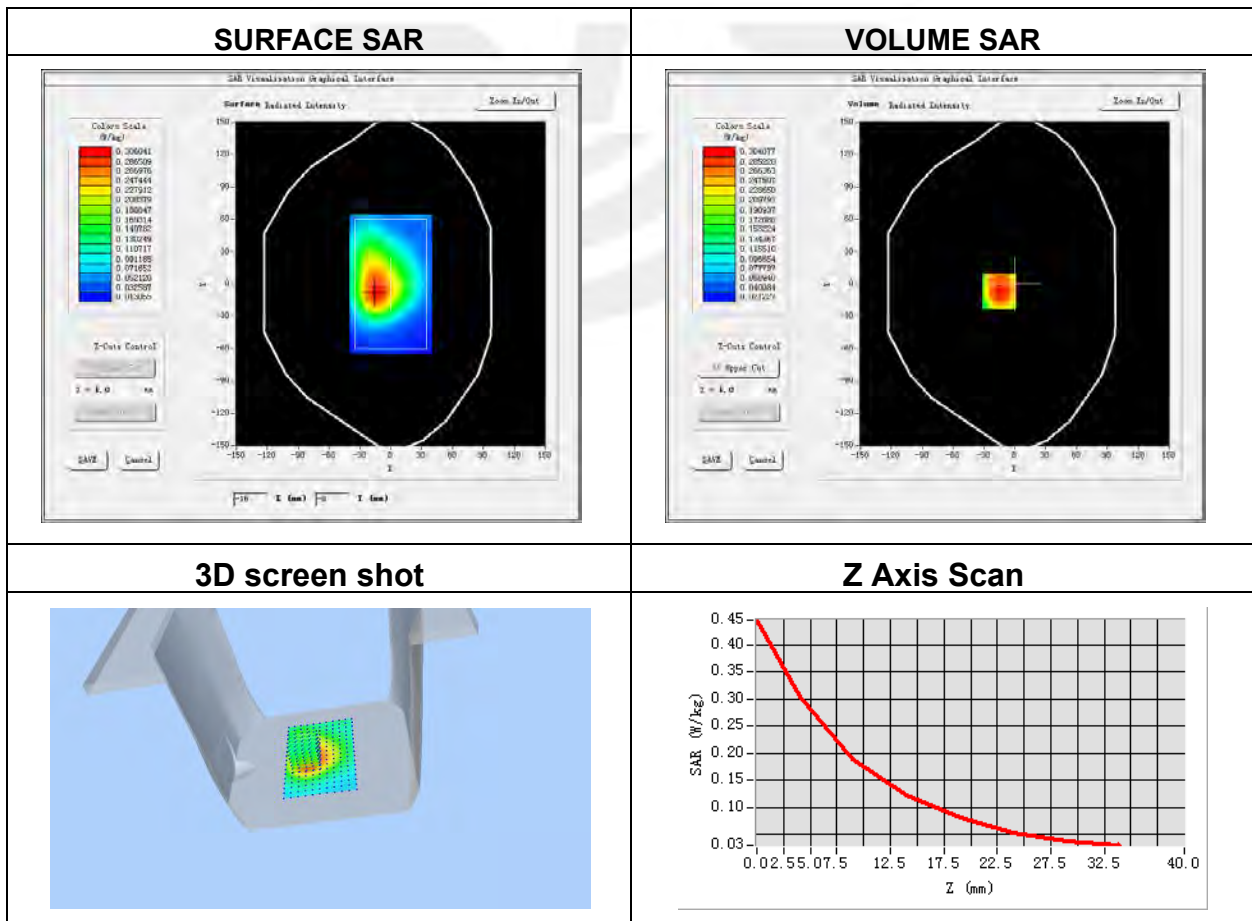

Plot 25: DUT: Mobile Phone; EUT Model: STUDIO X5 MAX

Test Date	2022-02-23
Probe	SN 07/21 EPGO352
Area Scan	dx=8mm, dy=8mm, h= 5.00 mm
Zoom Scan	5x5x7, dx=8mm, dy=8mm, dz=5mm, Complete/ndx=8mm, dy=8mm, h= 5.00 mm
Phantom	Right Cheek
Device Position	Cheek
Band	IEEE 802.11b ISM
Signal	IEEE802.b (Crest factor: 1.0)
Frequency (MHz)	2437
Relative permittivity (real part)	38.60
Conductivity (S/m)	1.75

Maximum location: X=0.00, Y=23.00
SAR Peak: 0.94 W/kg

SAR 10g (W/Kg)	0.275776
SAR 1g (W/Kg)	0.547361

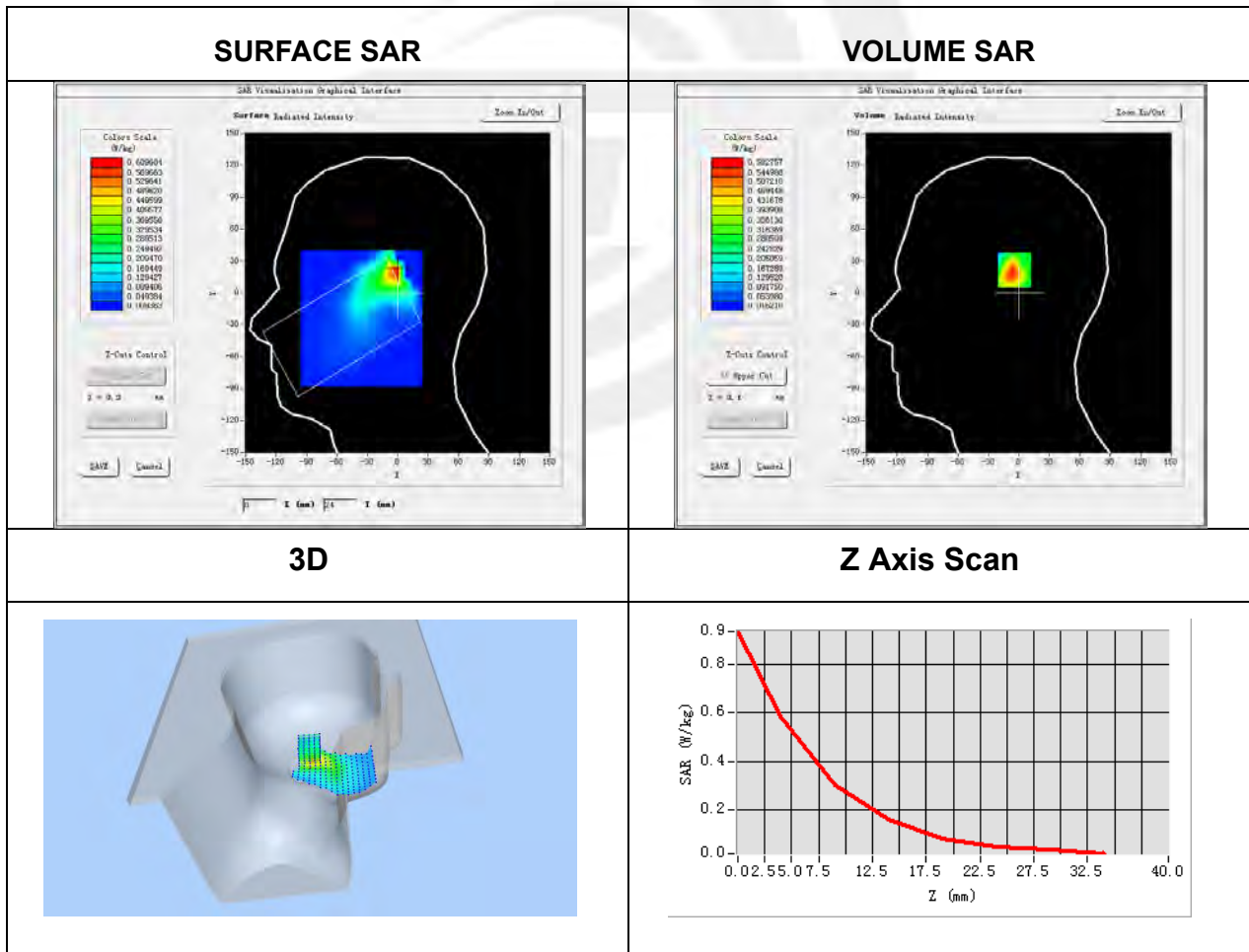

Plot 26: DUT: Mobile Phone; EUT Model: STUDIO X5 MAX

Test Date	2022-02-23
Probe	SN 07/21 EPGO352
Area Scan	dx=8mm, dy=8mm, h= 5.00 mm
Zoom Scan	5x5x7, dx=8mm, dy=8mm, dz=5mm, Complete/ndx=8mm, dy=8mm, h= 5.00 mm
Phantom	Validation plane
Device Position	Back Side
Band	IEEE 802.11b ISM
Signal	IEEE802.b (Crest factor: 1.0)
Frequency (MHz)	2437
Relative permittivity (real part)	38.60
Conductivity (S/m)	1.75

Maximum location: X=-14.00, Y=9.00

SAR Peak: 0.41 W/kg

SAR 10g (W/Kg)	0.113409
SAR 1g (W/Kg)	0.230244

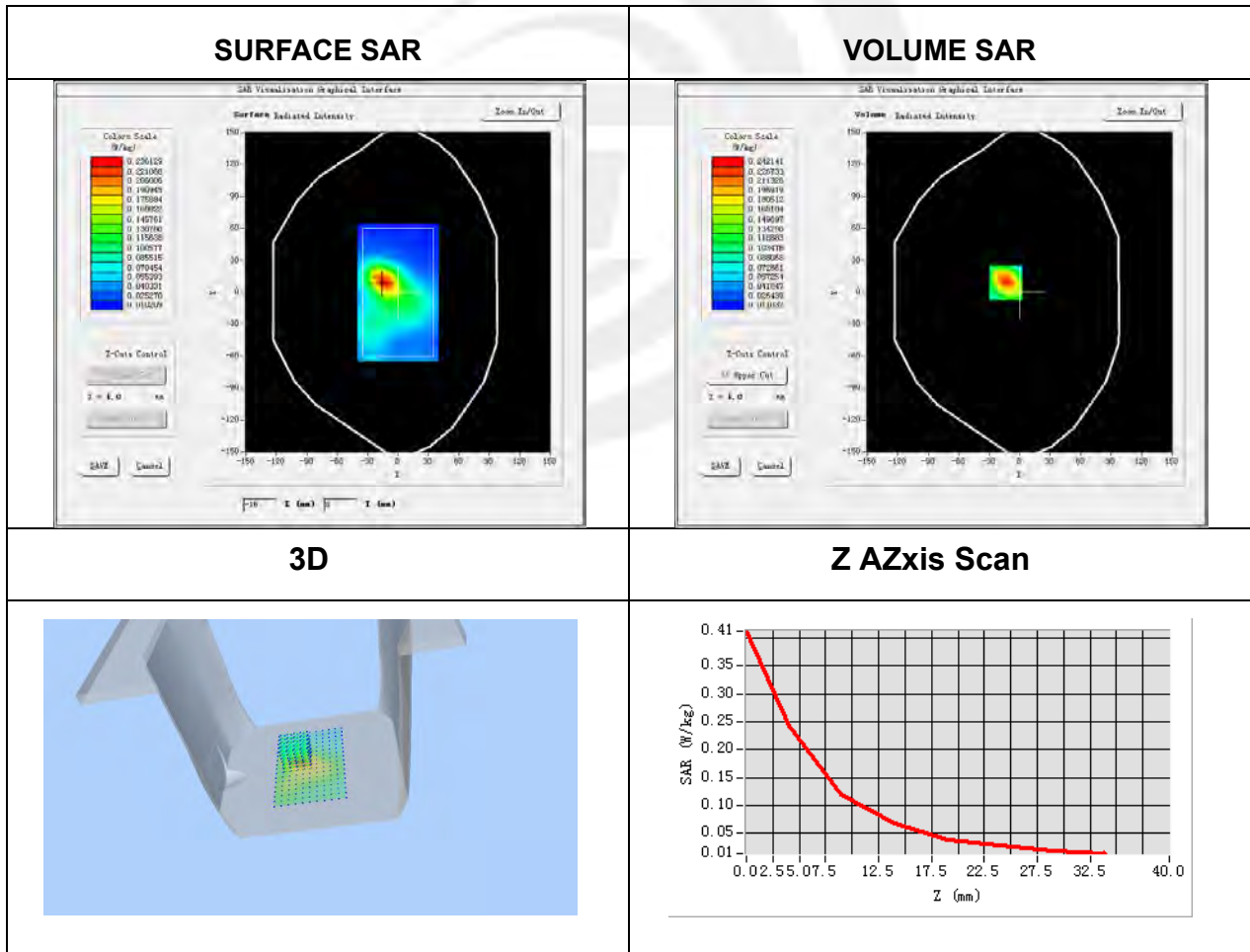

Plot 27: DUT: Mobile Phone; EUT Model: STUDIO X5 MAX

Test Date	2022-02-23
Probe	SN 07/21 EPGO352
Area Scan	dx=8mm, dy=8mm, h= 5.00 mm
Zoom Scan	5x5x7, dx=8mm, dy=8mm, dz=5mm, Complete/ndx=8mm, dy=8mm, h= 5.00 mm
Phantom	Left Cheek
Device Position	Cheek
Band	BT
Signal	GFSK (Crest factor: 1.0)
Frequency (MHz)	2402
Relative permittivity (real part)	39.23
Conductivity (S/m)	1.81

Maximum location: X=-29.00, Y=8.00
SAR Peak: 0.08 W/kg

SAR 10g (W/Kg)	0.012655
SAR 1g (W/Kg)	0.031088

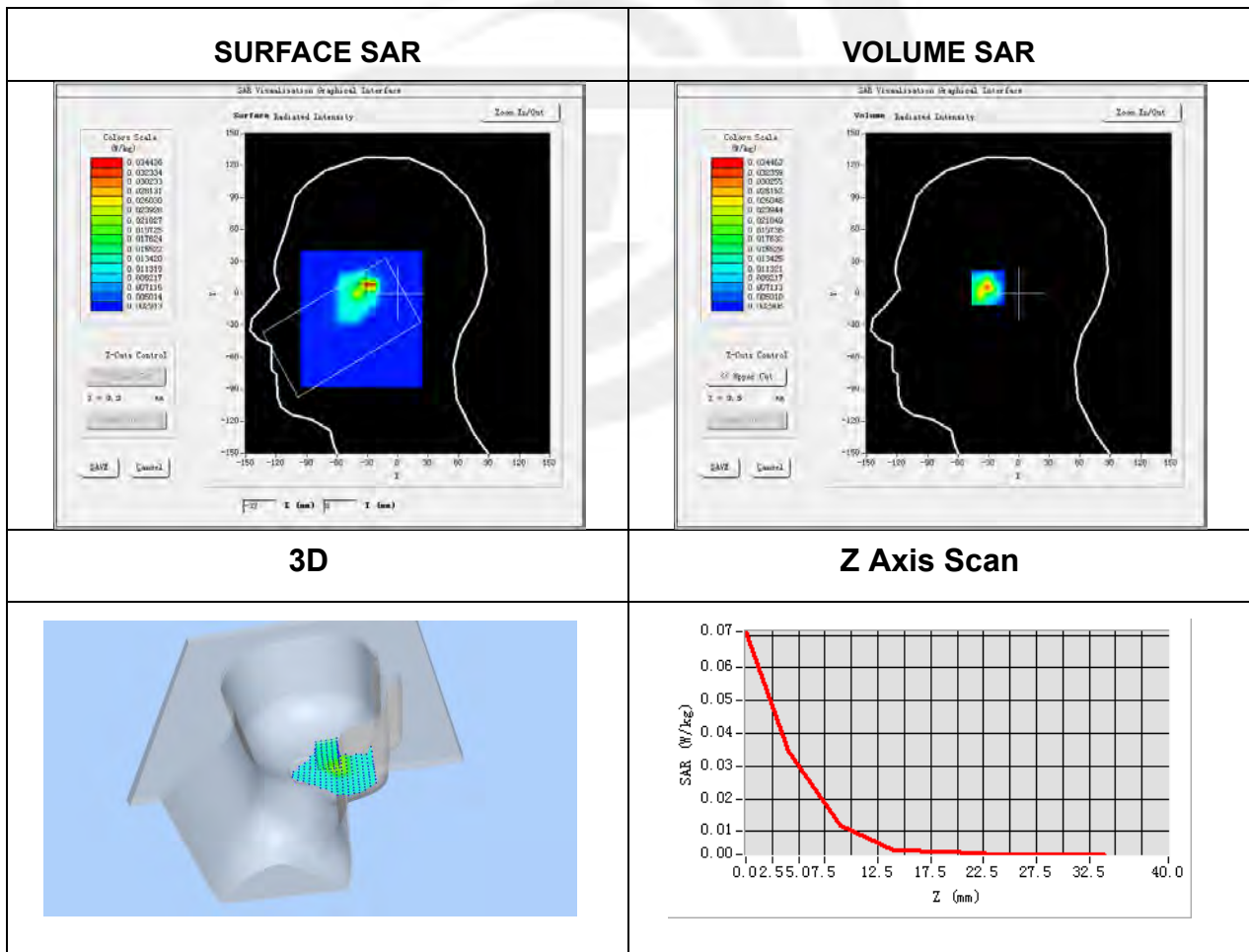

Plot 28: DUT: Mobile Phone; EUT Model: STUDIO X5 MAX

Test Date	2022-02-23
Probe	SN 07/21 EPGO352
Area Scan	dx=8mm, dy=8mm, h= 5.00 mm
Zoom Scan	5x5x7, dx=8mm, dy=8mm, dz=5mm, Complete/ndx=8mm, dy=8mm, h= 5.00 mm
Phantom	Validation plane
Device Position	Back Side
Band	BT
Signal	GFSK (Crest factor: 1.0)
Frequency (MHz)	2402
Relative permittivity (real part)	39.23
Conductivity (S/m)	1.81

Maximum location: X=0.00, Y=8.00

SAR Peak: 0.09 W/kg

SAR 10g (W/Kg)	0.020501
SAR 1g (W/Kg)	0.040711

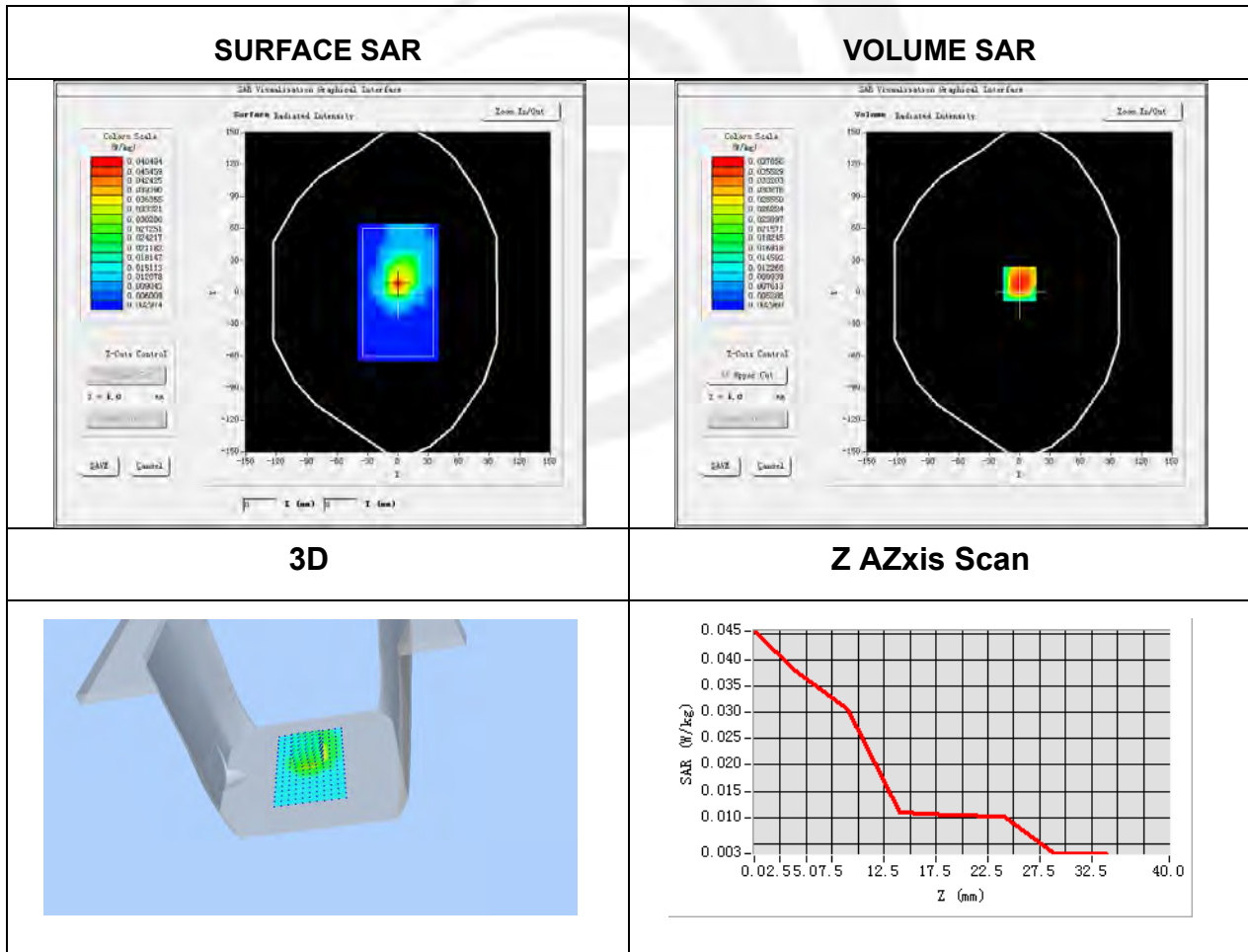

Plot 29: DUT: Mobile Phone; EUT Model: STUDIO X5 MAX

Test Date	2022-03-02
Probe	SN 07/21 EPGO352
Area Scan	dx=8mm, dy=8mm, h= 5.00 mm
Zoom Scan	7x7x12, dx=4mm, dy=4mm, dz=2mm, Complete/ndx=8mm, dy=8mm, h= 5.00 mm
Phantom	Left Cheek
Device Position	Cheek
Band	IEEE 802.11a ISM
Signal	IEEE802.a (Crest factor: 1.0)
Frequency (MHz)	5300
Relative permittivity (real part)	35.06
Conductivity (S/m)	4.70

Maximum location: X=-8.00, Y=16.00
SAR Peak: 0.13 W/kg

SAR 10g (W/Kg)	0.040905
SAR 1g (W/Kg)	0.054416

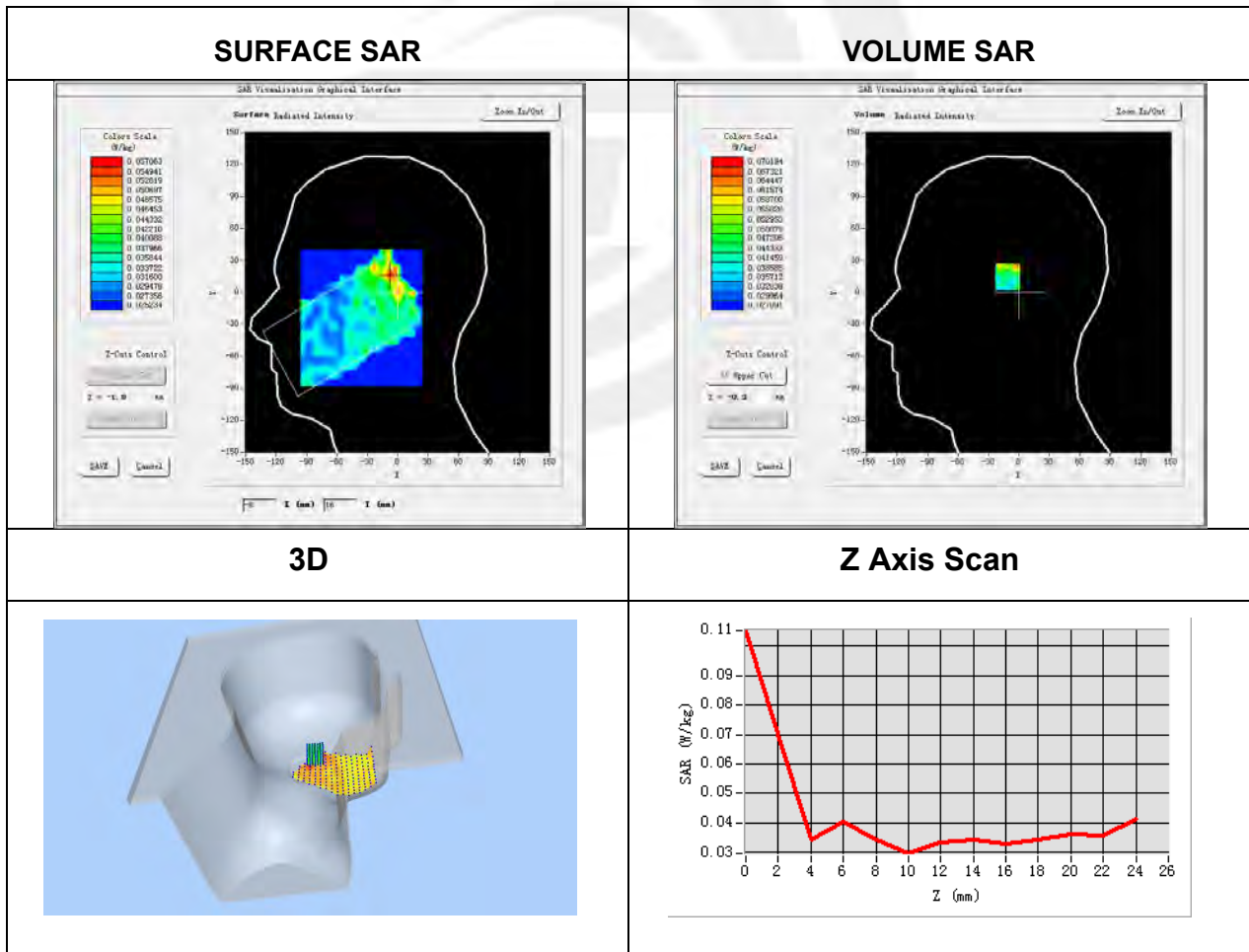

Plot 30: DUT: Mobile Phone; EUT Model: STUDIO X5 MAX

Test Date	2022-03-02
Probe	SN 07/21 EPGO352
Area Scan	dx=8mm, dy=8mm, h= 5.00 mm
Zoom Scan	7x7x12, dx=4mm, dy=4mm, dz=2mm, Complete/ndx=8mm, dy=8mm, h= 5.00 mm
Phantom	Validation plane
Device Position	Front Side
Band	IEEE 802.11a ISM
Signal	IEEE802.a (Crest factor: 1.0)
Frequency (MHz)	5300
Relative permittivity (real part)	35.06
Conductivity (S/m)	4.70

Maximum location: X=8.00, Y=-23.00

SAR Peak: 0.11 W/kg

SAR 10g (W/Kg)	0.035872
SAR 1g (W/Kg)	0.049064

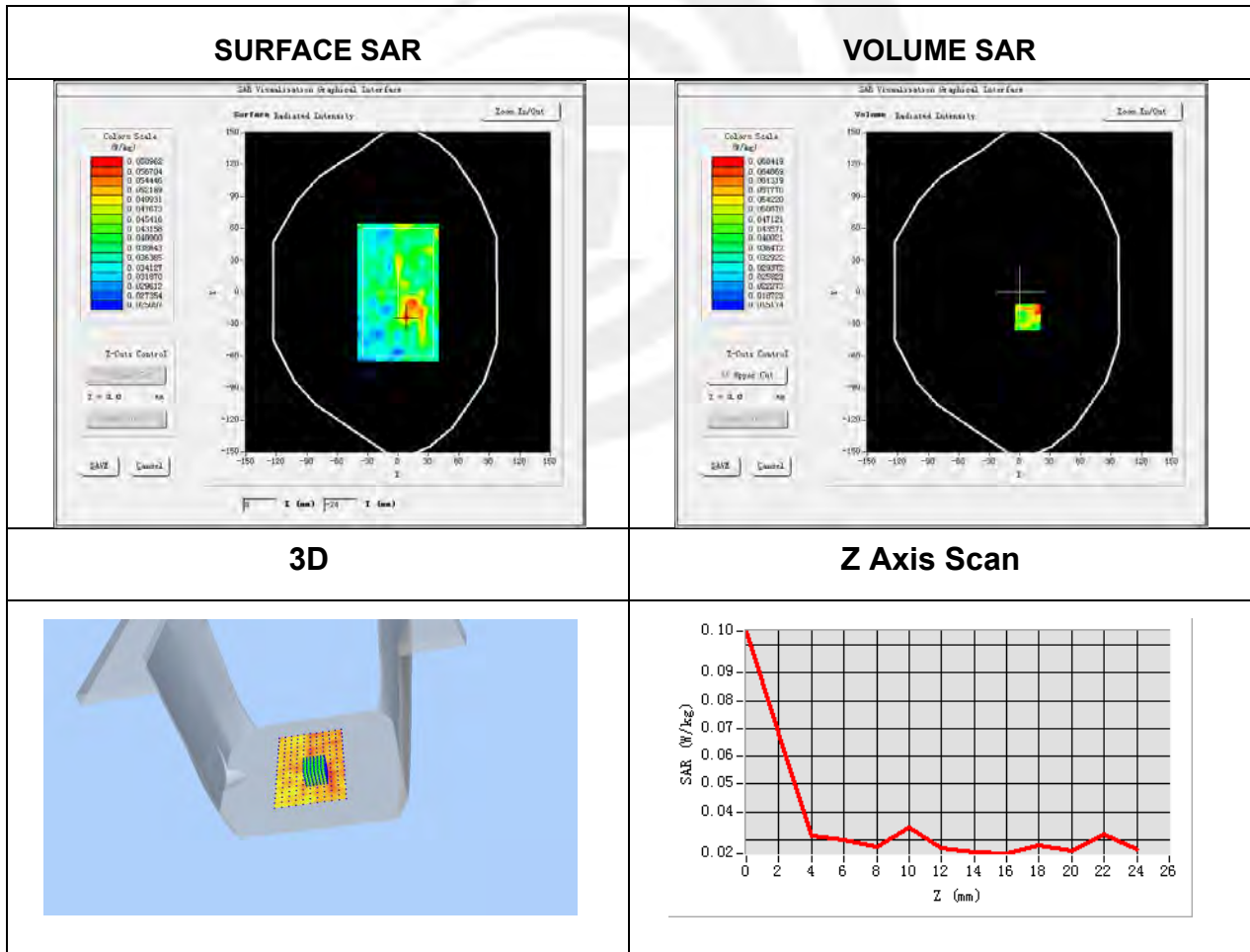

Plot 31: DUT: Mobile Phone; EUT Model: STUDIO X5 MAX

Test Date	2022-03-02
Probe	SN 07/21 EPGO352
Area Scan	dx=8mm, dy=8mm, h= 5.00 mm
Zoom Scan	7x7x12, dx=4mm, dy=4mm, dz=2mm, Complete/ndx=8mm, dy=8mm, h= 5.00 mm
Phantom	Left Cheek
Device Position	Cheek
Band	IEEE 802.11a ISM
Signal	IEEE802.a (Crest factor: 1.0)
Frequency (MHz)	5510
Relative permittivity (real part)	36.63
Conductivity (S/m)	5.00

Maximum location: X=-24.00, Y=17.00
SAR Peak: 0.17 W/kg

SAR 10g (W/Kg)	0.038536
SAR 1g (W/Kg)	0.064943

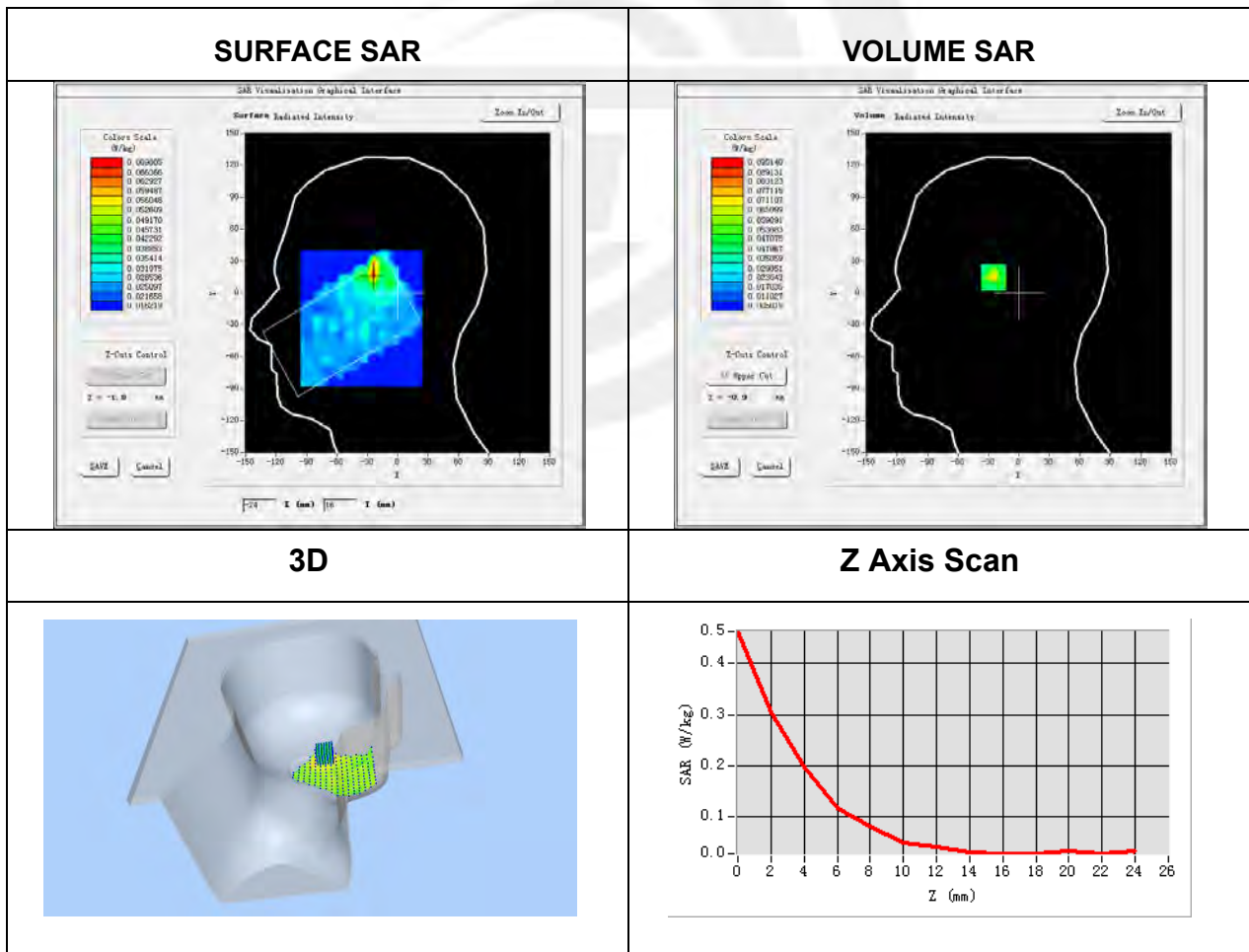

Plot 32: DUT: Mobile Phone; EUT Model: STUDIO X5 MAX

Test Date	2022-03-02
Probe	SN 07/21 EPGO352
Area Scan	dx=8mm, dy=8mm, h= 5.00 mm
Zoom Scan	7x7x12, dx=4mm, dy=4mm, dz=2mm, Complete/ndx=8mm, dy=8mm, h= 5.00 mm
Phantom	Validation plane
Device Position	Back Side
Band	IEEE 802.11a ISM
Signal	IEEE802.a (Crest factor: 1.0)
Frequency (MHz)	5510
Relative permittivity (real part)	36.63
Conductivity (S/m)	5.00

Maximum location: X=24.00, Y=-27.00

SAR Peak: 0.16 W/kg

SAR 10g (W/Kg)	0.045589
SAR 1g (W/Kg)	0.063190

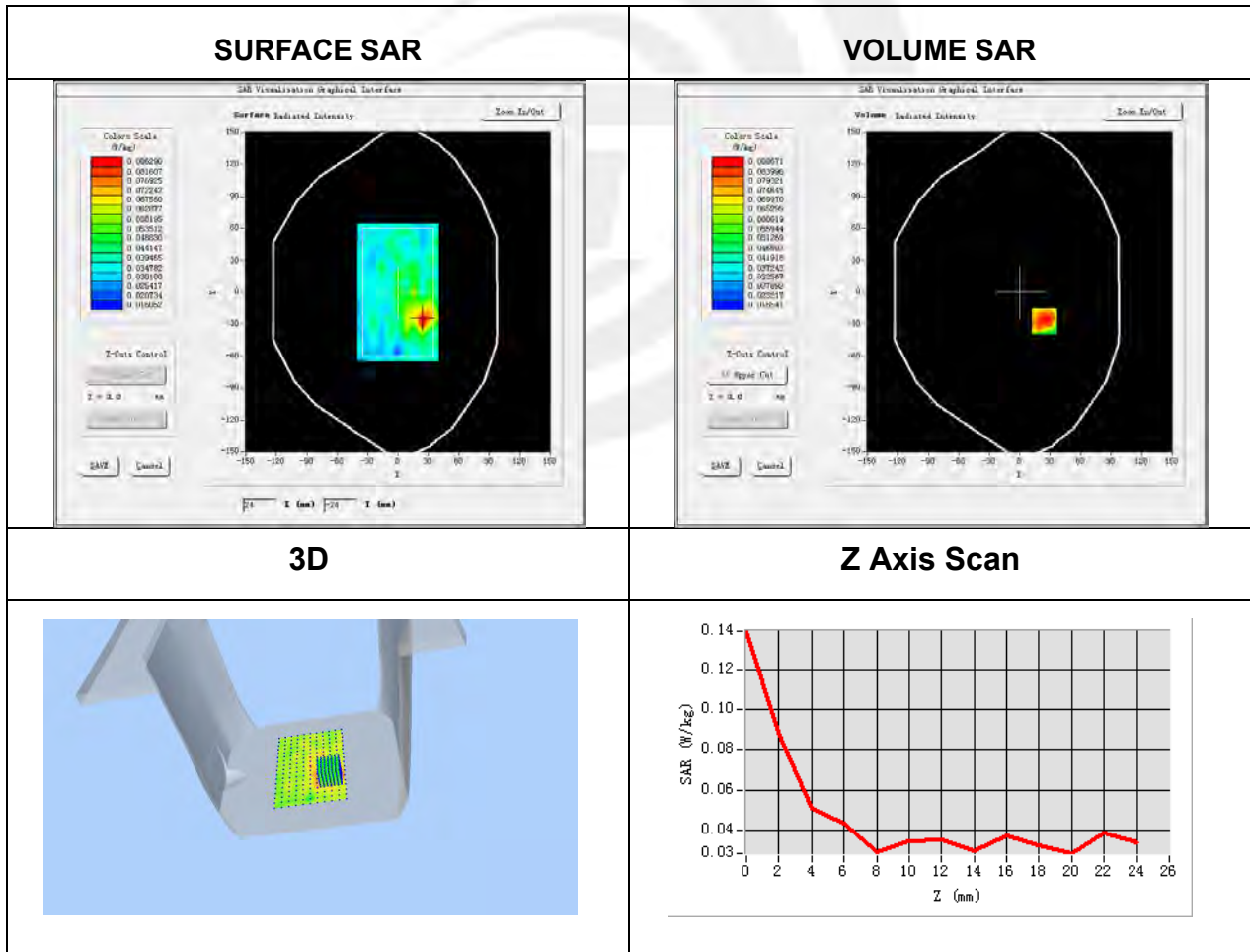

Plot 33: DUT: Mobile Phone; EUT Model: STUDIO X5 MAX

Test Date	2022-03-02
Probe	SN 07/21 EPGO352
Area Scan	dx=8mm, dy=8mm, h= 5.00 mm
Zoom Scan	7x7x12, dx=4mm, dy=4mm, dz=2mm, Complete/ndx=8mm, dy=8mm, h= 5.00 mm
Phantom	Left Cheek
Device Position	Cheek
Band	IEEE 802.11a ISM
Signal	IEEE802.a (Crest factor: 1.0)
Frequency (MHz)	5785
Relative permittivity (real part)	34.5
Conductivity (S/m)	5.23

Maximum location: X=0.00, Y=-5.00
SAR Peak: 0.15 W/kg

SAR 10g (W/Kg)	0.039682
SAR 1g (W/Kg)	0.054990

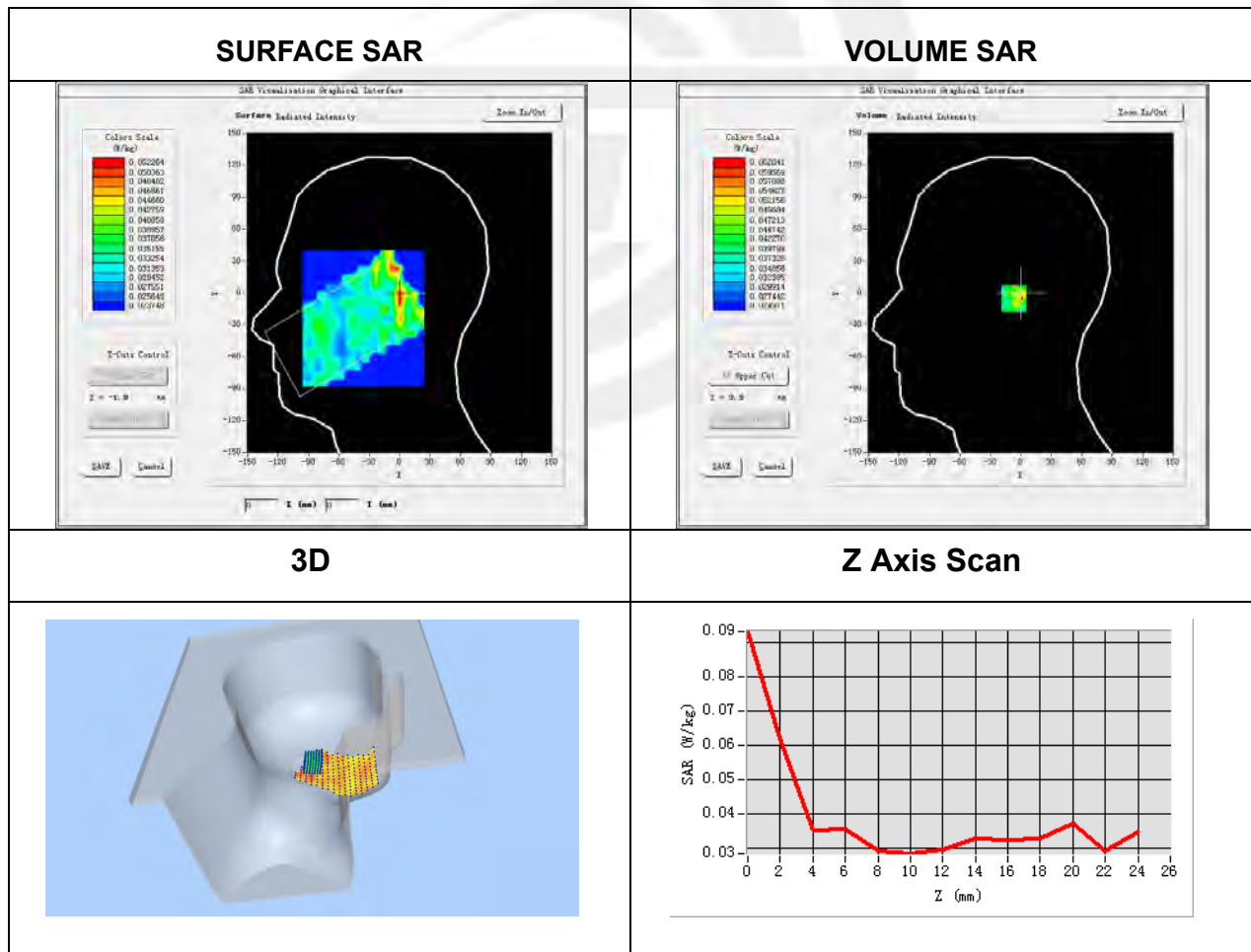

Plot 34: DUT: Mobile Phone; EUT Model: STUDIO X5 MAX

Test Date	2022-03-02
Probe	SN 07/21 EPGO352
Area Scan	dx=8mm, dy=8mm, h= 5.00 mm
Zoom Scan	7x7x12, dx=4mm, dy=4mm, dz=2mm, Complete/ndx=8mm, dy=8mm, h= 5.00 mm
Phantom	Validation plane
Device Position	Back Side
Band	IEEE 802.11a ISM
Signal	IEEE802.a (Crest factor: 1.0)
Frequency (MHz)	5785
Relative permittivity (real part)	34.5
Conductivity (S/m)	5.23

Maximum location: X=-16.00, Y=8.00

SAR Peak: 0.12 W/kg

SAR 10g (W/Kg)	0.037310
SAR 1g (W/Kg)	0.048222

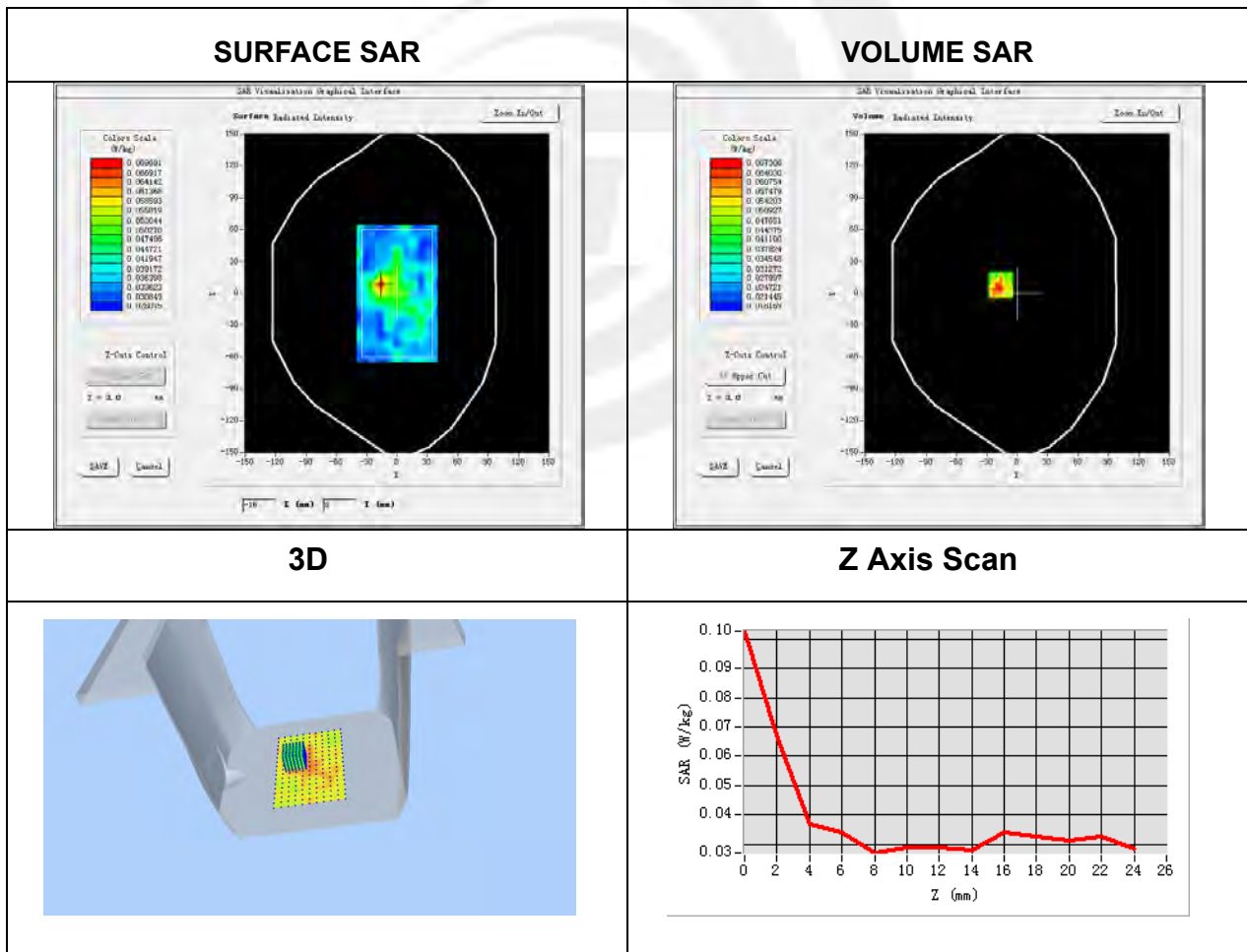



Appendix C. Probe Calibration and Dipole Calibration Report

Refer the appendix Calibration Report.

※※※※END OF THE REPORT※※※※

