

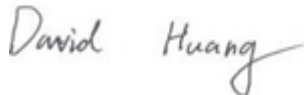

# RF TEST REPORT



Report No.: 17070437-FCC-R1-V1

Supersede Report No.: N/A

Applicant	BLU Products , Inc	
Product Name	Mobile phone	
Model No.	Studio PRO	
Serial No.	N/A	
Test Standard	FCC Part 22(H):2016 ;FCC Part 24(E):2016; FCC Part 27:2016; ANSI/TIA-603-D: 2010	
Test Date	June 14 to July 02, 2017	
Issue Date	July 19, 2017	
Test Result	<input checked="" type="checkbox"/> Pass <input type="checkbox"/> Fail	
Equipment complied with the specification	<input checked="" type="checkbox"/>	
Equipment did not comply with the specification	<input type="checkbox"/>	
		
Loren Luo Test Engineer	David Huang Checked By	
<p>This test report may be reproduced in full only Test result presented in this test report is applicable to the tested sample only</p>		

Issued by:

**SIEMIC (SHENZHEN-CHINA) LABORATORIES**

Zone A, Floor 1, Building 2 Wan Ye Long Technology Park

South Side of Zhoushi Road, Bao' an District, Shenzhen, Guangdong China 518108

Phone: +86 0755 2601 4629801 Email: [China@siemic.com.cn](mailto:China@siemic.com.cn)

## Laboratories Introduction

SIEMIC, headquartered in the heart of Silicon Valley, with superior facilities in US and Asia, is one of the leading independent testing and certification facilities providing customers with one-stop shop services for Compliance Testing and Global Certifications.



In addition to testing and certification, SIEMIC provides initial design reviews and compliance management throughout a project. Our extensive experience with China, Asia Pacific, North America, European, and International compliance requirements, assures the fastest, most cost effective way to attain regulatory compliance for the global markets.

### Accreditations for Conformity Assessment

Country/Region	Scope
USA	EMC, RF/Wireless, SAR, Telecom
Canada	EMC, RF/Wireless, SAR, Telecom
Taiwan	EMC, RF, Telecom, SAR, Safety
Hong Kong	RF/Wireless, SAR, Telecom
Australia	EMC, RF, Telecom, SAR, Safety
Korea	EMI, EMS, RF, SAR, Telecom, Safety
Japan	EMI, RF/Wireless, SAR, Telecom
Singapore	EMC, RF, SAR, Telecom
Europe	EMC, RF, SAR, Telecom, Safety

Test Report	17070437-FCC-R1-V1
Page	3 of 103

This page has been left blank intentionally.

# CONTENTS

1. REPORT REVISION HISTORY .....	5
2. CUSTOMER INFORMATION.....	5
3. TEST SITE INFORMATION .....	5
4. EQUIPMENT UNDER TEST (EUT) INFORMATION .....	6
5. TEST SUMMARY .....	9
6. MEASUREMENTS, EXAMINATION AND DERIVED RESULTS.....	10
6.1 RF EXPOSURE (SAR) .....	10
6.2 RF OUTPUT POWER.....	11
6.3 PEAK-AVERAGE RATIO.....	23
6.4 OCCUPIED BANDWIDTH .....	28
6.5 SPURIOUS EMISSIONS AT ANTENNA TERMINALS .....	43
6.6 SPURIOUS RADIATED EMISSIONS.....	59
6.7 BAND EDGE .....	66
6.8 FREQUENCY STABILITY.....	80
ANNEX A. TEST INSTRUMENT .....	85
ANNEX B. EUT AND TEST SETUP PHOTOGRAPHS.....	87
ANNEX C. TEST SETUP AND SUPPORTING EQUIPMENT.....	99
ANNEX C.II. EUT OPERATING CONKITIONS .....	101
ANNEX D. USER MANUAL / BLOCK DIAGRAM / SCHEMATICS / PARTLIST .....	102
ANNEX E. DECLARATION OF SIMILARITY .....	103

## 1. Report Revision History

Report No.	Report Version	Description	Issue Date
17070437-FCC-R1	NONE	Original	July 03, 2017
17070437-FCC-R1-V1	V1	Changed the EUT Photo	July 19, 2017

## 2. Customer information

Applicant Name	BLU Products , Inc
Applicant Add	10814 NW 33rd St # 100 Doral, FL 33172
Manufacturer	BLU Products , Inc
Manufacturer Add	10814 NW 33rd St # 100 Doral, FL 33172

## 3. Test site information

Lab performing tests	SIEMIC (Shenzhen-China) LABORATORIES
Lab Address	Zone A, Floor 1, Building 2 Wan Ye Long Technology Park South Side of Zhoushi Road, Bao' an District, Shenzhen, Guangdong China 518108
FCC Test Site No.	718246
IC Test Site No.	4842E-1
Test Software	Radiated Emission Program-To Shenzhen v2.0



WIFI: 802.11b/g/n(20M): 2412-2462 MHz  
WIFI: 802.11n(40M): 2422-2452 MHz  
Bluetooth& BLE: 2402-2480 MHz  
GPS: 1575.42 MHz

GSM Voice:GSM850: 32.08 dBm  
PCS1900: 30.07 dBm

GPRS:GSM850: 32.07 dBm  
PCS1900: 29.86 dBm

EGPRS(MCS1):GSM850: 32.05 dBm  
PCS1900: 29.84 dBm

Maximum Conducted  
AV Power to Antenna:

RMC:UMTS-FDD Band V: 22.51 dBm  
UMTS-FDD Band II: 22.79 dBm  
UMTS-FDD Band IV: 22.66 dBm  
HSDPA:UMTS-FDD Band V: 22.01 dBm  
UMTS-FDD Band II: 22.26 dBm  
UMTS-FDD Band IV: 22.13 dBm  
HSUPA:UMTS-FDD Band V:21.79 dBm  
UMTS-FDD Band II: 22.11 dBm  
UMTS-FDD Band IV: 21.93 dBm

GSM Voice:GSM850: 28.91 dBm / ERP  
PCS1900: 28.87 dBm / EIRP

GPRS:GSM850: 28.90 dBm / ERP  
PCS1900: 28.66 dBm / EIRP

EGPRS(MCS1):GSM850: 28.88 dBm / ERP  
PCS1900: 28.94 dBm / EIRP

ERP/EIRP:

RMC:UMTS-FDD Band V: 19.16 dBm / ERP  
UMTS-FDD Band II: 21.62 dBm / EIRP  
UMTS-FDD Band IV: 21.63 dBm / EIRP  
HSDPA:UMTS-FDD Band V: 18.66 dBm / ERP  
UMTS-FDD Band II: 21.06 dBm / EIRP  
UMTS-FDD Band IV: 21.10 dBm / EIRP  
HSUPA:UMTS-FDD Band V: 18.44 dBm / ERP  
UMTS-FDD Band II: 20.91 dBm / EIRP  
UMTS-FDD Band IV: 20.90 dBm / EIRP

Number of Channels: GSM 850: 124CH  
PCS1900: 299CH  
UMTS-FDD Band V: 102CH  
UMTS-FDD Band IV: 202CH  
UMTS-FDD Band II: 277CH  
WIFI :802.11b/g/n(20M): 11CH  
WIFI :802.11n(40M): 7CH  
Bluetooth: 79CH  
BLE: 40CH  
GPS:1CH

Port: USB Port, Earphone Port

Input Power: Adapter:  
Model: TPA-46B050100UU  
Input: AC100-240V~50/60Hz,0.2A  
Output: DC 5.0V,1.0A  
Battery:  
Model: C745243200L  
Spec : 3.8V,2000mAh,7.60Wh

Trade Name : BLU

GPRS/EGPRS Multi-slot class 8/10/12

FCC ID: YHLBLUSTUDIOPRO



## 5. Test Summary

The product was tested in accordance with the following specifications.

All testing has been performed according to below product classification:

FCC Rules	Description of Test	Result
§ 1.1307; § 2.1093	RF Exposure (SAR)	Compliance
§2.1046; § 22.913(a); § 24.232(c); § 27.50(c.10) ; § 27.50(d.4)	RF Output Power	Compliance
§ 24.232 (d) ; § 27.50(d)	Peak-Average Ratio	Compliance
§ 2.1049; § 22.905; § 22.917; § 24.238; § 27.53(a.5)	99% & -26 dB Occupied Bandwidth	Compliance
§ 2.1051; § 22.917(a); § 24.238(a); § 27.53(h)	Spurious Emissions at Antenna Terminal	Compliance
§ 2.1053; § 22.917(a); § 24.238(a); § 27.53(h)	Field Strength of Spurious Radiation	Compliance
§ 22.917(a); § 24.238(a); § 27.53(h)	Out of band emission, Band Edge	Compliance
§ 2.1055; § 22.355; § 24.235; § 27.5(h); § 27.54	Frequency stability vs. temperature Frequency stability vs. voltage	Compliance

Note: Testing was performed by configuring EUT to maximum output power status, the declared output power class for different

### Measurement Uncertainty

Emissions		
Test Item	Description	Uncertainty
Band Edge and Radiated Spurious Emissions	Confidence level of approximately 95% (in the case where distributions are normal), with a coverage factor of 2 (for EUTs < 0.5m X 0.5m X 0.5m)	+5.6dB/-4.5dB
-	-	-

## 6. MEASUREMENTS, EXAMINATION AND DERIVED RESULTS

### 6.1 RF Exposure (SAR)

Test Result: Pass

The EUT is a portable device, thus requires SAR evaluation;

Please refer to RF Exposure Evaluation Report: 17070437-FCC-H.

## 6.2 RF Output Power

Temperature	23 °C
Relative Humidity	54%
Atmospheric Pressure	1020mbar
Test date :	June 28, 2017
Tested By :	Loren Luo

### Requirement(s):

Spec	Item	Requirement	Applicable
§22.913 (a)	a)	ERP:38.45dBm	<input checked="" type="checkbox"/>
§24.232 (c)	b)	EIRP:33dBm	<input checked="" type="checkbox"/>
§27.50 (c)	c)	EIRP: 30dBm	<input checked="" type="checkbox"/>

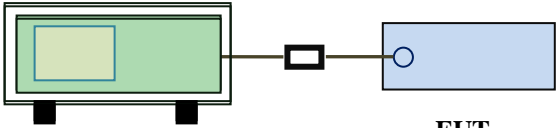
Test Setup	 <p style="text-align: center;">Base Station                      EUT</p>
------------	---

Test Procedure	<p>For Conducted Power:</p> <ul style="list-style-type: none"> <li>- The transmitter output port was connected to base station.</li> <li>- Set EUT at maximum power through base station.</li> <li>- Select lowest, middle, and highest channels for each band and different test mode.</li> </ul> <p>For ERP/EIRP:</p> <p>According with KDB 971168 v02r02</p> <ul style="list-style-type: none"> <li>- The transmitter was placed on a wooden turntable, and it was transmitting into a non-radiating load which was also placed on the turntable.</li> <li>- The measurement antenna was placed at a distance of 3 meters from the EUT. During the tests, the antenna height and polarization as well as EUT azimuth were varied in order to identify the maximum level of emissions from the EUT. The test was performed by placing the EUT on 3-orthogonal axis.</li> <li>- The frequency range up to tenth harmonic of the fundamental</li> </ul>
----------------	---

	<p>frequency was investigated.</p> <ul style="list-style-type: none"> <li>- Remove the EUT and replace it with substitution antenna. A signal generator was connected to the substitution antenna by a non-radiating cable. The absolute levels of the spurious emissions were measured by the substitution.</li> <li>- Spurious emissions in dB = <math>10 \log (\text{TX power in Watts}/0.001)</math> – the absolute level</li> <li>- Spurious attenuation limit in dB = <math>43 + 10 \text{ Log}_{10} (\text{power out in Watts})</math>.</li> </ul>
Remark	
Result	<input checked="" type="checkbox"/> Pass <input type="checkbox"/> Fail

Test Data     Yes                       N/A

Test Plot     Yes (See below)             N/A

## Conducted Power

### GSM Mode:

Burst Average Power (dBm);								
Band	GSM850				PCS1900			
Channel	128	190	251	Tune up Power tolerant	512	661	810	Tune up Power tolerant
Frequency (MHz)	824.2	836.6	848.8	/	1850.2	1880	1909.8	/
GSM Voice (1 uplink),GMSK	<b>32.08</b>	31.96	31.77	32±1	30.06	30.01	<b>30.07</b>	30±1
GPRS Multi-Slot Class 8 (1 uplink),GMSK	<b>32.07</b>	31.91	31.77	32±1	29.85	29.81	<b>29.86</b>	29.5±1
GPRS Multi-Slot Class 10 (2 uplink) GMSK	30.85	30.7	30.56	30.5±1	29.4	29.43	29.48	29.5±1
GPRS Multi-Slot Class 12 (4 uplink) GMSK	27.86	27.72	27.61	27.5±1	26.48	26.51	26.49	26.5±1
EGPRS Multi-Slot Class 8 (1 uplink) GMSK MCS1	<b>32.05</b>	31.9	31.65	32±1	<b>29.84</b>	29.8	29.83	29.5±1
EGPRS Multi-Slot Class 10 (2 uplink) GMSK MCS1	30.75	30.65	30.5	30.5±1	29.37	29.36	29.42	29.5±1
EGPRS Multi-Slot Class 12 (4 uplink) GMSK MCS1	27.83	27.71	27.6	27.5±1	26.42	26.45	26.45	26.5±1

Remark :

GPRS, CS1 coding scheme.

EGPRS, MCS1 coding scheme.

Multi-Slot Class 8 , Support Max 4 downlink, 1 uplink , 5 working link

Multi-Slot Class 10 , Support Max 4 downlink, 2 uplink , 5 working link

Multi-Slot Class 12 , Support Max 4 downlink, 4 uplink , 5 working link

## UMTS Mode:

### UMTS-FDD Band V

Band/ Time Slot configuration	Channel	Frequency	Average power (dBm)	Tune up Power tolerant
RMC 12.2kbps	4132	826.4	22.48	22.5±1
	4175	835	<b>22.51</b>	22.5±1
	4233	846.6	22.41	22.5±1
HSDPA Subtest1	4132	826.4	21.77	22±1
	4175	835	21.79	22±1
	4233	846.6	21.61	22±1
HSDPA Subtest2	4132	826.4	21.96	22±1
	4175	835	<b>22.01</b>	22±1
	4233	846.6	21.85	22±1
HSDPA Subtest3	4132	826.4	21.68	22±1
	4175	835	21.76	22±1
	4233	846.6	21.69	22±1
HSDPA Subtest4	4132	826.4	21.89	22±1
	4175	835	21.91	22±1
	4233	846.6	21.81	22±1
HSUPA Subtest1	4132	826.4	21.75	22±1
	4175	835	21.75	22±1
	4233	846.6	21.67	22±1
HSUPA Subtest2	4132	826.4	21.77	22±1
	4175	835	<b>21.79</b>	22±1
	4233	846.6	21.70	22±1
HSUPA Subtest3	4132	826.4	21.69	22±1
	4175	835	21.76	22±1
	4233	846.6	21.65	22±1
HSUPA Subtest4	4132	826.4	21.73	22±1
	4175	835	21.73	22±1
	4233	846.6	21.66	22±1
HSUPA Subtest5	4132	826.4	21.77	22±1
	4175	835	21.72	22±1
	4233	846.6	21.67	22±1

## UMTS-FDD Band II

Band/ Time Slot configuration	Channel	Frequency	Average power (dBm)	Tune up Power tolerant
RMC 12.2kbps	9262	1852.4	22.82	22.5±1
	9400	1880	<b>22.79</b>	22.5±1
	9538	1907.6	22.41	22.5±1
HSDPA Subtest1	9262	1852.4	22.08	22±1
	9400	1880	22.03	22±1
	9538	1907.6	21.63	22±1
HSDPA Subtest2	9262	1852.4	22.26	22±1
	9400	1880	<b>22.26</b>	22±1
	9538	1907.6	21.88	22±1
HSDPA Subtest3	9262	1852.4	22.11	22±1
	9400	1880	22.09	22±1
	9538	1907.6	21.65	22±1
HSDPA Subtest4	9262	1852.4	22.24	22±1
	9400	1880	22.16	22±1
	9538	1907.6	21.81	22±1
HSUPA Subtest1	9262	1852.4	22.03	22±1
	9400	1880	21.99	22±1
	9538	1907.6	21.69	22±1
HSUPA Subtest2	9262	1852.4	22.11	22±1
	9400	1880	22.08	22±1
	9538	1907.6	21.68	22±1
HSUPA Subtest3	9262	1852.4	22.03	22±1
	9400	1880	22.00	22±1
	9538	1907.6	21.62	22±1
HSUPA Subtest4	9262	1852.4	<b>22.11</b>	22±1
	9400	1880	22.04	22±1
	9538	1907.6	21.62	22±1
HSUPA Subtest5	9262	1852.4	22.1	22±1
	9400	1880	22.07	22±1
	9538	1907.6	21.69	22±1

### UMTS-FDD Band IV

Band/ Time Slot configuration	Channel	Frequency	Average power (dBm)	Tune up Power tolerant
RMC 12.2kbps	1313	1712.6	22.14	22.5±1
	1413	1732.6	<b>22.66</b>	22.5±1
	1512	1752.4	22.38	22.5±1
HSDPA Subtest1	1313	1712.6	21.44	22±1
	1413	1732.6	21.87	22±1
	1512	1752.4	21.59	22±1
HSDPA Subtest2	1313	1712.6	21.61	22±1
	1413	1732.6	<b>22.13</b>	22±1
	1512	1752.4	21.83	22±1
HSDPA Subtest3	1313	1712.6	21.41	22±1
	1413	1732.6	21.95	22±1
	1512	1752.4	21.61	22±1
HSDPA Subtest4	1313	1712.6	21.54	22±1
	1413	1732.6	22.09	22±1
	1512	1752.4	21.74	22±1
HSUPA Subtest1	1313	1712.6	21.42	22±1
	1413	1732.6	21.92	22±1
	1512	1752.4	21.65	22±1
HSUPA Subtest2	1313	1712.6	21.42	22±1
	1413	1732.6	<b>21.93</b>	22±1
	1512	1752.4	21.67	22±1
HSUPA Subtest3	1313	1712.6	21.41	22±1
	1413	1732.6	21.87	22±1
	1512	1752.4	21.60	22±1
HSUPA Subtest4	1313	1712.6	21.36	22±1
	1413	1732.6	21.90	22±1
	1512	1752.4	21.59	22±1
HSUPA Subtest5	1313	1712.6	21.42	22±1
	1413	1732.6	21.91	22±1
	1512	1752.4	21.64	22±1



## ERP & EIRP

### GSM Voice

#### ERP for Cellular Band (Part 22H)

Frequency (MHz)	Substituted level (dBm)	Antenna Polarization	Antenna Gain correction (dBi)	Cable Loss (dB)	Absolute Level (dBm)	Limit (dBm)
824.2	23.34	V	6.1	0.53	<b>28.91</b>	38.45
824.2	21.88	H	6.1	0.53	27.45	38.45
836.6	23.12	V	6.2	0.53	28.79	38.45
836.6	21.54	H	6.2	0.53	27.21	38.45
848.8	22.93	V	6.2	0.53	28.60	38.45
848.8	21.48	H	6.2	0.53	27.15	38.45

#### EIRP for PCS Band (Part 24E)

Frequency (MHz)	Substituted level (dBm)	Antenna Polarization	Antenna Gain correction (dBi)	Cable Loss (dB)	Absolute Level (dBm)	Limit (dBm)
1850.2	21.7	V	7.88	0.72	28.86	33
1850.2	19.73	H	7.88	0.72	26.89	33
1880	21.66	V	7.88	0.72	28.82	33
1880	19.96	H	7.88	0.72	27.12	33
1909.8	21.73	V	7.86	0.72	<b>28.87</b>	33
1909.8	20.2	H	7.86	0.72	27.34	33

**GPRS:**

**ERP for Cellular Band (Part 22H)**

Frequency (MHz)	Substituted level (dBm)	Antenna Polarization	Antenna Gain correction (dBi)	Cable Loss (dB)	Absolute Level (dBm)	Limit (dBm)
824.2	23.33	V	6.1	0.53	<b>28.9</b>	38.45
824.2	21.55	H	6.1	0.53	27.12	38.45
836.6	23.07	V	6.2	0.53	28.74	38.45
836.6	21.41	H	6.2	0.53	27.08	38.45
848.8	22.93	V	6.2	0.53	28.6	38.45
848.8	21.03	H	6.2	0.53	26.7	38.45

**EIRP for PCS Band (Part 24E)**

Frequency (MHz)	Substituted level (dBm)	Antenna Polarization	Antenna Gain correction (dBi)	Cable Loss (dB)	Absolute Level (dBm)	Limit (dBm)
1850.2	21.49	V	7.88	0.72	28.65	33
1850.2	20.62	H	7.88	0.72	27.78	33
1880	21.45	V	7.88	0.72	28.61	33
1880	20.13	H	7.88	0.72	27.29	33
1909.8	21.52	V	7.86	0.72	<b>28.66</b>	33
1909.8	20.95	H	7.86	0.72	28.09	33

**EGPRS (MCS1):**

**ERP for Cellular Band (Part 22H)**

Frequency (MHz)	Substituted level (dBm)	Antenna Polarization	Antenna Gain correction (dBi)	Cable Loss (dB)	Absolute Level (dBm)	Limit (dBm)
824.2	23.31	V	6.1	0.53	<b>28.88</b>	38.45
824.2	22.64	H	6.1	0.53	28.21	38.45
836.6	23.06	V	6.2	0.53	28.73	38.45
836.6	22.37	H	6.2	0.53	28.04	38.45
848.8	22.81	V	6.2	0.53	28.48	38.45
848.8	21.71	H	6.2	0.53	27.38	38.45

**EIRP for PCS Band (Part 24E)**

Frequency (MHz)	Substituted level (dBm)	Antenna Polarization	Antenna Gain correction (dBi)	Cable Loss (dB)	Absolute Level (dBm)	Limit (dBm)
1850.2	21.78	V	7.88	0.72	<b>28.94</b>	33
1850.2	20.19	H	7.88	0.72	27.35	33
1880	21.44	V	7.88	0.72	28.6	33
1880	20.81	H	7.88	0.72	27.97	33
1909.8	21.49	V	7.86	0.72	28.63	33
1909.8	20.43	H	7.86	0.72	27.57	33

## RMC

### ERP for UMTS-FDD Band V (Part 22H)

Frequency (MHz)	Substituted level (dBm)	Antenna Polarization	Antenna Gain correction (dBi)	Cable Loss (dB)	Absolute Level (dBm)	Limit (dBm)
826.4	13.56	V	6.1	0.53	19.13	38.45
826.4	12.85	H	6.1	0.53	18.42	38.45
835	13.49	V	6.2	0.53	<b>19.16</b>	38.45
835	12.47	H	6.2	0.53	18.14	38.45
846.6	13.39	V	6.2	0.53	19.06	38.45
846.6	11.61	H	6.2	0.53	17.28	38.45

### EIRP for UMTS-FDD Band II (Part 24E)

Frequency (MHz)	Substituted level (dBm)	Antenna Polarization	Antenna Gain correction (dBi)	Cable Loss (dB)	Absolute Level (dBm)	Limit (dBm)
1852.4	14.46	V	7.88	0.72	<b>21.62</b>	33
1852.4	13.09	H	7.88	0.72	20.25	33
1880	14.43	V	7.88	0.72	21.59	33
1880	14.15	H	7.88	0.72	21.31	33
1907.6	14.07	V	7.86	0.72	21.21	33
1907.6	14.01	H	7.86	0.72	21.15	33

### EIRP for UMTS-FDD Band IV (Part 27H)

Frequency (MHz)	Substituted level (dBm)	Antenna Polarization	Antenna Gain correction (dBi)	Cable Loss (dB)	Absolute Level (dBm)	Limit (dBm)
1712.4	13.85	V	7.95	0.69	21.11	30
1712.4	12.19	H	7.95	0.69	19.45	30
1740	14.39	V	7.93	0.69	<b>21.63</b>	30
1740	13.16	H	7.93	0.69	20.40	30
1752.6	14.12	V	7.92	0.69	21.35	30
1752.6	12.97	H	7.92	0.69	20.20	30

## HSDPA

### ERP for UMTS-FDD Band V (Part 22H)

Frequency (MHz)	Substituted level (dBm)	Antenna Polarization	Antenna Gain correction (dBi)	Cable Loss (dB)	Absolute Level (dBm)	Limit (dBm)
826.4	12.56	V	6.1	0.53	18.13	38.45
826.4	11.69	H	6.1	0.53	17.26	38.45
835	12.99	V	6.2	0.53	<b>18.66</b>	38.45
835	11.36	H	6.2	0.53	17.03	38.45
846.6	12.83	V	6.2	0.53	18.5	38.45
846.6	11.52	H	6.2	0.53	17.19	38.45

### EIRP for UMTS-FDD Band II (Part 24E)

Frequency (MHz)	Substituted level (dBm)	Antenna Polarization	Antenna Gain correction (dBi)	Cable Loss (dB)	Absolute Level (dBm)	Limit (dBm)
1852.4	13.9	V	7.88	0.72	<b>21.06</b>	33
1852.4	13.25	H	7.88	0.72	20.41	33
1880	13.9	V	7.88	0.72	21.06	33
1880	13.5	H	7.88	0.72	20.66	33
1907.6	13.54	V	7.86	0.72	20.68	33
1907.6	12.73	H	7.86	0.72	19.87	33

### EIRP for UMTS-FDD Band IV (Part 27H)

Frequency (MHz)	Substituted level (dBm)	Antenna Polarization	Antenna Gain correction (dBi)	Cable Loss (dB)	Absolute Level (dBm)	Limit (dBm)
1712.4	13.32	V	7.95	0.69	20.58	30
1712.4	11.4	H	7.95	0.69	18.66	30
1740	13.86	V	7.93	0.69	<b>21.10</b>	30
1740	13.75	H	7.93	0.69	20.99	30
1752.6	13.57	V	7.92	0.69	20.80	30
1752.6	11.94	H	7.92	0.69	19.17	30

## HSUPA

### ERP for UMTS-FDD Band V (Part 22H)

Frequency (MHz)	Substituted level (dBm)	Antenna Polarization	Antenna Gain correction (dBi)	Cable Loss (dB)	Absolute Level (dBm)	Limit (dBm)
826.4	12.85	V	6.1	0.53	18.42	38.45
826.4	11.41	H	6.1	0.53	16.98	38.45
835	12.77	V	6.2	0.53	<b>18.44</b>	38.45
835	12.06	H	6.2	0.53	17.73	38.45
846.6	12.68	V	6.2	0.53	18.35	38.45
846.6	11.77	H	6.2	0.53	17.44	38.45

### EIRP for UMTS-FDD Band II (Part 24E)

Frequency (MHz)	Substituted level (dBm)	Antenna Polarization	Antenna Gain correction (dBi)	Cable Loss (dB)	Absolute Level (dBm)	Limit (dBm)
1852.4	13.75	V	7.88	0.72	<b>20.91</b>	33
1852.4	11.75	H	7.88	0.72	18.91	33
1880	13.72	V	7.88	0.72	20.88	33
1880	11.97	H	7.88	0.72	19.13	33
1907.6	13.35	V	7.86	0.72	20.49	33
1907.6	12.61	H	7.86	0.72	19.75	33

### EIRP for UMTS-FDD Band IV (Part 27H)

Frequency (MHz)	Substituted level (dBm)	Antenna Polarization	Antenna Gain correction (dBi)	Cable Loss (dB)	Absolute Level (dBm)	Limit (dBm)
1712.4	13.13	V	7.95	0.69	20.39	30
1712.4	13.06	H	7.95	0.69	20.32	30
1740	13.66	V	7.93	0.69	<b>20.90</b>	30
1740	13.02	H	7.93	0.69	20.26	30
1752.6	13.41	V	7.92	0.69	20.64	30
1752.6	12.06	H	7.92	0.69	19.29	30

### 6.3 Peak-Average Ratio

Temperature	23 °C
Relative Humidity	54%
Atmospheric Pressure	1020mbar
Test date :	June 28, 2017
Tested By :	Loren Luo

Requirement(s):

Spec	Item	Requirement	Applicable
§24.232(d) § 27.50(d)	a)	The peak-to-average ratio (PAR) of the transmission may not exceed 13 dB.	<input checked="" type="checkbox"/>

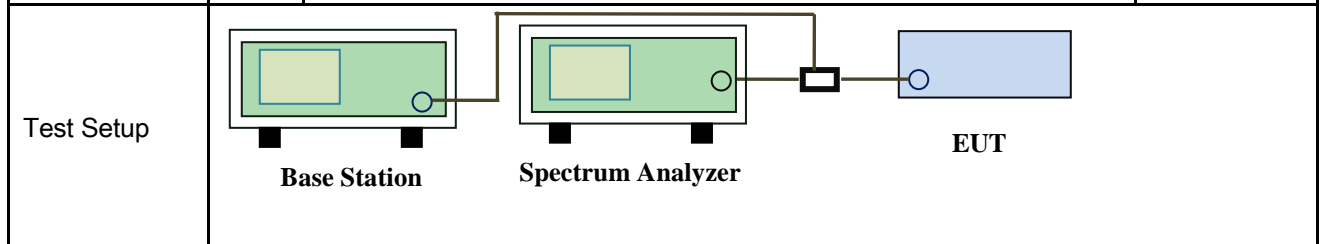

Test Procedure	<p><b>According with KDB 971168 v02r02</b></p> <p><b>5.7.2 Alternate procedure for PAPR</b></p> <p><b>5.1.2 Peak power measurements with a peak power meter</b></p> <p>The total peak output power may be measured using a broadband peak RF power meter. The power meter must have a video bandwidth that is greater than or equal to the emission bandwidth and utilize a fast-responding diode detector.</p> <p><b>5.2.3 Average power measurement with average power meter</b></p> <p>As an alternative to the use of a spectrum/signal analyzer or EMI receiver to perform a measurement of the total in-band average output power, a wideband RF average power meter with a thermocouple detector or equivalent can be used under certain conditions</p> <p>If the EUT can be configured to transmit continuously (i.e., the burst duty cycle <math>\geq 98\%</math>) and at all times the EUT is transmitting at its maximum output</p>
----------------	--

Test Report	17070437-FCC-R1-V1
Page	24 of 103

	<p>power level, then a conventional wide-band RF power meter can be used.</p> <p>If the EUT cannot be configured to transmit continuously (i.e., the burst duty cycle &lt; 98%), then there are two options for the use of an average power meter. First, a gated average power meter can be used to perform the measurement if the gating parameters can be adjusted such that the power is measured only over active transmission bursts at maximum output power levels. A conventional average power meter can also be used if the measured burst duty cycle is constant (i.e., duty cycle variations are less than <math>\pm 2</math> percent) by performing the measurement over the on/off burst cycles and then correcting (increasing) the measured level by a factor equal to <math>10\log(1/\text{duty cycle})</math></p>
Remark	
Result	<input checked="" type="checkbox"/> Pass <input type="checkbox"/> Fail

**Test Data**     Yes                       N/A  
**Test Plot**     Yes (See below)             N/A



**GSM : GSM 1900 PK-AV POWER (PART 24E)**

Frequency (MHz)	Conducted power(dBm)		Peak-Average Ratio(PAR)
	Peak	Average	
1850.2	30.29	30.06	0.23
1880	30.35	30.01	0.34
1909.8	30.36	30.07	0.29

**GPRS 1900 PK-AV POWER (PART 24E)**

Frequency (MHz)	Conducted power(dBm)		Peak-Average Ratio(PAR)
	Peak	Average	
1850.2	30.09	29.85	0.24
1880	30.03	29.81	0.22
1909.8	30.06	29.86	0.2

**EGPRS (MSC1) 1900 PK-AV POWER (PART 24E)**

Frequency (MHz)	Conducted power(dBm)		Peak-Average Ratio(PAR)
	Peak	Average	
1850.2	30.08	29.84	0.24
1880	30.08	29.8	0.28
1909.8	30.05	29.83	0.22

**RMC : UMTS-FDD Band II PK-AV POWER (PART 24E)**

Frequency (MHz)	Conducted power(dBm)		Peak-Average Ratio(PAR)
	Peak	Average	
1852.4	23.05	22.82	0.23
1880	23.06	22.79	0.27
1907.6	22.68	22.41	0.27

**UMTS-FDD Band IV PK-AV POWER (PART 24E)**

Frequency (MHz)	Conducted power(dBm)		Peak-Average Ratio(PAR)
	Peak	Average	
1712.6	22.32	22.14	0.18
1732.6	22.86	22.66	0.2
1752.4	22.56	22.38	0.18

**HSUPA : UMTS-FDD Band II PK-AV POWER (PART 24E)**

Frequency (MHz)	Conducted power(dBm)		Peak-Average Ratio(PAR)
	Peak	Average	
1852.4	22.26	22.03	0.23
1880	22.24	21.99	0.25
1907.6	21.98	21.69	0.29

**UMTS-FDD Band IV PK-AV POWER (PART 24E)**

Frequency (MHz)	Conducted power(dBm)		Peak-Average Ratio(PAR)
	Peak	Average	
1712.6	21.68	21.42	0.26
1732.6	22.16	21.92	0.24
1752.4	21.81	21.65	0.16

**HSDPA : UMTS-FDD Band II PK-AV POWER (PART 24E)**

Frequency (MHz)	Conducted power(dBm)		Peak-Average Ratio(PAR)
	Peak	Average	
1852.4	22.29	22.08	0.21
1880	22.25	22.03	0.22
1907.6	21.84	21.63	0.21

**UMTS-FDD Band IV PK-AV POWER (PART 24E)**

Frequency (MHz)	Conducted power(dBm)		Peak-Average Ratio(PAR)
	Peak	Average	
1712.6	21.65	21.44	0.21
1732.6	22.03	21.87	0.16
1752.4	21.86	21.59	0.27

## 6.4 Occupied Bandwidth

Temperature	25 °C
Relative Humidity	57%
Atmospheric Pressure	1023mbar
Test date :	June 27, 2017
Tested By :	Loren Luo

### Requirement(s):

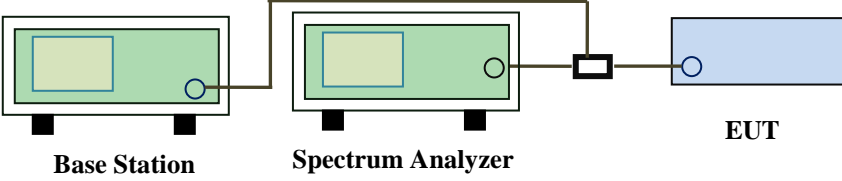
Spec	Item	Requirement	Applicable
§2.1049, §22.917, §22.905 §24.238 §27.53(a)	a)	99% Occupied Bandwidth(kHz)	<input checked="" type="checkbox"/>
	b)	26 dB Bandwidth(kHz)	<input checked="" type="checkbox"/>
Test Setup	 <p style="text-align: center;">Base Station      Spectrum Analyzer      EUT</p>		
Test Procedure	<ul style="list-style-type: none"> <li>- The EUT was connected to Spectrum Analyzer and Base Station via power divider.</li> <li>- The 99% and 26 dB occupied bandwidth (BW) of the middle channel for the highest RF powers.</li> </ul>		
Remark			
Result	<input checked="" type="checkbox"/> Pass <input type="checkbox"/> Fail		

Test Data     Yes       N/A

Test Plot     Yes (See below)       N/A

**GSM Voice:**

**Cellular Band (Part 22H) result**

Channel	Frequency (MHz)	99% Occupied Bandwidth (kHz)	26 dB Bandwidth (kHz)
128	824.2	244.35	318.1
190	836.6	246.18	320.8
251	848.8	246.44	322.5

**PCS Band (Part 24E) result**

Channel	Frequency (MHz)	99% Occupied Bandwidth (kHz)	26 dB Bandwidth (kHz)
512	1850.2	246.47	316.1
661	1880.0	244.95	316.4
810	1909.8	247.96	314.0

**GPRS:**

**Cellular Band (Part 22H) result**

Channel	Frequency (MHz)	99% Occupied Bandwidth (kHz)	26 dB Bandwidth (kHz)
128	824.2	248.00	316.5
190	836.6	244.60	316.7
251	848.8	244.87	319.1

**PCS Band (Part 24E) result**

Channel	Frequency (MHz)	99% Occupied Bandwidth (kHz)	26 dB Bandwidth (kHz)
512	1850.2	244.78	317.0
661	1880.0	245.84	317.3
810	1909.8	245.68	315.9

**EGPRS (MCS 1):**

**Cellular Band (Part 22H) result**

Channel	Frequency (MHz)	99% Occupied Bandwidth (kHz)	26 dB Bandwidth (kHz)
128	824.2	244.38	315.9
190	836.6	245.74	315.4
251	848.8	243.38	315.0

**PCS Band (Part 24E) result**

Channel	Frequency (MHz)	99% Occupied Bandwidth (kHz)	26 dB Bandwidth (kHz)
512	1850.2	245.53	314.5
661	1880.0	243.14	315.9
810	1909.8	244.75	316.3

**RMC:**

**UMTS-FDD Band V (Part 22H)**

Channel	Frequency (MHz)	99% Occupied Bandwidth (MHz)	26 dB Bandwidth (MHz)
4132	826.4	4.1519	4.651
4175	835.0	4.1427	4.650
4233	846.6	4.1466	4.670

**UMTS-FDD Band II (Part 24E)**

Channel	Frequency (MHz)	99% Occupied Bandwidth (MHz)	26 dB Bandwidth (MHz)
9262	1852.4	4.1925	4.745
9400	1880.0	4.1559	4.698
9538	1907.6	4.1693	4.703

**UMTS-FDD Band IV (Part 27)**

Channel	Frequency (MHz)	99% Occupied Bandwidth (MHz)	26 dB Bandwidth (MHz)
1313	1713	4.1620	4.691
1413	1733	4.1588	4.694
1512	1752	4.1839	4.755

**HSDPA:**

**UMTS-FDD Band V (Part 22H)**

Channel	Frequency (MHz)	99% Occupied Bandwidth (MHz)	26 dB Bandwidth (MHz)
4132	826.6	4.1491	4.658
4175	835.0	4.1444	4.666
4233	846.6	4.1421	4.667

**UMTS-FDD Band II (Part 24E)**

Channel	Frequency (MHz)	99% Occupied Bandwidth (MHz)	26 dB Bandwidth (MHz)
9262	1852.4	4.1990	4.748
9400	1880.0	4.1617	4.704
9538	1907.6	4.1627	4.707

**UMTS-FDD Band IV (Part 27)**

Channel	Frequency (MHz)	99% Occupied Bandwidth (MHz)	26 dB Bandwidth (MHz)
1313	1713	4.1624	4.685
1413	1733	4.1568	4.686
1512	1752	4.1842	4.734



**HSUPA:**

**UMTS-FDD Band V (Part 22H)**

Channel	Frequency (MHz)	99% Occupied Bandwidth (MHz)	26 dB Bandwidth (MHz)
4132	826.4	4.1563	4.678
4175	835.0	4.1437	4.659
4233	846.6	4.1412	4.655

**UMTS-FDD Band II (Part 24E)**

Channel	Frequency (MHz)	99% Occupied Bandwidth (MHz)	26 dB Bandwidth (MHz)
9262	1852.4	4.1970	4.765
9400	1880.0	4.1666	4.691
9538	1907.6	4.1556	4.704

**UMTS-FDD Band IV (Part 27)**

Channel	Frequency (MHz)	99% Occupied Bandwidth (MHz)	26 dB Bandwidth (MHz)
1313	1713	4.1571	4.677
1413	1733	4.1699	4.684
1512	1752	4.1773	4.730

### Test Plots

#### GMS Voice:

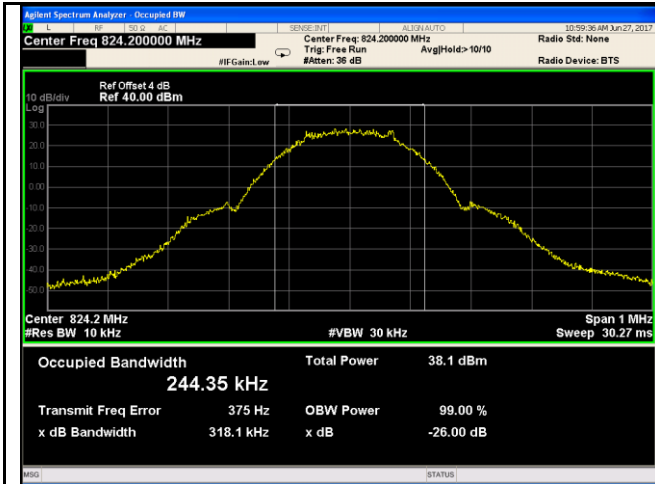

GSM 850 BW - Low CH 824.2MHz

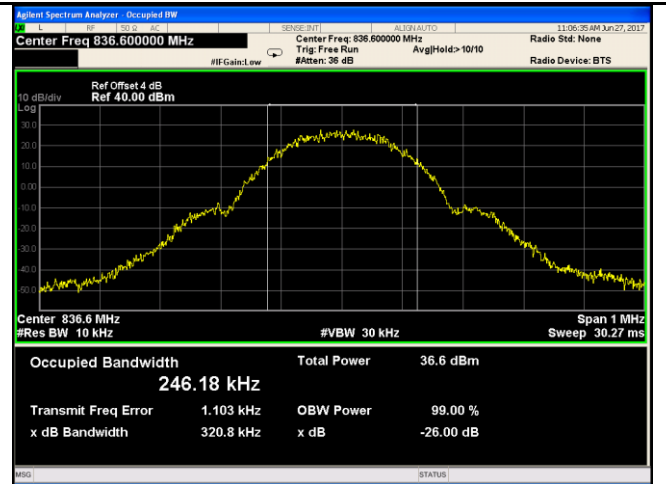

GSM 850 BW - Mid CH 836.6MHz

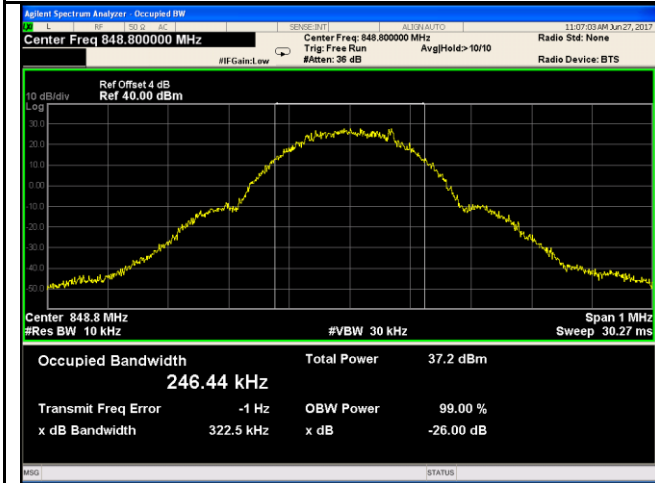

GSM 850 BW - High CH 848.8MHz

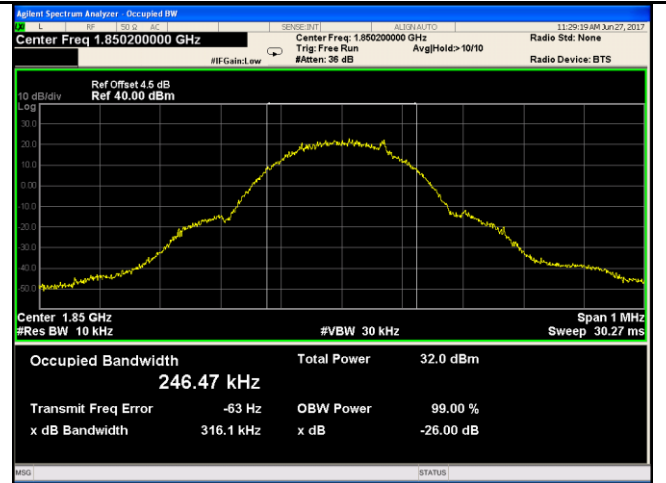

PCS 1900 BW - Low CH 1850.2MHz

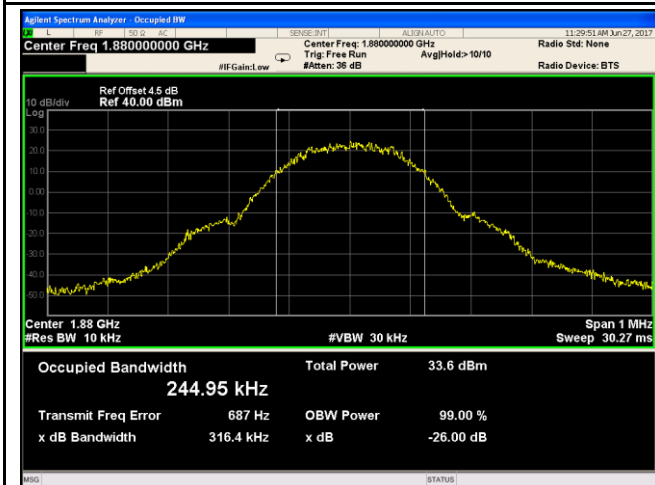

PCS 1900 BW - Mid CH 1880MHz

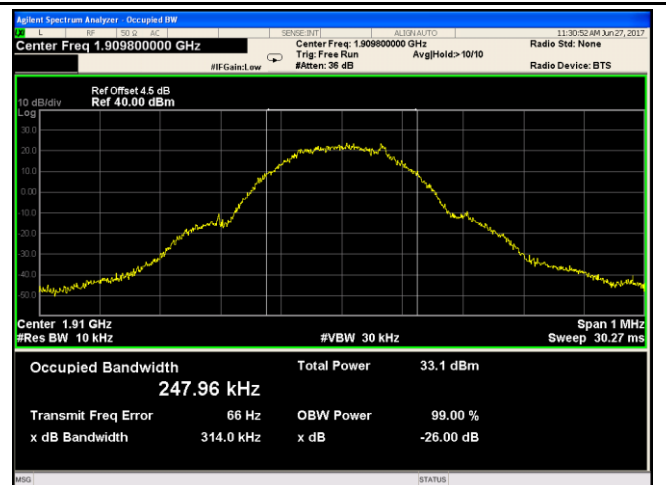

PCS 1900 BW - High CH 1910MHz

**GPRS:**

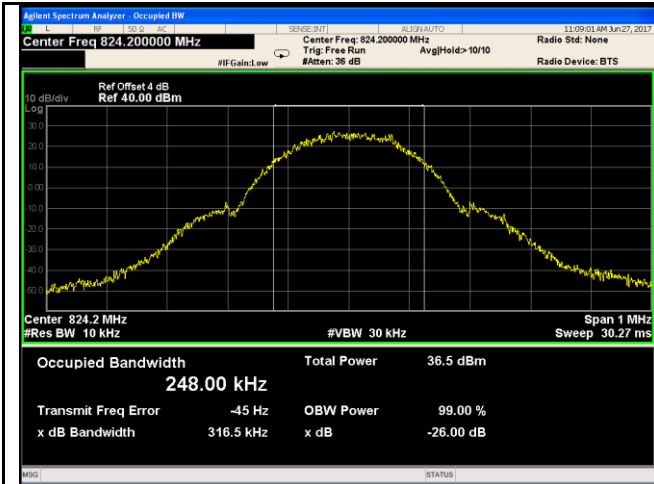

GSM 850 BW - Low CH 824.2MHz

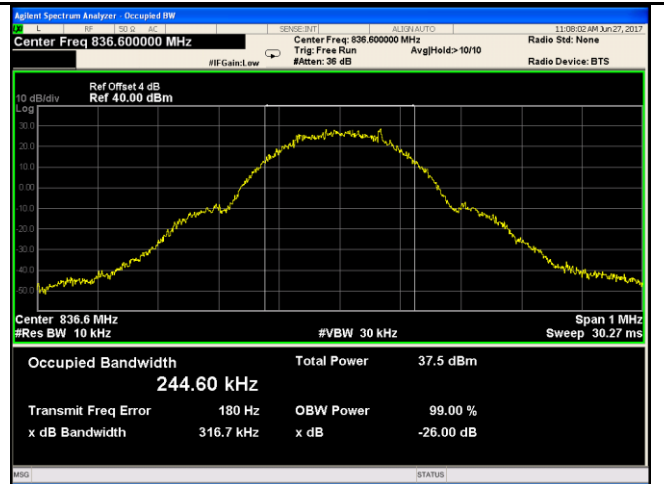

GSM 850 BW - Mid CH 836.6MHz

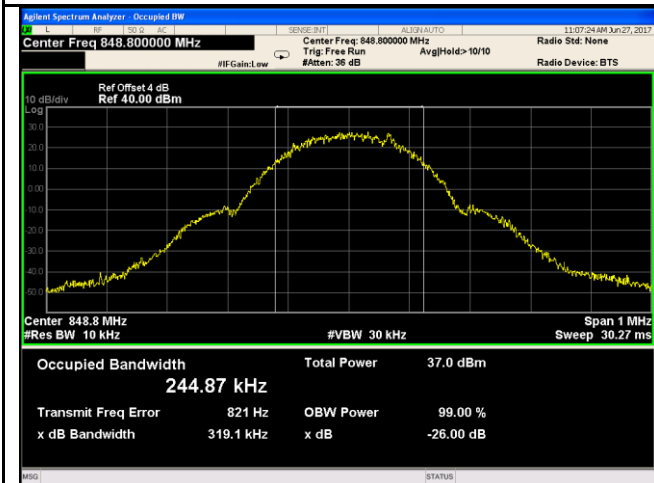

GSM 850 BW - High CH 848.8MHz

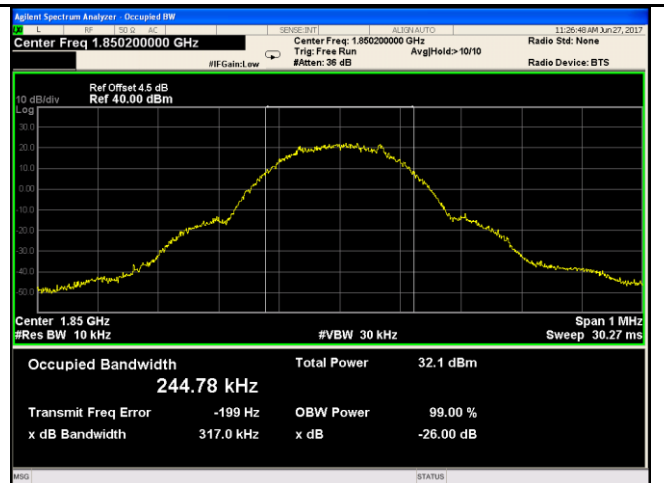

PCS 1900 BW - Low CH 1850.2MHz

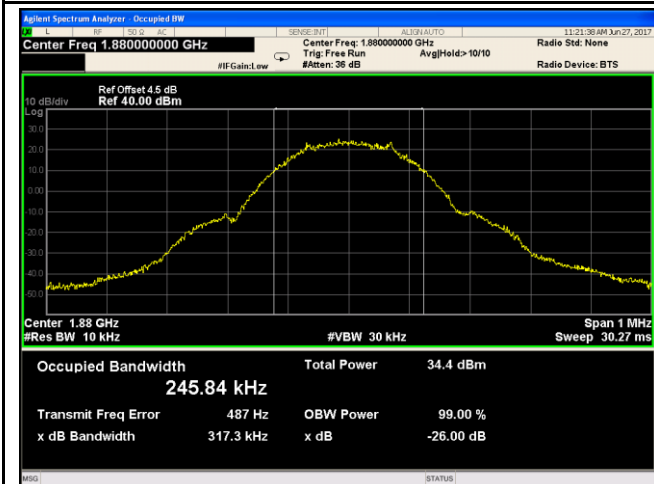

PCS 1900 BW - Mid CH 1880MHz

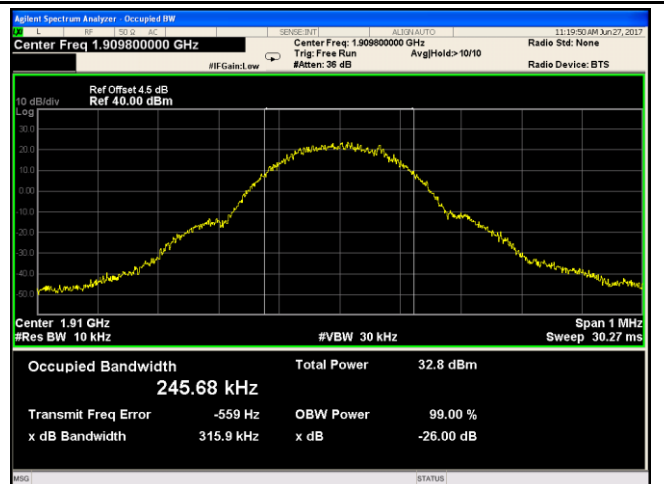

PCS 1900 BW - High CH 1910MHz

EGPRS:

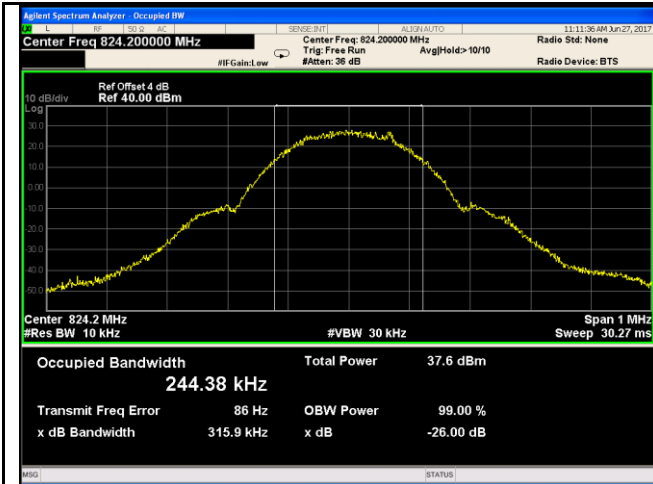

GSM 850 BW - Low CH 824.2MHz

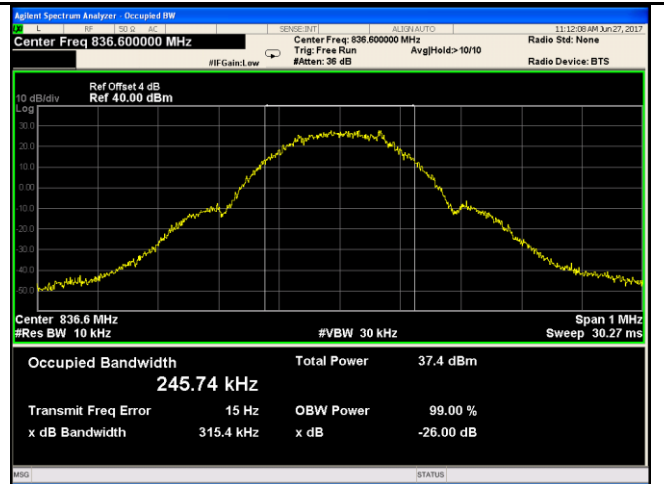

GSM 850 BW - Mid CH 836.6MHz

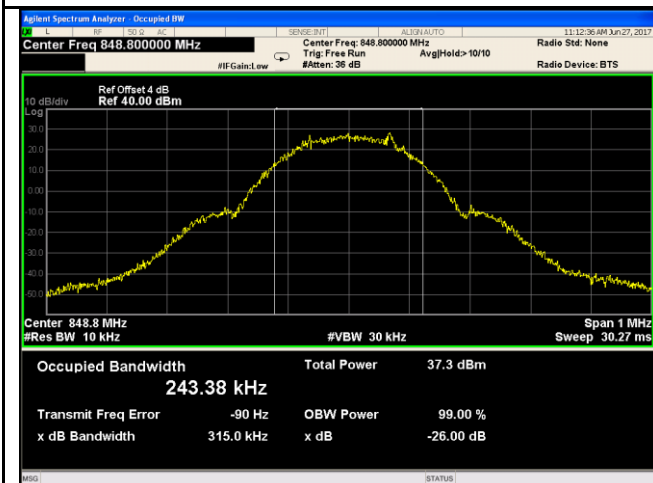

GSM 850 BW - High CH 848.8MHz

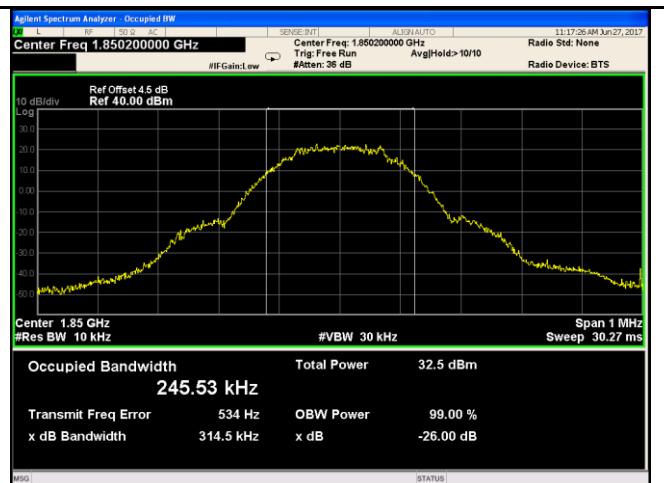

PCS 1900 BW - Low CH 1850.2MHz

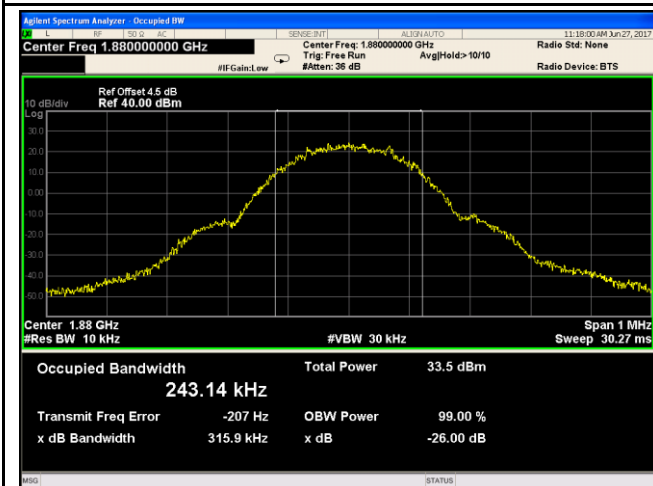

PCS 1900 BW - Mid CH 1880MHz

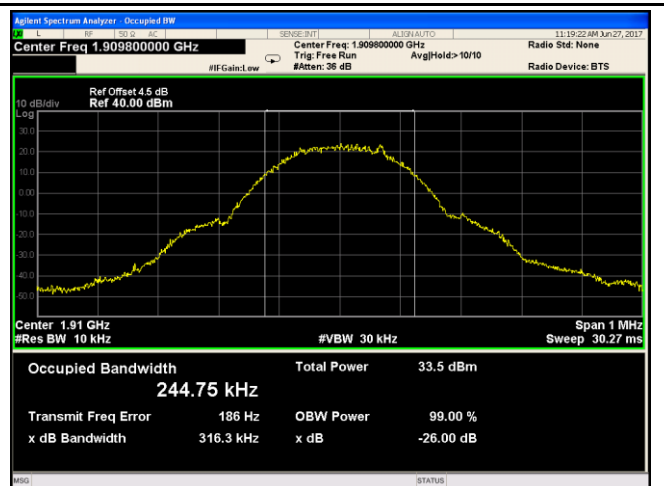

PCS 1900 BW - High CH 1910MHz

**RMC:**

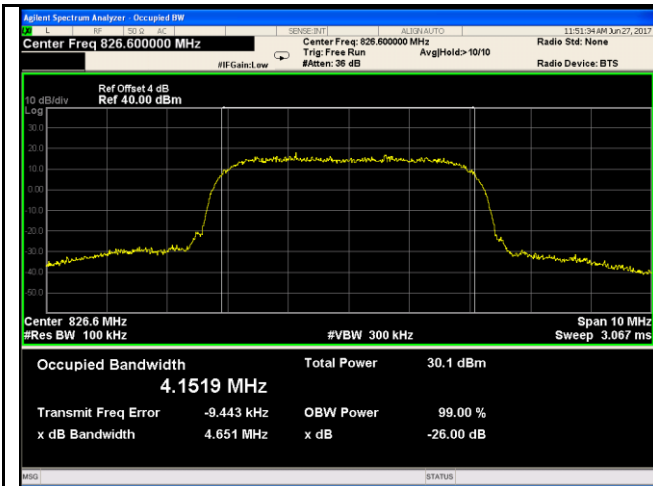

Band V BW - Low CH 826.6 MHz

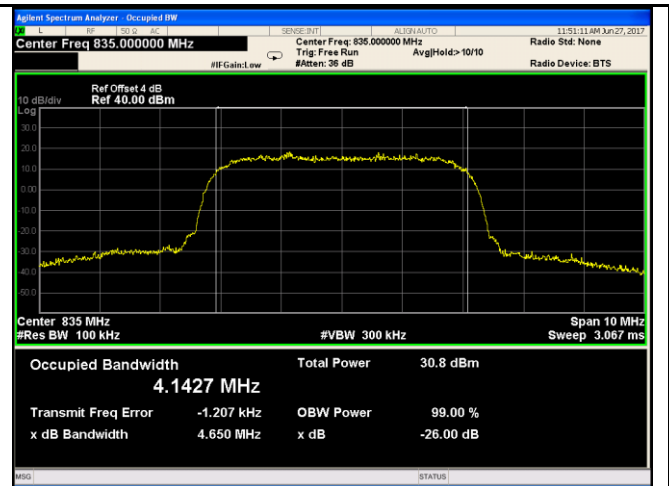

Band V BW - Mid CH 835.0 MHz

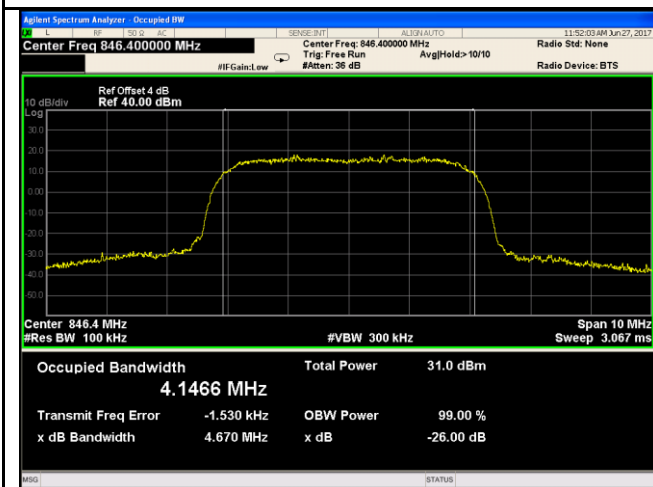

Band V BW - High CH 846.6 MHz

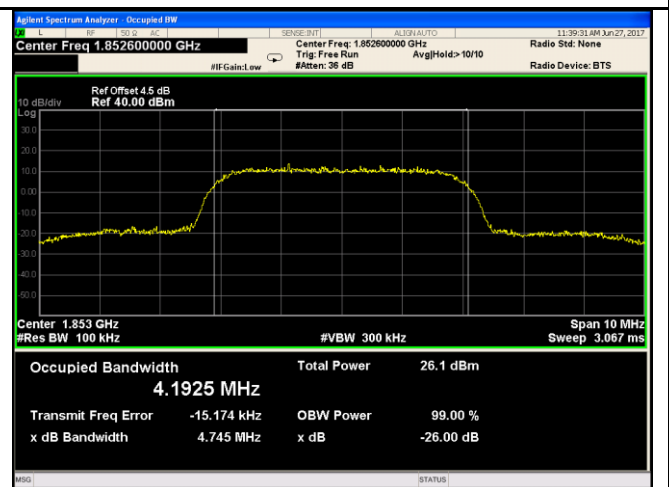

Band II BW - Low CH 1853MHz

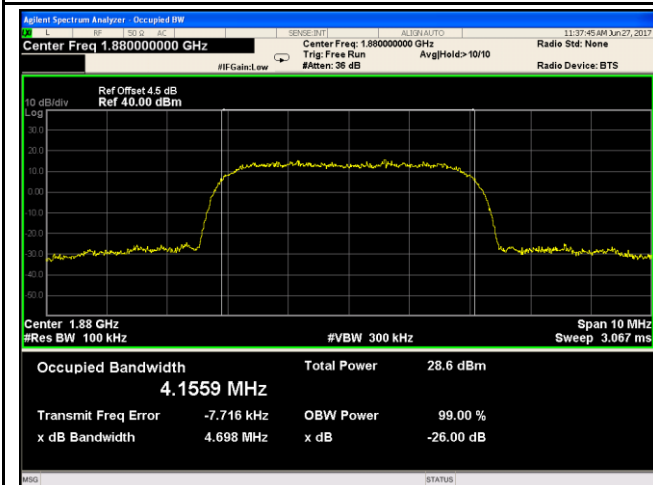

Band II BW - Mid CH 1880MHz

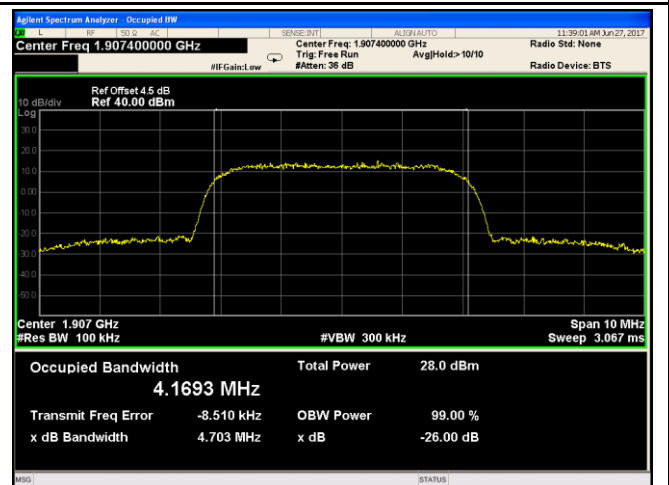

Band II BW - High CH 1907MHz

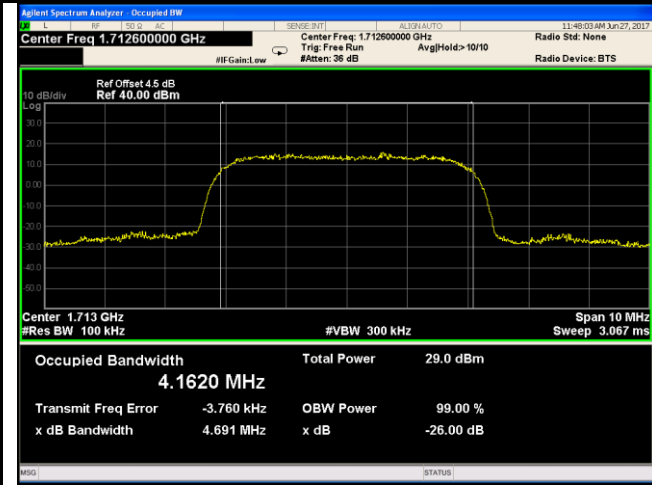

Band IV BW - Low CH 1713MHz

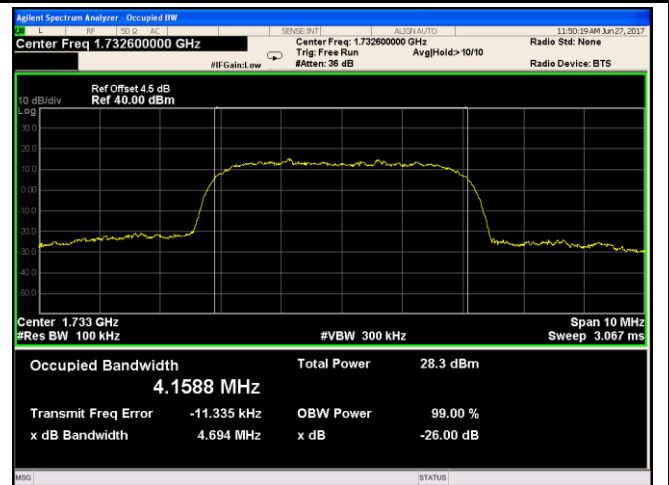

Band IVBW - Mid CH 1733MHz

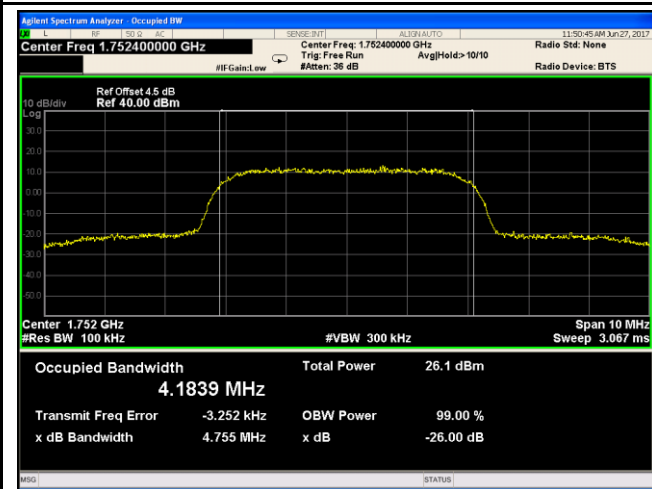

Band IV BW - High CH 1752MHz

**HSDPA:**

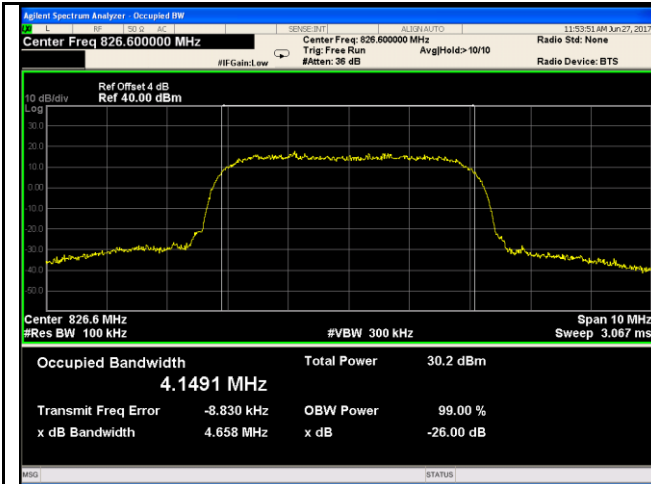

Band V BW - Low CH 826.6 MHz

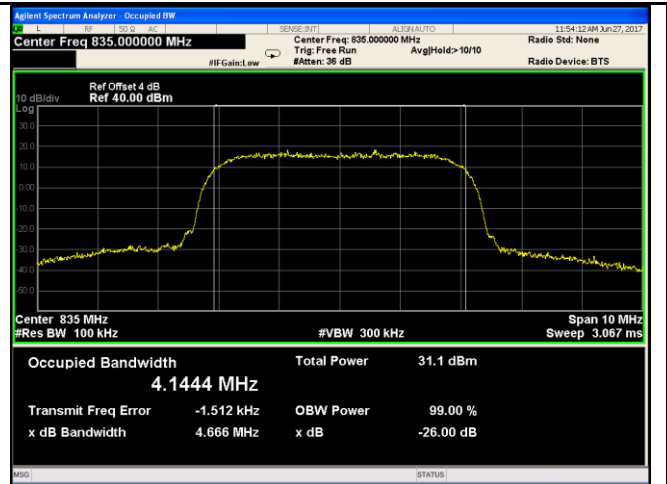

Band V BW - Mid CH 835.0 MHz

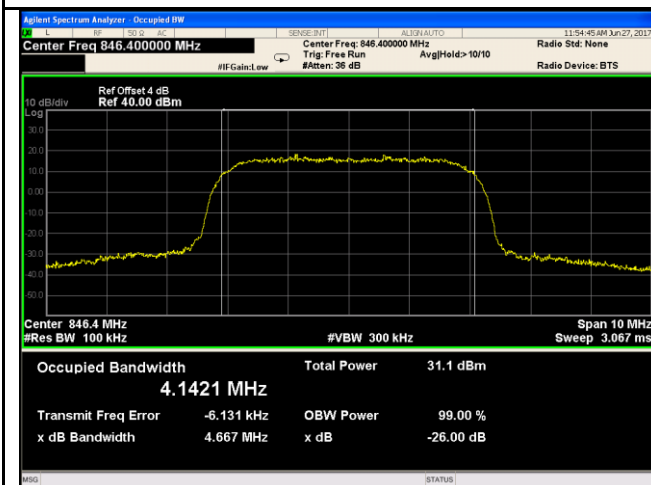

Band V BW - High CH 846.4 MHz

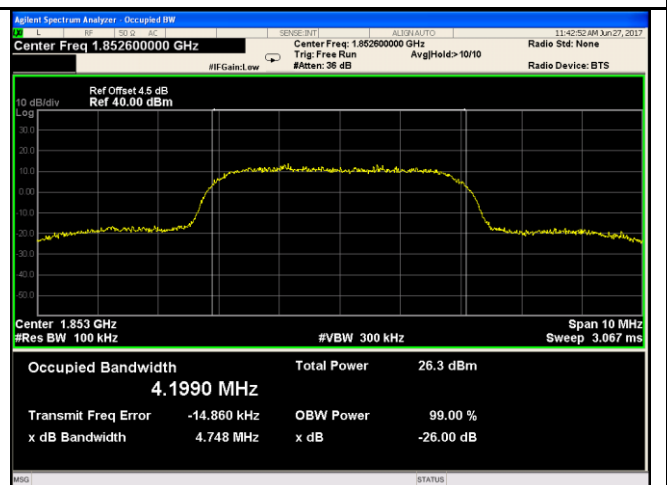

Band II BW - Low CH 1852.4MHz

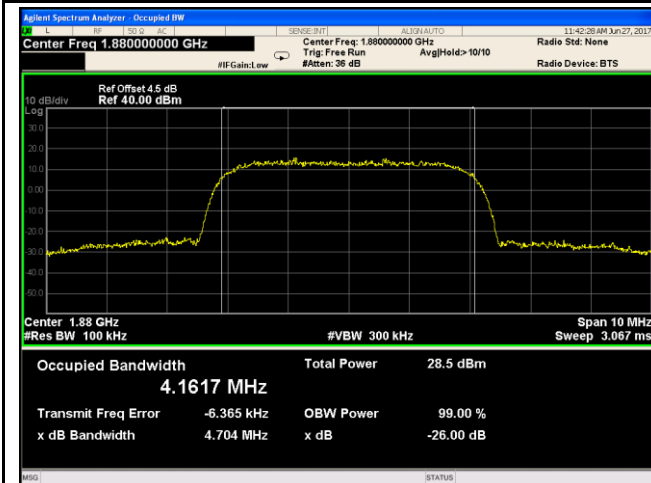

Band II BW - Mid CH 1880MHz

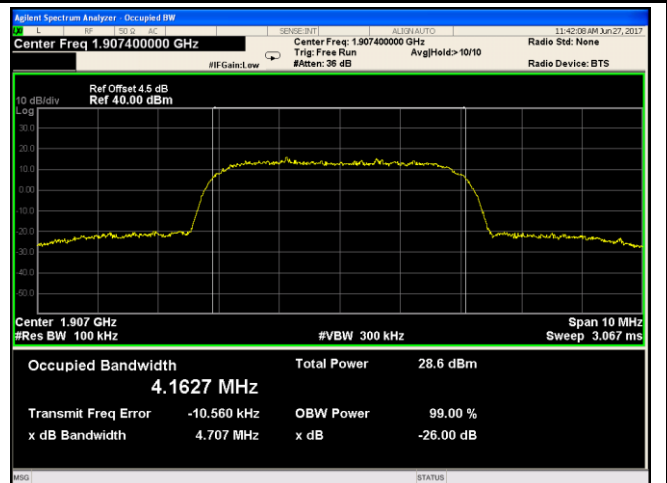

Band II BW - High CH 1907MHz

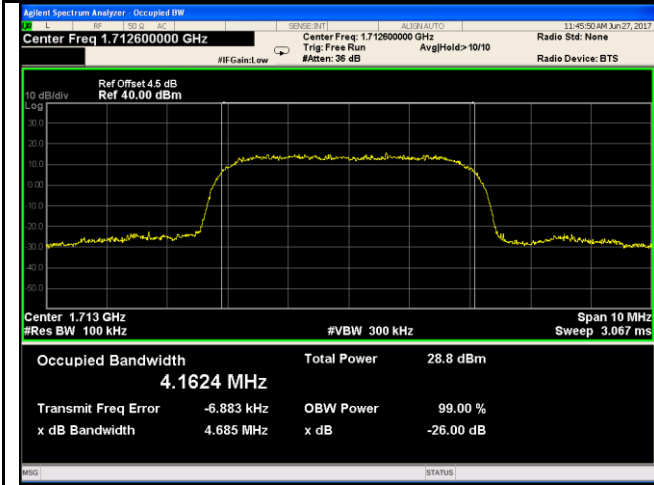

Band IV BW - Low CH 1713MHz

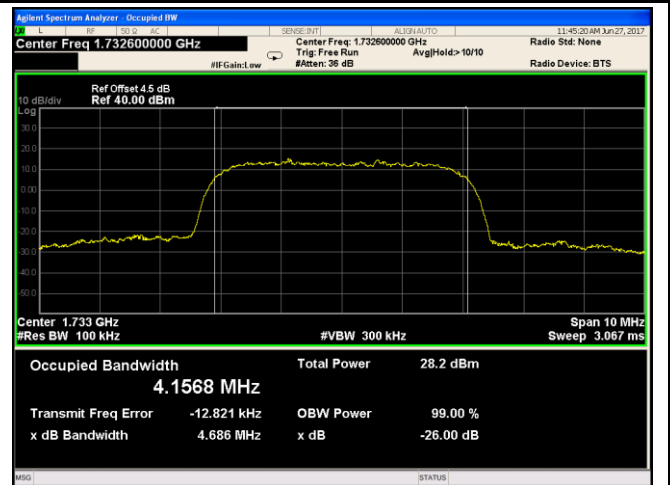

Band IVBW - Mid CH 1733MHz

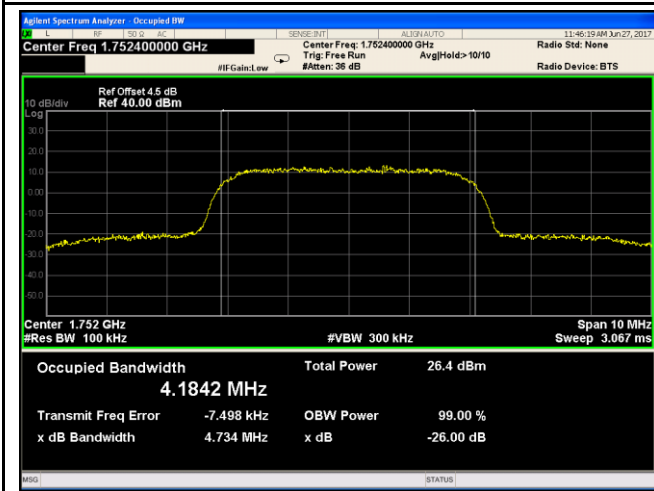

Band IV BW - High CH 1752MHz



**HSUPA:**

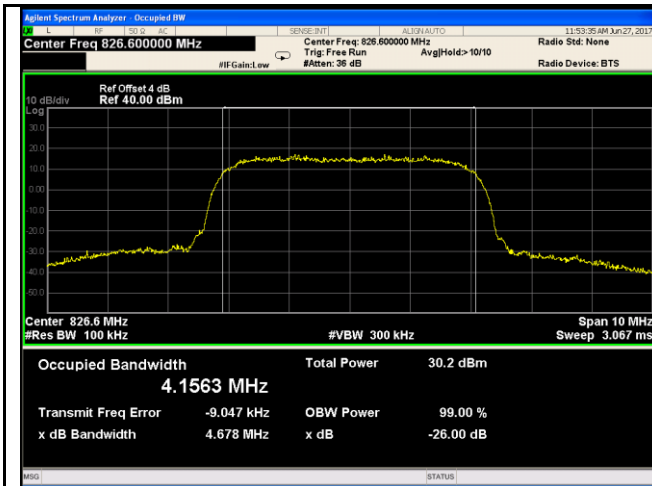

Band V BW - Low CH 826.6 MHz

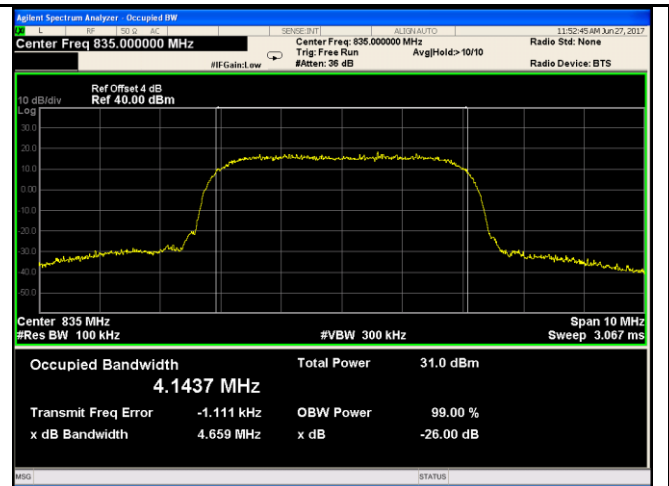

Band V BW - Mid CH 835.0 MHz

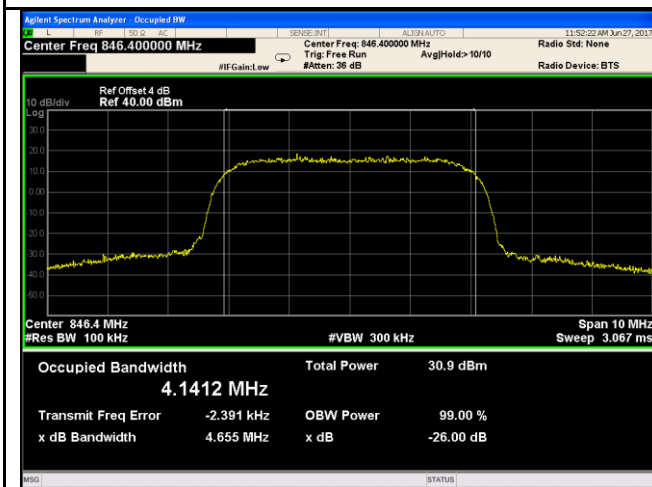

Band V BW - High CH 846.4 MHz

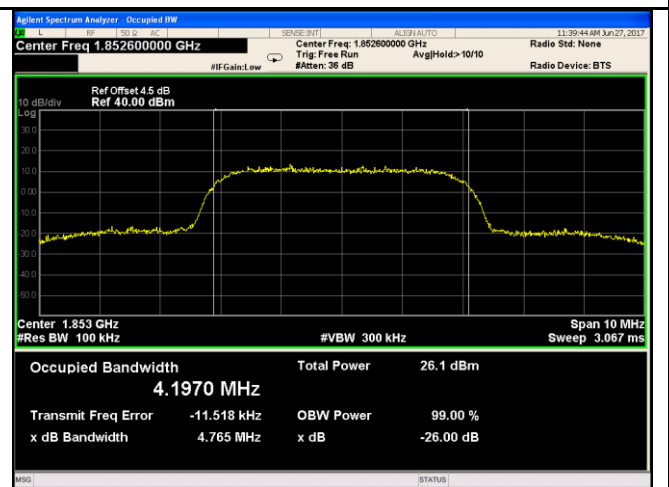

Band II BW - Low CH 1853MHz

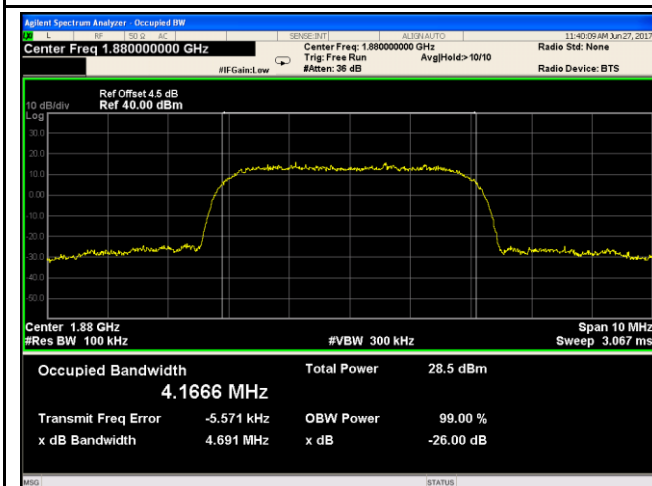

Band II BW - Mid CH 1880MHz

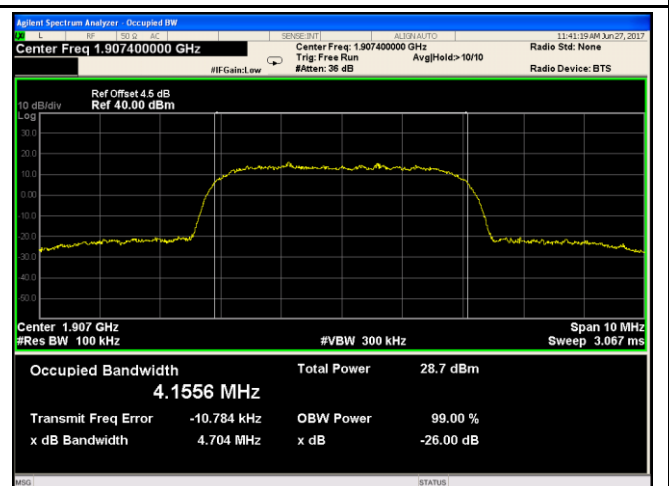

Band II BW - High CH 1907MHz

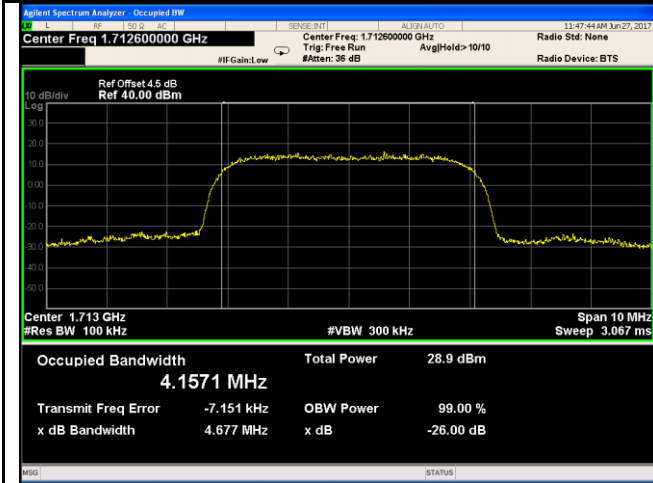

Band IV BW - Low CH 1713MHz

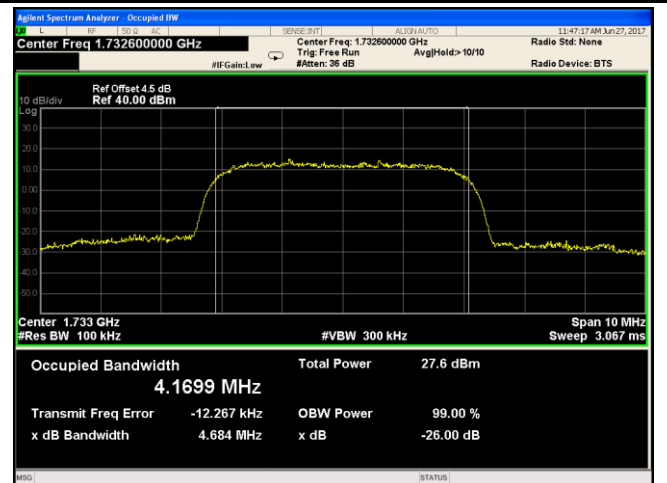

Band IVBW - Mid CH 1733MHz

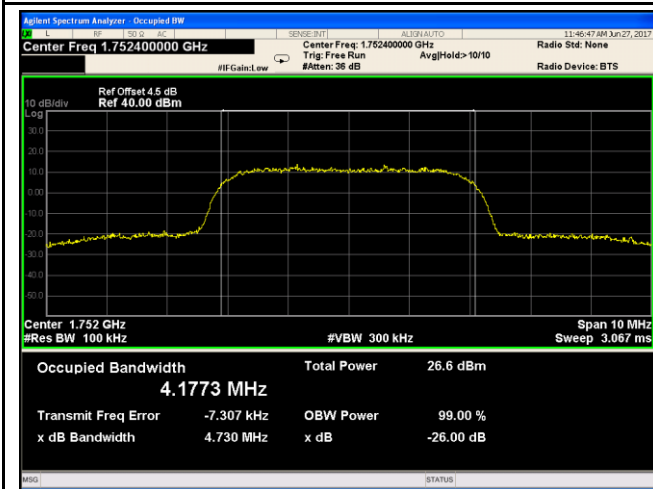

Band IV BW - High CH 1752MHz

## 6.5 Spurious Emissions at Antenna Terminals

Temperature	25 °C
Relative Humidity	57%
Atmospheric Pressure	1023mbar
Test date :	June 27, 2017
Tested By :	Loren Luo

### Requirement(s):

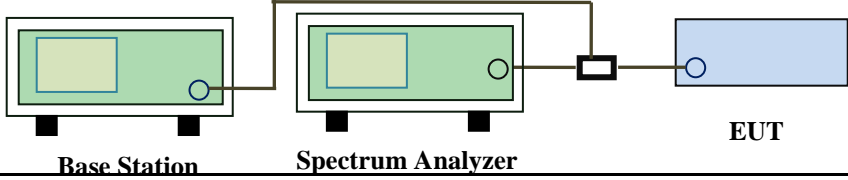
Spec	Item	Requirement	Applicable
§2.1051, §22.917(a)& §24.238(a) § 27.53(h)	a)	The power of any emission outside of the authorized operating frequency ranges must be lower than the transmitter power (P) by a factor of at least $43 + 10 \log(P)$ dB	<input checked="" type="checkbox"/>
Test Setup	 <p style="text-align: center;">Base Station      Spectrum Analyzer      EUT</p>		
Test Procedure	<ul style="list-style-type: none"> <li>- The EUT was connected to Spectrum Analyzer and Base Station via power divider.</li> <li>- The Band Edges of low and high channels for the highest RF powers were measured.</li> <li>- Setting RBW as roughly BW/100.</li> </ul>		
Remark			
Result	<input checked="" type="checkbox"/> Pass <input type="checkbox"/> Fail		

Test Data     Yes       N/A  
 Test Plot     Yes (See below)       N/A

### Test Plots

#### GSM Voice:

#### Cellular Band (Part 22H) result

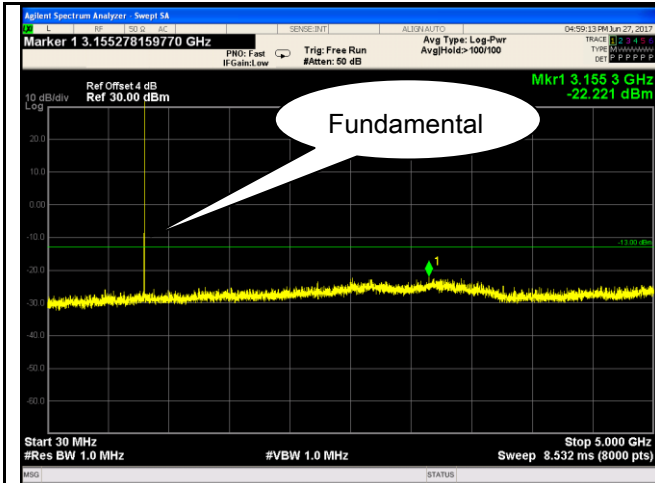

GSM 850 - Low Channel-1

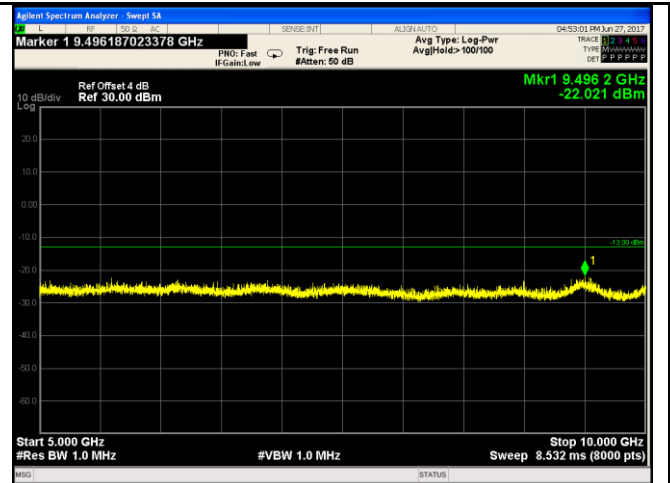

GSM 850 - Low Channel-2

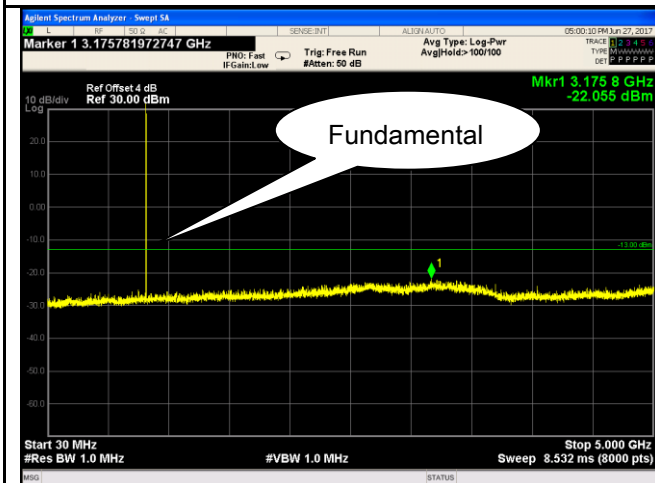

GSM 850 Middle Channel-1

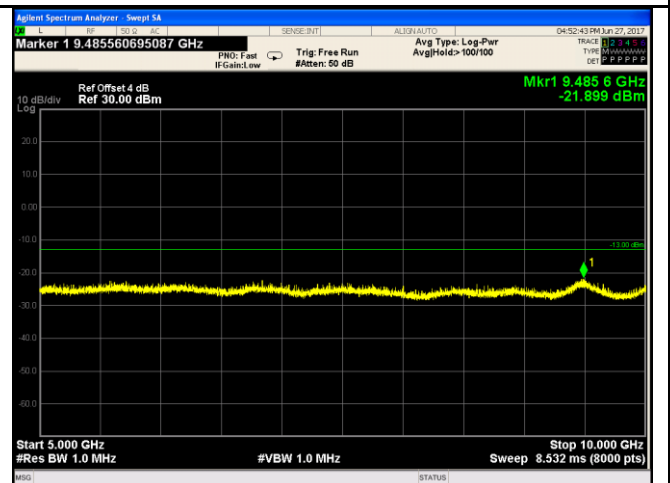

GSM 850 Middle Channel-2

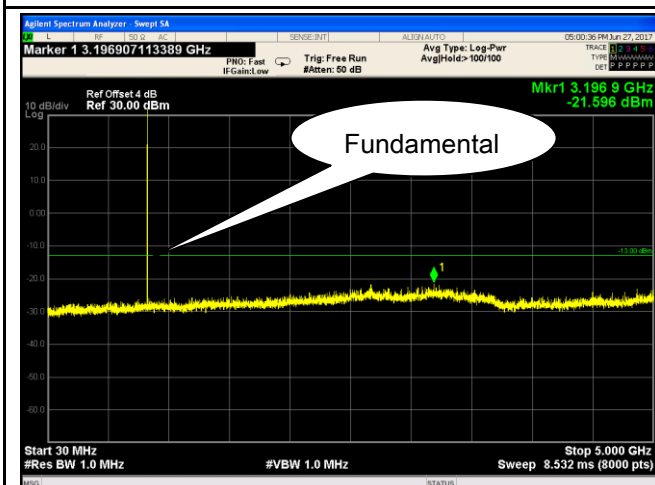

GSM 850 - High Channel-1

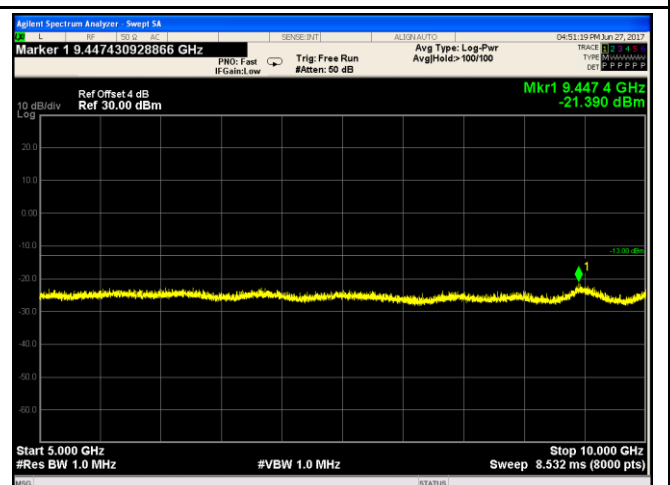

GSM 850 - High Channel-2

### PCS Band (Part24E) result

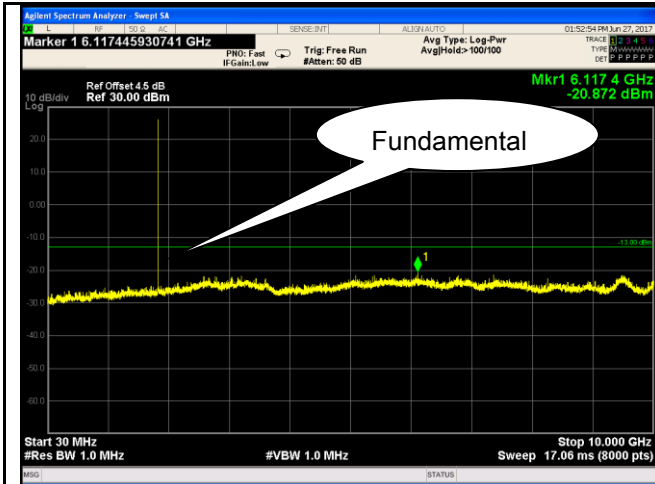

PCS1900 - Low Channel-1

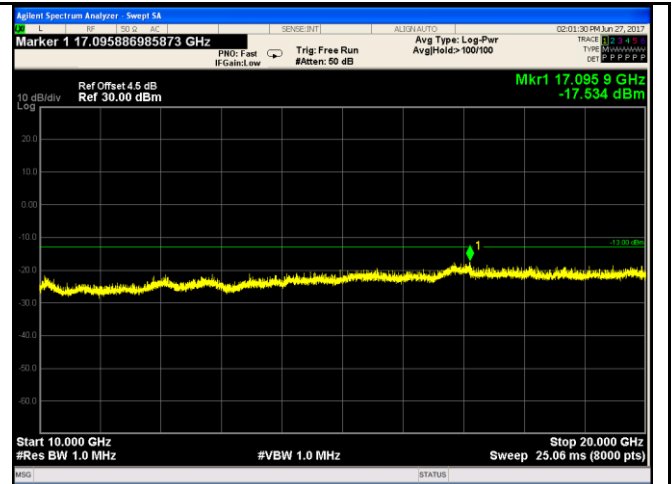

PCS 1900 - Low Channel-2

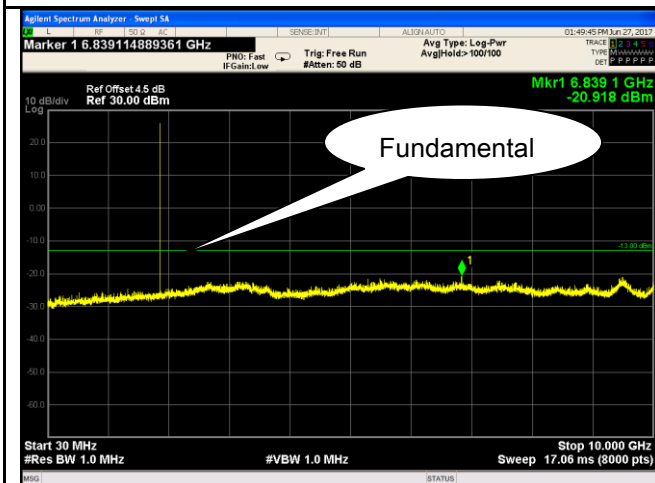

PCS1900 - Middle Channel-1

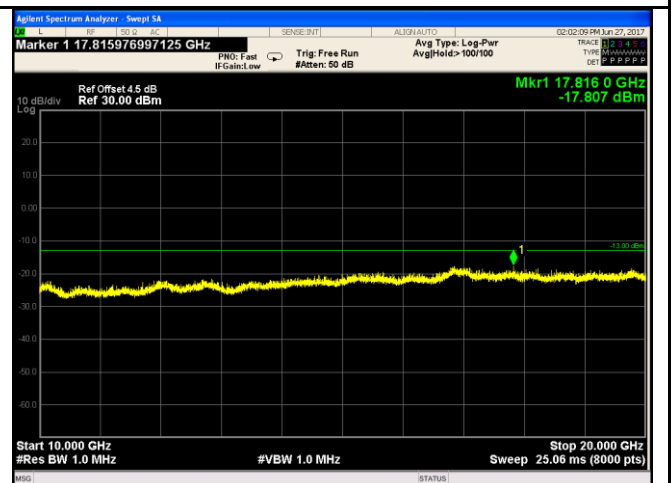

PCS 1900 - Middle Channel-2

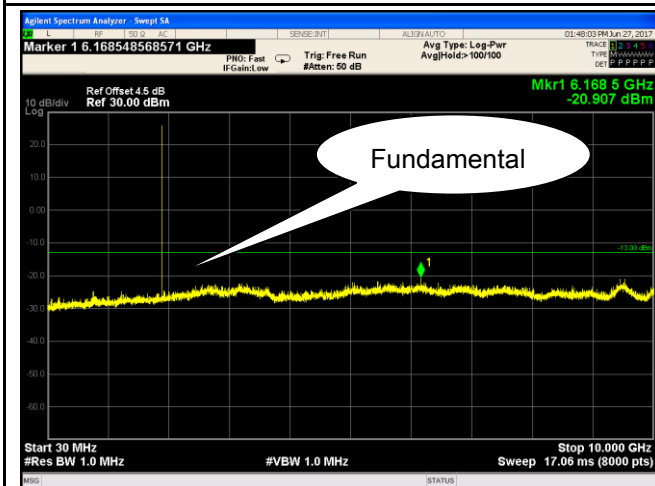

PCS1900 - High Channel-1

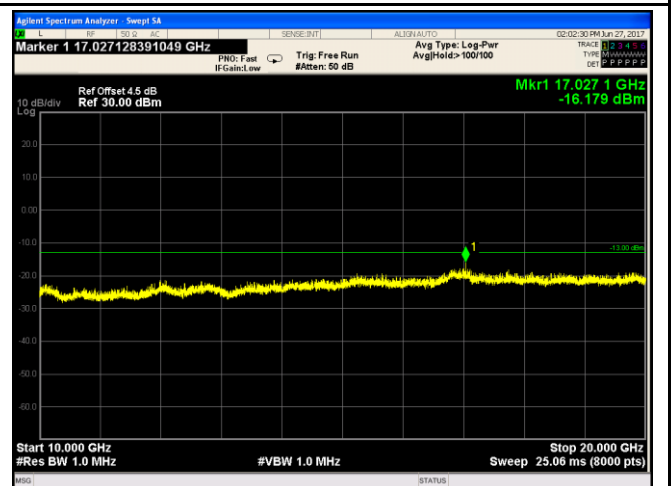

PCS 1900 - High Channel-2