

Test Report No.	17071300-FCC-R2
Page	33 of 64

	<p>coaxial cable.</p> <ol style="list-style-type: none"> 4. All other supporting equipment were powered separately from another main supply. 5. The EUT was switched on and allowed to warm up to its normal operating condition. 6. A scan was made on the NEUTRAL line (for AC mains) or Earth line (for DC power) over the required frequency range using an EMI test receiver. 7. High peaks, relative to the limit line, The EMI test receiver was then tuned to the selected frequencies and the necessary measurements made with a receiver bandwidth setting of 10 kHz. 8. Step 7 was then repeated for the LIVE line (for AC mains) or DC line (for DC power).
Remark	
Result	<input checked="" type="checkbox"/> Pass <input type="checkbox"/> Fail

Test Data Yes N/A

Test Plot Yes (See below) N/A

Test Mode:	Transmitting Mode
-------------------	--------------------------

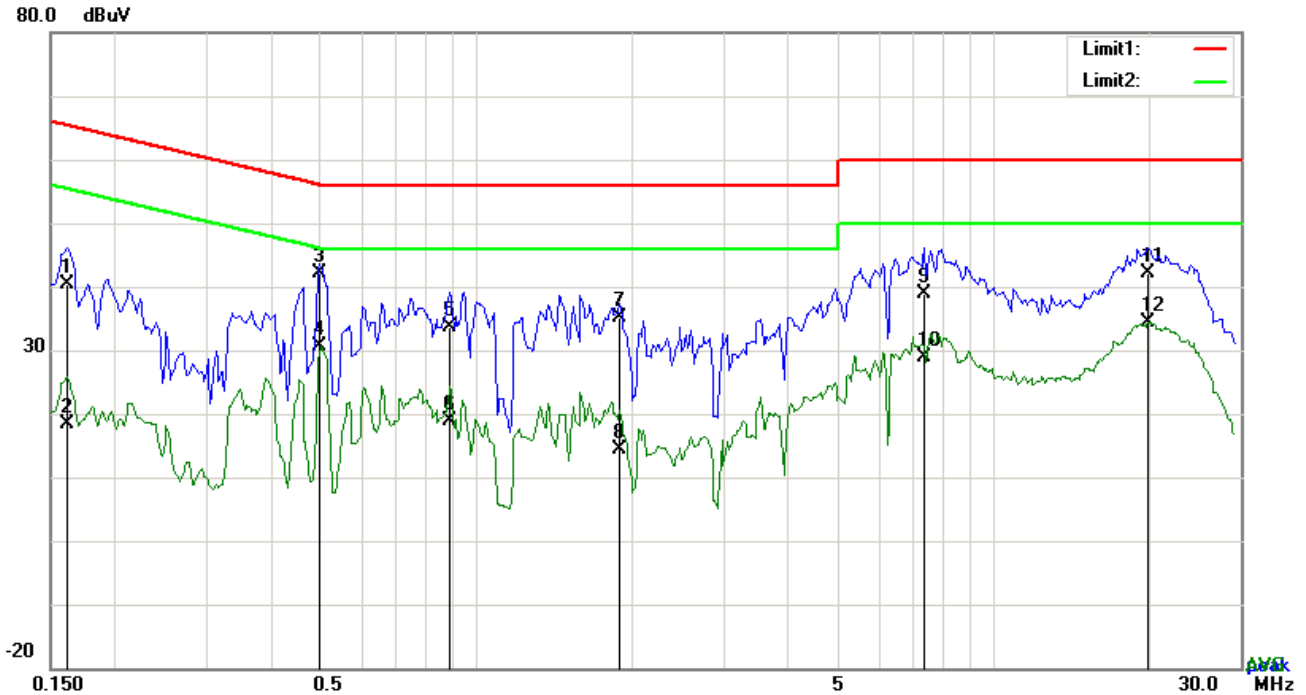

Test Data

Phase Line Plot at 120Vac, 60Hz

No.	P/L	Frequency (MHz)	Reading (dBµV)	Detector	Corrected (dB)	Result (dBµV)	Limit (dBµV)	Margin (dB)
1	L1	0.1617	30.24	QP	10.03	40.27	65.38	-25.11
2	L1	0.1617	8.32	AVG	10.03	18.35	55.38	-37.03
3	L1	0.4971	32.12	QP	10.03	42.15	56.05	-13.90
4	L1	0.4971	20.55	AVG	10.03	30.58	46.05	-15.47
5	L1	0.8871	23.63	QP	10.03	33.66	56.00	-22.34
6	L1	0.8871	8.77	AVG	10.03	18.80	46.00	-27.20
7	L1	1.8894	25.03	QP	10.04	35.07	56.00	-20.93
8	L1	1.8894	4.43	AVG	10.04	14.47	46.00	-31.53
9	L1	7.3329	28.89	QP	10.11	39.00	60.00	-21.00
10	L1	7.3329	18.68	AVG	10.11	28.79	50.00	-21.21
11	L1	19.9182	31.87	QP	10.30	42.17	60.00	-17.83
12	L1	19.9182	24.16	AVG	10.30	34.46	50.00	-15.54

Test Mode:	Transmitting Mode
-------------------	--------------------------

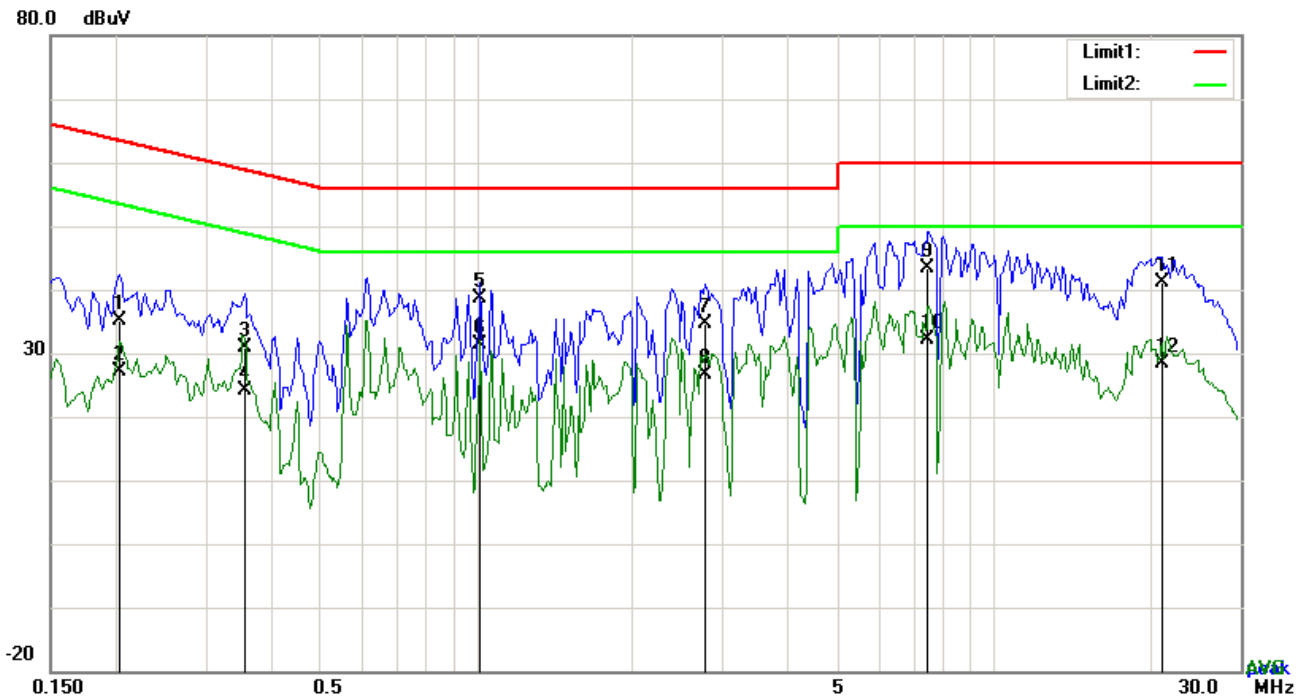

Test Data

Phase Neutral Plot at 120Vac, 60Hz

No.	P/L	Frequency (MHz)	Reading (dBµV)	Detector	Corrected (dB)	Result (dBµV)	Limit (dBµV)	Margin (dB)
1	N	0.2046	25.11	QP	10.02	35.13	63.42	-28.29
2	N	0.2046	17.18	AVG	10.02	27.20	53.42	-26.22
3	N	0.3567	20.87	QP	10.02	30.89	58.80	-27.91
4	N	0.3567	14.03	AVG	10.02	24.05	48.80	-24.75
5	N	1.0158	28.55	QP	10.03	38.58	56.00	-17.42
6	N	1.0158	21.27	AVG	10.03	31.30	46.00	-14.70
7	N	2.7708	24.64	QP	10.05	34.69	56.00	-21.31
8	N	2.7708	16.53	AVG	10.05	26.58	46.00	-19.42
9	N	7.4733	33.22	QP	10.10	43.32	60.00	-16.68
10	N	7.4733	22.10	AVG	10.10	32.20	50.00	-17.80
11	N	21.1896	30.76	QP	10.28	41.04	60.00	-18.96
12	N	21.1896	18.07	AVG	10.28	28.35	50.00	-21.65

Test Mode:	Transmitting Mode
-------------------	--------------------------

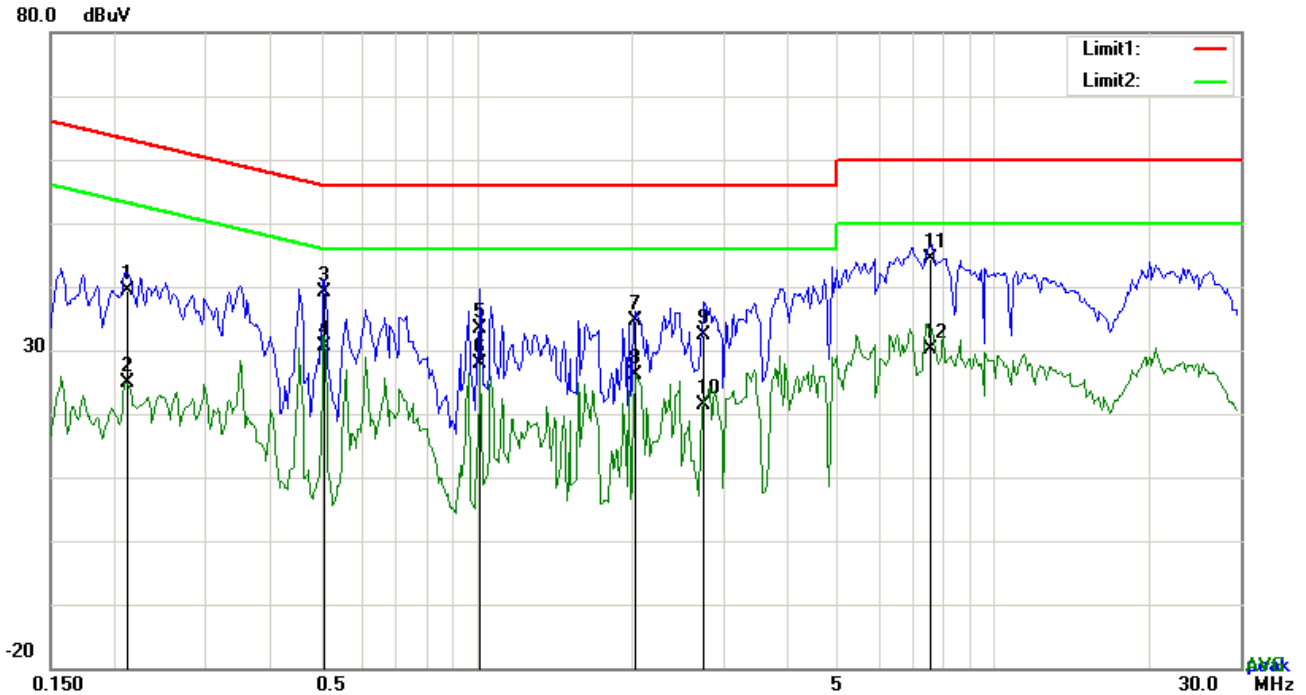

Test Data

Phase Line Plot at 240Vac, 60Hz

No.	P/L	Frequency (MHz)	Reading (dBμV)	Detector	Corrected (dB)	Result (dBμV)	Limit (dBμV)	Margin (dB)
1	L1	0.2124	29.27	QP	10.03	39.30	63.11	-23.81
2	L1	0.2124	14.84	AVG	10.03	24.87	53.11	-28.24
3	L1	0.5088	29.13	QP	10.03	39.16	56.00	-16.84
4	L1	0.5088	20.59	AVG	10.03	30.62	46.00	-15.38
5	L1	1.0158	23.29	QP	10.03	33.32	56.00	-22.68
6	L1	1.0158	17.76	AVG	10.03	27.79	46.00	-18.21
7	L1	2.0298	24.62	QP	10.04	34.66	56.00	-21.34
8	L1	2.0298	16.03	AVG	10.04	26.07	46.00	-19.93
9	L1	2.7630	22.44	QP	10.05	32.49	56.00	-23.51
10	L1	2.7630	11.37	AVG	10.05	21.42	46.00	-24.58
11	L1	7.5630	34.36	QP	10.12	44.48	60.00	-15.52
12	L1	7.5630	20.11	AVG	10.12	30.23	50.00	-19.77

Test Mode:	Transmitting Mode
-------------------	--------------------------

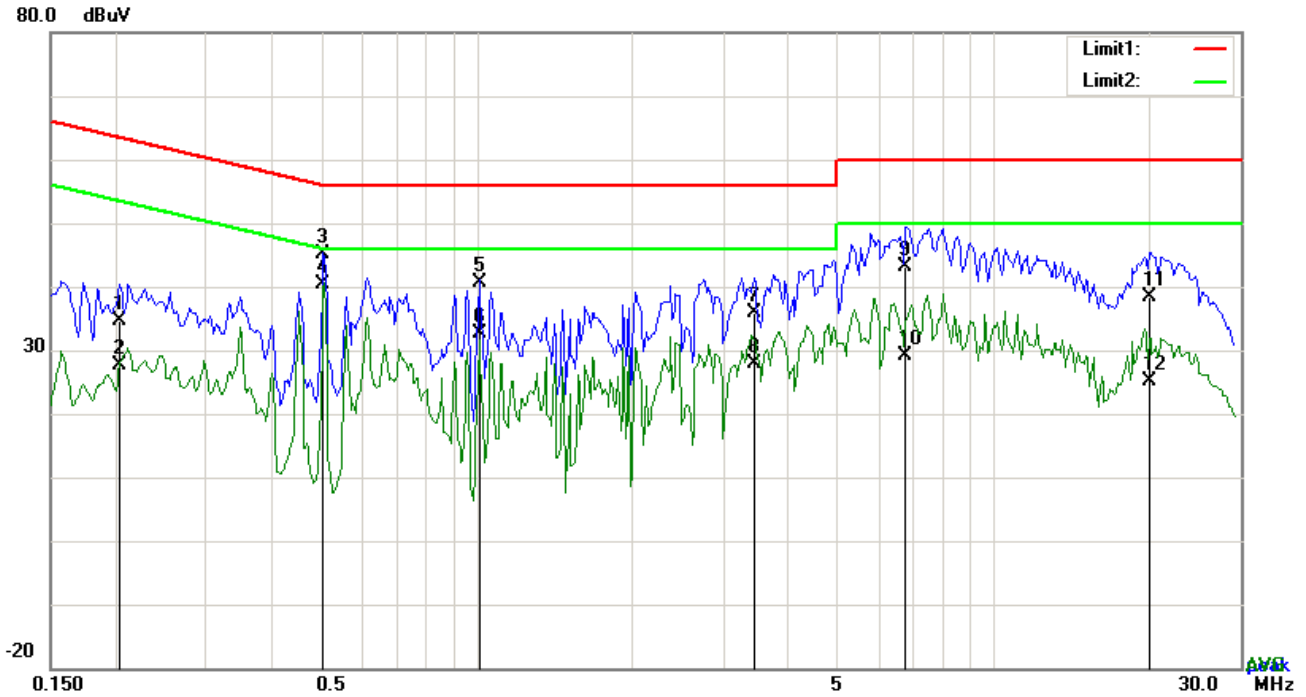

Test Data

Phase Neutral Plot at 240Vac, 60Hz

No.	P/L	Frequency (MHz)	Reading (dBμV)	Detector	Corrected (dB)	Result (dBμV)	Limit (dBμV)	Margin (dB)
1	N	0.2046	24.61	QP	10.02	34.63	63.42	-28.79
2	N	0.2046	17.54	AVG	10.02	27.56	53.42	-25.86
3	N	0.5049	35.14	QP	10.02	45.16	56.00	-10.84
4	N	0.5049	30.40	AVG	10.02	40.42	46.00	-5.58
5	N	1.0119	30.50	QP	10.03	40.53	56.00	-15.47
6	N	1.0119	22.57	AVG	10.03	32.60	46.00	-13.40
7	N	3.4485	25.88	QP	10.05	35.93	56.00	-20.07
8	N	3.4485	17.80	AVG	10.05	27.85	46.00	-18.15
9	N	6.7557	33.16	QP	10.09	43.25	60.00	-16.75
10	N	6.7557	19.11	AVG	10.09	29.20	50.00	-20.80
11	N	20.0469	28.23	QP	10.26	38.49	60.00	-21.51
12	N	20.0469	14.85	AVG	10.26	25.11	50.00	-24.89

6.7 Radiated Spurious Emissions & Restricted Band

Temperature	25 °C
Relative Humidity	57%
Atmospheric Pressure	1024mbar
Test date :	November 24, 2017
Tested By :	Aaron Liang

Requirement(s):

Spec	Item	Requirement	Applicable																
47CFR§15.247(d), RSS210 (A8.5)	a)	<p>Except higher limit as specified elsewhere in other section, the emissions from the low-power radio-frequency devices shall not exceed the field strength levels specified in the following table and the level of any unwanted emissions shall not exceed the level of the fundamental emission. The tighter limit applies at the band edges</p> <table border="1"> <thead> <tr> <th>Frequency range (MHz)</th> <th>Field Strength (µV/m)</th> </tr> </thead> <tbody> <tr> <td>0.009~0.490</td> <td>2400/F(KHz)</td> </tr> <tr> <td>0.490~1.705</td> <td>24000/F(KHz)</td> </tr> <tr> <td>1.705~30.0</td> <td>30</td> </tr> <tr> <td>30 – 88</td> <td>100</td> </tr> <tr> <td>88 – 216</td> <td>150</td> </tr> <tr> <td>216 960</td> <td>200</td> </tr> <tr> <td>Above 960</td> <td>500</td> </tr> </tbody> </table>	Frequency range (MHz)	Field Strength (µV/m)	0.009~0.490	2400/F(KHz)	0.490~1.705	24000/F(KHz)	1.705~30.0	30	30 – 88	100	88 – 216	150	216 960	200	Above 960	500	<input checked="" type="checkbox"/>
	Frequency range (MHz)	Field Strength (µV/m)																	
	0.009~0.490	2400/F(KHz)																	
0.490~1.705	24000/F(KHz)																		
1.705~30.0	30																		
30 – 88	100																		
88 – 216	150																		
216 960	200																		
Above 960	500																		
b)	<p>For non-restricted band, In any 100 kHz bandwidth outside the frequency band in which the spread spectrum or digitally modulated intentional radiator is operating, the radio frequency power that is produced by the intentional radiator shall be at least 20 dB or 30dB below that in the 100 kHz bandwidth within the band that contains the highest level of the desired power, determined by the measurement method on output power to be used. Attenuation below the general limits specified in § 15.209(a) is not required</p> <p><input checked="" type="checkbox"/> 20 dB down <input type="checkbox"/> 30 dB down</p>	<input checked="" type="checkbox"/>																	
c)	<p>or restricted band, emission must also comply with the radiated emission limits specified in 15.209</p>	<input checked="" type="checkbox"/>																	

<p>Test Setup</p>	
<p>Procedure</p>	<ol style="list-style-type: none"> 1. The EUT was switched on and allowed to warm up to its normal operating condition. 2. The test was carried out at the selected frequency points obtained from the EUT characterization. Maximization of the emissions, was carried out by rotating the EUT, changing the antenna polarization, and adjusting the antenna height in the following manner: <ol style="list-style-type: none"> a. Vertical or horizontal polarization (whichever gave the higher emission level over a full rotation of the EUT) was chosen. b. The EUT was then rotated to the direction that gave the maximum emission. c. Finally, the antenna height was adjusted to the height that gave the maximum emission. 3. The resolution bandwidth and video bandwidth of test receiver/spectrum analyzer is 120 kHz for Quasiy Peak detection at frequency below 1GHz. 4. The resolution bandwidth of test receiver/spectrum analyzer is 1MHz and video bandwidth is 3MHz with Peak detection for Peak measurement at frequency above 1GHz.

Test Report No.	17071300-FCC-R2
Page	40 of 64

	<p>The resolution bandwidth of test receiver/spectrum analyzer is 1MHz and the video bandwidth is 10Hz with Peak detection for Average Measurement as below at frequency above 1GHz.</p> <p>5. Steps 2 and 3 were repeated for the next frequency point, until all selected frequency points were measured.</p>
Remark	Different RF configuration has been evaluated but not much difference was found. The data presented here is the worst case data with EUT under 802.11n – HT20-2437MHz mode.
Result	<input checked="" type="checkbox"/> Pass <input type="checkbox"/> Fail

Test Data Yes N/A

Test Plot Yes (See below) N/A

Test Result:

Test Mode:	Transmitting Mode
-------------------	-------------------

Frequency range: 9KHz - 30MHz

Freq. (MHz)	Detection value	Factor (dB/m)	Reading (dBuV/m)	Result (dBuV/m)	Limit@3m (dBuV/m)	Margin (dB)
--	--	--	--	--	--	>20
--	--	--	--	--	--	>20

Note:

The amplitude of spurious emissions which are attenuated by more than 20dB below the permissible value has no need to be reported.

Distance extrapolation factor = $40 \log (\text{specific distance}/\text{test distance})$ (dB);

Limit line = specific limits(dBuv) + distance extrapolation factor.

Test Mode:	Transmitting Mode
-------------------	--------------------------

30MHz -1GHz

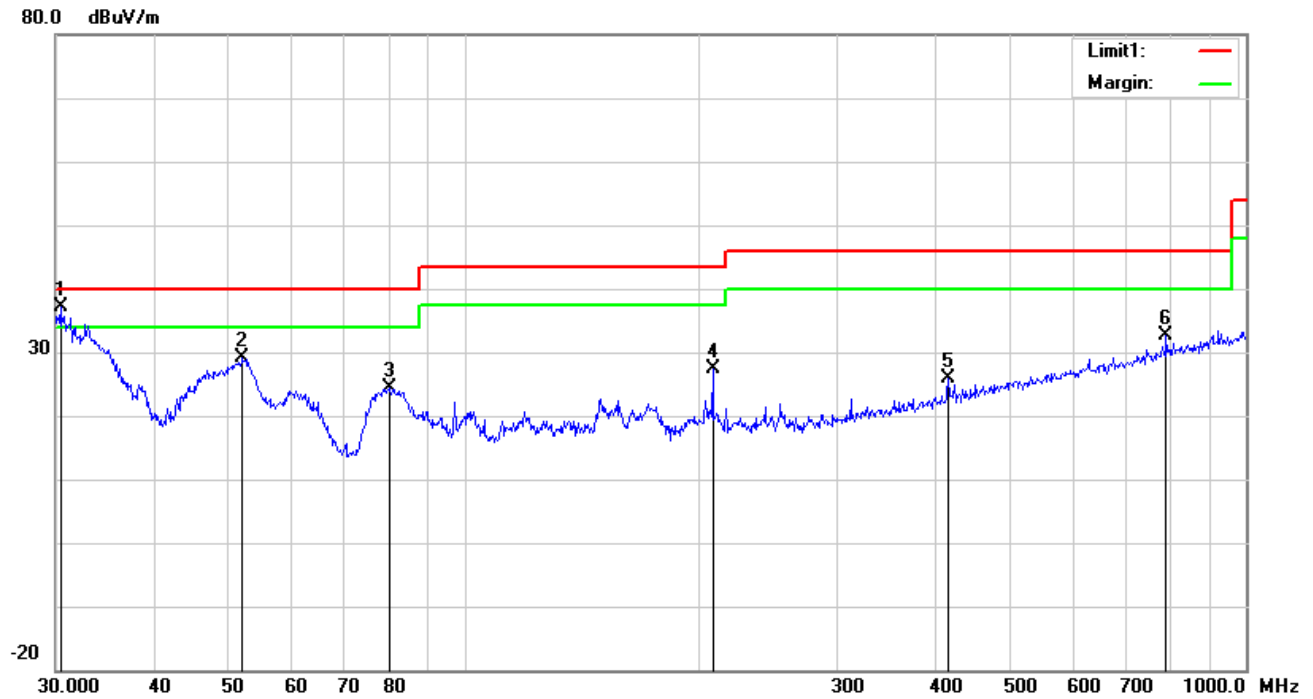

Test Data

Vertical Polarity Plot @3m

No.	P/L	Frequency	Reading	Detect or	Ant_F	PA_G	Cab_L	Result	Limit	Margin	Height	Degree
		(MHz)	(dBuV/m)		(dB/m)	(dB)	(dB)	(dBuV/m)	(dBuV/m)	(dB)	(cm)	(°)
1	V	30.4238	37.75	QP	21.07	22.28	0.63	37.17	40.00	-2.83	100	27
2	V	52.0251	42.50	peak	8.18	22.39	0.79	29.08	40.00	-10.92	100	271
3	V	80.3619	38.07	peak	7.61	22.42	1.05	24.31	40.00	-15.69	100	37
4	V	207.8501	36.27	peak	11.99	22.37	1.57	27.46	43.50	-16.04	100	82
5	V	416.1791	29.80	peak	16.02	21.98	2.05	25.89	46.00	-20.11	100	131
6	V	790.6188	29.55	peak	21.29	21.17	2.94	32.61	46.00	-13.39	200	284

30MHz -1GHz

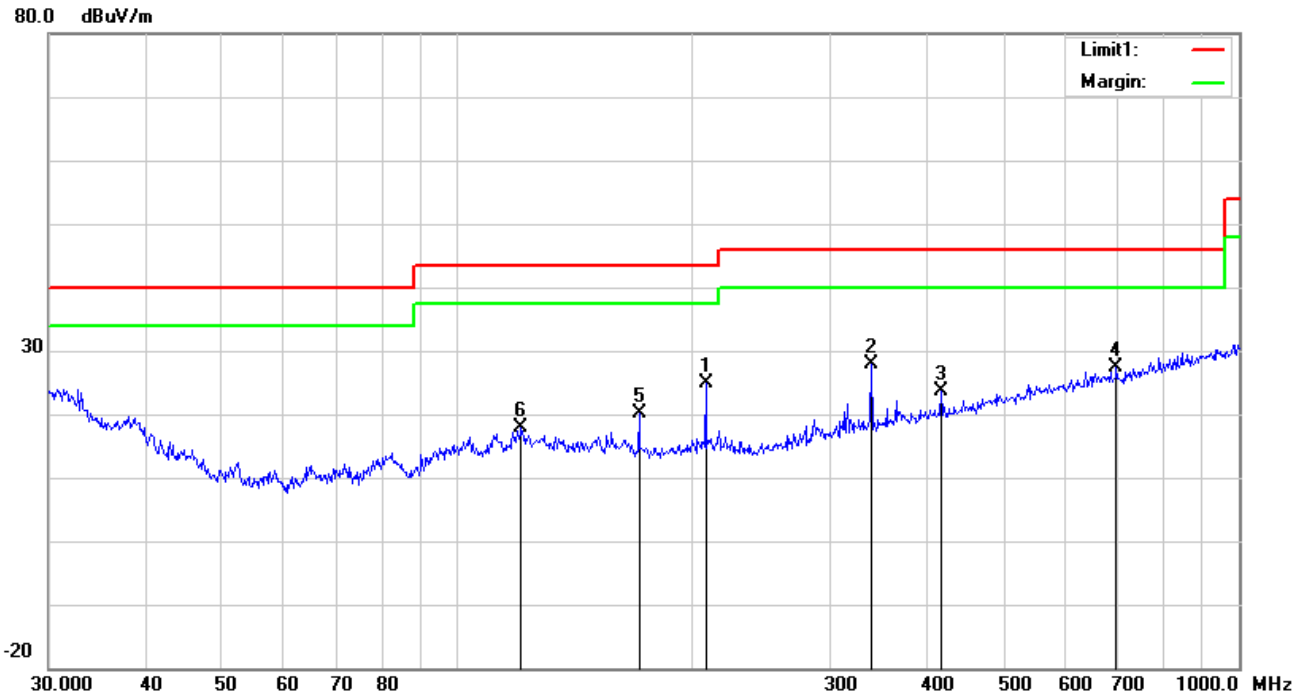

Test Data

Horizontal Polarity Plot @3m

N o.	P/ L	Frequency (MHz)	Reading (dBuV/m)	Detect or	Ant_F (dB/m)	PA_G (dB)	Cab_ L (dB)	Result (dBuV/m)	Limit (dBuV/m)	Margin (dB)	Height (cm)	Degr ee ()
1	H	207.8501	33.77	peak	11.99	22.37	1.57	24.96	43.50	-18.54	100	169
2	H	338.4001	33.57	peak	14.41	22.18	1.98	27.78	46.00	-18.22	100	281
3	H	416.1791	27.59	peak	16.02	21.98	2.05	23.68	46.00	-22.32	100	58
4	H	696.8567	25.99	peak	20.17	21.37	2.55	27.34	46.00	-18.66	100	289
5	H	170.7926	29.18	peak	11.74	22.26	1.36	20.02	43.50	-23.48	100	103
6	H	120.6991	25.19	peak	13.85	22.36	1.16	17.84	43.50	-25.66	100	66

Above 1GHz

Test Mode:	Transmitting Mode
-------------------	--------------------------

Low Channel (2412 MHz) (b mode worst case)

Frequency (MHz)	S.A. Reading (dB μ V)	Detector (PK/AV)	Polarity (H/V)	Ant. Factor (dB/m)	Cable Loss (dB)	Pre-Amp. Gain (dB)	Cord Amp. (dB μ V/m)	Limit (dB μ V/m)	Margin (dB)
4824	44.19	AV	V	33.39	7.22	48.46	36.34	54	-17.66
4824	45.49	AV	H	33.39	7.22	48.46	37.64	54	-16.36
4824	66.69	PK	V	33.39	7.22	48.46	58.84	74	-15.16
4824	63.62	PK	H	33.39	7.22	48.46	55.77	74	-18.23
11326	18.85	AV	V	40.31	13.08	47.13	25.11	54	-28.89
11326	20.8	AV	H	40.31	13.08	47.13	27.06	54	-26.94
11326	41.24	PK	V	40.31	13.08	47.13	47.5	74	-26.5
11326	42.88	PK	H	40.31	13.08	47.13	49.14	74	-24.86

Middle Channel (2437 MHz) (b mode worst case)

Frequency (MHz)	S.A. Reading (dB μ V)	Detector (PK/AV)	Polarity (H/V)	Ant. Factor (dB/m)	Cable Loss (dB)	Pre-Amp. Gain (dB)	Cord Amp. (dB μ V/m)	Limit (dB μ V/m)	Margin (dB)
4874	42.17	AV	V	33.62	7.53	48.36	34.96	54	-19.04
4874	45.62	AV	H	33.62	7.53	48.36	38.41	54	-15.59
4874	68.25	PK	V	33.62	7.53	48.36	61.04	74	-12.96
4874	66.09	PK	H	33.62	7.53	48.36	58.88	74	-15.12
12772	19.59	AV	V	40.07	14.3	47.79	26.17	54	-27.83
12772	21.48	AV	H	40.07	14.3	47.79	28.06	54	-25.94
12772	39.56	PK	V	40.07	14.3	47.79	46.14	74	-27.86
12772	38.95	PK	H	40.07	14.3	47.79	45.53	74	-28.47

High Channel (2462 MHz) (b mode worst case)

Frequency (MHz)	S.A. Reading (dB μ V)	Detector (PK/AV)	Polarity (H/V)	Ant. Factor (dB/m)	Cable Loss (dB)	Pre-Amp. Gain (dB)	Cord Amp. (dB μ V/m)	Limit (dB μ V/m)	Margin (dB)
4924	47.25	AV	V	33.74	7.78	48.34	40.43	54	-13.57
4924	46.16	AV	H	33.74	7.78	48.34	39.34	54	-14.66
4924	69.43	PK	V	33.74	7.78	48.34	62.61	74	-11.39
4924	63.99	PK	H	33.74	7.78	48.34	57.17	74	-16.83
17821	19.25	AV	V	41.13	16.53	45.49	31.42	54	-22.58
17821	20.85	AV	H	41.13	16.53	45.49	33.02	54	-20.98
17821	39.85	PK	V	41.13	16.53	45.49	52.02	74	-21.98
17821	41.2	PK	H	41.13	16.53	45.49	53.37	74	-20.63

Note:

1, The testing has been conformed to $10 \times 2462 \text{MHz} = 24,620 \text{MHz}$

2, All other emissions more than 30 dB below the limit

3, X-Axis, Y-Axis and Z-Axis were investigated. The results above show only the worst case.

4, The radiated spurious test above 18GHz is subcontracted to SIEMIC (Nanjing-China) Laboratories. and found 30dB below the limit at least.

Annex A. TEST INSTRUMENT

Instrument	Model	Serial #	Cal Date	Cal Due	In use
AC Line Conducted					
EMI test receiver	ESCS30	8471241027	09/15/2017	09/14/2018	<input checked="" type="checkbox"/>
Line Impedance	LI-125A	191106	09/23/2017	09/22/2018	<input checked="" type="checkbox"/>
Line Impedance	LI-125A	191107	09/23/2017	09/22/2018	<input checked="" type="checkbox"/>
ISN	ISN T800	34373	09/23/2017	09/22/2018	<input type="checkbox"/>
Transient Limiter	LIT-153	531118	08/30/2017	08/29/2018	<input type="checkbox"/>
RF conducted test					
Agilent ESA-E SERIES	E4407B	MY45108319	09/15/2017	09/14/2018	<input checked="" type="checkbox"/>
Power Splitter	1#	1#	08/30/2017	08/29/2018	<input checked="" type="checkbox"/>
DC Power Supply	E3640A	MY40004013	09/15/2017	09/14/2018	<input checked="" type="checkbox"/>
Radiated Emissions					
EMI test receiver	ESL6	100262	09/15/2017	09/14/2018	<input checked="" type="checkbox"/>
Positioning Controller	UC3000	MF780208282	11/18/2016	11/17/2017	<input checked="" type="checkbox"/>
OPT 010 AMPLIFIER (0.1-1300MHz)	8447E	2727A02430	08/30/2017	08/29/2018	<input checked="" type="checkbox"/>
Microwave Preamplifier (1 ~ 26.5GHz)	8449B	3008A02402	03/23/2017	03/22/2018	<input checked="" type="checkbox"/>
Horn Antenna	BBHA9170	3145226D1	09/27/2017	09/26/2018	<input checked="" type="checkbox"/>
Active Antenna (9kHz-30MHz)	AL-130	121031	10/12/2017	10/11/2018	<input checked="" type="checkbox"/>
Bilog Antenna (30MHz~6GHz)	JB6	A110712	09/19/2017	09/18/2018	<input checked="" type="checkbox"/>
Double Ridge Horn Antenna (1 ~18GHz)	AH-118	71283	09/22/2017	09/21/2018	<input checked="" type="checkbox"/>
Universal Radio Communication Tester	CMU200	121393	09/23/2017	09/22/2018	<input checked="" type="checkbox"/>

Annex B. EUT and Test Setup Photographs

Annex B.i. Photograph: EUT External Photo

Whole Package View



Adapter - Label View

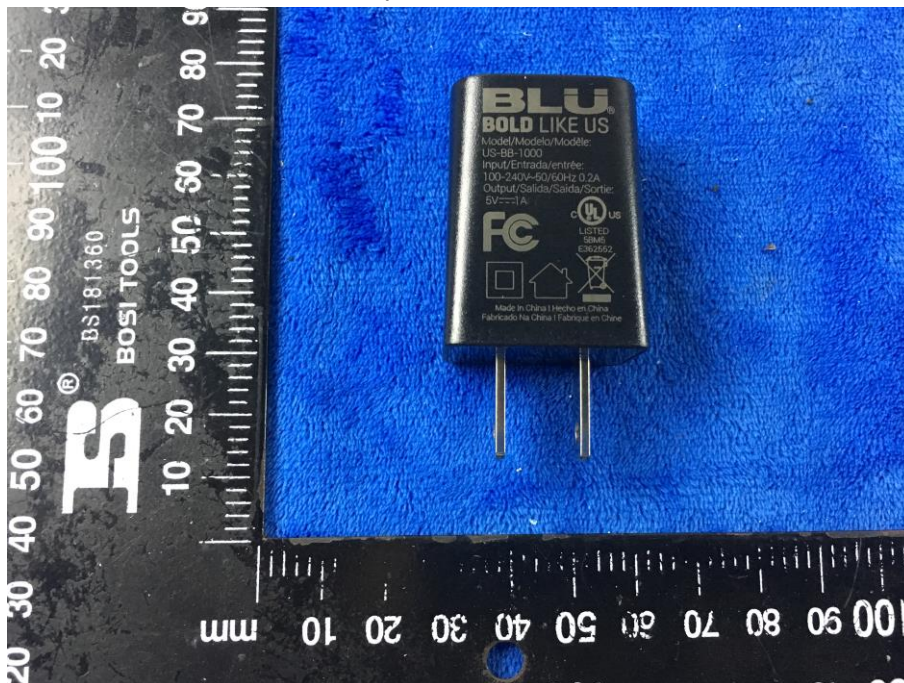

EUT - Front View



EUT - Rear View



EUT - Top View

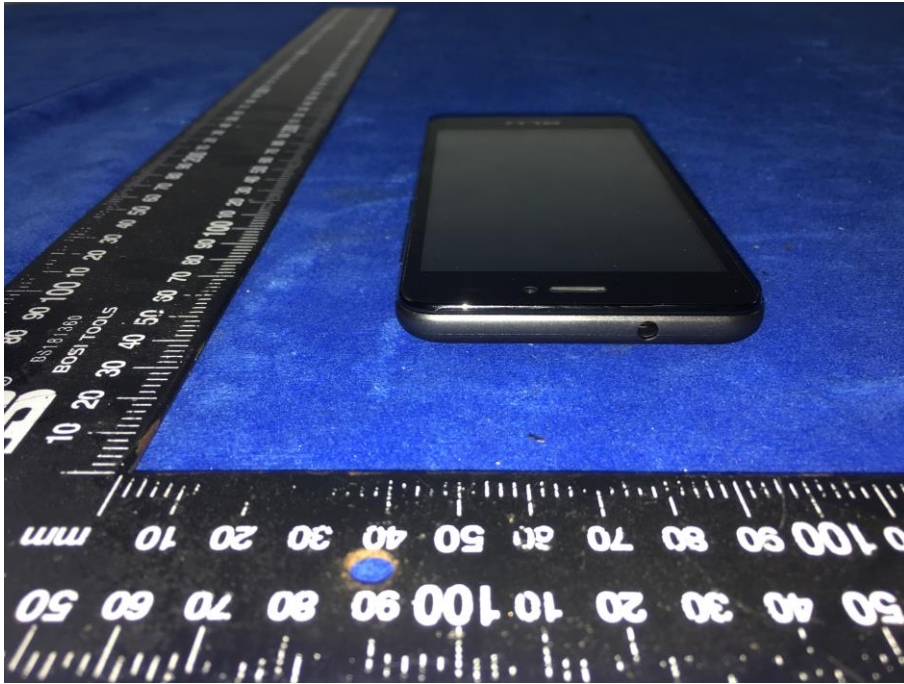

EUT - Bottom View

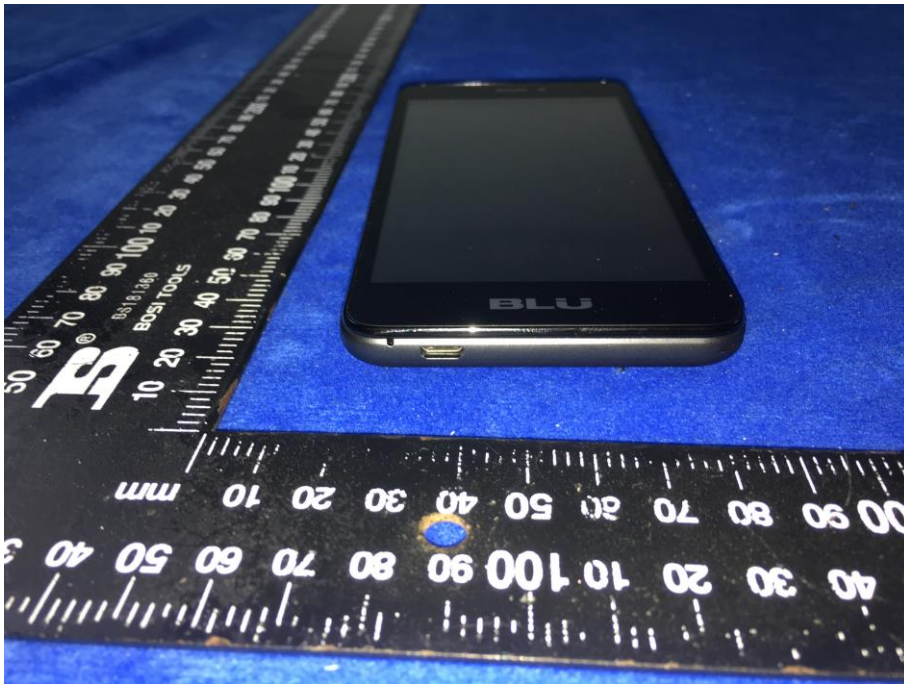

EUT - Left View

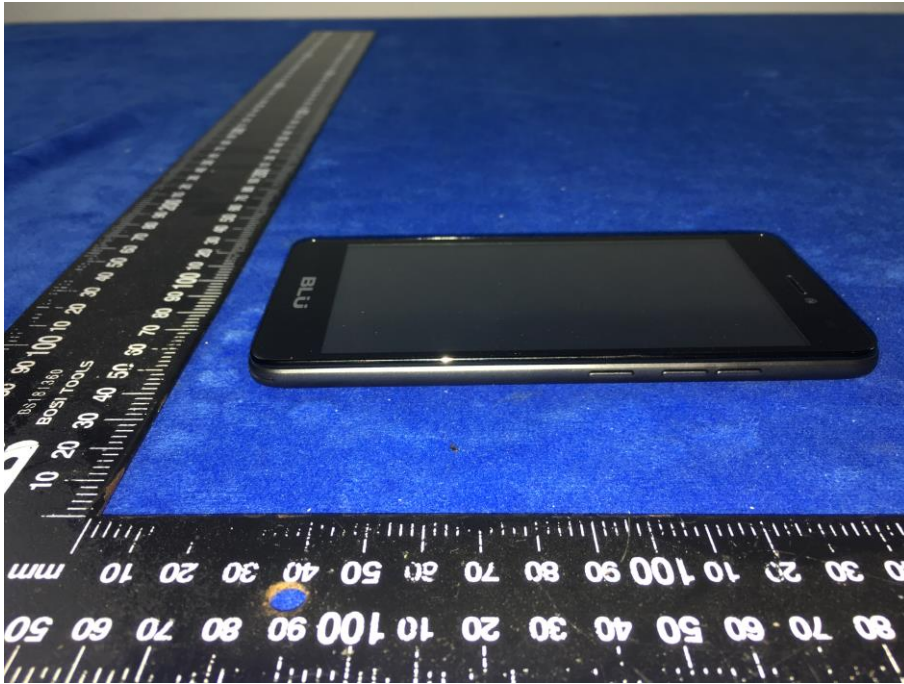

EUT - Right View

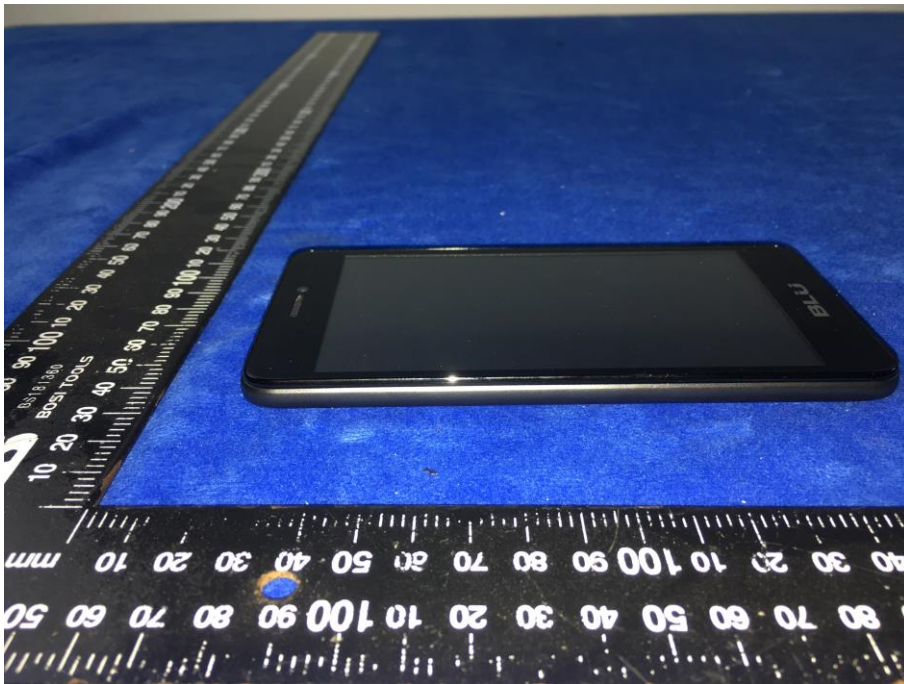

Annex B.ii. Photograph: EUT Internal Photo

Cover Off - Top View 1



Cover Off - Top View 2



Test Report No.	17071300-FCC-R2
Page	52 of 64

Battery - Front View

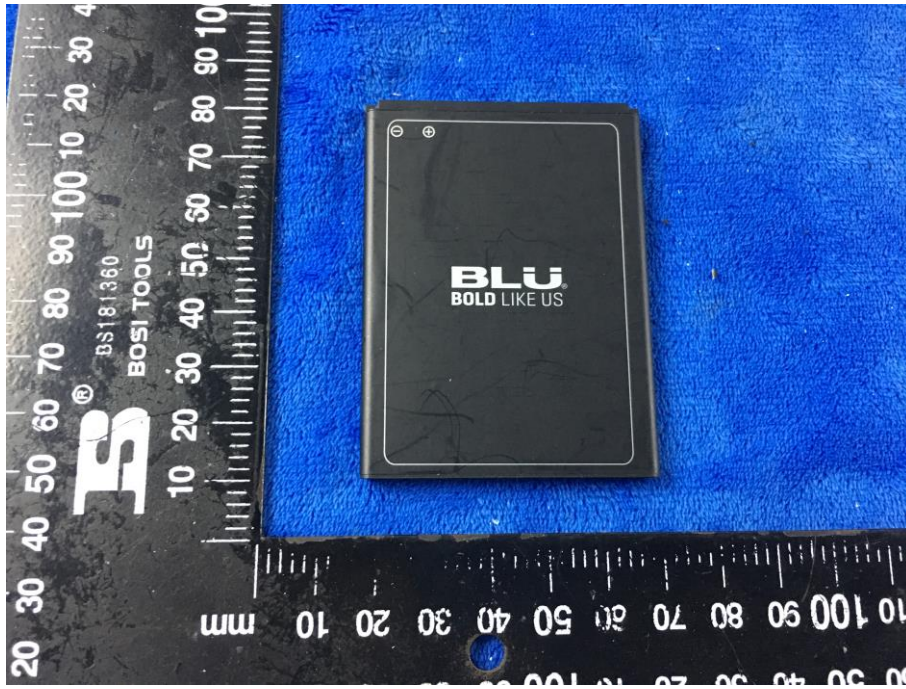

Battery - Rear View



Mainboard with Shielding - Front View

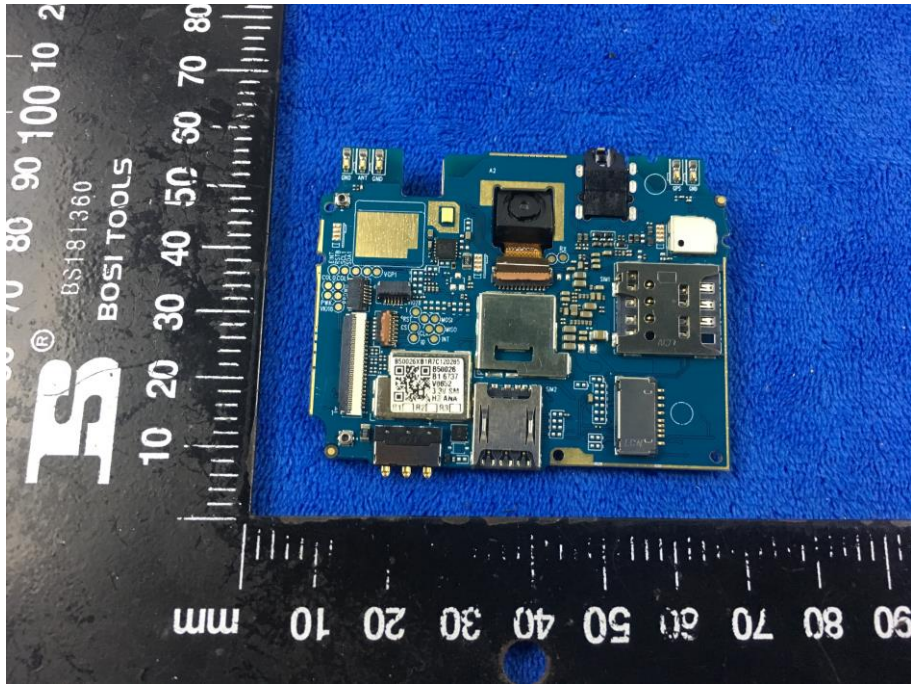

Mainboard without Shielding - Front View

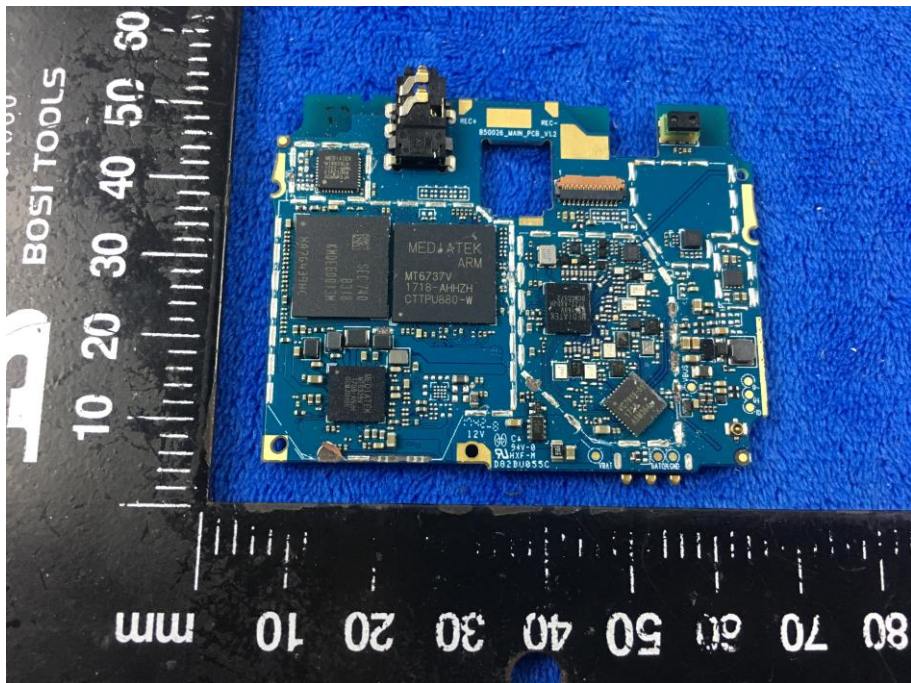

Mainboard without Shielding – Rear View

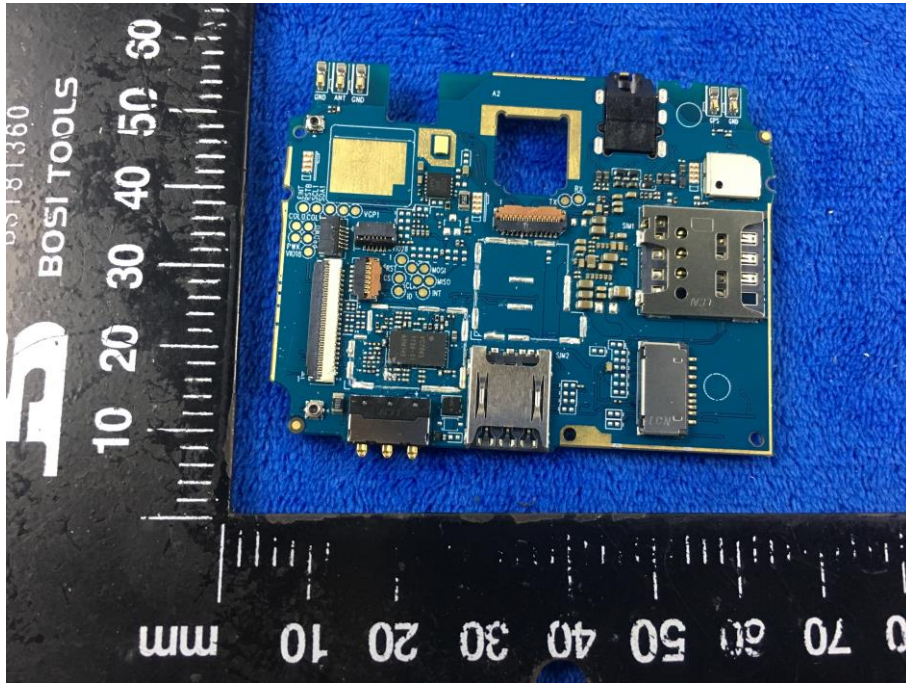

Smallboard – Front View

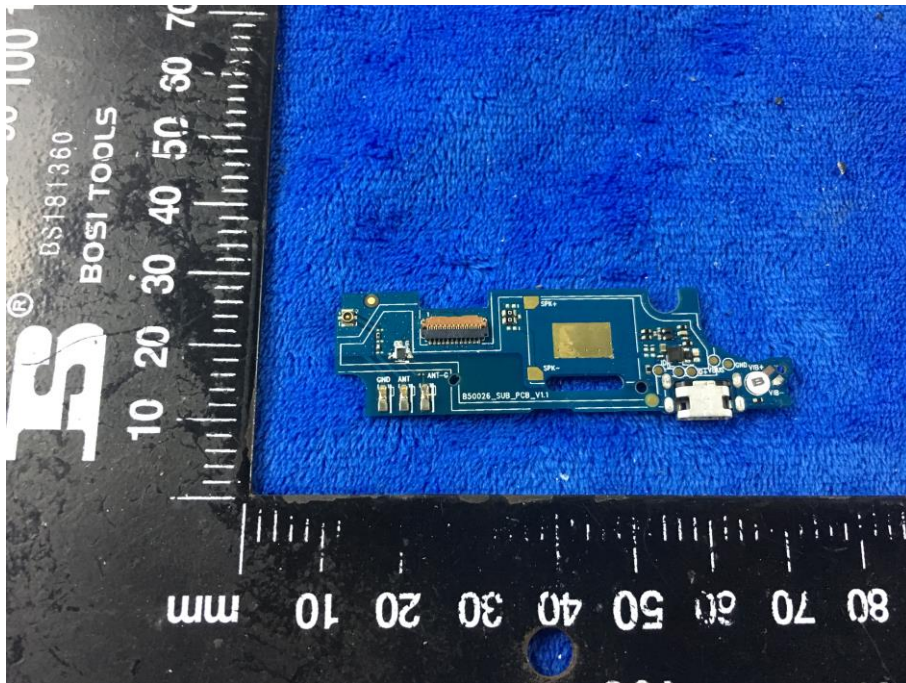

Smallboard – Rear View

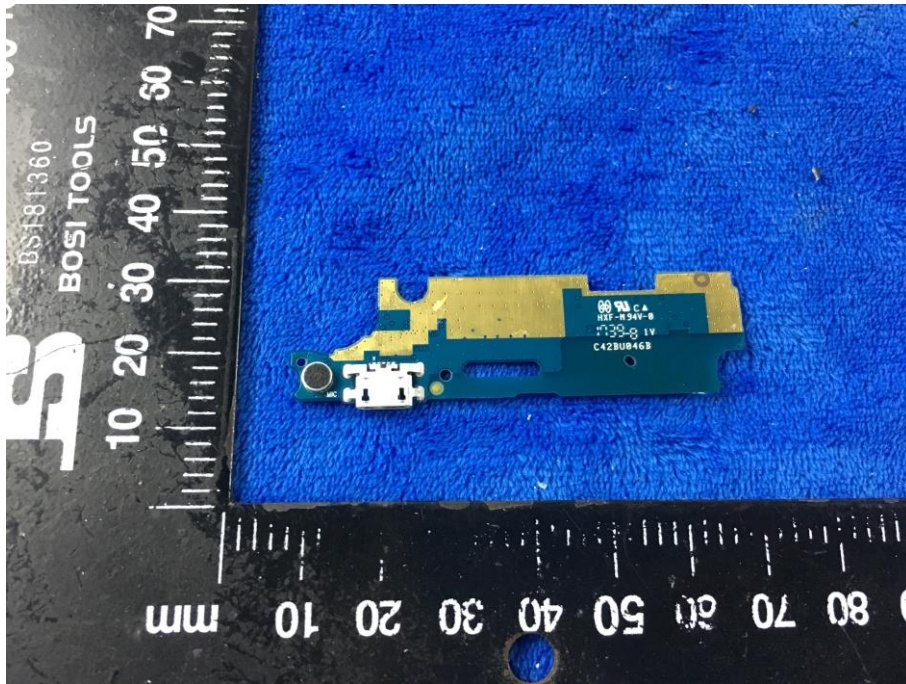

LCD – Front View



LCD – Rear View



GSM/PCS/UMTS-FDD/LTE Antenna View



WIFI/BT/BLE/GPS - Antenna View



RXD- Antenna View



Annex B.iii. Photograph: Test Setup Photo

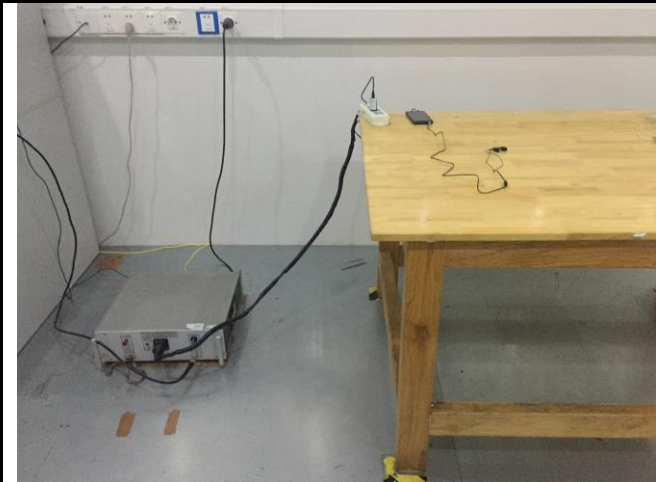

Conducted Emissions Test Setup Front View



Conducted Emissions Test Setup Side View

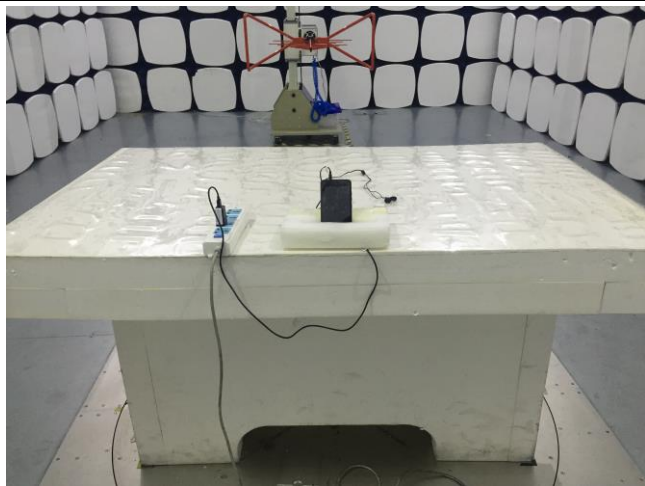

Radiated Spurious Emissions Test Setup Below 1GHz



Radiated Spurious Emissions Test Setup Above
1GHz

Annex C. TEST SETUP AND SUPPORTING EQUIPMENT

Annex C.ii. TEST SET UP BLOCK

Block Configuration Diagram for AC Line Conducted Emissions

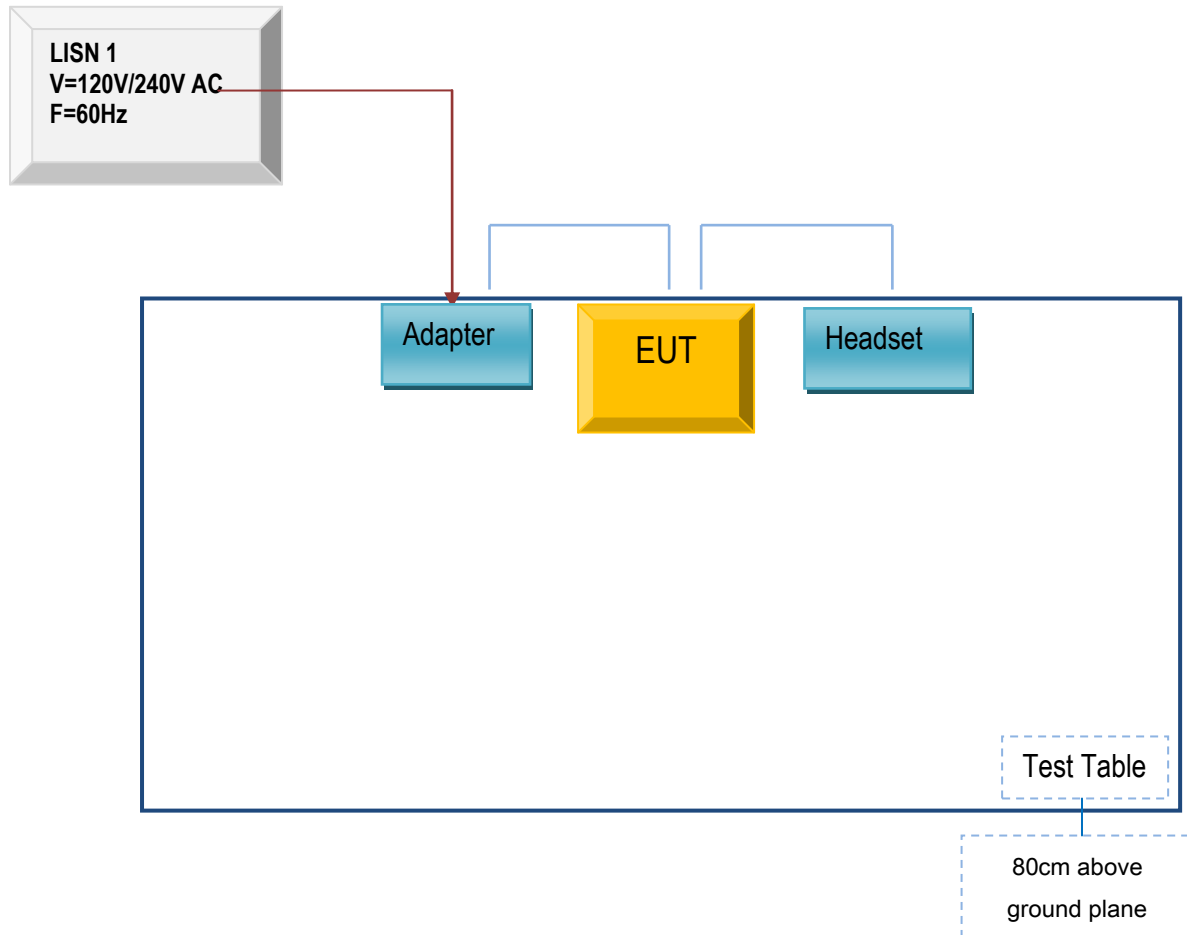

Block Configuration Diagram for Radiated Emissions (Below 1GHz) .

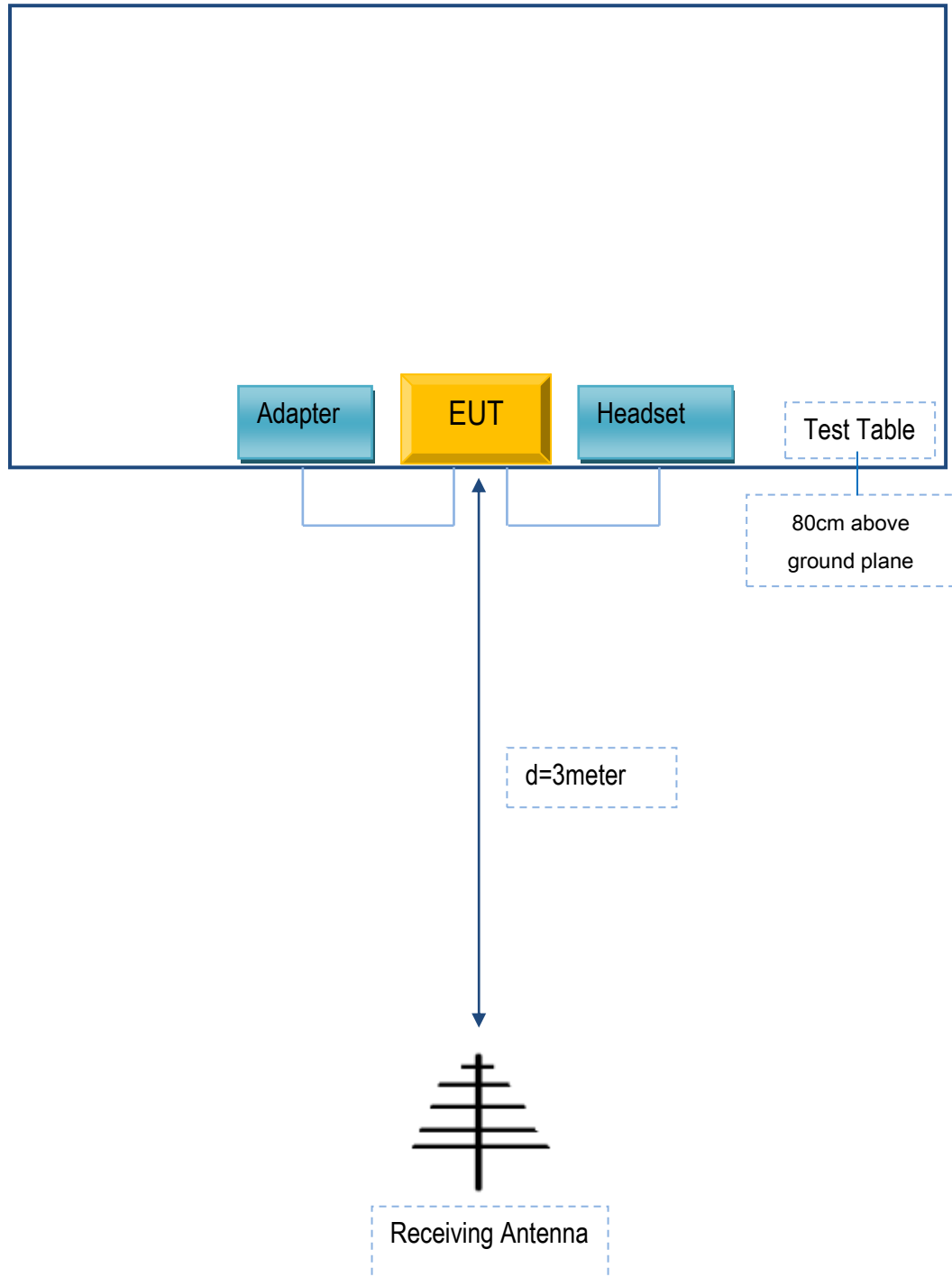

Block Configuration Diagram for Radiated Emissions (Above 1GHz) .

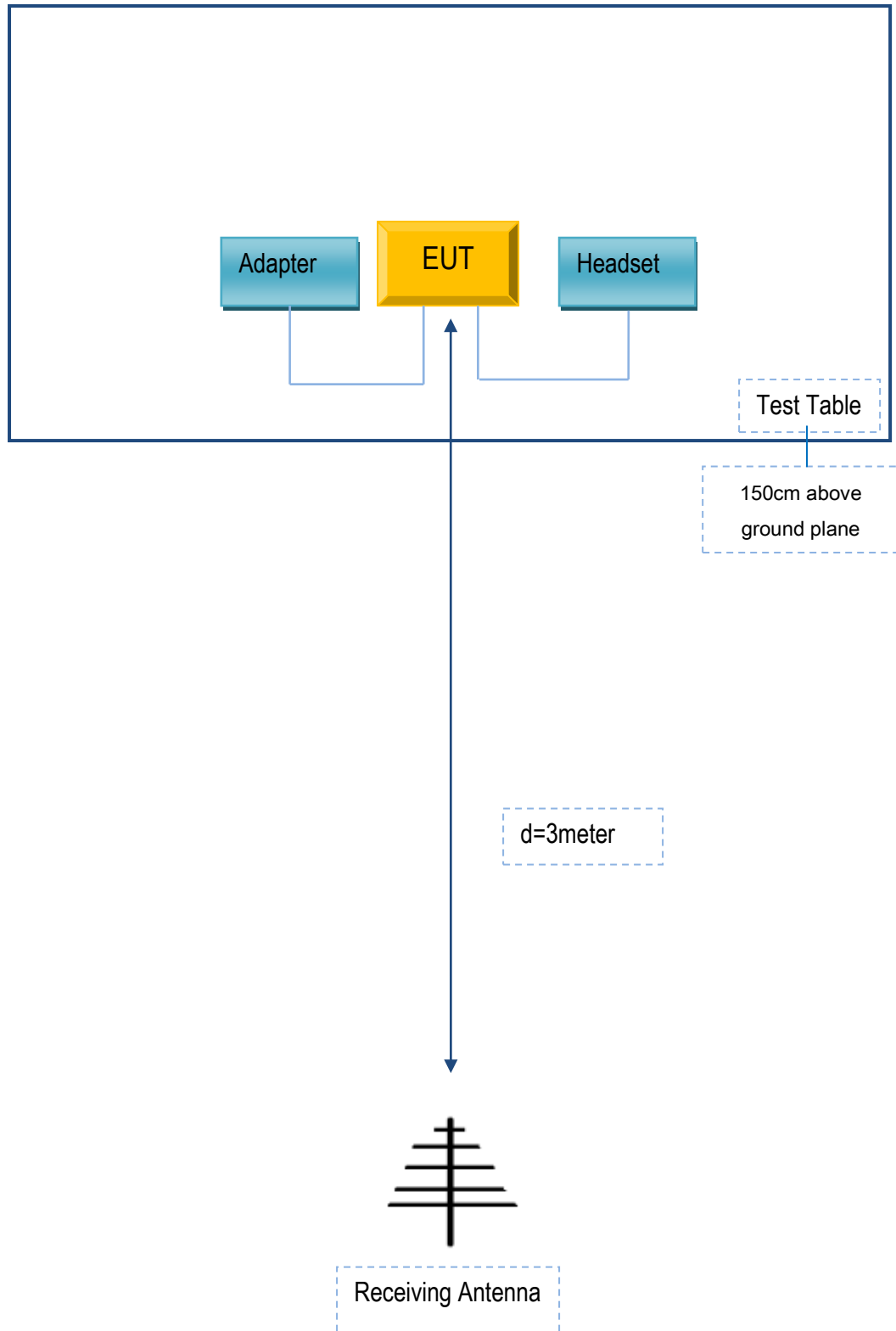

Annex C. ii. SUPPORTING EQUIPMENT DESCRIPTION

The following is a description of supporting equipment and details of cables used with the EUT.

Supporting Equipment:

Manufacturer	Equipment Description	Model	Serial No
BLU Products, Inc.	Adapter	US-BB-1000	N/A
SAMSUNG	headset	HS330	N/A

Supporting Cable:

Cable type	Shield Type	Ferrite Core	Length	Serial No
USB Cable	Un-shielding	No	0.8m	N/A

Test Report No.	17071300-FCC-R2
Page	63 of 64

Annex D. User Manual / Block Diagram / Schematics / Partlist

Please see the attachment

Test Report No.	17071300-FCC-R2
Page	64 of 64

Annex E. DECLARATION OF SIMILARITY

N/A