

8-DPSK Mode:

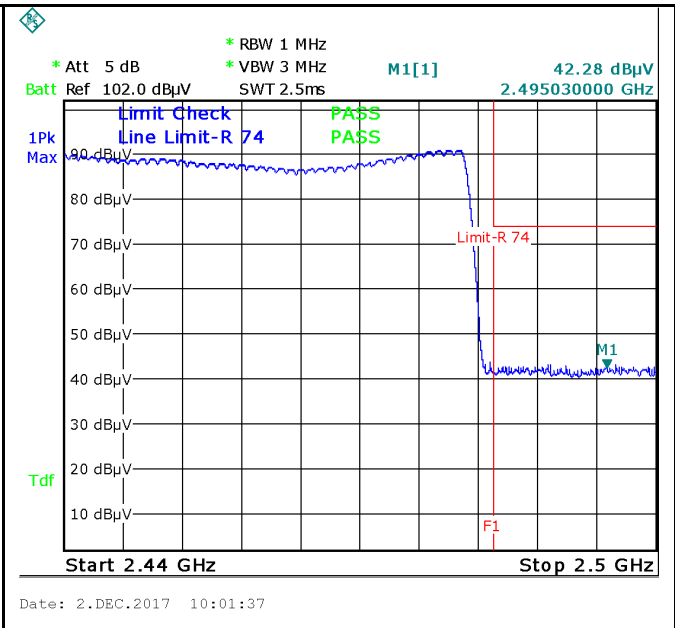
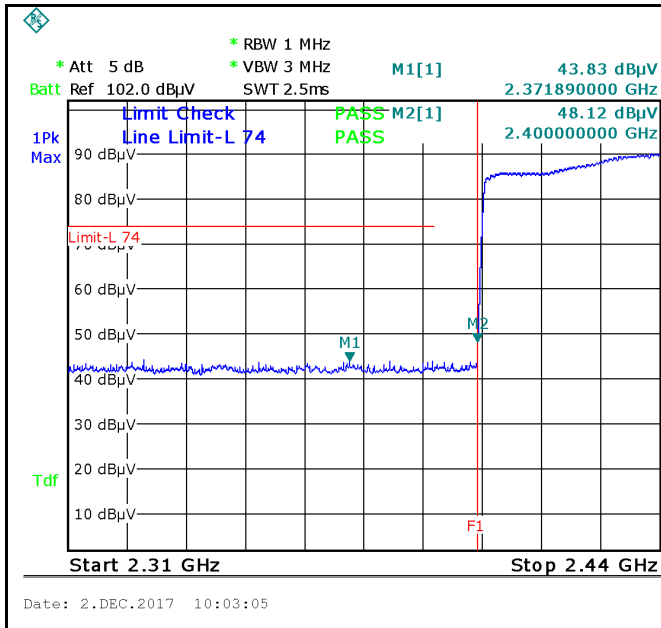

8DPSK-Hopping Left Side-PK
Note: F1 is frequency 2400MHz

8DPSK-Hopping Right Side-PK
Note: F1 is frequency 2483.5MHz

Note: (no need if PK value less than the AV limit)

Note: (no need if PK value less than the AV limit)

8DPSK-Hopping Left-AV

8DPSK-Hopping Right-AV

Note: Both Horizontal and vertical polarities were investigated.

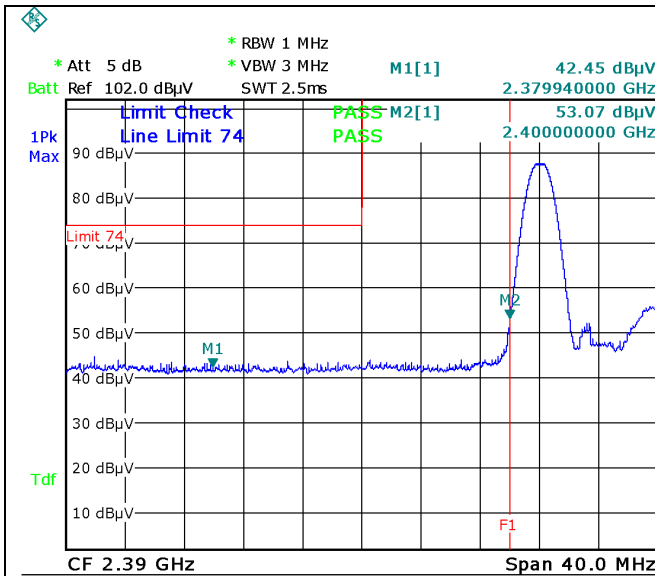

Date: 2.DEC.2017 09:57:09

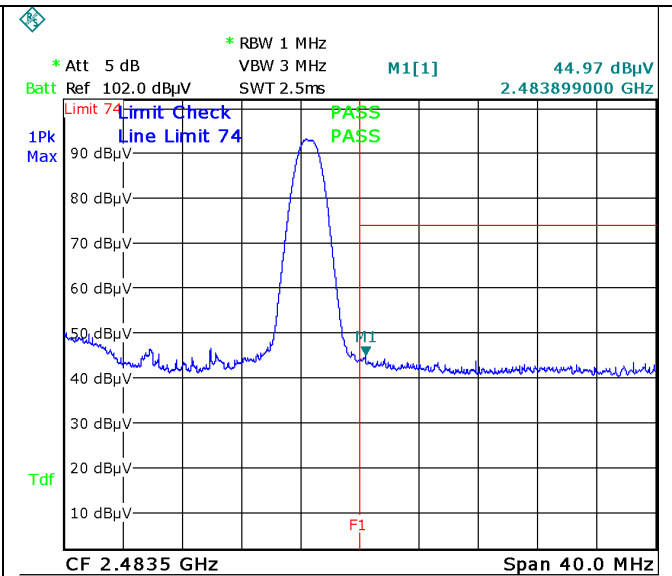

Date: 27.NOV.2017 11:44:36

8DPSK-Left Side-PK

Note: F1 is frequency 2400MHz

8DPSK-Right Side-PK

Note: F1 is frequency 2483.5MHz

Note: (no need if PK value less than the AV limit)

Note: (no need if PK value less than the AV limit)

8DPSK-Left Side-AV

8DPSK-Right Side-AV

Note: Both Horizontal and vertical polarities were investigated.

6.8 AC Power Line Conducted Emissions

Temperature	25 °C
Relative Humidity	50%
Atmospheric Pressure	1008mbar
Test date :	December 08, 2017
Tested By :	Aaron Liang

Requirement(s):

Spec	Item	Requirement	Applicable														
47CFR§15.207, RSS210 (A8.1)	a)	For Low-power radio-frequency devices that is designed to be connected to the public utility (AC) power line, the radio frequency voltage that is conducted back onto the AC power line on any frequency or frequencies, within the band 150 kHz to 30 MHz, shall not exceed the limits in the following table, as measured using a 50 [mu]H/50 ohms line impedance stabilization network (LISN). The lower limit applies at the boundary between the frequencies ranges.	<input checked="" type="checkbox"/>														
		<table border="1"> <thead> <tr> <th rowspan="2">Frequency ranges (MHz)</th> <th colspan="2">Limit (dBµV)</th> </tr> <tr> <th>QP</th> <th>Average</th> </tr> </thead> <tbody> <tr> <td>0.15 ~ 0.5</td> <td>66 – 56</td> <td>56 – 46</td> </tr> <tr> <td>0.5 ~ 5</td> <td>56</td> <td>46</td> </tr> <tr> <td>5 ~ 30</td> <td>60</td> <td>50</td> </tr> </tbody> </table>		Frequency ranges (MHz)	Limit (dBµV)		QP	Average	0.15 ~ 0.5	66 – 56	56 – 46	0.5 ~ 5	56	46	5 ~ 30	60	50
		Frequency ranges (MHz)			Limit (dBµV)												
				QP	Average												
0.15 ~ 0.5	66 – 56	56 – 46															
0.5 ~ 5	56	46															
5 ~ 30	60	50															

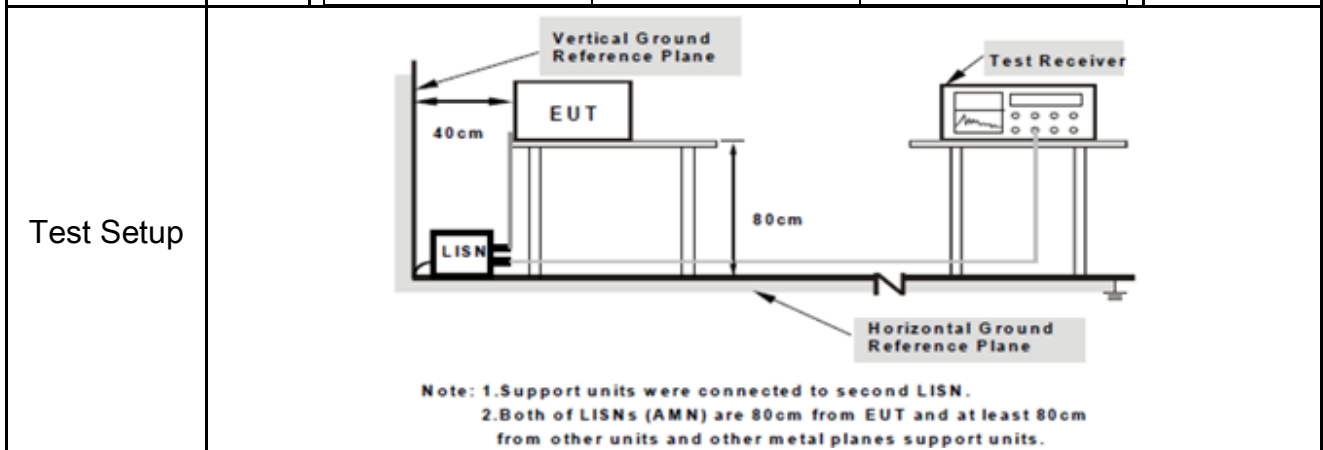

Procedure	<ol style="list-style-type: none"> The EUT and supporting equipment were set up in accordance with the requirements of the standard on top of a 1.5m x 1m x 0.8m high, non-metallic table. The power supply for the EUT was fed through a 50W/50mH EUT LISN, connected to filtered mains. The RF OUT of the EUT LISN was connected to the EMI test receiver via a low-loss
-----------	---

Test Report	17071300-FCC-R3
Page	38 of 68

	<p>coaxial cable.</p> <ol style="list-style-type: none"> 4. All other supporting equipment were powered separately from another main supply. 5. The EUT was switched on and allowed to warm up to its normal operating condition. 6. A scan was made on the NEUTRAL line (for AC mains) or Earth line (for DC power) over the required frequency range using an EMI test receiver. 7. High peaks, relative to the limit line, The EMI test receiver was then tuned to the selected frequencies and the necessary measurements made with a receiver bandwidth setting of 10 kHz. 8. Step 7 was then repeated for the LIVE line (for AC mains) or DC line (for DC power).
Remark	
Result	<input checked="" type="checkbox"/> Pass <input type="checkbox"/> Fail

Test Data Yes N/A
 Test Plot Yes (See below) N/A

Test Mode:	Bluetooth Mode
-------------------	-----------------------

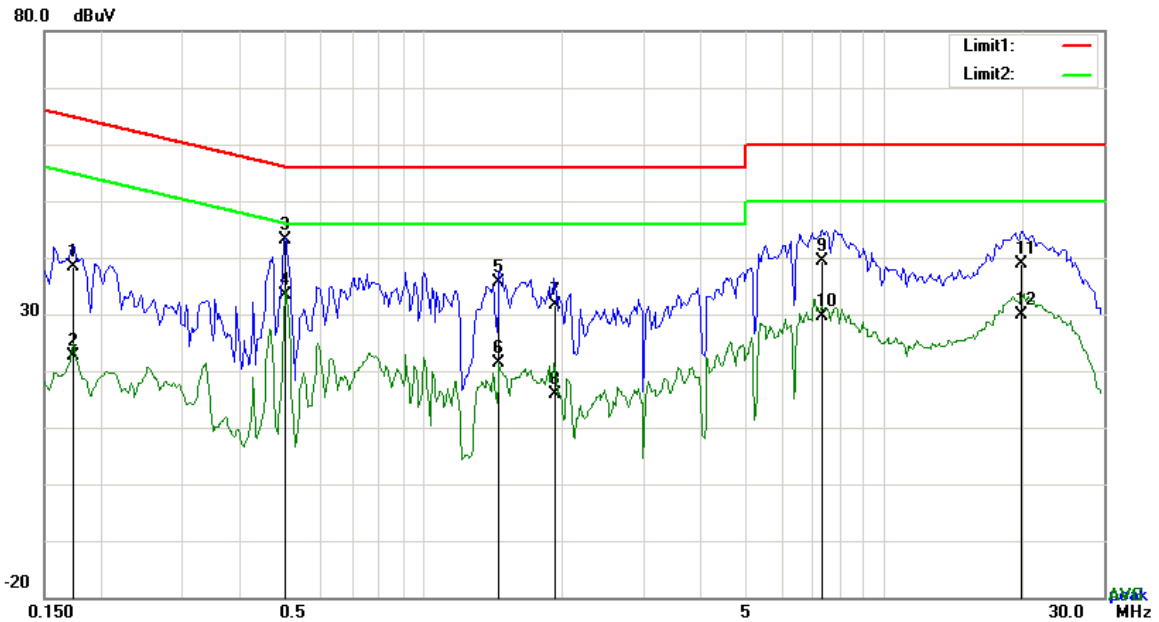

Test Data

Phase Line Plot at 120Vac, 60Hz

No.	P/L	Frequency (MHz)	Reading (dBuV)	Detector	Corrected (dB)	Result (dBuV)	Limit (dBuV)	Margin (dB)
1	L1	0.1734	28.40	QP	10.03	38.43	64.80	-26.37
2	L1	0.1734	12.67	AVG	10.03	22.70	54.80	-32.10
3	L1	0.5010	33.15	QP	10.03	43.18	56.00	-12.82
4	L1	0.5010	23.38	AVG	10.03	33.41	46.00	-12.59
5	L1	1.4565	25.51	QP	10.04	35.55	56.00	-20.45
6	L1	1.4565	11.39	AVG	10.04	21.43	46.00	-24.57
7	L1	1.9284	21.57	QP	10.04	31.61	56.00	-24.39
8	L1	1.9284	5.91	AVG	10.04	15.95	46.00	-30.05
9	L1	7.3641	29.23	QP	10.11	39.34	60.00	-20.66
10	L1	7.3641	19.40	AVG	10.11	29.51	50.00	-20.49
11	L1	19.8831	28.58	QP	10.30	38.88	60.00	-21.12
12	L1	19.8831	19.50	AVG	10.30	29.80	50.00	-20.20

Test Mode:	Bluetooth Mode
-------------------	-----------------------

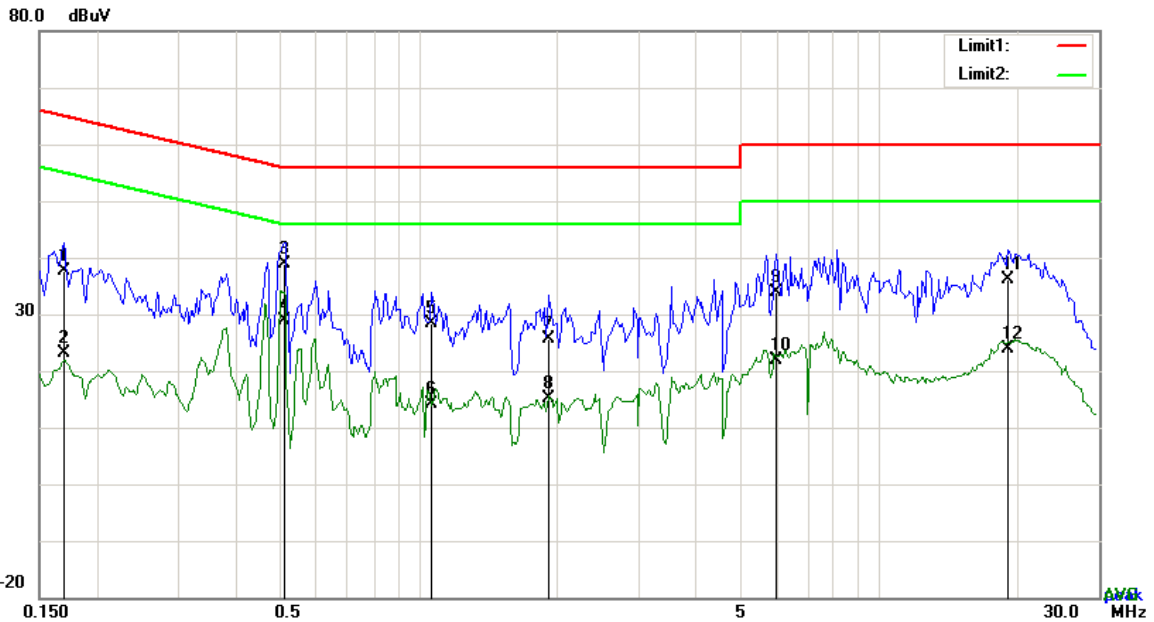

Test Data

Phase Neutral Plot at 120Vac, 60Hz

No.	P/L	Frequency	Reading	Detector	Corrected	Result	Limit	Margin
		(MHz)	(dBuV)		(dB}	(dBuV)	(dBuV)	(dB)
1	N	0.1695	27.53	QP	10.03	37.56	64.98	-27.42
2	N	0.1695	13.17	AVG	10.03	23.20	54.98	-31.78
3	N	0.5127	28.74	QP	10.03	38.77	56.00	-17.23
4	N	0.5127	18.91	AVG	10.03	28.94	46.00	-17.06
5	N	1.0665	18.26	QP	10.03	28.29	56.00	-27.71
6	N	1.0665	4.02	AVG	10.03	14.05	46.00	-31.95
7	N	1.9128	15.70	QP	10.04	25.74	56.00	-30.26
8	N	1.9128	5.09	AVG	10.04	15.13	46.00	-30.87
9	N	5.9640	23.70	QP	10.09	33.79	60.00	-26.21
10	N	5.9640	11.69	AVG	10.09	21.78	50.00	-28.22
11	N	19.0797	25.80	QP	10.29	36.09	60.00	-23.91
12	N	19.0797	13.53	AVG	10.29	23.82	50.00	-26.18

Test Mode:	Bluetooth Mode
-------------------	-----------------------

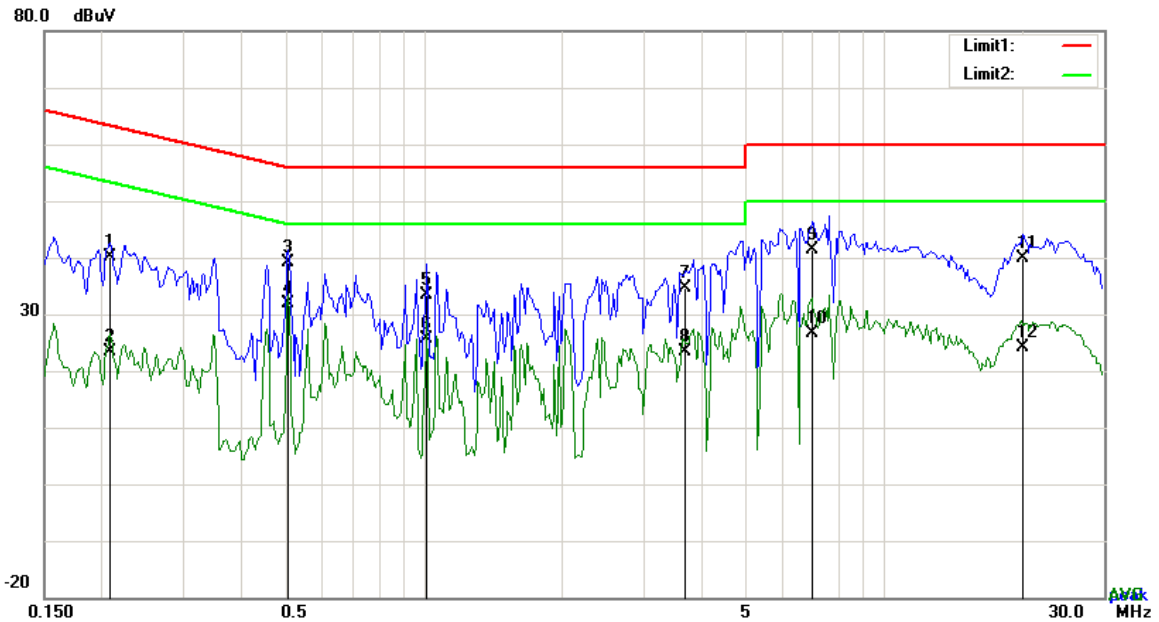

Test Data

Phase Line Plot at 240Vac, 60Hz

No.	P/L	Frequency	Reading	Detector	Corrected	Result	Limit	Margin
		(MHz)	(dBuV)		(dB)	(dBuV)	(dBuV)	(dB)
1	L1	0.2085	30.04	QP	10.03	40.07	63.26	-23.19
2	L1	0.2085	13.39	AVG	10.03	23.42	53.26	-29.84
3	L1	0.5088	29.17	QP	10.03	39.20	56.00	-16.80
4	L1	0.5088	21.89	AVG	10.03	31.92	46.00	-14.08
5	L1	1.0158	23.47	QP	10.03	33.50	56.00	-22.50
6	L1	1.0158	15.67	AVG	10.03	25.70	46.00	-20.30
7	L1	3.7020	24.65	QP	10.06	34.71	56.00	-21.29
8	L1	3.7020	13.25	AVG	10.06	23.31	46.00	-22.69
9	L1	7.0092	31.30	QP	10.11	41.41	60.00	-18.59
10	L1	7.0092	16.62	AVG	10.11	26.73	50.00	-23.27
11	L1	20.0079	29.64	QP	10.30	39.94	60.00	-20.06
12	L1	20.0079	13.80	AVG	10.30	24.10	50.00	-25.90

Test Mode:	Bluetooth Mode
-------------------	-----------------------

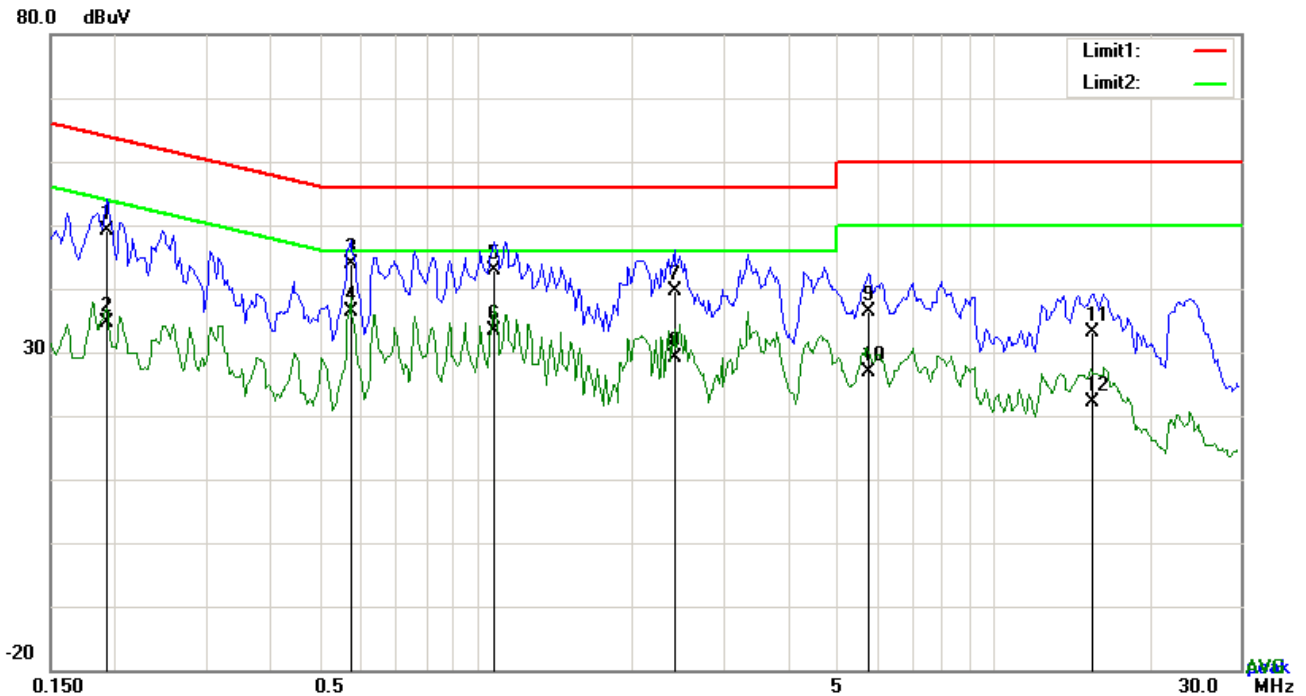

Test Data

Phase Neutral Plot at 240Vac, 60Hz

No.	P/L	Frequency	Reading	Detector	Corrected	Result	Limit	Margin
		(MHz)	(dBuV)		(dB)	(dBuV)	(dBuV)	(dB)
1	N	0.1929	39.22	QP	10.02	49.24	63.91	-14.67
2	N	0.1929	24.70	AVG	10.02	34.72	53.91	-19.19
3	N	0.5712	33.94	QP	10.02	43.96	56.00	-12.04
4	N	0.5712	26.26	AVG	10.02	36.28	46.00	-9.72
5	N	1.0821	32.93	QP	10.03	42.96	56.00	-13.04
6	N	1.0821	23.35	AVG	10.03	33.38	46.00	-12.62
7	N	2.4120	29.48	QP	10.04	39.52	56.00	-16.48
8	N	2.4120	19.17	AVG	10.04	29.21	46.00	-16.79
9	N	5.7378	26.37	QP	10.08	36.45	60.00	-23.55
10	N	5.7378	16.82	AVG	10.08	26.90	50.00	-23.10
11	N	15.5073	22.80	QP	10.21	33.01	60.00	-26.99
12	N	15.5073	11.97	AVG	10.21	22.18	50.00	-27.82

6.9 Radiated Emissions & Restricted Band

Temperature	25 °C
Relative Humidity	55%
Atmospheric Pressure	1017mbar
Test date :	November 23, 2017
Tested By :	Aaron Liang

Requirement(s):

Spec	Item	Requirement	Applicable																
47CFR§15.205, §15.209, §15.247(d)	a)	Except higher limit as specified elsewhere in other section, the emissions from the low-power radio-frequency devices shall not exceed the field strength levels specified in the following table and the level of any unwanted emissions shall not exceed the level of the fundamental emission. The tighter limit applies at the band edges	<input checked="" type="checkbox"/>																
		<table border="1"> <thead> <tr> <th>Frequency range (MHz)</th> <th>Field Strength ($\mu\text{V}/\text{m}$)</th> </tr> </thead> <tbody> <tr> <td>0.009~0.490</td> <td>2400/F(KHz)</td> </tr> <tr> <td>0.490~1.705</td> <td>24000/F(KHz)</td> </tr> <tr> <td>1.705~30.0</td> <td>30</td> </tr> <tr> <td>30 – 88</td> <td>100</td> </tr> <tr> <td>88 – 216</td> <td>150</td> </tr> <tr> <td>216 960</td> <td>200</td> </tr> <tr> <td>Above 960</td> <td>500</td> </tr> </tbody> </table>		Frequency range (MHz)	Field Strength ($\mu\text{V}/\text{m}$)	0.009~0.490	2400/F(KHz)	0.490~1.705	24000/F(KHz)	1.705~30.0	30	30 – 88	100	88 – 216	150	216 960	200	Above 960	500
		Frequency range (MHz)		Field Strength ($\mu\text{V}/\text{m}$)															
		0.009~0.490		2400/F(KHz)															
		0.490~1.705		24000/F(KHz)															
		1.705~30.0		30															
		30 – 88		100															
		88 – 216		150															
216 960	200																		
Above 960	500																		

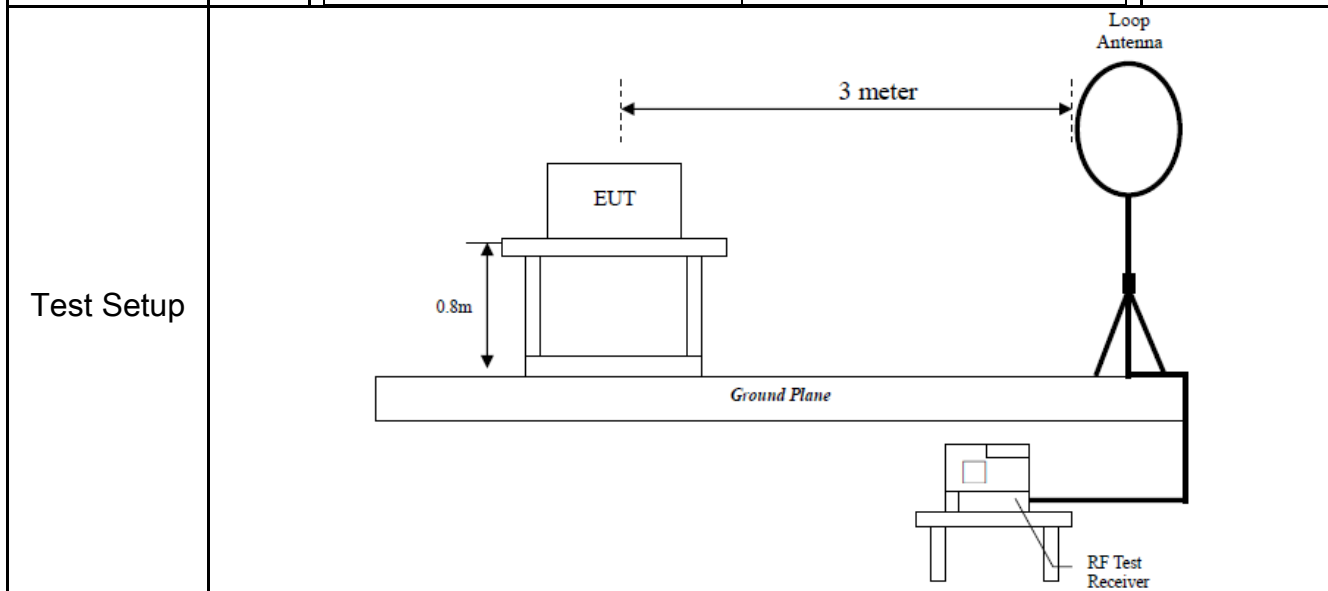

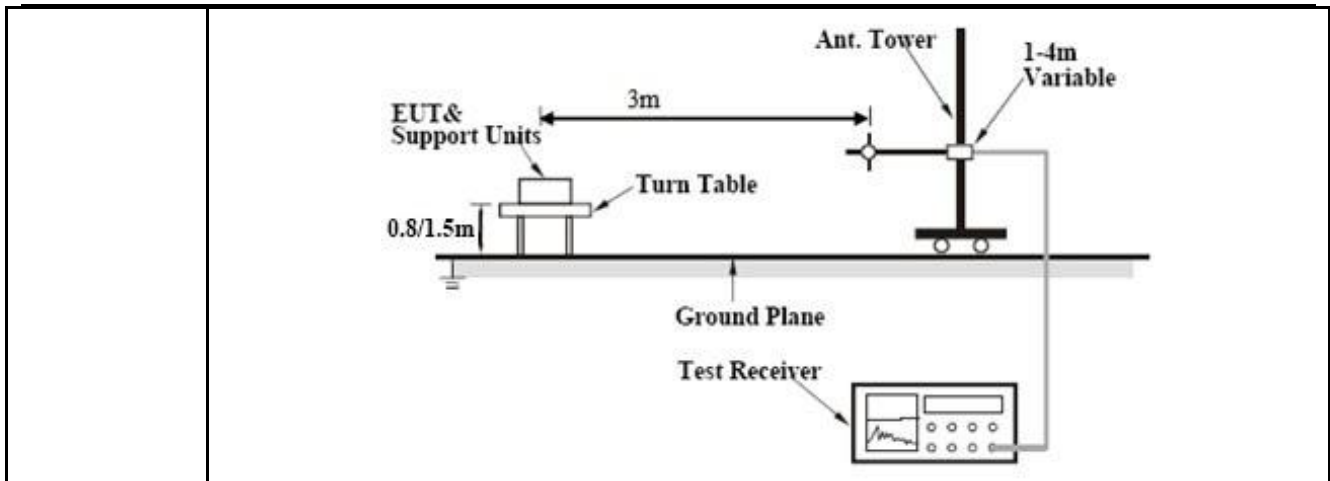

Procedure

- The EUT was switched on and allowed to warm up to its normal operating condition.
- The test was carried out at the selected frequency points obtained from the EUT characterization. Maximization of the emissions, was carried out by rotating the EUT, changing the antenna polarization, and adjusting the antenna height in the following manner:
 - Vertical or horizontal polarization (whichever gave the higher emission level over a full rotation of the EUT) was chosen.
 - The EUT was then rotated to the direction that gave the maximum emission.
 - Finally, the antenna height was adjusted to the height that gave the maximum emission.
- The resolution bandwidth and video bandwidth of test receiver/spectrum analyzer is 120 kHz for Quasi Peak detection at frequency below 1GHz.
- The resolution bandwidth of test receiver/spectrum analyzer is 1MHz and video bandwidth is 3MHz with Peak detection for Peak measurement at frequency above 1GHz.
The resolution bandwidth of test receiver/spectrum analyzer is 1MHz and the video bandwidth is 10Hz with Peak detection for Average Measurement as below at frequency above 1GHz.
- Steps 2 and 3 were repeated for the next frequency point, until all selected frequency points were measured.

Remark

Result Pass Fail

Test Data Yes N/A

Test Plot Yes (See below) N/A

Test Result:

Test Mode:	Transmitting Mode
-------------------	-------------------

Frequency range: 9KHz - 30MHz

Freq. (MHz)	Detection value	Factor (dB/m)	Reading (dBuV/m)	Result (dBuV/m)	Limit@3m (dBuV/m)	Margin (dB)
--	--	--	--	--	--	>20
--	--	--	--	--	--	>20

Note:

The amplitude of spurious emissions which are attenuated by more than 20dB below the permissible value has no need to be reported.

Distance extrapolation factor = $40 \log (\text{specific distance}/\text{test distance})$ (dB);

Limit line = specific limits(dBuv) + distance extrapolation factor.

Test Mode: Bluetooth Mode

30MHz -1GHz

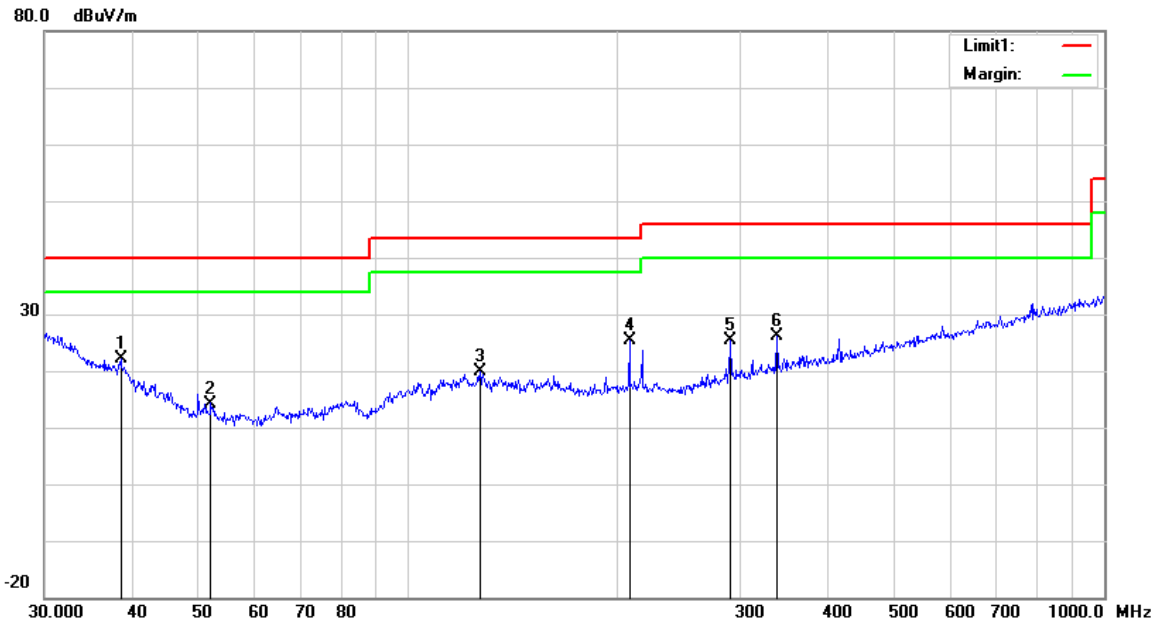

Test Data

Horizontal Polarity Plot @3m

No.	P/L	Frequency (MHz)	Reading (dBuV/m)	Detect or	Ant_F (dB/m)	PA_G (dB)	Cab_L (dB)	Result (dBuV/m)	Limit (dBuV/m)	Margin (dB)	Height (cm)	Degr ee (°)
1	H	38.6161	28.72	peak	14.91	22.27	0.78	22.14	40.00	-17.86	200	301
2	H	52.0251	27.67	peak	8.18	22.39	0.79	14.25	40.00	-25.75	100	253
3	H	126.7723	27.53	peak	13.46	22.38	1.19	19.80	43.50	-23.70	100	8
4	H	207.8501	34.22	peak	11.99	22.37	1.57	25.41	43.50	-18.09	100	82
5	H	290.0172	32.80	peak	13.16	22.29	1.77	25.44	46.00	-20.56	100	187
6	H	338.4001	31.97	peak	14.41	22.18	1.98	26.18	46.00	-19.82	100	272

30MHz -1GHz

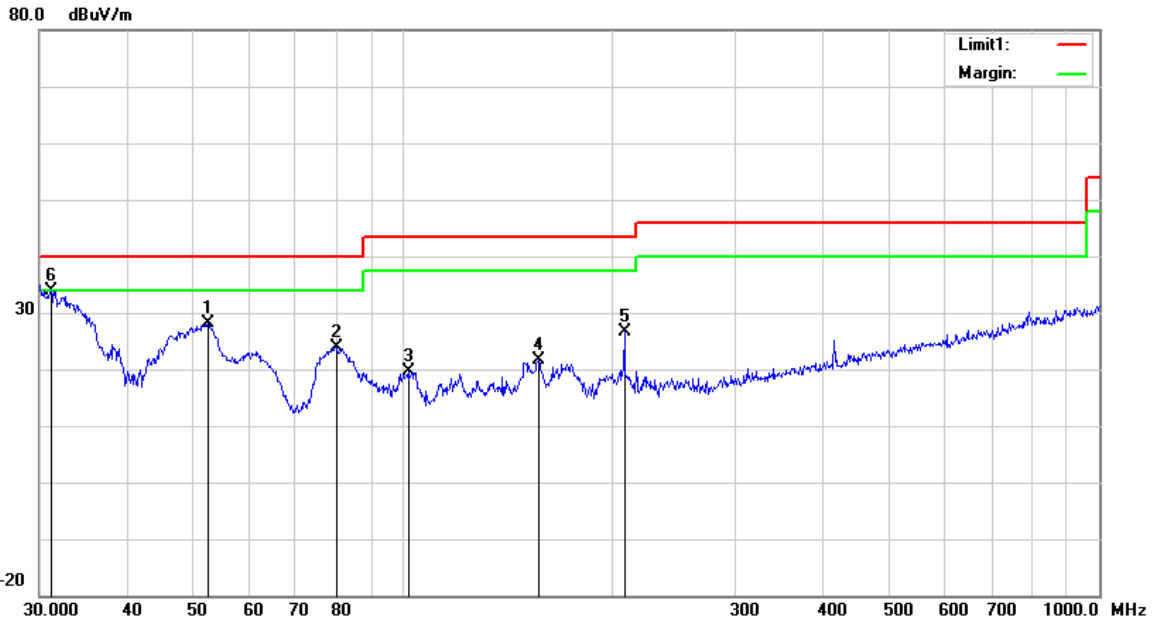

Test Data

Vertical Polarity Plot @3m

No.	P/L	Frequency (MHz)	Reading (dBuV/m)	Detect or	Ant_F (dB/m)	PA_G (dB)	Cab_L (dB)	Result (dBuV/m)	Limit (dBuV/m)	Margin (dB)	Height (cm)	Degr ee ()
1	V	52.3913	41.56	peak	8.14	22.39	0.79	28.10	40.00	-11.90	100	83
2	V	80.0806	37.68	peak	7.60	22.42	1.05	23.91	40.00	-16.09	100	252
3	V	102.0014	29.95	peak	10.75	22.32	1.13	19.51	43.50	-23.99	100	78
4	V	156.4578	29.85	peak	12.60	22.29	1.37	21.53	43.50	-21.97	100	118
5	V	207.8501	35.53	peak	11.99	22.37	1.57	26.72	43.50	-16.78	100	324
6	V	31.1798	35.10	peak	20.49	22.27	0.65	33.97	40.00	-6.03	100	211

Above 1GHz

Test Mode:	Transmitting Mode
-------------------	--------------------------

Low Channel: GFSK Mode (Worst Case) (2402 MHz)

Frequency (MHz)	S.A. Reading (dBµV)	Detector (PK/AV)	Polarity (H/V)	Ant. Factor (dB/m)	Cable Loss (dB)	Pre-Amp. Gain (dB)	Cord. Amp. (dBµV/m)	Limit (dBµV/m)	Margin (dB)
4804	49.7	AV	V	33.39	7.22	48.46	41.85	54	-12.15
4804	42.31	AV	H	33.39	7.22	48.46	34.46	54	-19.54
4804	70.73	PK	V	33.39	7.22	48.46	62.88	74	-11.12
4804	64.8	PK	H	33.39	7.22	48.46	56.95	74	-17.05
9400	33.25	AV	V	39.35	9.22	49.07	32.75	54	-21.25
9400	25.64	AV	H	39.35	9.22	49.07	25.14	54	-28.86
9400	52.45	PK	V	39.35	9.22	49.07	51.95	74	-22.05
9400	51.84	PK	H	39.35	9.22	49.07	51.34	74	-22.66

Middle Channel: GFSK Mode (Worst Case) (2441 MHz)

Frequency (MHz)	S.A. Reading (dBµV)	Detector (PK/AV)	Polarity (H/V)	Ant. Factor (dB/m)	Cable Loss (dB)	Pre-Amp. Gain (dB)	Cord. Amp. (dBµV/m)	Limit (dBµV/m)	Margin (dB)
4882	49.73	AV	V	33.62	7.53	48.36	42.52	54	-11.48
4882	43.12	AV	H	33.62	7.53	48.36	35.91	54	-18.09
4882	68.45	PK	V	33.62	7.53	48.36	61.24	74	-12.76
4882	67.32	PK	H	33.62	7.53	48.36	60.11	74	-13.89
7686	32.25	AV	V	37.08	8.58	48.13	29.78	54	-24.22
7686	33.65	AV	H	37.08	8.58	48.13	31.18	54	-22.82
7686	56.65	PK	V	37.08	8.58	48.13	54.18	74	-19.82
7686	55.32	PK	H	37.08	8.58	48.13	52.85	74	-21.15

High Channel: GFSK Mode (Worst Case) (2480 MHz)

Frequency (MHz)	S.A. Reading (dB μ V)	Detector (PK/AV)	Polarity (H/V)	Ant. Factor (dB/m)	Cable Loss (dB)	Pre-Amp. Gain (dB)	Cord. Amp. (dB μ V/m)	Limit (dB μ V/m)	Margin (dB)
4960	42.47	AV	V	33.89	7.86	48.31	35.91	54	-18.09
4960	42.95	AV	H	33.89	7.86	48.31	36.39	54	-17.61
4960	66.12	PK	V	33.89	7.86	48.31	59.56	74	-14.44
4960	64.18	PK	H	33.89	7.86	48.31	57.62	74	-16.38
17877	19.09	AV	V	42.93	19.53	45.03	36.52	54	-17.48
17877	18.36	AV	H	42.93	19.53	45.03	35.79	54	-18.21
17877	39.4	PK	V	42.93	19.53	45.03	56.83	74	-17.17
17877	40.57	PK	H	42.93	19.53	45.03	58	74	-16

Note:

1, The testing has been conformed to $10 \times 2480 \text{ MHz} = 24,800 \text{ MHz}$

2, All other emissions more than 30 dB below the limit

3, X-Axis, Y-Axis and Z-Axis were investigated. The results above show only the worst case.

4, The radiated spurious test above 18GHz is subcontracted to SIEMIC (Nanjing-China) Laboratories. and found 30dB below the limit at least.

Annex A. TEST INSTRUMENT

Instrument	Model	Serial #	Cal Date	Cal Due	In use
AC Line Conducted					
EMI test receiver	ESCS30	8471241027	09/15/2017	09/14/2018	<input checked="" type="checkbox"/>
Line Impedance	LI-125A	191106	09/23/2017	09/22/2018	<input checked="" type="checkbox"/>
Line Impedance	LI-125A	191107	09/23/2017	09/22/2018	<input checked="" type="checkbox"/>
ISN	ISN T800	34373	09/23/2017	09/22/2018	<input type="checkbox"/>
Transient Limiter	LIT-153	531118	08/30/2017	08/29/2018	<input type="checkbox"/>
RF conducted test					
Agilent ESA-E SERIES	E4407B	MY45108319	09/15/2017	09/14/2018	<input checked="" type="checkbox"/>
Power Splitter	1#	1#	08/30/2017	08/29/2018	<input checked="" type="checkbox"/>
DC Power Supply	E3640A	MY40004013	09/15/2017	09/14/2018	<input checked="" type="checkbox"/>
Radiated Emissions					
EMI test receiver	ESL6	100262	09/15/2017	09/14/2018	<input checked="" type="checkbox"/>
Positioning Controller	UC3000	MF780208282	11/17/2017	11/16/2018	<input checked="" type="checkbox"/>
OPT 010 AMPLIFIER (0.1-1300MHz)	8447E	2727A02430	08/30/2017	08/29/2018	<input checked="" type="checkbox"/>
Microwave Preamplifier (1 ~ 26.5GHz)	8449B	3008A02402	03/23/2017	03/22/2018	<input checked="" type="checkbox"/>
Horn Antenna	BBHA9170	3145226D1	09/27/2017	09/26/2018	<input checked="" type="checkbox"/>
Active Antenna (9kHz-30MHz)	AL-130	121031	10/12/2017	10/11/2018	<input checked="" type="checkbox"/>
Bilog Antenna (30MHz~6GHz)	JB6	A110712	09/19/2017	09/18/2018	<input checked="" type="checkbox"/>
Double Ridge Horn Antenna (1 ~18GHz)	AH-118	71283	09/22/2017	09/21/2018	<input checked="" type="checkbox"/>
Universal Radio Communication Tester	CMU200	121393	09/23/2017	09/22/2018	<input checked="" type="checkbox"/>

Annex B. EUT And Test Setup Photographs

Annex B.i. Photograph: EUT External Photo

Whole Package View



Adapter - Label View

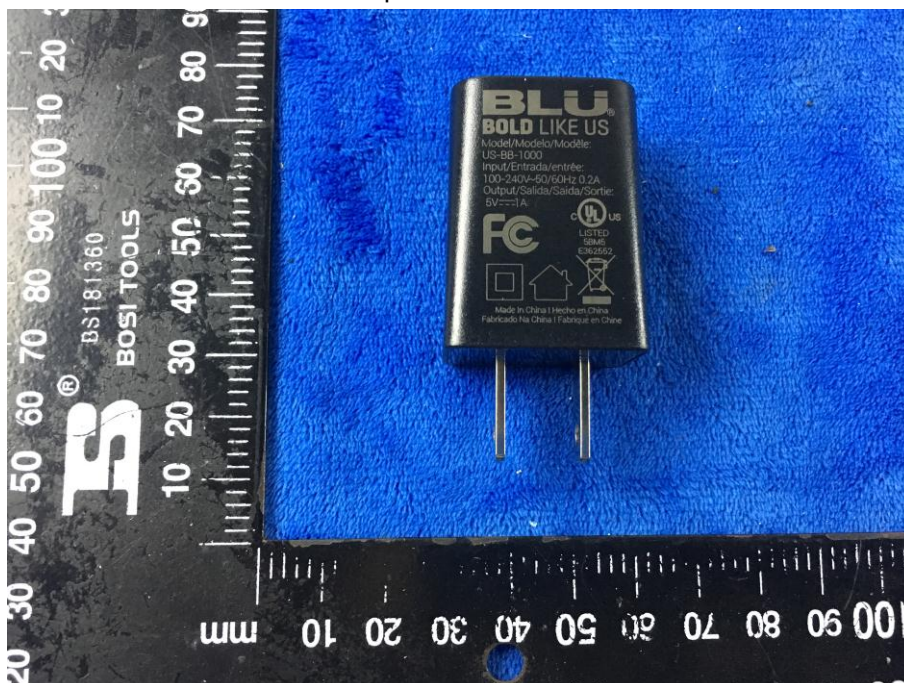

EUT - Front View



EUT - Rear View



EUT - Top View

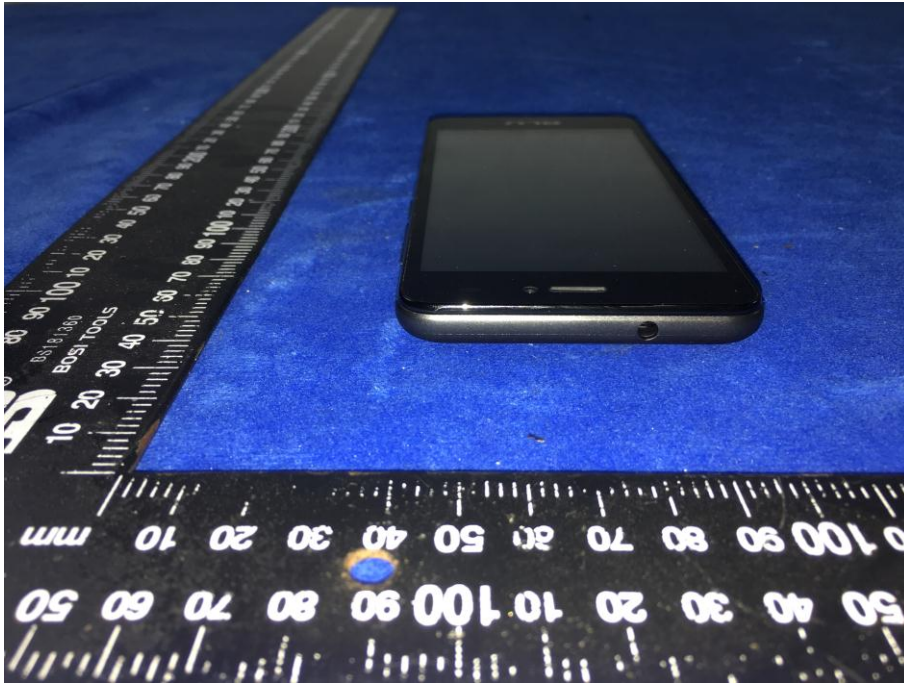

EUT - Bottom View

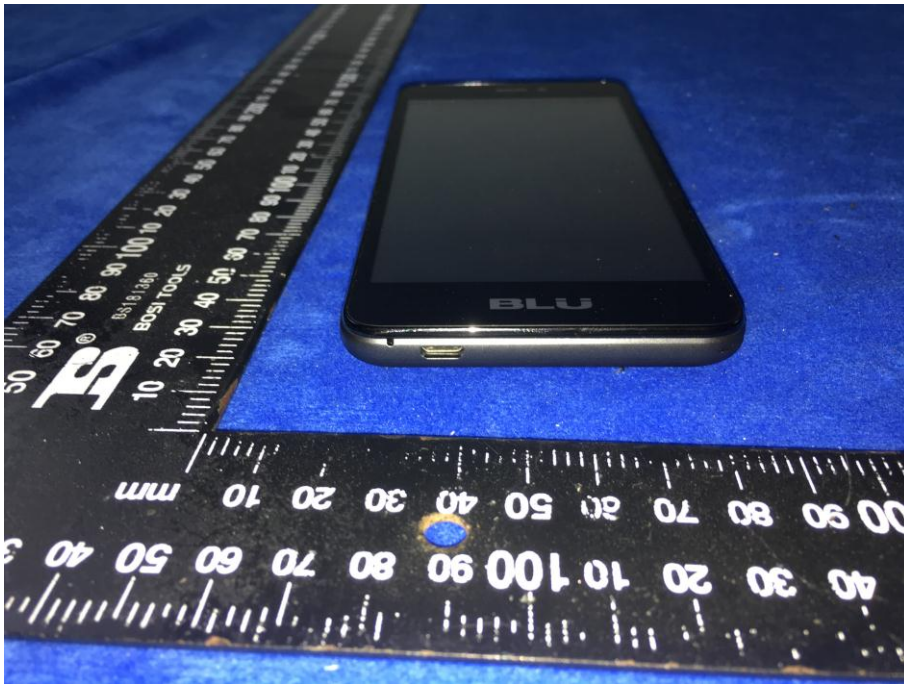

EUT - Left View

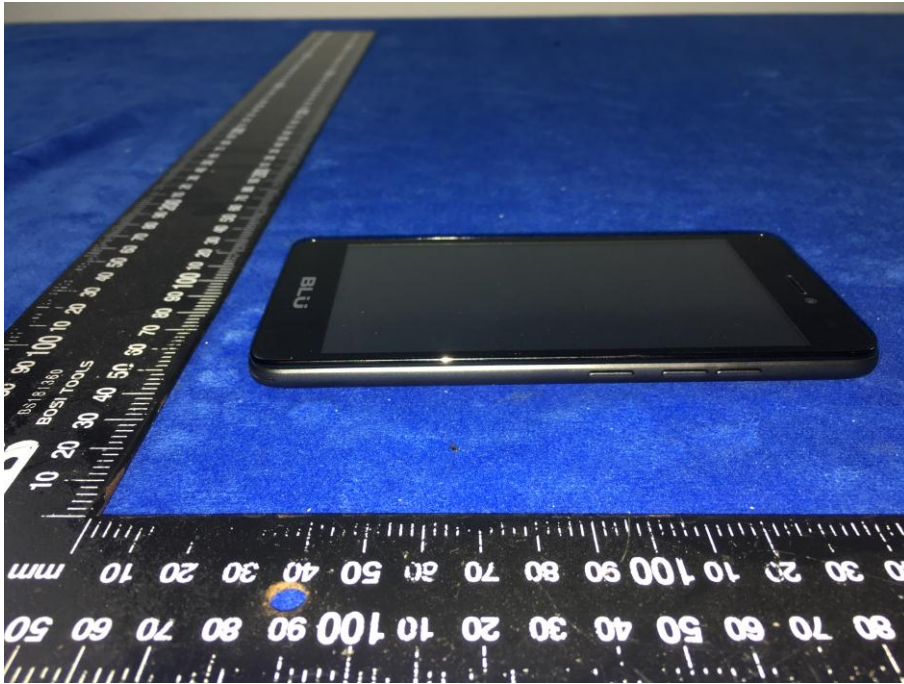

EUT - Right View

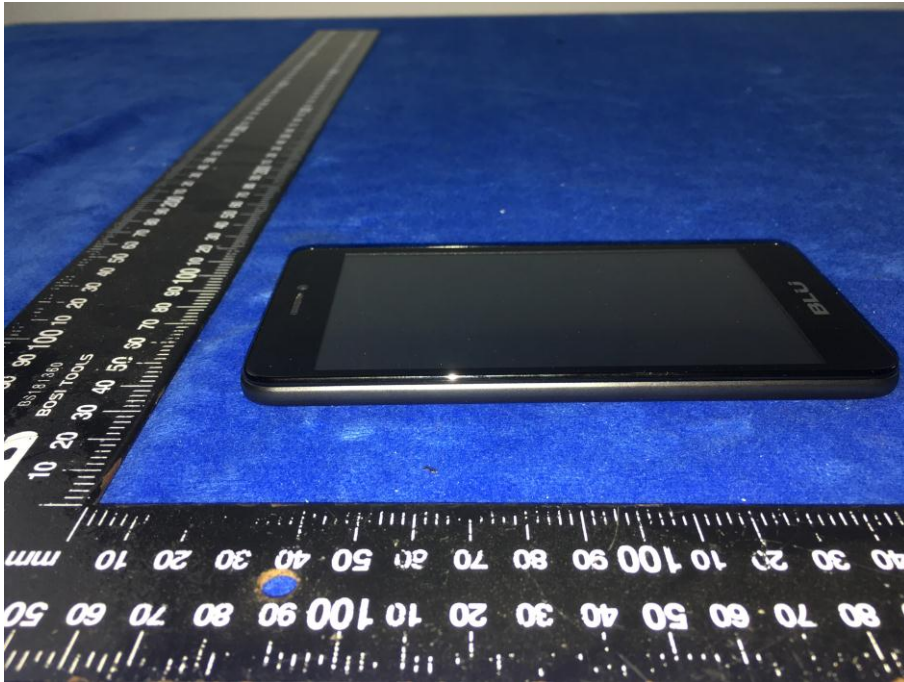

Annex B.ii. Photograph: EUT Internal Photo

Cover Off - Top View 1



Cover Off - Top View 2



Battery - Front View

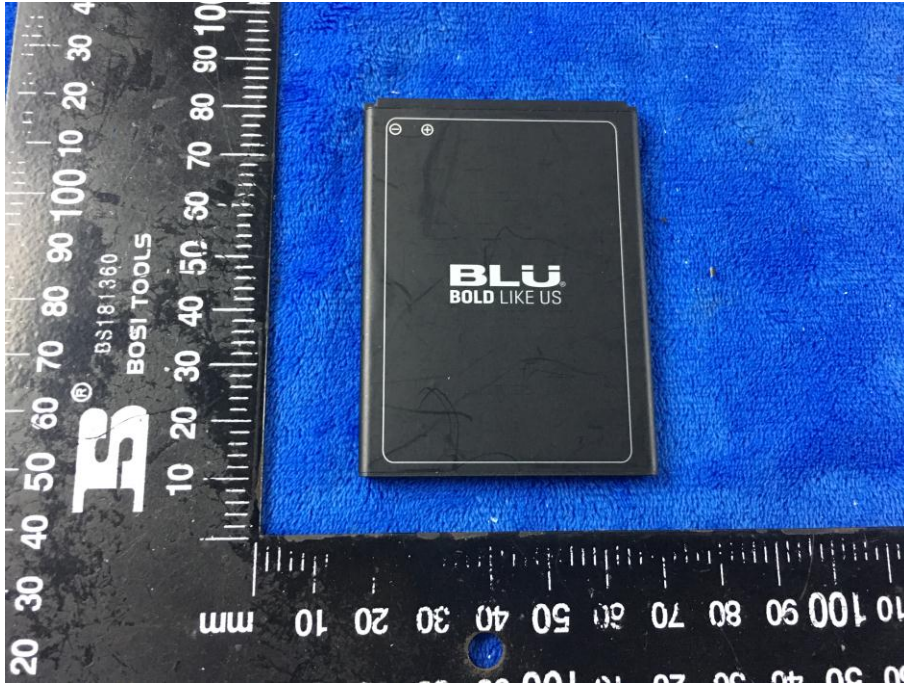

Battery - Rear View



Mainboard with Shielding - Front View

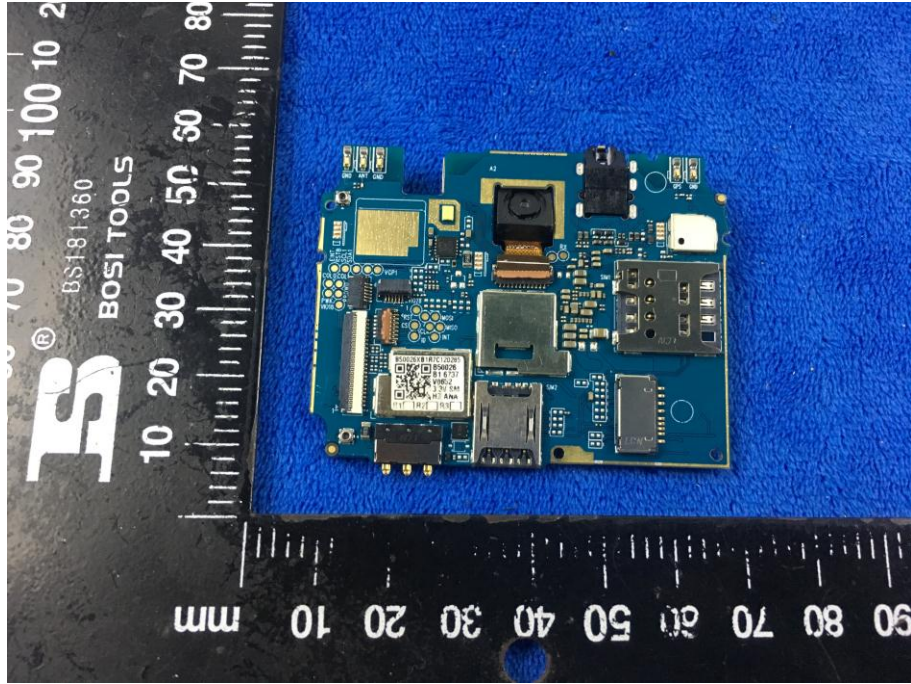

Mainboard without Shielding - Front View

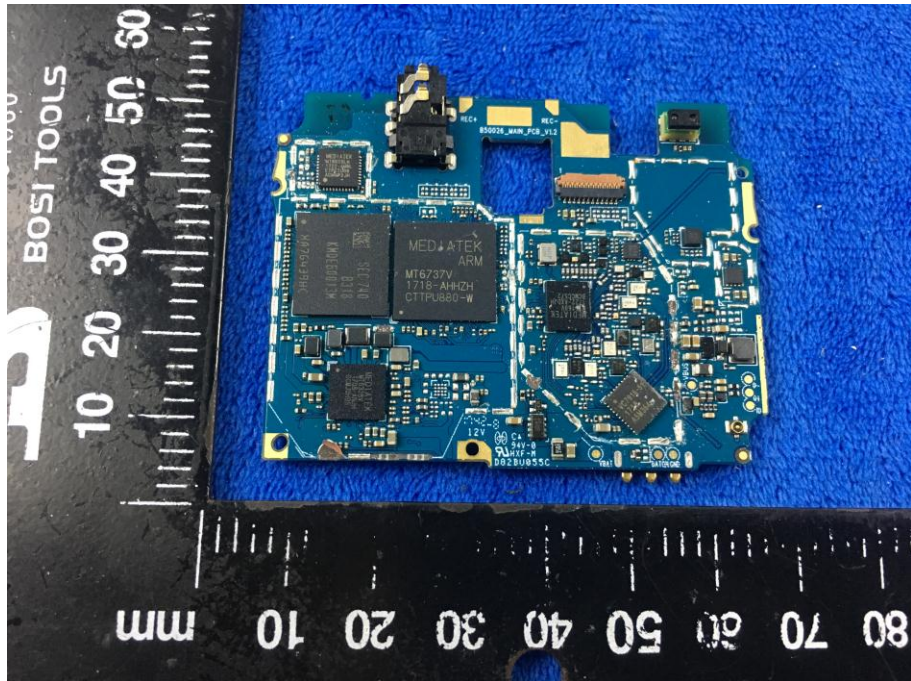

Mainboard without Shielding – Rear View

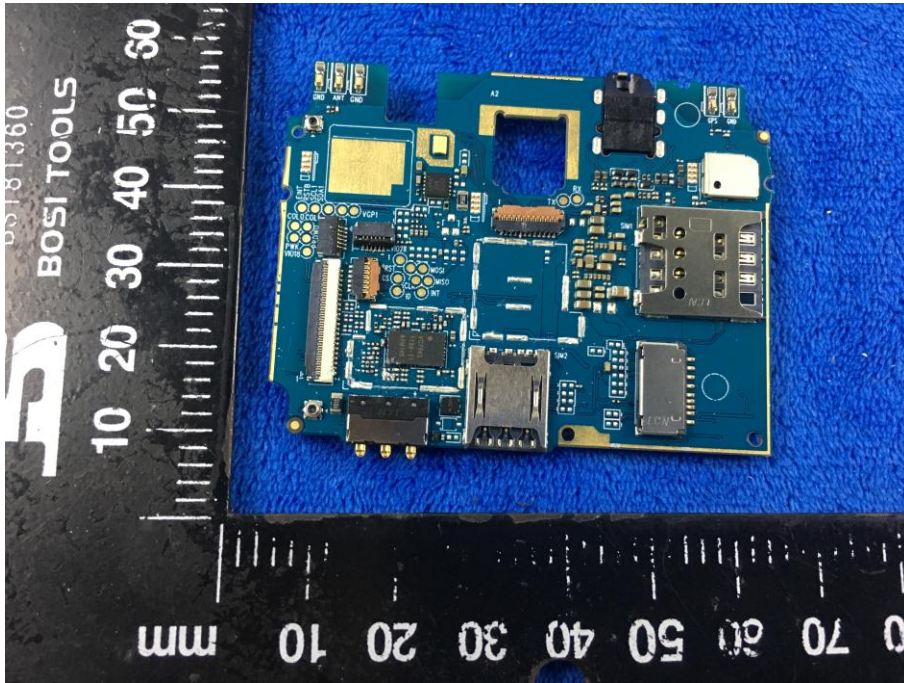

Smallboard – Front View

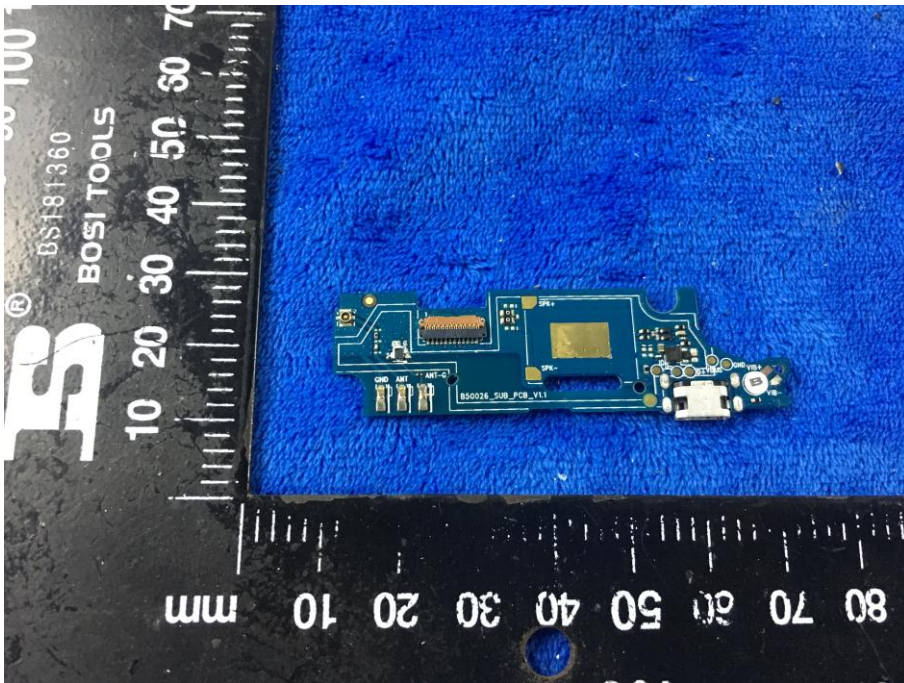

Smallboard – Rear View

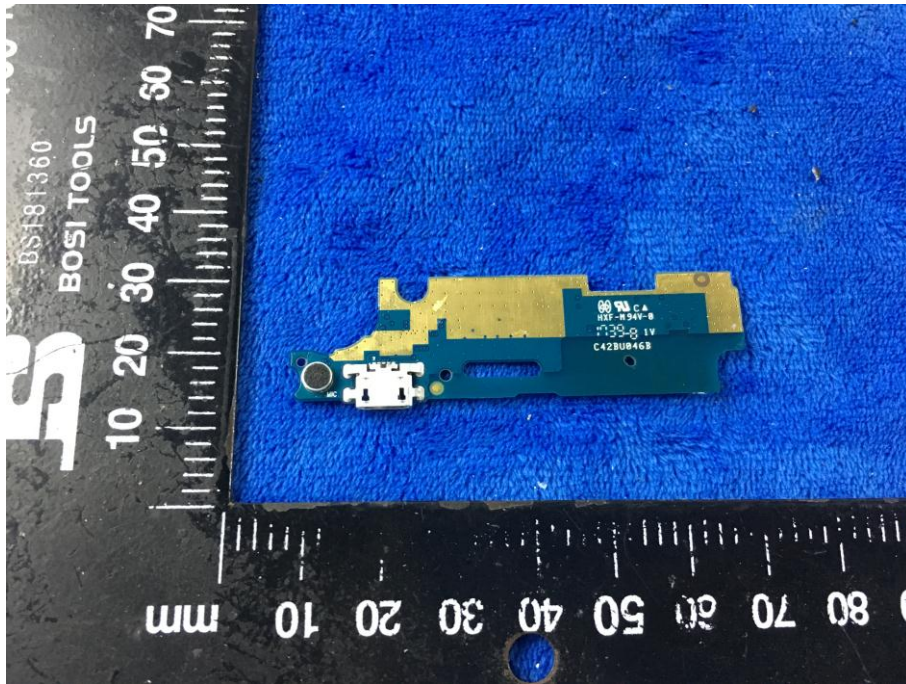

LCD – Front View



LCD – Rear View



GSM/PCS/UMTS-FDD/LTE Antenna View



WIFI/BT/BLE/GPS - Antenna View



RXD- Antenna View



Annex B.iii. Photograph: Test Setup Photo

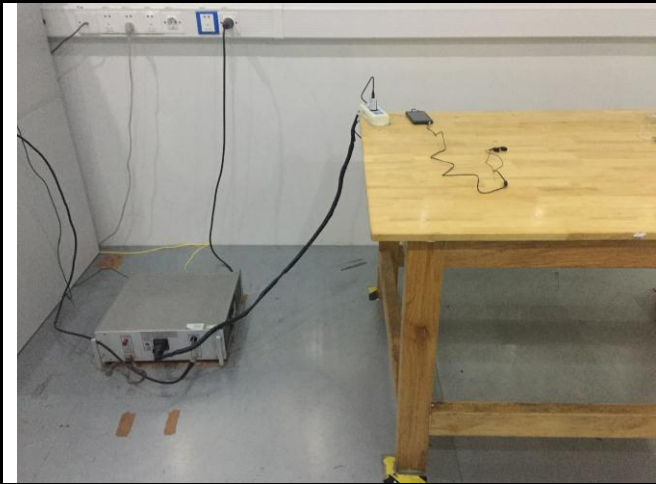

Conducted Emissions Test Setup Front View



Conducted Emissions Test Setup Side View

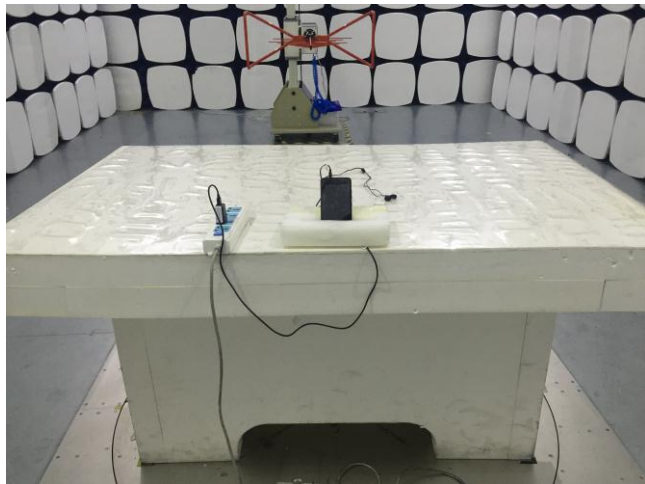

Radiated Spurious Emissions Test Setup Below 1GHz



Radiated Spurious Emissions Test Setup Above
1GHz

Annex C. TEST SETUP AND SUPPORTING EQUIPMENT

Annex C.ii. TEST SET UP BLOCK

Block Configuration Diagram for AC Line Conducted Emissions

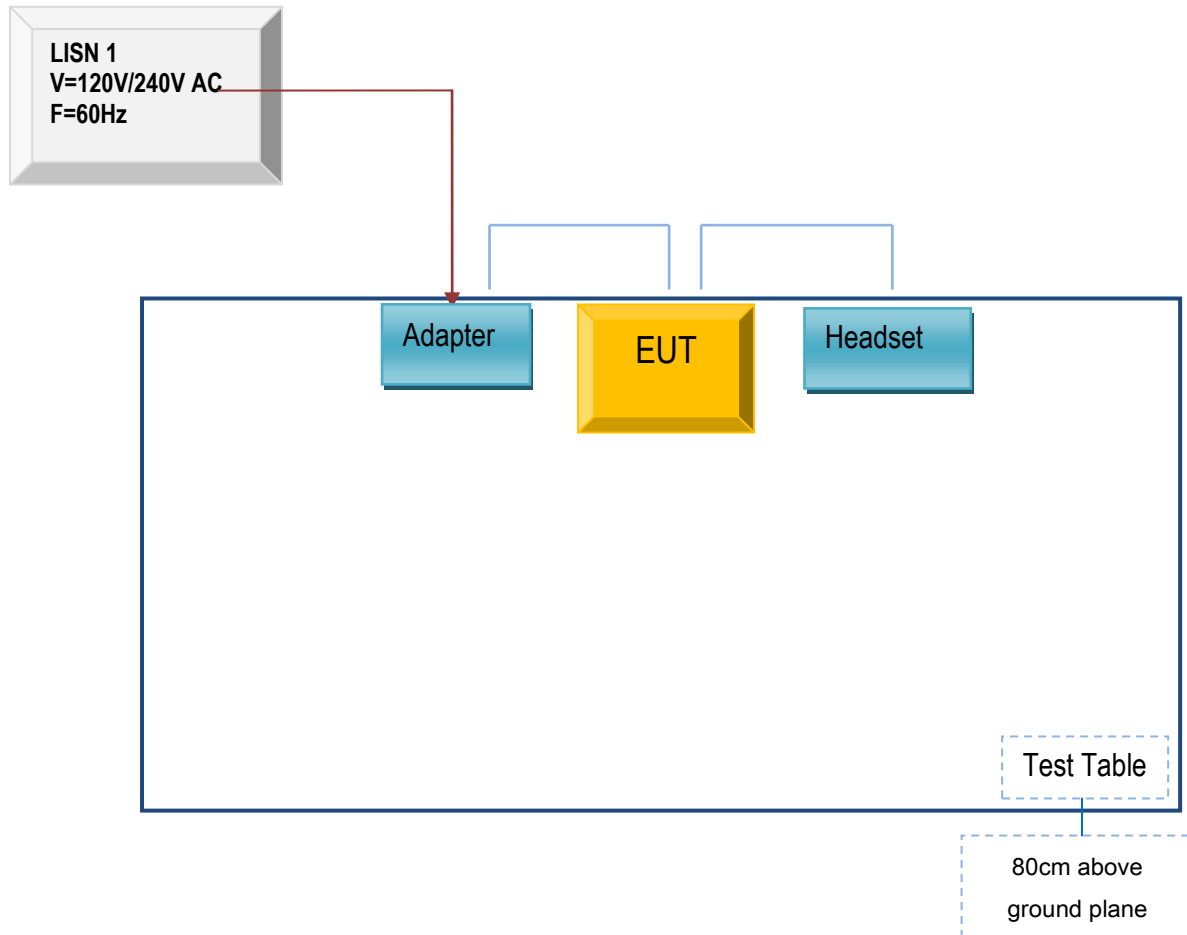

Block Configuration Diagram for Radiated Emissions (Below 1GHz) .

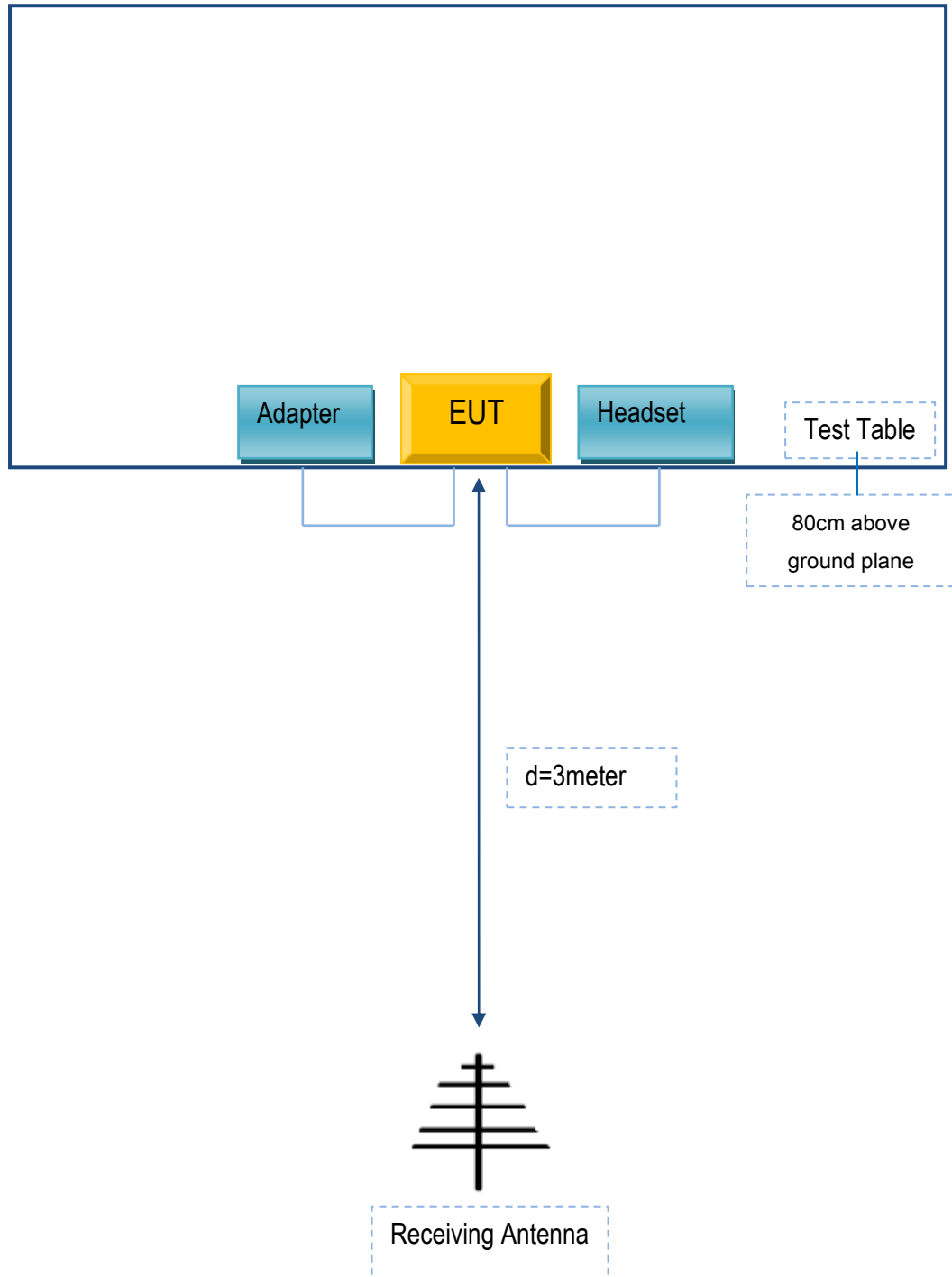

Block Configuration Diagram for Radiated Emissions (Above 1GHz) .

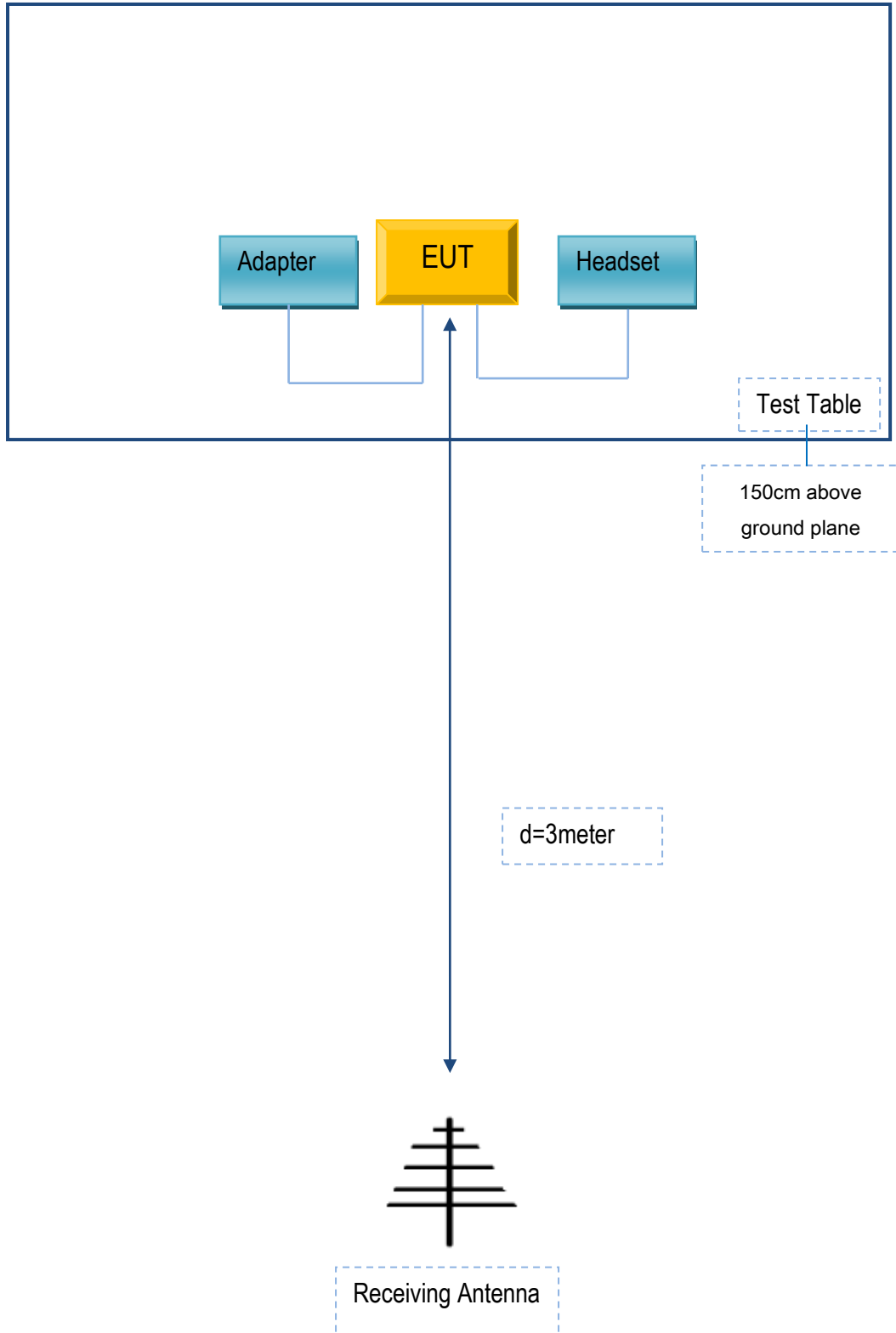

Annex C. ii. SUPPORTING EQUIPMENT DESCRIPTION

The following is a description of supporting equipment and details of cables used with the EUT.

Supporting Equipment:

Manufacturer	Equipment Description	Model	Serial No
BLU Products, Inc.	Adapter	US-BB-1000	N/A
SAMSUNG	headset	HS330	N/A

Supporting Cable:

Cable type	Shield Type	Ferrite Core	Length	Serial No
USB Cable	Un-shielding	No	0.8m	N/A

Test Report	17071300-FCC-R3
Page	67 of 68

Annex D. User Manual / Block Diagram / Schematics / Partlist

Please see the attachment

Test Report	17071300-FCC-R3
Page	68 of 68

Annex E. DECLARATION OF SIMILARITY

N/A