

RMC

UMTS-FDD Band V (Part 22H)

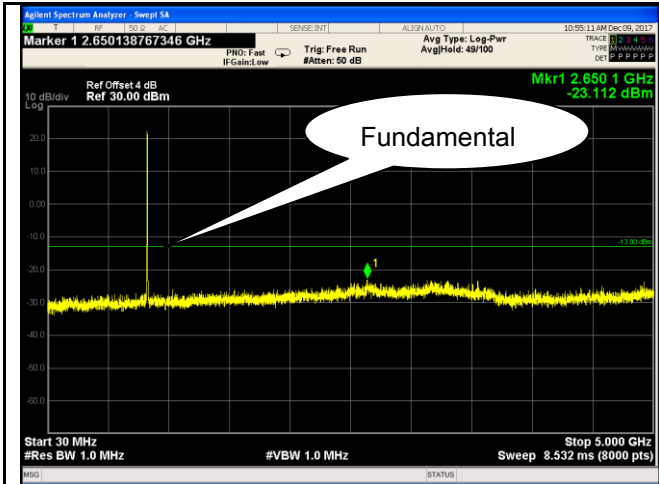

Band V - Low Channel-1

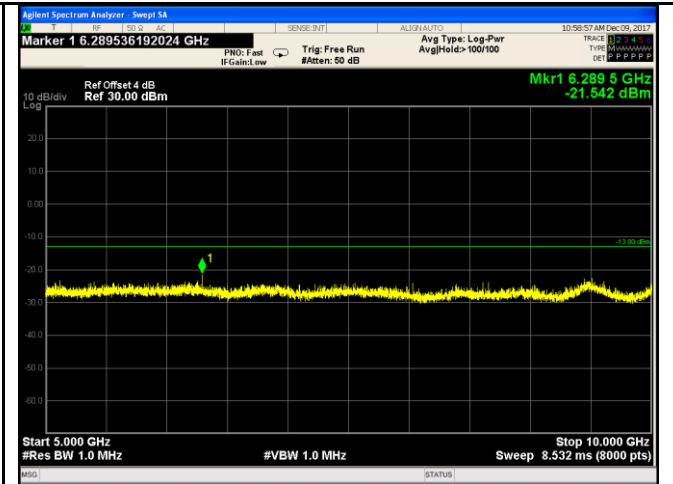

Band V - Low Channel-2

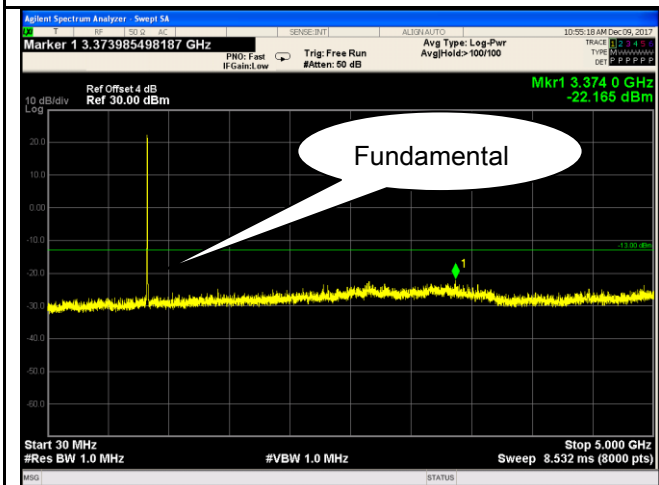

Band V - Middle Channel-1

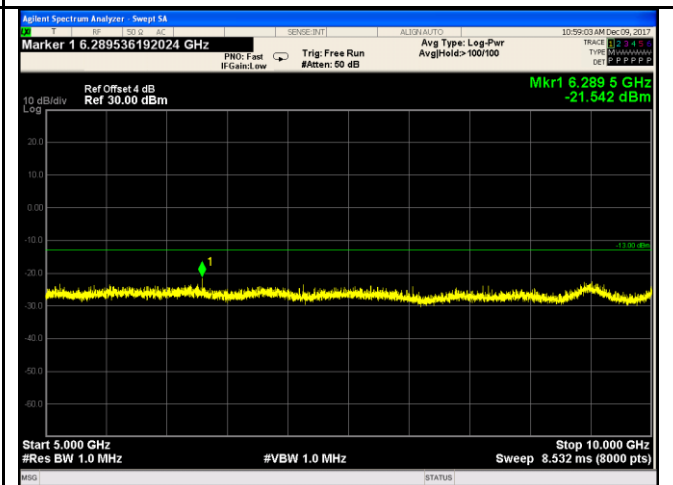

Band V - Middle Channel-2

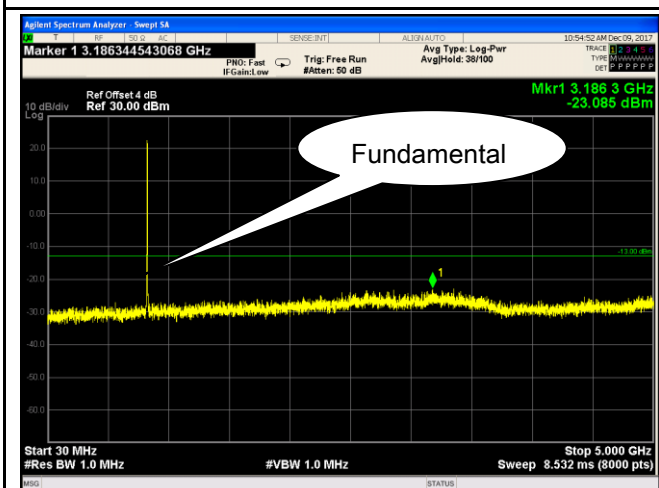

Band V - High Channel-1

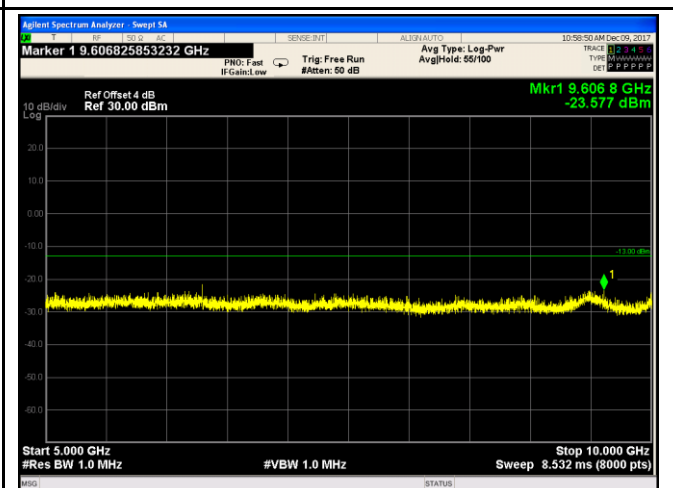

Band V - High Channel-2

UMTS-FDD Band II (Part 24E)

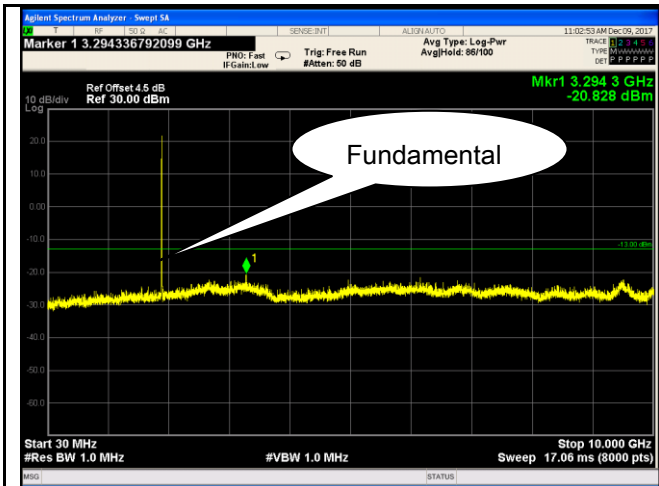

Band II - Low Channel-1

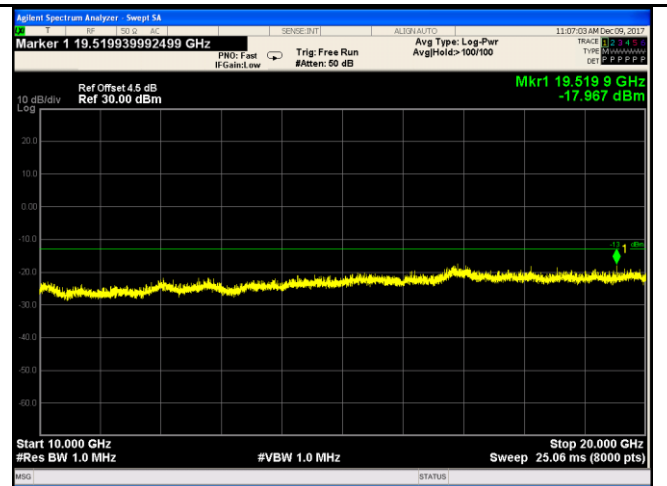

Band II - Low Channel-2

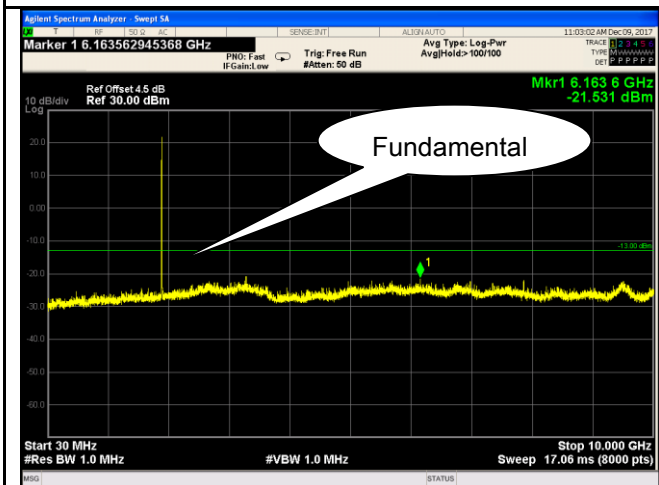

Band II - Middle Channel-1

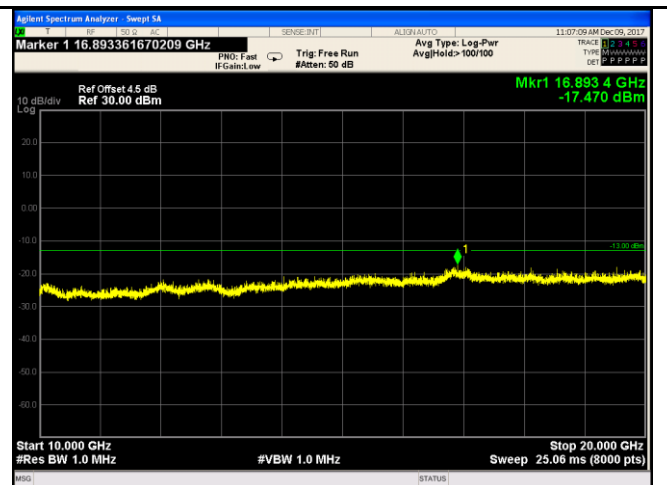

Band II - Middle Channel-2

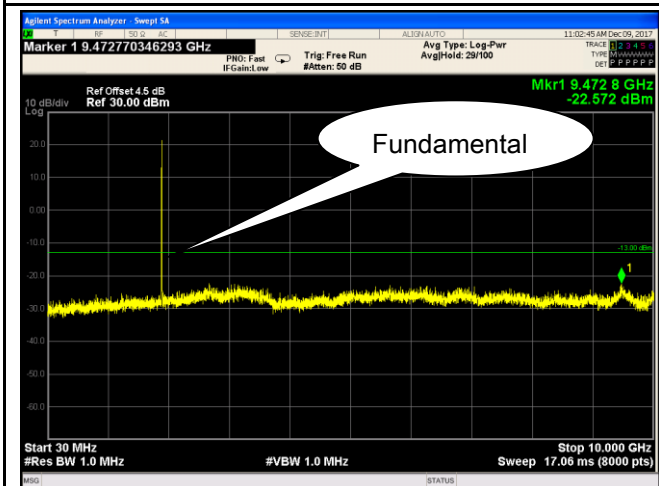

Band II - High Channel-1

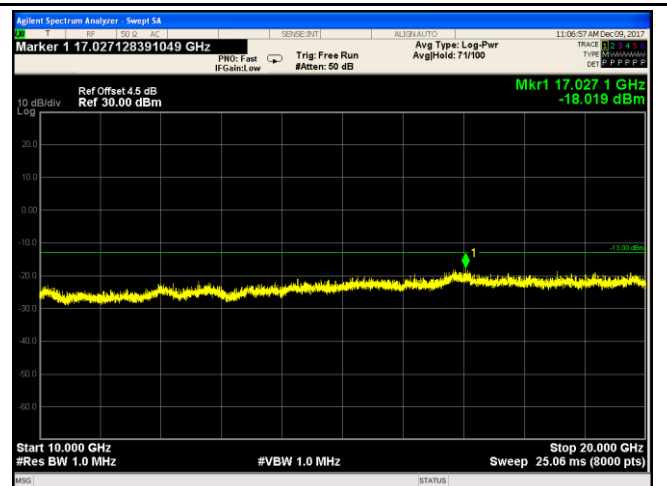

Band II - High Channel-2

UMTS-FDD Band IV (Part 27)

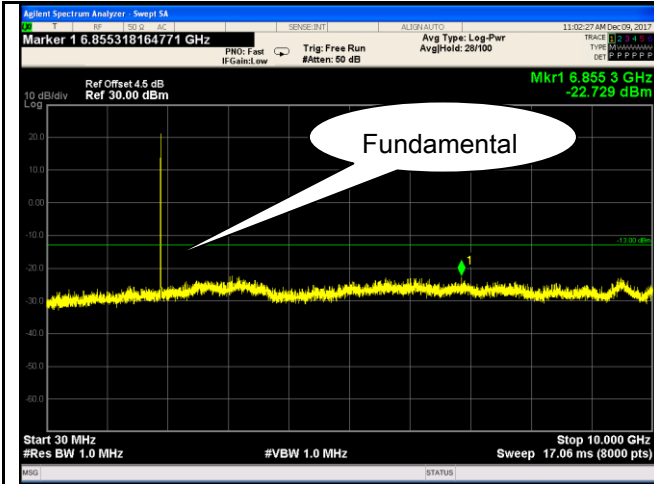

Band IV - Low Channel-1

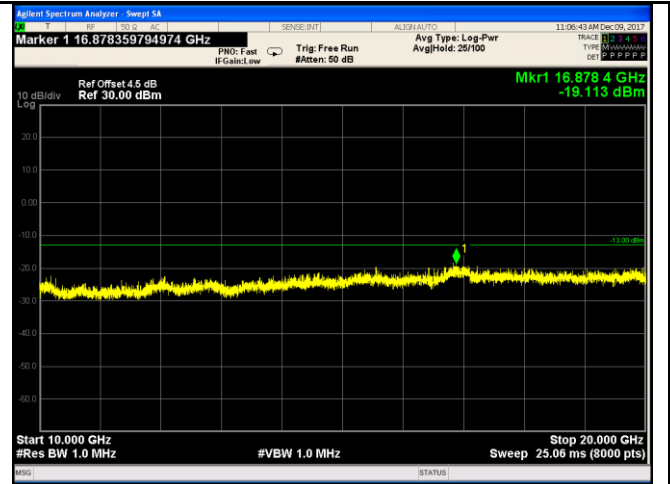

Band IV - Low Channel-2

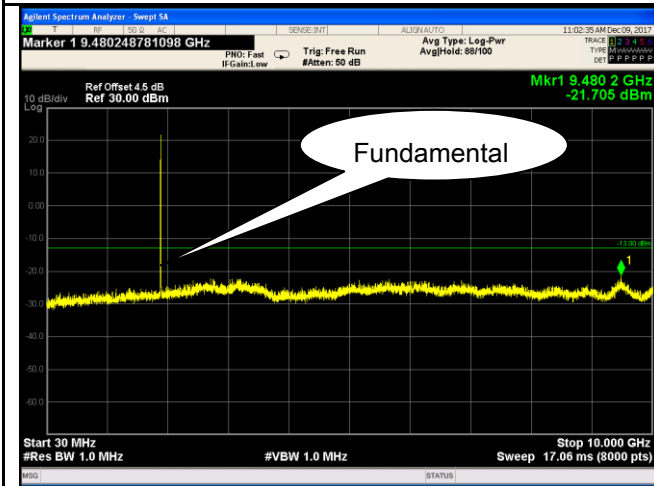

Band IV - Middle Channel-1

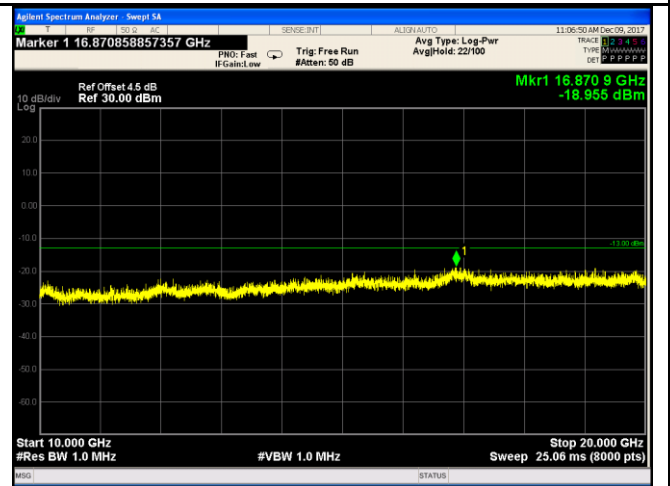

Band IV - Middle Channel-2

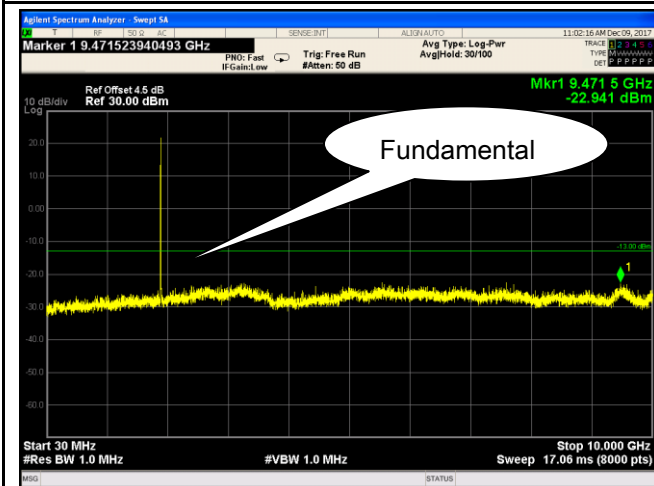

Band IV - High Channel-1

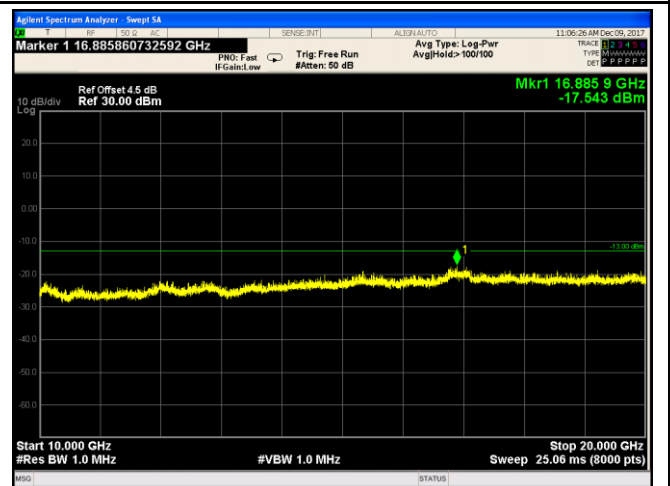

Band IV - High Channel-2

**HSUPA:
UMTS-FDD Band V (Part 22H)**

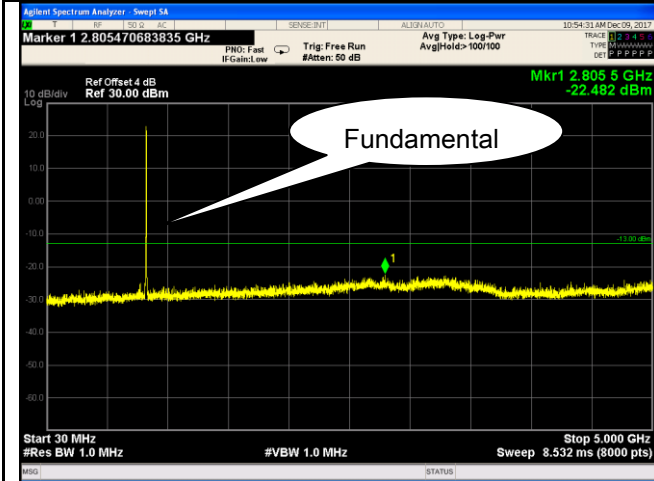

Band V - Low Channel-1

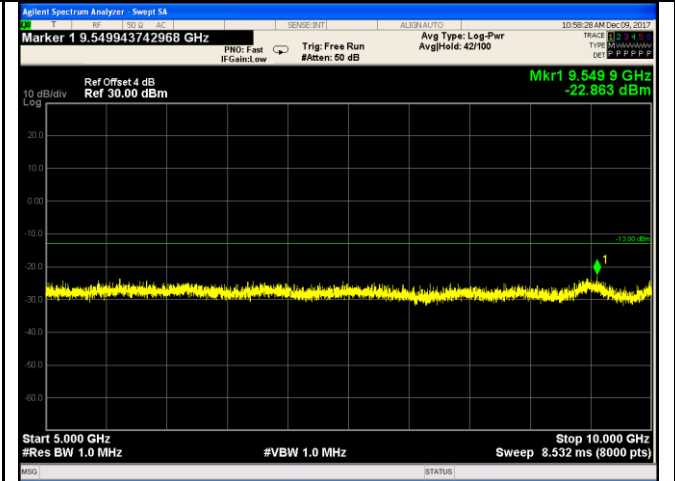

Band V - Low Channel-2

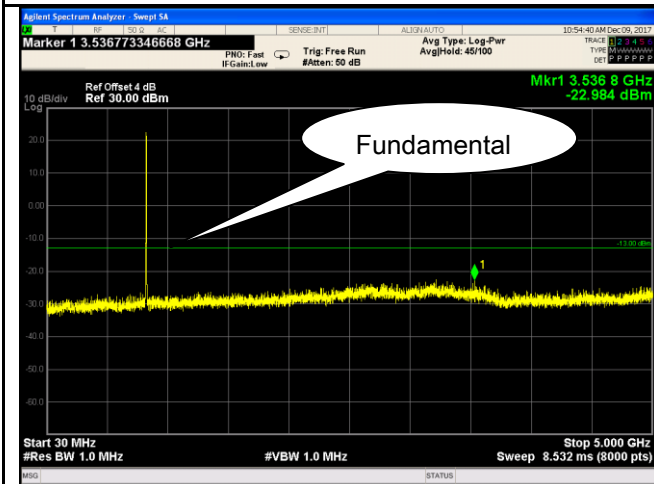

Band V - Middle Channel-1

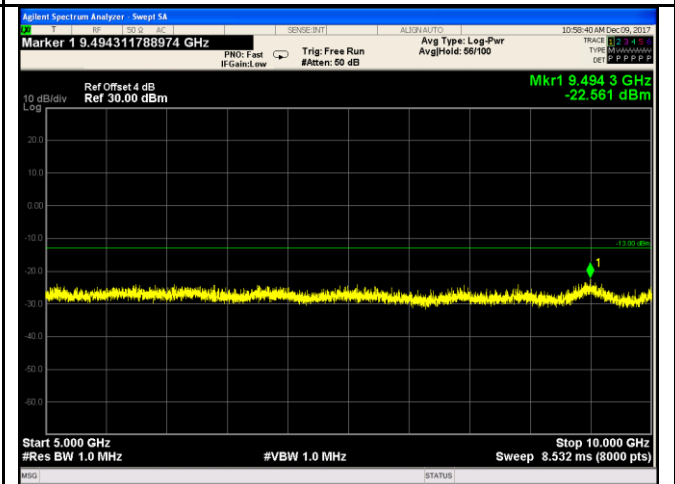

Band V - Middle Channel-2

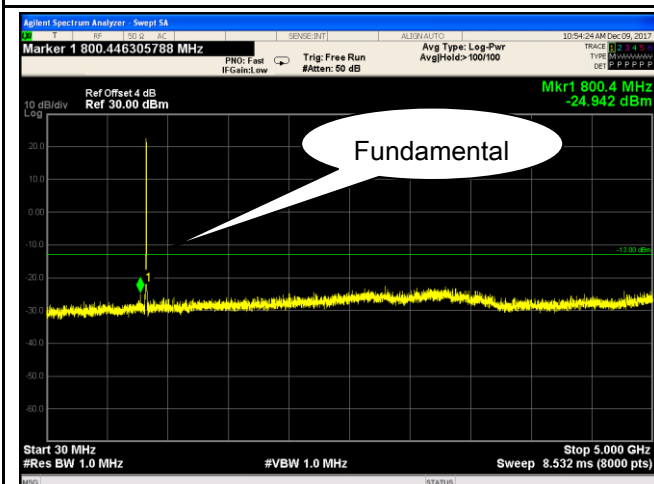

Band V - High Channel-1

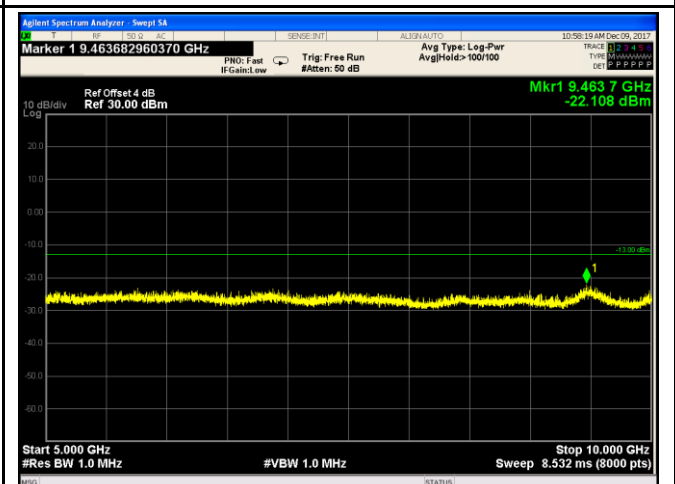

Band V - High Channel-2

UMTS-FDD Band II (Part 24E)

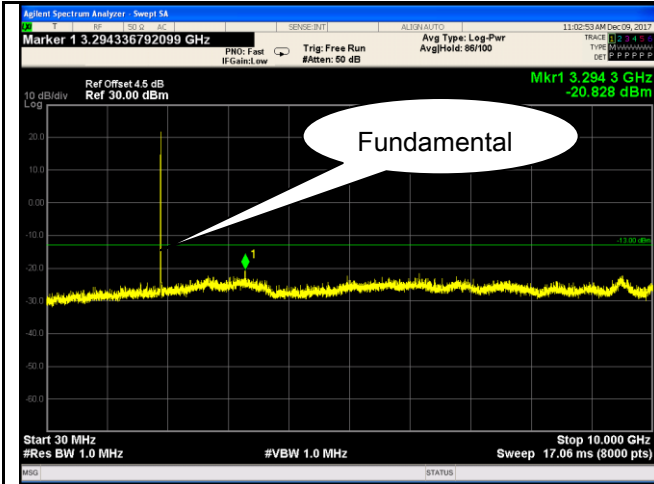

Band II - Low Channel-1

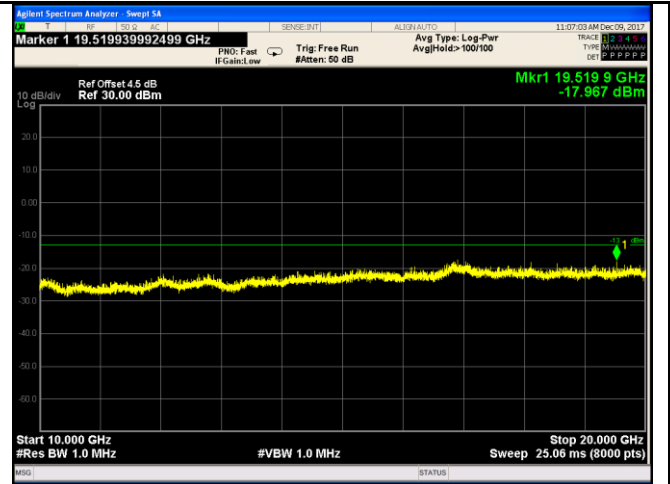

Band II - Low Channel-2

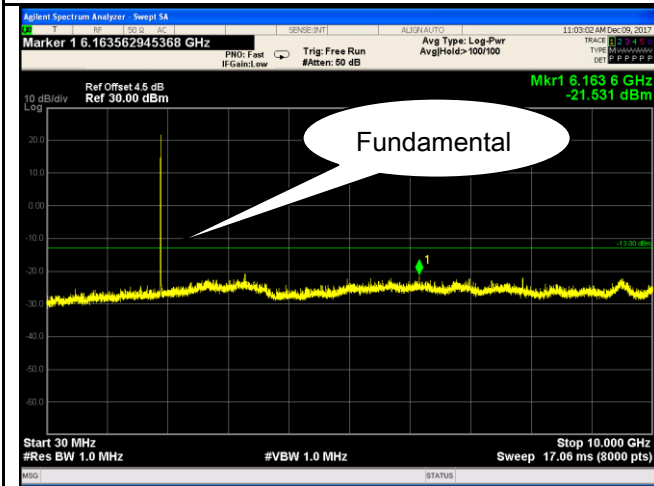

Band II - Middle Channel-1

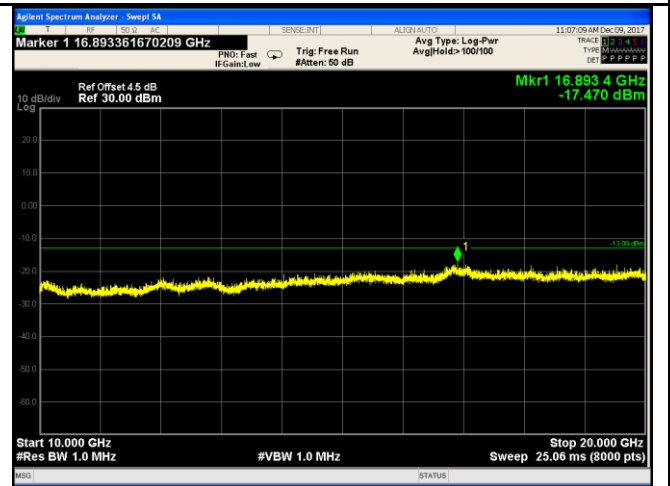

Band II - Middle Channel-2

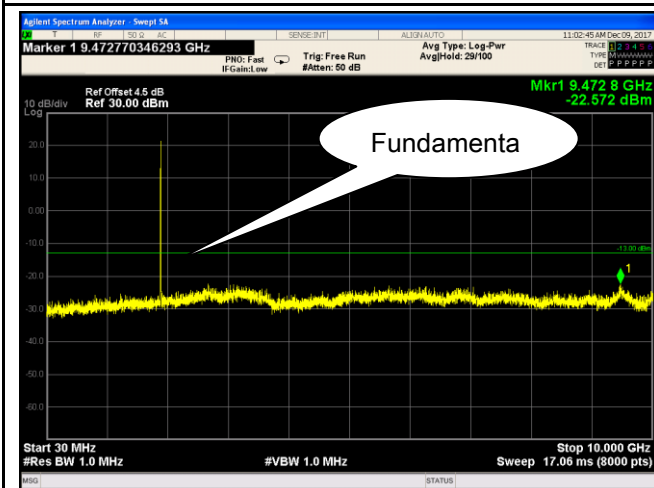

Band II - High Channel-1

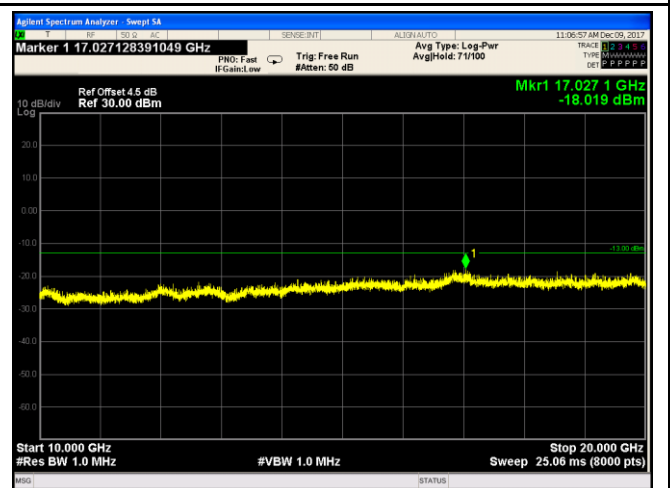

Band II - High Channel-2

UMTS-FDD Band IV (Part 27)

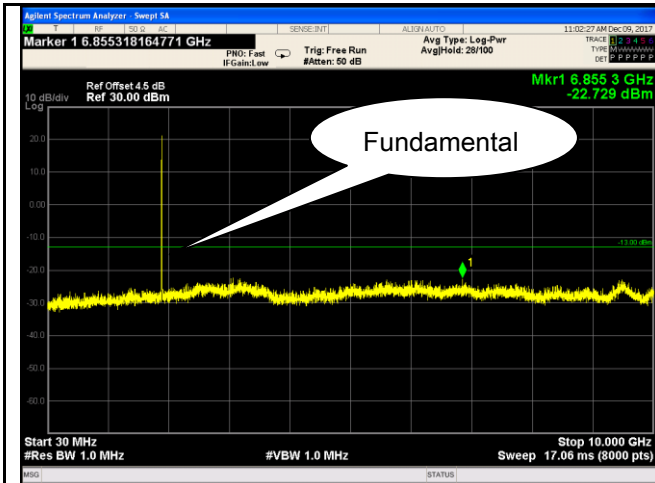

Band IV - Low Channel-1

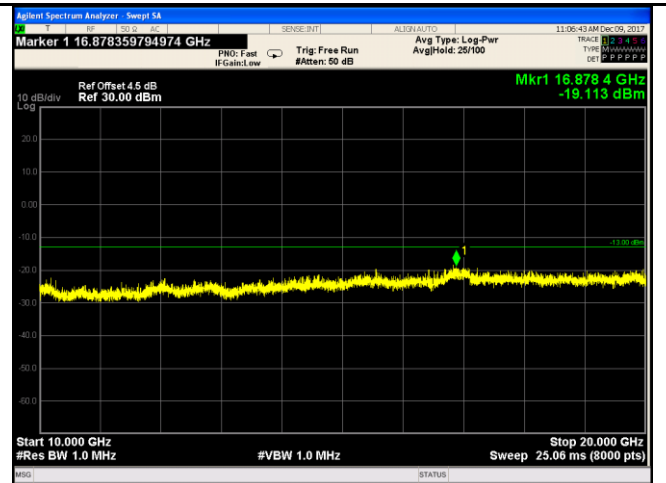

Band IV - Low Channel-2

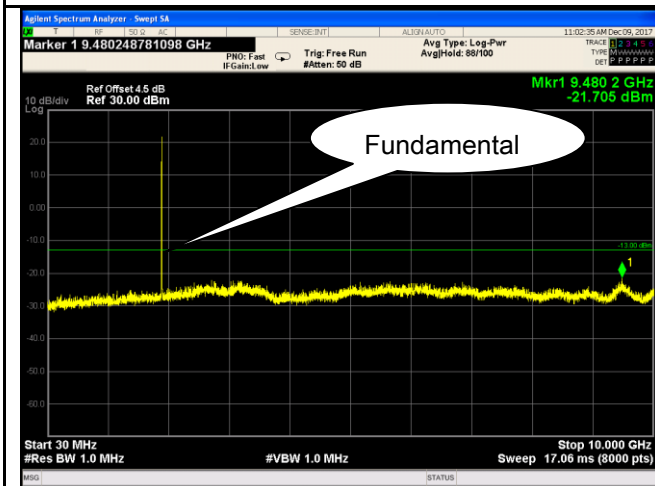

Band IV - Middle Channel-1

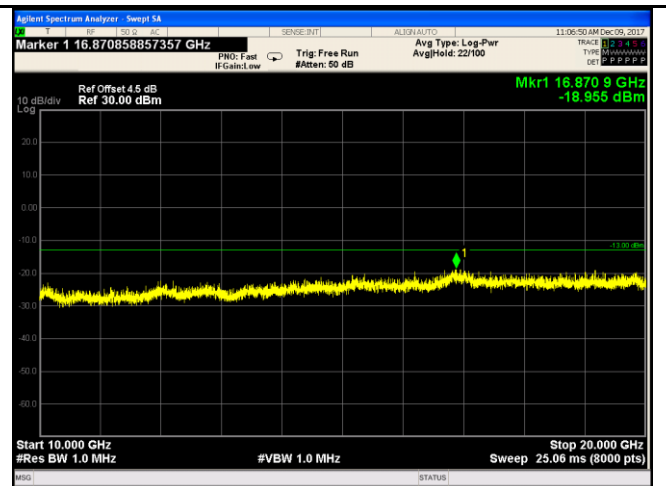

Band IV - Middle Channel-2

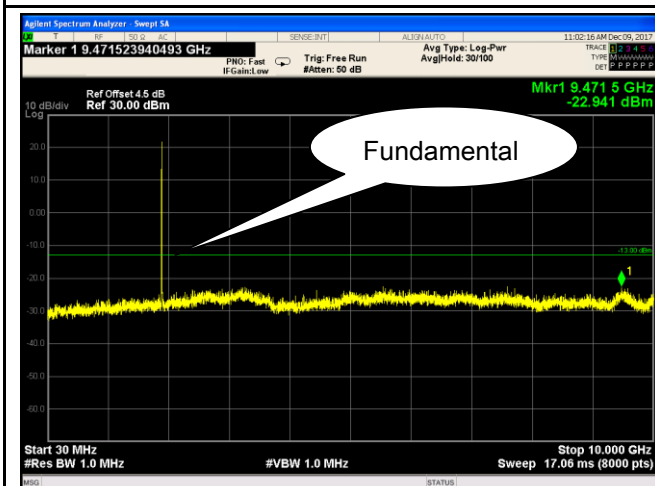

Band IV - High Channel-1

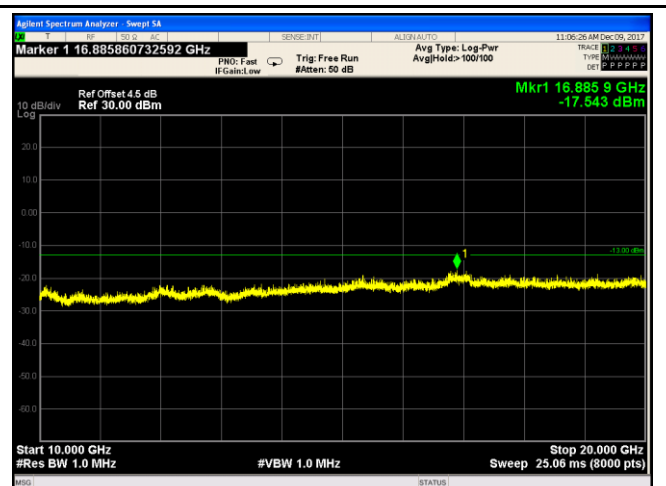

Band IV - High Channel-2

HSDPA:
UMTS-FDD Band V (Part 22H)

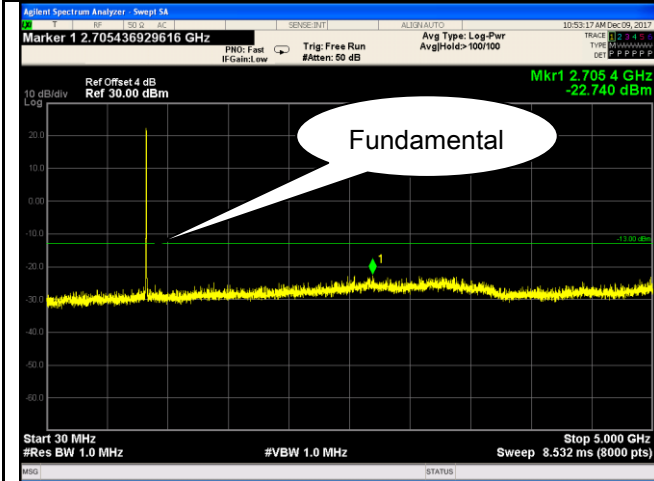

Band V - Low Channel-1

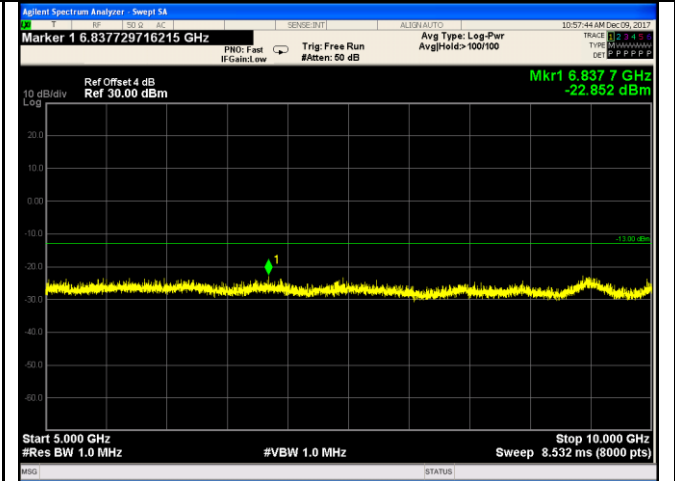

Band V - Low Channel-2

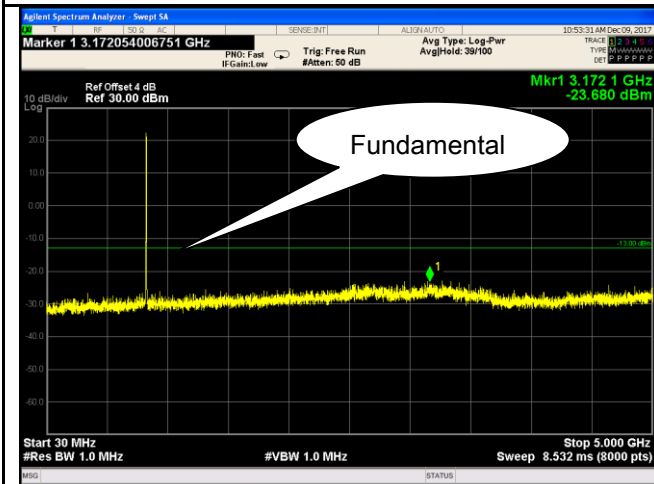

Band V - Middle Channel-1

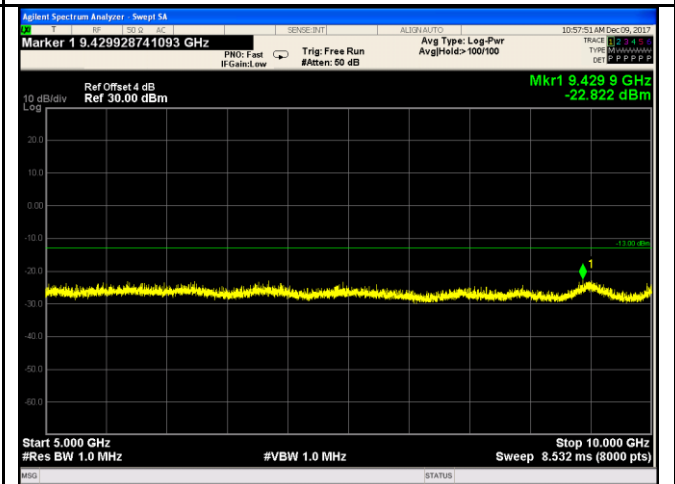

Band V - Middle Channel-2

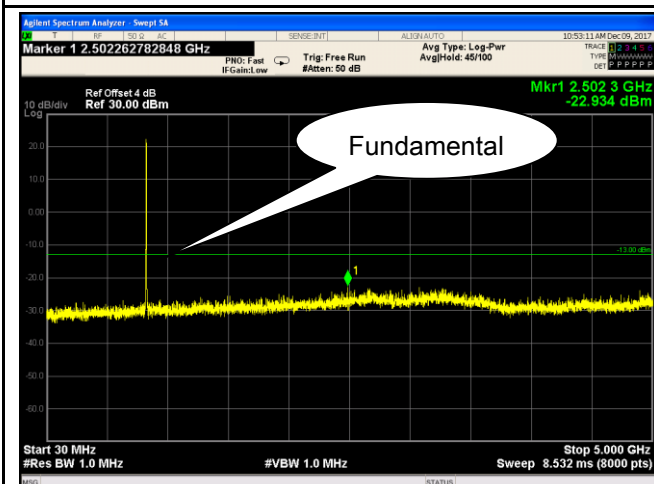

Band V - High Channel-1

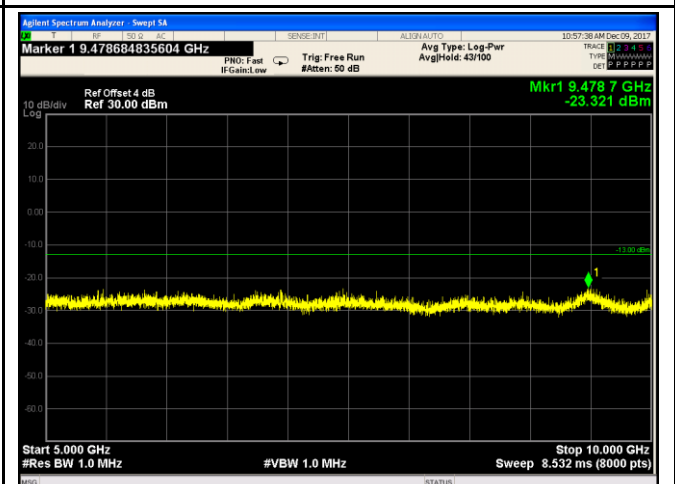

Band V - High Channel-2

UMTS-FDD Band II (Part 24E)

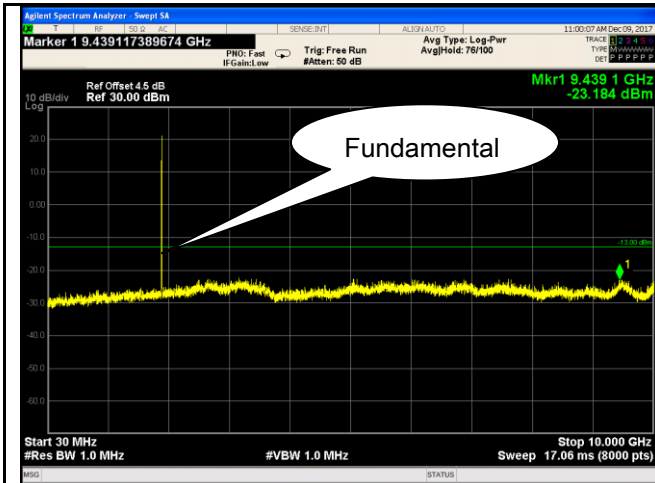

Band II - Low Channel-1

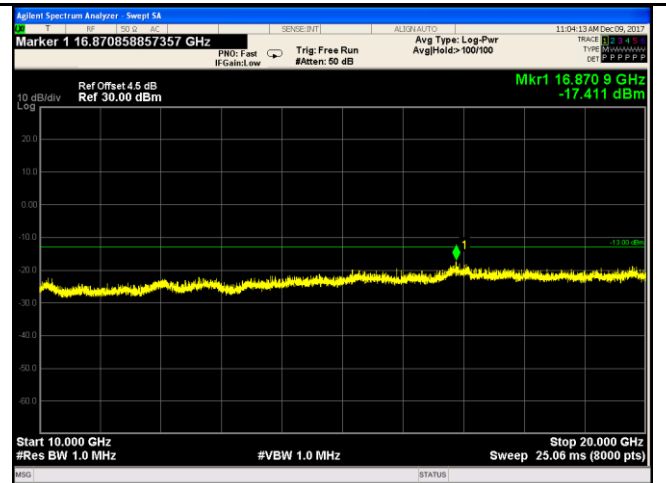

Band II - Low Channel-2

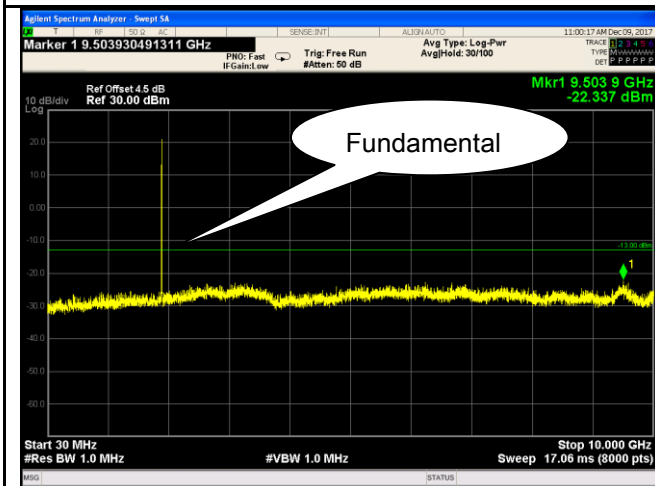

Band II - Middle Channel-1

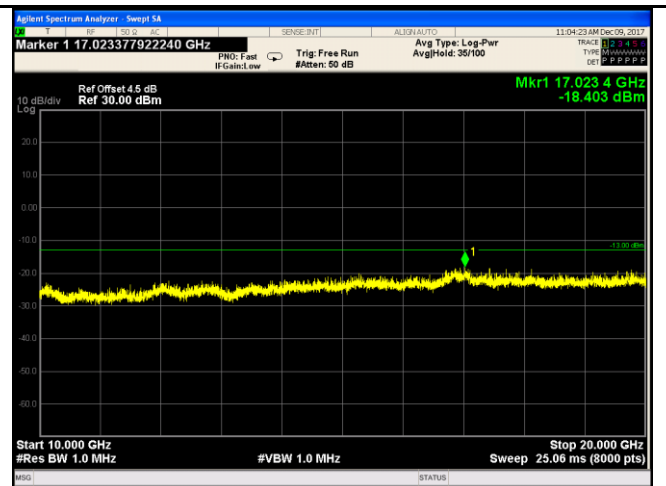

Band II - Middle Channel-2

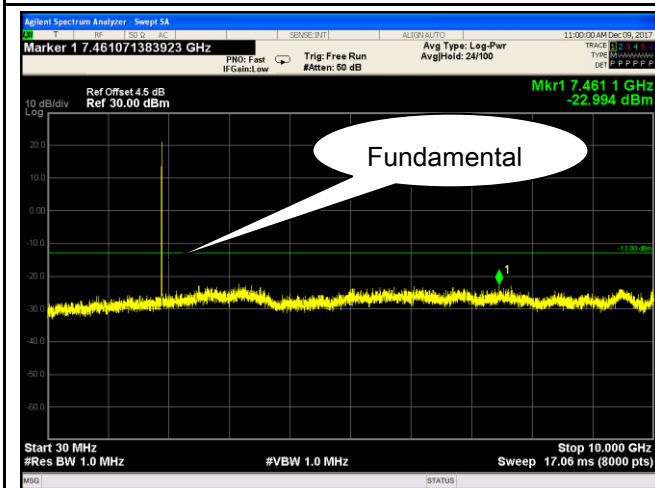

Band II - High Channel-1

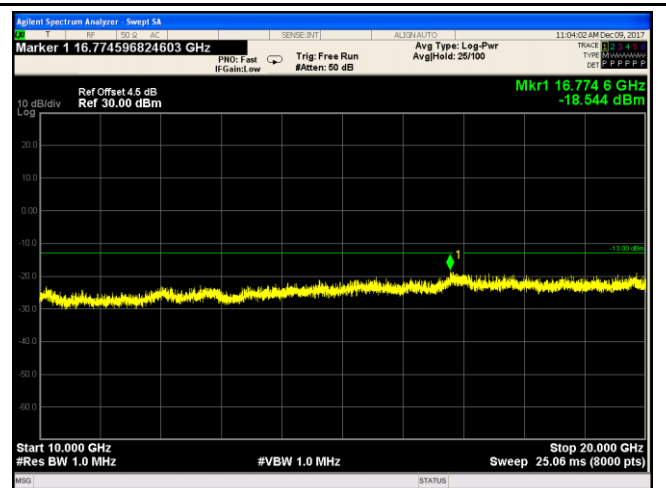

Band II - High Channel-2

UMTS-FDD Band IV (Part 27)

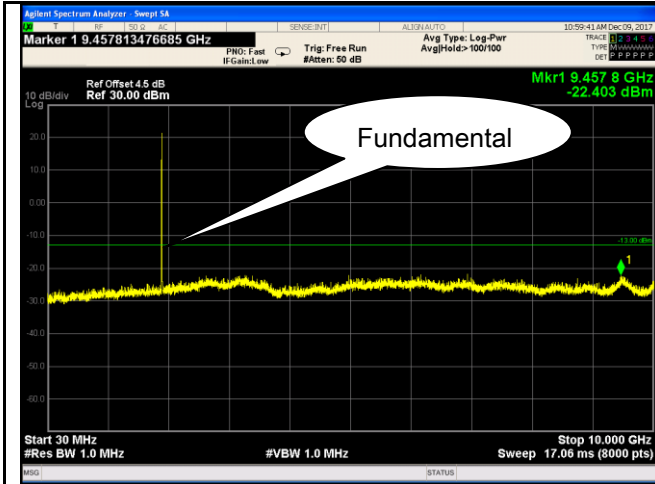

Band IV - Low Channel-1

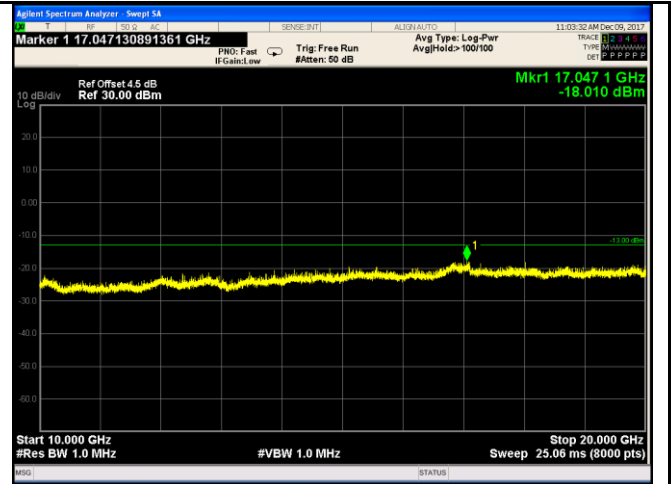

Band IV - Low Channel-2

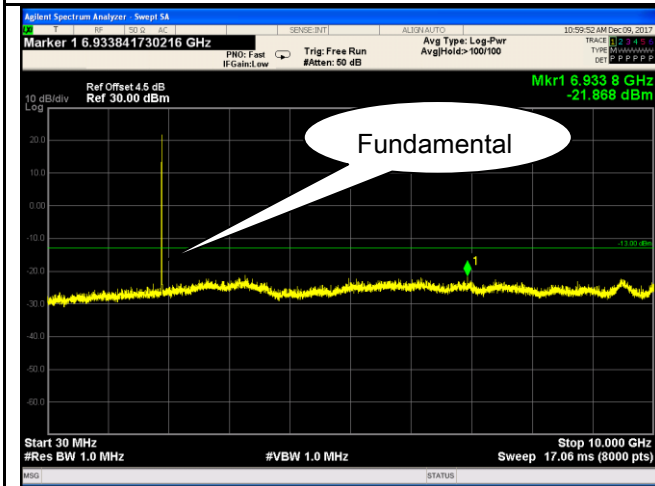

Band IV - Middle Channel-1

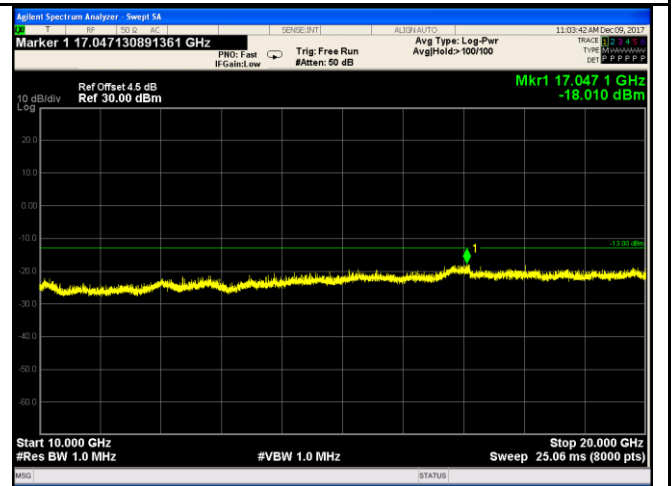

Band IV - Middle Channel-2

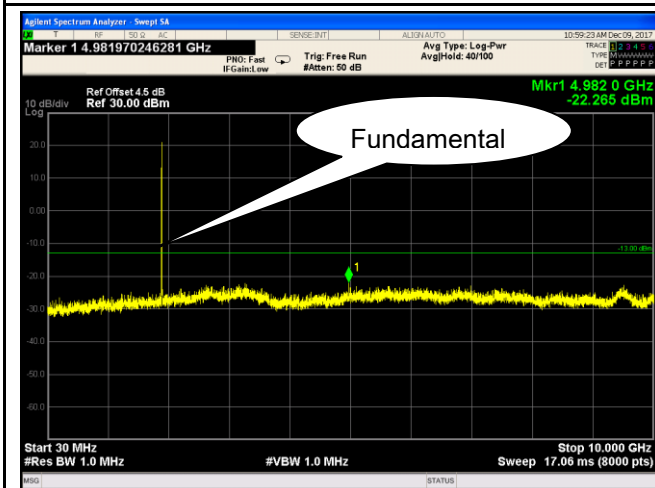

Band IV - High Channel-1

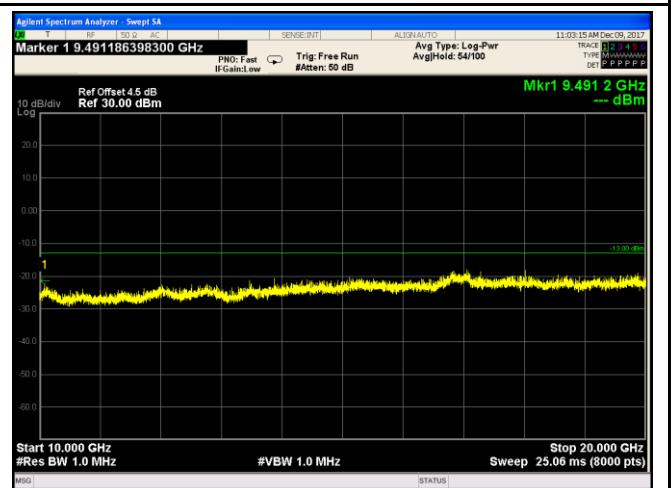

Band IV - High Channel-2

6.6 Spurious Radiated Emissions

Temperature	25 °C
Relative Humidity	56%
Atmospheric Pressure	1018mbar
Test date :	December 09, 2017
Tested By :	Loren Luo

Requirement(s):

Spec	Item	Requirement	Applicable
§2.1053, §22.917 & §24.238 § 27.53(h)	a)	The power of any emission outside of the authorized operating frequency ranges must be attenuated below the transmitter power (P) by a factor of at least $43 + 10 \log (P)$ dB. The spectrum is scanned from 30 MHz up to a frequency including its 10th harmonic.	<input checked="" type="checkbox"/>

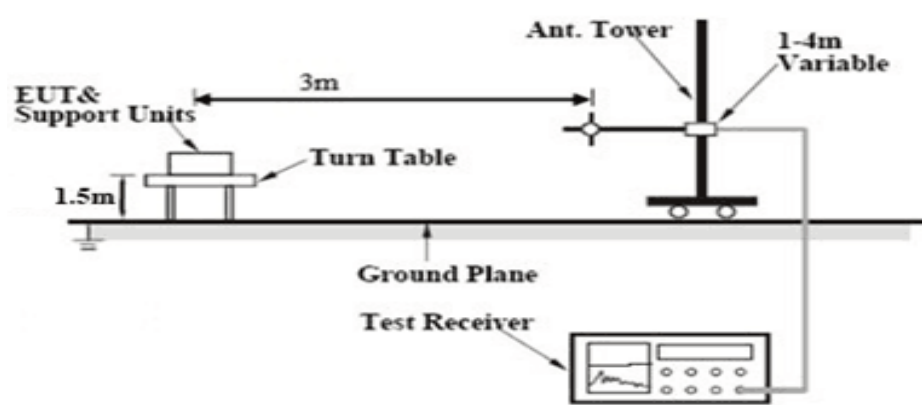
Test setup	
------------	--

Test Procedure	<ol style="list-style-type: none"> The transmitter was placed on a wooden turntable, and it was transmitting into a non-radiating load which was also placed on the turntable. The measurement antenna was placed at a distance of 3 meters from the EUT. During the tests, the antenna height and polarization as well as EUT azimuth were varied in order to identify the maximum level of emissions from the EUT. The test was performed by placing the EUT on 3-orthogonal axis. Remove the EUT and replace it with substitution antenna. A signal generator was connected to the substitution antenna by a non-radiating cable. The absolute levels of the spurious emissions were measured by the substitution. Sample Calculation: EUT Field Strength = Raw Amplitude (dBµV/m) – Amplifier Gain (dB) + Antenna Factor (dB) + Cable Loss (dB) + Filter Attenuation (dB, if used)
----------------	---

Test Report	17071301-FCC-R1
Page	61 of 104

Remark	
Result	<input checked="" type="checkbox"/> Pass <input type="checkbox"/> Fail

Test Data Yes N/A
 Test Plot Yes (See below) N/A

Cellular Band (Part 22H) result

Low channel

Frequency (MHz)	Substituted level (dBm)	Polarity (H/V)	Antenna Gain Correction (dB)	Cable Loss (dB)	Corrected Reading (dBm)	Limit (dBm)	Margin (dB)
1648.4	-43.57	V	7.95	0.67	-36.29	-13	-23.29
1648.4	-44.83	H	7.95	0.67	-37.55	-13	-24.55
236.08	-52.94	V	5.96	0.22	-47.2	-13	-34.2
326.28	-52.85	H	6.03	0.31	-47.13	-13	-34.13

Middle channel

Frequency (MHz)	Substituted level (dBm)	Polarity (H/V)	Antenna Gain Correction (dB)	Cable Loss (dB)	Corrected Reading (dBm)	Limit (dBm)	Margin (dB)
1673.2	-42.95	V	7.95	0.67	-35.67	-13	-22.67
1673.2	-43.71	H	7.95	0.67	-36.43	-13	-23.43
756.37	-52.65	V	6.42	0.33	-46.56	-13	-33.56
649.83	-53.2	H	6.14	0.34	-47.4	-13	-34.4

High channel

Frequency (MHz)	Substituted level (dBm)	Polarity (H/V)	Antenna Gain Correction (dB)	Cable Loss (dB)	Corrected Reading (dBm)	Limit (dBm)	Margin (dB)
1697.6	-43.37	V	7.95	0.68	-36.1	-13	-23.1
1697.6	-44.47	H	7.95	0.68	-37.2	-13	-24.2
513.17	-51.74	V	6.01	0.33	-46.06	-13	-33.06
769.93	-52.28	H	6.39	0.42	-46.31	-13	-33.31

Note:

1, The testing has been conformed to $10 \times 848.8 \text{ MHz} = 8,488 \text{ MHz}$

2, All other emissions more than 30 dB below the limit

3, GSM voice, GPRS and EGPRS mode were investigated. The results above show only the worse cases

4, X-Axis, Y-Axis and Z-Axis were investigated. The results above show only the worst case.

5, The radiated spurious test above 18GHz is subcontracted to SIEMIC (Nanjing-China) Laboratories. and found 30dB below the limit at least.

PCS Band (Part24E) result

Low channel

Frequency (MHz)	Substituted level (dBm)	Polarity (H/V)	Antenna Gain Correction (dB)	Cable Loss (dB)	Corrected Reading (dBm)	Limit (dBm)	Margin (dB)
3700.4	-48.9	V	10.25	1	-39.65	-13	-26.65
3700.4	-48.53	H	10.25	1	-39.28	-13	-26.28
817.3	-52.66	V	6.4	0.46	-46.72	-13	-33.72
762.55	-54.28	H	6.38	0.45	-48.35	-13	-35.35

Middle channel

Frequency (MHz)	Substituted level (dBm)	Polarity (H/V)	Antenna Gain Correction (dB)	Cable Loss (dB)	Corrected Reading (dBm)	Limit (dBm)	Margin (dB)
3760	-48.1	V	10.25	1.01	-38.86	-13	-25.86
3760	-49.23	H	10.25	1.01	-39.99	-13	-26.99
477.43	-52.69	V	6.05	0.26	-46.9	-13	-33.9
276.17	-52.72	H	5.96	0.25	-47.01	-13	-34.01

High channel

Frequency (MHz)	Substituted level (dBm)	Polarity (H/V)	Antenna Gain Correction (dB)	Cable Loss (dB)	Corrected Reading (dBm)	Limit (dBm)	Margin (dB)
3819.6	-48.08	V	10.36	1.02	-38.74	-13	-25.74
3819.6	-50.23	H	10.36	1.02	-40.89	-13	-27.89
521.18	-52.97	V	6.44	0.38	-46.91	-13	-33.91
552.24	-52.72	H	6.41	0.36	-46.67	-13	-33.67

Note:

- 1, The testing has been conformed to $10 \times 1909.8 \text{ MHz} = 19,098 \text{ MHz}$
- 2, All other emissions more than 30 dB below the limit
- 3, GSM voice, GPRS and EGPRS mode were investigated. The results above show only the worse cases
- 4, X-Axis, Y-Axis and Z-Axis were investigated. The results above show only the worst case.
- 5, The radiated spurious test above 18GHz is subcontracted to SIEMIC (Nanjing-China) Laboratories. and found 30dB below the limit at least.

UMTS-FDD Band V (Part 22H)

Low channel

Frequency (MHz)	Substituted level (dBm)	Polarity (H/V)	Antenna Gain Correction (dB)	Cable Loss (dB)	Corrected Reading (dBm)	Limit (dBm)	Margin (dB)
1652.8	-46.41	V	7.95	0.67	-39.13	-13	-26.13
1652.8	-46.37	H	7.95	0.67	-39.09	-13	-26.09
572.42	-52.4	V	6.42	0.37	-46.35	-13	-33.35
785.54	-52.97	H	6.39	0.44	-47.02	-13	-34.02

Middle channel

Frequency (MHz)	Substituted level (dBm)	Polarity (H/V)	Antenna Gain Correction (dB)	Cable Loss (dB)	Corrected Reading (dBm)	Limit (dBm)	Margin (dB)
1670	-46.64	V	7.95	0.67	-39.36	-13	-26.36
1670	-45.47	H	7.95	0.67	-38.19	-13	-25.19
715.36	-52.53	V	6.43	0.44	-46.54	-13	-33.54
817.14	-52.77	H	6.45	0.42	-46.74	-13	-33.74

High channel

Frequency (MHz)	Substituted level (dBm)	Polarity (H/V)	Antenna Gain Correction (dB)	Cable Loss (dB)	Corrected Reading (dBm)	Limit (dBm)	Margin (dB)
1693.2	-46.78	V	7.95	0.68	-39.51	-13	-26.51
1693.2	-46.3	H	7.95	0.68	-39.03	-13	-26.03
610.01	-52.26	V	6.36	0.44	-46.34	-13	-33.34
305.4	-53.91	H	5.95	0.27	-48.23	-13	-35.23

Note:

1, The testing has been conformed to $10 \times 846.6 \text{ MHz} = 8,466 \text{ MHz}$

2, All other emissions more than 30 dB below the limit

3, RMC, HSUPA and HSDPA mode were investigated. The results above show only the worse cases

4, X-Axis, Y-Axis and Z-Axis were investigated. The results above show only the worst case.

5, The radiated spurious test above 18GHz is subcontracted to SIEMIC (Nanjing-China) Laboratories. and found 30dB below the limit at least.

UMTS-FDD Band II (Part 24E)

Low channel

Frequency (MHz)	Substituted level (dBm)	Polarity (H/V)	Antenna Gain Correction (dB)	Cable Loss (dB)	Corrected Reading (dBm)	Limit (dBm)	Margin (dB)
3704.8	-50.22	V	10.25	1	-40.97	-13	-27.97
3704.8	-48.83	H	10.25	1	-39.58	-13	-26.58
568.29	-53.23	V	6.44	0.37	-47.16	-13	-34.16
314.56	-53.91	H	5.96	0.22	-48.17	-13	-35.17

Middle channel

Frequency (MHz)	Substituted level (dBm)	Polarity (H/V)	Antenna Gain Correction (dB)	Cable Loss (dB)	Corrected Reading (dBm)	Limit (dBm)	Margin (dB)
3760	-49.65	V	10.25	1.01	-40.41	-13	-27.41
3760	-50.23	H	10.25	1.01	-40.99	-13	-27.99
837.04	-52.92	V	6.39	0.42	-46.95	-13	-33.95
581.15	-52.74	H	6.42	0.33	-46.65	-13	-33.65

High channel

Frequency (MHz)	Substituted level (dBm)	Polarity (H/V)	Antenna Gain Correction (dB)	Cable Loss (dB)	Corrected Reading (dBm)	Limit (dBm)	Margin (dB)
3815.2	-49.51	V	10.36	1.02	-40.17	-13	-27.17
3815.2	-49.67	H	10.36	1.02	-40.33	-13	-27.33
383.57	-52.98	V	6.03	0.28	-47.23	-13	-34.23
200.21	-54.58	H	5.96	0.25	-48.87	-13	-35.87

Note:

- 1, The testing has been conformed to $10 \times 1907.6 \text{ MHz} = 19,076 \text{ MHz}$
- 2, All other emissions more than 30 dB below the limit
- 3, RMC, HSUPA and HSDPA mode were investigated. The results above show only the worse cases
- 4, X-Axis, Y-Axis and Z-Axis were investigated. The results above show only the worst case
- 5, The radiated spurious test above 18GHz is subcontracted to SIEMIC (Nanjing-China) Laboratories. and found 30dB below the limit at least.

UMTS-FDD Band IV (Part 27)

Low channel

Frequency (MHz)	Substituted level (dBm)	Polarity (H/V)	Antenna Gain Correction (dB)	Cable Loss (dB)	Corrected Reading (dBm)	Limit (dBm)	Margin (dB)
3424.8	-42.69	V	10.07	0.96	-33.58	-13	-20.58
3424.8	-44.4	H	10.07	0.96	-35.29	-13	-22.29
210.51	-52.58	V	5.97	0.27	-46.88	-13	-33.88
536.62	-52.38	H	6.05	0.36	-46.69	-13	-33.69

Middle channel

Frequency (MHz)	Substituted level (dBm)	Polarity (H/V)	Antenna Gain Correction (dB)	Cable Loss (dB)	Corrected Reading (dBm)	Limit (dBm)	Margin (dB)
3480	-43.67	V	10.09	0.96	-34.54	-13	-21.54
3480	-43.08	H	10.09	0.96	-33.95	-13	-20.95
407.2	-52.9	V	6.11	0.31	-47.1	-13	-34.1
305.03	-52.88	H	5.96	0.28	-47.2	-13	-34.2

High channel

Frequency (MHz)	Substituted level (dBm)	Polarity (H/V)	Antenna Gain Correction (dB)	Cable Loss (dB)	Corrected Reading (dBm)	Limit (dBm)	Margin (dB)
3505.2	-43.38	V	10.09	0.97	-34.26	-13	-21.26
3505.2	-44.3	H	10.09	0.97	-35.18	-13	-22.18
764.24	-52.34	V	6.34	0.43	-46.43	-13	-33.43
495.36	-52.06	H	6.09	0.33	-46.3	-13	-33.3

Note:

1, The testing has been conformed to $10 \times 1752.6 \text{ MHz} = 17,526 \text{ MHz}$

2, All other emissions more than 30 dB below the limit

3, RMC, HSUPA and HSDPA mode were investigated. The results above show only the worse cases.

4, X-Axis, Y-Axis and Z-Axis were investigated. The results above show only the worst case.

5, The radiated spurious test above 18GHz is subcontracted to SIEMIC (Nanjing-China) Laboratories. and found 30dB below the limit at least.

6.7 Band Edge

Temperature	25 °C
Relative Humidity	56%
Atmospheric Pressure	1018mbar
Test date :	December 09, 2017
Tested By :	Loren Luo

Requirement(s):

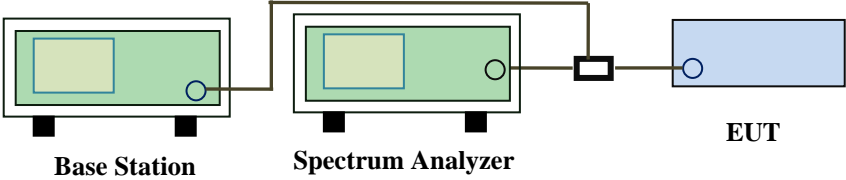
Spec	Item	Requirement	Applicable
§22.917(a) §24.238(a) § 27.53(h)	a)	The power of any emission outside of the authorized operating frequency ranges must be lower than the transmitter power (P) by a factor of at least $43 + 10 \log (P)$ dB.	<input checked="" type="checkbox"/>
Test setup	 <p>The diagram shows a Base Station (green box) and a Spectrum Analyzer (green box) connected to an EUT (blue box) through a power divider (black box). The Base Station and Spectrum Analyzer are connected to the power divider, which then splits the signal to the EUT.</p>		
Procedure	<ul style="list-style-type: none"> - The EUT was connected to Spectrum Analyzer and Base Station via power divider. - The Band Edges of low and high channels for the highest RF powers were measured. Setting RBW as roughly BW/100. 		
Remark			
Result	<input checked="" type="checkbox"/> Pass <input type="checkbox"/> Fail		

Test Data Yes N/A
 Test Plot Yes (See below) N/A

GSM Voice:

Cellular Band (Part 22H) result

Frequency (MHz)	Emission (dBm)	Limit (dBm)
823.995	-14.683	-13
849.0025	-17.958	-13

PCS Band (Part24E) result

Frequency (MHz)	Emission (dBm)	Limit (dBm)
1849.9975	-17.046	-13
1910.0225	-15.105	-13

GPRS:

Cellular Band (Part 22H) result

Frequency (MHz)	Emission (dBm)	Limit (dBm)
823.9975	-17.669	-13
849.0225	-17.131	-13

PCS Band (Part24E) result

Frequency (MHz)	Emission (dBm)	Limit (dBm)
1849.9975	-16.379	-13
1910.005	-16.330	-13

EGPRS (MCS1):

Cellular Band (Part 22H) result

Frequency (MHz)	Emission (dBm)	Limit (dBm)
823.9975	-15.28	-13
849.015	-18.67	-13

PCS Band (Part24E) result

Frequency (MHz)	Emission (dBm)	Limit (dBm)
1849.9975	-19.56	-13
1910.02	-17.61	-13

RCM:

UMTS-FDD Band V (Part 22H)

Frequency (MHz)	Emission (dBm)	Limit (dBm)
823.125	-21.715	-13
850.125	-28.743	-13

UMTS-FDD Band II (Part 24E)

Frequency (MHz)	Emission (dBm)	Limit (dBm)
1849.175	-23.802	-13
1910.05	-27.707	-13

UMTS-FDD Band IV (Part 27)

Frequency (MHz)	Emission (dBm)	Limit (dBm)
1708.775	-25.090	-13
1755.275	-22.193	-13

HSUPA:

UMTS-FDD Band V (Part 22H)

Frequency (MHz)	Emission (dBm)	Limit (dBm)
823.025	-21.366	-13
850.05	-27.876	-13

UMTS-FDD Band II (Part 24E)

Frequency (MHz)	Emission (dBm)	Limit (dBm)
1849.2	-23.680	-13
1910.05	-27.215	-27.66

UMTS-FDD Band IV (Part 27)

Frequency (MHz)	Emission (dBm)	Limit (dBm)
1709.875	-26.113	-13
1756	-22.679	-13

HSDPA:

UMTS-FDD Band V (Part 22H)

Frequency (MHz)	Emission (dBm)	Limit (dBm)
823.1	-20.248	-13
849.85	-28.941	-13

UMTS-FDD Band II (Part 24E)

Frequency (MHz)	Emission (dBm)	Limit (dBm)
1849.125	-24.935	-13
1910.05	-26.584	-13

UMTS-FDD Band IV (Part 27)

Frequency (MHz)	Emission (dBm)	Limit (dBm)
1709.075	-26.304	-13
1755.1	-23.921	-13

**GSM Voice:
Test Plots**

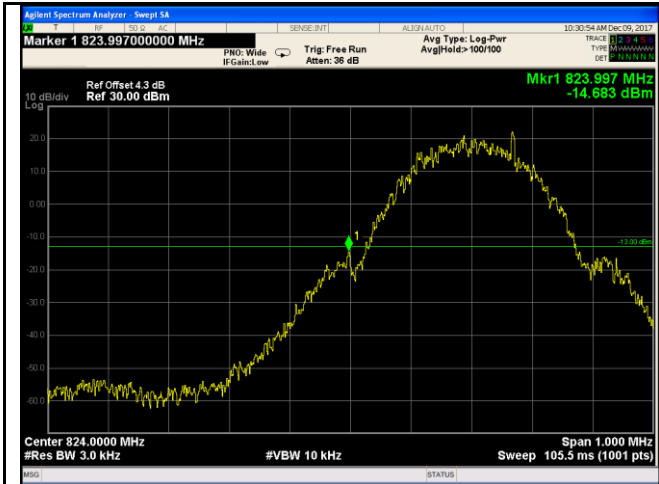

Cellular Band - Low Channel

Note: Offset=Cable loss (4.0) + 10log
(3.18/3)=4.0+0.3=4.3dB



Cellular Band - High Channel

Note: Offset=Cable loss (4.0) + 10log
(3.18/3)=4.0+0.3=4.3dB

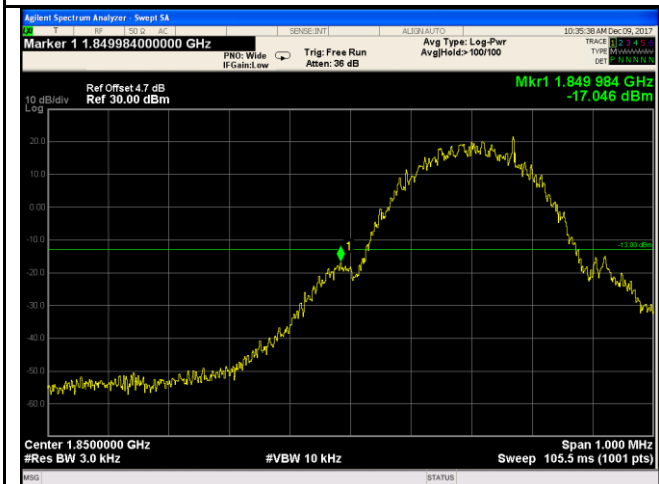

PCS Band - Low Channel

Note: Offset=Cable loss (4.0) + 10log
(3.11/3)=4.5+0.2=4.7dB

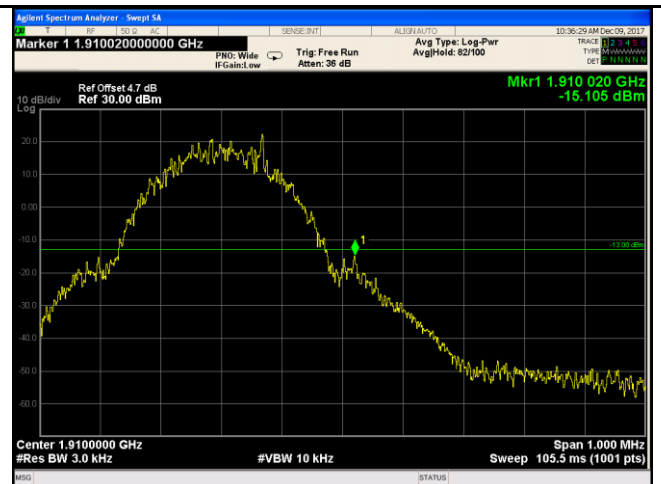

PCS Band - High Channel

Note: Offset=Cable loss (4.0) + 10log
(3.13/3)=4.5+0.2=4.7dB

GPRS:

Test Plots

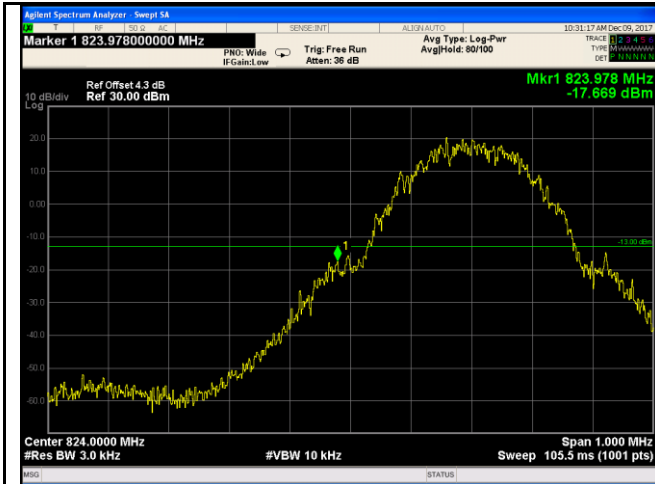

Cellular Band - Low Channel

Note: Offset=Cable loss (4.0) + 10log
(3.21/3)=4.0+0.3=4.3dB

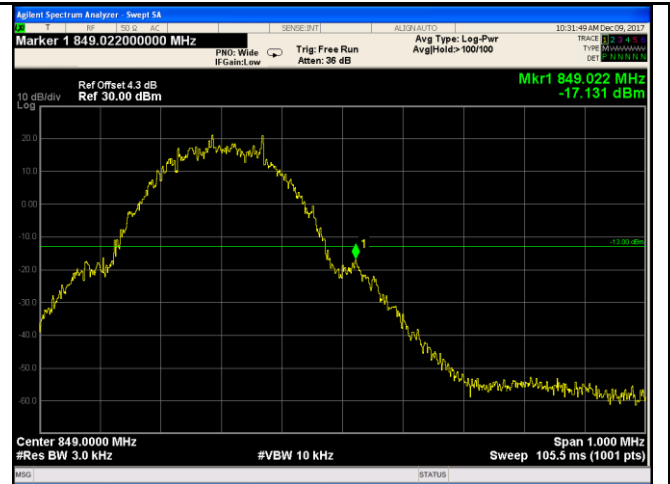

Cellular Band - High Channel

Note: Offset=Cable loss (4.0) + 10log
(3.18/3)=4.0+0.3=4.3dB

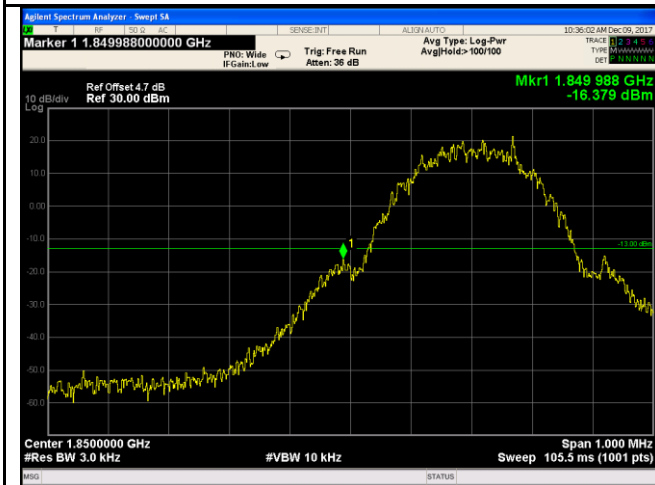

PCS Band - Low Channel

Note: Offset=Cable loss (4.5) + 10log
(3.17/3)=4.5+0.2=4.7dB



PCS Band - High Channel

Note: Offset=Cable loss (4.5) + 10log
(3.10/3)=4.5+0.2=4.7dB

EGPRS (MCS1):

Test Plots

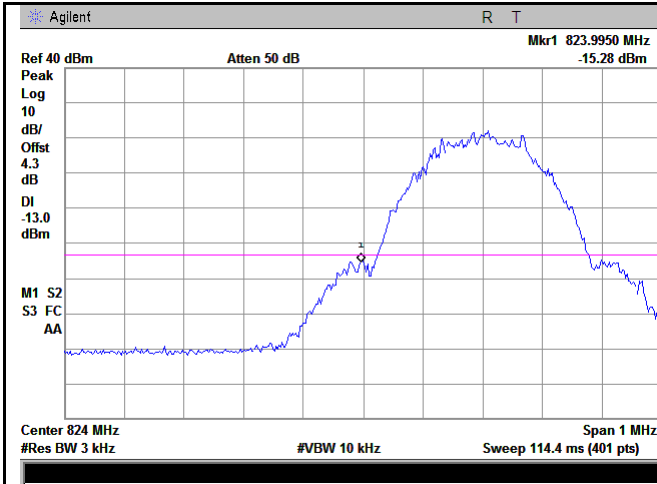

Cellular Band - Low Channel

Note: Offset=Cable loss (4.0) + 10log
(3.19/3)=4.0+0.3=4.3dB

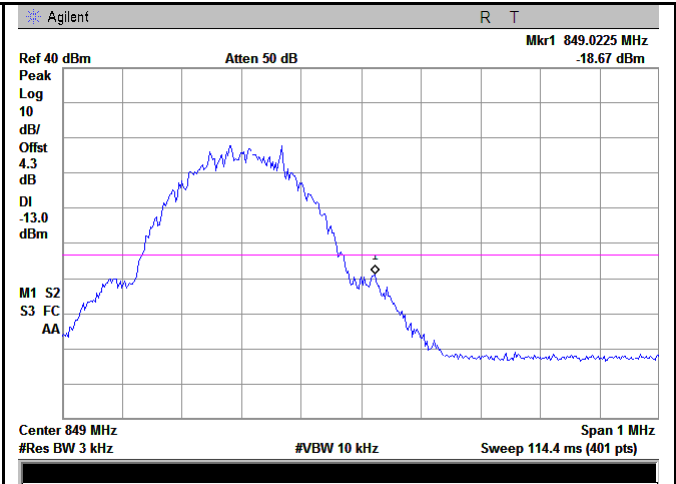

Cellular Band - High Channel

Note: Offset=Cable loss (4.0) + 10log
(3.19/3)=4.0+0.3=4.3dB

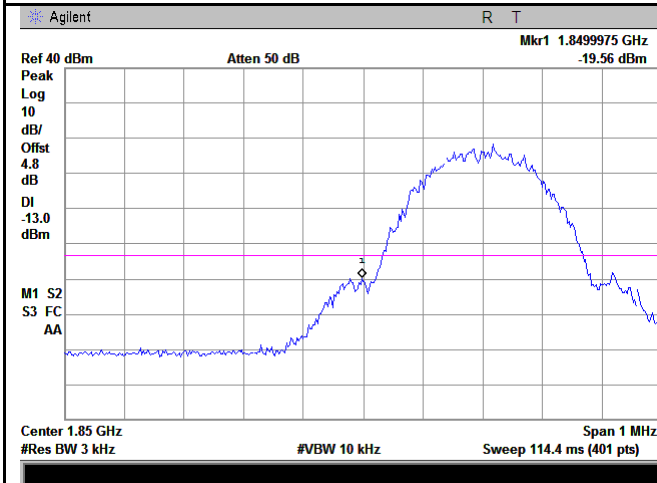

PCS Band - Low Channel

Note: Offset=Cable loss (4.5) + 10log
(3.19/3)=4.5+0.3=4.8dB

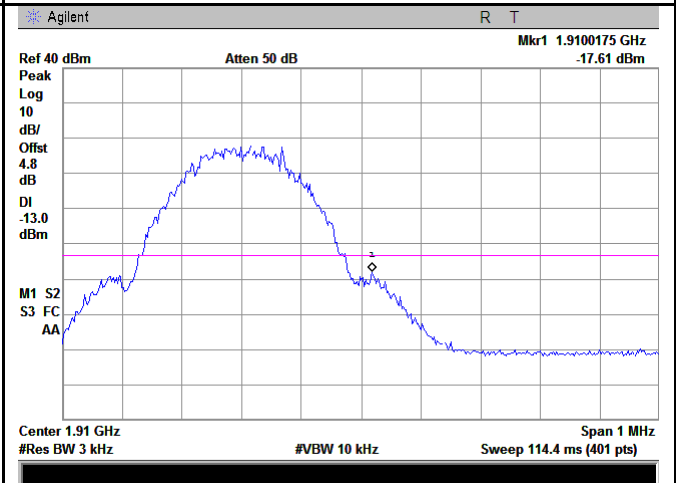

PCS Band - High Channel

Note: Offset=Cable loss (4.5) + 10log
(3.19/3)=4.5+0.3=4.8dB

RMC:

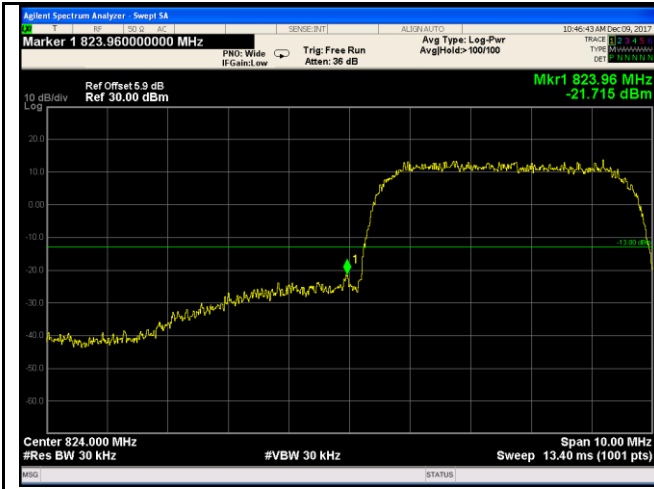

UMTS-FDD Band V - Low Channel

Note: Offset=Cable loss (4.0) + 10log
(47.00/30)=4.0+1.9=5.9dB

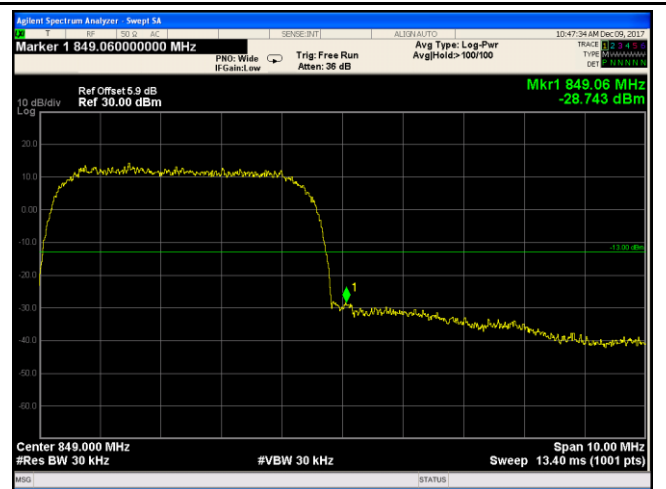

UMTS-FDD Band V - High Channel

Note: Offset=Cable loss (4.0) + 10log
(46.73/30)=4.0+1.9=5.9dB

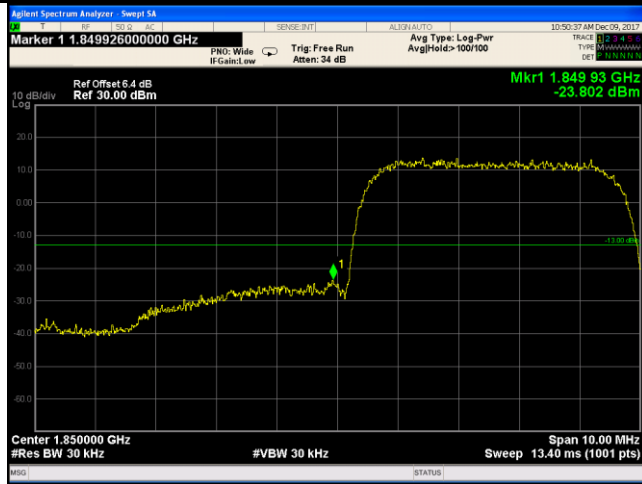

UMTS-FDD Band II - Low Channel

Note: Offset=Cable loss (4.5) + 10log
(47.00/30)=4.5+1.9=6.4dB

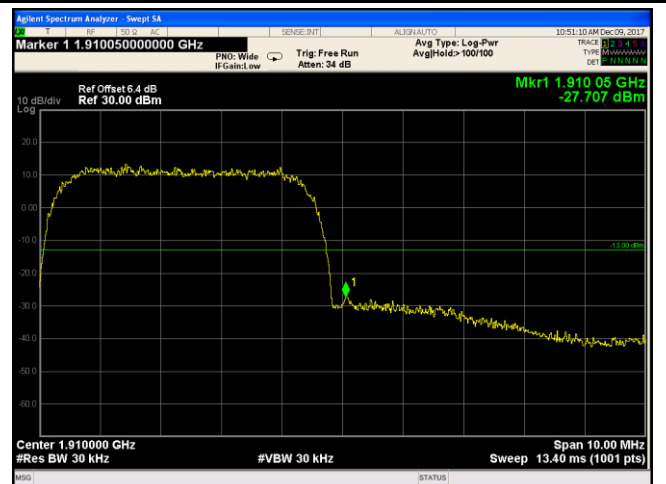

UMTS-FDD Band II - High Channel

Note: Offset=Cable loss (4.5) + 10log
(46.91/30)=4.5+1.9=6.4dB