

PCS Band (Part24E) result

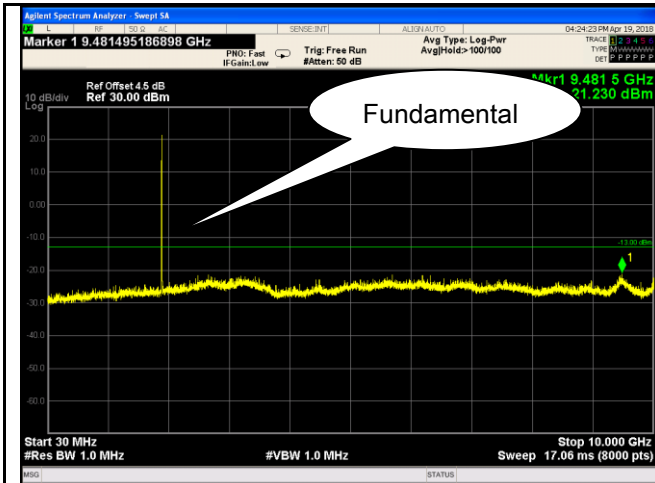

PCS1900 - Low Channel-1

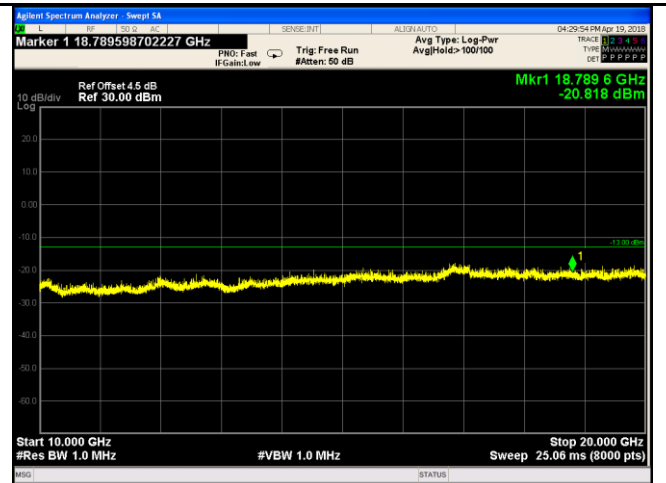

PCS 1900 - Low Channel-2

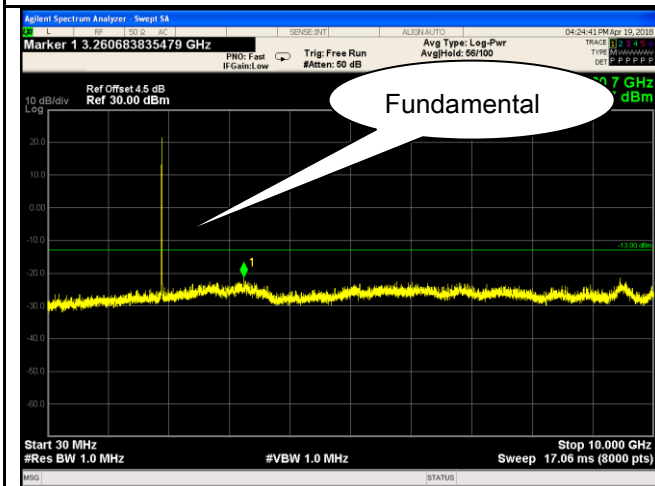

PCS1900 - Middle Channel-1

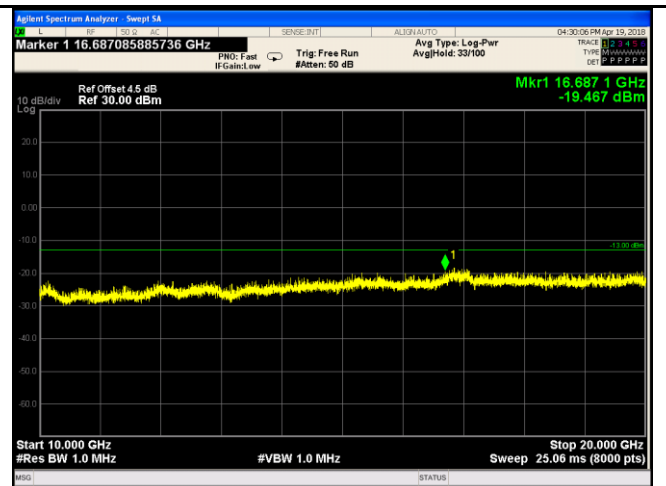

PCS 1900 - Middle Channel-2

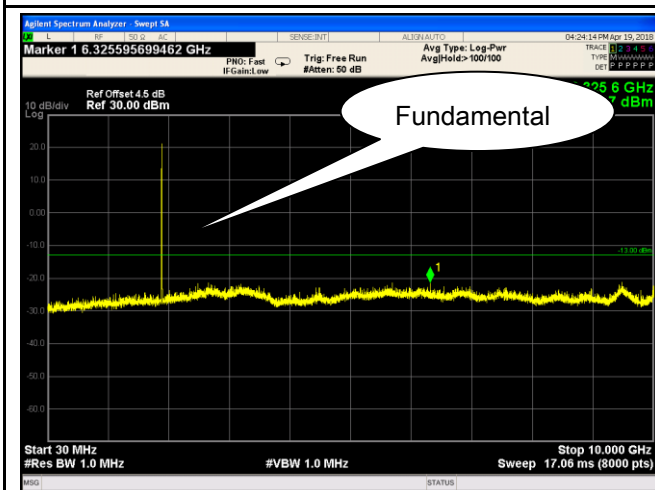

PCS1900 - High Channel-1

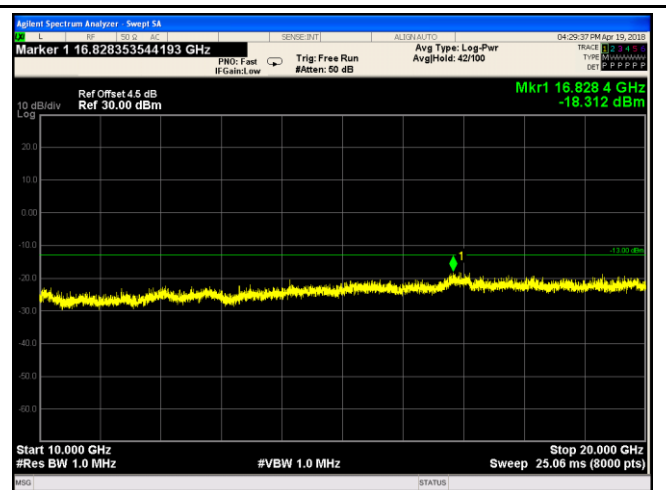

PCS 1900 - High Channel-2

RMC

UMTS-FDD Band V (Part 22H)

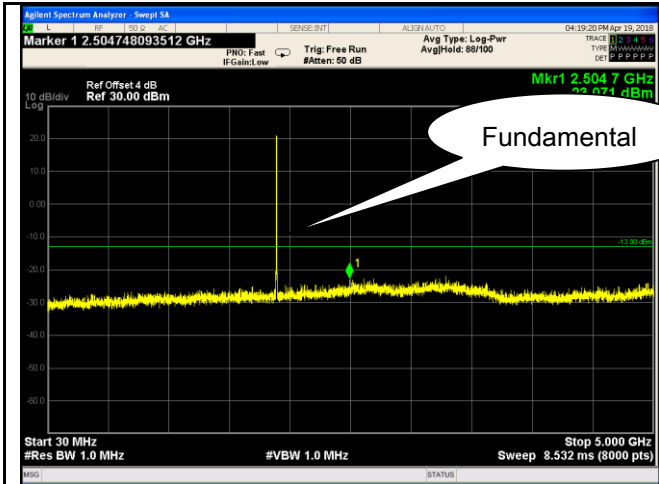

Band V - Low Channel-1

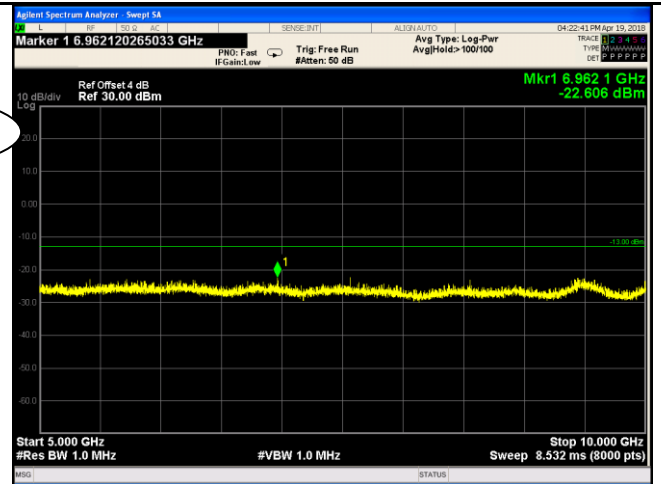

Band V - Low Channel-2

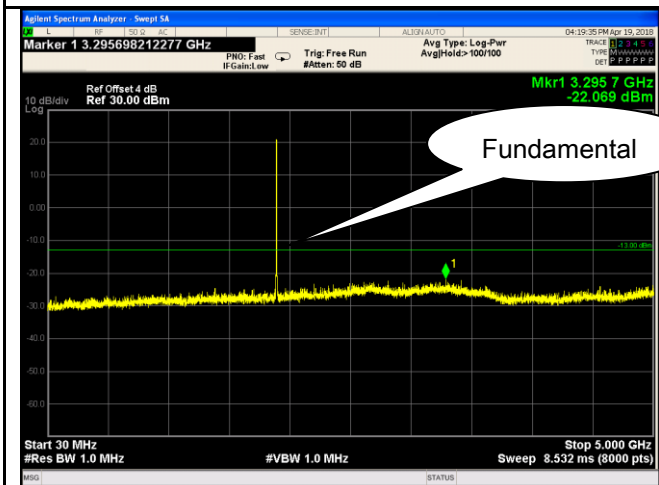

Band V - Middle Channel-1

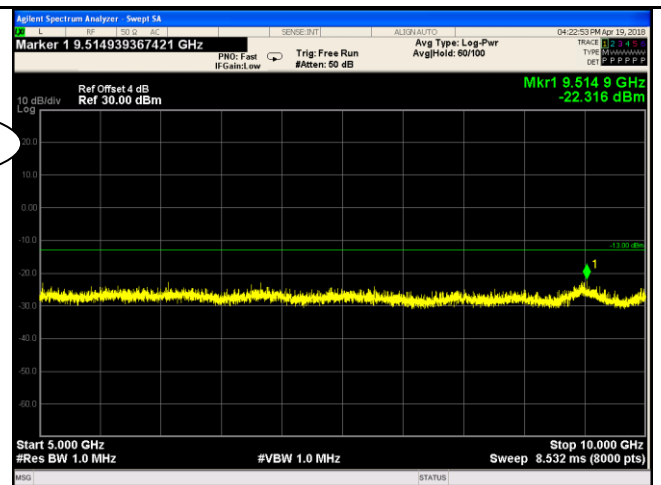

Band V - Middle Channel-2

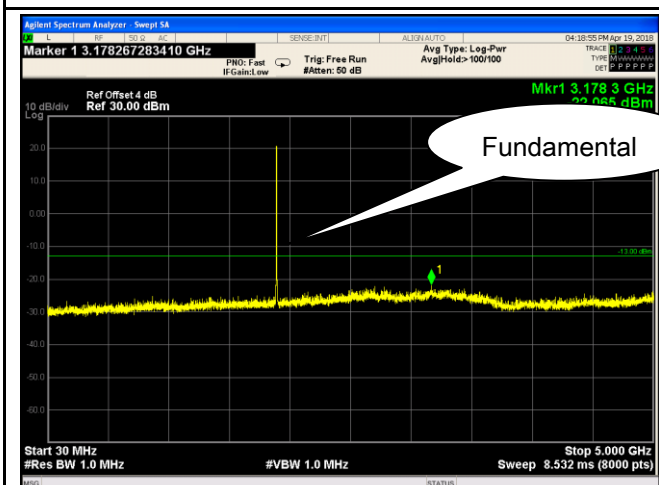

Band V - High Channel-1

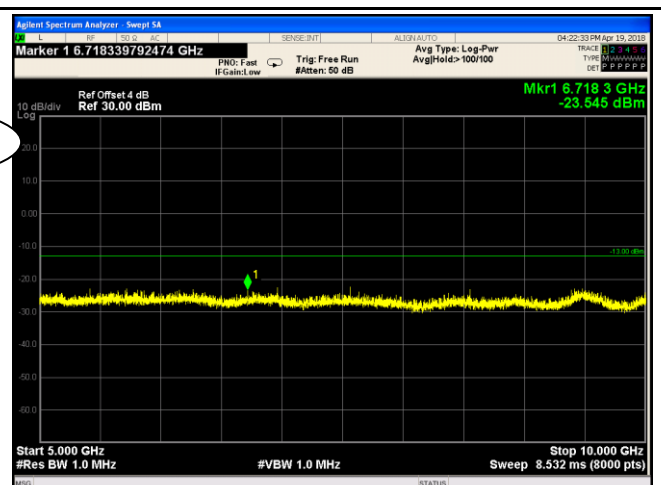

Band V - High Channel-2

UMTS-FDD Band II (Part 24E)

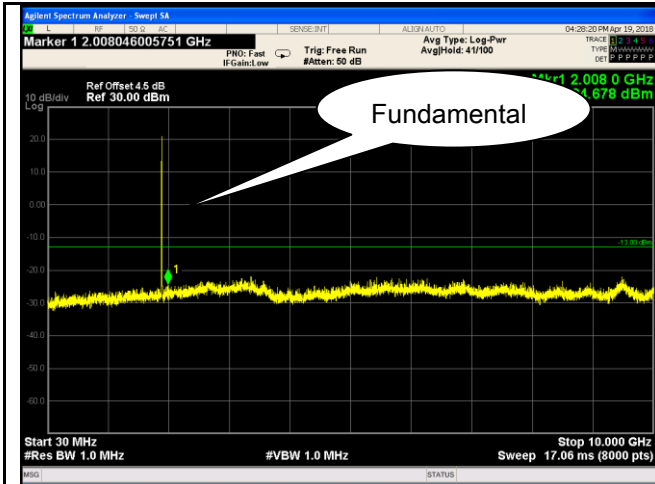

Band II - Low Channel-1

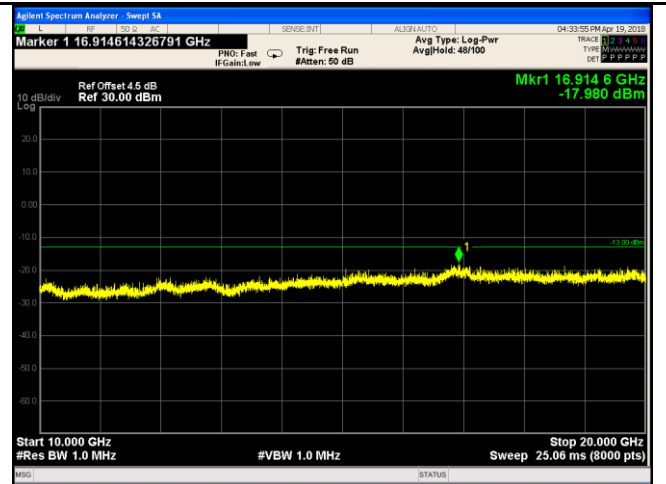

Band II - Low Channel-2

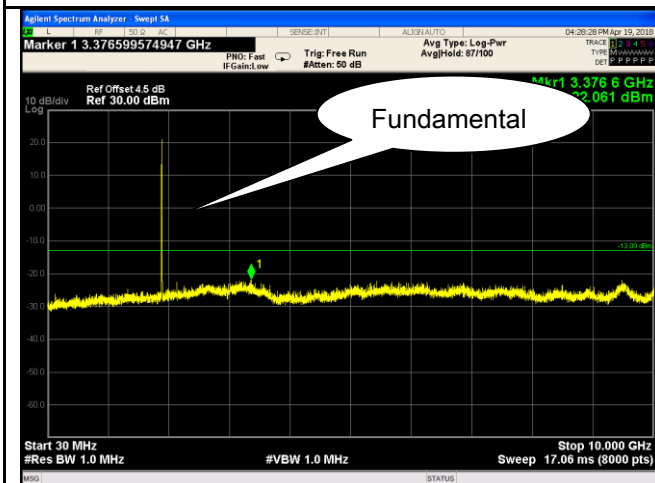

Band II - Middle Channel-1

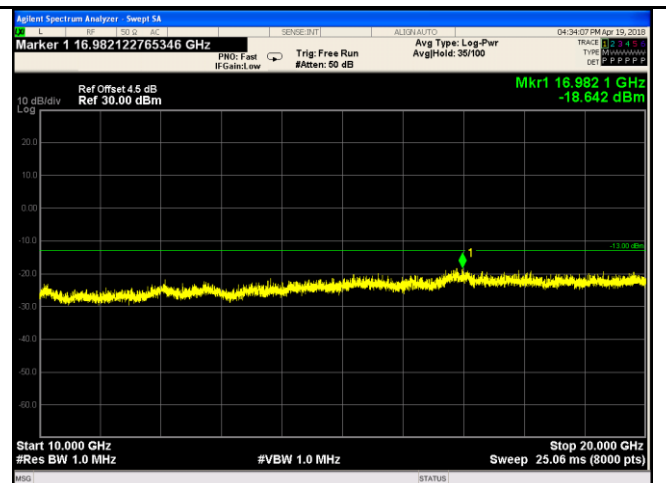

Band II - Middle Channel-2

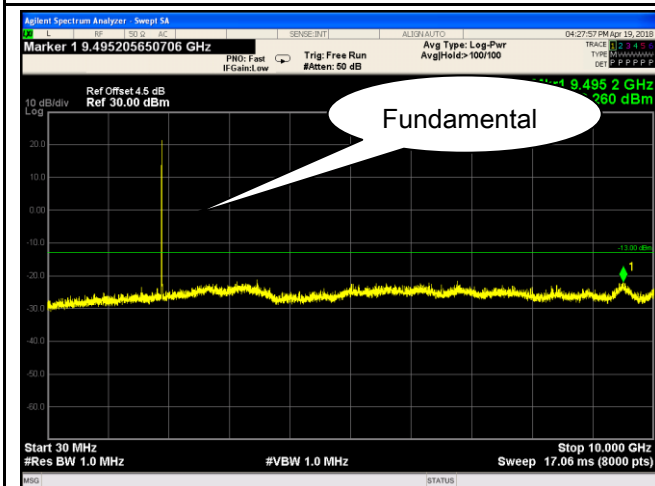

Band II - High Channel-1

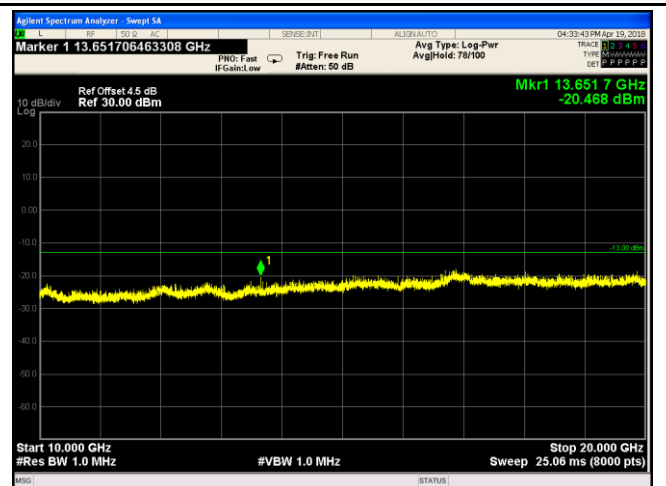

Band II - High Channel-2

UMTS-FDD Band IV (Part 27)

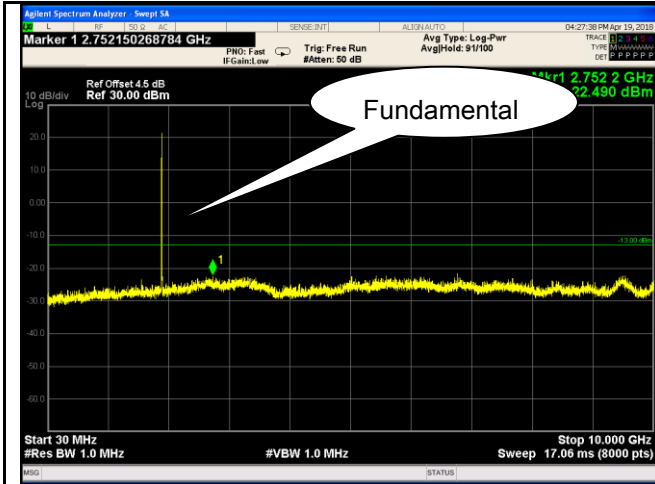

Band IV - Low Channel-1

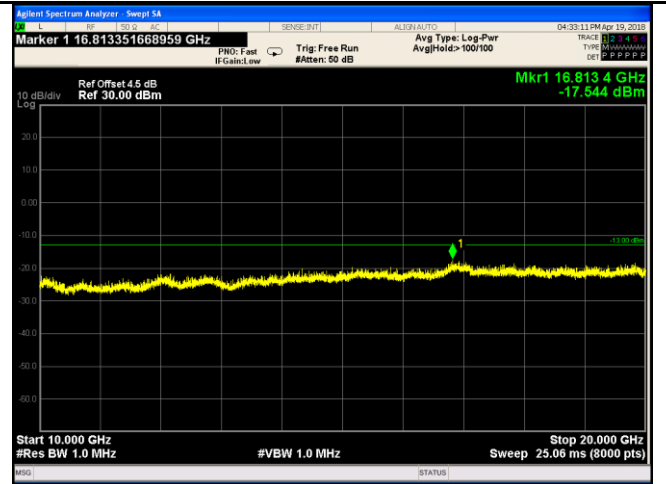

Band IV - Low Channel-2

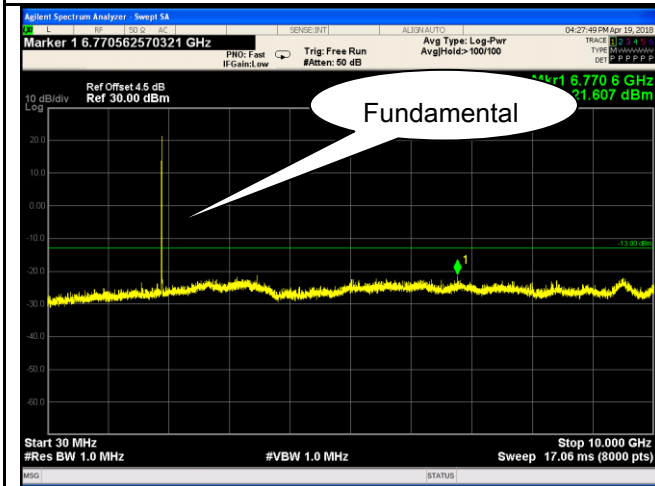

Band IV - Middle Channel-1

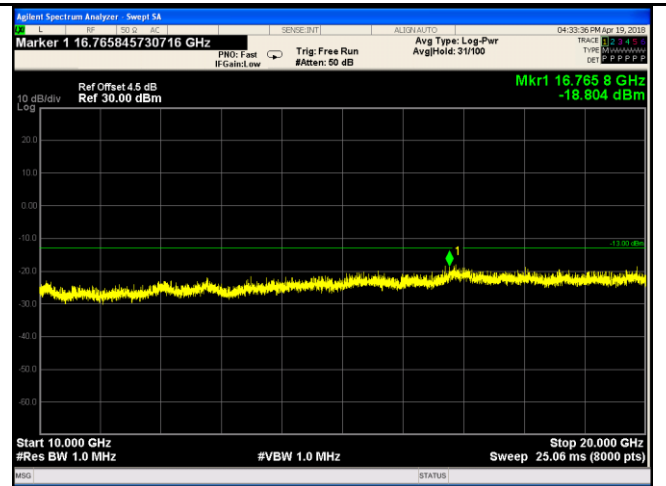

Band IV - Middle Channel-2

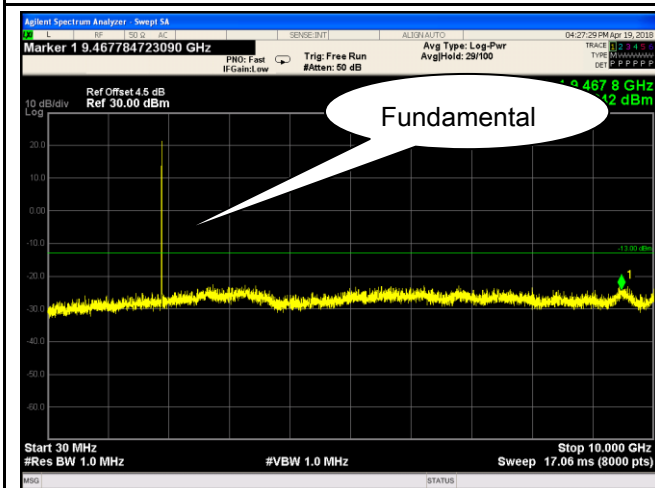

Band IV - High Channel-1

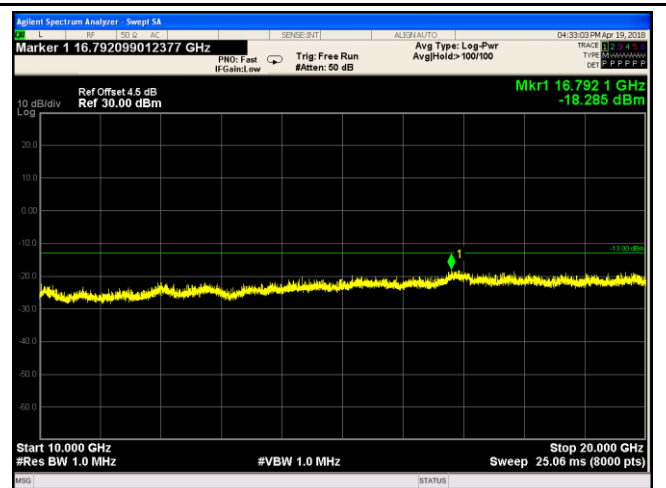

Band IV - High Channel-2

HSDPA:

UMTS-FDD Band V (Part 22H)

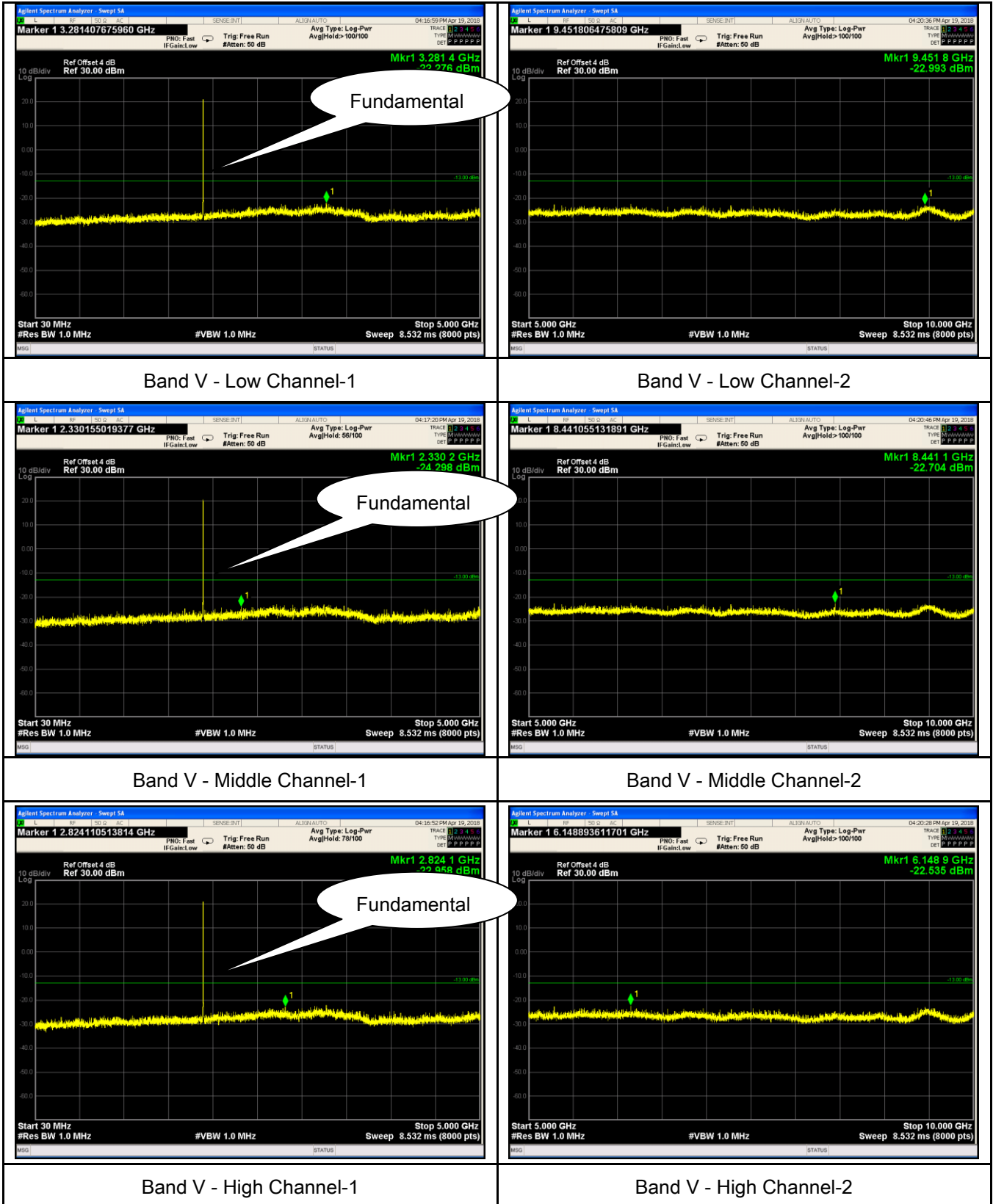

UMTS-FDD Band II (Part 24E)

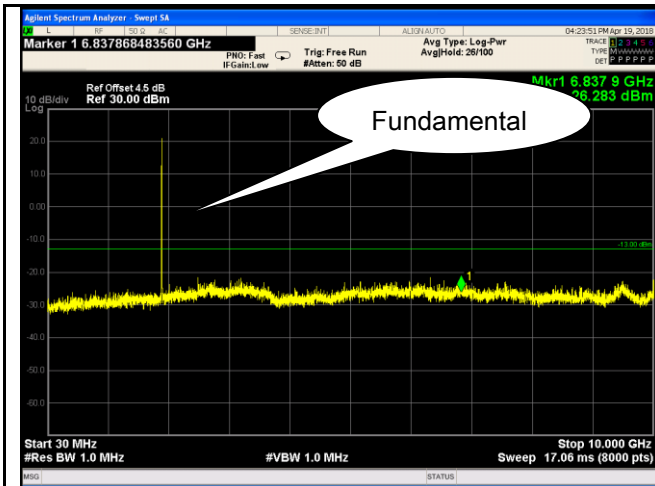

Band II - Low Channel-1

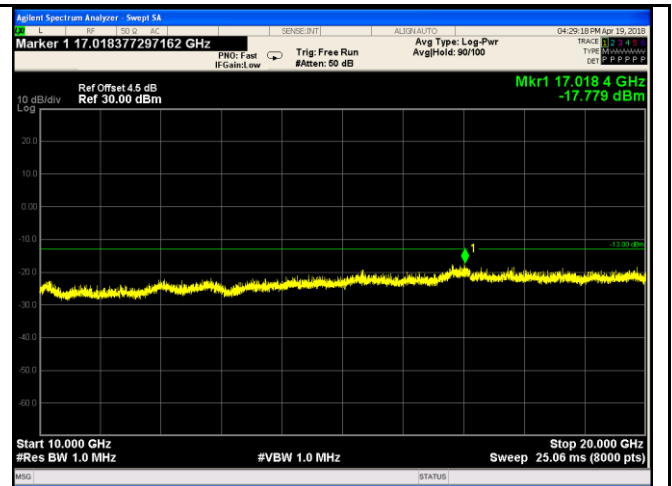

Band II - Low Channel-2

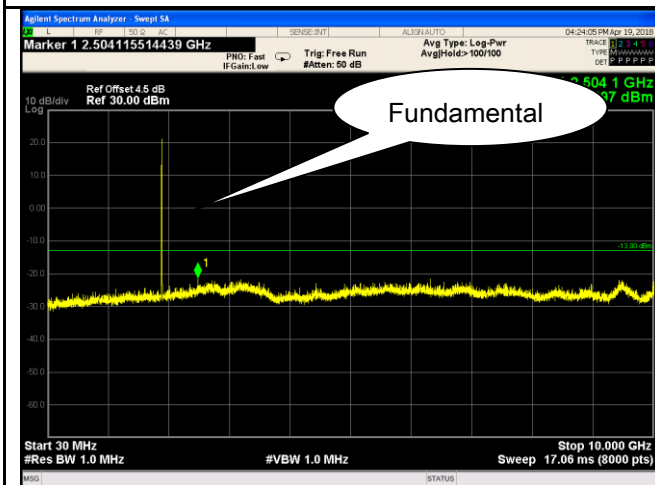

Band II - Middle Channel-1

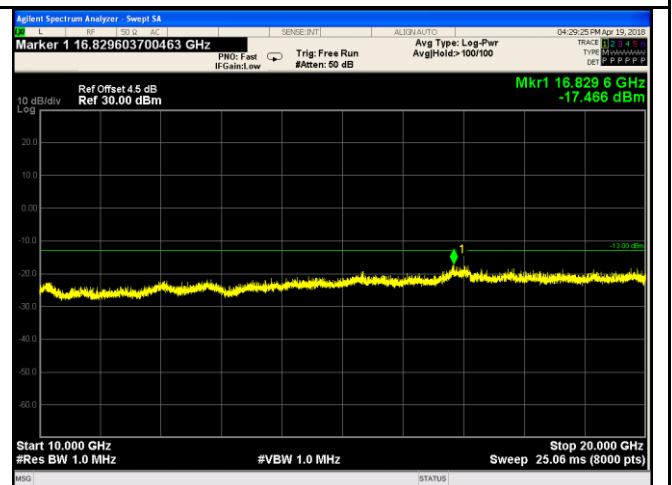

Band II - Middle Channel-2

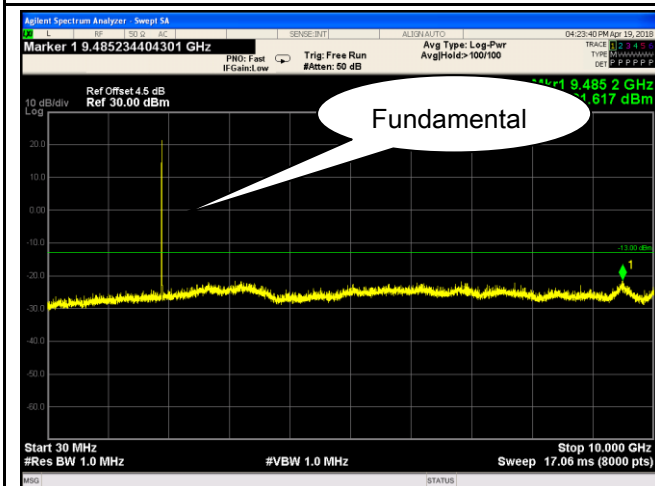

Band II - High Channel-1

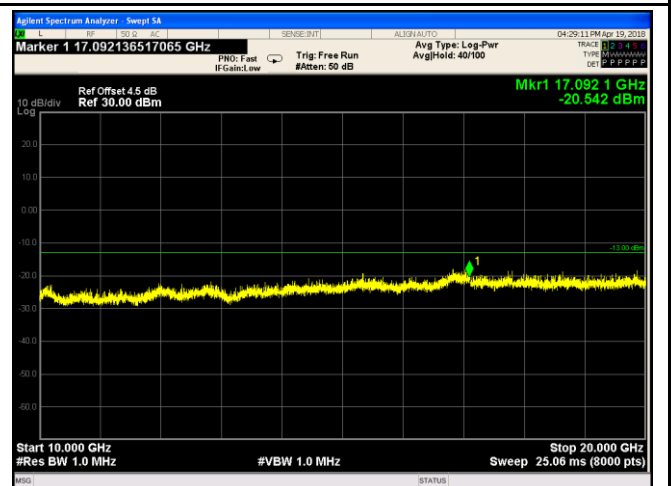

Band II - High Channel-2

UMTS-FDD Band IV (Part 27)

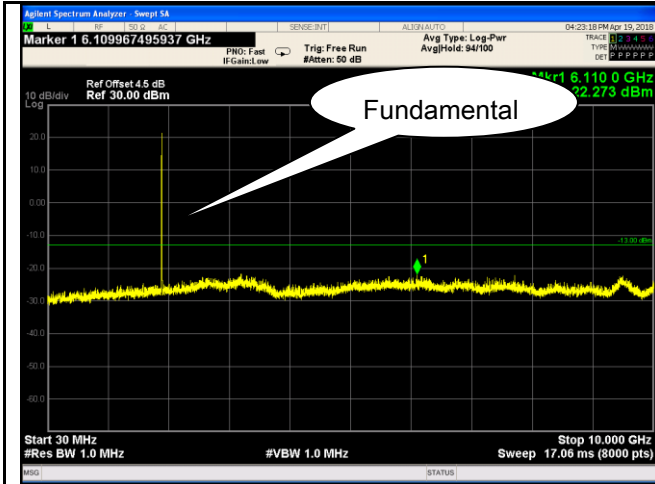

Band IV - Low Channel-1

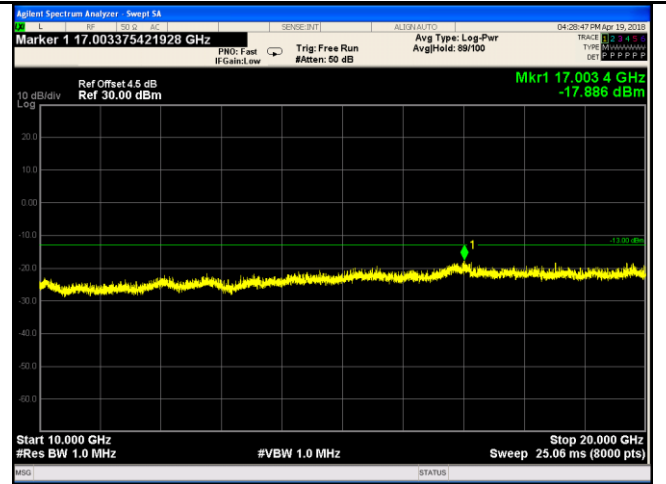

Band IV - Low Channel-2

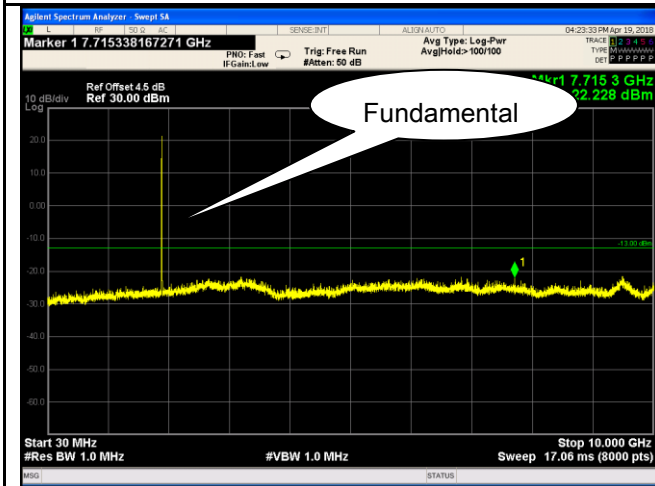

Band IV - Middle Channel-1

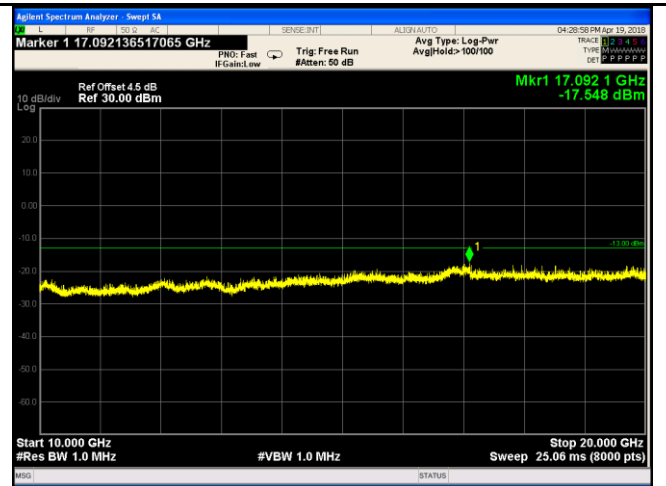

Band IV - Middle Channel-2

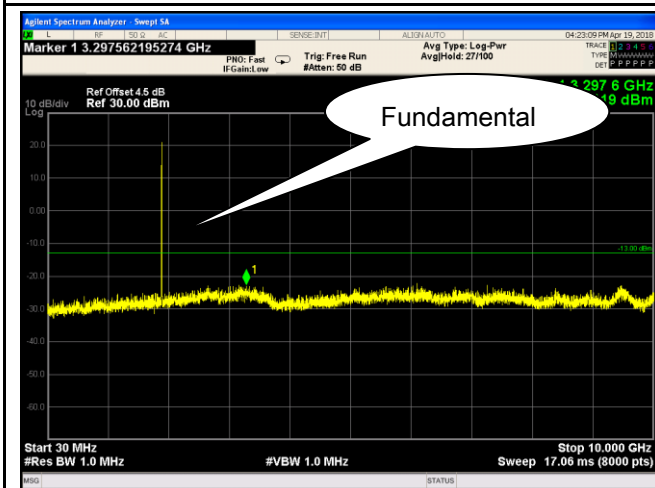

Band IV - High Channel-1

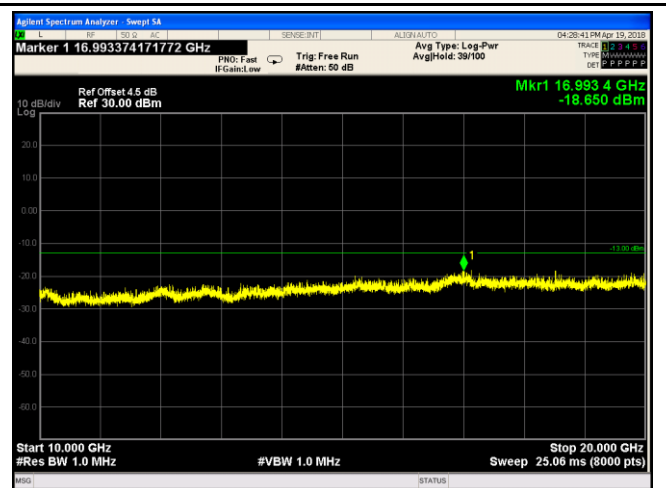

Band IV - High Channel-2

HSUPA:
UMTS-FDD Band V (Part 22H)

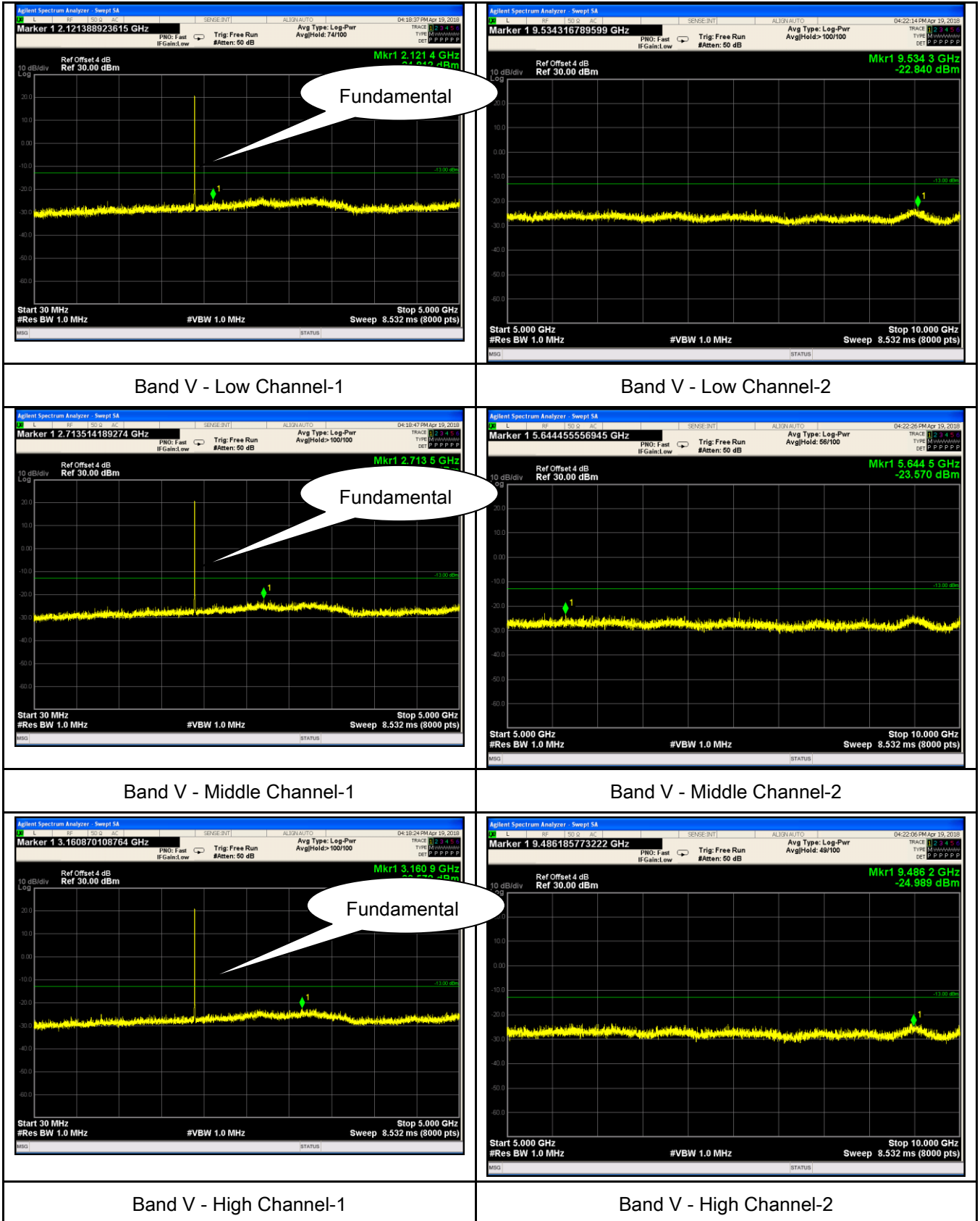

UMTS-FDD Band II (Part 24E)

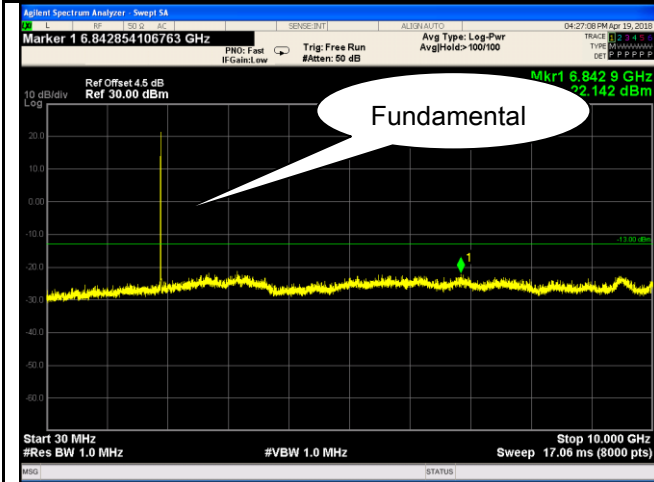

Band II - Low Channel-1

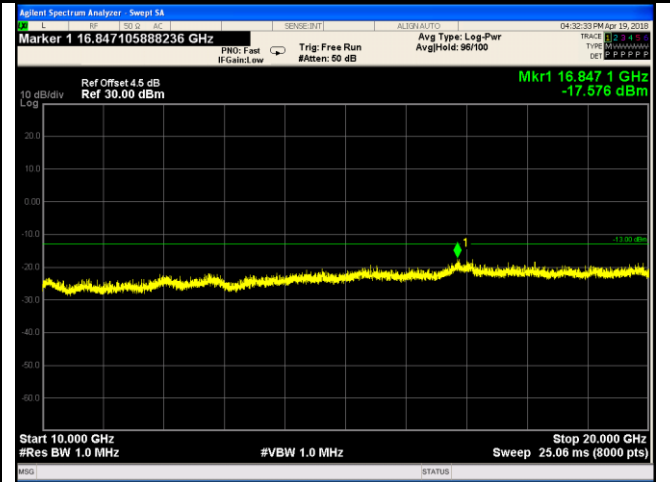

Band II - Low Channel-2

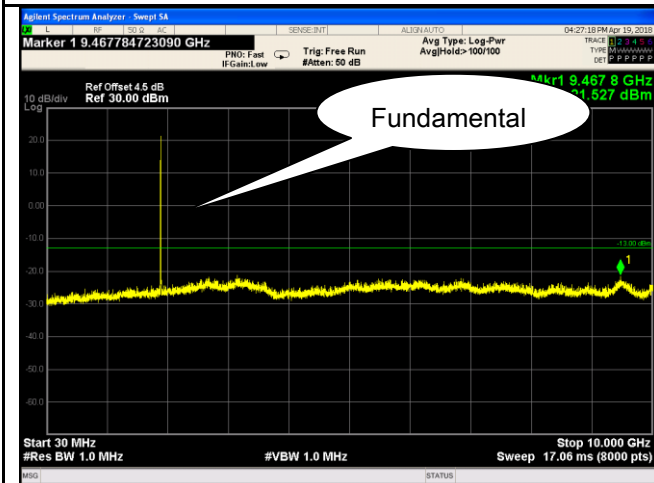

Band II - Middle Channel-1

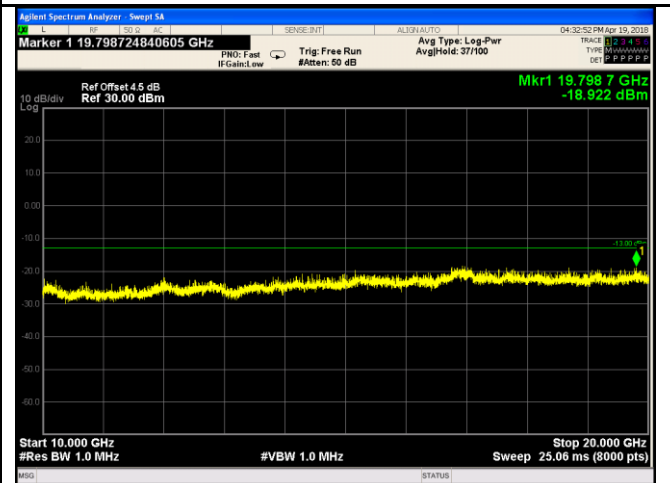

Band II - Middle Channel-2

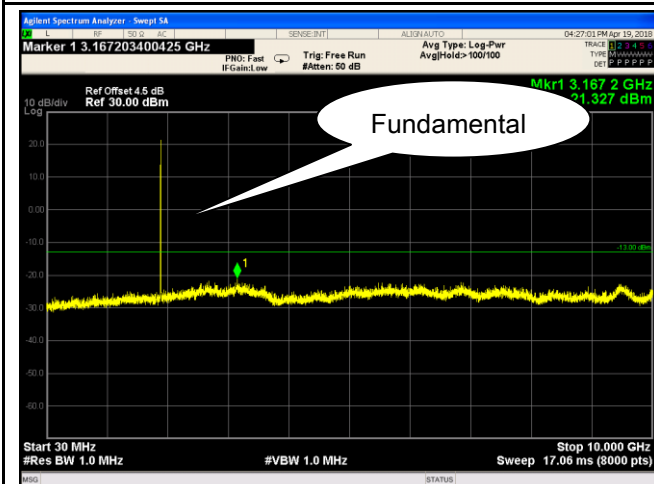

Band II - High Channel-1

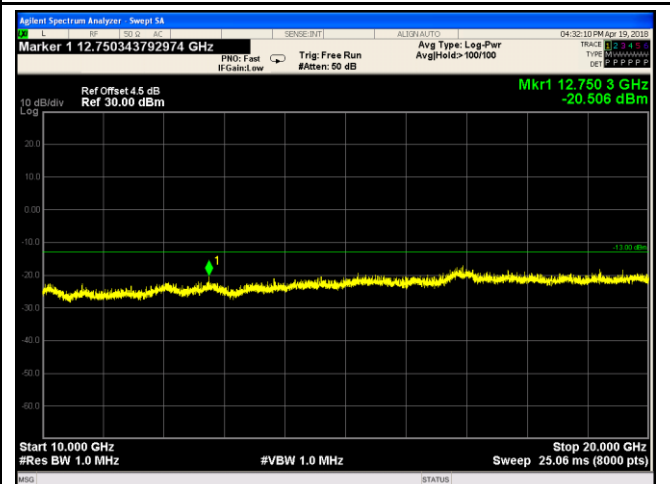

Band II - High Channel-2

UMTS-FDD Band IV (Part 27)

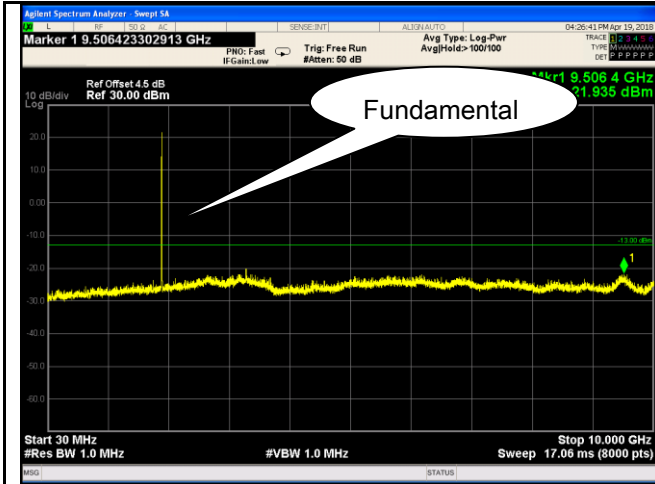

Band IV - Low Channel-1

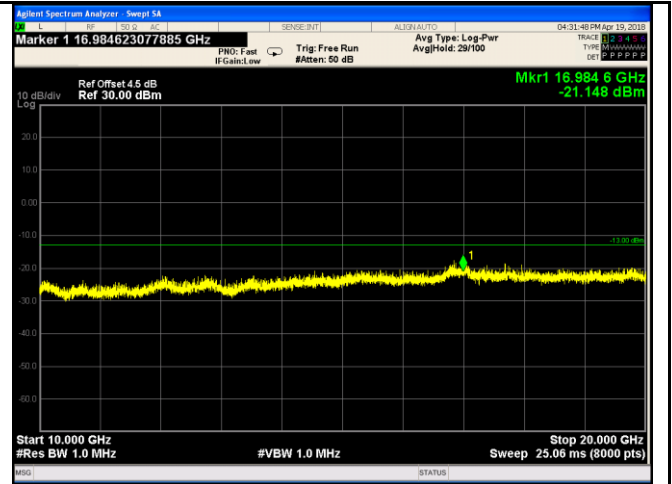

Band IV - Low Channel-2

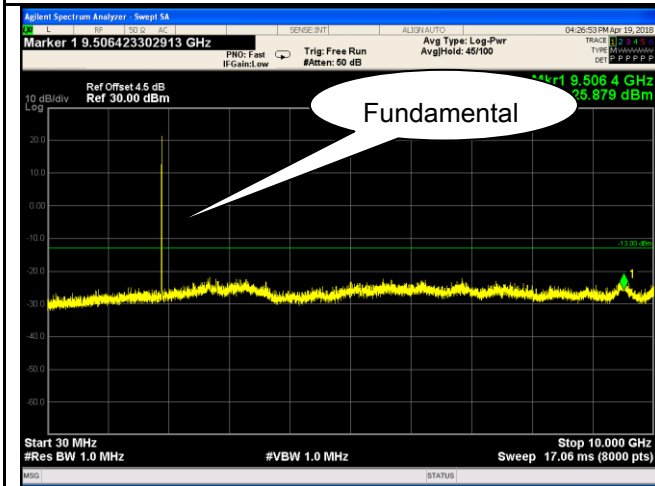

Band IV - Middle Channel-1

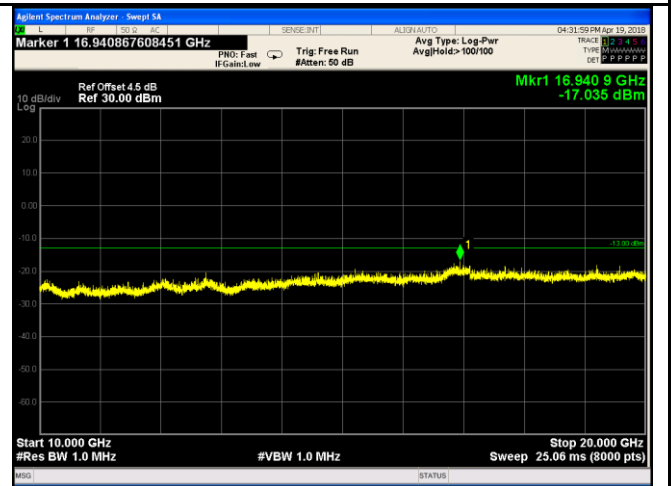

Band IV - Middle Channel-2

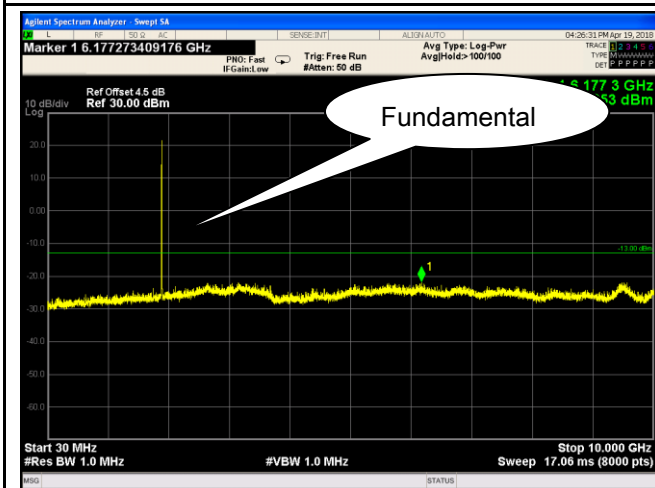

Band IV - High Channel-1

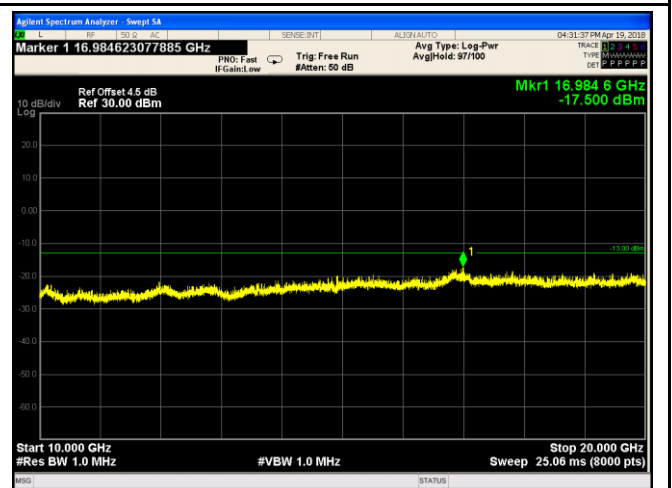

Band IV - High Channel-2

6.6 Spurious Radiated Emissions

| | |
|----------------------|----------------|
| Temperature | 25°C |
| Relative Humidity | 57% |
| Atmospheric Pressure | 1015mbar |
| Test date : | April 19, 2018 |
| Tested By : | Aaron Liang |

Requirement(s):

| Spec | Item | Requirement | Applicable |
|------------------------------------------------|------|---------------------------------------------------------------------------------------------------------------------------------------------------------------------------------------------------------------------------------------------------------------------|-------------------------------------|
| §2.1053, §22.917 & §24.238 § 27.53(h) | a) | The power of any emission outside of the authorized operating frequency ranges must be attenuated below the transmitter power (P) by a factor of at least $43 + 10 \log (P)$ dB. The spectrum is scanned from 30 MHz up to a frequency including its 10th harmonic. | <input checked="" type="checkbox"/> |

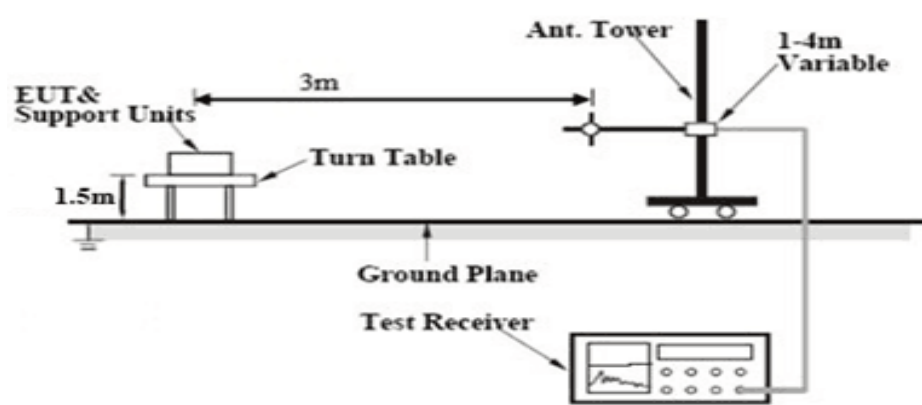
| | |
|------------|--------------------------------------------------------------------------------------|
| Test setup |  |
|------------|--------------------------------------------------------------------------------------|

| | |
|----------------|---------------------------------------------------------------------------------------------------------------------------------------------------------------------------------------------------------------------------------------------------------------------------------------------------------------------------------------------------------------------------------------------------------------------------------------------------------------------------------------------------------------------------------------------------------------------------------------------------------------------------------------------------------------------------------------------------------------------------------------------------------------------------------------------------------------------------------------------------------------------------------------------------------------------------------------|
| Test Procedure | <ol style="list-style-type: none"> The transmitter was placed on a wooden turntable, and it was transmitting into a non-radiating load which was also placed on the turntable. The measurement antenna was placed at a distance of 3 meters from the EUT. During the tests, the antenna height and polarization as well as EUT azimuth were varied in order to identify the maximum level of emissions from the EUT. The test was performed by placing the EUT on 3-orthogonal axis. Remove the EUT and replace it with substitution antenna. A signal generator was connected to the substitution antenna by a non-radiating cable. The absolute levels of the spurious emissions were measured by the substitution. <p>Sample Calculation:</p> <p>EUT Field Strength = Raw Amplitude (dBµV/m) – Amplifier Gain (dB) + Antenna Factor (dB) + Cable Loss (dB) + Filter Attenuation (dB, if used)</p> |
|----------------|---------------------------------------------------------------------------------------------------------------------------------------------------------------------------------------------------------------------------------------------------------------------------------------------------------------------------------------------------------------------------------------------------------------------------------------------------------------------------------------------------------------------------------------------------------------------------------------------------------------------------------------------------------------------------------------------------------------------------------------------------------------------------------------------------------------------------------------------------------------------------------------------------------------------------------------|

| | |
|-------------|-----------------|
| Test Report | 18070322-FCC-R1 |
| Page | 62 of 105 |

| | |
|--------|------------------------------------------------------------------------|
| Remark | |
| Result | <input checked="" type="checkbox"/> Pass <input type="checkbox"/> Fail |

Test Data Yes N/A
 Test Plot Yes (See below) N/A

Cellular Band (Part 22H) result

Low channel

| Frequency (MHz) | Antenna Polarization (H/V) | Corrected Reading (dBm) | Limit (dBm) | Margin (dB) |
|--------------------|----------------------------------|-------------------------------|----------------|----------------|
| 1648.4 | V | -30.28 | -13 | -17.28 |
| 1648.4 | H | -30.37 | -13 | -17.37 |
| 340.21 | V | -33.87 | -13 | -20.87 |
| 280.79 | H | -35.25 | -13 | -22.25 |

Middle channel

| Frequency (MHz) | Antenna Polarization (H/V) | Corrected Reading (dBm) | Limit (dBm) | Margin (dB) |
|--------------------|----------------------------------|-------------------------------|----------------|----------------|
| 1673.2 | V | -30.99 | -13 | -17.99 |
| 1673.2 | H | -24.58 | -13 | -11.58 |
| 540.62 | V | -37.73 | -13 | -24.73 |
| 233.38 | H | -41.25 | -13 | -28.25 |

High channel

| Frequency (MHz) | Antenna Polarization (H/V) | Corrected Reading (dBm) | Limit (dBm) | Margin (dB) |
|--------------------|----------------------------------|-------------------------------|----------------|----------------|
| 1697.6 | V | -28.43 | -13 | -15.43 |
| 1697.6 | H | -24.54 | -13 | -11.54 |
| 397.85 | V | -33.63 | -13 | -20.63 |
| 204.55 | H | -40.75 | -13 | -27.75 |

Note:

- 1, The testing has been conformed to $10 \times 848.8 \text{MHz} = 8,488 \text{MHz}$
- 2, All other emissions more than 30 dB below the limit
- 3, GSM voice, EGPRS and GPRS mode were investigated. The results above show only the worse cases
- 4, X-Axis, Y-Axis and Z-Axis were investigated. The results above show only the worst case.

PCS Band (Part24E) result

Low channel

| Frequency (MHz) | Antenna Polarization (H/V) | Corrected Reading (dBm) | Limit (dBm) | Margin (dB) |
|--------------------|----------------------------------|-------------------------------|----------------|----------------|
| 3700.4 | V | -33.75 | -13 | -20.75 |
| 3700.4 | H | -38.55 | -13 | -25.55 |
| 552.92 | V | -40.76 | -13 | -27.76 |
| 629.52 | H | -34.82 | -13 | -21.82 |

Middle channel

| Frequency (MHz) | Antenna Polarization (H/V) | Corrected Reading (dBm) | Limit (dBm) | Margin (dB) |
|--------------------|----------------------------------|-------------------------------|----------------|----------------|
| 3760 | V | -33.63 | -13 | -20.63 |
| 3760 | H | -36.87 | -13 | -23.87 |
| 572.41 | V | -35.81 | -13 | -22.81 |
| 697.32 | H | -36.21 | -13 | -23.21 |

High channel

| Frequency (MHz) | Antenna Polarization (H/V) | Corrected Reading (dBm) | Limit (dBm) | Margin (dB) |
|--------------------|----------------------------------|-------------------------------|----------------|----------------|
| 3819.6 | V | -33.94 | -13 | -20.94 |
| 3819.6 | H | -29.66 | -13 | -16.66 |
| 239.74 | V | -42.59 | -13 | -29.59 |
| 406.08 | H | -36.88 | -13 | -23.88 |

Note:

- 1, The testing has been conformed to $10 \times 1909.8 \text{MHz} = 19,098 \text{MHz}$
- 2, All other emissions more than 30 dB below the limit
- 3, GSM voice, EGPRS and GPRS mode were investigated. The results above show only the worse cases
- 4, X-Axis, Y-Axis and Z-Axis were investigated. The results above show only the worst case.
- 5, The radiated spurious test above 18GHz is subcontracted to SIEMIC (Nanjing-China) Laboratories. and found 30dB below the limit at least.

UMTS-FDD Band V (Part 22H)

Low channel

| Frequency (MHz) | Antenna Polarization (H/V) | Corrected Reading (dBm) | Limit (dBm) | Margin (dB) |
|--------------------|----------------------------------|-------------------------------|----------------|----------------|
| 1652.8 | V | -35.05 | -13 | -22.05 |
| 1652.8 | H | -26.27 | -13 | -13.27 |
| 518.12 | V | -37.22 | -13 | -24.22 |
| 302.32 | H | -41.95 | -13 | -28.95 |

Middle channel

| Frequency (MHz) | Antenna Polarization (H/V) | Corrected Reading (dBm) | Limit (dBm) | Margin (dB) |
|--------------------|----------------------------------|-------------------------------|----------------|----------------|
| 1670 | V | -27.42 | -13 | -14.42 |
| 1670 | H | -26.68 | -13 | -13.68 |
| 776.39 | V | -42 | -13 | -29 |
| 317.57 | H | -41.34 | -13 | -28.34 |

High channel

| Frequency (MHz) | Antenna Polarization (H/V) | Corrected Reading (dBm) | Limit (dBm) | Margin (dB) |
|--------------------|----------------------------------|-------------------------------|----------------|----------------|
| 1693.2 | V | -35.94 | -13 | -22.94 |
| 1693.2 | H | -31.15 | -13 | -18.15 |
| 475.28 | V | -34.96 | -13 | -21.96 |
| 737.6 | H | -36.01 | -13 | -23.01 |

Note:

- 1, The testing has been conformed to $10 \times 846.6 \text{ MHz} = 8,466 \text{ MHz}$
- 2, All other emissions more than 30 dB below the limit
- 3, RMC, HSUPA and HSDPA mode were investigated. The results above show only the worse cases
- 4, X-Axis, Y-Axis and Z-Axis were investigated. The results above show only the worst case.

UMTS-FDD Band II (Part 24E)

Low channel

| Frequency (MHz) | Antenna Polarization (H/V) | Corrected Reading (dBm) | Limit (dBm) | Margin (dB) |
|--------------------|----------------------------------|-------------------------------|----------------|----------------|
| 3704.8 | V | -34.94 | -13 | -21.94 |
| 3704.8 | H | -36.8 | -13 | -23.8 |
| 728.25 | V | -36.59 | -13 | -23.59 |
| 309.63 | H | -40.18 | -13 | -27.18 |

Middle channel

| Frequency (MHz) | Antenna Polarization (H/V) | Corrected Reading (dBm) | Limit (dBm) | Margin (dB) |
|--------------------|----------------------------------|-------------------------------|----------------|----------------|
| 3760 | V | -34.08 | -13 | -21.08 |
| 3760 | H | -32.26 | -13 | -19.26 |
| 441.32 | V | -42.63 | -13 | -29.63 |
| 309.86 | H | -38.95 | -13 | -25.95 |

High channel

| Frequency (MHz) | Antenna Polarization (H/V) | Corrected Reading (dBm) | Limit (dBm) | Margin (dB) |
|--------------------|----------------------------------|-------------------------------|----------------|----------------|
| 3815.2 | V | -31.75 | -13 | -18.75 |
| 3815.2 | H | -35.69 | -13 | -22.69 |
| 785.12 | V | -34.95 | -13 | -21.95 |
| 618.2 | H | -40.11 | -13 | -27.11 |

Note:

1, The testing has been conformed to $10 \times 1907.6 \text{MHz} = 19,076 \text{MHz}$

2, All other emissions more than 30 dB below the limit

3, RMC, HSUPA and HSDPA mode were investigated. The results above show only the worse cases

4, X-Axis, Y-Axis and Z-Axis were investigated. The results above show only the worst case

5, The radiated spurious test above 18GHz is subcontracted to SIEMIC (Nanjing-China) Laboratories. and found 30dB below the limit at least.

UMTS-FDD Band IV (Part 27)

Low channel

| Frequency (MHz) | Antenna Polarization (H/V) | Corrected Reading (dBm) | Limit (dBm) | Margin (dB) |
|--------------------|----------------------------------|-------------------------------|----------------|----------------|
| 3424.8 | V | -32.14 | -13 | -19.14 |
| 3424.8 | H | -27.76 | -13 | -14.76 |
| 715.03 | V | -38.91 | -13 | -25.91 |
| 687.47 | H | -39.05 | -13 | -26.05 |

Middle channel

| Frequency (MHz) | Antenna Polarization (H/V) | Corrected Reading (dBm) | Limit (dBm) | Margin (dB) |
|--------------------|----------------------------------|-------------------------------|----------------|----------------|
| 3480 | V | -32.36 | -13 | -19.36 |
| 3480 | H | -28.15 | -13 | -15.15 |
| 496.2 | V | -34.59 | -13 | -21.59 |
| 327.91 | H | -41.81 | -13 | -28.81 |

High channel

| Frequency (MHz) | Antenna Polarization (H/V) | Corrected Reading (dBm) | Limit (dBm) | Margin (dB) |
|--------------------|----------------------------------|-------------------------------|----------------|----------------|
| 3505.2 | V | -23.38 | -13 | -10.38 |
| 3505.2 | H | -29.68 | -13 | -16.68 |
| 407.19 | V | -39.31 | -13 | -26.31 |
| 419.37 | H | -42.23 | -13 | -29.23 |

Note:

- 1, The testing has been conformed to $10 \times 1752.6 \text{ MHz} = 17,526 \text{ MHz}$
- 2, All other emissions more than 30 dB below the limit
- 3, RMC, HSUPA and HSDPA mode were investigated. The results above show only the worse cases.
- 4, X-Axis, Y-Axis and Z-Axis were investigated. The results above show only the worst case.

6.7 Band Edge

| | |
|----------------------|----------------|
| Temperature | 25°C |
| Relative Humidity | 57% |
| Atmospheric Pressure | 1015mbar |
| Test date : | April 19, 2018 |
| Tested By : | Aaron Liang |

Requirement(s):

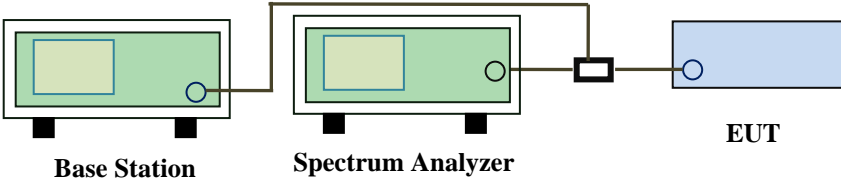
| Spec | Item | Requirement | Applicable |
|----------------------------------------|------------------------------------------------------------------------------------------------------------------------------------------------------------------------------------------------------------------------------------------------------------------------------------------------------------------------------------------------------------------------------------------------------------------------|----------------------------------------------------------------------------------------------------------------------------------------------------------------------------|-------------------------------------|
| §22.917(a) §24.238(a) § 27.53(h) | a) | The power of any emission outside of the authorized operating frequency ranges must be lower than the transmitter power (P) by a factor of at least $43 + 10 \log (P)$ dB. | <input checked="" type="checkbox"/> |
| Test setup |  <p>The diagram shows a Base Station (green box) connected to a Spectrum Analyzer (green box) and an EUT (blue box) via a power divider (black box). The Base Station and Spectrum Analyzer are connected to each other, and the Spectrum Analyzer is connected to the power divider, which then splits the signal to the EUT.</p> | | |
| Procedure | <ul style="list-style-type: none"> - The EUT was connected to Spectrum Analyzer and Base Station via power divider. - The Band Edges of low and high channels for the highest RF powers were measured. Setting RBW as roughly BW/100. | | |
| Remark | | | |
| Result | <input checked="" type="checkbox"/> Pass <input type="checkbox"/> Fail | | |

Test Data Yes N/A
 Test Plot Yes (See below) N/A

GSM Voice:

Cellular Band (Part 22H) result

| Frequency (MHz) | Emission (dBm) | Limit (dBm) |
|-----------------|----------------|-------------|
| 823.990 | -15.835 | -13 |
| 849.023 | -17.728 | -13 |

PCS Band (Part24E) result

| Frequency (MHz) | Emission (dBm) | Limit (dBm) |
|-----------------|----------------|-------------|
| 1849.996 | -14.259 | -13 |
| 1910.020 | -15.363 | -13 |

GPRS:

Cellular Band (Part 22H) result

| Frequency (MHz) | Emission (dBm) | Limit (dBm) |
|-----------------|----------------|-------------|
| 823.990 | -14.377 | -13 |
| 849.023 | -13.248 | -13 |

PCS Band (Part24E) result

| Frequency (MHz) | Emission (dBm) | Limit (dBm) |
|-----------------|----------------|-------------|
| 1849.982 | -17.351 | -13 |
| 1910.021 | -16.921 | -13 |

EGPRS (MCS 1):

Cellular Band (Part 22H) result

| Frequency (MHz) | Emission (dBm) | Limit (dBm) |
|-----------------|----------------|-------------|
| 823.996 | -13.468 | -13 |
| 849.019 | -13.726 | -13 |

PCS Band (Part24E) result

| Frequency (MHz) | Emission (dBm) | Limit (dBm) |
|-----------------|----------------|-------------|
| 1849.997 | -14.518 | -13 |
| 1910.019 | -17.407 | -13 |

RMC:

UMTS-FDD Band V (Part 22H)

| Frequency (MHz) | Emission (dBm) | Limit (dBm) |
|-----------------|----------------|-------------|
| 823.89 | -27.730 | -13 |
| 849.94 | -28.049 | -13 |

UMTS-FDD Band II (Part 24E)

| Frequency (MHz) | Emission (dBm) | Limit (dBm) |
|-----------------|----------------|-------------|
| 1849.68 | -28.196 | -13 |
| 1910.34 | -32.446 | -13 |

UMTS-FDD Band IV (Part 27)

| Frequency (MHz) | Emission (dBm) | Limit (dBm) |
|-----------------|----------------|-------------|
| 1709.07 | -21.989 | -13 |
| 1755.10 | -25.114 | -13 |

HSDPA:

UMTS-FDD Band V (Part 22H)

| Frequency (MHz) | Emission (dBm) | Limit (dBm) |
|-----------------|----------------|-------------|
| 823.98 | -25.963 | -13 |
| 850.00 | -29.004 | -13 |

UMTS-FDD Band II (Part 24E)

| Frequency (MHz) | Emission (dBm) | Limit (dBm) |
|-----------------|----------------|-------------|
| 1849.160 | -27.350 | -13 |
| 1910.84 | -29.863 | -13 |

UMTS-FDD Band IV (Part 27)

| Frequency (MHz) | Emission (dBm) | Limit (dBm) |
|-----------------|----------------|-------------|
| 1708.98 | -23.906 | -13 |
| 1755.10 | -26.832 | -13 |

HSUPA:

UMTS-FDD Band V (Part 22H)

| Frequency (MHz) | Emission (dBm) | Limit (dBm) |
|-----------------|----------------|-------------|
| 823.96 | -26.496 | -13 |
| 849.94 | -28.049 | -13 |

UMTS-FDD Band II (Part 24E)

| Frequency (MHz) | Emission (dBm) | Limit (dBm) |
|-----------------|----------------|-------------|
| 1849.82 | -27.622 | -13 |
| 1910.34 | -29.516 | -13 |

UMTS-FDD Band IV (Part 27)

| Frequency (MHz) | Emission (dBm) | Limit (dBm) |
|-----------------|----------------|-------------|
| 1709.02 | -23.755 | -13 |
| 1755.11 | -25.218 | -13 |

**GSM Voice:
Test Plots**

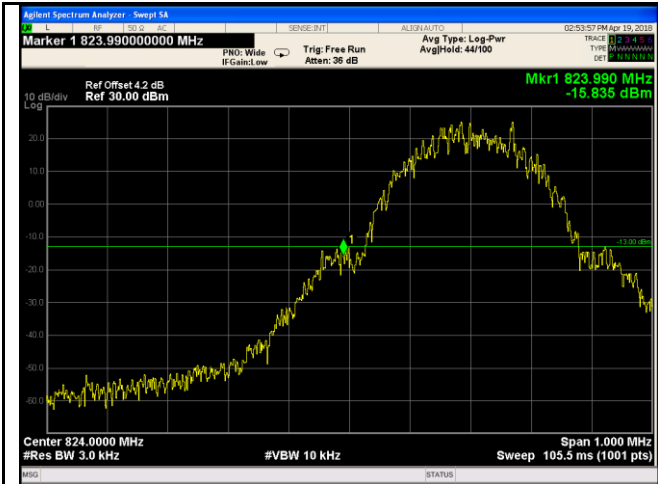

Cellular Band - Low Channel

Note: Offset=Cable loss (4.0) + 10log
(3.15/3)=4.0+0.2=4.1dB

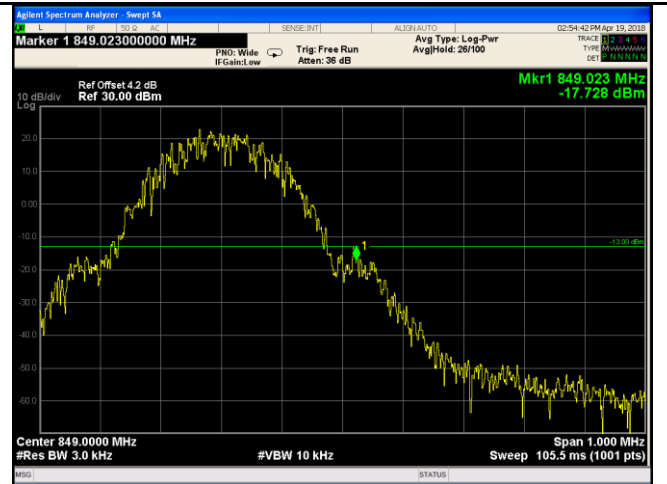

Cellular Band - High Channel

Note: Offset=Cable loss (4.0) + 10log
(3.15/3)=4.0+0.2=4.2dB

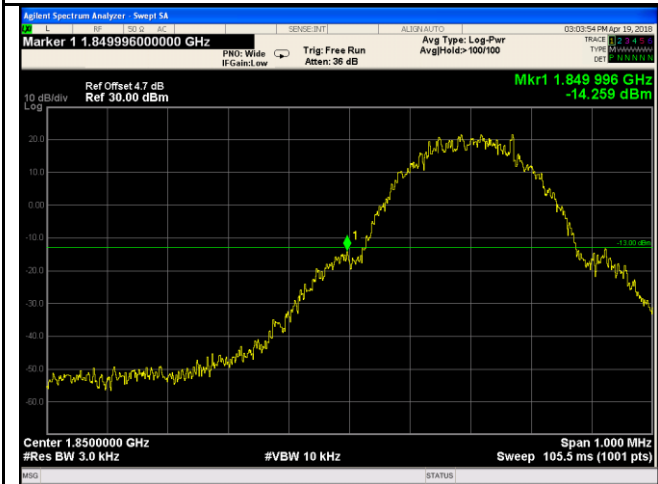

PCS Band - Low Channel

Note: Offset=Cable loss (4.0) + 10log
(3.14/3)=4.5+0.2=4.7dB

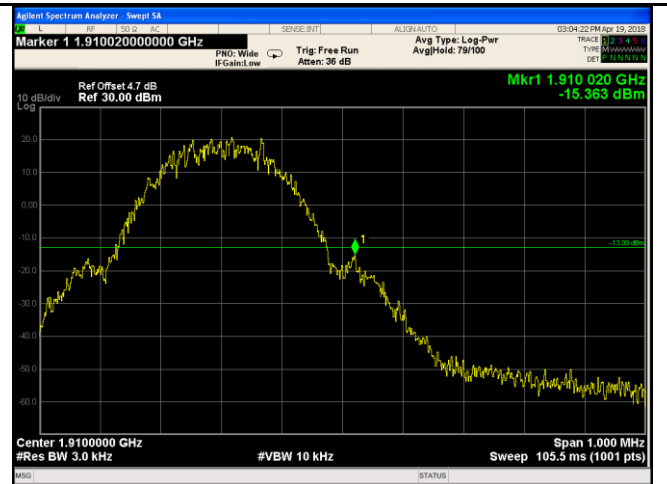

PCS Band - High Channel

Note: Offset=Cable loss (4.0) + 10log
(3.14/3)=4.5+0.2=4.7dB

GPRS:

Test Plots

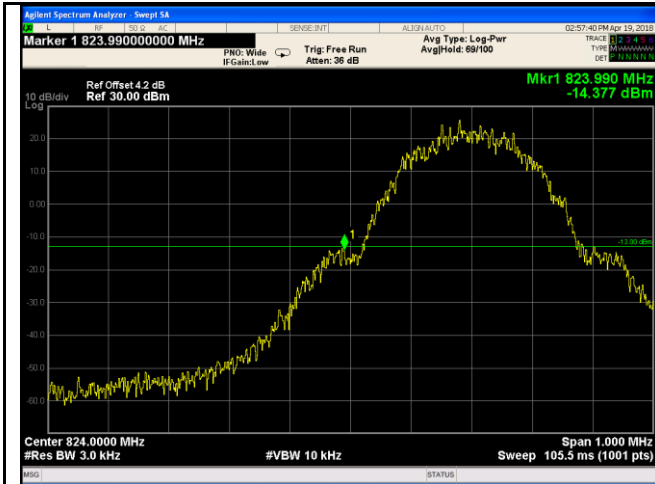

Cellular Band - Low Channel

Note: Offset=Cable loss (4.0) + 10log
 $(3.17/3)=4.0+0.2=4.2\text{dB}$



Cellular Band - High Channel

Note: Offset=Cable loss (4.0) + 10log
 $(3.16/3)=4.0+0.2=4.2\text{dB}$

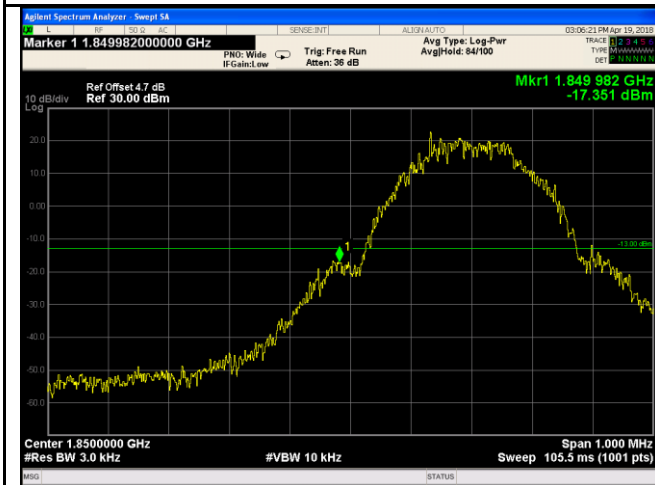

PCS Band - Low Channel

Note: Offset=Cable loss (4.5) + 10log
 $(3.14/3)=4.5+0.2=4.7\text{dB}$

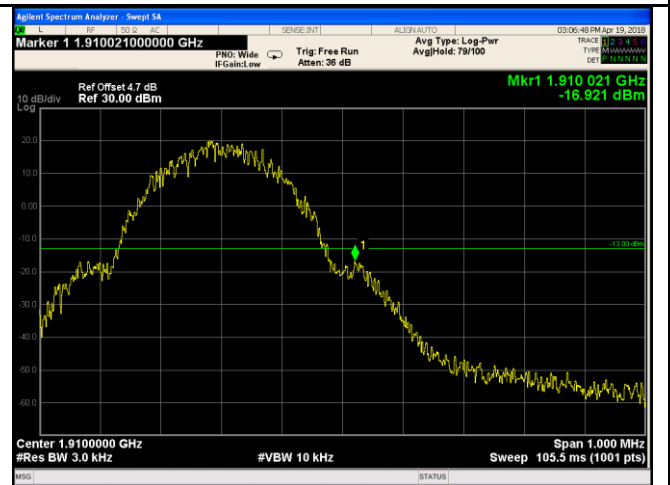

PCS Band - High Channel

Note: Offset=Cable loss (4.5) + 10log
 $(3.17/3)=4.5+0.2=4.7\text{dB}$

EGPRS (MCS1):

Test Plots

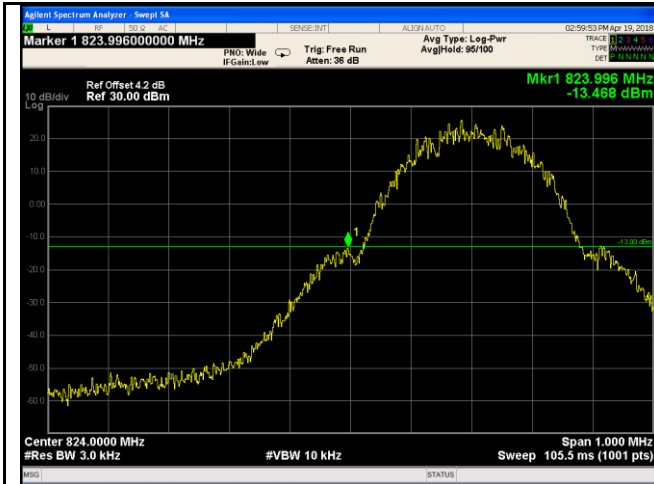

Cellular Band - Low Channel

Note: Offset=Cable loss (4.0) + 10log
 (3.17/3)=4.0+0.2=4.2dB

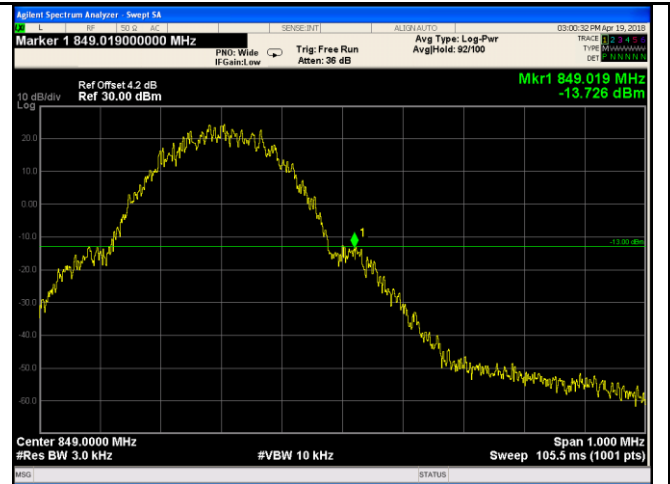

Cellular Band - High Channel

Note: Offset=Cable loss (4.0) + 10log
 (3.19/3)=4.0+0.2=4.2dB

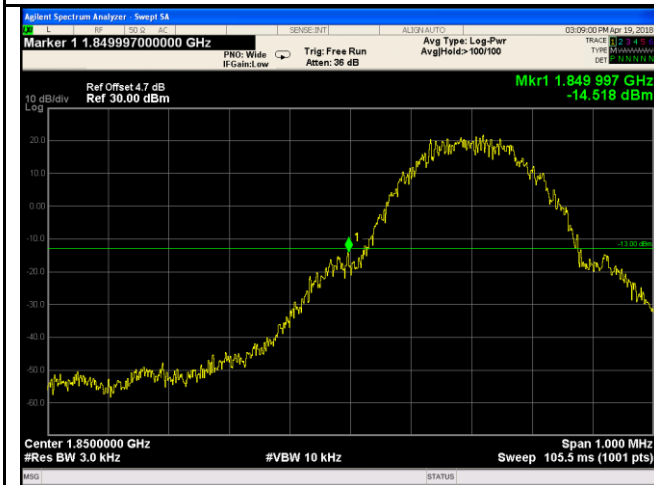

PCS Band - Low Channel

Note: Offset=Cable loss (4.5) + 10log
 (3.19/3)=4.5+0.2=4.7dB

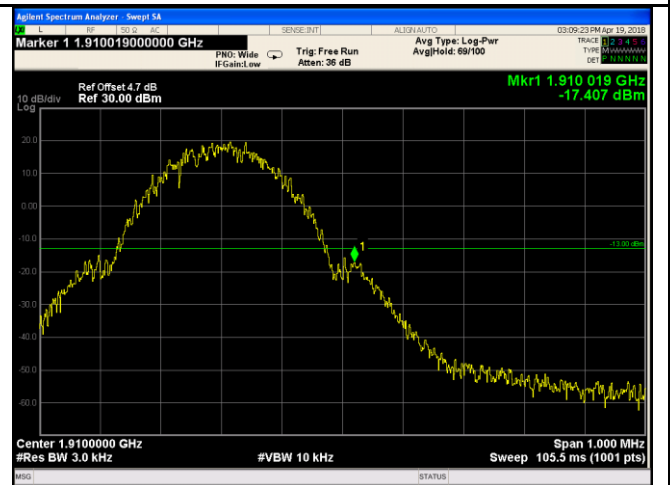

PCS Band - High Channel

Note: Offset=Cable loss (4.5) + 10log
 (3.09/3)=4.5+0.2=4.7dB

RMC:

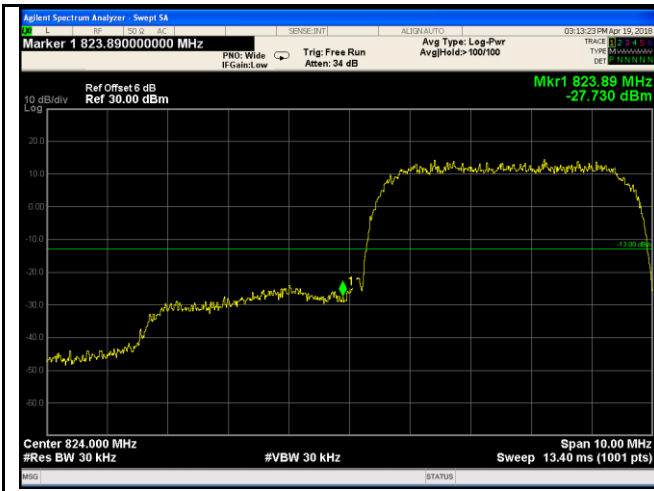

UMTS-FDD Band V - Low Channel

Note: Offset=Cable loss (4.0) + 10log
(46.73/30)=4.0+1.9=6.0dB

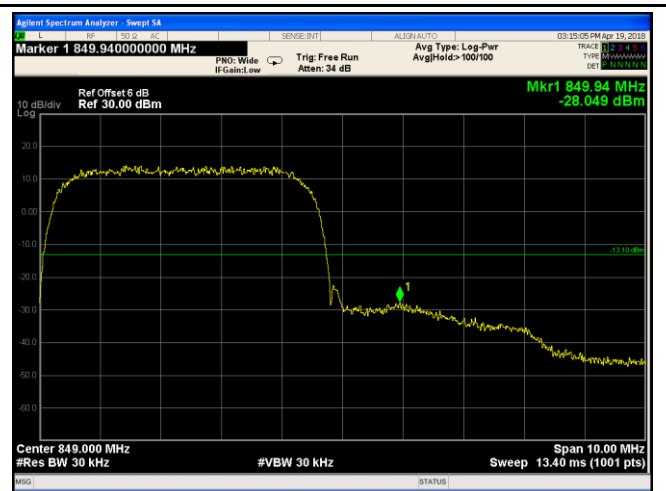

UMTS-FDD Band V - High Channel

Note: Offset=Cable loss (4.0) + 10log
(46.53/30)=4.0+2.0=6.0dB



UMTS-FDD Band II - Low Channel

Note: Offset=Cable loss (4.5) + 10log
(46.73/30)=4.5+2.0=6.5 dB

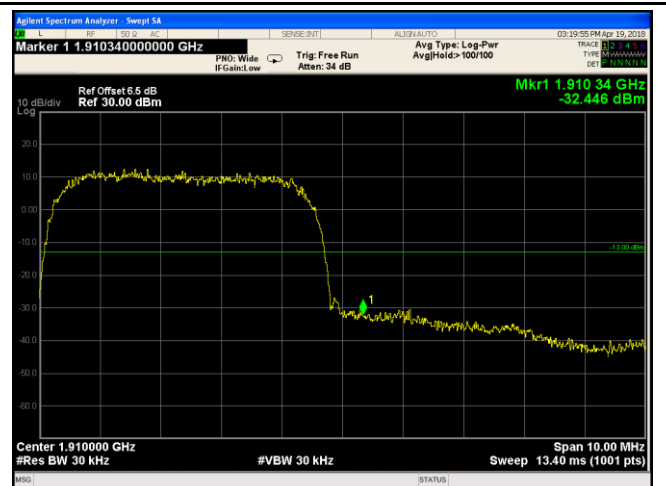

UMTS-FDD Band II - High Channel

Note: Offset=Cable loss (4.5) + 10log
(46.47/30)=4.5+2.0=6.5 dB

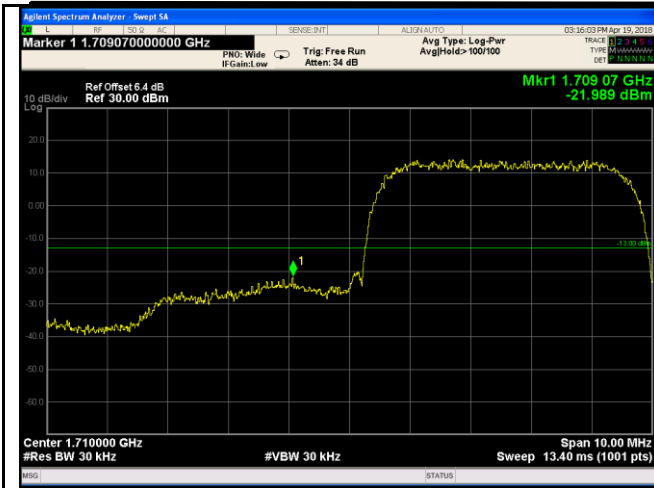

UMTS-FDD Band IV - Low Channel

Note: Offset=Cable loss (4.5) + 10log
 (46.79/30)=4.5+1.9=6.4 dB

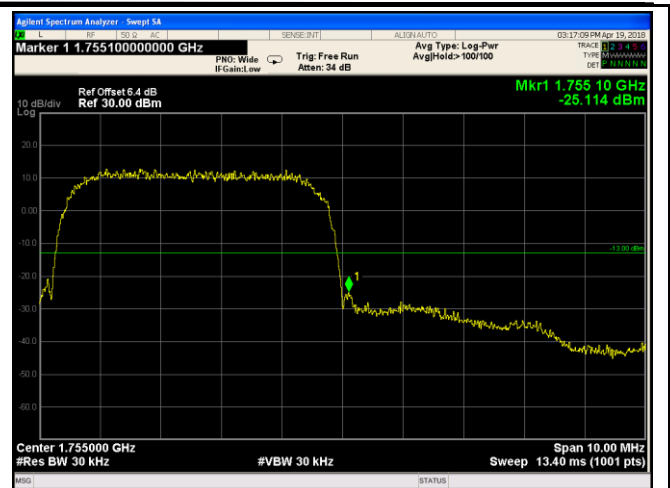

UMTS-FDD Band IV - High Channel

Note: Offset=Cable loss (4.0) + 10log
 (4669/30)=4.5+1.9=6.4 dB

HSDPA:

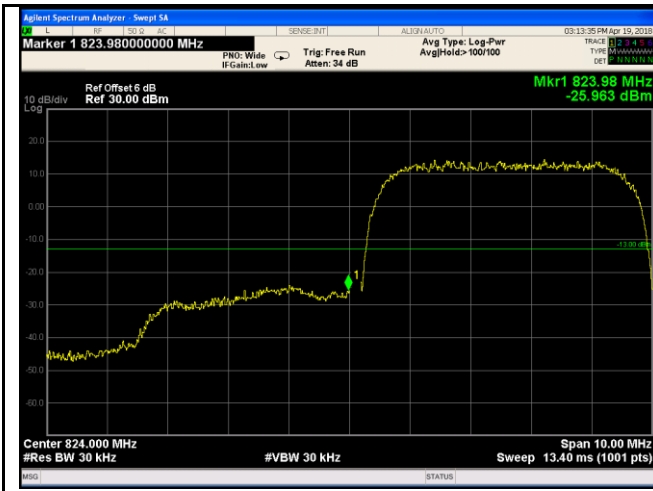

UMTS-FDD Band V - Low Channel



UMTS-FDD Band V - High Channel

Note: Offset=Cable loss (4.0) + 10log
(46.59/30)=4.0+2.0=6dB

Note: Offset=Cable loss (4.0) + 10log
(46.55/30)=4.0+2.0=6dB



UMTS-FDD Band II - Low Channel

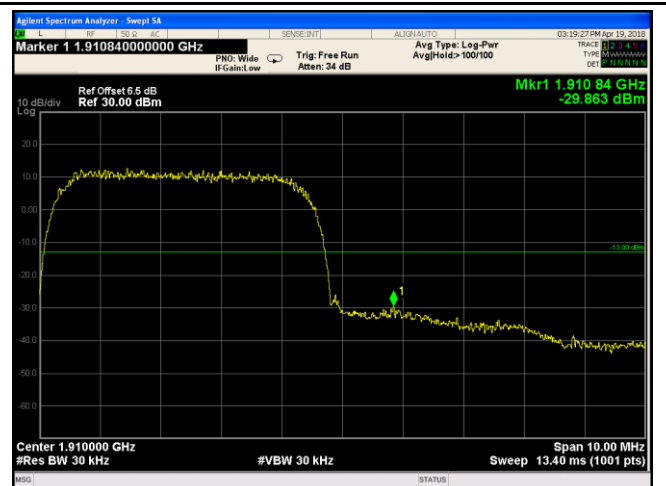

UMTS-FDD Band II - High Channel

Note: Offset=Cable loss (4.5) + 10log
(46.66/30)=4.5+2.0=6.5dB

Note: Offset=Cable loss (4.5) + 10log
(46.67/30)=4.5+2.0=6.5 dB

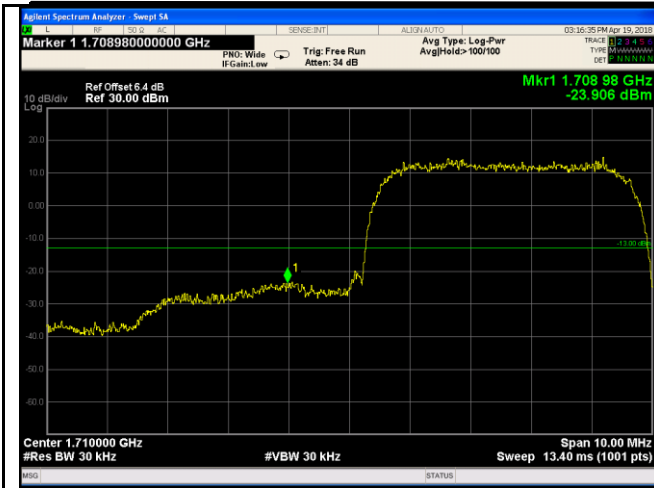

UMTS-FDD Band IV - Low Channel

Note: Offset=Cable loss (4.5) + 10log
 (46.66/30)=4.5+1.9=6.4 dB

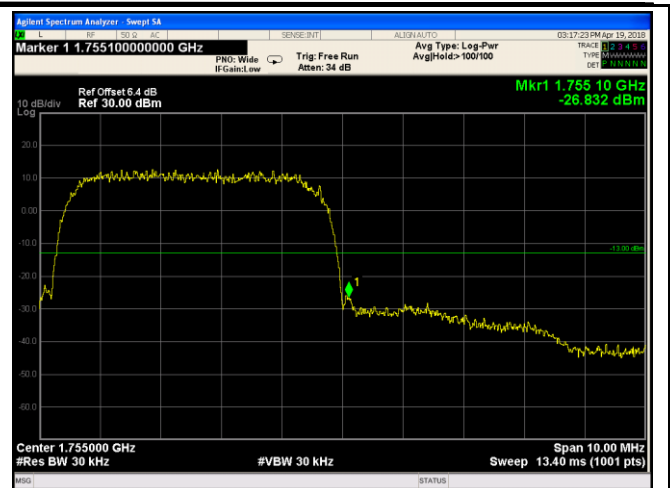

UMTS-FDD Band IV - High Channel

Note: Offset=Cable loss (4.0) + 10log
 (46.86/30)=4.5+1.9=6.4 dB

HSUPA:

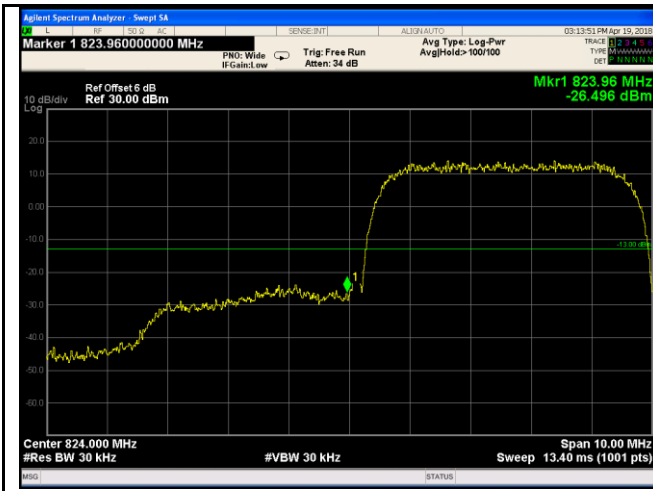

UMTS-FDD Band V - Low Channel

Note: Offset=Cable loss (4.0) + 10log
(46.49/30)=4.0+2.0=6 dB

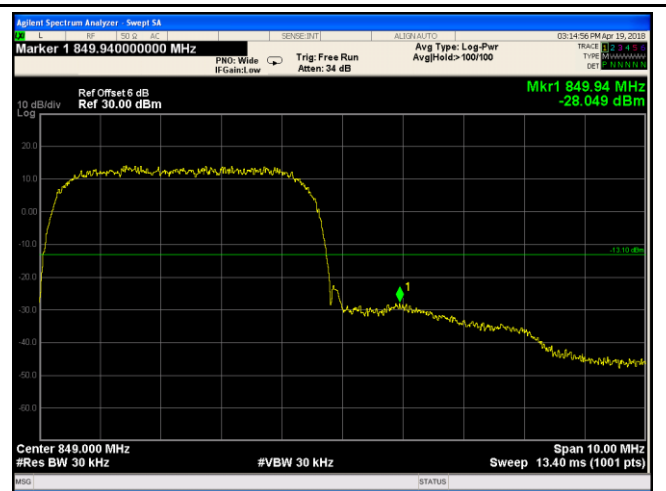

UMTS-FDD Band V - High Channel

Note: Offset=Cable loss (4.0) + 10log
(46.66/30)=4.0+2.0=6dB

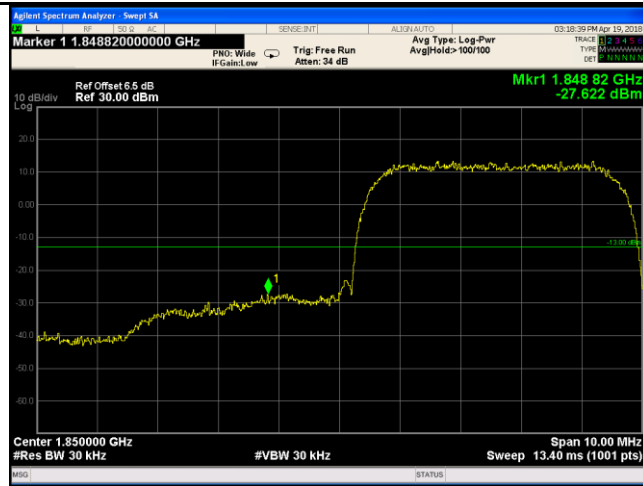

UMTS-FDD Band II - Low Channel

Note: Offset=Cable loss (4.5) + 10log
(46.66/30)=4.5+2.0=6.5dB

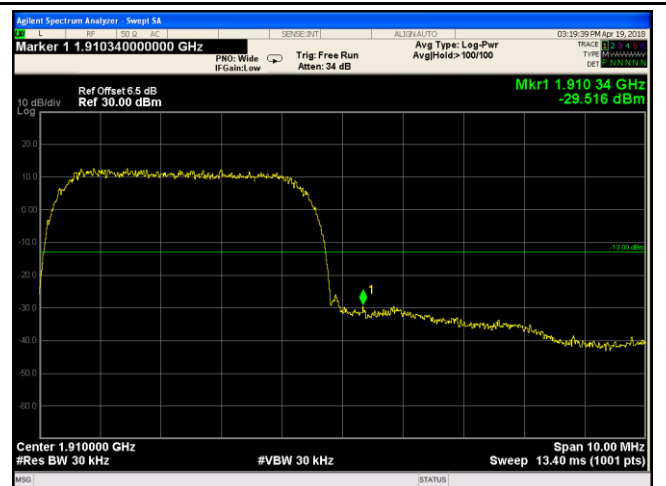

UMTS-FDD Band II - High Channel

Note: Offset=Cable loss (4.5) + 10log
(46.64/30)=4.5+2.0=6.5 dB

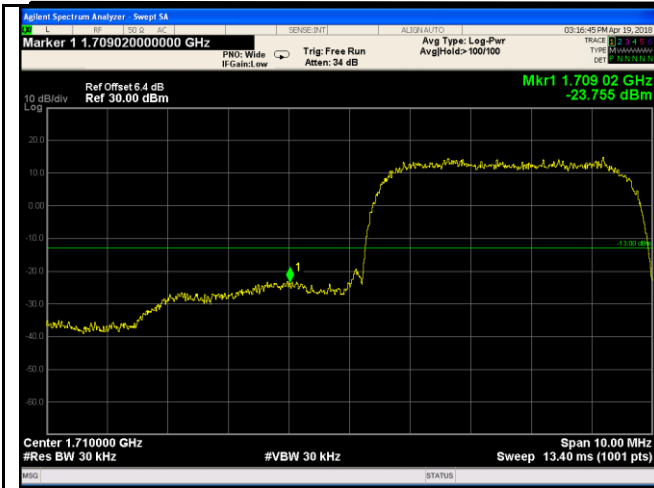

UMTS-FDD Band IV - Low Channel

Note: Offset=Cable loss (4.5) + 10log
 (46.70/30)=4.5+1.9=6.4 dB

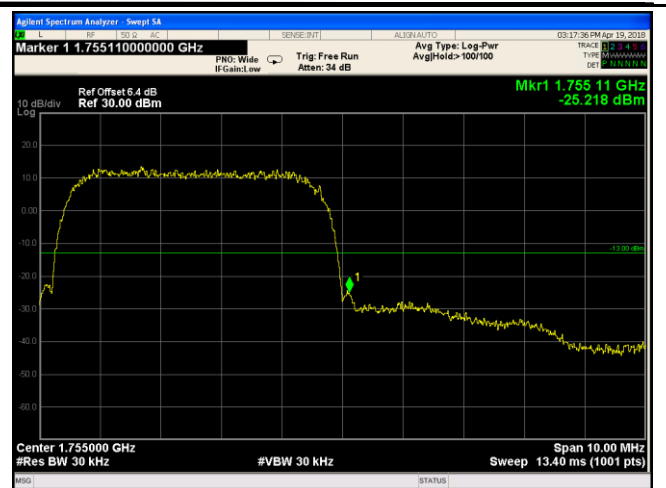

UMTS-FDD Band IV - High Channel

Note: Offset=Cable loss (4.0) + 10log
 (46.79/30)=4.5+1.9=6.4 dB

6.8 Frequency Stability

| | |
|----------------------|----------------|
| Temperature | 25°C |
| Relative Humidity | 57% |
| Atmospheric Pressure | 1015mbar |
| Test date : | April 19, 2018 |
| Tested By : | Aaron Liang |

Requirement(s):

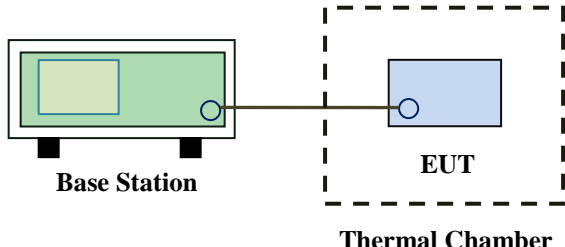
| Spec | Item | Requirement | Applicable | | | | | | | | | | | | | | | | | | | | | | | | | | | | | | | | |
|-----------------------------------------------------------|------|-------------------------------------------------------------------------------------------------------------------------------------------------------------------------------------------------------------------------------------------------------------------------------------------------------------------------------------------------------------------------------------------------------------------------------------------------------------------------------------------------------------------------------------------------------------------------------------------------------------------------------------------------------------------------------------------------------------------------------------------------------------------------------------------------------------------------------------------------------------------------------------------------------------------------------------------------------------------------------------------------------------------------------------------------------------------------------------------------------------------------------|-----------------------|------------------------|------------------------|------------------------|----------|------|------|------|-----------|-----|-----|------|------------|-----|-----|------|------------|-----|-----|-----|------------|-----|-----|-----|------------|-----|-----|-----|--------------|------|-----|-----|-------------------------------------|
| §2.1055, §22.355 & §24.235 § 27.5(h); § 27.54 | a) | <p>According to §22.355, the carrier frequency of each transmitter in the Public Mobile Services must be maintained within the tolerances given in Table below:</p> <p>Frequency Tolerance for Transmitters in the Public Mobile Services</p> <table border="1"> <thead> <tr> <th>Frequency Range (MHz)</th> <th>Base, fixed (ppm)</th> <th>Mobile ≤ 3 watts (ppm)</th> <th>Mobile ≤ 3 watts (ppm)</th> </tr> </thead> <tbody> <tr> <td>25 to 50</td> <td>20.0</td> <td>20.0</td> <td>50.0</td> </tr> <tr> <td>50 to 450</td> <td>5.0</td> <td>5.0</td> <td>50.0</td> </tr> <tr> <td>450 to 512</td> <td>2.5</td> <td>5.0</td> <td>10.0</td> </tr> <tr> <td>821 to 896</td> <td>1.5</td> <td>2.5</td> <td>2.5</td> </tr> <tr> <td>928 to 929</td> <td>5.0</td> <td>N/A</td> <td>N/A</td> </tr> <tr> <td>929 to 960</td> <td>1.5</td> <td>N/A</td> <td>N/A</td> </tr> <tr> <td>2110 to 2220</td> <td>10.0</td> <td>N/A</td> <td>N/A</td> </tr> </tbody> </table> <p>According to §24.235, the frequency stability shall be sufficient to ensure that the fundamental emissions stay within the authorized frequency block.</p> | Frequency Range (MHz) | Base, fixed (ppm) | Mobile ≤ 3 watts (ppm) | Mobile ≤ 3 watts (ppm) | 25 to 50 | 20.0 | 20.0 | 50.0 | 50 to 450 | 5.0 | 5.0 | 50.0 | 450 to 512 | 2.5 | 5.0 | 10.0 | 821 to 896 | 1.5 | 2.5 | 2.5 | 928 to 929 | 5.0 | N/A | N/A | 929 to 960 | 1.5 | N/A | N/A | 2110 to 2220 | 10.0 | N/A | N/A | <input checked="" type="checkbox"/> |
| | | Frequency Range (MHz) | Base, fixed (ppm) | Mobile ≤ 3 watts (ppm) | Mobile ≤ 3 watts (ppm) | | | | | | | | | | | | | | | | | | | | | | | | | | | | | | |
| 25 to 50 | 20.0 | 20.0 | 50.0 | | | | | | | | | | | | | | | | | | | | | | | | | | | | | | | | |
| 50 to 450 | 5.0 | 5.0 | 50.0 | | | | | | | | | | | | | | | | | | | | | | | | | | | | | | | | |
| 450 to 512 | 2.5 | 5.0 | 10.0 | | | | | | | | | | | | | | | | | | | | | | | | | | | | | | | | |
| 821 to 896 | 1.5 | 2.5 | 2.5 | | | | | | | | | | | | | | | | | | | | | | | | | | | | | | | | |
| 928 to 929 | 5.0 | N/A | N/A | | | | | | | | | | | | | | | | | | | | | | | | | | | | | | | | |
| 929 to 960 | 1.5 | N/A | N/A | | | | | | | | | | | | | | | | | | | | | | | | | | | | | | | | |
| 2110 to 2220 | 10.0 | N/A | N/A | | | | | | | | | | | | | | | | | | | | | | | | | | | | | | | | |
| Test setup | |  <p>The diagram illustrates the test setup. On the left, a green rectangular box labeled 'Base Station' is shown. A line connects it to a blue rectangular box labeled 'EUT' (Equipment Under Test) which is enclosed within a dashed-line box labeled 'Thermal Chamber'.</p> | | | | | | | | | | | | | | | | | | | | | | | | | | | | | | | | | |

| | |
|-------------|-----------------|
| Test Report | 18070322-FCC-R1 |
| Page | 83 of 105 |

| | |
|-----------|---------------------------------------------------------------------------------------------------------------------------------------------------------------------------------------------------------------------------------------------------------------------------------------------------------------------------------------------------------------------------------------------------|
| Procedure | <p>A communication link was established between EUT and base station. The frequency error was monitored and measured by base station under variation of ambient temperature and variation of primary supply voltage.</p> <p>Limit: The frequency stability of the transmitter shall be maintained within $\pm 0.00025\%$ ($\pm 2.5\text{ppm}$) of the center frequency.</p> |
| Remark | |
| Result | <input checked="" type="checkbox"/> Pass <input type="checkbox"/> Fail |

Test Data Yes N/A

Test Plot Yes (See below) N/A

GSM Voice:

Cellular Band (Part 22H) result

| Middle Channel, $f_0 = 836.6$ MHz | | | | |
|-----------------------------------|-----------------------------------|----------------------|-----------------------|-------------|
| Temperature (°C) | Power Supplied (V _{DC}) | Frequency Error (Hz) | Frequency Error (ppm) | Limit (ppm) |
| -10 | 3.8 | 19 | 0.0227 | 2.5 |
| 0 | | 17 | 0.0203 | 2.5 |
| 10 | | 17 | 0.0203 | 2.5 |
| 20 | | 13 | 0.0155 | 2.5 |
| 30 | | 16 | 0.0191 | 2.5 |
| 40 | | 17 | 0.0203 | 2.5 |
| 50 | | 22 | 0.0263 | 2.5 |
| 55 | | 18 | 0.0215 | 2.5 |
| 25 | 4.35 | 20 | 0.0239 | 2.5 |
| | 3.45 | 17 | 0.0203 | 2.5 |

PCS Band (Part 24E) result

| Middle Channel, $f_0 = 1880$ MHz | | | | |
|----------------------------------|-----------------------------------|----------------------|-----------------------|-------------|
| Temperature (°C) | Power Supplied (V _{DC}) | Frequency Error (Hz) | Frequency Error (ppm) | Limit (ppm) |
| -10 | 3.8 | 12 | 0.0064 | 2.5 |
| 0 | | 15 | 0.0080 | 2.5 |
| 10 | | 13 | 0.0069 | 2.5 |
| 20 | | 13 | 0.0069 | 2.5 |
| 30 | | 15 | 0.0080 | 2.5 |
| 40 | | 15 | 0.0080 | 2.5 |
| 50 | | 18 | 0.0096 | 2.5 |
| 55 | | 17 | 0.0090 | 2.5 |
| 25 | 4.35 | 18 | 0.0096 | 2.5 |
| | 3.45 | 19 | 0.0101 | 2.5 |

RMC:

UMTS-FDD Band V (Part 22H)

| Middle Channel, $f_0 = 835$ MHz | | | | |
|---------------------------------|-----------------------------------|----------------------|-----------------------|-------------|
| Temperature (°C) | Power Supplied (V _{DC}) | Frequency Error (Hz) | Frequency Error (ppm) | Limit (ppm) |
| -10 | 3.8 | 15 | 0.0180 | 2.5 |
| 0 | | 15 | 0.0180 | 2.5 |
| 10 | | 18 | 0.0216 | 2.5 |
| 20 | | 14 | 0.0168 | 2.5 |
| 30 | | 12 | 0.0144 | 2.5 |
| 40 | | 8 | 0.0096 | 2.5 |
| 50 | | 19 | 0.0228 | 2.5 |
| 55 | | 13 | 0.0156 | 2.5 |
| 25 | 4.35 | 18 | 0.0216 | 2.5 |
| | 3.45 | 16 | 0.0192 | 2.5 |

UMTS-FDD Band II (Part 24E)

| Middle Channel, $f_0 = 1880$ MHz | | | | |
|----------------------------------|-----------------------------------|----------------------|-----------------------|-------------|
| Temperature (°C) | Power Supplied (V _{DC}) | Frequency Error (Hz) | Frequency Error (ppm) | Limit (ppm) |
| -10 | 3.8 | 18 | 0.0096 | 2.5 |
| 0 | | 18 | 0.0096 | 2.5 |
| 10 | | 17 | 0.0090 | 2.5 |
| 20 | | 16 | 0.0085 | 2.5 |
| 30 | | 15 | 0.0080 | 2.5 |
| 40 | | 17 | 0.0090 | 2.5 |
| 50 | | 21 | 0.0112 | 2.5 |
| 55 | | 19 | 0.0101 | 2.5 |
| 25 | 4.35 | 18 | 0.0096 | 2.5 |
| | 3.45 | 16 | 0.0085 | 2.5 |

UMTS-FDD Band IV (Part 27)

| Middle Channel, $f_0 = 1733$ MHz | | | | |
|----------------------------------|-----------------------------------|----------------------|-----------------------|-------------|
| Temperature (°C) | Power Supplied (V _{DC}) | Frequency Error (Hz) | Frequency Error (ppm) | Limit (ppm) |
| -10 | 3.8 | 22 | 0.0263 | 2.5 |
| 0 | | 15 | 0.0180 | 2.5 |
| 10 | | 17 | 0.0204 | 2.5 |
| 20 | | 16 | 0.0192 | 2.5 |
| 30 | | 16 | 0.0192 | 2.5 |
| 40 | | 15 | 0.0180 | 2.5 |
| 50 | | 19 | 0.0228 | 2.5 |
| 55 | | 21 | 0.0251 | 2.5 |
| 25 | | 4.35 | 20 | 0.0240 |
| | 3.45 | 17 | 0.0204 | 2.5 |

Annex A. TEST INSTRUMENT

| Instrument | Model | Serial # | Cal Date | Cal Due | In use |
|----------------------------------------|-------------------|------------|------------|------------|-------------------------------------|
| RF Conducted Test | | | | | |
| Agilent ESA-E SERIES SPECTRUM ANALYZER | E4407B | MY45108319 | 09/14/2017 | 09/13/2018 | <input checked="" type="checkbox"/> |
| Power Splitter | 1# | 1# | 08/30/2017 | 08/29/2018 | <input checked="" type="checkbox"/> |
| Universal Radio Communication Tester | CMU200 | 121393 | 09/23/2017 | 09/22/2018 | <input checked="" type="checkbox"/> |
| Temperature/Humidity Chamber | UHL-270 | 001 | 10/07/2017 | 10/06/2018 | <input checked="" type="checkbox"/> |
| DC Power Supply | E3640A | MY40004013 | 09/15/2017 | 09/14/2018 | <input checked="" type="checkbox"/> |
| RF Power Sensor | Dare RPR3006C/P/W | AY554013 | 09/15/2017 | 09/14/2018 | <input checked="" type="checkbox"/> |
| Radiated Emissions | | | | | |
| EMI test receiver | ESL6 | 100262 | 09/15/2017 | 09/14/2018 | <input checked="" type="checkbox"/> |
| OPT 010 AMPLIFIER (0.1-1300MHz) | 8447E | 2727A02430 | 08/30/2017 | 08/29/2018 | <input checked="" type="checkbox"/> |
| Horn Antenna | BBHA9170 | 3145226D1 | 09/27/2017 | 09/26/2018 | <input checked="" type="checkbox"/> |
| Microwave Preamplifier (1 ~ 26.5GHz) | 8449B | 3008A02402 | 03/22/2018 | 03/21/2019 | <input checked="" type="checkbox"/> |
| Bilog Antenna (30MHz~6GHz) | JB6 | A110712 | 09/19/2017 | 09/18/2018 | <input checked="" type="checkbox"/> |
| Bilog Antenna (30MHz~2GHz) | JB1 | A112017 | 09/19/2017 | 09/18/2018 | <input checked="" type="checkbox"/> |
| Double Ridge Horn Antenna (1 ~18GHz) | AH-118 | 71259 | 09/22/2017 | 09/21/2018 | <input checked="" type="checkbox"/> |
| Double Ridge Horn Antenna (1 ~18GHz) | AH-118 | 71283 | 09/22/2017 | 09/21/2018 | <input checked="" type="checkbox"/> |
| SYNTHESIZED SIGNAL GENERATOR | 8665B | 3744A01293 | 09/15/2017 | 09/14/2018 | <input checked="" type="checkbox"/> |
| Power Amplifier | SMC150D | R1553-0313 | 03/08/2017 | 03/07/2018 | <input checked="" type="checkbox"/> |
| Power Amplifier | S41-25D | R1553-0314 | 05/26/2017 | 05/25/2018 | <input checked="" type="checkbox"/> |



| | |
|-------------|-----------------|
| Test Report | 18070322-FCC-R1 |
| Page | 88 of 105 |

| | | | | | |
|----------------------|-----------------|------|------------|------------|-------------------------------------|
| Tunable Notch Filter | 3NF-800/1000-S | AA4 | 08/30/2017 | 08/29/2018 | <input checked="" type="checkbox"/> |
| Tunable Notch Filter | 3NF-1000/2000-S | AM 4 | 08/30/2017 | 08/29/2018 | <input checked="" type="checkbox"/> |

Annex B. EUT And Test Setup Photographs

Annex B.i. Photograph: EUT External Photo

Whole Package View



Adapter - Label View

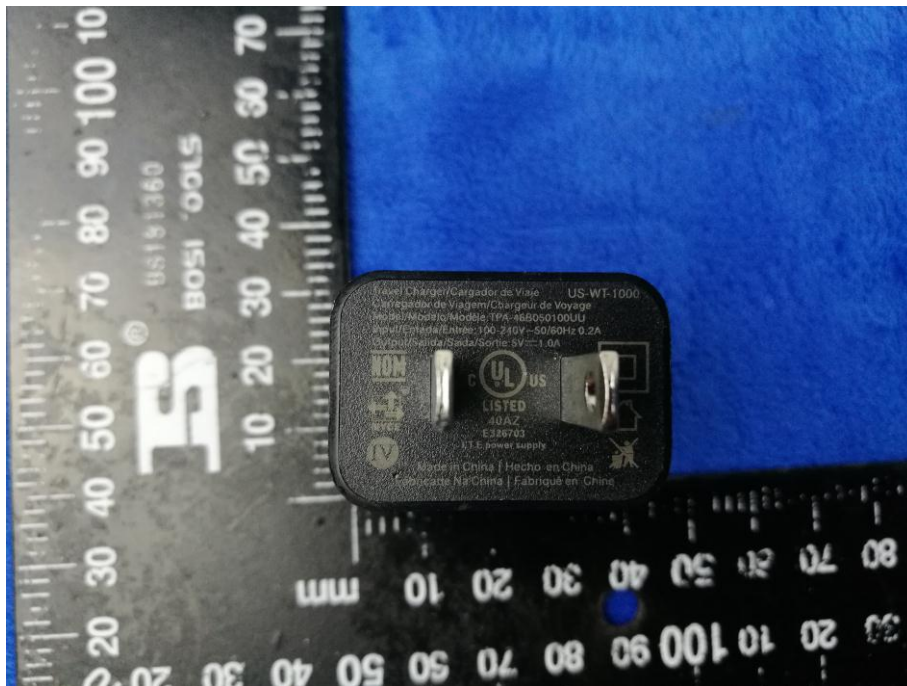

EUT - Front View



EUT - Rear View

