

# FCC SAR Test Report

APPLICANT : CT Asia  
EQUIPMENT : Mobile phone  
BRAND NAME : BLU  
MODEL NAME : Studio 5.0 II  
MARKETING NAME : Studio 5.0 II  
FCC ID : YHLBLUSTUDIO5II  
STANDARD : FCC 47 CFR Part 2 (2.1093)  
ANSI/IEEE C95.1-1992  
IEEE 1528-2003

The product was completely tested on Dec. 04, 2013. We, SPORTON INTERNATIONAL (XI'AN) INC., would like to declare that the tested sample has been evaluated in accordance with the procedures and shown the compliance with the applicable technical standards.

The test results in this report apply exclusively to the tested model / sample. Without written approval of SPORTON INTERNATIONAL (XI'AN) INC., the test report shall not be reproduced except in full.

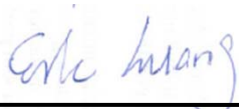

Reviewed by: Eric Huang / Deputy Manager



Approved by: Jones Tsai / Manager



**SPORTON INTERNATIONAL (XI'AN) INC.**

1F, Building A3, No. 39 Chuangye Rd., Xi'an Hi-tech Zone, Shanxi Province, P.R.C.



Table of Contents

1. Statement of Compliance .....4
2. Administration Data .....5
2.1 Testing Laboratory .....5
2.2 Applicant .....5
2.3 Manufacturer .....5
2.4 Application Details .....5
3. General Information .....6
3.1 Description of Equipment Under Test (EUT) .....6
3.2 Maximum RF output power among production units .....7
3.3 Applied Standard .....8
3.4 Device Category and SAR Limits .....8
3.5 Test Conditions .....8
4. Specific Absorption Rate (SAR) .....9
4.1 Introduction .....9
4.2 SAR Definition .....9
5. SAR Measurement System .....10
5.1 E-Field Probe .....11
5.2 Data Acquisition Electronics (DAE) .....11
5.3 Robot .....12
5.4 Measurement Server .....12
5.5 Phantom .....13
5.6 Device Holder .....13
5.7 Data Storage and Evaluation .....14
5.8 Test Equipment List .....16
6. Tissue Simulating Liquids .....17
7. System Verification Procedures .....19
7.1 Purpose of System Performance check .....19
7.2 System Setup .....19
7.3 SAR System Verification Results .....20
8. EUT Testing Position .....21
8.1 Define two imaginary lines on the handset .....21
8.2 Cheek Position .....22
8.3 Tilted Position .....22
8.4 Body Worn Position .....23
9. Measurement Procedures .....24
9.1 Spatial Peak SAR Evaluation .....24
9.2 Power Reference Measurement .....25
9.3 Area & Zoom Scan Procedures .....25
9.4 Volume Scan Procedures .....26
9.5 SAR Averaged Methods .....26
9.6 Power Drift Monitoring .....26
10. Conducted RF Output Power (Unit: dBm) .....27
11. Antenna Location .....35
12. SAR Test Results .....37
12.1 Head SAR .....37
12.2 Hotspot SAR .....39
12.3 Body Worn SAR .....41
12.4 Repeated SAR Measurement .....42
12.5 Highest SAR Plot .....43
13. Simultaneous Transmission Analysis .....49
13.1 Head Exposure Conditions .....50
13.2 Hotspot Exposure Conditions .....51
13.3 Body-Worn Exposure Conditions .....53
13.4 SPLSR Evaluation and Analysis .....54
14. Uncertainty Assessment .....56
15. References .....58
Appendix A. Plots of System Performance Check
Appendix B. Plots of SAR Measurement
Appendix C. DASY Calibration Certificate
Appendix D. Test Setup Photos



### Revision History

REPORT NO.	VERSION	DESCRIPTION	ISSUED DATE
FA3N1202	Rev. 01	Initial issue of report	Dec. 13, 2013

**1. Statement of Compliance**

The maximum results of Specific Absorption Rate (SAR) found during testing for **CT Asia; DUT: Mobile phone; Brand Name: BLU; Model Name: Studio 5.0 II; Marketing Name: Studio 5.0 II** are as follows.

**<Highest SAR Summary>**

Exposure Position	Frequency Band	Reported 1g-SAR (W/kg)	Equipment Class	Highest Reported 1g-SAR (W/kg)
Head	GSM850	0.41	PCE	0.41
	GSM1900	0.11		
	WCDMA Band V	0.26		
	WCDMA Band IV	0.19		
	WCDMA Band II	0.25		
	WLAN 2.4GHz Band	1.33	DTS	1.33
Hotspot (Separation 1cm)	GSM850	1.39	PCE	1.39
	GSM1900	1.19		
	WCDMA Band V	0.60		
	WCDMA Band IV	0.58		
	WCDMA Band II	1.38		
	WLAN 2.4GHz Band	0.29	DTS	0.29
Body-worn (Separation 1cm)	GSM850	1.39	PCE	1.39
	GSM1900	1.18		
	WCDMA Band V	0.60		
	WCDMA Band IV	0.50		
	WCDMA Band II	1.38		
	WLAN 2.4GHz Band	0.29	DTS	0.29

**<Highest Simultaneous transmission SAR>**

Exposure Position	Frequency Band	Equipment Class	Highest Reported Simultaneous Transmission 1g-SAR (W/kg)
Head	WCDMA Band II	PCE	1.57
	WLAN 2.4GHz Band	DTS	
Hotspot (Separation 1cm)	GSM850	PCE	1.41
	Bluetooth	DSS	

This device is in compliance with Specific Absorption Rate (SAR) for general population/uncontrolled exposure limits (1.6 W/kg) specified in FCC 47 CFR part 2 (2.1093) and ANSI/IEEE C95.1-1992, and had been tested in accordance with the measurement methods and procedures specified in IEEE 1528-2003.



**2. Administration Data**

**2.1 Testing Laboratory**

Test Site	SPORTON INTERNATIONAL (XI'AN) INC.
Test Site Location	1F, Building A3, No. 39 Chuangye Rd., Xi'an Hi-teck Zone, Shanxi Province, P. R. C. TEL: +86-029-8860-8767 FAX: +86-029-8860-8791

**2.2 Applicant**

Company Name	CT Asia
Address	Unit 01, 15/F, Seaview Centre, 139-141 Hoi bun road, Kwun Tong, Kowloon, Hongkong

**2.3 Manufacturer**

Company Name	TINNO MOBILE
Address	4/F., H-3 Building, OCT Eastern Industrial Park. NO.1 Xiangshan East Road., Nan Shan District, Shenzhen, P.R. CHINA

**2.4 Application Details**

Date of Start during the Test	Dec. 02, 2013
Date of End during the Test	Dec. 04, 2013



### 3. General Information

#### 3.1 Description of Equipment Under Test (EUT)

Product Feature & Specification	
DUT	Mobile phone
Brand Name	BLU
Model Name	Studio 5.0 II
Marketing Name	Studio 5.0 II
FCC ID	YHLBLUSTUDIO5II
IMEI Code	#1: 353919026325849 #2: 353924026325849
Wireless Technology and Frequency Range	GSM850: 824.2 MHz ~ 848.8 MHz GSM1900: 1850.2 MHz ~ 1909.8 MHz WCDMA Band V: 826.4 MHz ~ 846.6 MHz WCDMA Band IV : 1712.4 MHz ~ 1752.6 MHz WCDMA Band II: 1852.4 MHz ~ 1907.6 MHz WLAN 2.4GHz Band: 2412 MHz ~ 2462 MHz Bluetooth: 2402 MHz ~ 2480 MHz
Mode	<ul style="list-style-type: none"><li>• GSM/GPRS/EGPRS</li><li>• RMC/AMR 12.2Kbps Rel 99</li><li>• HSDPA Rel 7, Cat14</li><li>• HSUPA Rel 6, Cat6</li><li>• HSPA+ Rel 7, Cat 14 (Downlink Only)</li><li>• 802.11 b/g/n HT20/HT40</li><li>• Bluetooth v3.0 + EDR, Bluetooth v4.0</li></ul>
Antenna Type	WWAN: Fixed Internal Antenna WLAN: PIFA Antenna Bluetooth: PIFA Antenna
HW Version	V1.1
SW Version	BLU_D532a_V03_GENERIC
Transfer Mode Category	Class B – EUT cannot support Packet Switched and Circuit Switched Network simultaneously but can automatically switch between Packet and Circuit Switched Network.
DUT Stage	Identical Prototype
Remark:	<ol style="list-style-type: none"><li>1. The above EUT's information was declared by manufacturer. Please refer to the specifications or user's manual for more detailed description.</li><li>2. The EUT supports GPRS/EGPRS Class 12 and has no DTM function.</li></ol>

**3.2 Maximum RF output power among production units**

Burst Average Power (dBm)		
Mode / Band	GSM850	GSM1900
GSM (GMSK, 1 Tx slot)	33.5	30.5
GPRS (GMSK, 1 Tx slot)	33.5	30.5
GPRS (GMSK, 2 Tx slots)	32	29
GPRS (GMSK, 3 Tx slots)	31	28
GPRS (GMSK, 4 Tx slots)	30.5	27.5
EDGE (8PSK, 1 Tx slot)	27	27
EDGE (8PSK, 2 Tx slots)	26	25.5
EDGE (8PSK, 3 Tx slots)	23	23
EDGE (8PSK, 4 Tx slots)	22	22

Maximum Target Power for Production Unit			
Mode / Band	WCDMA Band V	WCDMA Band IV	WCDMA Band II
AMR	24.5	24	24
RMC 12.2K	24.5	24	24
HSDPA Subtest-1	23	23	23
HSDPA Subtest-2	23	23	23
HSDPA Subtest-3	23	23	22
HSDPA Subtest-4	23	23	22
HSUPA Subtest-1	21	21	21
HSUPA Subtest-2	21	20	20
HSUPA Subtest-3	22	21	21
HSUPA Subtest-4	21	20	21
HSUPA Subtest-5	22	21	21

Average Power (dBm)				
Mode / Band	IEEE 802.11b/g/n			
	11b	11g	11n-HT20	11n-HT40
WLAN 2.4GHz Band				
Channel 01	12.5	8	8	7
Channel 06	12.5	9	9	8
Channel 11	12.5	8	8	7

Average Power (dBm)				
Mode / Band	1Mbps (GFSK)	2Mbps ( $\pi/4$ -DQPSK)	3Mbps (8-DPSK)	BT4.0-LE (GFSK)
Bluetooth	0.5	0	0	-7



### 3.3 Applied Standard

The Specific Absorption Rate (SAR) testing specification, method, and procedure for this device is in accordance with the following standards:

- FCC 47 CFR Part 2 (2.1093)
- ANSI/IEEE C95.1-1992
- IEEE 1528-2003
- FCC KDB 865664 D01 SAR Measurement 100 MHz to 6 GHz v01r02
- FCC KDB 865664 D02 SAR Reporting v01r01
- FCC KDB 447498 D01 General RF Exposure Guidance v05r01
- FCC KDB 648474 D04 SAR Handsets Multi Xmitter and Ant v01r02
- FCC KDB 248227 D01 SAR meas for 802 11abg v01r02
- FCC KDB 941225 D01 SAR test for 3G devices v02
- FCC KDB 941225 D02 HSPA and 1x Advanced v02r02
- FCC KDB 941225 D03 SAR Test Reduction GSM GPRS EDGE v01
- FCC KDB 941225 D06 Hotspot SAR v01r01

### 3.4 Device Category and SAR Limits

This device belongs to portable device category because its radiating structure is allowed to be used within 20 centimeters of the body of the user. Limit for General Population/Uncontrolled exposure should be applied for this device, it is 1.6 W/kg as averaged over any 1 gram of tissue.

### 3.5 Test Conditions

#### 3.5.1 Ambient Condition

Ambient Temperature	20 to 24 °C
Humidity	< 60 %

#### 3.5.2 Test Configuration

For WWAN SAR testing, the device was controlled by using a base station emulator. Communication between the device and the emulator was established by air link. The distance between the EUT and the antenna of the emulator is larger than 50 cm and the output power radiated from the emulator antenna is at least 30 dB smaller than the output power of EUT.

During WLAN SAR testing EUT is configured with the WLAN continuous TX tool, and the transmission duty factor was monitored on the spectrum analyzer with zero-span setting

For WLAN SAR testing, WLAN engineering testing software installed on the EUT can provide continuous transmitting RF signal.



## **4. Specific Absorption Rate (SAR)**

### **4.1 Introduction**

SAR is related to the rate at which energy is absorbed per unit mass in an object exposed to a radio field. The SAR distribution in a biological body is complicated and is usually carried out by experimental techniques or numerical modeling. The standard recommends limits for two tiers of groups, occupational/controlled and general population/uncontrolled, based on a person's awareness and ability to exercise control over his or her exposure. In general, occupational/controlled exposure limits are higher than the limits for general population/uncontrolled.

### **4.2 SAR Definition**

The SAR definition is the time derivative (rate) of the incremental energy (dW) absorbed by (dissipated in) an incremental mass (dm) contained in a volume element (dv) of a given density ( $\rho$ ). The equation description is as below:

$$\text{SAR} = \frac{d}{dt} \left( \frac{dW}{dm} \right) = \frac{d}{dt} \left( \frac{dW}{\rho dv} \right)$$

SAR is expressed in units of Watts per kilogram (W/kg)

SAR measurement can be either related to the temperature elevation in tissue by

$$\text{SAR} = c \left( \frac{\delta T}{\delta t} \right)$$

Where: C is the specific heat capacity,  $\delta T$  is the temperature rise and  $\delta t$  is the exposure duration, or related to the electrical field in the tissue by

$$\text{SAR} = \frac{\sigma |E|^2}{\rho}$$

Where:  $\sigma$  is the conductivity of the tissue,  $\rho$  is the mass density of the tissue and E is the RMS electrical field strength.

However for evaluating SAR of low power transmitter, electrical field measurement is typically applied.

## 5. SAR Measurement System

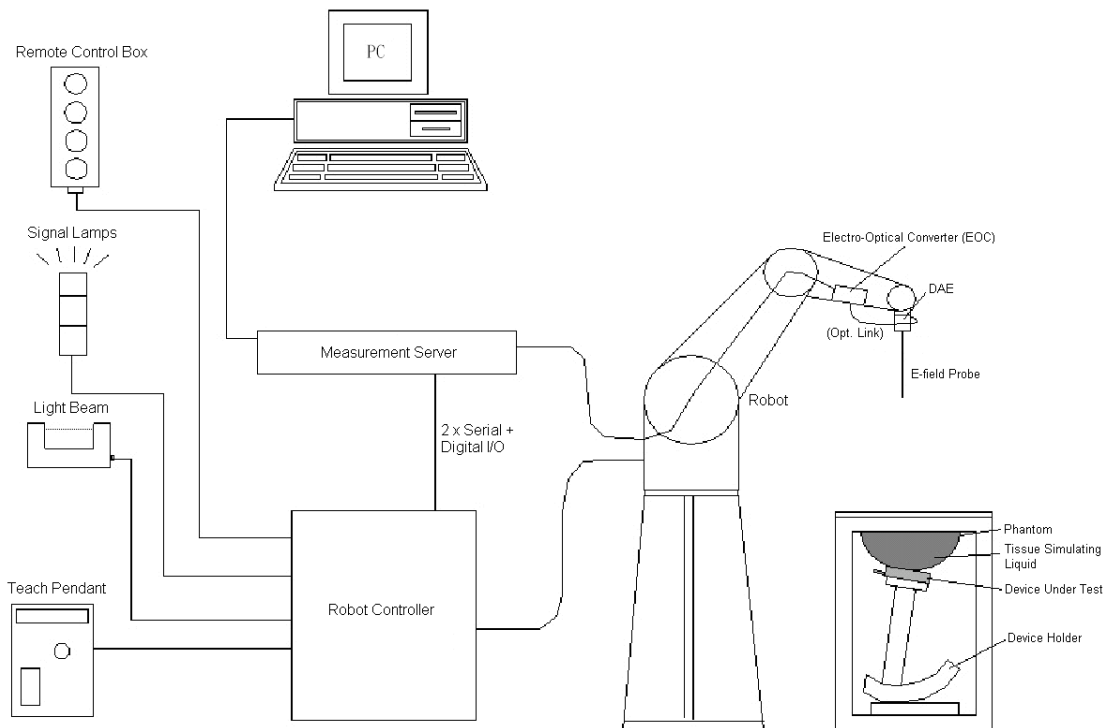

**Fig 5.1 SPEAG DASY System Configurations**

The DASY system for performance compliance tests is illustrated above graphically. This system consists of the following items:

- A standard high precision 6-axis robot with controller, a teach pendant and software
- A data acquisition electronic (DAE) attached to the robot arm extension
- A dosimetric probe equipped with an optical surface detector system
- The electro-optical converter (EOC) performs the conversion between optical and electrical signals
- A measurement server performs the time critical tasks such as signal filtering, control of the robot operation and fast movement interrupts.
- A probe alignment unit which improves the accuracy of the probe positioning
- A computer operating Windows XP
- DASY software
- Remote control with teach pendant and additional circuitry for robot safety such as warning lamps, etc.
- The SAM twin phantom
- A device holder
- Tissue simulating liquid
- Dipole for evaluating the proper functioning of the system

Component details are described in in the following sub-sections.

**5.1 E-Field Probe**

The SAR measurement is conducted with the dosimetric probe (manufactured by SPEAG). The probe is specially designed and calibrated for use in liquid with high permittivity. The dosimetric probe has special calibration in liquid at different frequency. This probe has a built in optical surface detection system to prevent from collision with phantom.

**5.1.1 E-Field Probe Specification**

**<EX3DV4 Probe>**

<b>Construction</b>	Symmetrical design with triangular core Built-in shielding against static charges PEEK enclosure material (resistant to organic solvents, e.g., DGBE)
<b>Frequency</b>	10 MHz to 6 GHz; Linearity: $\pm 0.2$ dB
<b>Directivity</b>	$\pm 0.3$ dB in HSL (rotation around probe axis) $\pm 0.5$ dB in tissue material (rotation normal to probe axis)
<b>Dynamic Range</b>	10 $\mu$ W/g to 100 mW/g; Linearity: $\pm 0.2$ dB (noise: typically $< 1 \mu$ W/g)
<b>Dimensions</b>	Overall length: 330 mm (Tip: 20 mm) Tip diameter: 2.5 mm (Body: 12 mm) Typical distance from probe tip to dipole centers: 1 mm

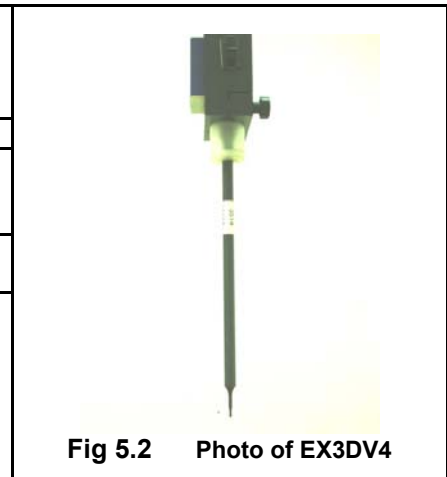

**Fig 5.2 Photo of EX3DV4**

**5.1.2 E-Field Probe Calibration**

Each probe needs to be calibrated according to a dosimetric assessment procedure with accuracy better than  $\pm 10\%$ . The spherical isotropy shall be evaluated and within  $\pm 0.25$ dB. The sensitivity parameters (NormX, NormY, and NormZ), the diode compression parameter (DCP) and the conversion factor (ConvF) of the probe are tested. The calibration data can be referred to appendix C of this report.

**5.2 Data Acquisition Electronics (DAE)**

The data acquisition electronics (DAE) consists of a highly sensitive electrometer-grade preamplifier with auto-zeroing, a channel and gain-switching multiplexer, a fast 16 bit AD-converter and a command decoder and control logic unit. Transmission to the measurement server is accomplished through an optical downlink for data and status information as well as an optical uplink for commands and the clock. The input impedance of the DAE is 200 MOhm; the inputs are symmetrical and floating. Common mode rejection is above 80 dB.



**Fig 5.3 Photo of DAE**

### **5.3 Robot**

The SPEAG DASY system uses the high precision robots (DASY5: TX90XL) type from Stäubli SA (France). For the 6-axis controller system, the robot controller version (DASY5: CS8c) from Stäubli is used. The Stäubli robot series have many features that are important for our application:

- High precision (repeatability  $\pm 0.035$  mm)
- High reliability (industrial design)
- Jerk-free straight movements
- Low ELF interference (the closed metallic construction shields against motor control fields)



**Fig 5.4 Photo of DASY5**

### **5.4 Measurement Server**

The measurement server is based on a PC/104 CPU board with CPU (DASY5: 400 MHz, Intel Celeron), chipdisk (DASY5: 128 MB), RAM (DASY5: 128 MB). The necessary circuits for communication with the DAE electronic box, as well as the 16 bit AD converter system for optical detection and digital I/O interface are contained on the DASY I/O board, which is directly connected to the PC/104 bus of the CPU board.

The measurement server performs all the real-time data evaluation for field measurements and surface detection, controls robot movements and handles safety operations.

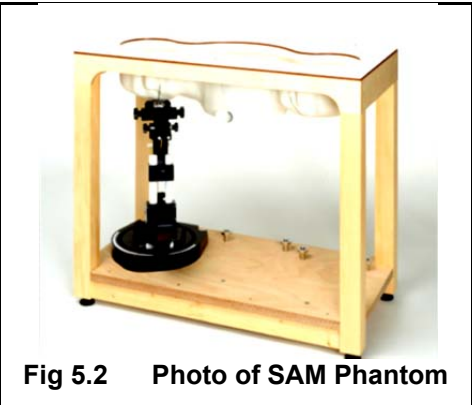

**Fig 5.1 Photo of Server for DASY5**

### 5.5 Phantom

<SAM Twin Phantom>

<b>Shell Thickness</b>	2 ± 0.2 mm; Center ear point: 6 ± 0.2 mm
<b>Filling Volume</b>	Approx. 25 liters
<b>Dimensions</b>	Length: 1000 mm; Width: 500 mm; Height: adjustable feet
<b>Measurement Areas</b>	Left Hand, Right Hand, Flat Phantom



The bottom plate contains three pair of bolts for locking the device holder. The device holder positions are adjusted to the standard measurement positions in the three sections. A white cover is provided to tap the phantom during off-periods to prevent water evaporation and changes in the liquid parameters. On the phantom top, three reference markers are provided to identify the phantom position with respect to the robot.

### 5.6 Device Holder

<Device Holder for SAM Twin Phantom>

The SAR in the phantom is approximately inversely proportional to the square of the distance between the source and the liquid surface. For a source at 5 mm distance, a positioning uncertainty of ± 0.5 mm would produce a SAR uncertainty of ± 20 %. Accurate device positioning is therefore crucial for accurate and repeatable measurements. The positions in which the devices must be measured are defined by the standards.

The DASY device holder is designed to cope with different positions given in the standard. It has two scales for the device rotation (with respect to the body axis) and the device inclination (with respect to the line between the ear reference points). The rotation center for both scales is the ear reference point (ERP). Thus the device needs no repositioning when changing the angles.

The DASY device holder is constructed of low-loss POM material having the following dielectric parameters: relative permittivity  $\epsilon = 3$  and loss tangent  $\delta = 0.02$ . The amount of dielectric material has been reduced in the closest vicinity of the device, since measurements have suggested that the influence of the clamp on the test results could thus be lowered.



Fig 5.3 Device Holder

## 5.7 Data Storage and Evaluation

### 5.7.1 Data Storage

The DASY software stores the assessed data from the data acquisition electronics as raw data (in microvolt readings from the probe sensors), together with all the necessary software parameters for the data evaluation (probe calibration data, liquid parameters and device frequency and modulation data) in measurement files. The post-processing software evaluates the desired unit and format for output each time the data is visualized or exported. This allows verification of the complete software setup even after the measurement and allows correction of erroneous parameter settings. For example, if a measurement has been performed with an incorrect crest factor parameter in the device setup, the parameter can be corrected afterwards and the data can be reevaluated.

The measured data can be visualized or exported in different units or formats, depending on the selected probe type (e.g., [V/m], [A/m], [mW/g]). Some of these units are not available in certain situations or give meaningless results, e.g., a SAR-output in a non-lose media, will always be zero. Raw data can also be exported to perform the evaluation with other software packages.

### 5.7.2 Data Evaluation

The DASY post-processing software (SEMCAD) automatically executes the following procedures to calculate the field units from the microvolt readings at the probe connector. The parameters used in the evaluation are stored in the configuration modules of the software :

<b>Probe parameters :</b>	- Sensitivity	Norm <sub>i</sub> , a <sub>i0</sub> , a <sub>i1</sub> , a <sub>i2</sub>
	- Conversion factor	ConvF <sub>i</sub>
	- Diode compression point	dcp <sub>i</sub>
<b>Device parameters :</b>	- Frequency	f
	- Crest factor	cf
<b>Media parameters :</b>	- Conductivity	σ
	- Density	ρ

These parameters must be set correctly in the software. They can be found in the component documents or they can be imported into the software from the configuration files issued for the DASY components. In the direct measuring mode of the multi-meter option, the parameters of the actual system setup are used. In the scan visualization and export modes, the parameters stored in the corresponding document files are used.

The first step of the evaluation is a linearization of the filtered input signal to account for the compression characteristics of the detector diode. The compensation depends on the input signal, the diode type and the DC-transmission factor from the diode to the evaluation electronics. If the exciting field is pulsed, the crest factor of the signal must be known to correctly compensate for peak power.

The formula for each channel can be given as :

$$V_i = U_i + U_i^2 \cdot \frac{cf}{dcp_i}$$

with  $V_i$  = compensated signal of channel i, (i = x, y, z)  
 $U_i$  = input signal of channel i, (i = x, y, z)  
 cf = crest factor of exciting field (DASY parameter)  
 dcp<sub>i</sub> = diode compression point (DASY parameter)

From the compensated input signals, the primary field data for each channel can be evaluated :

$$\text{E-field Probes : } E_i = \sqrt{\frac{V_i}{\text{Norm}_i \cdot \text{ConvF}}}$$

$$\text{H-field Probes : } H_i = \sqrt{V_i \cdot \frac{a_{i0} + a_{i1}f + a_{i2}f^2}{f}}$$

with  $V_i$  = compensated signal of channel i, (i = x, y, z)  
 Norm<sub>i</sub> = sensor sensitivity of channel i, (i = x, y, z),  $\mu\text{V}/(\text{V/m})^2$  for E-field Probes  
 ConvF = sensitivity enhancement in solution  
 a<sub>ij</sub> = sensor sensitivity factors for H-field probes  
 f = carrier frequency [GHz]  
 E<sub>i</sub> = electric field strength of channel i in V/m  
 H<sub>i</sub> = magnetic field strength of channel i in A/m

The RSS value of the field components gives the total field strength (Hermitian magnitude) :

$$E_{\text{tot}} = \sqrt{E_x^2 + E_y^2 + E_z^2}$$

The primary field data are used to calculate the derived field units.

$$\text{SAR} = E_{\text{tot}}^2 \cdot \frac{\sigma}{\rho \cdot 1000}$$

with SAR = local specific absorption rate in mW/g  
 E<sub>tot</sub> = total field strength in V/m  
 σ = conductivity in [mho/m] or [Siemens/m]  
 ρ = equivalent tissue density in g/cm<sup>3</sup>

Note that the density is set to 1, to account for actual head tissue density rather than the density of the tissue simulating liquid.



**5.8 Test Equipment List**

Manufacturer	Name of Equipment	Type/Model	Serial Number	Calibration	
				Last Cal.	Due Date
SPEAG	835MHz System Validation Kit	D835V2	4d151	Mar. 25. 2013	Mar. 24. 2014
SPEAG	1750MHz System Validation Kit	D1750V2	1090	Mar. 27. 2013	Mar. 26. 2014
SPEAG	1900MHz System Validation Kit	D1900V2	5d170	Mar. 27. 2013	Mar. 26. 2014
SPEAG	2450MHz System Validation Kit	D2450V2	908	Mar. 26. 2013	Mar. 25. 2014
SPEAG	Data Acquisition Electronics	DAE4	1358	Apr. 08, 2013	Apr. 07, 2014
SPEAG	Dosimetric E-Field Probe	EX3DV4	3911	Apr. 11, 2013	Apr. 10, 2014
SPEAG	SAM Twin Phantom	QD 000 P40 CD	TP-1753	NCR	NCR
SPEAG	SAM Twin Phantom	QD 000 P40 CD	TP-1754	NCR	NCR
SPEAG	Phone Positioner	N/A	N/A	NCR	NCR
Agilent	Wireless Communication Test Set	E5515C	MY52102600	Nov. 16, 2013	Nov. 15, 2014
Agilent	ENA Series Network Analyzer	E5071C	MY46111157	Apr. 22, 2013	Apr. 21, 2014
Agilent	Dielectric Probe Kit	85070E	MY44300751	NCR	NCR
Agilent	Dual Directional Coupler	778D	50422	Note 2	
Woken	Attenuator 1	WK0602-XX	N/A	Note 2	
PE	Attenuator 2	PE7005-10	N/A	Note 2	
PE	Attenuator 3	PE7005- 3	N/A	Note 2	
AR	Power Amplifier	5S1G4M2	328767	Note 3	
R&S	Spectrum Analyzer	FSP7	101230	Jun. 13, 2013	Jun. 12, 2014

**Table 5.1 Test Equipment List**

**Note:**

1. The calibration certificate of DASYS can be referred to appendix C of this report.
2. The Insertion Loss calibration of Dual Directional Coupler and Attenuator were characterized via the network analyzer and compensated during system check.
3. In system check we need to monitor the level on the power meter, and adjust the power amplifier level to have precise power level to the dipole; the measured SAR will be normalized to 1W input power according to the ratio of 1W to the input power to the dipole. For system check, the calibration of the power amplifier is deemed not critically required for correct measurement; the power meter is critical and we do have calibration for it
4. Attenuator 1 insertion loss is calibrated by the network Analyzer, which the calibration is valid, before system check.



## 6. Tissue Simulating Liquids

For the measurement of the field distribution inside the SAM phantom with DASY, the phantom must be filled with around 25 liters of homogeneous body tissue simulating liquid. For head SAR testing, the liquid height from the ear reference point (ERP) of the phantom to the liquid top surface is larger than 15 cm, which is shown in Fig. 6.1. For body SAR testing, the liquid height from the center of the flat phantom to the liquid top surface is larger than 15 cm, which is shown in Fig. 6.2.



Fig 6.1 Photo of Liquid Height for Head SAR



Fig 6.2 Photo of Liquid Height for Body SAR

The following table gives the recipes for tissue simulating liquid.

Frequency (MHz)	Water (%)	Sugar (%)	Cellulose (%)	Salt (%)	Preventol (%)	DGBE (%)	Conductivity ( $\sigma$ )	Permittivity ( $\epsilon_r$ )
<b>For Head</b>								
835	40.3	57.9	0.2	1.4	0.2	0	0.90	41.5
1800, 1900, 2000	55.2	0	0	0.3	0	44.5	1.40	40.0
2450	55.0	0	0	0	0	45.0	1.80	39.2
<b>For Body</b>								
835	50.8	48.2	0	0.9	0.1	0	0.97	55.2
1800, 1900, 2000	70.2	0	0	0.4	0	29.4	1.52	53.3
2450	68.6	0	0	0	0	31.4	1.95	52.7

Table 6.1 Recipes of Tissue Simulating Liquid



The dielectric parameters of the liquids were verified prior to the SAR evaluation using an SPEAG 85070E Dielectric Probe Kit and an Agilent Network Analyzer.

The following table shows the measuring results for simulating liquid.

Frequency (MHz)	Liquid Type	Liquid Temp. (°C)	Conductivity ( $\sigma$ )	Permittivity ( $\epsilon_r$ )	Conductivity Target ( $\sigma$ )	Permittivity Target ( $\epsilon_r$ )	Delta ( $\sigma$ ) (%)	Delta ( $\epsilon_r$ ) (%)	Limit (%)	Date
835	Head	22.7	0.902	40.749	0.90	41.5	0.22	-1.81	±5	Dec. 04, 2013
1750	Head	22.3	1.388	41.364	1.37	40.1	1.31	3.15	±5	Dec. 03, 2013
1900	Head	22.6	1.445	39.686	1.40	40.0	3.21	-0.79	±5	Dec. 03, 2013
2450	Head	22.5	1.809	37.604	1.80	39.2	0.50	-4.07	±5	Dec. 04, 2013
835	Body	22.4	0.974	54.283	0.97	55.2	0.41	-1.66	±5	Dec. 03, 2013
1750	Body	22.4	1.522	54.439	1.49	53.4	2.15	1.95	±5	Dec. 03, 2013
1900	Body	22.6	1.531	54.671	1.52	53.3	0.72	2.57	±5	Dec. 02, 2013
2450	Body	22.7	1.951	53.859	1.95	52.7	0.05	2.20	±5	Dec. 04, 2013

**Table 6.2 Measuring Results for Simulating Liquid**

## 7. System Verification Procedures

Each DASY system is equipped with one or more system validation kits. These units, together with the predefined measurement procedures within the DASY software, enable the user to conduct the system performance check and system validation. System validation kit includes a dipole, tripod holder to fix it underneath the flat phantom and a corresponding distance holder.

### 7.1 Purpose of System Performance check

The system performance check verifies that the system operates within its specifications. System and operator errors can be detected and corrected. It is recommended that the system performance check be performed prior to any usage of the system in order to guarantee reproducible results. The system performance check uses normal SAR measurements in a simplified setup with a well characterized source. This setup was selected to give a high sensitivity to all parameters that might fail or vary over time. The system check does not intend to replace the calibration of the components, but indicates situations where the system uncertainty is exceeded due to drift or failure.

### 7.2 System Setup

In the simplified setup for system evaluation, the EUT is replaced by a calibrated dipole and the power source is replaced by a continuous wave that comes from a signal generator. The calibrated dipole must be placed beneath the flat phantom section of the SAM twin phantom with the correct distance holder. The distance holder should touch the phantom surface with a light pressure at the reference marking and be oriented parallel to the long side of the phantom. The equipment setup is shown below:

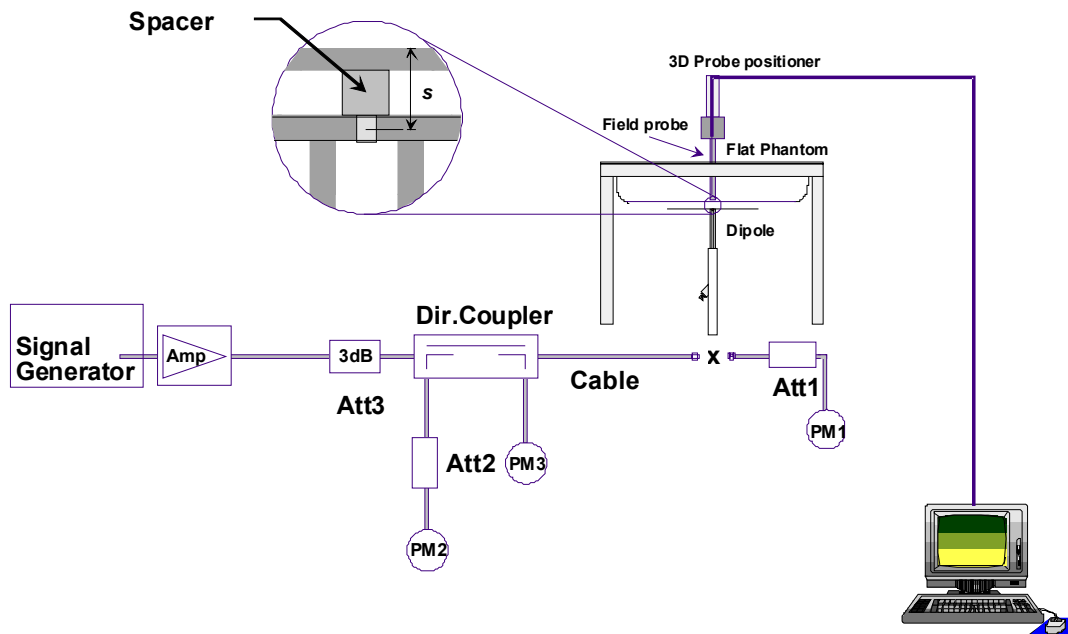

Fig 7.1 System Setup for System Evaluation

1. Signal Generator
2. Amplifier
3. Directional Coupler
4. Power Meter
5. Calibrated Dipole



**Fig 7.2 Photo of Dipole Setup**

**7.3 SAR System Verification Results**

Comparing to the original SAR value provided by SPEAG, the verification data should be within its specification of 10 %. Table 7.1 shows the target SAR and measured SAR after normalized to 1W input power. The table below indicates the system performance check can meet the variation criterion and the plots can be referred to Appendix A of this report.

Date	Frequency (MHz)	Liquid Type	Power fed onto reference dipole (mW)	Targeted SAR (W/kg)	Measured SAR (W/kg)	Normalized SAR (W/kg)	Deviation (%)
Dec. 04, 2013	835	Head	250	9.49	2.25	9.00	-5.16
Dec. 03, 2013	1750	Head	250	36.90	8.98	35.92	-2.66
Dec. 03, 2013	1900	Head	250	40.20	10.10	40.4	0.50
Dec. 04, 2013	2450	Head	250	54.00	13.10	52.4	-2.96
Dec. 03, 2013	835	Body	250	9.43	2.42	9.68	2.65
Dec. 03, 2013	1750	Body	250	38.10	9.74	38.96	2.26
Dec. 02, 2013	1900	Body	250	41.20	10.50	42.00	1.94
Dec. 04, 2013	2450	Body	250	50.40	12.40	49.6	-1.59

**Table 7.1 Target and Measurement SAR after Normalized**

## 8. EUT Testing Position

### 8.1 Define two imaginary lines on the handset

- The vertical centerline passes through two points on the front side of the handset - the midpoint of the width  $w_t$  of the handset at the level of the acoustic output, and the midpoint of the width  $w_b$  of the bottom of the handset.
- The horizontal line is perpendicular to the vertical centerline and passes through the center of the acoustic output. The horizontal line is also tangential to the face of the handset at point A.
- The two lines intersect at point A. Note that for many handsets, point A coincides with the center of the acoustic output; however, the acoustic output may be located elsewhere on the horizontal line. Also note that the vertical centerline is not necessarily parallel to the front face of the handset, especially for clamshell handsets, handsets with flip covers, and other irregularly shaped handsets.

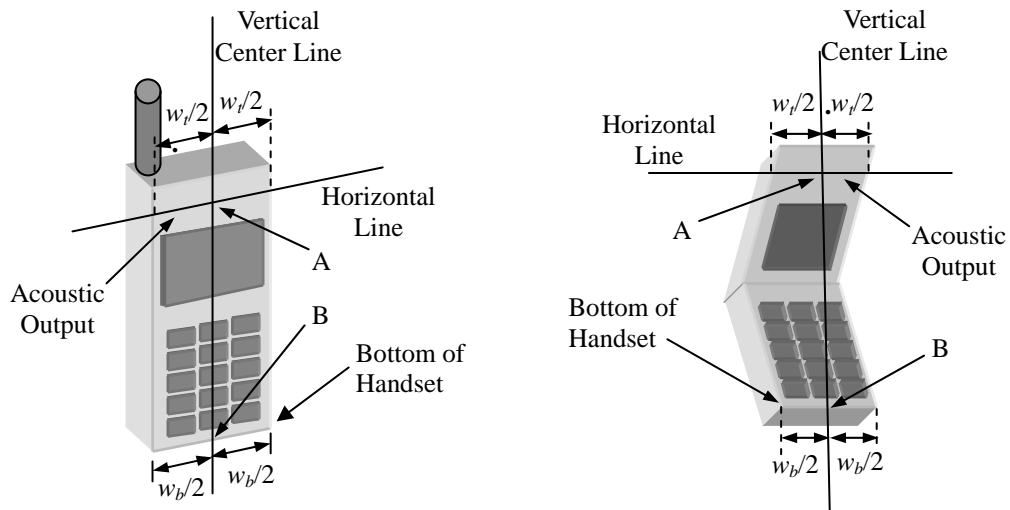

**Fig 8.1 Illustration for Handset Vertical and Horizontal Reference Lines**

### 8.2 Cheek Position

- (a) To position the device with the vertical center line of the body of the device and the horizontal line crossing the center piece in a plane parallel to the sagittal plane of the phantom. While maintaining the device in this plane, align the vertical center line with the reference plane containing the three ear and mouth reference point (M: Mouth, RE: Right Ear, and LE: Left Ear) and align the center of the ear piece with the line RE-LE.
- (b) To move the device towards the phantom with the ear piece aligned with the line LE-RE until the phone touched the ear. While maintaining the device in the reference plane and maintaining the phone contact with the ear, move the bottom of the phone until any point on the front side is in contact with the cheek of the phantom or until contact with the ear is lost (see Fig. 8.2).

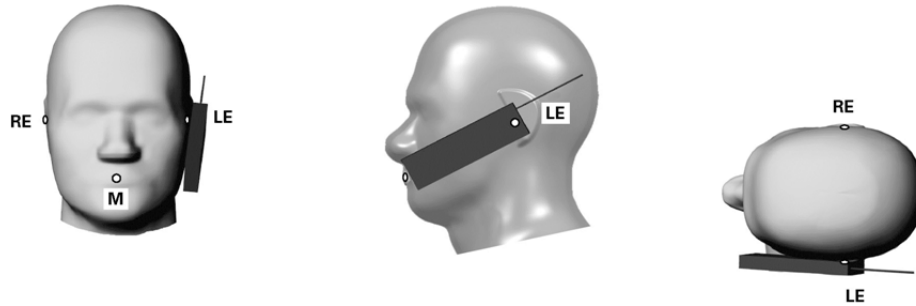

Fig 8.2 Illustration for Cheek Position

### 8.3 Tilted Position

- (a) To position the device in the “cheek” position described above.
- (b) While maintaining the device the reference planes described above and pivoting against the ear, moves it outward away from the mouth by an angle of 15 degrees or until contact with the ear is lost (see Fig. 8.3).

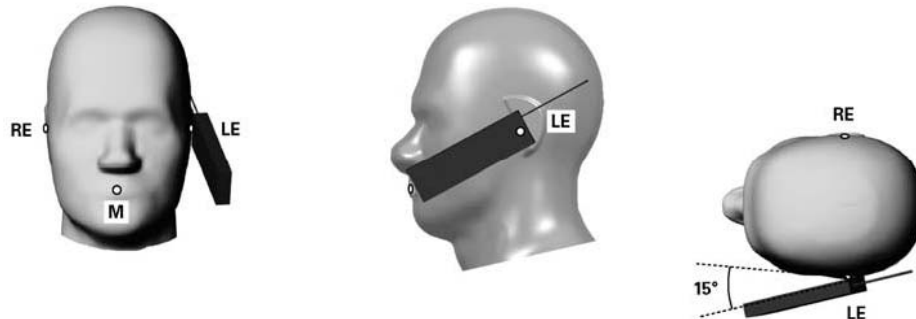
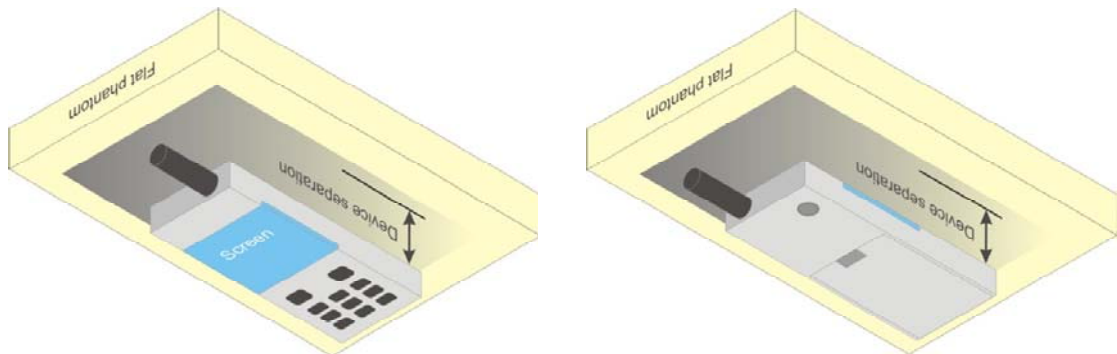

Fig 8.3 Illustration for Tilted Position

### **8.4 Body Worn Position**

- (a) To position the device parallel to the phantom surface with either keypad up or down.
- (b) To adjust the device parallel to the flat phantom.
- (c) To adjust the distance between the device surface and the flat phantom to 1 cm.



**Fig 8.4 Illustration for Body Worn Position**

### **8.5 Hotspot Position**

- (a) To position the device parallel to the phantom surface with all sides and either keypad up or down.
- (b) To adjust the device parallel to the flat phantom.
- (c) To adjust the distance between the device and the flat phantom to 1 cm.

#### **<EUT Setup Photos>**

Please refer to Appendix D for the test setup photos.

## 9. Measurement Procedures

The measurement procedures are as follows:

### <Conducted power measurement>

- (a) For WWAN power measurement, use base station simulator to configure EUT WWAN transmission in conducted connection with RF cable, at maximum power in each supported wireless interface and frequency band.
- (b) Read the WWAN RF power level from the base station simulator.
- (c) For WLAN/BT power measurement, use engineering software to configure EUT WLAN/BT continuously transmission, at maximum RF power in each supported wireless interface and frequency band
- (d) Connect EUT RF port through RF cable to the power meter, and measure WLAN/BT output power

### <SAR measurement>

- (a) Use base station simulator to configure EUT WWAN transmission in radiated connection, and engineering software to configure EUT WLAN/BT continuously transmission, at maximum RF power, in the highest power channel.
- (b) Place the EUT in the positions as Appendix D demonstrates.
- (c) Set scan area, grid size and other setting on the DASY software.
- (d) Measure SAR results for the highest power channel on each testing position.
- (e) Find out the largest SAR result on these testing positions of each band
- (f) Measure SAR results for other channels in worst SAR testing position if the reported SAR of highest power channel is larger than 0.8 W/kg

According to the test standard, the recommended procedure for assessing the peak spatial-average SAR value consists of the following steps:

- (a) Power reference measurement
- (b) Area scan
- (c) Zoom scan
- (d) Power drift measurement

### 9.1 Spatial Peak SAR Evaluation

The procedure for spatial peak SAR evaluation has been implemented according to the test standard. It can be conducted for 1g and 10g, as well as for user-specific masses. The DASY software includes all numerical procedures necessary to evaluate the spatial peak SAR value.

The base for the evaluation is a "cube" measurement. The measured volume must include the 1g and 10g cubes with the highest averaged SAR values. For that purpose, the center of the measured volume is aligned to the interpolated peak SAR value of a previously performed area scan.

The entire evaluation of the spatial peak values is performed within the post-processing engine (SEMCAD). The system always gives the maximum values for the 1g and 10g cubes. The algorithm to find the cube with highest averaged SAR is divided into the following stages:

- (a) Extraction of the measured data (grid and values) from the Zoom Scan
- (b) Calculation of the SAR value at every measurement point based on all stored data (A/D values and measurement parameters)
- (c) Generation of a high-resolution mesh within the measured volume
- (d) Interpolation of all measured values from the measurement grid to the high-resolution grid
- (e) Extrapolation of the entire 3-D field distribution to the phantom surface over the distance from sensor to surface
- (f) Calculation of the averaged SAR within masses of 1g and 10g



### 9.2 Power Reference Measurement

The Power Reference Measurement and Power Drift Measurements are for monitoring the power drift of the device under test in the batch process. The minimum distance of probe sensors to surface determines the closest measurement point to phantom surface. This distance cannot be smaller than the distance of sensor calibration points to probe tip as defined in the probe properties.

### 9.3 Area & Zoom Scan Procedures

First Area Scan is used to locate the approximate location(s) of the local peak SAR value(s). The measurement grid within an Area Scan is defined by the grid extent, grid step size and grid offset. Next, in order to determine the EM field distribution in a three-dimensional spatial extension, Zoom Scan is required. The Zoom Scan is performed around the highest E-field value to determine the averaged SAR-distribution over 10 g. Area scan and zoom scan resolution setting follows KDB 865664 D01v01r02 quoted below.

When the 1-g SAR of the highest peak is within 2 dB of the SAR limit, additional zoom scans are required for other peaks within 2 dB of the highest peak that have not been included in any zoom scan to ensure there is no increase in SAR.

		$\leq 3$ GHz	$> 3$ GHz	
Maximum distance from closest measurement point (geometric center of probe sensors) to phantom surface		$5 \pm 1$ mm	$\frac{1}{2} \delta \ln(2) \pm 0.5$ mm	
Maximum probe angle from probe axis to phantom surface normal at the measurement location		$30^\circ \pm 1^\circ$	$20^\circ \pm 1^\circ$	
Maximum area scan spatial resolution: $\Delta x_{Area}, \Delta y_{Area}$		$\leq 2$ GHz: $\leq 15$ mm 2 – 3 GHz: $\leq 12$ mm	3 – 4 GHz: $\leq 12$ mm 4 – 6 GHz: $\leq 10$ mm	
		When the x or y dimension of the test device, in the measurement plane orientation, is smaller than the above, the measurement resolution must be $\leq$ the corresponding x or y dimension of the test device with at least one measurement point on the test device.		
Maximum zoom scan spatial resolution: $\Delta x_{Zoom}, \Delta y_{Zoom}$		$\leq 2$ GHz: $\leq 8$ mm 2 – 3 GHz: $\leq 5$ mm*	3 – 4 GHz: $\leq 5$ mm* 4 – 6 GHz: $\leq 4$ mm*	
Maximum zoom scan spatial resolution, normal to phantom surface	uniform grid: $\Delta z_{Zoom}(n)$	$\leq 5$ mm	3 – 4 GHz: $\leq 4$ mm 4 – 5 GHz: $\leq 3$ mm 5 – 6 GHz: $\leq 2$ mm	
	graded grid	$\Delta z_{Zoom}(1)$ : between 1 <sup>st</sup> two points closest to phantom surface	$\leq 4$ mm	3 – 4 GHz: $\leq 3$ mm 4 – 5 GHz: $\leq 2.5$ mm 5 – 6 GHz: $\leq 2$ mm
		$\Delta z_{Zoom}(n>1)$ : between subsequent points	$\leq 1.5 \cdot \Delta z_{Zoom}(n-1)$	
Minimum zoom scan volume	x, y, z	$\geq 30$ mm	3 – 4 GHz: $\geq 28$ mm 4 – 5 GHz: $\geq 25$ mm 5 – 6 GHz: $\geq 22$ mm	
<p>Note: <math>\delta</math> is the penetration depth of a plane-wave at normal incidence to the tissue medium; see draft standard IEEE P1528-2011 for details.</p> <p>* When zoom scan is required and the <i>reported</i> SAR from the area scan based 1-g SAR estimation procedures of KDB 447498 is <math>\leq 1.4</math> W/kg, <math>\leq 8</math> mm, <math>\leq 7</math> mm and <math>\leq 5</math> mm zoom scan resolution may be applied, respectively, for 2 GHz to 3 GHz, 3 GHz to 4 GHz and 4 GHz to 6 GHz.</p>				



### **9.4 Volume Scan Procedures**

The volume scan is used for assess overlapping SAR distributions for antennas transmitting in different frequency bands. It is equivalent to an oversized zoom scan used in standalone measurements. The measurement volume will be used to enclose all the simultaneous transmitting antennas. For antennas transmitting simultaneously in different frequency bands, the volume scan is measured separately in each frequency band. In order to sum correctly to compute the 1g aggregate SAR, the EUT remain in the same test position for all measurements and all volume scan use the same spatial resolution and grid spacing. When all volume scan were completed, the software, SEMCAD postprocessor can combine and subsequently superpose these measurement data to calculating the multiband SAR.

### **9.5 SAR Averaged Methods**

In DASYS, the interpolation and extrapolation are both based on the modified Quadratic Shepard's method. The interpolation scheme combines a least-square fitted function method and a weighted average method which are the two basic types of computational interpolation and approximation.

Extrapolation routines are used to obtain SAR values between the lowest measurement points and the inner phantom surface. The extrapolation distance is determined by the surface detection distance and the probe sensor offset. The uncertainty increases with the extrapolation distance. To keep the uncertainty within 1% for the 1 g and 10 g cubes, the extrapolation distance should not be larger than 5 mm.

### **9.6 Power Drift Monitoring**

All SAR testing is under the EUT install full charged battery and transmit maximum output power. In DASYS measurement software, the power reference measurement and power drift measurement procedures are used for monitoring the power drift of EUT during SAR test. Both these procedures measure the field at a specified reference position before and after the SAR testing. The software will calculate the field difference in dB. If the power drifts more than 5%, the SAR will be retested.

## 10. Conducted RF Output Power (Unit: dBm)

### <GSM Conducted Power>

**Note:**

1. Per KDB 447498 D01v05r01, the maximum output power channel is used for SAR testing and for further SAR test reduction.
2. The EUT do not support DTM function.
3. For head SAR testing, the EUT was set in GSM Voice for GSM850 and GSM1900 due to its highest frame-average power.
4. For hotspot SAR testing, the EUT was set in GPRS 4 Tx slots for GSM850 and GSM1900 due to its highest frame-average power.
5. For body worn SAR testing, the EUT was set in GPRS 4 Tx slots and GSM Voice for GSM850 and GSM1900 due to their highest frame-average power.

### <SIM1>

Band: GSM850	Burst Average Power (dBm)			Frame-Average Power (dBm)		
Channel	128	189	251	128	189	251
Frequency (MHz)	824.2	836.4	848.8	824.2	836.4	848.8
GSM (GMSK, 1 Tx slot)	32.44	32.47	32.53	23.44	23.47	23.53
GPRS (GMSK, 1 Tx slot)	32.43	32.46	32.52	23.43	23.46	23.52
GPRS (GMSK, 2 Tx slots)	31.65	31.69	31.74	25.65	25.69	25.74
GPRS (GMSK, 3 Tx slots)	30.07	30.11	30.17	25.81	25.85	25.91
GPRS (GMSK, 4 Tx slots)	29.35	29.39	29.46	26.35	26.39	26.46
EDGE (8PSK, 1 Tx slot)	26.58	26.60	26.59	17.58	17.60	17.59
EDGE (8PSK, 2 Tx slots)	25.34	25.33	25.35	19.34	19.33	19.35
EDGE (8PSK, 3 Tx slots)	22.82	22.83	22.90	18.56	18.57	18.64
EDGE (8PSK, 4 Tx slots)	21.50	21.51	21.54	18.50	18.51	18.54
Band: GSM1900	Burst Average Power (dBm)			Frame-Average Power (dBm)		
Channel	512	661	810	512	661	810
Frequency (MHz)	1850.2	1880.0	1909.8	1850.2	1880.0	1909.8
GSM (GMSK, 1 Tx slot)	29.19	29.18	29.59	20.19	20.18	20.59
GPRS (GMSK, 1 Tx slot)	29.17	29.16	29.56	20.17	20.16	20.56
GPRS (GMSK, 2 Tx slots)	28.34	28.33	28.76	22.34	22.33	22.76
GPRS (GMSK, 3 Tx slots)	26.75	26.77	27.22	22.49	22.51	22.96
GPRS (GMSK, 4 Tx slots)	25.99	26.03	26.50	22.99	23.03	23.50
EDGE (8PSK, 1 Tx slot)	25.08	25.51	26.42	16.08	16.51	17.42
EDGE (8PSK, 2 Tx slots)	23.75	24.26	25.15	17.75	18.26	19.15
EDGE (8PSK, 3 Tx slots)	21.61	21.94	22.75	17.35	17.68	18.49
EDGE (8PSK, 4 Tx slots)	20.36	20.76	21.72	17.36	17.76	18.72

Remark: The frame-averaged power is linearly scaled the maximum burst averaged power over 8 time slots.

The calculated method are shown as below:

Frame-averaged power = Maximum burst averaged power (1 Tx Slot) - 9 dB

Frame-averaged power = Maximum burst averaged power (2 Tx Slots) - 6 dB

Frame-averaged power = Maximum burst averaged power (3 Tx Slots) - 4.26 dB

Frame-averaged power = Maximum burst averaged power (4 Tx Slots) - 3 dB



<SIM2>

Band: GSM850	Burst Average Power (dBm)			Frame-Average Power (dBm)		
Channel	128	189	251	128	189	251
Frequency (MHz)	824.2	836.4	848.8	824.2	836.4	848.8
GSM (GMSK, 1 Tx slot)	32.27	32.29	32.34	23.27	23.29	23.34
GPRS (GMSK, 1 Tx slot)	32.26	32.28	32.33	23.26	23.28	23.33
GPRS (GMSK, 2 Tx slots)	31.49	31.55	31.59	25.49	25.55	25.59
GPRS (GMSK, 3 Tx slots)	29.92	29.97	29.99	25.66	25.71	25.73
GPRS (GMSK, 4 Tx slots)	29.19	29.24	29.29	26.19	26.24	26.29
EDGE (8PSK, 1 Tx slot)	26.43	26.48	26.49	17.43	17.48	17.49
EDGE (8PSK, 2 Tx slots)	25.19	25.19	25.25	19.19	19.19	19.25
EDGE (8PSK, 3 Tx slots)	22.66	22.69	22.77	18.40	18.43	18.51
EDGE (8PSK, 4 Tx slots)	21.32	21.39	21.43	18.32	18.39	18.43
Band: GSM1900	Burst Average Power (dBm)			Frame-Average Power (dBm)		
Channel	512	661	810	512	661	810
Frequency (MHz)	1850.2	1880.0	1909.8	1850.2	1880.0	1909.8
GSM (GMSK, 1 Tx slot)	29.12	29.10	29.54	20.12	20.10	20.54
GPRS (GMSK, 1 Tx slot)	29.10	29.09	29.53	20.10	20.09	20.53
GPRS (GMSK, 2 Tx slots)	28.25	28.24	28.67	22.25	22.24	22.67
GPRS (GMSK, 3 Tx slots)	26.66	26.69	27.13	22.40	22.43	22.87
GPRS (GMSK, 4 Tx slots)	25.88	25.99	26.42	22.88	22.99	23.42
EDGE (8PSK, 1 Tx slot)	24.99	25.41	26.34	15.99	16.41	17.34
EDGE (8PSK, 2 Tx slots)	23.66	24.19	25.00	17.66	18.19	19.00
EDGE (8PSK, 3 Tx slots)	21.51	21.84	22.67	17.25	17.58	18.41
EDGE (8PSK, 4 Tx slots)	20.30	20.71	21.63	17.30	17.71	18.63

Remark: The frame-averaged power is linearly scaled the maximum burst averaged power over 8 time slots.  
The calculated method are shown as below:  
Frame-averaged power = Maximum burst averaged power (1 Tx Slot) - 9 dB  
Frame-averaged power = Maximum burst averaged power (2 Tx Slots) - 6 dB  
Frame-averaged power = Maximum burst averaged power (3 Tx Slots) - 4.26 dB  
Frame-averaged power = Maximum burst averaged power (4 Tx Slots) - 3 dB

**<WCDMA Conducted Power>**

The following tests were conducted according to the test requirements outlines in 3GPP TS 34.121 specification.

A summary of these settings are illustrated below:

**HSDPA Setup Configuration:**

- a. The EUT was connected to Base Station Agilent E5515C referred to the Setup Configuration.
- b. The RF path losses were compensated into the measurements.
- c. A call was established between EUT and Base Station with following setting:
  - i. Set Gain Factors ( $\beta_c$  and  $\beta_d$ ) and parameters were set according to each
  - ii. Specific sub-test in the following table, C10.1.4, quoted from the TS 34.121
  - iii. Set RMC 12.2Kbps + HSDPA mode.
  - iv. Set Cell Power = -86 dBm
  - v. Set HS-DSCH Configuration Type to FRC (H-set 1, QPSK)
  - vi. Select HSDPA Uplink Parameters
  - vii. Set Delta ACK, Delta NACK and Delta CQI = 8
  - viii. Set Ack-Nack Repetition Factor to 3
  - ix. Set CQI Feedback Cycle (k) to 4 ms
  - x. Set CQI Repetition Factor to 2
  - xi. Power Ctrl Mode = All Up bits
- d. The transmitted maximum output power was recorded.

**Table C.10.1.4:  $\beta$  values for transmitter characteristics tests with HS-DPCCH**

Sub-test	$\beta_c$	$\beta_d$	$\beta_d$ (SF)	$\beta_c/\beta_d$	$\beta_{HS}$ (Note 1, Note 2)	CM (dB) (Note 3)	MPR (dB) (Note 3)
1	2/15	15/15	64	2/15	4/15	0.0	0.0
2	12/15 (Note 4)	15/15 (Note 4)	64	12/15 (Note 4)	24/15	1.0	0.0
3	15/15	8/15	64	15/8	30/15	1.5	0.5
4	15/15	4/15	64	15/4	30/15	1.5	0.5

Note 1:  $\Delta_{ACK}, \Delta_{NACK}$  and  $\Delta_{CQI} = 30/15$  with  $\beta_{HS} = 30/15 * \beta_c$ .

Note 2: For the HS-DPCCH power mask requirement test in clause 5.2C, 5.7A, and the Error Vector Magnitude (EVM) with HS-DPCCH test in clause 5.13.1A, and HSDPA EVM with phase discontinuity in clause 5.13.1AA,  $\Delta_{ACK}$  and  $\Delta_{NACK} = 30/15$  with  $\beta_{HS} = 30/15 * \beta_c$ , and  $\Delta_{CQI} = 24/15$  with  $\beta_{HS} = 24/15 * \beta_c$ .

Note 3: CM = 1 for  $\beta_c/\beta_d = 12/15, \beta_{HS}/\beta_c = 24/15$ . For all other combinations of DPDCCH, DPCCH and HS-DPCCH the MPR is based on the relative CM difference. This is applicable for only UEs that support HSDPA in release 6 and later releases.

Note 4: For subtest 2 the  $\beta_c/\beta_d$  ratio of 12/15 for the TFC during the measurement period (TF1, TF0) is achieved by setting the signalled gain factors for the reference TFC (TF1, TF1) to  $\beta_c = 11/15$  and  $\beta_d = 15/15$ .

**Setup Configuration**

**HSUPA Setup Configuration:**

- a. The EUT was connected to Base Station Agilent E5515C referred to the Setup Configuration.
- b. The RF path losses were compensated into the measurements.
- c. A call was established between EUT and Base Station with following setting \* :
  - i. Call Configs = 5.2B, 5.9B, 5.10B, and 5.13.2B with QPSK
  - ii. Set the Gain Factors ( $\beta_c$  and  $\beta_d$ ) and parameters (AG Index) were set according to each specific sub-test in the following table, C11.1.3, quoted from the TS 34.121
  - iii. Set Cell Power = -86 dBm
  - iv. Set Channel Type = 12.2k + HSPA
  - v. Set UE Target Power
  - vi. Power Ctrl Mode= Alternating bits
  - vii. Set and observe the E-TFCl
  - viii. Confirm that E-TFCl is equal to the target E-TFCl of 75 for sub-test 1, and other subtest's E-TFCl
- d. The transmitted maximum output power was recorded.

**Table C.11.1.3:  $\beta$  values for transmitter characteristics tests with HS-DPCCH and E-DCH**

Sub-test	$\beta_c$	$\beta_d$	$\beta_d$ (SF)	$\beta_c/\beta_d$	$\beta_{HS}$ (Note 1)	$\beta_{ec}$	$\beta_{ed}$ (Note 5) (Note 6)	$\beta_{ed}$ (SF)	$\beta_{ed}$ (Codes)	CM (dB) (Note 2)	MPR (dB) (Note 2)	AG Index (Note 6)	E-TFCl
1	11/15 (Note 3)	15/15 (Note 3)	64	11/15 (Note 3)	22/15	209/225	1309/225	4	1	1.0	0.0	20	75
2	6/15	15/15	64	6/15	12/15	12/15	94/75	4	1	3.0	2.0	12	67
3	15/15	9/15	64	15/9	30/15	30/15	$\beta_{ed1}: 47/15$ $\beta_{ed2}: 47/15$	4	2	2.0	1.0	15	92
4	2/15	15/15	64	2/15	4/15	2/15	56/75	4	1	3.0	2.0	17	71
5	15/15 (Note 4)	15/15 (Note 4)	64	15/15 (Note 4)	30/15	24/15	134/15	4	1	1.0	0.0	21	81

Note 1:  $\Delta_{ACK}, \Delta_{NACK}$  and  $\Delta_{CQI} = 30/15$  with  $\beta_{hs} = 30/15 * \beta_c$ .

Note 2: CM = 1 for  $\beta_c/\beta_d = 12/15, \beta_{hs}/\beta_c = 24/15$ . For all other combinations of DPDCH, DPCCH, HS- DPCCH, E-DPDCH and E-DPCCH the MPR is based on the relative CM difference.

Note 3: For subtest 1 the  $\beta_c/\beta_d$  ratio of 11/15 for the TFC during the measurement period (TF1, TF0) is achieved by setting the signalled gain factors for the reference TFC (TF1, TF1) to  $\beta_c = 10/15$  and  $\beta_d = 15/15$ .

Note 4: For subtest 5 the  $\beta_c/\beta_d$  ratio of 15/15 for the TFC during the measurement period (TF1, TF0) is achieved by setting the signalled gain factors for the reference TFC (TF1, TF1) to  $\beta_c = 14/15$  and  $\beta_d = 15/15$ .

Note 5: In case of testing by UE using E-DPDCH Physical Layer category 1, Sub-test 3 is omitted according to TS25.306 Table 5.1g.

Note 6:  $\beta_{ed}$  can not be set directly, it is set by Absolute Grant Value.

**Setup Configuration**



<WCDMA Conducted Power>

Note:

1. Applying the subtest setup in Table C10.1.4 and Table C.11.1.3 of 3GPP TS 34.121-1 V9.1.0 to Rel. 6 HSPA.
2. Per KDB 941225 D01v02, RMC 12.2kbps setting is used to evaluate SAR. If AMR 12.2kbps power is < 0.25dB higher than RMC 12.2kbps, SAR tests with AMR 12.2kbps can be excluded.
3. By design, AMR, HSDPA/HSUPA RF power will not be larger than RMC 12.2kbps, detailed information is included in Tune-up Procure exhibit.
4. It is expected by the manufacturer that MPR for some HSDPA/HSUPA subtests may differ from the specification of 3GPP, according to the chipset implementation in this model. The implementation and expected deviation are detailed in tune-up procedure exhibit.

<SIM1>

Band		WCDMA Band V			WCDMA Band II		
Tx Channel		4132	4182	4233	9262	9400	9538
Rx Channel		4357	4407	4458	9662	9800	9938
Frequency (MHz)		826.4	836.4	846.6	1852.4	1880	1907.6
3GPP Rel 99	AMR	23.55	23.48	23.41	23.20	23.08	23.01
3GPP Rel 99	RMC 12.2Kbps	23.56	23.50	23.42	23.22	23.10	23.02
3GPP Rel 6	HSDPA Subtest-1	22.61	22.59	22.50	22.27	22.12	22.11
3GPP Rel 6	HSDPA Subtest-2	22.62	22.58	22.51	22.30	22.15	22.08
3GPP Rel 6	HSDPA Subtest-3	22.15	22.13	22.05	21.83	21.71	21.65
3GPP Rel 6	HSDPA Subtest-4	22.14	22.10	22.03	21.82	21.68	21.64
3GPP Rel 6	HSUPA Subtest-1	20.98	20.55	20.49	20.12	20.05	20.11
3GPP Rel 6	HSUPA Subtest-2	20.18	20.13	20.06	19.85	19.72	19.73
3GPP Rel 6	HSUPA Subtest-3	21.02	21.05	20.97	20.61	20.56	20.58
3GPP Rel 6	HSUPA Subtest-4	20.67	20.63	20.56	20.30	20.16	20.16
3GPP Rel 6	HSUPA Subtest-5	21.28	21.30	21.26	20.57	20.40	20.78
3GPP MPR specification	MPR result	WCDMA Band V			WCDMA Band II		
0	HSDPA Subtest-1	0.00	0.00	0.00	0.00	0.00	0.00
0	HSDPA Subtest-2	-0.01	0.01	-0.01	-0.03	-0.03	0.03
≤ 0.5	HSDPA Subtest-3	0.46	0.46	0.45	0.44	0.41	0.46
≤ 0.5	HSDPA Subtest-4	0.47	0.49	0.47	0.45	0.44	0.47
≤ 0	HSUPA Subtest-1	0.30	0.75	0.77	0.45	0.35	0.67
≤ 2	HSUPA Subtest-2	1.10	1.17	1.20	0.72	0.68	1.05
≤ 1	HSUPA Subtest-3	0.26	0.25	0.29	-0.04	-0.16	0.20
≤ 2	HSUPA Subtest-4	0.61	0.67	0.70	0.27	0.24	0.62
≤ 0	HSUPA Subtest-5	0.00	0.00	0.00	0.00	0.00	0.00



Band		WCDMA Band IV		
Tx Channel		1312	1413	1513
Rx Channel		1537	1638	1738
Frequency (MHz)		1712.4	1732.6	1752.6
3GPP Rel 99	AMR	23.01	22.84	22.98
3GPP Rel 99	RMC 12.2Kbps	23.02	22.85	22.99
3GPP Rel 6	HSDPA Subtest-1	22.01	21.78	21.96
3GPP Rel 6	HSDPA Subtest-2	22.02	21.77	21.98
3GPP Rel 6	HSDPA Subtest-3	21.78	21.53	21.75
3GPP Rel 6	HSDPA Subtest-4	21.76	21.63	21.83
3GPP Rel 6	HSUPA Subtest-1	19.91	20.06	20.14
3GPP Rel 6	HSUPA Subtest-2	19.63	19.71	18.60
3GPP Rel 6	HSUPA Subtest-3	20.65	20.54	20.67
3GPP Rel 6	HSUPA Subtest-4	19.14	19.76	19.18
3GPP Rel 6	HSUPA Subtest-5	20.46	20.81	20.58
3GPP MPR specification	MPR result	WCDMA Band IV		
0	HSDPA Subtest-1	0.00	0.00	0.00
0	HSDPA Subtest-2	-0.01	0.01	-0.02
≤ 0.5	HSDPA Subtest-3	0.23	0.25	0.21
≤ 0.5	HSDPA Subtest-4	0.25	0.15	0.13
≤ 0	HSUPA Subtest-1	0.55	0.75	0.44
≤ 2	HSUPA Subtest-2	0.83	1.10	1.98
≤ 1	HSUPA Subtest-3	-0.19	0.27	-0.09
≤ 2	HSUPA Subtest-4	1.32	1.05	1.40
≤ 0	HSUPA Subtest-5	0.00	0.00	0.00

<SIM2>

Band		WCDMA Band V			WCDMA Band II		
Tx Channel		4132	4182	4233	9262	9400	9538
Rx Channel		4357	4407	4458	9662	9800	9938
Frequency (MHz)		826.4	836.4	846.6	1852.4	1880	1907.6
3GPP Rel 99	AMR	23.48	23.40	23.38	23.10	23.06	23.00
3GPP Rel 99	RMC 12.2Kbps	23.49	23.42	23.40	23.12	23.08	23.00
3GPP Rel 6	HSDPA Subtest-1	22.53	22.54	22.48	22.25	22.10	22.07
3GPP Rel 6	HSDPA Subtest-2	22.51	22.49	22.41	22.24	22.11	22.07
3GPP Rel 6	HSDPA Subtest-3	22.12	21.99	22.00	21.80	21.70	21.60
3GPP Rel 6	HSDPA Subtest-4	22.11	21.97	22.01	21.72	21.66	21.63
3GPP Rel 6	HSUPA Subtest-1	20.95	20.47	20.47	20.09	20.03	20.09
3GPP Rel 6	HSUPA Subtest-2	20.12	20.10	20.01	19.80	19.70	19.69
3GPP Rel 6	HSUPA Subtest-3	21.00	21.01	20.92	20.56	20.51	20.49
3GPP Rel 6	HSUPA Subtest-4	20.65	20.60	20.51	20.23	20.10	20.15
3GPP Rel 6	HSUPA Subtest-5	21.22	21.23	21.22	20.52	20.34	20.68
3GPP MPR specification	MPR result	WCDMA Band V			WCDMA Band II		
0	HSDPA Subtest-1	0.00	0.00	0.00	0.00	0.00	0.00
0	HSDPA Subtest-2	0.02	0.05	0.07	0.01	-0.01	0.00
≤ 0.5	HSDPA Subtest-3	0.41	0.55	0.48	0.45	0.40	0.47
≤ 0.5	HSDPA Subtest-4	0.42	0.57	0.47	0.53	0.44	0.44
≤ 0	HSUPA Subtest-1	0.27	0.76	0.75	0.43	0.31	0.59
≤ 2	HSUPA Subtest-2	1.10	1.13	1.21	0.72	0.64	0.99
≤ 1	HSUPA Subtest-3	0.22	0.22	0.30	-0.04	-0.17	0.19
≤ 2	HSUPA Subtest-4	0.57	0.63	0.71	0.29	0.24	0.53
≤ 0	HSUPA Subtest-5	0.00	0.00	0.00	0.00	0.00	0.00





Band		WCDMA Band IV		
Tx Channel		1312	1413	1513
Rx Channel		1537	1638	1738
Frequency (MHz)		1712.4	1732.6	1752.6
3GPP Rel 99	AMR	22.93	22.77	22.94
3GPP Rel 99	RMC 12.2Kbps	22.95	22.79	22.96
3GPP Rel 6	HSDPA Subtest-1	21.99	21.77	21.87
3GPP Rel 6	HSDPA Subtest-2	21.98	21.69	21.89
3GPP Rel 6	HSDPA Subtest-3	21.73	21.43	21.66
3GPP Rel 6	HSDPA Subtest-4	21.69	21.53	21.74
3GPP Rel 6	HSUPA Subtest-1	19.83	19.96	20.08
3GPP Rel 6	HSUPA Subtest-2	19.56	19.68	18.57
3GPP Rel 6	HSUPA Subtest-3	20.62	20.51	20.63
3GPP Rel 6	HSUPA Subtest-4	19.06	19.72	19.12
3GPP Rel 6	HSUPA Subtest-5	20.41	20.78	20.52
3GPP MPR specification	MPR result	WCDMA Band IV		
0	HSDPA Subtest-1	0.00	0.00	0.00
0	HSDPA Subtest-2	0.01	0.08	-0.02
≤ 0.5	HSDPA Subtest-3	0.26	0.34	0.21
≤ 0.5	HSDPA Subtest-4	0.30	0.24	0.13
≤ 0	HSUPA Subtest-1	0.58	0.82	0.44
≤ 2	HSUPA Subtest-2	0.85	1.10	1.95
≤ 1	HSUPA Subtest-3	-0.21	0.27	-0.11
≤ 2	HSUPA Subtest-4	1.35	1.06	1.40
≤ 0	HSUPA Subtest-5	0.00	0.00	0.00

<WLAN 2.4GHz Band Conducted Power>

General Note:

1. Per KDB 248227 D01 v01r02, choose the highest output power channel to test SAR and determine further SAR exclusion
2. For each frequency band, testing at higher data rates and higher order modulations is not required when the maximum average output power for each of these configurations is less than 1/4dB higher than those measured at the lowest data rate
3. Per KDB 248227 D01 v01r02, 11g, 11n-HT20 and 11n-HT40 output power is less than 1/4dB higher than 11b mode, thus the SAR can be excluded.

802.11b Average Power (dBm)					
Channel	Frequency (MHz)	Data Rate (bps)			
		1M bps	2M bps	5.5M bps	11M bps
CH 01	2412	11.94	11.84	11.93	11.95
CH 06	2437	11.38	11.37	11.43	11.38
CH 11	2462	12.01	11.94	11.99	11.97

802.11g Average Power (dBm)									
Channel	Frequency (MHz)	Data Rate (bps)							
		6M bps	9M bps	12M bps	18M bps	24M bps	36M bps	48M bps	54M bps
CH 01	2412	7.01	6.76	6.80	6.86	6.92	6.77	6.89	6.87
CH 06	2437	8.73	8.52	8.56	8.62	8.68	8.53	8.65	8.48
CH 11	2462	7.12	6.96	6.91	7.05	7.08	6.96	7.04	7.10

WLAN 2.4GHz Band 802.11n-HT20 Average Power (dBm)									
Channel	Frequency (MHz)	MCS Index							
		MCS0	MCS1	MCS2	MCS3	MCS4	MCS5	MCS6	MCS7
CH 01	2412	6.83	6.81	6.85	6.81	6.80	6.78	6.71	6.81
CH 06	2437	8.69	8.63	8.60	8.63	8.58	8.55	8.39	8.55
CH 11	2462	7.28	7.20	7.13	7.21	7.12	7.10	7.13	7.21

WLAN 2.4GHz Band 802.11n-HT40 Average Power (dBm)									
Channel	Frequency (MHz)	MCS Index							
		MCS0	MCS1	MCS2	MCS3	MCS4	MCS5	MCS6	MCS7
CH 03	2422	5.58	5.48	5.40	5.52	5.56	5.54	5.39	5.39
CH 06	2437	7.56	7.22	7.36	7.54	7.51	7.50	7.36	7.34
CH 09	2452	5.81	5.75	5.68	5.73	5.73	5.75	5.70	5.75

<Bluetooth Conducted Power>

Bluetooth average power (dBm)				
Mode	1Mbps (GFSK)	2Mbps (π/4-DQPSK)	3Mbps (8-DPSK)	BT4.0-LE (GFSK)
Tune Up Limit	0.5	0	0	-7

Note:

1. Per KDB 447498 D01v05r01, the 1-g and 10-g SAR test exclusion thresholds for 100 MHz to 6 GHz at test separation distances ≤ 50 mm are determined by:

$$[(\text{max. power of channel, including tune-up tolerance, mW}) / (\text{min. test separation distance, mm})] \cdot [\sqrt{f(\text{GHz})}] \leq 3.0 \text{ for 1-g SAR and } \leq 7.5 \text{ for 10-g extremity SAR}$$

- f(GHz) is the RF channel transmit frequency in GHz
- Power and distance are rounded to the nearest mW and mm before calculation
- The result is rounded to one decimal place for comparison
- If the distance of the antenna to the user is < 5mm, 5mm is used to determine SAR exclusion threshold

Bluetooth Max Power (dBm)	mW	Test Distance (mm)	Frequency (GHz)	exclusion thresholds
0.5	1.00	0	2.48	0.31
		10	2.48	0.16

2. Per KDB 447498 D01v05r01 exclusion thresholds is 0.31 < 3, RF exposure evaluation is not required.

### 11. Antenna Location

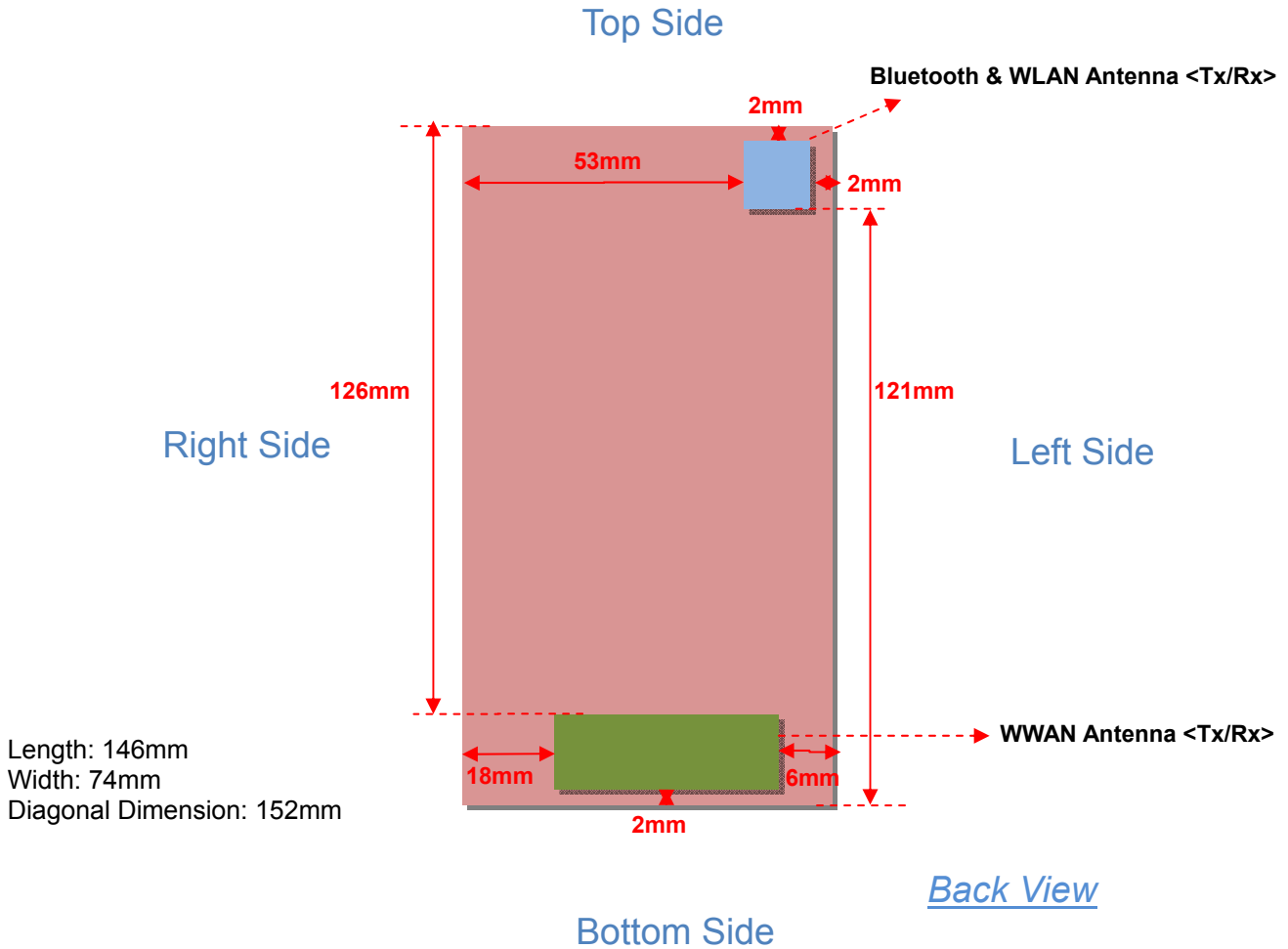

Antennas	Wireless Interface
WWAN Antenna <Tx / Rx>	GSM850 GSM1900 WCDMA Band V WCDMA Band IV WCDMA Band II
Bluetooth & WLAN Antenna <Tx / Rx>	WLAN 2.4GHz Band Bluetooth

Distance of the Antenna to the EUT surface/edge						
Antennas	Back	Front	Top Side	Bottom Side	Right Side	Left Side
<b>WWAN</b>	≤ 25mm	≤ 25mm	126mm	≤ 25mm	≤ 25mm	≤ 25mm
<b>Bluetooth &amp; WLAN</b>	≤ 25mm	≤ 25mm	≤ 25mm	121mm	53mm	≤ 25mm

Positions for SAR tests; Hotspot mode Test distance: 10 mm						
Antennas	Back	Front	Top Side	Bottom Side	Right Side	Left Side
<b>WWAN</b>	Yes	Yes	NO	Yes	Yes	Yes
<b>Bluetooth &amp; WLAN</b>	Yes	Yes	Yes	NO	NO	Yes

**Note:**

1. Head/Body-worn/Hotspot mode SAR assessments are required.
2. Referring to KDB 941225 D06 v01r01, when the overall device length and width are ≥ 9cm\*5cm, the test distance is 10 mm. SAR must be measured for all sides and surfaces with a transmitting antenna located within 25mm from that surface or edge
3. Per KDB 447498 D01v05r01, for handsets the *test separation distance* is determined by the smallest distance between the outer surface of the device and the user; which is 0mm for head SAR, 10mm for hotspot SAR, 10mm for body-worn SAR.



## 12. SAR Test Results

**Note:**

1. Per KDB 447498 D01v05r01, the reported SAR is the measured SAR value adjusted for maximum tune-up tolerance.
  - a. Tune-up scaling Factor = tune-up limit power (mW) / EUT RF power (mW), where tune-up limit is the maximum rated power among all production units.
  - b. Reported SAR(W/kg)= Measured SAR(W/kg)\*Tune-up Scaling Factor
2. Per KDB 447498 D01v05r01, for each exposure position, if the highest output channel reported SAR ≤0.8W/kg, other channels SAR testing is not necessary.
3. For Hotspot SAR testing, per KDB 941225 D06v01r01, for EUT dimension ≥ 9cm\*5cm, the test distance is 1cm. SAR must be measured for all surfaces and sides with a transmitting antenna located within 2.5cm from that surface or edge.
4. Body-worn exposure conditions are intended to voice call and GPRS operations, therefore GSM voice call and GPRS modes are selected to be tested.
5. Pre KDB648474 D04v02, When the reported SAR for a body-worn accessory for GSM Voice, measured without a headset connected to the handset, is > 1.2 W/kg, the highest reported SAR configuration for that wireless mode and frequency band should be repeated for that body-worn accessory with a headset attached to the handset.
6. Though per KDB 648474 D04v02, when the reported SAR for a body-worn accessory measured without a headset connected to the handset is ≤ 1.2 W/kg, the SAR testing with a headset connected to the handset is not required, but considered the simultaneous SAR for body-worn, we still perform the WLAN SAR with headset mode.
7. Per KDB 941225 D02v02r02, RMC 12.2kbps setting is used to evaluate SAR. If HSDPA/HSUPA output power is < 0.25dB higher than RMC, or reported SAR with RMC 12.2kbps setting is ≤ 1.2W/kg, HSDPA/HSUPA SAR evaluation can be excluded.

### 12.1 Head SAR

**<GSM SAR>**

Plot No.	Band	Mode	Test Position	Ch.	Freq. (MHz)	Average Power (dBm)	Tune-Up Limit (dBm)	Scaling Factor	Power Drift (dB)	Measured 1g SAR (W/kg)	Reported 1g SAR (W/kg)
59	GSM850	GSM Voice	Right Cheek	251	848.8	32.53	33.5	1.250	-0.11	0.326	0.408
60	GSM850	GSM Voice	Right Tilted	251	848.8	32.53	33.5	1.250	-0.07	0.223	0.279
61	GSM850	GSM Voice	Left Cheek	251	848.8	32.53	33.5	1.250	0.02	0.279	0.349
62	GSM850	GSM Voice	Left Tilted	251	848.8	32.53	33.5	1.250	-0.01	0.213	0.266
55	GSM1900	GSM Voice	Right Cheek	810	1909.8	29.59	30.5	1.233	-0.15	0.072	0.089
56	GSM1900	GSM Voice	Right Tilted	810	1909.8	29.59	30.5	1.233	-0.18	0.047	0.058
57	GSM1900	GSM Voice	Left Cheek	810	1909.8	29.59	30.5	1.233	-0.07	0.087	0.107
58	GSM1900	GSM Voice	Left Tilted	810	1909.8	29.59	30.5	1.233	-0.09	0.046	0.057



<WCDMA SAR>

Plot No.	Band	Mode	Test Position	Ch.	Freq. (MHz)	Average Power (dBm)	Tune-Up Limit (dBm)	Scaling Factor	Power Drift (dB)	Measured 1g SAR (W/kg)	Reported 1g SAR (W/kg)
63	WCDMA Band V	RMC12.2K	Right Cheek	4132	826.4	23.56	24.5	1.242	0.01	0.211	0.262
64	WCDMA Band V	RMC12.2K	Right Tilted	4132	826.4	23.56	24.5	1.242	0.04	0.149	0.185
65	WCDMA Band V	RMC12.2K	Left Cheek	4132	826.4	23.56	24.5	1.242	0.12	0.188	0.233
66	WCDMA Band V	RMC12.2K	Left Tilted	4132	826.4	23.56	24.5	1.242	0.06	0.141	0.175
47	WCDMA Band IV	RMC 12.2K	Right Cheek	1312	1712.4	23.02	24	1.253	-0.09	0.134	0.168
48	WCDMA Band IV	RMC 12.2K	Right Tilted	1312	1712.4	23.02	24	1.253	0.02	0.096	0.120
49	WCDMA Band IV	RMC 12.2K	Left Cheek	1312	1712.4	23.02	24	1.253	0.12	0.155	0.194
50	WCDMA Band IV	RMC 12.2K	Left Cheek	1312	1712.4	23.02	24	1.253	-0.04	0.098	0.123
51	WCDMA Band II	RMC 12.2K	Right Cheek	9262	1852.4	23.22	24	1.197	-0.08	0.196	0.235
52	WCDMA Band II	RMC 12.2K	Right Tilted	9262	1852.4	23.22	24	1.197	-0.1	0.096	0.115
53	WCDMA Band II	RMC 12.2K	Left Cheek	9262	1852.4	23.22	24	1.197	-0.16	0.209	0.250
54	WCDMA Band II	RMC 12.2K	Left Cheek	9262	1852.4	23.22	24	1.197	-0.13	0.125	0.150

<WLAN 2.4GHz SAR>

Plot No.	Band	Mode	Test Position	Ch.	Freq. (MHz)	Average Power (dBm)	Tune-Up Limit (dBm)	Scaling Factor	Power Drift (dB)	Measured 1g SAR (W/kg)	Reported 1g SAR (W/kg)
67	WLAN 2.4GHz	802.11b	Right Cheek	11	2462	12.01	12.5	1.119	0.09	1.080	1.209
68	WLAN 2.4GHz	802.11b	Right Tilted	11	2462	12.01	12.5	1.119	-0.11	0.682	0.763
69	WLAN 2.4GHz	802.11b	Left Cheek	11	2462	12.01	12.5	1.119	0.08	0.401	0.449
70	WLAN 2.4GHz	802.11b	Left Tilted	11	2462	12.01	12.5	1.119	0.09	0.302	0.338
71	WLAN 2.4GHz	802.11b	Right Cheek	1	2412	11.94	12.5	1.138	0.12	0.931	1.059
72	WLAN 2.4GHz	802.11b	Right Cheek	6	2437	11.38	12.5	1.294	0.04	1.030	1.333

**12.2 Hotspot SAR**

**<GSM SAR>**

Plot No.	Band	Mode	Test Position	Gap (cm)	Ch.	Freq. (MHz)	Average Power (dBm)	Tune-Up Limit (dBm)	Scaling Factor	Power Drift (dB)	Measured 1g SAR (W/kg)	Reported 1g SAR (W/kg)
24	GSM850	GPRS(GMSK 4 Tx slots)	Front	1	251	848.8	29.46	30.5	1.271	-0.04	0.704	0.894
<b>25</b>	<b>GSM850</b>	<b>GPRS(GMSK 4 Tx slots)</b>	<b>Back</b>	<b>1</b>	<b>251</b>	<b>848.8</b>	<b>29.46</b>	<b>30.5</b>	<b>1.271</b>	<b>-0.04</b>	<b>1.090</b>	<b>1.385</b>
26	GSM850	GPRS(GMSK 4 Tx slots)	Left side	1	251	848.8	29.46	30.5	1.271	-0.01	0.516	0.656
27	GSM850	GPRS(GMSK 4 Tx slots)	Right side	1	251	848.8	29.46	30.5	1.271	-0.02	0.777	0.987
28	GSM850	GPRS(GMSK 4 Tx slots)	Bottom side	1	251	848.8	29.46	30.5	1.271	-0.07	0.173	0.220
29	GSM850	GPRS(GMSK 4 Tx slots)	Front	1	128	824.2	29.35	30.5	1.303	0.01	0.394	0.513
30	GSM850	GPRS(GMSK 4 Tx slots)	Front	1	189	836.4	29.39	30.5	1.291	-0.01	0.548	0.708
31	GSM850	GPRS(GMSK 4 Tx slots)	Back	1	128	824.2	29.35	30.5	1.303	0.03	0.722	0.941
32	GSM850	GPRS(GMSK 4 Tx slots)	Back	1	189	836.4	29.39	30.5	1.291	0.03	0.908	1.172
33	GSM850	GPRS(GMSK 4 Tx slots)	Right side	1	128	824.2	29.35	30.5	1.303	-0.01	0.456	0.594
34	GSM850	GPRS(GMSK 4 Tx slots)	Right side	1	189	836.4	29.39	30.5	1.291	0.02	0.600	0.775
1	GSM1900	GPRS(GMSK 4 Tx slots)	Front	1	810	1909.8	26.5	27.5	1.259	0.08	0.380	0.478
2	GSM1900	GPRS(GMSK 4 Tx slots)	Back	1	810	1909.8	26.5	27.5	1.259	-0.16	0.895	1.127
3	GSM1900	GPRS(GMSK 4 Tx slots)	Left side	1	810	1909.8	26.5	27.5	1.259	-0.11	0.149	0.188
4	GSM1900	GPRS(GMSK 4 Tx slots)	Right side	1	810	1909.8	26.5	27.5	1.259	-0.05	0.094	0.118
5	GSM1900	GPRS(GMSK 4 Tx slots)	Bottom side	1	810	1909.8	26.5	27.5	1.259	-0.03	0.882	1.110
6	GSM1900	GPRS(GMSK 4 Tx slots)	Back	1	512	18502	25.99	27.5	1.416	-0.01	0.822	1.164
7	GSM1900	GPRS(GMSK 4 Tx slots)	Back	1	661	1880	26.03	27.5	1.403	0.08	0.842	1.181
<b>8</b>	<b>GSM1900</b>	<b>GPRS(GMSK 4 Tx slots)</b>	<b>Bottom side</b>	<b>1</b>	<b>512</b>	<b>18502</b>	<b>25.99</b>	<b>27.5</b>	<b>1.416</b>	<b>-0.05</b>	<b>0.842</b>	<b>1.192</b>
9	GSM1900	GPRS(GMSK 4 Tx slots)	Bottom side	1	661	1880	26.03	27.5	1.403	-0.12	0.835	1.171

**<WCDMA SAR>**

Plot No.	Band	Mode	Test Position	Gap (cm)	Ch.	Freq. (MHz)	Average Power (dBm)	Tune-Up Limit (dBm)	Scaling Factor	Power Drift (dB)	Measured 1g SAR (W/kg)	Reported 1g SAR (W/kg)
36	WCDMA Band V	RMC 12.2K	Front	1	4132	826.4	23.56	24.5	1.242	-0.01	0.303	0.376
<b>37</b>	<b>WCDMA Band V</b>	<b>RMC 12.2K</b>	<b>Back</b>	<b>1</b>	<b>4132</b>	<b>826.4</b>	<b>23.56</b>	<b>24.5</b>	<b>1.242</b>	<b>-0.02</b>	<b>0.479</b>	<b>0.595</b>
38	WCDMA Band V	RMC 12.2K	Left side	1	4132	826.4	23.56	24.5	1.242	0.01	0.221	0.274
39	WCDMA Band V	RMC 12.2K	Right side	1	4132	826.4	23.56	24.5	1.242	0.02	0.323	0.401
40	WCDMA Band V	RMC 12.2K	Bottom side	1	4132	826.4	23.56	24.5	1.242	0.09	0.052	0.065
42	WCDMA Band IV	RMC12.2K	Front	1	1312	1712.4	23.02	24	1.253	0.04	0.201	0.252
43	WCDMA Band IV	RMC12.2K	Back	1	1312	1712.4	23.02	24	1.253	-0.06	0.396	0.496
44	WCDMA Band IV	RMC12.2K	Left side	1	1312	1712.4	23.02	24	1.253	-0.02	0.101	0.127
45	WCDMA Band IV	RMC12.2K	Right side	1	1312	1712.4	23.02	24	1.253	-0.04	0.071	0.089
<b>46</b>	<b>WCDMA Band IV</b>	<b>RMC12.2K</b>	<b>Bottom side</b>	<b>1</b>	<b>1312</b>	<b>1712.4</b>	<b>23.02</b>	<b>24</b>	<b>1.253</b>	<b>-0.04</b>	<b>0.461</b>	<b>0.578</b>
11	WCDMA Band II	RMC12.2K	Front	1	9262	1852.4	23.22	24	1.197	-0.02	0.503	0.602
12	WCDMA Band II	RMC12.2K	Back	1	9262	1852.4	23.22	24	1.197	-0.06	1.080	1.292
13	WCDMA Band II	RMC12.2K	Left side	1	9262	1852.4	23.22	24	1.197	-0.11	0.191	0.229
14	WCDMA Band II	RMC12.2K	Right side	1	9262	1852.4	23.22	24	1.197	-0.12	0.116	0.139
15	WCDMA Band II	RMC12.2K	Bottom side	1	9262	1852.4	23.22	24	1.197	-0.1	1.080	1.292
<b>16</b>	<b>WCDMA Band II</b>	<b>RMC12.2K</b>	<b>Back</b>	<b>1</b>	<b>9400</b>	<b>1880</b>	<b>23.1</b>	<b>24</b>	<b>1.230</b>	<b>-0.11</b>	<b>1.120</b>	<b>1.378</b>
17	WCDMA Band II	RMC12.2K	Back	1	9538	1907.6	23.02	24	1.253	-0.02	1.010	1.266
21	WCDMA Band II	RMC12.2K	Bottom side	1	9400	1880	23.1	24	1.230	-0.09	1.090	1.341
22	WCDMA Band II	RMC12.2K	Bottom side	1	9538	1907.6	23.02	24	1.253	-0.13	0.994	1.246



<WLAN2.4GHz SAR>

Plot No.	Band	Mode	Test Position	Gap (cm)	Ch.	Freq. (MHz)	Average Power (dBm)	Tune-Up Limit (dBm)	Scaling Factor	Power Drift (dB)	Measured 1g SAR (W/kg)	Reported 1g SAR (W/kg)
73	WLAN 2.4GHz	802.11b	Front	1	11	2462	12.01	12.5	1.119	0.01	0.259	0.290
74	WLAN 2.4GHz	802.11b	Back	1	11	2462	12.01	12.5	1.119	-0.09	0.222	0.249
75	WLAN 2.4GHz	802.11b	Left side	1	11	2462	12.01	12.5	1.119	0.12	0.163	0.182
77	WLAN 2.4GHz	802.11b	Top side	1	11	2462	12.01	12.5	1.119	-0.05	0.075	0.084



**12.3 Body Worn SAR**

**<GSM SAR>**

Plot No.	Band	Mode	Test Position	Gap (cm)	Headset	Ch.	Freq. (MHz)	Average Power (dBm)	Tune-Up Limit (dBm)	Scaling Factor	Power Drift (dB)	Measured 1g SAR (W/kg)	Reported 1g SAR (W/kg)
24	GSM850	GPRS(GMSK 4 Tx slots)	Front	1	-	251	848.8	29.46	30.5	1.271	-0.04	0.704	0.894
<b>25</b>	<b>GSM850</b>	<b>GPRS(GMSK 4 Tx slots)</b>	<b>Back</b>	<b>1</b>	<b>-</b>	<b>251</b>	<b>848.8</b>	<b>29.46</b>	<b>30.5</b>	<b>1.271</b>	<b>-0.04</b>	<b>1.090</b>	<b>1.385</b>
29	GSM850	GPRS(GMSK 4 Tx slots)	Front	1	-	128	824.2	29.35	30.5	1.303	0.01	0.394	0.513
30	GSM850	GPRS(GMSK 4 Tx slots)	Front	1	-	189	836.4	29.39	30.5	1.291	-0.01	0.548	0.708
31	GSM850	GPRS(GMSK 4 Tx slots)	Back	1	-	128	824.2	29.35	30.5	1.303	0.03	0.722	0.941
32	GSM850	GPRS(GMSK 4 Tx slots)	Back	1	-	189	836.4	29.39	30.5	1.291	0.03	0.908	1.172
35	GSM850	GSM Voice	Back	1	-	251	848.8	32.53	33.5	1.250	-0.01	0.571	0.714
1	GSM1900	GPRS(GMSK 4 Tx slots)	Front	1	-	810	1909.8	26.5	27.5	1.259	0.08	0.380	0.478
2	GSM1900	GPRS(GMSK 4 Tx slots)	Back	1	-	810	1909.8	26.5	27.5	1.259	-0.16	0.895	1.127
6	GSM1900	GPRS(GMSK 4 Tx slots)	Back	1	-	512	18502	25.99	27.5	1.416	-0.01	0.822	1.164
<b>7</b>	<b>GSM1900</b>	<b>GPRS(GMSK 4 Tx slots)</b>	<b>Back</b>	<b>1</b>	<b>-</b>	<b>661</b>	<b>1880</b>	<b>26.03</b>	<b>27.5</b>	<b>1.403</b>	<b>0.08</b>	<b>0.842</b>	<b>1.181</b>
10	GSM1900	GSM Voice	Back	1	-	810	1909.8	29.59	30.5	1.233	-0.06	0.486	0.599

**<WCDMA SAR>**

Plot No.	Band	Mode	Test Position	Gap (cm)	Headset	Ch.	Freq. (MHz)	Average Power (dBm)	Tune-Up Limit (dBm)	Scaling Factor	Power Drift (dB)	Measured 1g SAR (W/kg)	Reported 1g SAR (W/kg)
36	WCDMA Band V	RMC 12.2K	Front	1	-	4132	826.4	23.56	24.5	1.242	-0.01	0.303	0.376
<b>37</b>	<b>WCDMA Band V</b>	<b>RMC 12.2K</b>	<b>Back</b>	<b>1</b>	<b>-</b>	<b>4132</b>	<b>826.4</b>	<b>23.56</b>	<b>24.5</b>	<b>1.242</b>	<b>-0.02</b>	<b>0.479</b>	<b>0.595</b>
42	WCDMA Band IV	RMC12.2K	Front	1	-	1312	1712.4	23.02	24	1.253	0.04	0.201	0.252
<b>43</b>	<b>WCDMA Band IV</b>	<b>RMC12.2K</b>	<b>Back</b>	<b>1</b>	<b>-</b>	<b>1312</b>	<b>1712.4</b>	<b>23.02</b>	<b>24</b>	<b>1.253</b>	<b>-0.06</b>	<b>0.396</b>	<b>0.496</b>
11	WCDMA Band II	RMC12.2K	Front	1	-	9262	1852.4	23.22	24	1.197	-0.02	0.503	0.602
12	WCDMA Band II	RMC12.2K	Back	1	-	9262	1852.4	23.22	24	1.197	-0.06	1.080	1.292
<b>16</b>	<b>WCDMA Band II</b>	<b>RMC12.2K</b>	<b>Back</b>	<b>1</b>	<b>-</b>	<b>9400</b>	<b>1880</b>	<b>23.1</b>	<b>24</b>	<b>1.230</b>	<b>-0.11</b>	<b>1.120</b>	<b>1.378</b>
17	WCDMA Band II	RMC12.2K	Back	1	-	9538	1907.6	23.02	24	1.253	-0.02	1.010	1.266
18	WCDMA Band II	RMC12.2K	Back	1	Headset	9400	1880	23.1	24	1.230	-0.08	1.070	1.316
19	WCDMA Band II	RMC12.2K	Back	1	Headset	9262	1852.4	23.22	24	1.197	-0.03	1.040	1.245
20	WCDMA Band II	RMC12.2K	Back	1	Headset	9538	1907.6	23.02	24	1.253	-0.07	1.000	1.253

**<WLAN 2.4GHz SAR>**

Plot No.	Band	Mode	Test Position	Gap (cm)	Headset	Ch.	Freq. (MHz)	Average Power (dBm)	Tune-Up Limit (dBm)	Scaling Factor	Power Drift (dB)	Measured 1g SAR (W/kg)	Reported 1g SAR (W/kg)
<b>73</b>	<b>WLAN 2.4GHz</b>	<b>802.11b</b>	<b>Front</b>	<b>1</b>	<b>-</b>	<b>11</b>	<b>2462</b>	<b>12.01</b>	<b>12.5</b>	<b>1.119</b>	<b>0.01</b>	<b>0.259</b>	<b>0.290</b>
74	WLAN 2.4GHz	802.11b	Back	1	-	11	2462	12.01	12.5	1.119	-0.09	0.222	0.249
78	WLAN 2.4GHz	802.11b	Back	1	Headset	11	2462	12.01	12.5	1.119	0.1	0.180	0.201



12.4 Repeated SAR Measurement

Plot No.	Band	Mode	Test Position	Gap (cm)	Ch.	Freq. (MHz)	Average Power (dBm)	Tune-Up Limit (dBm)	Scaling Factor	Power Drift (dB)	Measured 1g SAR (W/kg)	Ratio	Reported 1g SAR (W/kg)
67	WLAN 2.4GHz	802.11b	Right Cheek	-	11	2462	12.01	12.5	1.119	0.09	1.080	1	1.209
79	WLAN 2.4GHz	802.11b	Right Cheek	-	11	2462	12.01	12.5	1.119	0.02	1.060	1.018	1.187
25	GSM850	GPRS(GMSK 4 Tx slots)	Back	1	251	848.8	29.46	30.5	1.271	-0.04	1.090	1	1.385
41	GSM850	GPRS(GMSK 4 Tx slots)	Back	1	251	848.8	29.46	30.5	1.271	0.01	1.070	1.018	1.360
16	WCDMA Band II	RMC 12.2K	Back	1	9400	1880	23.1	24	1.230	-0.11	1.120	1	1.378
23	WCDMA Band II	RMC 12.2K	Back	1	9400	1880	23.1	24	1.230	-0.09	1.090	1.027	1.341

Note:

1. Per KDB 865664 D01v01r02, for each frequency band, repeated SAR measurement is required only when the measured SAR is  $\geq 0.8$ W/kg
2. Per KDB 865664 D01v01r02, if the ratio among the repeated measurement is  $\leq 1.2$  and the measured SAR  $< 1.45$ W/kg, only one repeated measurement is required.
3. The ratio is the difference in percentage between original and repeated *measured SAR*.
4. All measurement SAR result is scaled-up to account for tune-up tolerance and is compliant.

**12.5 Highest SAR Plot**

TestLaboratory: Sporton International Inc. SAR/HAC TestingLab

Date: 2013.12.03

**25 GSM850\_GPRS(GMSK 4 Tx slots)\_Back\_1.0cm\_Ch251**

Communication System: GPRS/EDGE (4 Tx slot); Frequency: 848.8 MHz; Duty Cycle: 1:2.08  
 Medium: MSL\_835\_131203 Medium parameters used:  $f = 849$  MHz;  $\sigma = 0.987$  S/m;  $\epsilon_r = 54.156$ ;  $\rho = 1000$  kg/m<sup>3</sup>  
 Ambient Temperature: 23.6 °C; Liquid Temperature : 22.4 °C

DASY5 Configuration:

- Probe: EX3DV4 - SN3911; ConvF(9.93, 9.93, 9.93); Calibrated: 2013.04.11;
- Sensor-Surface: 2mm (Mechanical Surface Detection)
- Electronics: DAE4 Sn1358; Calibrated: 2013.04.08
- Phantom: SAM 1; Type: QD 000 P40 C; Serial: TP-1753
- Measurement SW: DASY52, Version 52.8 (6); SEMCAD X Version 14.6.9 (7117)

**Ch251/Area Scan (61x111x1):** Interpolated grid: dx=15mm, dy=15mm  
 Maximum value of SAR (interpolated) = 1.27 W/kg

**Ch251/Zoom Scan (5x5x7)/Cube 0:** Measurement grid: dx=8mm, dy=8mm, dz=5mm  
 Reference Value = 33.405 V/m; Power Drift = -0.04 dB  
 Peak SAR (extrapolated) = 1.40 W/kg  
**SAR(1 g) = 1.090 W/kg; SAR(10 g) = 0.845 W/kg**  
 Maximum value of SAR (measured) = 1.26 W/kg

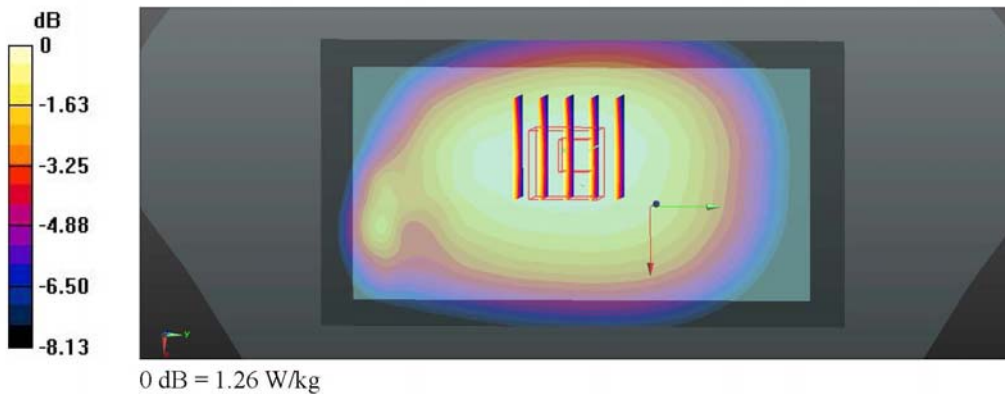

TestLaboratory: Sporton International Inc. SAR/HAC TestingLab

Date: 2013.12.02

**08 GSM1900\_GPRS(GMSK 4 Tx slots)\_Bottom side\_1.0cm\_Ch512**

Communication System: GPRS/EDGE (4 Tx slot);Frequency: 1850.2 MHz;Duty Cycle: 1:2.08  
 Medium: MSL\_1900\_131202 Medium parameters used:  $f = 1850.2$  MHz;  $\sigma = 1.47$  S/m;  $\epsilon_r = 54.773$ ;  
 $\rho = 1000$  kg/m<sup>3</sup>  
**Ambient Temperature: 23.4 °C; Liquid Temperature : 22.6 °C**

DASY5 Configuration:

- Probe: EX3DV4 - SN3911; ConvF(7.7, 7.7, 7.7); Calibrated: 2013.04.11;
- Sensor-Surface: 2mm (Mechanical Surface Detection)
- Electronics: DAE4 Sn1358; Calibrated: 2013.04.08
- Phantom: SAM 2; Type: QD 000 P40 C; Serial: TP-1754
- Measurement SW: DASY52, Version 52.8 (6); SEMCAD X Version 14.6.9 (7117)

**Ch512/Area Scan (31x71x1):** Interpolated grid: dx=15mm, dy=15mm  
 Maximum value of SAR (interpolated) = 1.16 W/kg

**Ch512/Zoom Scan (5x5x7)/Cube 0:** Measurement grid: dx=8mm, dy=8mm, dz=5mm  
 Reference Value = 9.871 V/m; Power Drift = -0.05 dB  
 Peak SAR (extrapolated) = 1.43 W/kg  
**SAR(1 g) = 0.842 W/kg; SAR(10 g) = 0.444 W/kg**  
 Maximum value of SAR (measured) = 1.17 W/kg

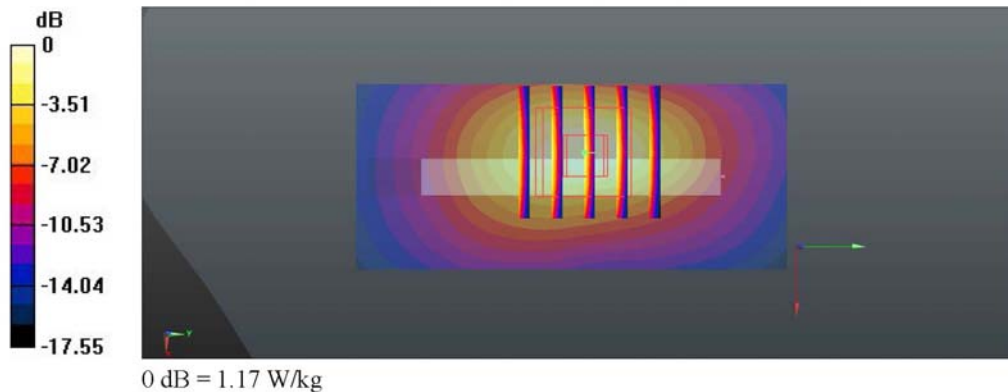

TestLaboratory: Sporton International Inc. SAR/HAC TestingLab

Date: 2013.12.03

**37 WCDMA Band V\_RMC 12.2K\_Back\_1.0cm\_Ch4132**

Communication System: WCDMA;Frequency: 826.4 MHz;Duty Cycle: 1:1  
 Medium: MSL\_835\_131203 Medium parameters used:  $f = 826.4$  MHz;  $\sigma = 0.966$  S/m;  $\epsilon_r = 54.341$ ;  
 $\rho = 1000$  kg/m<sup>3</sup>  
**Ambient Temperature: 23.6 °C; Liquid Temperature : 22.4 °C**

DASY5 Configuration:

- Probe: EX3DV4 - SN3911; ConvF(9.93, 9.93, 9.93); Calibrated: 2013.04.11;
- Sensor-Surface: 2mm (Mechanical Surface Detection)
- Electronics: DAE4 Sn1358; Calibrated: 2013.04.08
- Phantom: SAM 1; Type: QD 000 P40 C; Serial: TP-1753
- Measurement SW: DASY52, Version 52.8 (6); SEMCAD X Version 14.6.9 (7117)

**Ch4132/Area Scan (61x111x1):** Interpolated grid: dx=15mm, dy=15mm  
 Maximum value of SAR (interpolated) = 0.551 W/kg

**Ch4132/Zoom Scan (5x5x7)/Cube 0:** Measurement grid: dx=8mm, dy=8mm, dz=5mm  
 Reference Value = 22.383 V/m; Power Drift = -0.02 dB  
 Peak SAR (extrapolated) = 0.599 W/kg  
**SAR(1 g) = 0.479 W/kg; SAR(10 g) = 0.374 W/kg**  
 Maximum value of SAR (measured) = 0.544 W/kg

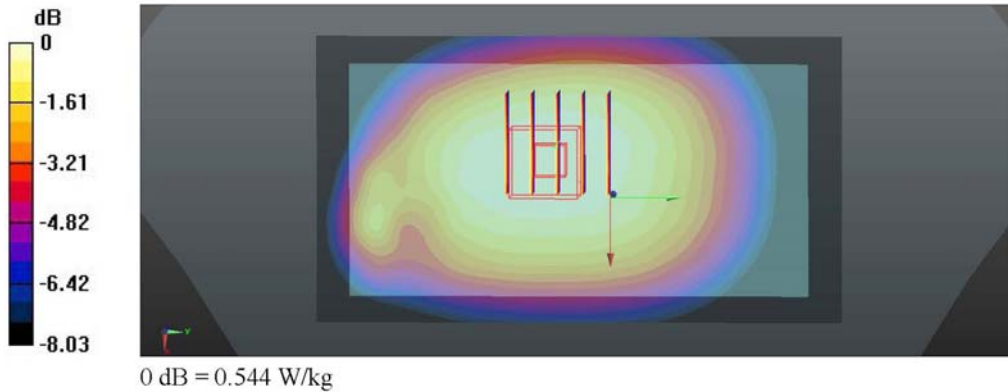

Test Laboratory: Sporton International Inc. SAR/HAC Testing Lab

Date: 2013.12.03

**46 WCDMA Band IV\_RMC 12.2K\_Bottom side\_1.0cm\_Ch1312**

Communication System: WCDMA; Frequency: 1712.4 MHz; Duty Cycle: 1:1  
 Medium: MSL\_1750\_131203 Medium parameters used:  $f = 1712.4 \text{ MHz}$ ;  $\sigma = 1.487 \text{ S/m}$ ;  $\epsilon_r = 54.734$ ;  $\rho = 1000 \text{ kg/m}^3$   
 Ambient Temperature: 23.6 °C; Liquid Temperature : 22.4 °C

DASY5 Configuration:

- Probe: EX3DV4 - SN3911; ConvF(8.17, 8.17, 8.17); Calibrated: 2013.04.11;
- Sensor-Surface: 2mm (Mechanical Surface Detection)
- Electronics: DAE4 Sn1358; Calibrated: 2013.04.08
- Phantom: SAM 2; Type: QD 000 P40 C; Serial: TP-1754
- Measurement SW: DASY52, Version 52.8 (6); SEMCAD X Version 14.6.9 (7117)

**Ch1312/Area Scan (31x71x1):** Interpolated grid:  $dx=15\text{mm}$ ,  $dy=15\text{mm}$   
 Maximum value of SAR (interpolated) = 0.611 W/kg

**Ch1312/Zoom Scan (5x5x7)/Cube 0:** Measurement grid:  $dx=8\text{mm}$ ,  $dy=8\text{mm}$ ,  $dz=5\text{mm}$   
 Reference Value = 8.229 V/m; Power Drift = -0.04 dB  
 Peak SAR (extrapolated) = 0.783 W/kg  
**SAR(1 g) = 0.461 W/kg; SAR(10 g) = 0.247 W/kg**  
 Maximum value of SAR (measured) = 0.630 W/kg

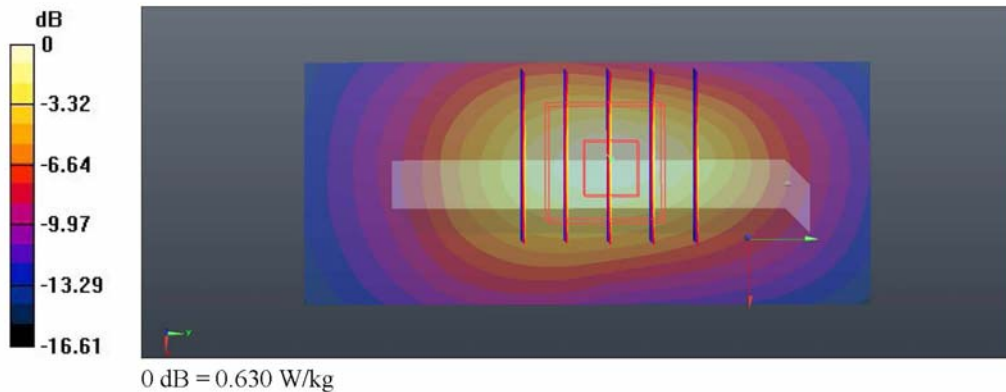

TestLaboratory: Sporton International Inc. SAR/HAC TestingLab

Date: 2013.12.02

**16 WCDMA Band II\_RMC 12.2K\_Back\_1.0cm\_Ch9400**

Communication System: WCDMA; Frequency: 1880 MHz; Duty Cycle: 1:1  
 Medium: MSL\_1900\_131202 Medium parameters used:  $f = 1880$  MHz;  $\sigma = 1.509$  S/m;  $\epsilon_r = 54.703$ ;  
 $\rho = 1000$  kg/m<sup>3</sup>  
 Ambient Temperature: 23.4 °C; Liquid Temperature : 22.6 °C

DASY5 Configuration:

- Probe: EX3DV4 - SN3911; ConvF(7.7, 7.7, 7.7); Calibrated: 2013.04.11;
- Sensor-Surface: 2mm (Mechanical Surface Detection)
- Electronics: DAE4 Sn1358; Calibrated: 2013.04.08
- Phantom: SAM 2; Type: QD 000 P40 C; Serial: TP-1754
- Measurement SW: DASY52, Version 52.8 (6); SEMCAD X Version 14.6.9 (7117)

**Ch9400/Area Scan (61x121x1):** Interpolated grid: dx=15mm, dy=15mm  
 Maximum value of SAR (interpolated) = 1.48 W/kg

**Ch9400/Zoom Scan (5x5x7)/Cube 0:** Measurement grid: dx=8mm, dy=8mm, dz=5mm  
 Reference Value = 8.557 V/m; Power Drift = -0.11 dB  
 Peak SAR (extrapolated) = 1.95 W/kg  
**SAR(1 g) = 1.120 W/kg; SAR(10 g) = 0.578 W/kg**  
 Maximum value of SAR (measured) = 1.51 W/kg

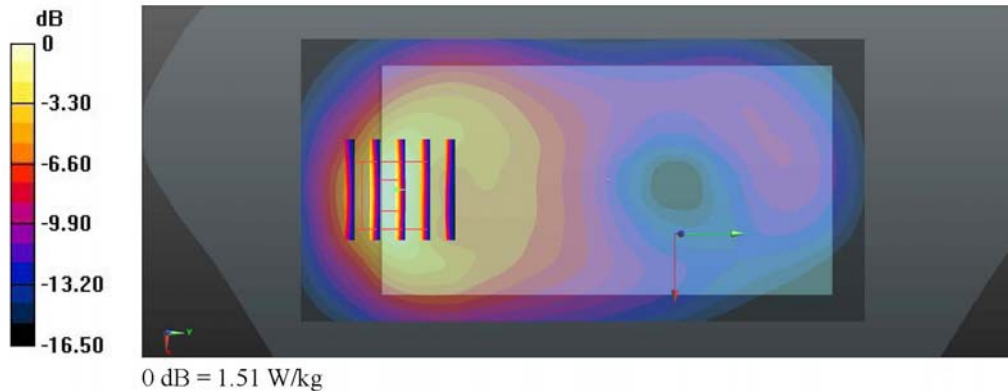

TestLaboratory: Sporton International Inc. SAR/HAC TestingLab

Date: 2013.12.04

**72 WLAN 2.4GHz\_802.11b\_Right Cheek\_Ch6**

Communication System: 802.11b ;Frequency: 2437 MHz;Duty Cycle: 1:1  
Medium: HSL\_2450\_131204 Medium parameters used:  $f = 2437$  MHz;  $\sigma = 1.795$  S/m;  $\epsilon_r = 37.678$ ;  
 $\rho = 1000$  kg/m<sup>3</sup>  
Ambient Temperature: 23.4 °C; Liquid Temperature : 22.5 °C

## DASY5 Configuration:

- Probe: EX3DV4 - SN3911; ConvF(7.22, 7.22, 7.22); Calibrated: 2013.04.11;
- Sensor-Surface: 2mm (Mechanical Surface Detection)
- Electronics: DAE4 Sn1358; Calibrated: 2013.04.08
- Phantom: SAM 1; Type: QD 000 P40 C; Serial: TP-1753
- Measurement SW: DASY52, Version 52.8 (6); SEMCAD X Version 14.6.9 (7117)

**Ch6/Area Scan (81x141x1):** Interpolated grid: dx=12mm, dy=12mm  
Maximum value of SAR (interpolated) = 1.50 W/kg

**Ch6/Zoom Scan (7x7x7)/Cube 0:** Measurement grid: dx=5mm, dy=5mm, dz=5mm  
Reference Value = 10.531 V/m; Power Drift = 0.04 dB  
Peak SAR (extrapolated) = 2.32 W/kg  
**SAR(1 g) = 1.030 W/kg; SAR(10 g) = 0.466 W/kg**  
Maximum value of SAR (measured) = 1.56 W/kg

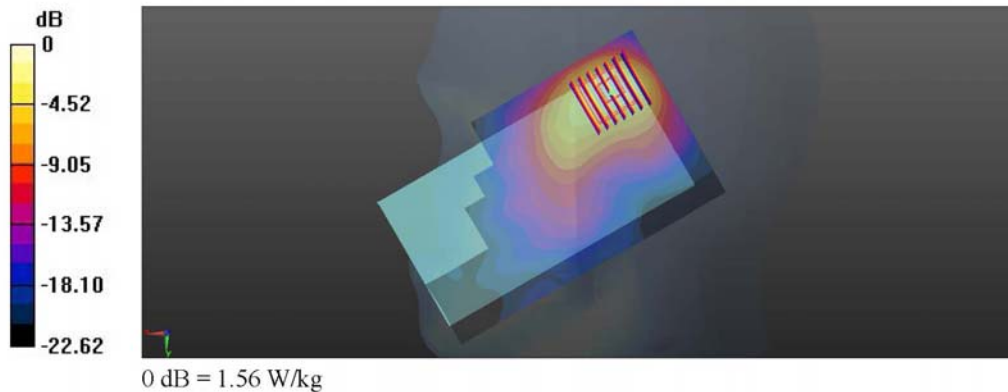



### 13. Simultaneous Transmission Analysis

NO.	Simultaneous Transmission Configurations	Phone			Note
		Head	Body-worn	Hotspot	
1.	GSM(Voice) + WLAN2.4GHz(data)	Yes	Yes		
2.	WCDMA(Voice) + WLAN2.4GHz(data)	Yes	Yes		
3.	GSM(Voice) + Bluetooth(data)	Yes	Yes		
4.	WCDMA((Voice) + Bluetooth(data)	Yes	Yes		
5.	GPRS/EDGE(Data) + WLAN2.4GHz(data)		Yes	Yes	2.4GHz Hotspot
6.	WCDMA(Data) + WLAN2.4GHz(data)	Yes	Yes	Yes	2.4GHz Hotspot
7.	GPRS/EDGE(Data) + Bluetooth(data)		Yes	Yes	
8.	WCDMA(Data) + Bluetooth(data)	Yes	Yes	Yes	

**Note:**

1. WLAN 2.4GHz and Bluetooth share the same antenna, and cannot transmit simultaneously.
2. EUT will choose either GSM or WCDMA according to the network signal condition; therefore, they will not transmit simultaneously.
3. The reported SAR summation is calculated based on the same configuration and test position.
4. Per KDB 447498 D01v05r01, simultaneous transmission SAR is compliant if,
  - i) Scalar SAR summation < 1.6W/kg.
  - ii)  $SPLSR = (SAR_1 + SAR_2)^{1.5} / (min. separation distance, mm)$ , and the peak separation distance is determined from the square root of  $[(x_1-x_2)^2 + (y_1-y_2)^2 + (z_1-z_2)^2]$ , where  $(x_1, y_1, z_1)$  and  $(x_2, y_2, z_2)$  are the coordinates of the extrapolated peak SAR locations in the zoom scan  
If  $SPLSR \leq 0.04$ , simultaneously transmission SAR measurement is not necessary
  - iii) Simultaneously transmission SAR measurement, and the reported multi-band SAR < 1.6W/kg
5. For simultaneous transmission analysis, Bluetooth SAR is estimated per KDB 447498 D01v05r01 based on the formula below.
  - i)  $(max. power of channel, including tune-up tolerance, mW) / (min. test separation distance, mm) \cdot [\sqrt{f(GHz)} / x] W/kg$  for test separation distances  $\leq 50$  mm; where  $x = 7.5$  for 1-g SAR, and  $x = 18.75$  for 10-g SAR.
  - ii) When the minimum test separation distance is < 5mm, the distance is used 5mm to determine SAR test exclusion.
  - iii) 0.4 W/kg for 1-g SAR and 1.0 W/kg for 10-g SAR, when the test separation distances is > 50 mm.  
If the test separation distance (antenna-user) is < 5mm, 5mm is used for excluded SAR calculation

Bluetooth				
Tune-up Maximum power (dBm)	Exposure Position	Head	Hotspot	Body-worn
		Test separation (mm)	0	10
0.5	Estimated SAR (W/kg)	0.042	0.021	0.021



**13.1 Head Exposure Conditions**

**<WWAN + WLAN 2.4GHZ>**

Position	WWAN (PCE)			WLAN 2.4GHz (DTS)		Summed SAR (W/kg)	SPLSR ≤ 0.04	Case No
	WWAN Band	Plot No	SAR (W/kg)	Plot No	SAR (W/kg)			
Right Cheek	GSM850	59	0.408	72	1.333	1.74	0.03	1
	GSM1900	55	0.089	72	1.333	1.42		
	WCDMA Band V	63	0.262	72	1.333	1.60	0.03	2
	WCDMA Band IV	47	0.168	72	1.333	1.50		
	WCDMA Band II	51	0.235	72	1.333	1.57		
Right Tilted	GSM850	60	0.279	68	0.763	1.04		
	GSM1900	56	0.058	68	0.763	0.82		
	WCDMA Band V	64	0.185	68	0.763	0.95		
	WCDMA Band IV	48	0.120	68	0.763	0.88		
	WCDMA Band II	52	0.115	68	0.763	0.88		
Left Cheek	GSM850	61	0.349	69	0.449	0.80		
	GSM1900	57	0.107	69	0.449	0.56		
	WCDMA Band V	65	0.233	69	0.449	0.68		
	WCDMA Band IV	49	0.194	69	0.449	0.64		
	WCDMA Band II	53	0.250	69	0.449	0.70		
Left Tilted	GSM850	62	0.266	70	0.338	0.60		
	GSM1900	58	0.057	70	0.338	0.40		
	WCDMA Band V	66	0.175	70	0.338	0.51		
	WCDMA Band IV	50	0.123	70	0.338	0.46		
	WCDMA Band II	54	0.150	70	0.338	0.49		

**<WWAN + Bluetooth>**

Position	WWAN (PCE)			Bluetooth (DSS)	Summed SAR (W/kg)	SPLSR ≤ 0.04	Case No
	WWAN Band	Plot No	SAR (W/kg)	Estimated SAR (W/kg)			
Right Cheek	GSM 850	59	0.408	0.042	0.45		
	GSM 1900	55	0.089	0.042	0.13		
	WCDMA Band V	63	0.262	0.042	0.30		
	WCDMA Band IV	47	0.168	0.042	0.21		
	WCDMA Band II	51	0.235	0.042	0.28		
Right Tilted	GSM 850	60	0.279	0.042	0.32		
	GSM 1900	56	0.058	0.042	0.10		
	WCDMA Band V	64	0.185	0.042	0.23		
	WCDMA Band IV	48	0.120	0.042	0.16		
	WCDMA Band II	52	0.115	0.042	0.16		
Left Cheek	GSM 850	61	0.349	0.042	0.39		
	GSM 1900	57	0.107	0.042	0.15		
	WCDMA Band V	65	0.233	0.042	0.28		
	WCDMA Band IV	49	0.194	0.042	0.24		
	WCDMA Band II	53	0.250	0.042	0.29		
Left Tilted	GSM 850	62	0.266	0.042	0.31		
	GSM 1900	58	0.057	0.042	0.10		
	WCDMA Band V	66	0.175	0.042	0.22		
	WCDMA Band IV	50	0.123	0.042	0.17		
	WCDMA Band II	54	0.150	0.042	0.19		



**13.2 Hotspot Exposure Conditions**

**<WWAN + WLAN 2.4GHz>**

Position	WWAN (PCE)			WLAN 2.4GHz (DTS)		Summed SAR (W/kg)	SPLSR ≤ 0.04	Case No
	WWAN Band	Plot No	SAR (W/kg)	Plot No	SAR (W/kg)			
Front	GSM850	24	0.894	73	0.290	<b>1.18</b>		
	GSM1900	1	0.478	73	0.290	<b>0.77</b>		
	WCDMA Band V	36	0.376	73	0.290	<b>0.67</b>		
	WCDMA Band IV	42	0.252	73	0.290	<b>0.54</b>		
	WCDMA Band II	11	0.602	73	0.290	<b>0.89</b>		
Back	GSM850	25	1.385	74	0.249	<b>1.63</b>	0.04	3
	GSM1900	7	1.181	74	0.249	<b>1.43</b>		
	WCDMA Band V	37	0.595	74	0.249	<b>0.84</b>		
	WCDMA Band IV	43	0.496	74	0.249	<b>0.75</b>		
	WCDMA Band II	16	1.378	74	0.249	<b>1.63</b>	0.02	4
Left Side	GSM850	26	0.656	75	0.182	<b>0.84</b>		
	GSM1900	3	0.188	75	0.182	<b>0.37</b>		
	WCDMA Band V	38	0.274	75	0.182	<b>0.46</b>		
	WCDMA Band IV	44	0.127	75	0.182	<b>0.31</b>		
	WCDMA Band II	13	0.229	75	0.182	<b>0.41</b>		
Right Side	GSM850	27	0.987			<b>0.99</b>		
	GSM1900	4	0.118			<b>0.12</b>		
	WCDMA Band V	39	0.401			<b>0.40</b>		
	WCDMA Band IV	45	0.089			<b>0.09</b>		
	WCDMA Band II	14	0.139			<b>0.14</b>		
Top Side	GSM850			77	0.084	<b>0.08</b>		
	GSM1900			77	0.084	<b>0.08</b>		
	WCDMA Band V			77	0.084	<b>0.08</b>		
	WCDMA Band IV			77	0.084	<b>0.08</b>		
	WCDMA Band II			77	0.084	<b>0.08</b>		
Bottom Side	GSM850	28	0.220			<b>0.22</b>		
	GSM1900	8	1.192			<b>1.19</b>		
	WCDMA Band V	40	0.065			<b>0.07</b>		
	WCDMA Band IV	46	0.578			<b>0.58</b>		
	WCDMA Band II	21	1.341			<b>1.34</b>		



<WWAN + Bluetooth>

Position	WWAN (PCE)			Bluetooth (DSS)	Summed SAR (W/kg)	SPLSR ≤ 0.04	Case No
	WWAN Band	Plot No	SAR (W/kg)	Estimated SAR (W/kg)			
Front	GSM850	24	0.894	0.021	<b>0.92</b>		
	GSM1900	1	0.478	0.021	<b>0.50</b>		
	WCDMA Band V	36	0.376	0.021	<b>0.40</b>		
	WCDMA Band IV	42	0.252	0.021	<b>0.27</b>		
	WCDMA Band II	11	0.602	0.021	<b>0.62</b>		
Back	GSM850	25	1.385	0.021	<b>1.41</b>		
	GSM1900	7	1.181	0.021	<b>1.20</b>		
	WCDMA Band V	37	0.595	0.021	<b>0.62</b>		
	WCDMA Band IV	43	0.496	0.021	<b>0.52</b>		
	WCDMA Band II	16	1.378	0.021	<b>1.40</b>		
Left Side	GSM850	26	0.656	0.021	<b>0.68</b>		
	GSM1900	3	0.188	0.021	<b>0.21</b>		
	WCDMA Band V	38	0.274	0.021	<b>0.30</b>		
	WCDMA Band IV	44	0.127	0.021	<b>0.15</b>		
	WCDMA Band II	13	0.229	0.021	<b>0.25</b>		
Right Side	GSM850	27	0.987		<b>0.99</b>		
	GSM1900	4	0.118		<b>0.12</b>		
	WCDMA Band V	39	0.401		<b>0.40</b>		
	WCDMA Band IV	45	0.089		<b>0.09</b>		
	WCDMA Band II	14	0.139		<b>0.14</b>		
Top Side	GSM850			0.021	<b>0.02</b>		
	GSM1900			0.021	<b>0.02</b>		
	WCDMA Band V			0.021	<b>0.02</b>		
	WCDMA Band IV			0.021	<b>0.02</b>		
	WCDMA Band II			0.021	<b>0.02</b>		
Bottom Side	GSM850	28	0.220		<b>0.22</b>		
	GSM1900	8	1.192		<b>0.19</b>		
	WCDMA Band V	40	0.065		<b>0.07</b>		
	WCDMA Band IV	46	0.578		<b>0.58</b>		
	WCDMA Band II	21	1.341		<b>1.34</b>		

**13.3 Body-Worn Exposure Conditions**

**<WWAN + WLAN 2.4GHz>**

Position	WWAN (PCE)			WLAN 2.4GHz (DTS)		Summed SAR (W/kg)	SPLSR ≤ 0.04	Case No
	WWAN Band	Plot No	SAR (W/kg)	Plot No	SAR (W/kg)			
Front	GSM850	24	0.894	73	0.290	<b>1.18</b>		
	GSM1900	1	0.478	73	0.290	<b>0.77</b>		
	WCDMA Band V	36	0.376	73	0.290	<b>0.67</b>		
	WCDMA Band IV	42	0.252	73	0.290	<b>0.54</b>		
	WCDMA Band II	11	0.602	73	0.290	<b>0.89</b>		
Back	GSM850	25	1.385	74	0.249	<b>1.63</b>	0.04	3
	GSM1900	7	1.181	74	0.249	<b>1.43</b>		
	WCDMA Band V	37	0.595	74	0.249	<b>0.84</b>		
	WCDMA Band IV	43	0.496	74	0.249	<b>0.75</b>		
	WCDMA Band II	16	1.378	74	0.249	<b>1.63</b>	0.02	4
Back (with / Headset)	GSM850			78	0.201	<b>0.20</b>		
	GSM1900			78	0.201	<b>0.20</b>		
	WCDMA Band V			78	0.201	<b>0.20</b>		
	WCDMA Band IV			78	0.201	<b>0.20</b>		
	WCDMA Band II	18	1.316	78	0.201	<b>1.52</b>		

**<WWAN + Bluetooth>**

Position	WWAN (PCE)			Bluetooth (DSS)	Summed SAR (W/kg)	SPLSR ≤ 0.04	Case No
	WWAN Band	Plot No	SAR (W/kg)	Estimated SAR (W/kg)			
Front	GSM850	24	0.894	0.021	<b>0.92</b>		
	GSM1900	1	0.478	0.021	<b>0.50</b>		
	WCDMA Band V	36	0.376	0.021	<b>0.40</b>		
	WCDMA Band IV	42	0.252	0.021	<b>0.27</b>		
	WCDMA Band II	11	0.602	0.021	<b>0.62</b>		
Back	GSM850	25	1.385	0.021	<b>1.41</b>		
	GSM1900	7	1.181	0.021	<b>1.20</b>		
	WCDMA Band V	37	0.595	0.021	<b>0.62</b>		
	WCDMA Band IV	43	0.496	0.021	<b>0.52</b>		
	WCDMA Band II	16	1.378	0.021	<b>1.40</b>		
Back (with / Headset)	GSM850			0.021	<b>0.02</b>		
	GSM1900			0.021	<b>0.02</b>		
	WCDMA Band V			0.021	<b>0.02</b>		
	WCDMA Band IV			0.021	<b>0.02</b>		
	WCDMA Band II	18	1.316	0.021	<b>1.34</b>		

13.4 SPLSR Evaluation and Analysis

Case No 1 Plot No	Band	Position	SAR (W/kg)	Gap (cm)	SAR peak location (m)			3D distance (mm)	Pair SAR sum (W/kg)	SPLSR	Simultaneous SAR
					X	Y	Z				
59	GSM850	Right Cheek	0.408	-	0.0672	-0.269	-0.173	69.7	1.74	0.03	Not required
72	WLAN 2.4GHz		1.333	-	0.0318	-0.329	-0.173				

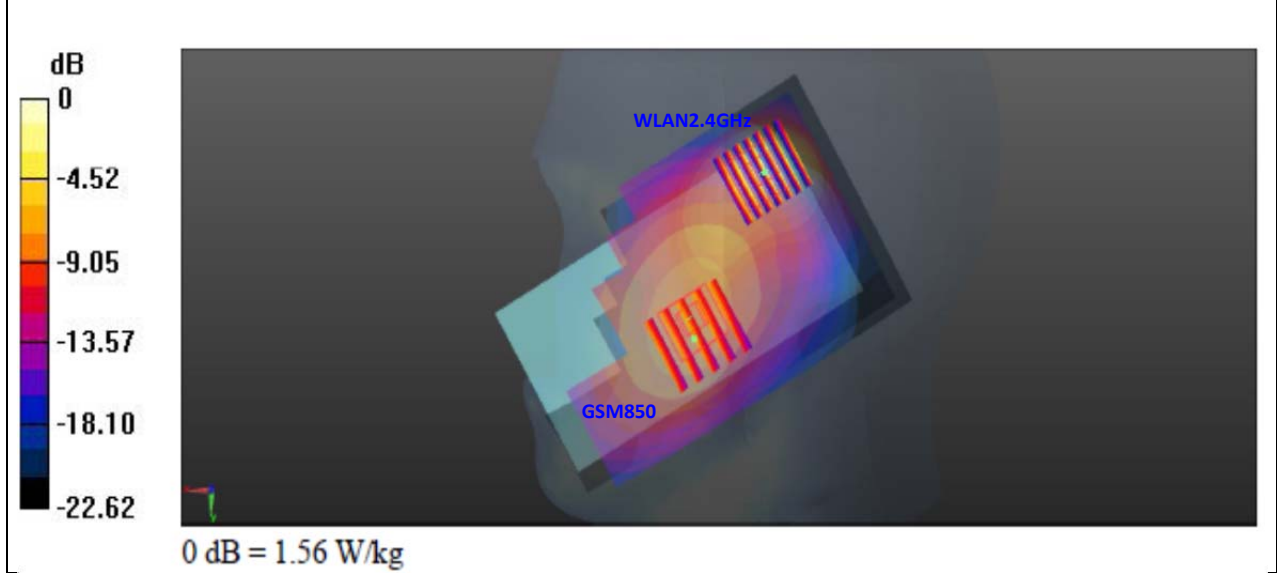

Case No 2 Plot No	Band	Position	SAR (W/kg)	Gap (cm)	SAR peak location (m)			3D distance (mm)	Pair SAR sum (W/kg)	SPLSR	Simultaneous SAR
					X	Y	Z				
63	WCDMA Band V	Right Cheek	0.262	-	0.0632	-0.262	-0.174	74.0	1.60	0.03	Not required
72	WLAN 2.4GHz		1.333	-	0.0318	-0.329	-0.173				

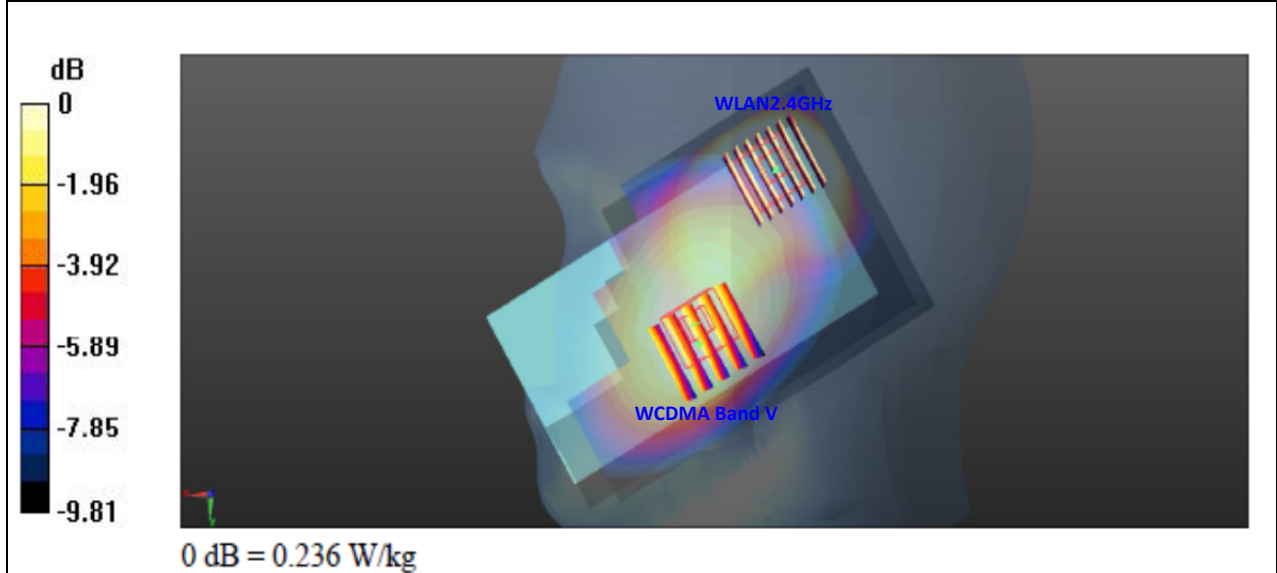

Case No 3 Plot No	Band	Position	SAR (W/kg)	Gap (cm)	SAR peak location (m)			3D distance (mm)	Pair SAR sum (W/kg)	SPLSR	Simultaneous SAR
					X	Y	Z				
25	GSM850	Back	1.385	1	-0.0275	0.002	-0.205	56.8	1.63	0.04	Not required
74	WLAN 2.4GHz		0.249	1	0.0056	0.0482	-0.205				

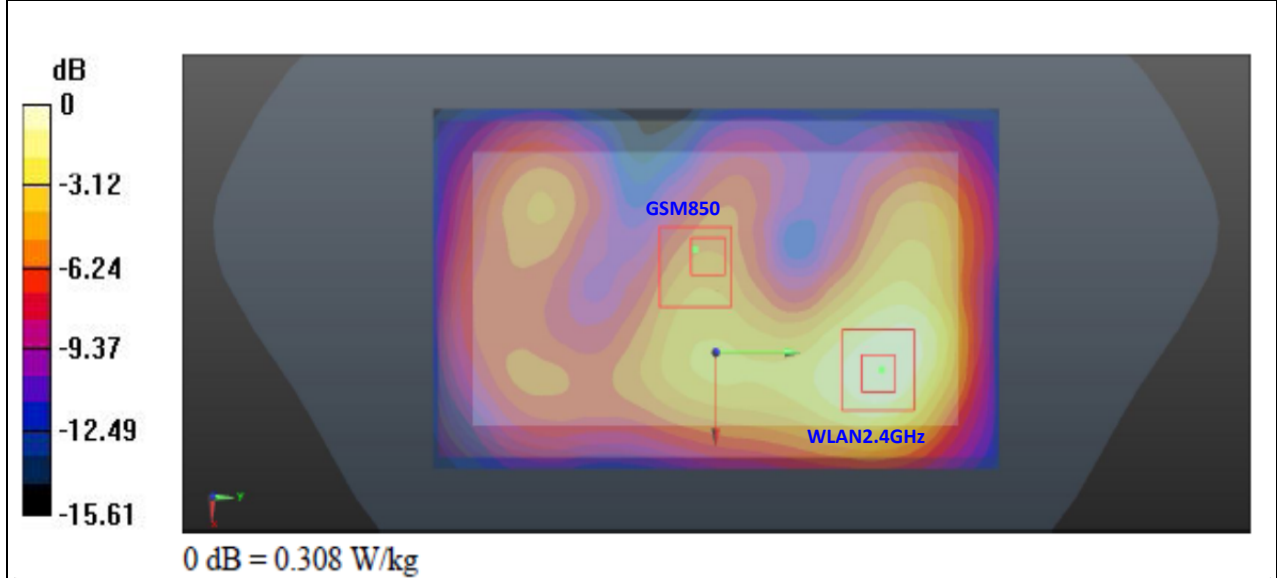

Case No 4 Plot No	Band	Position	SAR (W/kg)	Gap (cm)	SAR peak location (m)			3D distance (mm)	Pair SAR sum (W/kg)	SPLSR	Simultaneous SAR
					X	Y	Z				
16	WCDMA Band II	Back	1.378	1	-0.014	-0.068	-0.204	117.8	1.63	0.02	Not required
74	WLAN 2.4GHz		0.249	1	0.0056	0.0482	-0.205				

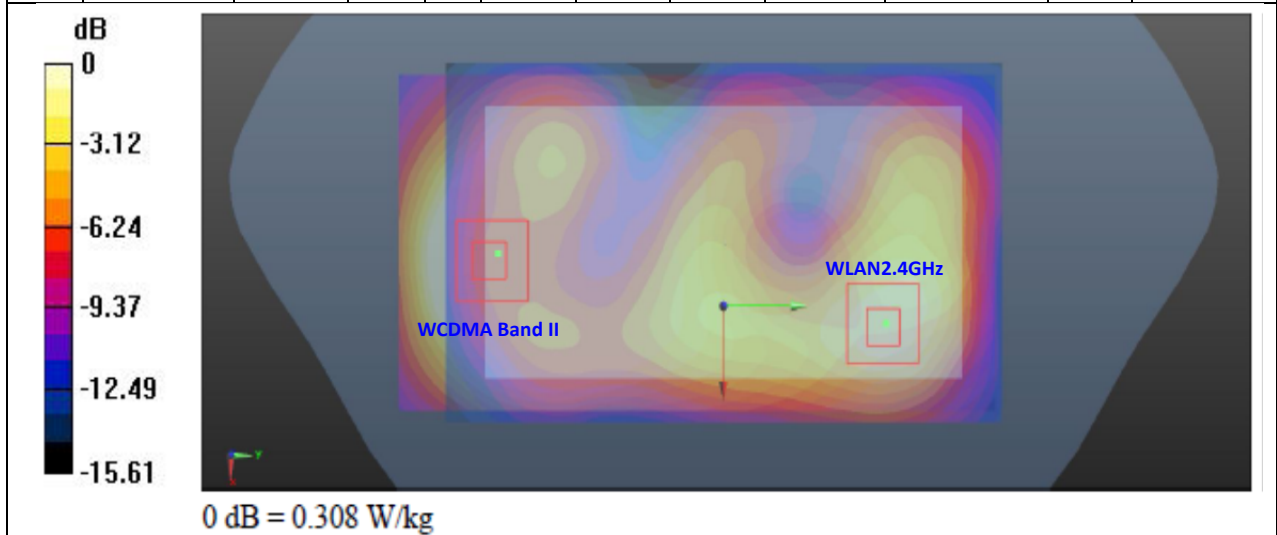

Remark: Per KDB 447498 D01v05r01, if SPLSR ≤ 0.04, further evaluation is not required.

Test Engineer : Kat Yin

## 14. Uncertainty Assessment

The component of uncertainty may generally be categorized according to the methods used to evaluate them. The evaluation of uncertainty by the statistical analysis of a series of observations is termed a Type A evaluation of uncertainty. The evaluation of uncertainty by means other than the statistical analysis of a series of observation is termed a Type B evaluation of uncertainty. Each component of uncertainty, however evaluated, is represented by an estimated standard deviation, termed standard uncertainty, which is determined by the positive square root of the estimated variance.

A Type A evaluation of standard uncertainty may be based on any valid statistical method for treating data. This includes calculating the standard deviation of the mean of a series of independent observations; using the method of least squares to fit a curve to the data in order to estimate the parameter of the curve and their standard deviations; or carrying out an analysis of variance in order to identify and quantify random effects in certain kinds of measurement.

A type B evaluation of standard uncertainty is typically based on scientific judgment using all of the relevant information available. These may include previous measurement data, experience, and knowledge of the behavior and properties of relevant materials and instruments, manufacture’s specification, data provided in calibration reports and uncertainties assigned to reference data taken from handbooks. Broadly speaking, the uncertainty is either obtained from an outdoor source or obtained from an assumed distribution, such as the normal distribution, rectangular or triangular distributions indicated in Table 14.1

Uncertainty Distributions	Normal	Rectangular	Triangular	U-Shape
Multi-plying Factor <sup>(a)</sup>	1/k <sup>(b)</sup>	1/√3	1/√6	1/√2

(a) standard uncertainty is determined as the product of the multiplying factor and the estimated range of variations in the measured quantity

(b)  $\kappa$  is the coverage factor

**Table 14.1. Standard Uncertainty for Assumed Distribution**

The combined standard uncertainty of the measurement result represents the estimated standard deviation of the result. It is obtained by combining the individual standard uncertainties of both Type A and Type B evaluation using the usual “root-sum-squares” (RSS) methods of combining standard deviations by taking the positive square root of the estimated variances.

Expanded uncertainty is a measure of uncertainty that defines an interval about the measurement result within which the measured value is confidently believed to lie. It is obtained by multiplying the combined standard uncertainty by a coverage factor. Typically, the coverage factor ranges from 2 to 3. Using a coverage factor allows the true value of a measured quantity to be specified with a defined probability within the specified uncertainty range. For purpose of this document, a coverage factor two is used, which corresponds to confidence interval of about 95 %. The DASY uncertainty Budget is shown in the following tables.





Error Description	Uncertainty Value (±%)	Probability Distribution	Divisor	Ci (1g)	Ci (10g)	Standard Uncertainty (1g)	Standard Uncertainty (10g)
<b>Measurement System</b>							
Probe Calibration	6.0	Normal	1	1	1	± 6.0 %	± 6.0 %
Axial Isotropy	4.7	Rectangular	√3	0.7	0.7	± 1.9 %	± 1.9 %
Hemispherical Isotropy	9.6	Rectangular	√3	0.7	0.7	± 3.9 %	± 3.9 %
Boundary Effects	1.0	Rectangular	√3	1	1	± 0.6 %	± 0.6 %
Linearity	4.7	Rectangular	√3	1	1	± 2.7 %	± 2.7 %
System Detection Limits	1.0	Rectangular	√3	1	1	± 0.6 %	± 0.6 %
Readout Electronics	0.3	Normal	1	1	1	± 0.3 %	± 0.3 %
Response Time	0.8	Rectangular	√3	1	1	± 0.5 %	± 0.5 %
Integration Time	2.6	Rectangular	√3	1	1	± 1.5 %	± 1.5 %
RF Ambient Noise	3.0	Rectangular	√3	1	1	± 1.7 %	± 1.7 %
RF Ambient Reflections	3.0	Rectangular	√3	1	1	± 1.7 %	± 1.7 %
Probe Positioner	0.4	Rectangular	√3	1	1	± 0.2 %	± 0.2 %
Probe Positioning	2.9	Rectangular	√3	1	1	± 1.7 %	± 1.7 %
Max. SAR Eval.	1.0	Rectangular	√3	1	1	± 0.6 %	± 0.6 %
<b>Test Sample Related</b>							
Device Positioning	2.9	Normal	1	1	1	± 2.9 %	± 2.9 %
Device Holder	3.6	Normal	1	1	1	± 3.6 %	± 3.6 %
Power Drift	5.0	Rectangular	√3	1	1	± 2.9 %	± 2.9 %
<b>Phantom and Setup</b>							
Phantom Uncertainty	4.0	Rectangular	√3	1	1	± 2.3 %	± 2.3 %
Liquid Conductivity (Target)	5.0	Rectangular	√3	0.64	0.43	± 1.8 %	± 1.2 %
Liquid Conductivity (Meas.)	2.5	Normal	1	0.64	0.43	± 1.6 %	± 1.1 %
Liquid Permittivity (Target)	5.0	Rectangular	√3	0.6	0.49	± 1.7 %	± 1.4 %
Liquid Permittivity (Meas.)	2.5	Normal	1	0.6	0.49	± 1.5 %	± 1.2 %
<b>Combined Standard Uncertainty</b>						± 11.0 %	± 10.8 %
<b>Coverage Factor for 95 %</b>						K=2	
<b>Expanded Uncertainty</b>						± 22.0 %	± 21.5 %

Table 14.2. Uncertainty Budget for frequency range 300 MHz to 3 GHz



## **15. References**

- [1] FCC 47 CFR Part 2 “Frequency Allocations and Radio Treaty Matters; General Rules and Regulations”
- [2] ANSI/IEEE Std. C95.1-1992, “IEEE Standard for Safety Levels with Respect to Human Exposure to Radio Frequency Electromagnetic Fields, 3 kHz to 300 GHz”, September 1992
- [3] IEEE Std. 1528-2003, “Recommended Practice for Determining the Peak Spatial-Average Specific Absorption Rate (SAR) in the Human Head from Wireless Communications Devices: Measurement Techniques”, December 2003
- [4] SPEAG DASYS System Handbook
- [5] FCC KDB 248227 D01 v01r02, “SAR Measurement Procedures for 802.11 a/b/g Transmitters”, May 2007
- [6] FCC KDB 447498 D01 v05r01, “Mobile and Portable Device RF Exposure Procedures and Equipment Authorization Policies”, May 2013
- [7] FCC KDB 648474 D04 v01r02, “SAR Evaluation Considerations for Wireless Handsets”, December 2013
- [8] FCC KDB 941225 D01 v02, “SAR Measurement Procedures for 3G Devices – CDMA 2000 / Ev-Do / WCDMA / HSDPA / HSPA”, October 2007
- [9] FCC KDB 941225 D02 v02r02, “SAR Guidance for HSPA, HSPA+, DC-HSDPA and 1x-Advanced”, May 2013.
- [10] FCC KDB 941225 D03 v01, “Recommended SAR Test Reduction Procedures for GSM / GPRS / EDGE”, December 2008.
- [11] FCC KDB 941225 D06 v01r01, “SAR Evaluation Procedures for Portable Devices with Wireless Router Capabilities”, May 2013
- [12] FCC KDB 865664 D01 v01r02, “SAR Measurement Requirements for 100 MHz to 6 GHz”, December 2013.
- [13] FCC KDB 865664 D02 v01r01, “RF Exposure Compliance Reporting and Documentation Considerations”, May 2013



## ***Appendix A. Plots of System Performance Check***

The plots are shown as follows.

### System Check\_Head\_835MHz\_131204

**DUT: D835V2 - SN: 4d151**

Communication System: CW; Frequency: 835 MHz; Duty Cycle: 1:1

Medium: HSL\_835\_131204 Medium parameters used:  $f = 835 \text{ MHz}$ ;  $\sigma = 0.902 \text{ S/m}$ ;  $\epsilon_r = 40.749$ ;  $\rho = 1000 \text{ kg/m}^3$

Ambient Temperature:  $23.4 \text{ }^\circ\text{C}$ ; Liquid Temperature :  $22.7 \text{ }^\circ\text{C}$

DASY5 Configuration:

- Probe: EX3DV4 - SN3911; ConvF(10.05, 10.05, 10.05); Calibrated: 2013.04.11;
- Sensor-Surface: 2mm (Mechanical Surface Detection)
- Electronics: DAE4 Sn1358; Calibrated: 2013.04.08
- Phantom: SAM 1; Type: QD 000 P40 C; Serial: TP-1753
- Measurement SW: DASY52, Version 52.8 (6); SEMCAD X Version 14.6.9 (7117)

**Pin=250mW/Area Scan (61x61x1):** Interpolated grid:  $dx=15\text{mm}$ ,  $dy=15\text{mm}$

Maximum value of SAR (interpolated) =  $2.82 \text{ W/kg}$

**Pin=250mW/Zoom Scan (5x5x7)/Cube 0:** Measurement grid:  $dx=8\text{mm}$ ,  $dy=8\text{mm}$ ,  $dz=5\text{mm}$

Reference Value =  $56.339 \text{ V/m}$ ; Power Drift =  $-0.06 \text{ dB}$

Peak SAR (extrapolated) =  $3.35 \text{ W/kg}$

**SAR(1 g) =  $2.25 \text{ W/kg}$ ; SAR(10 g) =  $1.48 \text{ W/kg}$**

Maximum value of SAR (measured) =  $2.85 \text{ W/kg}$

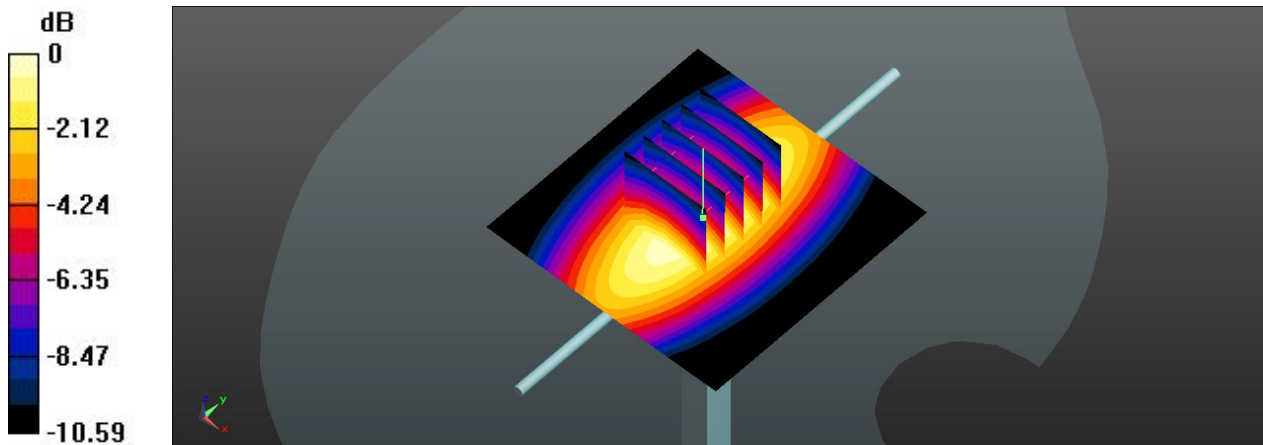

0 dB =  $2.85 \text{ W/kg}$

### System Check\_Head\_1750MHz\_131203

**DUT: D1750V2 - SN: 1090**

Communication System: CW; Frequency: 1750 MHz; Duty Cycle: 1:1

Medium: HSL\_1750\_131203 Medium parameters used:  $f = 1750$  MHz;  $\sigma = 1.388$  S/m;  $\epsilon_r = 41.364$ ;

$\rho = 1000$  kg/m<sup>3</sup>

Ambient Temperature: 23.4 °C; Liquid Temperature : 22.3 °C

DASY5 Configuration:

- Probe: EX3DV4 - SN3911; ConvF(8.59, 8.59, 8.59); Calibrated: 2013.04.11;
- Sensor-Surface: 2mm (Mechanical Surface Detection)
- Electronics: DAE4 Sn1358; Calibrated: 2013.04.08
- Phantom: SAM 1; Type: QD 000 P40 C; Serial: TP-1753
- Measurement SW: DASY52, Version 52.8 (6); SEMCAD X Version 14.6.9 (7117)

**Pin=250mW/Area Scan (61x61x1):** Interpolated grid: dx=15mm, dy=15mm

Maximum value of SAR (interpolated) = 12.7 W/kg

**Pin=250mW/Zoom Scan (5x5x7)/Cube 0:** Measurement grid: dx=8mm, dy=8mm, dz=5mm

Reference Value = 94.197 V/m; Power Drift = -0.02 dB

Peak SAR (extrapolated) = 16.2 W/kg

**SAR(1 g) = 8.98 W/kg; SAR(10 g) = 4.79 W/kg**

Maximum value of SAR (measured) = 12.5 W/kg

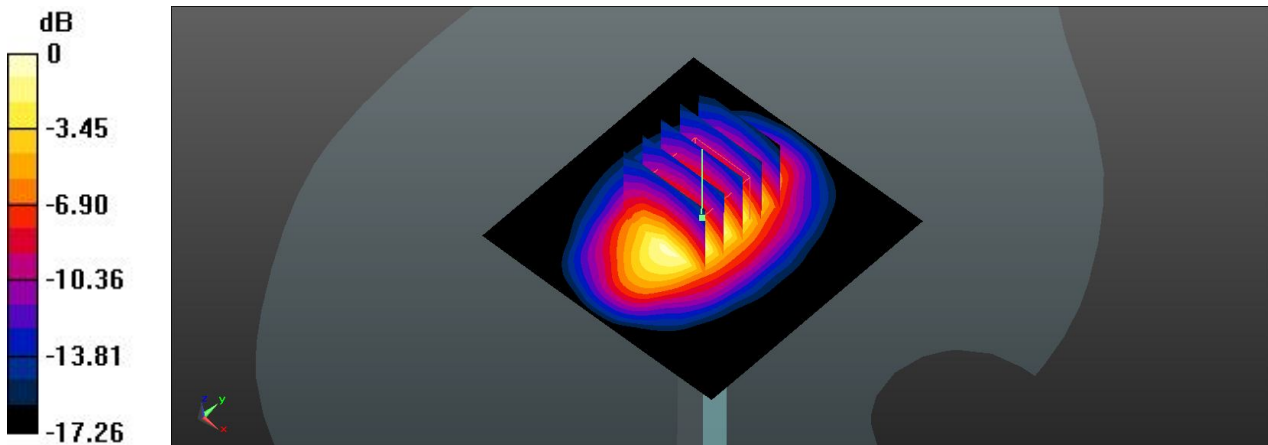

0 dB = 12.5 W/kg

### System Check\_Head\_1900MHz\_131203

**DUT: D1900V2 - SN: 5d170**

Communication System: CW; Frequency: 1900 MHz; Duty Cycle: 1:1

Medium: HSL\_1900\_131203 Medium parameters used:  $f = 1900 \text{ MHz}$ ;  $\sigma = 1.445 \text{ S/m}$ ;  $\epsilon_r = 39.686$ ;

$\rho = 1000 \text{ kg/m}^3$

Ambient Temperature:  $23.5 \text{ }^\circ\text{C}$ ; Liquid Temperature :  $22.6 \text{ }^\circ\text{C}$

DASY5 Configuration:

- Probe: EX3DV4 - SN3911; ConvF(8.25, 8.25, 8.25); Calibrated: 2013.04.11;
- Sensor-Surface: 2mm (Mechanical Surface Detection)
- Electronics: DAE4 Sn1358; Calibrated: 2013.04.08
- Phantom: SAM 2; Type: QD 000 P40 C; Serial: TP-1754
- Measurement SW: DASY52, Version 52.8 (6); SEMCAD X Version 14.6.9 (7117)

**Pin=250mW/Area Scan (61x61x1):** Interpolated grid:  $dx=15\text{mm}$ ,  $dy=15\text{mm}$

Maximum value of SAR (interpolated) =  $14.9 \text{ W/kg}$

**Pin=250mW/Zoom Scan (5x5x7)/Cube 0:** Measurement grid:  $dx=8\text{mm}$ ,  $dy=8\text{mm}$ ,  $dz=5\text{mm}$

Reference Value =  $95.309 \text{ V/m}$ ; Power Drift =  $-0.06 \text{ dB}$

Peak SAR (extrapolated) =  $18.3 \text{ W/kg}$

**SAR(1 g) =  $10.1 \text{ W/kg}$ ; SAR(10 g) =  $5.31 \text{ W/kg}$**

Maximum value of SAR (measured) =  $14.6 \text{ W/kg}$

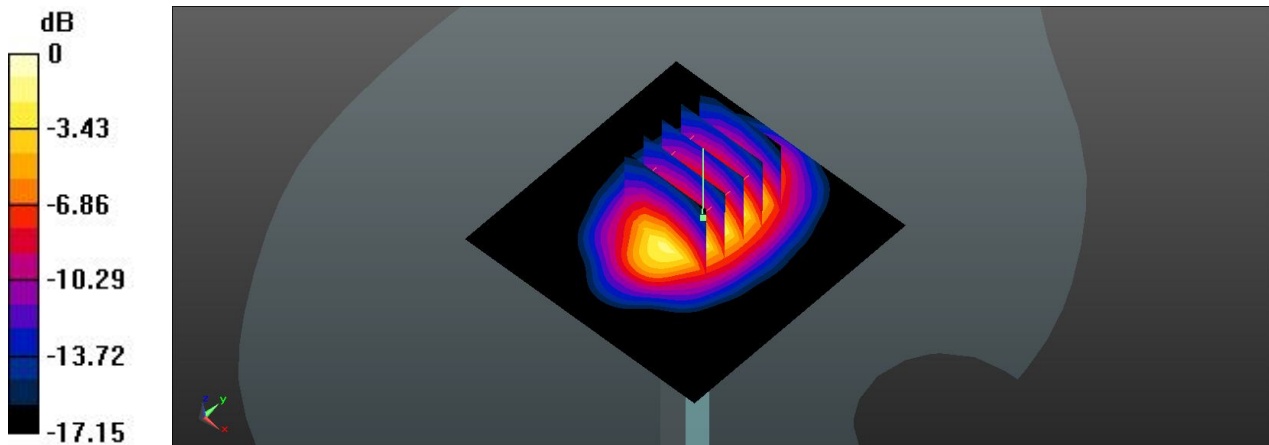

0 dB =  $14.6 \text{ W/kg}$

### System Check\_Head\_2450MHz\_131204

**DUT: D2450V2 - SN: 908**

Communication System: CW; Frequency: 2450 MHz; Duty Cycle: 1:1

Medium: HSL\_2450\_131204 Medium parameters used:  $f = 2450 \text{ MHz}$ ;  $\sigma = 1.809 \text{ S/m}$ ;  $\epsilon_r = 37.604$ ;

$\rho = 1000 \text{ kg/m}^3$

Ambient Temperature:  $23.4 \text{ }^\circ\text{C}$ ; Liquid Temperature :  $22.5 \text{ }^\circ\text{C}$

DASY5 Configuration:

- Probe: EX3DV4 - SN3911; ConvF(7.22, 7.22, 7.22); Calibrated: 2013.04.11;
- Sensor-Surface: 2mm (Mechanical Surface Detection)
- Electronics: DAE4 Sn1358; Calibrated: 2013.04.08
- Phantom: SAM 1; Type: QD 000 P40 C; Serial: TP-1753
- Measurement SW: DASY52, Version 52.8 (6); SEMCAD X Version 14.6.9 (7117)

**Pin=250mW/Area Scan (71x81x1):** Interpolated grid:  $dx=12\text{mm}$ ,  $dy=12\text{mm}$

Maximum value of SAR (interpolated) =  $20.9 \text{ W/kg}$

**Pin=250mW/Zoom Scan (7x7x7)/Cube 0:** Measurement grid:  $dx=5\text{mm}$ ,  $dy=5\text{mm}$ ,  $dz=5\text{mm}$

Reference Value =  $107.6 \text{ V/m}$ ; Power Drift =  $-0.07 \text{ dB}$

Peak SAR (extrapolated) =  $28.2 \text{ W/kg}$

**SAR(1 g) =  $13.1 \text{ W/kg}$ ; SAR(10 g) =  $5.89 \text{ W/kg}$**

Maximum value of SAR (measured) =  $20.2 \text{ W/kg}$

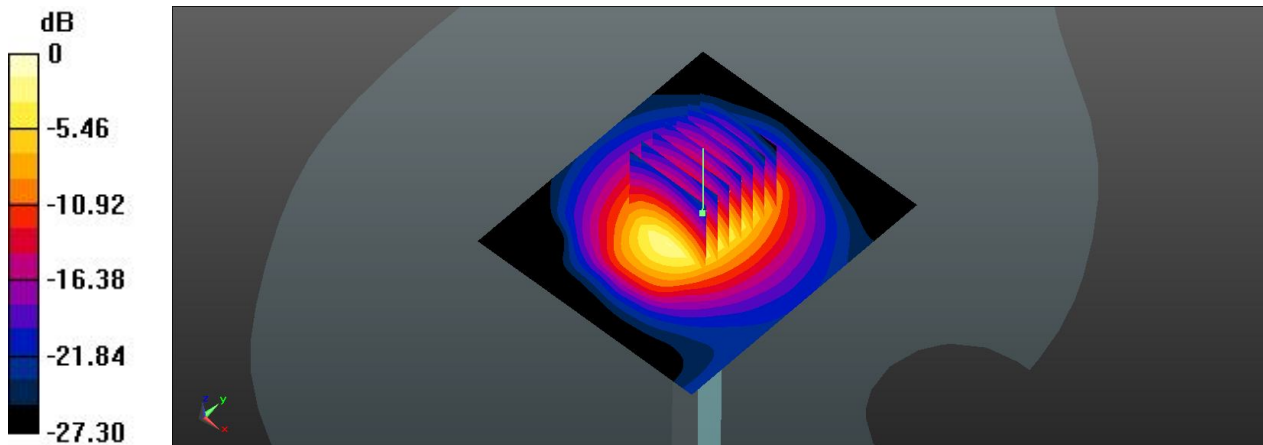

0 dB =  $20.2 \text{ W/kg}$

### System Check\_Body\_835MHz\_131203

**DUT: D835V2 - SN: 4d151**

Communication System: CW; Frequency: 835 MHz; Duty Cycle: 1:1

Medium: MSL\_835\_131203 Medium parameters used:  $f = 835$  MHz;  $\sigma = 0.974$  S/m;  $\epsilon_r = 54.283$ ;  $\rho = 1000$  kg/m<sup>3</sup>

Ambient Temperature: 23.6 °C; Liquid Temperature : 22.4 °C

DASY5 Configuration:

- Probe: EX3DV4 - SN3911; ConvF(9.93, 9.93, 9.93); Calibrated: 2013.04.11;
- Sensor-Surface: 2mm (Mechanical Surface Detection)
- Electronics: DAE4 Sn1358; Calibrated: 2013.04.08
- Phantom: SAM 1; Type: QD 000 P40 C; Serial: TP-1753
- Measurement SW: DASY52, Version 52.8 (6); SEMCAD X Version 14.6.9 (7117)

**Pin=250mW/Area Scan (61x61x1):** Interpolated grid: dx=15mm, dy=15mm

Maximum value of SAR (interpolated) = 3.03 W/kg

**Pin=250mW/Zoom Scan (5x5x7)/Cube 0:** Measurement grid: dx=8mm, dy=8mm, dz=5mm

Reference Value = 56.366 V/m; Power Drift = -0.08 dB

Peak SAR (extrapolated) = 3.53 W/kg

**SAR(1 g) = 2.42 W/kg; SAR(10 g) = 1.6 W/kg**

Maximum value of SAR (measured) = 3.03 W/kg

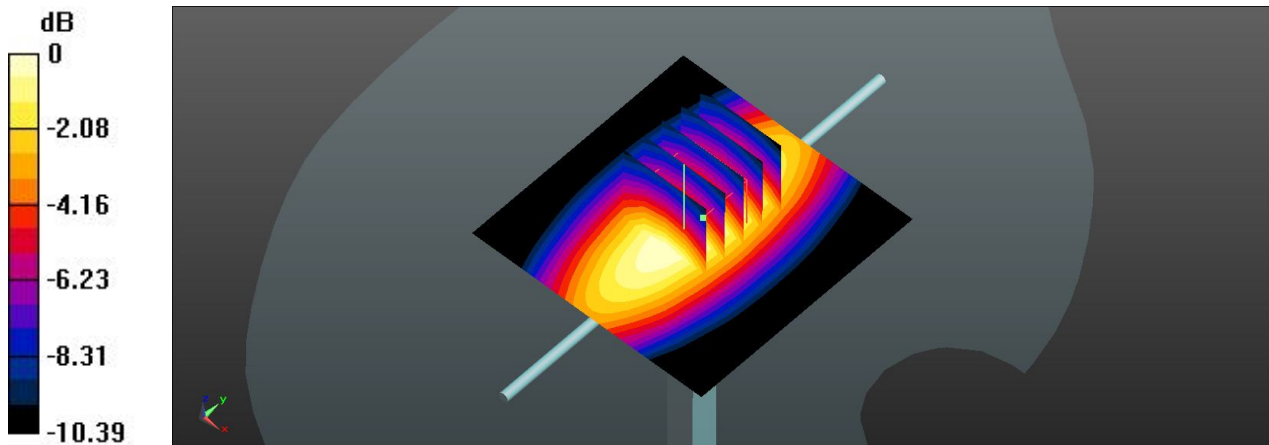

0 dB = 3.03 W/kg



### System Check\_Body\_1750MHz\_131203

**DUT: D1750V2 - SN: 1090**

Communication System: CW; Frequency: 1750 MHz; Duty Cycle: 1:1

Medium: MSL\_1750\_131203 Medium parameters used:  $f = 1750$  MHz;  $\sigma = 1.522$  S/m;  $\epsilon_r = 54.439$ ;  
 $\rho = 1000$  kg/m<sup>3</sup>

Ambient Temperature: 23.6 °C; Liquid Temperature : 22.4 °C

DASY5 Configuration:

- Probe: EX3DV4 - SN3911; ConvF(8.17, 8.17, 8.17); Calibrated: 2013.04.11;
- Sensor-Surface: 2mm (Mechanical Surface Detection)
- Electronics: DAE4 Sn1358; Calibrated: 2013.04.08
- Phantom: SAM 2; Type: QD 000 P40 C; Serial: TP-1754
- Measurement SW: DASY52, Version 52.8 (6); SEMCAD X Version 14.6.9 (7117)

**Pin=250mW/Area Scan (61x61x1):** Interpolated grid: dx=15mm, dy=15mm

Maximum value of SAR (interpolated) = 13.7 W/kg

**Pin=250mW/Zoom Scan (5x5x7)/Cube 0:** Measurement grid: dx=8mm, dy=8mm, dz=5mm

Reference Value = 96.252 V/m; Power Drift = -0.04 dB

Peak SAR (extrapolated) = 17.3 W/kg

**SAR(1 g) = 9.74 W/kg; SAR(10 g) = 5.18 W/kg**

Maximum value of SAR (measured) = 13.8 W/kg

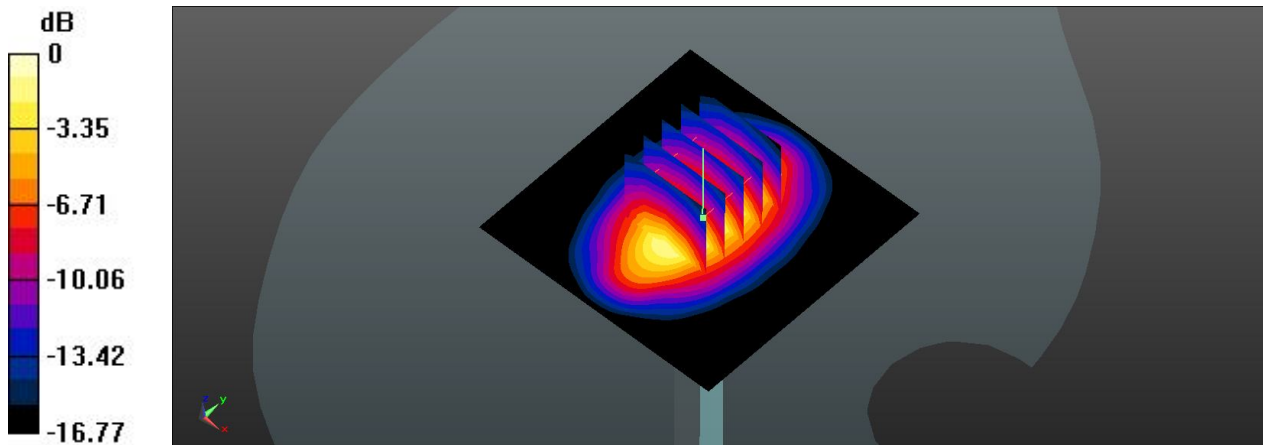

0 dB = 13.8 W/kg

**System Check\_Body\_1900MHz\_131202**

**DUT: D1900V2 - SN: 5d170**

Communication System: CW; Frequency: 1900 MHz; Duty Cycle: 1:1

Medium: MSL\_1900\_131202 Medium parameters used:  $f = 1900$  MHz;  $\sigma = 1.531$  S/m;  $\epsilon_r = 54.671$ ;  
 $\rho = 1000$  kg/m<sup>3</sup>

Ambient Temperature: 23.4 °C; Liquid Temperature : 22.6 °C

DASY5 Configuration:

- Probe: EX3DV4 - SN3911; ConvF(7.7, 7.7, 7.7); Calibrated: 2013.04.11;
- Sensor-Surface: 2mm (Mechanical Surface Detection)
- Electronics: DAE4 Sn1358; Calibrated: 2013.04.08
- Phantom: SAM 2; Type: QD 000 P40 C; Serial: TP-1754
- Measurement SW: DASY52, Version 52.8 (6); SEMCAD X Version 14.6.9 (7117)

**Pin=250mW/Area Scan (61x61x1):** Interpolated grid: dx=15mm, dy=15mm

Maximum value of SAR (interpolated) = 14.6 W/kg

**Pin=250mW/Zoom Scan (5x5x7)/Cube 0:** Measurement grid: dx=8mm, dy=8mm, dz=5mm

Reference Value = 96.980 V/m; Power Drift = -0.04 dB

Peak SAR (extrapolated) = 18.3 W/kg

**SAR(1 g) = 10.5 W/kg; SAR(10 g) = 5.5 W/kg**

Maximum value of SAR (measured) = 14.4 W/kg

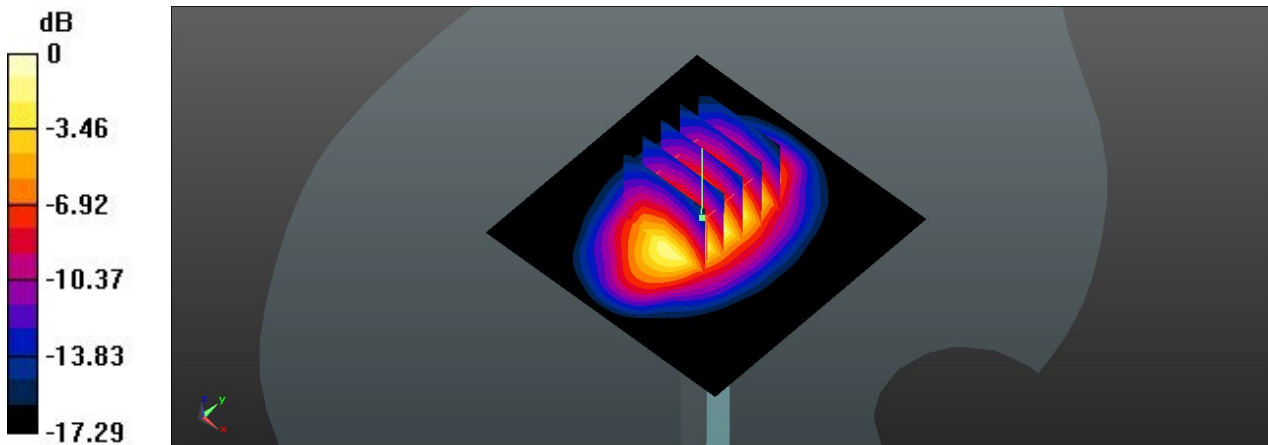

0 dB = 14.4 W/kg

### System Check\_Body\_2450MHz\_131204

**DUT: D2450V2 - SN: 908**

Communication System: CW; Frequency: 2450 MHz; Duty Cycle: 1:1

Medium: MSL\_2450\_131204 Medium parameters used:  $f = 2450$  MHz;  $\sigma = 1.951$  S/m;  $\epsilon_r = 53.859$ ;  $\rho = 1000$  kg/m<sup>3</sup>

Ambient Temperature: 23.5 °C; Liquid Temperature : 22.7 °C

DASY5 Configuration:

- Probe: EX3DV4 - SN3911; ConvF(7.34, 7.34, 7.34); Calibrated: 2013.04.11;
- Sensor-Surface: 2mm (Mechanical Surface Detection)
- Electronics: DAE4 Sn1358; Calibrated: 2013.04.08
- Phantom: SAM 1; Type: QD 000 P40 C; Serial: TP-1753
- Measurement SW: DASY52, Version 52.8 (6); SEMCAD X Version 14.6.9 (7117)

**Pin=250mW/Area Scan (71x81x1):** Interpolated grid: dx=12mm, dy=12mm

Maximum value of SAR (interpolated) = 19.1 W/kg

**Pin=250mW/Zoom Scan (7x7x7)/Cube 0:** Measurement grid: dx=5mm, dy=5mm, dz=5mm

Reference Value = 94.674 V/m; Power Drift = -0.03 dB

Peak SAR (extrapolated) = 24.9 W/kg

**SAR(1 g) = 12.4 W/kg; SAR(10 g) = 5.85 W/kg**

Maximum value of SAR (measured) = 18.5 W/kg

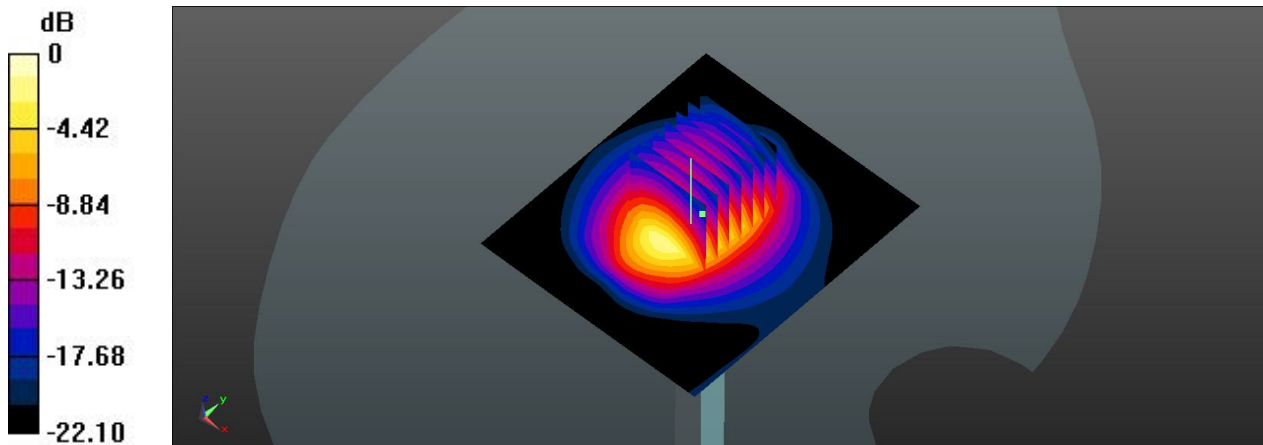

0 dB = 18.5 W/kg