

FCC Test Report

APPLICANT : CT Asia
EQUIPMENT : GSM mobile phone
BRAND NAME : BLU
MODEL NAME : Spark TV
FCC ID : YHLBLUSPARKTV
STANDARD : FCC 47 CFR FCC Part 15 Subpart B
CLASSIFICATION : Certification

The product was received on Jan. 15, 2013 and completely tested on Mar. 04, 2013. We, SPORTON INTERNATIONAL (KUNSHAN) INC., would like to declare that the tested sample has been evaluated in accordance with the procedures given in ANSI C63.4-2003 and shown the compliance with the applicable technical standards.

The test results in this report apply exclusively to the tested model / sample. Without written approval of SPORTON INTERNATIONAL (KUNSHAN) INC., the test report shall not be reproduced except in full.

Reviewed by:



Jones Tsai / Manager



SPORTON INTERNATIONAL (KUNSHAN) INC.
No. 3-2, PingXiang Road, Kunshan, Jiangsu Province, P.R.C.



TABLE OF CONTENTS

REVISION HISTORY..... 3

SUMMARY OF TEST RESULT 4

1. GENERAL DESCRIPTION 5

 1.1. Applicant..... 5

 1.2. Manufacturer 5

 1.3. Feature of Equipment Under Test..... 5

 1.4. Product Specification of Equipment Under Test 5

 1.5. Test Site 6

 1.6. Applied Standards 6

2. TEST CONFIGURATION OF EQUIPMENT UNDER TEST 7

 2.1. Test Mode 7

 2.2. Connection Diagram of Test System 9

 2.3. Support Unit used in test configuration and system..... 10

 2.4. Test Software 11

3. TEST RESULT..... 12

 3.1. Test of AC Conducted Emission Measurement 12

 3.2. Test of Radiated Emission Measurement 18

4. LIST OF MEASURING EQUIPMENT 24

5. UNCERTAINTY OF EVALUATION 25

APPENDIX A. PHOTOGRAPHS OF EUT

APPENDIX B. SETUP PHOTOGRAPHS



REVISION HISTORY

REPORT NO.	VERSION	DESCRIPTION	ISSUED DATE
FC311501	Rev. 01	Initial issue of report	Mar. 05, 2013



SUMMARY OF TEST RESULT

Report Section	FCC Rule	IC Rule	Description	Limit	Result	Remark
3.1	15.107	7.2.4	AC Conducted Emission	< 15.107 limits < RSS-Gen table 2 limits	PASS	Under limit 5.51 dB at 2.280 MHz
3.2	15.109	7.2.3.2	Radiated Emission	< 15.109 limits or < RSS-Gen table 1 limits (Section 6)	PASS	Under limit 10.57 dB at 41.640 MHz for Quasi-Peak

1. General Description

1.1. Applicant

CT Asia

Unit 01, 15/F, Seaview Centre, 139-141 Hoi bun road, Kwun Tong, Kowloon, Hongkong

1.2. Manufacturer

Zechin Communications Co., Ltd.

Unit804, 8th Floor Desay Tech Building Gaoxin Road South, Nanshan District Shenzhen, China

1.3. Feature of Equipment Under Test

Product Feature	
Equipment	GSM mobile phone
Brand Name	BLU
Model Name	Spark TV
FCC ID	YHLBLUSPARKTV
EUT supports Radios application	GSM/GPRS/EGPRS (Downlink Only)/Bluetooth
HW Version	X565-MB-V0.2
SW Version	BLU_S130T_V20_GENERIC
EUT Stage	Production Unit

Remark: The above EUT's information was declared by manufacturer. Please refer to the specifications or user's manual for more detailed description.

1.4. Product Specification of Equipment Under Test

Product Specification subjective to this standard	
Tx Frequency	GSM850: 824.2 MHz ~ 848.8 MHz GSM1900: 1850.2 MHz ~ 1909.8MHz Bluetooth: 2402 MHz ~ 2480 MHz
Rx Frequency Range	GSM850: 869.2 MHz ~ 893.8 MHz GSM1900: 1930.2 MHz ~ 1989.8 MHz Bluetooth: 2402 MHz ~ 2480 MHz FM: 88 MHz ~ 108 MHz
Antenna Type	WWAN : Fixed Internal Antenna Bluetooth : PIFA Antenna
Type of Modulation	GSM / GPRS: GMSK EDGE: GMSK / 8PSK (Downlink Only) Bluetooth BDR (1Mbps) : GFSK Bluetooth EDR (2Mbps) : $\pi/4$ -DQPSK Bluetooth EDR (3Mbps) : 8-DPSK FM

1.5. Test Site

Test Site	SPORTON INTERNATIONAL (KUNSHAN) INC.		
Test Site Location	No. 3-2, PingXiang Road, Kunshan, Jiangsu Province, P.R.C. TEL: +86-0512-5790-0158 FAX: +86-0512-5790-0958		
Test Site No.	Sporton Site No.		FCC/IC Registration No.
	CO01-KS	03CH01-KS	149928/4086E-1

1.6. Applied Standards

According to the specifications of the manufacturer, the EUT must comply with the requirements of the following standards:

- FCC 47 CFR FCC Part 15 Subpart B
- ANSI C63.4-2003

Remark: All test items were verified and recorded according to the standards and without any deviation during the test.

2. Test Configuration of Equipment Under Test

2.1. Test Mode

The EUT has been associated with peripherals pursuant to ANSI C63.4-2003 and configuration operated in a manner tended to maximize its emission characteristics in a typical application.

Frequency range investigated: conduction (150 KHz to 30 MHz), radiation (30MHz to the 5th harmonic of the highest fundamental frequency or to 40 GHz, whichever is lower).

The following tables are showing the test modes as the worst cases and recorded in this report.

Item	EUT Configuration	Test Condition		
		EMI AC	EMI RE<1G	EMI RE≥1G
1.	Charging Mode (EUT with adapter)	☒	☒	☒
2.	Data application transferred mode (EUT with PC)	☒	☒	☒

Abbreviations:

- EMI AC: AC conducted emissions
- EMI RE ≥ 1G: EUT radiated emissions ≥ 1GHz
- EMI RE < 1G: EUT radiated emissions < 1GHz

Test Items	EUT Configure Mode	Function Type
AC Conducted Emission	1/2	Mode 1: GSM850 Idle + USB Cable (Charging from Adapter) + Bluetooth Idle + Camera + SIM 2 <Fig. 1> Mode 2: GSM1900 Idle + USB Cable (Charging from Adapter) + Bluetooth Idle + MP3 + SIM 2 <Fig. 1> Mode 3: GSM850 Idle + USB Cable (Charging from Adapter) + Bluetooth Idle + FM Rx + SIM 2 <Fig. 2> Mode 4: GSM1900 Idle + USB Cable (Data Link with PC) + Bluetooth Idle + SIM 2 <Fig. 3>
Radiated Emissions < 1GHz	1/2	Mode 1: GSM850 Idle + USB Cable (Charging from Adapter) + Bluetooth Idle + Camera + SIM 2 <Fig. 1> Mode 2: GSM1900 Idle + USB Cable (Charging from Adapter) + Bluetooth Idle + MP3 + SIM 2 <Fig. 1> Mode 3: GSM850 Idle + USB Cable (Charging from Adapter) + Bluetooth Idle + FM Rx + SIM 2 <Fig. 2> Mode 4: GSM1900 Idle + USB Cable (Data Link with PC) + Bluetooth Idle + SIM 2 <Fig. 3>
Radiated Emissions ≥ 1GHz	1/2	Mode 1: GSM850 Idle + USB Cable (Charging from Adapter) + Bluetooth Idle + Camera + SIM 2 <Fig. 1> Mode 2: GSM1900 Idle + USB Cable (Data Link with PC) + Bluetooth Idle + SIM 2 <Fig. 3>

Remark:

1. The worst case of AC Conducted Emission is mode 2; the test data of this mode was reported.
2. The USB link of AC Conducted Emission is mode 4; the test data of this mode was reported.
3. The worst case of Radiated Emissions is mode 1; the test data of this mode was reported.
4. The USB link of Radiated Emissions is mode 4; the test data of this mode was reported.
5. Link with PC means data application transferred mode between EUT and PC.

2.2. Connection Diagram of Test System

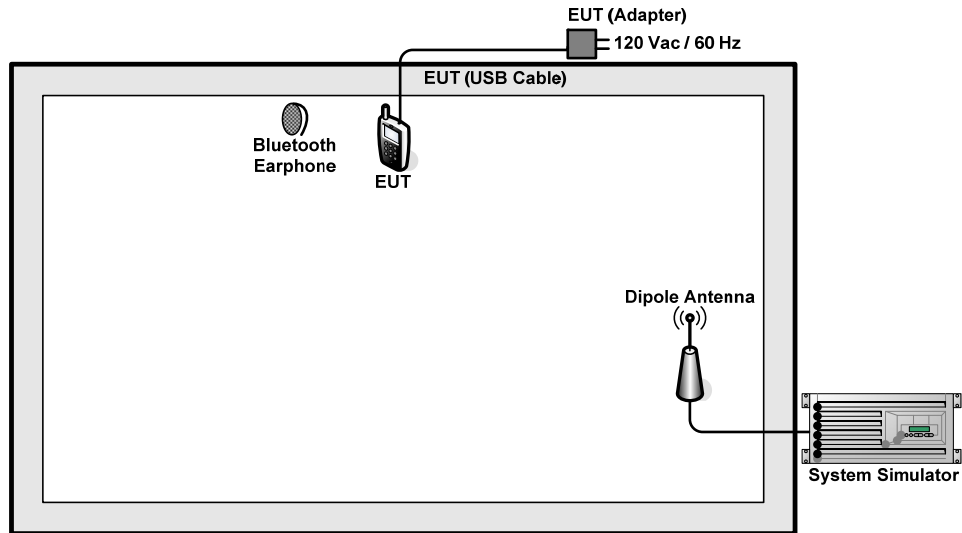

<Fig. 1>

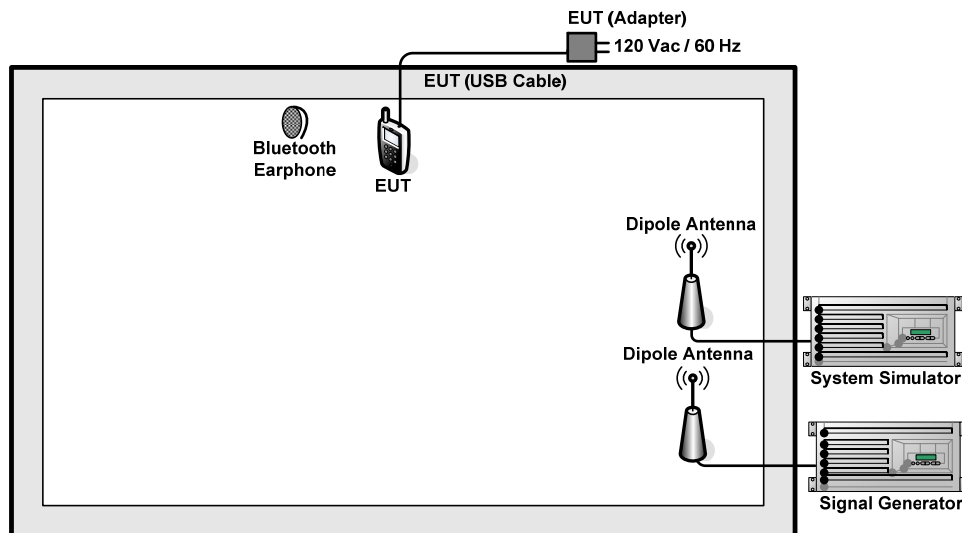

<Fig. 2>

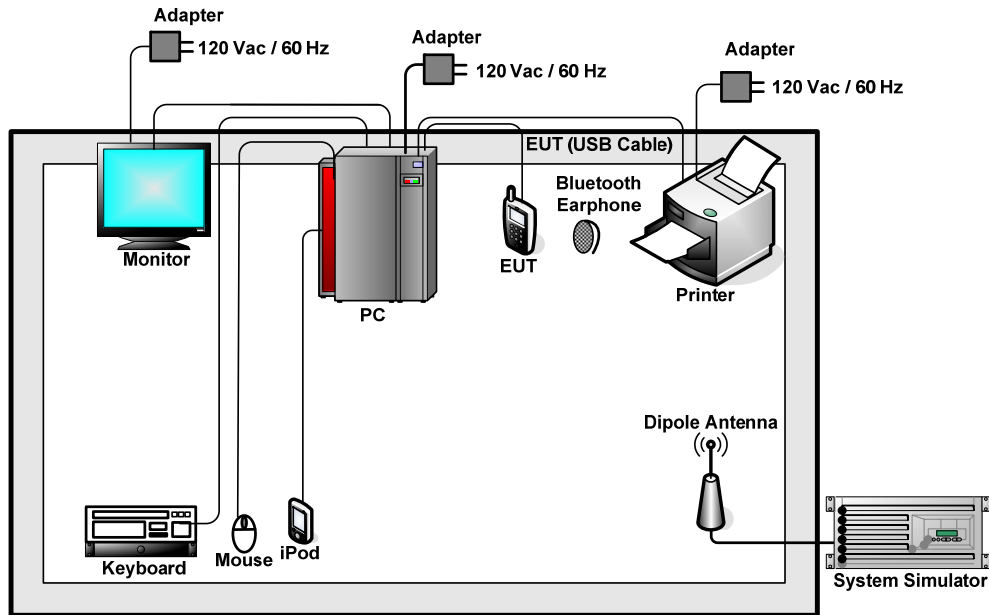

<Fig. 3>

2.3. Support Unit used in test configuration and system

Item	Equipment	Trade Name	Model Name	FCC ID	Data Cable	Power Cord
1.	System Simulator	R&S	CMU 200	N/A	N/A	Unshielded, 1.8 m
2.	Signal Generator	R&S	SMR40	FCC DoC	Shielded, 1.6 m	Unshielded, 1.8 m
3.	PC	Dell	DCSM	FCC DoC	N/A	Unshielded, 1.8 m
4.	PC	Dell	MT320	FCC DoC	N/A	Unshielded, 1.8 m
5.	Monitor	Dell	E1910Hc	FCC DoC	N/A	Unshielded, 1.8 m
6.	(USB) Mouse	Dell	MO56UC	FCC DoC	Shielded, 1.8 m	N/A
7.	(USB) Mouse	Dell	N231	FCC DoC	Shielded, 1.8 m	N/A
8.	(USB) Keyboard	Dell	SK-8115	FCC DoC	Shielded, 1.5 m	N/A
9.	Printer	HP	Laser Jet 1018	FCC DoC	Shielded, 1.8 m	Unshielded, 1.8 m
10.	Bluetooth Earphone	Nokia	BH-102	PYAHS-107W	N/A	N/A
11.	Bluetooth Earphone	Nokia	BH-106	QTLBH-106	N/A	N/A
12.	iPod	Apple	A1199	FCC DoC	Unshielded, 1.2 m	N/A



2.4. Test Software

The EUT was in GSM idle mode during the testing. The EUT was synchronized to the BCCH, and is in continuous receiving mode by setting system simulator's paging reorganization.

At the same time, the EUT was attached to the Bluetooth earphone, and the following programs installed in the EUT were programmed during the test.

1. Execute the program, "Winthrax" under WIN7 installed in PC for files transfer with EUT via USB cable.
2. Turn on FM function to keep EUT receiving continuous signals from Signal Generator.
3. Execute "Music Player" to play MP3 file.

3. Test Result

3.1. Test of AC Conducted Emission Measurement

3.1.1 Limits of AC Conducted Emission

For equipment that is designed to be connected to the public utility (AC) power line, the radio frequency voltage that is conducted back onto the AC power line on any frequency or frequencies within the band 150 KHz to 30 MHz shall not exceed the limits in the following table.

Frequency of emission (MHz)	Conducted limit (dBuV)	
	Quasi-peak	Average
0.15-0.5	66 to 56*	56 to 46*
0.5-5	56	46
5-30	60	50

*Decreases with the logarithm of the frequency.

3.1.2 Measuring Instruments

See list of measuring instruments of this test report.

3.1.3 Test Procedure

1. The EUT was placed 0.4 meter from the conducting wall of the shielding room was kept at least 80 centimeters from any other grounded conducting surface.
2. Connect EUT to the power mains through a line impedance stabilization network (LISN).
3. All the support units are connecting to the other LISN.
4. The LISN provides 50 ohm coupling impedance for the measuring instrument.
5. The FCC states that a 50 ohm, 50 microhenry LISN should be used.
6. Both sides of AC line were checked for maximum conducted interference.
7. The frequency range from 150 KHz to 30 MHz was searched.
8. Set the test-receiver system to Peak Detect Function and specified bandwidth with Maximum Hold Mode.

3.1.4 Test Setup

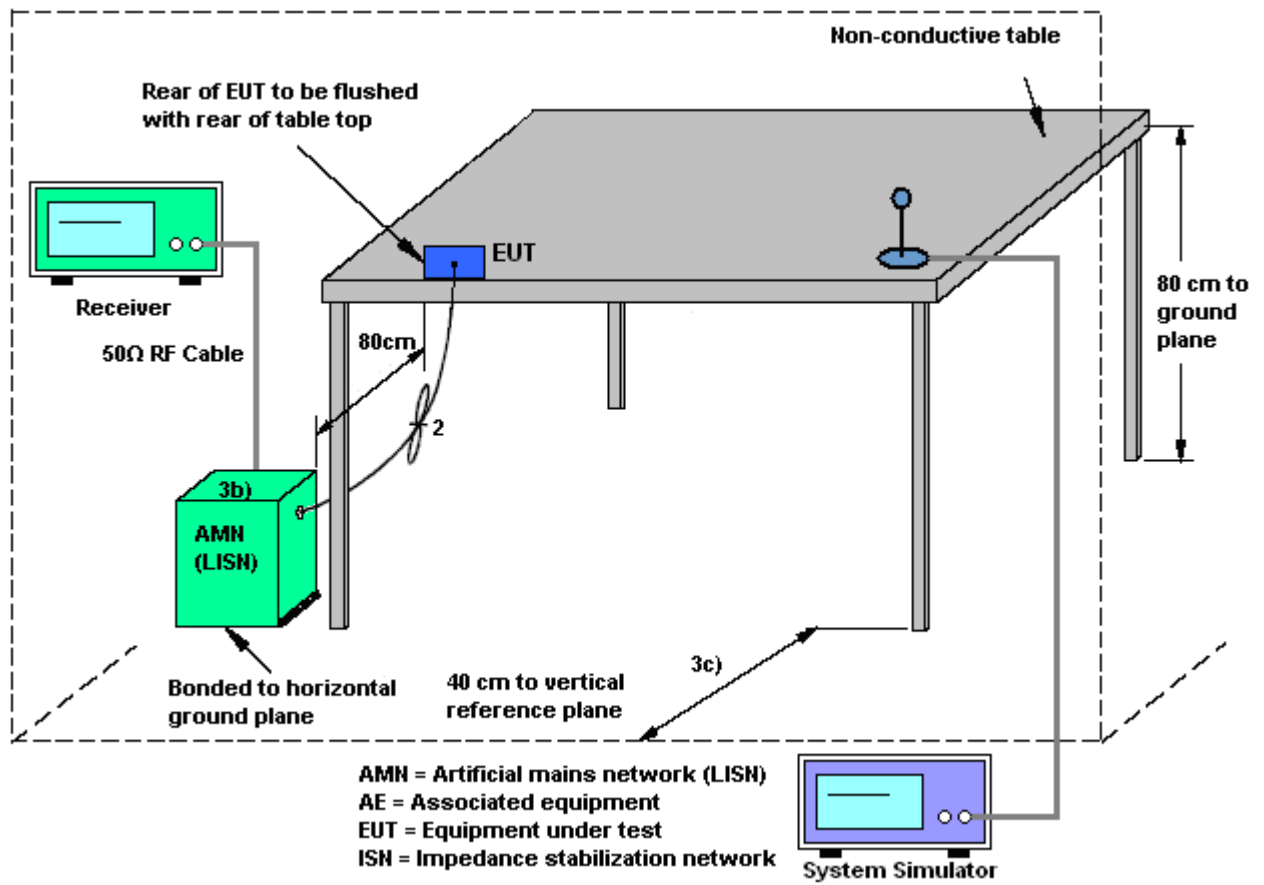

3.1.5 Test Result of AC Conducted Emission

Test Mode :	Mode 2	Temperature :	19~20°C
Test Engineer :	Tom Wang	Relative Humidity :	39~40%
Test Voltage :	120Vac / 60Hz	Phase :	Line
Function Type :	GSM1900 Idle + USB Cable (Charging from Adapter) + Bluetooth Idle + MP3 + SIM 2		
Remark :	All emissions not reported here are more than 10 dB below the prescribed limit.		

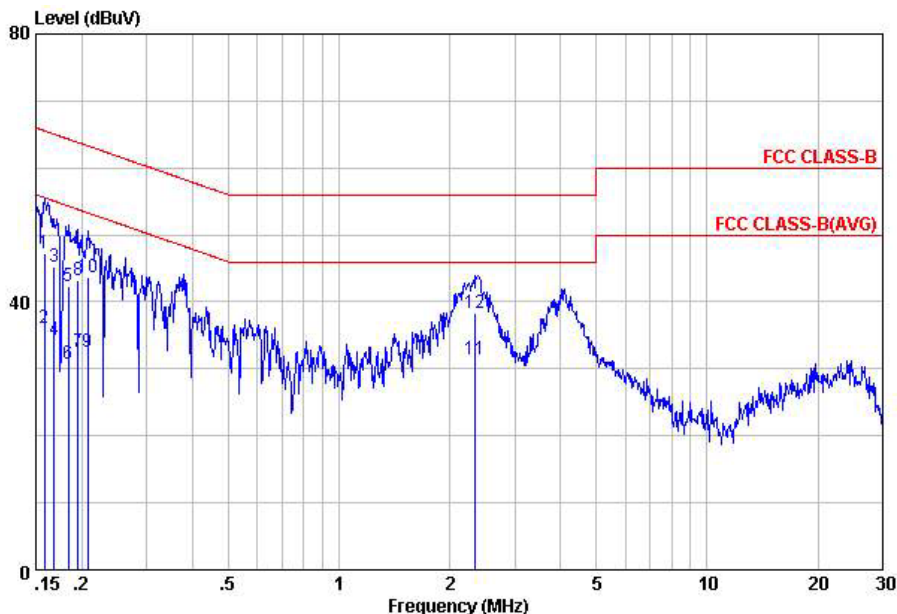

Site : C001-KS
 Condition: FCC CLASS-B LISN-111230 LINE
 Project : (FC) 311501
 mode : Mode 2

	Freq	Level	Over	Limit	Read	LISN	Cable	Remark
	MHz	dBuV	Limit	Line	Level	Factor	Loss	
			dB	dBuV	dBuV	dB	dB	
1	0.16	47.13	-18.43	65.56	37.00	-0.07	10.20	QP
2	0.16	36.13	-19.43	55.56	26.00	-0.07	10.20	Average
3	0.17	45.34	-19.69	65.03	35.20	-0.07	10.21	QP
4	0.17	34.34	-20.69	55.03	24.20	-0.07	10.21	Average
5	0.18	42.25	-22.08	64.33	32.10	-0.07	10.22	QP
6	0.18	30.75	-23.58	54.33	20.60	-0.07	10.22	Average
7	0.20	32.45	-21.35	53.80	22.30	-0.07	10.22	Average
8	0.20	43.15	-20.65	63.80	33.00	-0.07	10.22	QP
9	0.21	32.55	-20.77	53.32	22.40	-0.07	10.22	Average
10	0.21	43.75	-19.57	63.32	33.60	-0.07	10.22	QP
11	2.35	31.39	-14.61	46.00	21.20	-0.11	10.30	Average
12	2.35	38.29	-17.71	56.00	28.10	-0.11	10.30	QP



Test Mode :	Mode 2	Temperature :	19~20°C
Test Engineer :	Tom Wang	Relative Humidity :	39~40%
Test Voltage :	120Vac / 60Hz	Phase :	Neutral
Function Type :	GSM1900 Idle + USB Cable (Charging from Adapter) + Bluetooth Idle + MP3 + SIM 2		
Remark :	All emissions not reported here are more than 10 dB below the prescribed limit.		

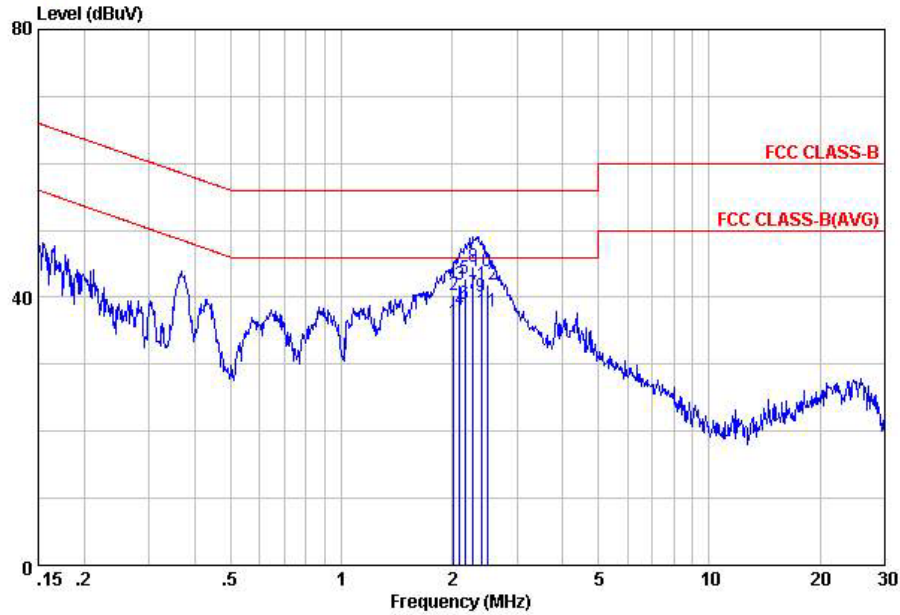

Site : C001-KS
 Condition: FCC CLASS-B LISN-111230 NEUTRAL
 Project : (FC) 311501
 mode : Mode 2

	Freq	Level	Over	Limit	Read	LISN	Cable	Remark
	MHz	dBuV	Limit	Line	Level	Factor	Loss	
			dB	dBuV	dBuV	dB	dB	
1	2.02	36.39	-9.61	46.00	26.20	-0.11	10.30	Average
2	2.02	40.29	-15.71	56.00	30.10	-0.11	10.30	QP
3	2.10	41.89	-14.11	56.00	31.70	-0.11	10.30	QP
4	2.10	38.19	-7.81	46.00	28.00	-0.11	10.30	Average
5	2.17	42.89	-13.11	56.00	32.70	-0.11	10.30	QP
6	2.17	38.99	-7.01	46.00	28.80	-0.11	10.30	Average
7	2.28	40.49	-5.51	46.00	30.30	-0.11	10.30	Average
8	2.28	44.59	-11.41	56.00	34.40	-0.11	10.30	QP
9	2.40	40.09	-5.91	46.00	29.89	-0.11	10.31	Average
10	2.40	43.99	-12.01	56.00	33.79	-0.11	10.31	QP
11	2.49	37.99	-8.01	46.00	27.79	-0.11	10.31	Average
12	2.49	41.99	-14.01	56.00	31.79	-0.11	10.31	QP



Test Mode :	Mode 4	Temperature :	19~20°C
Test Engineer :	Tom Wang	Relative Humidity :	39~40%
Test Voltage :	120Vac / 60Hz	Phase :	Line
Function Type :	GSM1900 Idle + USB Cable (Data Link with PC) + Bluetooth Idle + SIM 2		
Remark :	All emissions not reported here are more than 10 dB below the prescribed limit.		

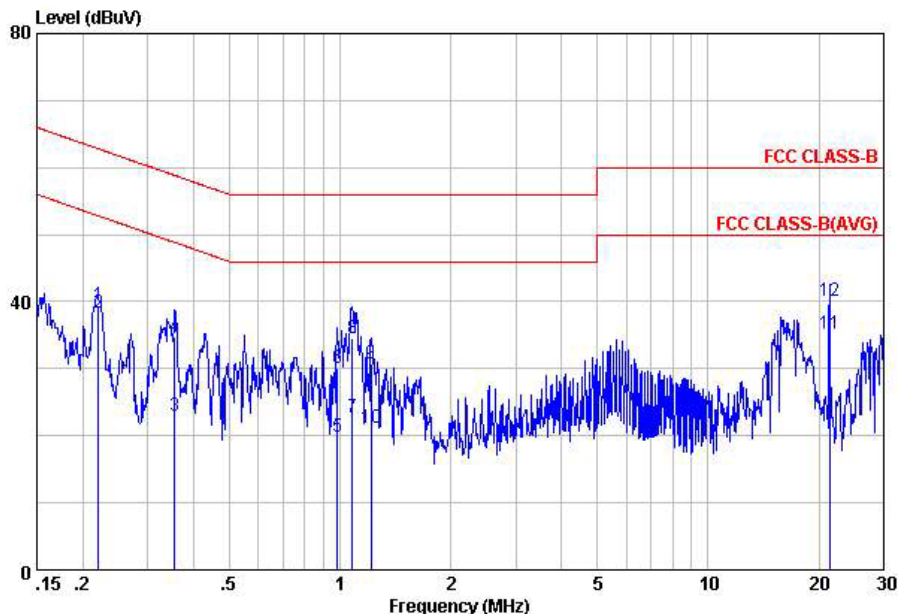

Site : C001-KS
 Condition: FCC CLASS-B LISN-111230 LINE
 Project : (FC) 311501
 mode : Mode 4

	Freq	Level	Over	Limit	Read	LISN	Cable	Remark
	MHz	dBuV	Limit	Line	Level	Factor	Loss	
			dB	dBuV	dBuV	dB	dB	
1	0.22	39.35	-23.44	62.79	29.20	-0.07	10.22	QP
2	0.22	38.35	-14.44	52.79	28.20	-0.07	10.22	Average
3	0.36	22.87	-25.96	48.83	12.70	-0.08	10.25	Average
4	0.36	34.87	-23.96	58.83	24.70	-0.08	10.25	QP
5	0.98	19.88	-26.12	46.00	9.70	-0.10	10.28	Average
6	0.98	29.98	-26.02	56.00	19.80	-0.10	10.28	QP
7	1.08	22.78	-23.22	46.00	12.60	-0.10	10.28	Average
8	1.08	34.58	-21.42	56.00	24.40	-0.10	10.28	QP
9	1.22	30.68	-25.32	56.00	20.50	-0.10	10.28	QP
10	1.22	21.08	-24.92	46.00	10.90	-0.10	10.28	Average
11	21.37	35.20	-14.80	50.00	24.60	0.09	10.51	Average
12	21.37	40.10	-19.90	60.00	29.50	0.09	10.51	QP



Test Mode :	Mode 4	Temperature :	19~20°C
Test Engineer :	Tom Wang	Relative Humidity :	39~40%
Test Voltage :	120Vac / 60Hz	Phase :	Neutral
Function Type :	GSM1900 Idle + USB Cable (Data Link with PC) + Bluetooth Idle + SIM 2		
Remark :	All emissions not reported here are more than 10 dB below the prescribed limit.		

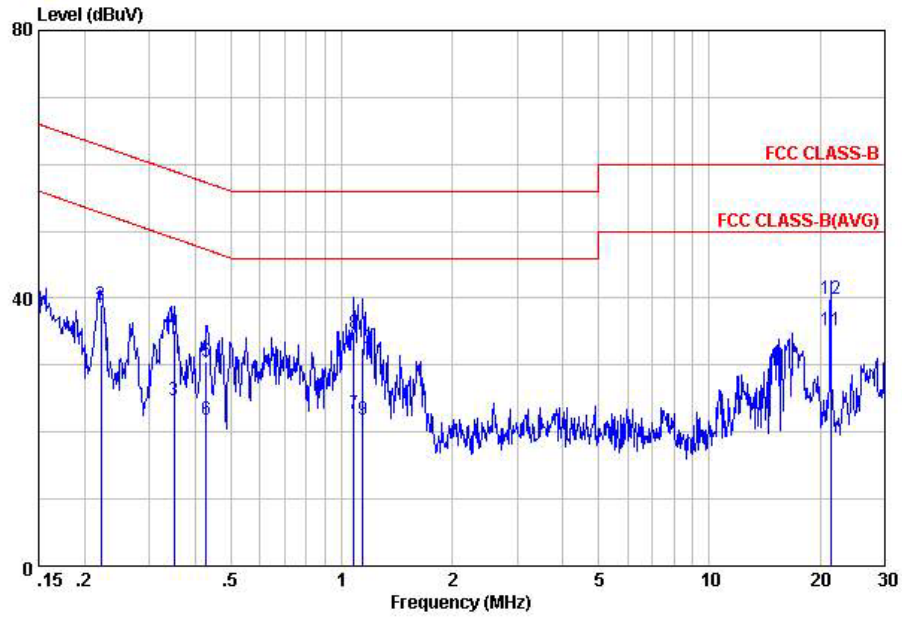

Site : C001-KS
 Condition: FCC CLASS-B LISN-111230 NEUTRAL
 Project : (FC) 311501
 mode : Mode 4

	Freq	Level	Over	Limit	Read	LISN	Cable	Remark
	MHz	dBuV	Limit	Line	Level	Factor	Loss	
			dB	dBuV	dBuV	dB	dB	
1	0.22	38.65	-14.09	52.74	28.50	-0.07	10.22	Average
2	0.22	39.05	-23.69	62.74	28.90	-0.07	10.22	QP
3	0.35	24.77	-24.19	48.96	14.60	-0.08	10.25	Average
4	0.35	35.17	-23.79	58.96	25.00	-0.08	10.25	QP
5	0.43	30.57	-26.72	57.29	20.40	-0.08	10.25	QP
6	0.43	21.77	-25.52	47.29	11.60	-0.08	10.25	Average
7	1.08	22.79	-23.21	46.00	12.60	-0.09	10.28	Average
8	1.08	34.69	-21.31	56.00	24.50	-0.09	10.28	QP
9	1.14	21.89	-24.11	46.00	11.70	-0.09	10.28	Average
10	1.14	32.59	-23.41	56.00	22.40	-0.09	10.28	QP
11	21.37	35.18	-14.82	50.00	24.60	0.07	10.51	Average
12	21.37	39.98	-20.02	60.00	29.40	0.07	10.51	QP

3.2. Test of Radiated Emission Measurement

3.2.1. Limit of Radiated Emission

The emissions from an unintentional radiator shall not exceed the field strength levels specified in the following table:

Frequency (MHz)	Field Strength (microvolts/meter)	Measurement Distance (meters)
30 – 88	100	3
88 – 216	150	3
216 - 960	200	3
Above 960	500	3

3.2.2. Measuring Instruments

See list of measuring instruments of this test report.

3.2.3. Test Procedures

1. The EUT was placed on a turntable with 0.8 meter above ground.
2. The EUT was set 3 meters from the interference receiving antenna, which was mounted on the top of a variable height antenna tower.
3. The table was rotated 360 degrees to determine the position of the highest radiation.
4. The antenna height is adjusted between one to four meters above ground to find the maximum value of the field strength for both horizontal polarization and vertical polarization of the antenna.
5. For each suspected emission, the EUT was arranged to its worst case and then tune the antenna tower (from 1 m to 4 m) and turntable (from 0 degree to 360 degrees) to find the maximum reading.
6. Set the test-receiver system to Peak Detect Function and specified bandwidth with Maximum Hold Mode.
7. If the emission level of the EUT in peak mode was 3 dB lower than the limit specified, peak values of EUT will be reported. Otherwise, the emission will be repeated by using the quasi-peak method and reported.
8. Emission level (dBuV/m) = 20 log Emission level (uV/m)
9. Corrected Reading: Antenna Factor + Cable Loss + Read Level - Preamp Factor= Level

3.2.4. Test Setup of Radiated Emission

For radiated emissions from 30MHz to 1GHz

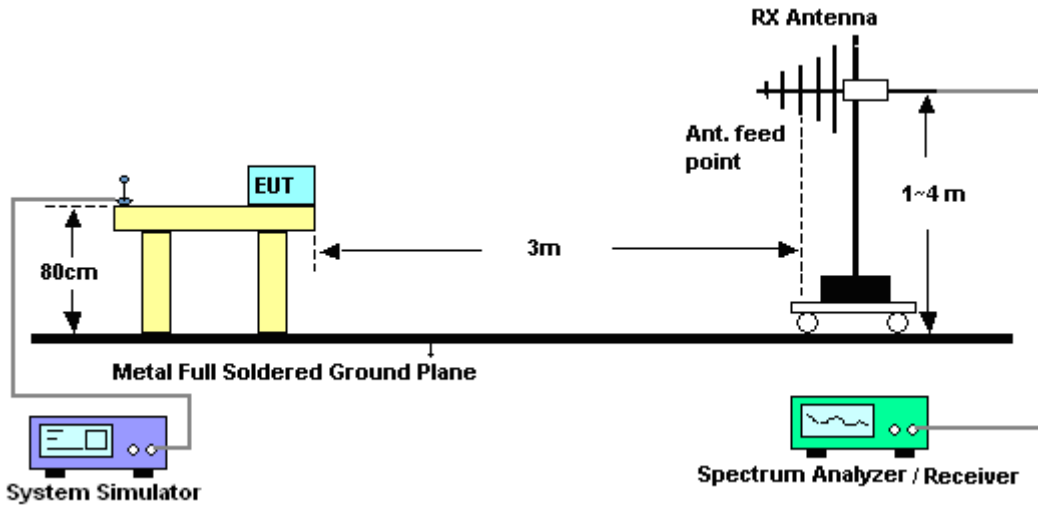

For radiated emissions above 1GHz

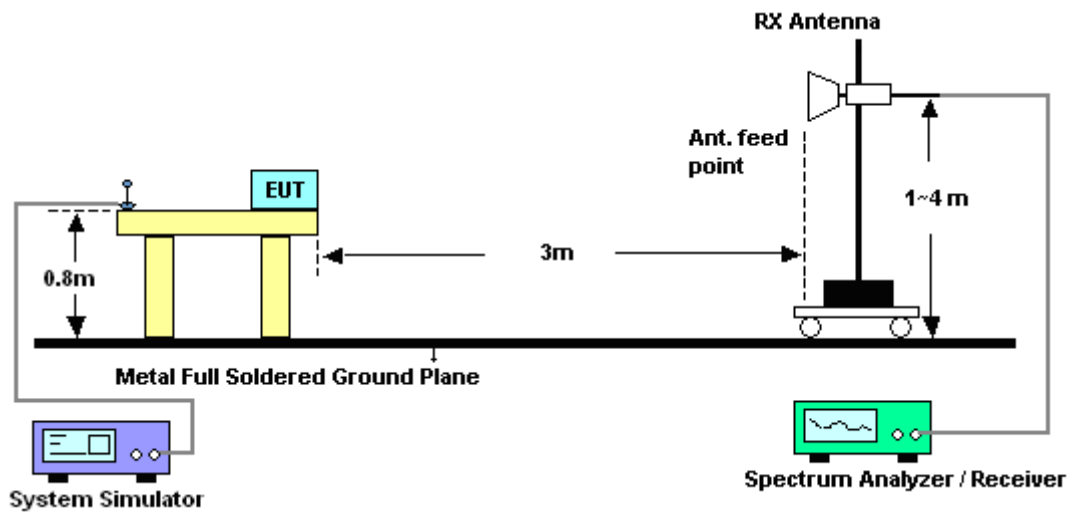



3.2.5. Test Result of Radiated Emission

Test Mode :	Mode 1	Temperature :	22~23°C
Test Engineer :	Steven Hao	Relative Humidity :	41~42%
Test Distance :	3m	Polarization :	Horizontal
Function Type :	GSM850 Idle + USB Cable (Charging from Adapter) + Bluetooth Idle + Camera + SIM 2		

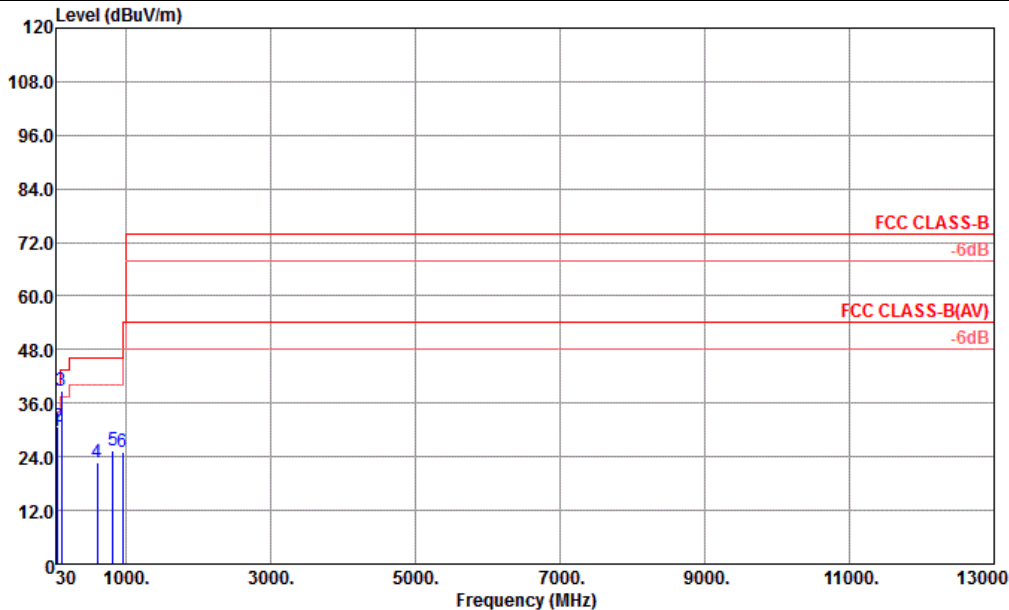

Site : 03CH01-KS
 Condition : FCC CLASS-B 3m LF_ANT-100803 HORIZONTAL
 Project : (FC) 311501
 Mode : Mode 1

	Freq	Level	Over Limit	Limit Line	ReadAntenna Level	Antenna Factor	Cable Loss	Preamp Factor	A/Pos	T/Pos	Remark
	MHz	dBuV/m	dB	dBuV/m	dBuV	dB/m	dB	dB	cm	deg	
1	40.67	29.64	-10.36	40.00	51.26	11.63	0.38	33.63	---	---	Peak
2	60.07	30.88	-9.12	40.00	58.70	5.29	0.47	33.58	---	---	Peak
3 !	107.60	38.72	-4.78	43.50	60.21	11.53	0.58	33.60	100	254	Peak
4	600.36	22.64	-23.36	46.00	35.60	18.59	1.39	32.94	---	---	Peak
5	818.61	25.51	-20.49	46.00	36.47	20.06	1.63	32.65	---	---	Peak
6	954.41	25.20	-20.80	46.00	35.13	20.75	1.75	32.43	---	---	Peak



Test Mode :	Mode 1	Temperature :	22~23°C
Test Engineer :	Steven Hao	Relative Humidity :	41~42%
Test Distance :	3m	Polarization :	Vertical
Function Type :	GSM850 Idle + USB Cable (Charging from Adapter) + Bluetooth Idle + Camera + SIM 2		

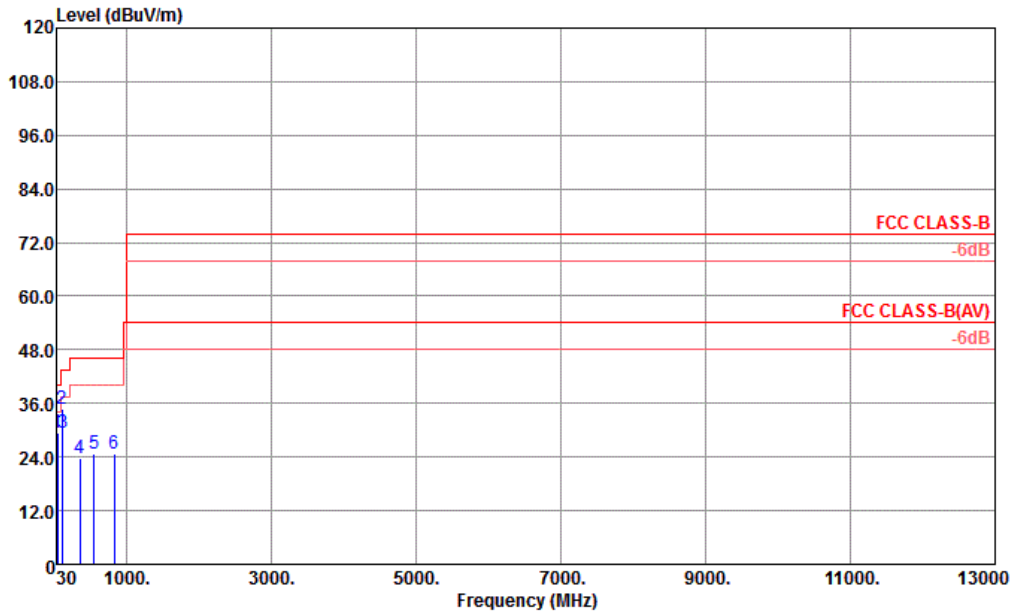

Site : 03CH01-KS
 Condition : FCC CLASS-B 3m LF_ANT-100803 VERTICAL
 Project : (FC) 311501
 Mode : Mode 1

	Freq	Level	Over Limit	Limit Line	ReadAntenna Level	Antenna Factor	Cable Loss	Preamp Factor	A/Pos	T/Pos	Remark
	MHz	dBuV/m	dB	dBuV/m	dBuV	dB/m	dB	dB	cm	deg	
1	41.64	29.43	-10.57	40.00	51.73	10.94	0.39	33.63	200	0	QP
2	106.63	34.88	-8.62	43.50	56.50	11.40	0.58	33.60	---	---	Peak
3	119.24	29.30	-14.20	43.50	50.48	11.79	0.62	33.59	---	---	Peak
4	359.80	23.79	-22.21	46.00	41.32	14.71	1.10	33.34	---	---	Peak
5	551.86	24.61	-21.39	46.00	37.81	18.49	1.32	33.01	---	---	Peak
6	826.37	24.88	-21.12	46.00	35.74	20.19	1.63	32.68	---	---	Peak



Test Mode :	Mode 4	Temperature :	22~23°C
Test Engineer :	Steven Hao	Relative Humidity :	41~42%
Test Distance :	3m	Polarization :	Horizontal
Function Type :	GSM1900 Idle + USB Cable (Data Link with PC) + Bluetooth Idle + SIM 2		

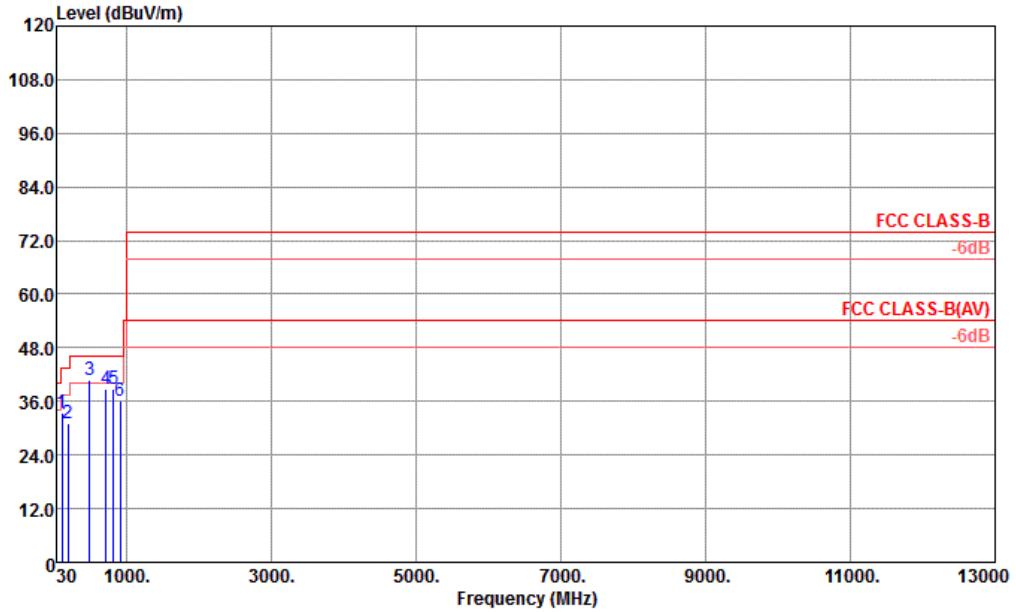

Site : 03CH01-KS
 Condition : FCC CLASS-B 3m LF_ANT-100803 HORIZONTAL
 Project : (FC) 311501
 Mode : Mode 4

	Freq	Level	Over Limit	Limit Line	ReadAntenna Level	Antenna Factor	Cable Loss	Preamp Factor	A/Pos	T/Pos	Remark
	MHz	dBuV/m	dB	dBuV/m	dBuV	dB/m	dB	dB	cm	deg	
1	103.72	33.43	-10.07	43.50	55.45	11.01	0.58	33.61	---	---	Peak
2	191.99	31.04	-12.46	43.50	55.20	8.59	0.80	33.55	---	---	Peak
3 !	485.90	40.78	-5.22	46.00	55.67	16.97	1.28	33.14	154	209	Peak
4	718.70	38.65	-7.35	46.00	50.46	19.50	1.52	32.83	---	---	Peak
5	814.73	38.91	-7.09	46.00	49.92	20.00	1.63	32.64	---	---	Peak
6	909.79	36.05	-9.95	46.00	46.23	20.48	1.76	32.42	---	---	Peak



Test Mode :	Mode 4	Temperature :	22~23°C
Test Engineer :	Steven Hao	Relative Humidity :	41~42%
Test Distance :	3m	Polarization :	Vertical
Function Type :	GSM1900 Idle + USB Cable (Data Link with PC) + Bluetooth Idle + SIM 2		

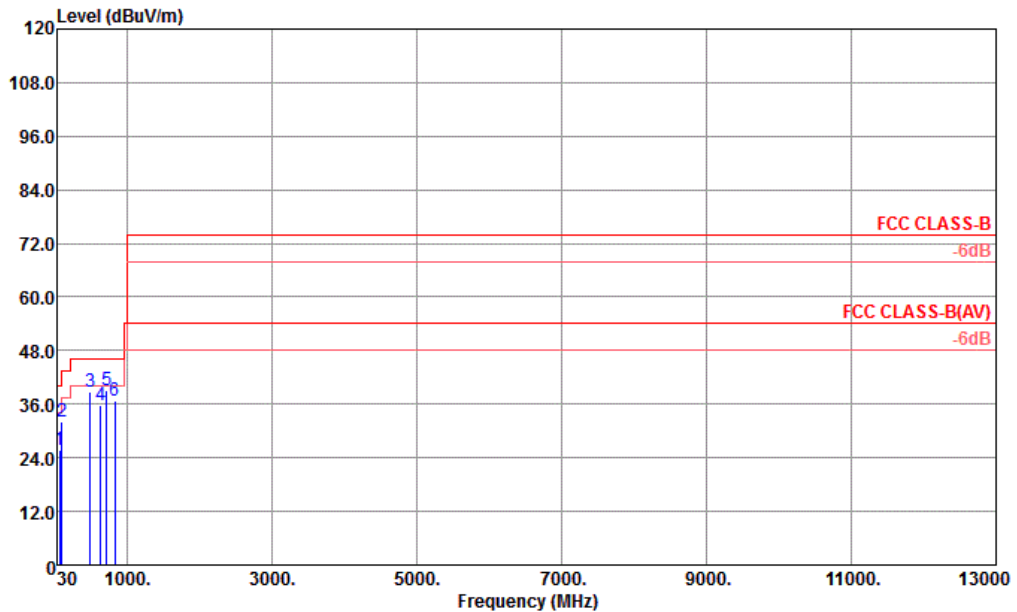

Site : 03CH01-KS
 Condition : FCC CLASS-B 3m LF_ANT-100803 VERTICAL
 Project : (FC) 311501
 Mode : Mode 4

	Freq	Level	Over Limit	Limit Line	ReadAntenna Level	Antenna Factor	Cable Loss	Preamp Factor	A/Pos	T/Pos	Remark
	MHz	dBuV/m	dB	dBuV/m	dBuV	dB/m	dB	dB	cm	deg	
1	66.86	25.63	-14.37	40.00	53.47	5.24	0.50	33.58	---	---	Peak
2	99.84	32.12	-11.38	43.50	54.67	10.49	0.57	33.61	---	---	Peak
3	486.87	38.78	-7.22	46.00	53.64	16.99	1.29	33.14	---	---	Peak
4	633.34	35.72	-10.28	46.00	48.43	18.80	1.43	32.94	---	---	Peak
5	718.70	39.01	-6.99	46.00	50.82	19.50	1.52	32.83	200	0	Peak
6	829.28	36.80	-9.20	46.00	47.62	20.24	1.63	32.69	---	---	Peak

4. List of Measuring Equipment

Instrument	Manufacturer	Model No.	Serial No.	Characteristics	Calibration Date	Test Date	Due Date	Remark
EMI Receiver	R&S	ESC17	100768	9kHz~7GHz	Jun. 01, 2012	Mar. 04, 2013	May 31, 2013	Conduction (CO01-KS)
LISN	MessTec	AN3016	60103	9kHz~30MHz	Dec. 29, 2012	Mar. 04, 2013	Dec. 28, 2013	Conduction (CO01-KS)
LISN	MessTec	AN3016	60105	9kHz~30MHz	Dec. 29, 2012	Mar. 04, 2013	Dec. 28, 2013	Conduction (CO01-KS)
AC Power Source	Chroma	61602	ABP0000008 11	N/A	Nov. 15, 2012	Mar. 04, 2013	Nov. 14, 2013	Conduction (CO01-KS)
System Simulator	R&S	CMU200	837587/066	2G Full-Band	Dec. 29, 2012	Mar. 04, 2013	Dec. 28, 2013	Conduction (CO01-KS)
Signal Generator	R&S	SMR40	100455	10MHz~40GHz	Dec. 29, 2012	Mar. 04, 2013	Dec. 28, 2013	Conduction (CO01-KS)
EMI Test Receiver	R&S	ESC1	100534	9kHz~3GHz	Nov. 08, 2012	Jan. 31, 2013	Nov. 07, 2013	Radiation (03CH01-KS)
Spectrum Analyzer	R&S	FSP30	100400	9kHz~30GHz	Jun. 01, 2012	Jan. 31, 2013	May 31, 2013	Radiation (03CH01-KS)
Bilog Antenna	SCHAFFNER	CBL6112D	23182	25MHz~2GHz	Dec. 07, 2012	Jan. 31, 2013	Dec. 06, 2013	Radiation (03CH01-KS)
Double Ridge Horn Antenna	EMCO	3117	00075959	1GHz~18GHz	Jan. 07, 2012	Jan. 31, 2013	Jan. 06, 2013	Radiation (03CH01-KS)
Amplifier	com-power	PA-103A	161069	1MHz~1GHz	Jun. 01, 2012	Jan. 31, 2013	May 31, 2013	Radiation (03CH01-KS)
Amplifier	Agilent	8449B	3008A02370	1GHz~26.5GHz	Dec. 29, 2012	Jan. 31, 2013	Dec. 28, 2013	Radiation (03CH01-KS)
Signal Generator	R&S	SMR40	100455	10MHz~40GHz	Dec. 29, 2012	Jan. 31, 2013	Dec. 28, 2013	Radiation (03CH01-KS)
System Simulator	R&S	CMU200	837587/066	2G Full-Band	Dec. 29, 2012	Jan. 31, 2013	Dec. 28, 2013	Radiation (03CH01-KS)

5. Uncertainty of Evaluation

Uncertainty of Conducted Emission Measurement (150 KHz ~ 30 MHz)

Measuring Uncertainty for a Level of Confidence of 95% ($U = 2Uc(y)$)	2.26
---	------

Uncertainty of Radiated Emission Measurement (30 MHz ~ 1000 MHz)

Measuring Uncertainty for a Level of Confidence of 95% ($U = 2Uc(y)$)	2.54
---	------

Uncertainty of Radiated Emission Measurement (1 GHz ~ 40 GHz)

Measuring Uncertainty for a Level of Confidence of 95% ($U = 2Uc(y)$)	4.72
---	------



Appendix A. Photographs of EUT

Please refer to Sporton report number EP311501 as below.