

FCC TEST REPORT (PART 22)

REPORT NO.: RF120831N010-2

MODEL NO.: GSM mobile

FCC ID: YHLBLUNEOXT

RECEIVED: Sep. 3, 2012

TESTED: Sep. 3 ~ Sep. 10, 2012

ISSUED: Sep. 10, 2012

APPLICANT: CT Asia

ADDRESS: Unit 01, 15/F, Seaview Centre, 139-141 Hoi bun road, Kwun Tong, Kowloon, Hongkong

ISSUED BY: Bureau Veritas Shenzhen Co., Ltd.
Dongguan Branch

LAB ADDRESS: No. 34, Chenwulu Section, Guantai Road, Houjie Town, Dongguan City, Guangdong 523942, China

TEST LOCATION: No. 34, Chenwulu Section, Guantai Road, Houjie Town, Dongguan City, Guangdong 523942, China

This report should not be used by the client to claim product certification, approval, or endorsement by A2LA or any government agencies.

This report is for your exclusive use. Any copying or replication of this report to or for any other person or entity, or use of our name or trademark, is permitted only with our prior written permission. This report sets forth our findings solely with respect to the test samples identified herein. The results set forth in this report are not indicative or representative of the quality or characteristics of the lot from which a test sample was taken or any similar or identical product unless specifically and expressly noted. Our report includes all of the tests requested by you and the results thereof based upon the information that you provided to us. You have 60 days from date of issuance of this report to notify us of any material error or omission caused by our negligence, provided, however, that such notice shall be in writing and shall specifically address the issue you wish to raise. A failure to raise such issue within the prescribed time shall constitute your unqualified acceptance of the completeness of this report, the tests conducted and the correctness of the report contents. Unless specific mention, the uncertainty of measurement has been explicitly taken into account to declare the compliance or non-compliance to the specification.



TABLE OF CONTENTS

RELEASE CONTROL RECORD	3
1 CERTIFICATION	4
2 SUMMARY OF TEST RESULTS	5
2.1 MEASUREMENT UNCERTAINTY	5
2.2 TEST SITE AND INSTRUMENTS	6
3 GENERAL INFORMATION	7
3.1 GENERAL DESCRIPTION OF EUT	7
3.2 CONFIGURATION OF SYSTEM UNDER TEST	8
3.3 DESCRIPTION OF SUPPORT UNITS	8
3.4 TEST ITEM AND TEST CONFIGURATION	9
3.5 EUT OPERATING CONDITIONS	9
3.6 GENERAL DESCRIPTION OF APPLIED STANDARDS	10
4 TEST TYPES AND RESULTS	11
4.1 OUTPUT POWER MEASUREMENT	11
4.1.1 LIMITS OF OUTPUT POWER MEASUREMENT	11
4.1.2 TEST PROCEDURES	11
4.1.3 TEST SETUP	12
4.1.4 TEST RESULTS	13
4.2 FREQUENCY STABILITY MEASUREMENT	14
4.2.1 LIMITS OF FREQUENCY STABILITY MEASUREMENT	14
4.2.2 TEST PROCEDURE	14
4.2.3 TEST SETUP	14
4.2.4 TEST RESULTS	14
4.3 OCCUPIED BANDWIDTH MEASUREMENT	15
4.3.1 TEST PROCEDURES	16
4.3.2 TEST SETUP	16
4.3.3 TEST RESULTS	17
4.4 BAND EDGE MEASUREMENT	18
4.4.1 LIMITS OF BAND EDGE MEASUREMENT	18
4.4.2 TEST SETUP	18
4.4.3 TEST PROCEDURES	18
4.4.4 TEST RESULTS	19
4.5 CONDUCTED SPURIOUS EMISSIONS	20
4.5.1 LIMITS OF CONDUCTED SPURIOUS EMISSIONS MEASUREMENT	20
4.5.2 TEST PROCEDURE	20
4.5.3 TEST SETUP	20
4.5.4 TEST RESULTS	21
4.6 RADIATED EMISSION MEASUREMENT	22
4.6.1 LIMITS OF RADIATED EMISSION MEASUREMENT	22
4.6.2 TEST PROCEDURES	22
4.6.3 DEVIATION FROM TEST STANDARD	22
4.6.4 TEST SETUP	23
4.6.5 TEST RESULTS	24
5 PHOTOGRAPHS OF THE TEST CONFIGURATION	26
6 INFORMATION ON THE TESTING LABORATORIES	27
7 APPENDIX A – MODIFICATIONS RECORDERS FOR ENGINEERING CHANGES TO THE EUT BY THE LAB	28



BUREAU
VERITAS

Test Report No.: RF120831N010-2

RELEASE CONTROL RECORD

ISSUE NO.	REASON FOR CHANGE	DATE ISSUED
Original release	N/A	Sep.10, 2012



1 CERTIFICATION

PRODUCT: GSM mobile

MODEL: NEO XT

BRAND: BLU

APPLICANT: CT Asia

TESTED: Sep. 3 ~ Sep. 10, 2012

TEST SAMPLE: Production Unit

STANDARDS: FCC PART 22, Subpart H

The above equipment (model: NEO XT) has been tested by **Bureau Veritas Shenzhen Co., Ltd. Dongguan Branch**, and found compliance with the requirement of the above standards. The test record, data evaluation & Equipment Under Test (EUT) configurations represented herein are true and accurate accounts of the measurements of the sample's EMC characteristics under the conditions specified in this report.

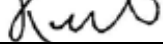
PREPARED BY :  , **DATE** : Sep. 10, 2012
Kent Liu / Project Engineer

APPROVED BY :  , **DATE** : Sep. 10, 2012
Sam Tung / Technical Manager



2 SUMMARY OF TEST RESULTS

The EUT has been tested according to the following specifications:

APPLIED STANDARD: FCC Part 22 & Part 2			
STANDARD SECTION	TEST TYPE	RESULT	REMARK
2.1046 22.913 (a)	Effective Radiated Power	PASS	Meet the requirement of limit.
2.1055 22.355	Frequency Stability	PASS	Meet the requirement of limit.
2.1049	Occupied Bandwidth	PASS	Meet the requirement of limit.
22.917	Band Edge Measurements	PASS	Meet the requirement of limit.
2.1051 22.917	Conducted Spurious Emissions	PASS	Meet the requirement of limit.
2.1053 22.917	Radiated Spurious Emissions	PASS	Meet the requirement of limit. Minimum passing margin is 27.56dB at 1672MHz.

2.1 MEASUREMENT UNCERTAINTY

Where relevant, the following measurement uncertainty levels have been estimated for tests performed on the EUT as specified in CISPR 16-4-2:

MEASUREMENT	FREQUENCY	UNCERTAINTY
Conducted emissions	9kHz~30MHz	2.94dB
Radiated emissions	30MHz ~ 1000MHz	3.6419dB
	1GHz ~ 18GHz	2.2dB
	18GHz ~ 40GHz	1.94dB

This uncertainty represents an expanded uncertainty expressed at approximately the 95% confidence level using a coverage factor of k=2.



2.2 TEST SITE AND INSTRUMENTS

DESCRIPTION & MANUFACTURER	MODEL NO.	SERIAL NO.	DATE OF CALIBRATION	DUE DATE OF CALIBRATION
Spectrum Analyzer Agilent	E4446A	MY46180622	May 02, 12	May 01, 13
Test Receiver ROHDE & SCHWARZ	ESVD	841431/004	May 15,12	May 14,13
Bilog Antenna TESEQ	CBL 6111D	27089	July 16,12	July 15,13
Horn Antenna EMCO	3117	00062558	Oct.19,11	Oct.19,12
10m Semi-anechoic Chamber ETS-LINDGREN	21.4m*12.1m*8.8m	NSEMC006	Mar. 24,12	Mar. 23,13
RF Cable IMRO	IMRO-400	10m Cable 1#10m	May 16,12	May 15,13
RF Cable IMRO	IMRO-400	10m Cable 2#3m	May 16,12	May 15,13
Signal Amplifier EMCI	EMC330	980095	Nov 07,11	Nov 07,12
Signal Amplifier EMCI	EMC 012645	980077	Nov 07,11	Nov 07,12
Signal Amplifier SONOMA	310N	186955	Mar. 14,12	Mar. 13,13
Signal Amplifier HP	8449B	3008A00409	May 31,12	May 30,13
RF Cable DRAKA	M06/25-RG102	10m Cable 2#	May 16,12	May 15,13
Spectrum Analyzer Agilent	E7405A	MY45118807	May 15,12	May 14,13
Digital Multimeter FLUKE	15B	A1220010DG	Jan 14,12	Jan 13,13
Power Meter Anritsu	ML2495A	1139001	Nov.07,11	Nov.07,12
Signal Analyzer Rohde & Schwarz	FSV7	102331	Nov. 25, 11	Nov. 25, 12
Universal Radio Communication Tester Rohde & Schwarz	CMU 200	123259	Apr 16,12	Apr 15,13
Test software ADT	ADT_Radiated_V7. 6.15	N/A	N/A	N/A

- NOTE:**
1. The calibration interval of the above test instruments is 12 months and the calibrations are traceable to CEPREI/CHINA and NIM/CHINA.
 2. The test was performed in Dongguan Chamber 10m.
 3. The horn antenna are used only for the measurement of emission frequency above 1GHz if tested.



3 GENERAL INFORMATION

3.1 GENERAL DESCRIPTION OF EUT

EUT	GSM mobile
MODEL NO.	NEO XT
IMEI Code	355861041315769
HW Version	0.3
SW Version	BLU-S290T-V33-GENERIC
POWER SUPPLY	5.0Vdc (adapter or host equipment) 3.7Vdc (battery)
MODULATION TYPE	GSM: GMSK
FREQUENCY RANGE	GSM: 824.2MHz ~ 848.8MHz
MAX. ERP POWER	GSM: 0.51Watts
POWER CLASS	12
ANTENNA TYPE	Fixed Internal antenna with -1 dBi gain
I/O PORTS	Refer to users' manual
DATA CABLE	USB Port
ACCESSORY DEVICES	USB Cable: Shielded, Detachable, with 1 cores, 0.8m

NOTE:

- There are WLAN, Bluetooth, GSM technology used for the EUT. and the functions of EUT listed as below table:

Function	Report No.
WLAN	RF120831N010
Bluetooth	RF120831N010-1
2G & 3G (Part 22)	RF120831N010-2
2G & 3G (Part 24)	RF120831N010-3

- The EUT was powered by the following adapters:

ADAPTER	
BRAND:	BLU
MODEL:	US300507
INPUT:	100 - 240 VAC, 150 MA
OUTPUT:	5 VDC, 500 MA
DC LINE:	0.8 METER, SHIELDED CABLE, WITH 1 CORE

- The above EUT information was declared by manufacturer and for more detailed features description, please refer to the manufacturer's specifications or User's Manual.



3.2 CONFIGURATION OF SYSTEM UNDER TEST

FOR RADIATION EMISSION TEST

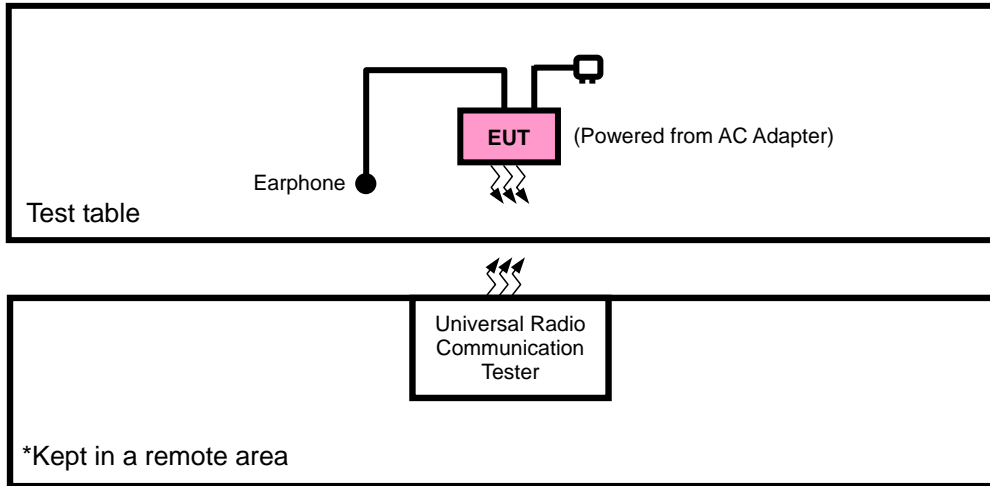

3.3 DESCRIPTION OF SUPPORT UNITS

The EUT has been tested as an independent unit together with other necessary accessories or support units. The following support units or accessories were used to form a representative test configuration during the tests.

NO.	PRODUCT	BRAND	MODEL NO.	SERIAL NO.	FCC ID
1	N/A				

NO.	SIGNAL CABLE DESCRIPTION OF THE ABOVE SUPPORT UNITS
1	N/A

NOTE: All power cords of the above support units are non shielded (1.8m).



3.4 TEST ITEM AND TEST CONFIGURATION

Pre-Scan has been conducted to determine the worst-case mode from all possible combinations between available modulations, data rates, XYZ axis and antenna ports. The worst case was found when positioned on Y-Z plane for ERP and radiated emission. Following channel(s) was (were) selected for the final test as listed below:

EUT CONFIGURE MODE	DESCRIPTION
A	EUT + Adapter + Earphone with GSM link
B	EUT + Battery + Earphone with GSM link
C	EUT + USB Charger + Earphone with GSM

GSM MODE

EUT CONFIGURE MODE	TEST ITEM	AVAILABLE CHANNEL	TESTED CHANNEL	MODE
A	ERP	128 to 251	128, 190, 251	GSM
A	FREQUENCY STABILITY	128 to 251	190	GSM
A	OCCUPIED BANDWIDTH	128 to 251	128, 190, 251	GSM
A	BAND EDGE	128 to 251	128, 251	GSM
A	CONDCUDED EMISSION	128 to 251	128, 190, 251	GSM
A	RADIATED EMISSION	128 to 251	190	GSM

TEST CONDITION:

TEST ITEM	ENVIRONMENTAL CONDITIONS	INPUT POWER	TESTED BY
ERP	26deg. C, 65%RH	3.8Vdc	Venless Long
FREQUENCY STABILITY	26deg. C, 65%RH	3.8Vdc	Venless Long
OCCUPIED BANDWIDTH	26deg. C, 65%RH	3.8Vdc	Venless Long
BAND EDGE	26deg. C, 65%RH	3.8Vdc	Venless Long
CONDCUDED EMISSION	26deg. C, 65%RH	3.8Vdc	Venless Long
RADIATED EMISSION	26deg. C, 65%RH	3.8Vdc	Venless Long

3.5 EUT OPERATING CONDITIONS

The EUT makes a call to the communication simulator. The communication simulator station system controlled a EUT to export maximum output power under transmission mode and specific channel frequency



3.6 GENERAL DESCRIPTION OF APPLIED STANDARDS

The EUT is a RF product. According to the specifications of the manufacturer, it must comply with the requirements of the following standards:

FCC 47 CFR Part 2

FCC 47 CFR Part 22

ANSI/TIA/EIA-603-C 2004

NOTE: All test items have been performed and recorded as per the above standards.

4 TEST TYPES AND RESULTS

4.1 OUTPUT POWER MEASUREMENT

4.1.1 LIMITS OF OUTPUT POWER MEASUREMENT

Mobile / Portable station are limited to 7 watts e.r.p.

4.1.2 TEST PROCEDURES

EIRP / ERP MEASUREMENT:

- a. All measurements were done at low, middle and high operational frequency range. RBW and VBW is 1MHz for GSM, GPRS & EDGE and 5MHz for WCDMA mode.
- b. Substitution method is used for E.I.R.P measurement. In the semi-anechoic chamber, EUT placed on the 0.8m height of Turn Table, rotated the table around 360 degrees to search the maximum radiation power and receiver antenna shall be rotated vertical and horizontal polarization and moved height from 1m to 4m to find the maximum polar radiated power. The “Read Value” is the spectrum reading the maximum power value.
- c. The substitution horn antenna is substituted for EUT at the same position and signals generator export the CW signal to the substitution antenna via a tx cable. Rotated the Turn Table and moved receiving antenna to find the maximum radiation power. Adjust output power level of S.G to get a Value of spectrum reading equal to “Read Value “ of step b. Record the power level of S.G
- d. $EIRP = \text{Output power level of S.G} - \text{TX cable loss} + \text{Antenna gain of substitution horn.}$ E.R.P power can be calculated form E.I.R.P power by subtracting the gain of dipole, $E.R.P \text{ power} = E.I.P.R \text{ power} - 2.15\text{dBi.}$

CONDUCTED POWER MEASUREMENT:

The EUT was set up for the maximum power with GSM, GPRS, EDGE & WCDMA link data modulation and link up with simulator. Set the EUT to transmit under low, middle and high channel and record the power level shown on simulator.



4.1.3 TEST SETUP

EIRP / ERP MEASUREMENT:

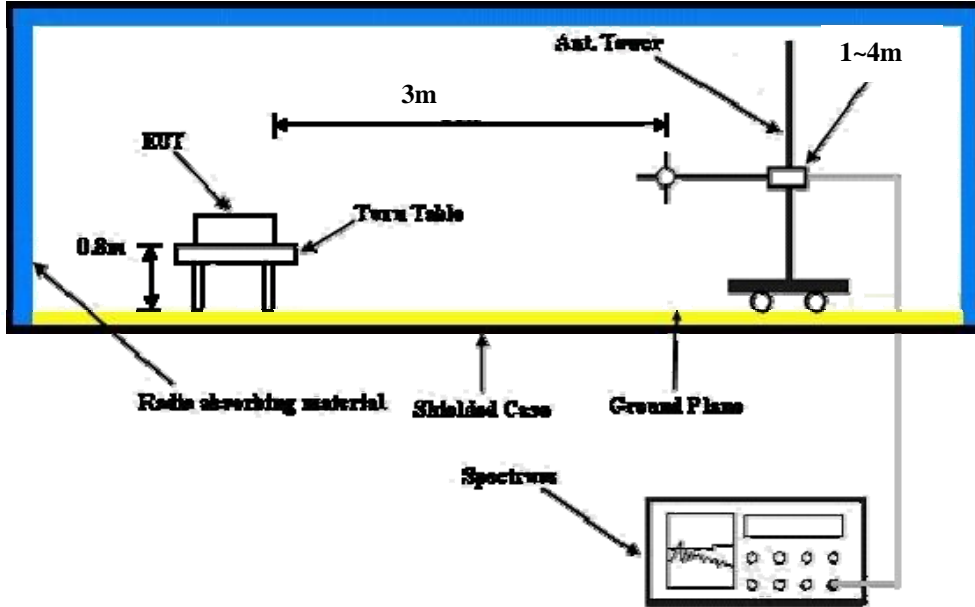

For the actual test configuration, please refer to the attached file (Test Setup Photo).

CONDUCTED POWER MEASUREMENT:

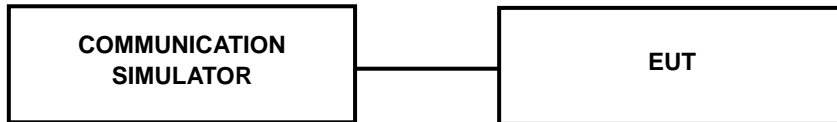

For the actual test configuration, please refer to the attached file (Test Setup Photo).



4.1.4 TEST RESULTS

CONDUCTED OUTPUT POWER (dBm)

Band	GSM850		
Channel	128	190	251
Frequency (MHz)	824.2	836.6	848.8
GSM (1 Uplink)	32.89	32.90	32.91
GPRS 8 (1 Uplink)	32.85	32.89	32.85
GPRS 10 (2 Uplink)	32.41	32.29	32.14
GPRS 11 (3 Uplink)	30.90	30.74	30.56
GPRS 12 (4 Uplink)	30.03	29.88	29.71

ERP POWER (dBm)

GSM 850_Class8 (Horizontal)					
CHANNEL NO.	FREQUENCY (MHz)	SPA Reading (dBm)	CORRECTION FACTOR (dB)	OUTPUT POWER	
				dBm	Watt
128	824.2	-3.67	32.91	27.09	0.51
190	836.6	-7.19	33.7	24.36	0.27
251	848.8	-8.89	34.14	23.10	0.20
GSM 850_Class8 (Vertical)					
CHANNEL NO.	FREQUENCY (MHz)	SPA Reading (dBm)	CORRECTION FACTOR (dB)	OUTPUT POWER	
				dBm	Watt
128	824.2	-16.64	35.18	16.39	0.04
190	836.6	-14.38	35.27	18.74	0.07
251	848.8	-21.72	35.27	11.40	0.01

- REMARKS:** 1. ERP Output Power (dBm) = SPA Reading (dBm) + Correction Factor (dB) -2.15.
2. Correction factor (dB) = Free Space Loss + Antenna Factor + Cable Loss.

4.2 FREQUENCY STABILITY MEASUREMENT

4.2.1 LIMITS OF FREQUENCY STABILITY MEASUREMENT

1.5 ppm is for base and fixed station. 2.5 ppm is for mobile station.

4.2.2 TEST PROCEDURE

- a. Device is placed at the oven room. The oven room could control the temperatures and humidity. Power warm up is at least 15 min and power applied should perform before recording frequency error.
- b. EUT is connected the external power supply to control the DC input power. The test voltage range is from minimum to maximum working voltage. Each step shall be record the frequency error rate.
- c. The temperature range step is 10 degrees in this test items. All temperature levels shall be hold the $\pm 0.5^{\circ}\text{C}$ during the measurement testing. The each temperature step shall be at least 0.5 hours, consider the EUT could be test under the stability condition.

NOTE: The frequency error was recorded frequency error from the communication simulator.

4.2.3 TEST SETUP

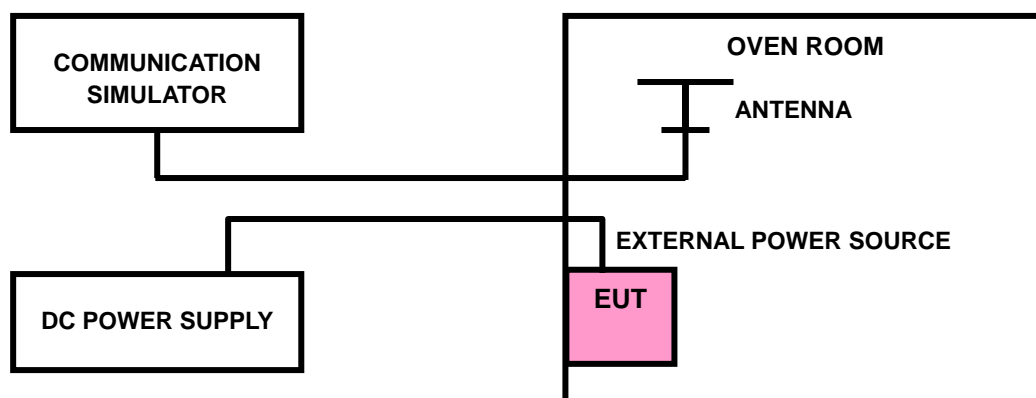

4.2.4 TEST RESULTS

FREQUENCY ERROR VS. VOLTAGE



VOLTAGE (Volts)	FREQUENCY ERROR (ppm)	LIMIT (ppm)
	GSM	
3.7	0.02	2.5
3.5	0.02	2.5
4.2	-0.02	2.5

NOTE: The applicant defined the normal working voltage of the battery is from 3.5Vdc to 4.2Vdc.

FREQUENCY ERROR vs. TEMPERATURE.

TEMP. (°C)	FREQUENCY ERROR (ppm)	LIMIT (ppm)
	GSM	
55	-0.04	2.5
50	0.02	2.5
40	0.03	2.5
30	-0.03	2.5
20	-0.03	2.5
10	-0.05	2.5
0	-0.06	2.5
-10	-0.04	2.5

4.3 OCCUPIED BANDWIDTH MEASUREMENT

4.3.1 TEST PROCEDURES

The EUT makes a call to the communication simulator. All measurements were done at low, middle and high operational frequency range. The communication simulator station system controlled a EUT to export maximum output power under transmission mode and specific channel frequency. Use OBW measurement function of Spectrum analyzer to measure 99 % occupied bandwidth.

4.3.2 EST SETUP

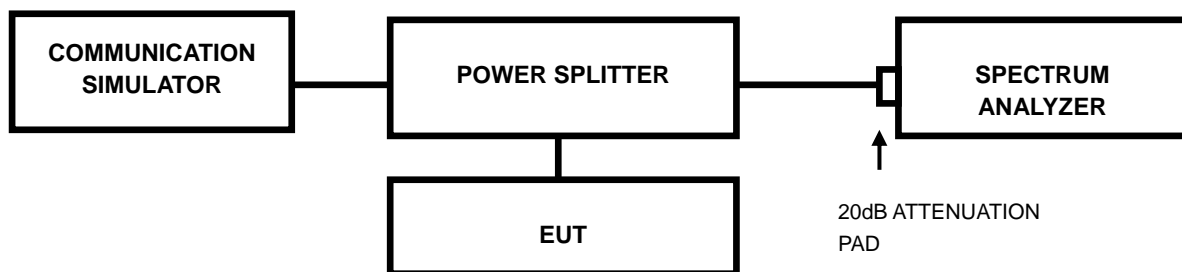



4.3.3 TEST RESULTS

CHANNEL	FREQUENCY (MHz)	99% OCCUPIED BANDWIDTH (kHz)
		GSM
128	824.2	247.46
190	836.6	246.02
251	848.8	247.46

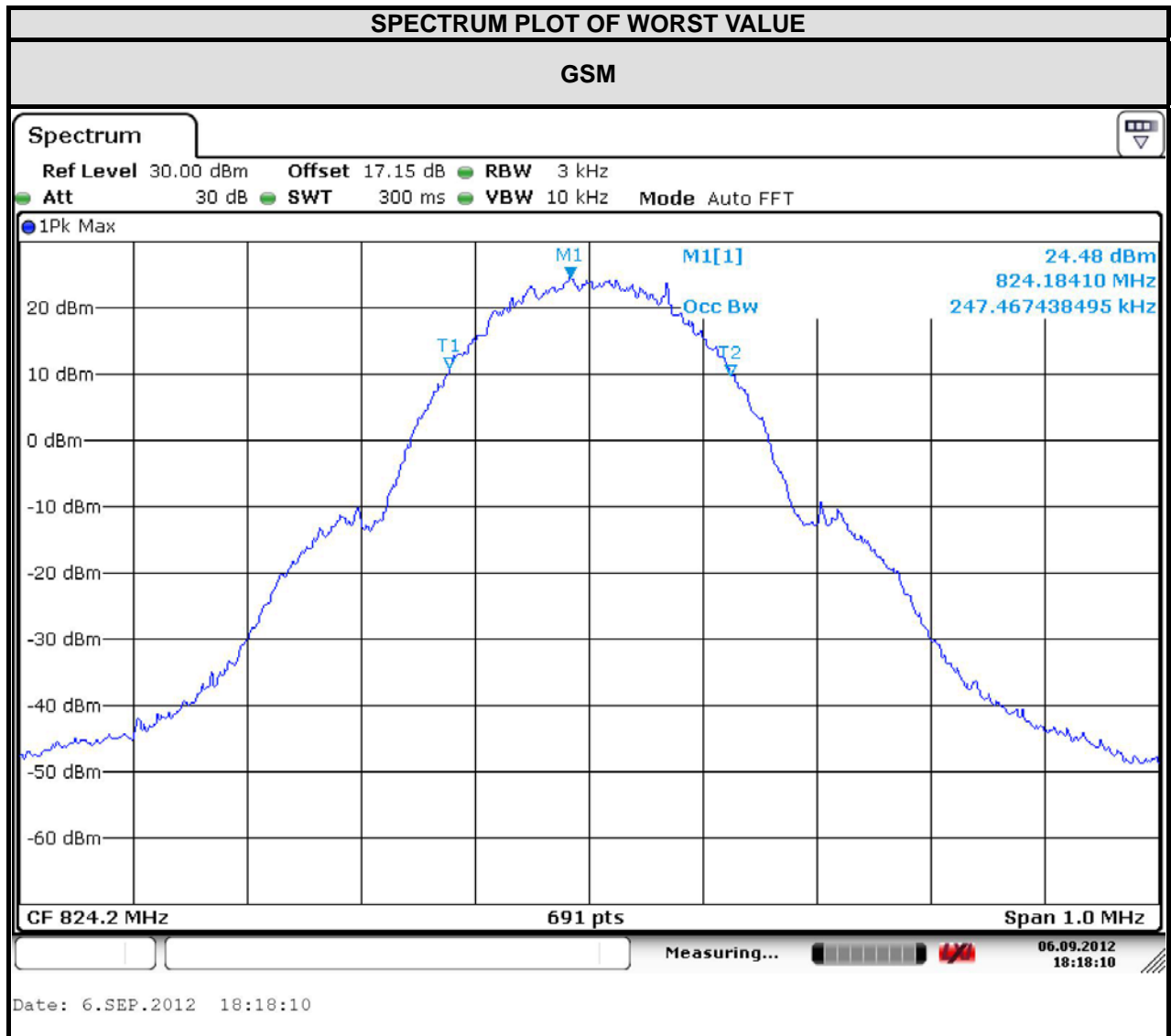

4.4 BAND EDGE MEASUREMENT

4.4.1 LIMITS OF BAND EDGE MEASUREMENT

Power of any emission outside of the authorized operating frequency ranges must be attenuated below the transmitting power (P) by a factor of at least $43 + 10 \log(P)$ dB. In the 1 MHz bands immediately outside and adjacent to the frequency block a resolution bandwidth of at least one percent of the emission bandwidth of the fundamental emission of the transmitter may be employed.

4.4.2 TEST SETUP

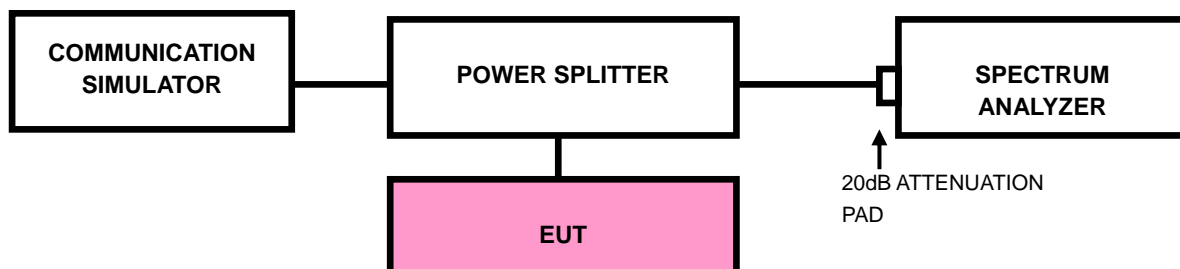

4.4.3 TEST PROCEDURES

- a. All measurements were done at low and high operational frequency range.
- b. The center frequency of spectrum is the band edge frequency and span is 1.5 MHz. RB of the spectrum is 3kHz and VB of the spectrum is 10kHz (GSM/GPRS/EDGE).
- c. The center frequency of spectrum is the band edge frequency and span is 10MHz. RB of the spectrum is 100kHz and VB of the spectrum is 300kHz (WCDMA).
- d. Record the max trace plot into the test report.



4.4.4 TEST RESULTS

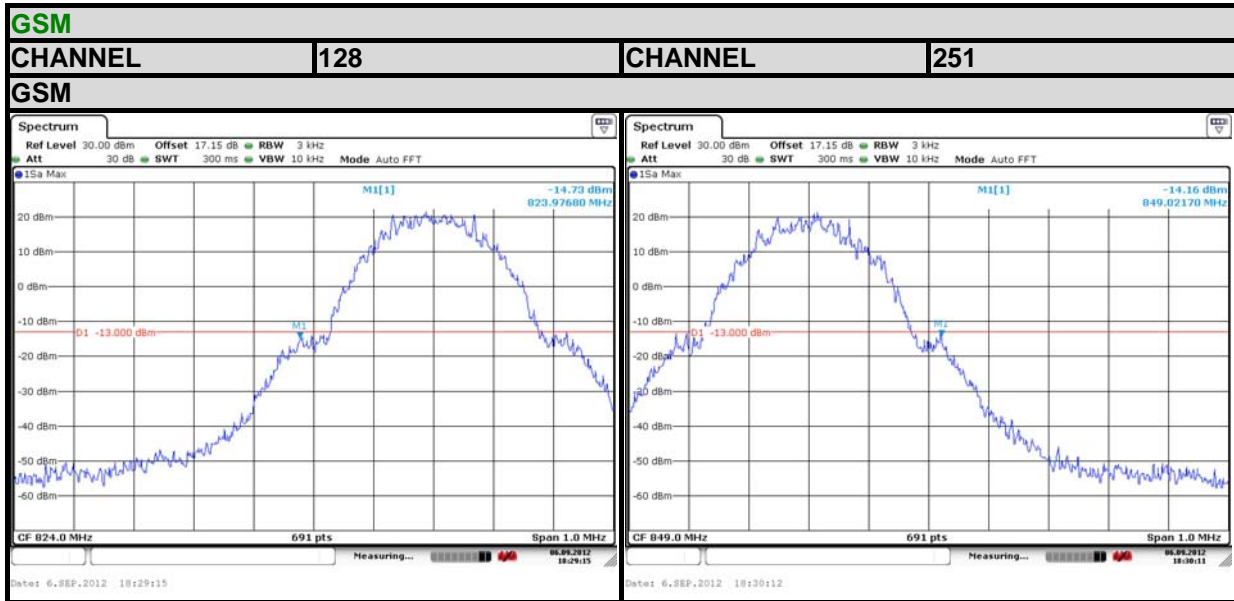

4.5 CONDUCTED SPURIOUS EMISSIONS

4.5.1 LIMITS OF CONDUCTED SPURIOUS EMISSIONS MEASUREMENT

The power of any emission outside of the authorized operating frequency ranges must be attenuated below the transmitting power (P) by a factor of at least $43 + 10 \log(P)$ dB. The emission limit equal to -13dBm .

4.5.2 TEST PROCEDURE

- a. The EUT makes a phone call to the communication simulator. All measurements were done at low, middle and high operational frequency range.
- b. Measuring frequency range is from 9 kHz to 9GHz. 20dB attenuation pad is connected with spectrum. RBW=1MHz and VBW=3MHz is used for conducted emission measurement.

4.5.3 TEST SETUP

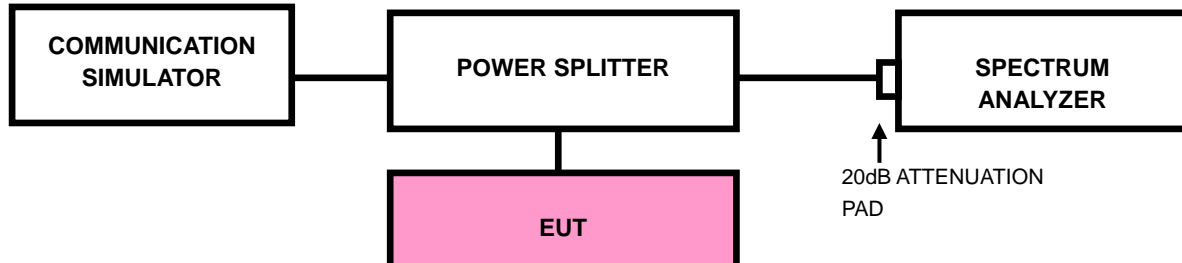



4.5.4 TEST RESULTS

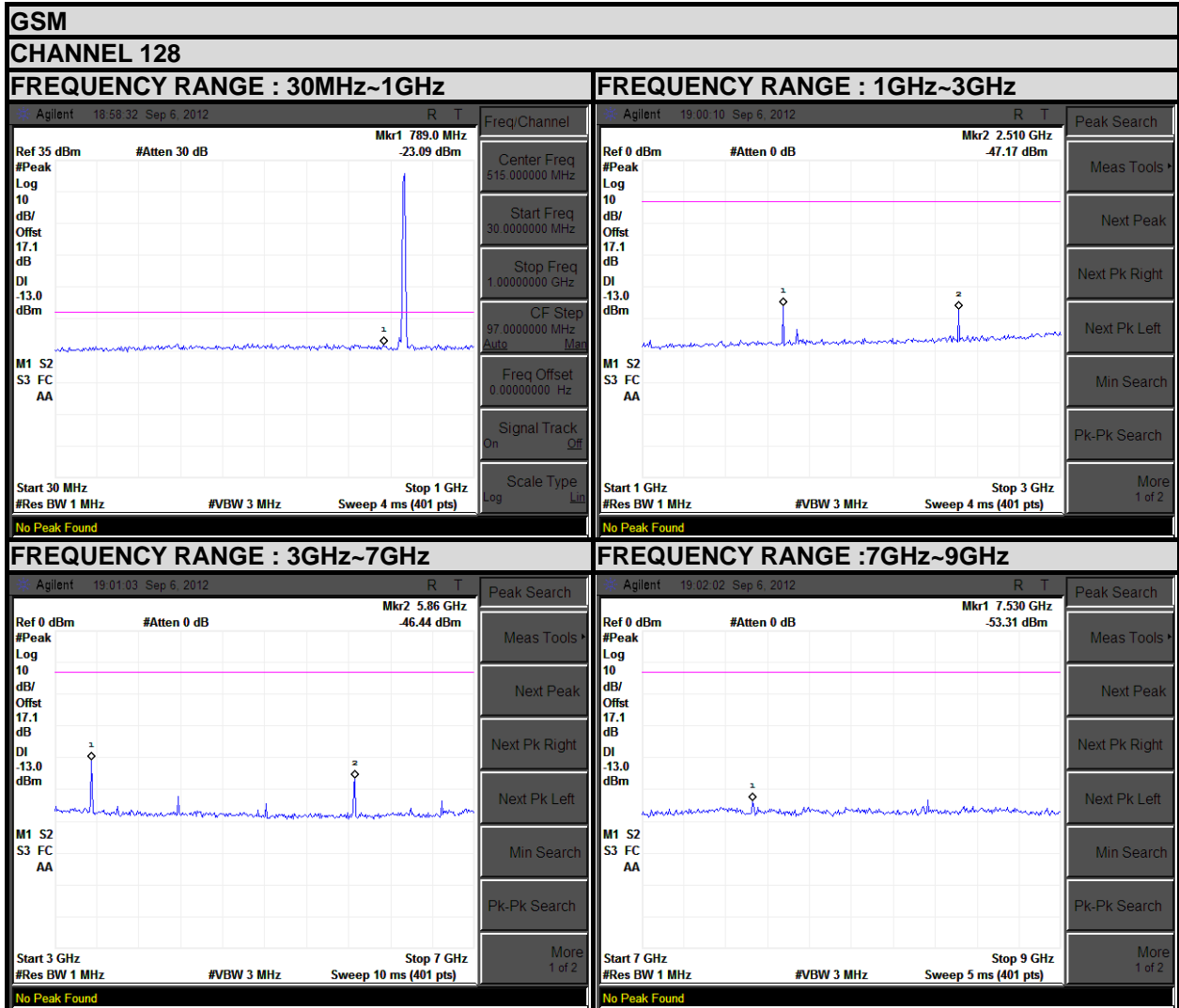

4.6 RADIATED EMISSION MEASUREMENT

4.6.1 LIMITS OF RADIATED EMISSION MEASUREMENT

The power of any emission outside of the authorized operating frequency ranges must be attenuated below the transmitting power (P) by a factor of at least $43 + 10 \log(P)$ dB. The emission limit equal to -13dBm .

4.6.2 TEST PROCEDURES

- a. Substitution method is used for E.I.R.P measurement. In the semi-anechoic chamber, EUT placed on the 0.8m height of Turn Table, rotated the table around 360 degrees to search the maximum radiation power and receiver antenna shall be rotated vertical and horizontal polarization and moved height from 1m to 4m to find the maximum polar radiated power. The “Read Value” is the spectrum reading the maximum power value.
- b. The substitution horn antenna is substituted for EUT at the same position and signals generator export the CW signal to the substitution antenna via a TX cable. Rotated the Turn Table and moved receiving antenna to find the maximum radiation power. Adjust output power level of S.G to get a Value of spectrum reading equal to “Read Value “ of step a. Record the power level of S.G
- c. $\text{EIRP} = \text{Output power level of S.G} - \text{TX cable loss} + \text{Antenna gain of substitution horn}$.
- d. E.R.P power can be calculated form E.I.R.P power by subtracting the gain of dipole, $\text{E.R.P power} = \text{E.I.P.R power} - 2.15\text{dBi}$.

NOTE: The resolution bandwidth and video bandwidth of test receiver/spectrum analyzer is 1MHz/3MHz.

4.6.3 DEVIATION FROM TEST STANDARD

No deviation

4.6.4 TEST SETUP

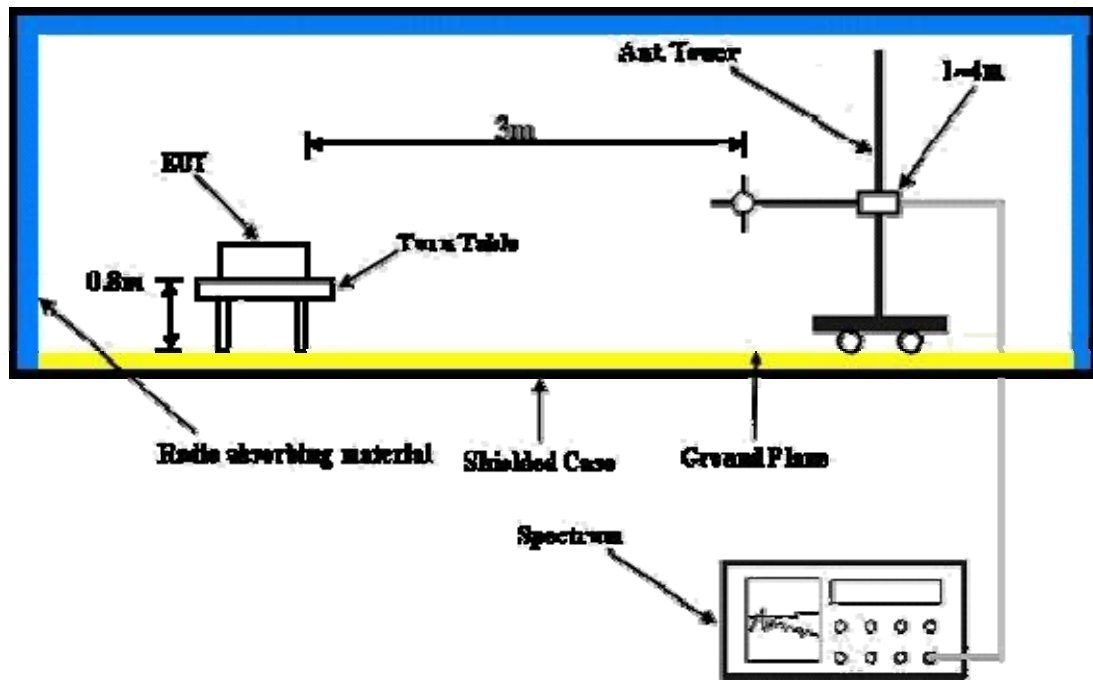

For the actual test configuration, please refer to the attached file (Test Setup Photo).



4.6.5 TEST RESULTS

Below 1GHz

GSM:

FREQUENCY RANGE	Below 1000MHz	INPUT POWER	120Vac, 60 Hz
ENVIRONMENTAL CONDITIONS	26deg. C, 65%RH	TESTED BY	Venless Long

ANTENNA POLARITY & TEST DISTANCE: HORIZONTAL AT 3 M						
No.	Freq. (MHz)	Emission Level (dBuV)	Limit (dBm)	S.G Power Value (dBm)	Correction Factor (dB)	ERP (dBm)
1	162.57	23.87	-13	32.24	-103.67	-71.43
2	233.7	28.97	-13	35.9	-102.23	-66.33
3	246.63	28.27	-13	31.12	-98.15	-67.03
4	330.7	30.83	-13	29.98	-94.45	-64.47
5	342.02	30.51	-13	25.87	-90.66	-64.79
6	419.62	32.81	-13	30.13	-92.62	-62.49
ANTENNA POLARITY & TEST DISTANCE: VERTICAL AT 3 M						
No.	Freq. (MHz)	Emission Level (dBuV)	Limit (dBm)	S.G Power Value (dBm)	Correction Factor (dB)	ERP (dBm)
1	162.57	20.95	-13	29.32	-103.67	-74.35
2	233.7	26.99	-13	33.92	-102.23	-68.31
3	246.63	25.73	-13	28.58	-98.15	-69.57
4	342.02	28.36	-13	27.51	-94.45	-66.94
5	408.3	28.3	-13	23.66	-90.66	-67.00
6	432.55	27.31	-13	24.63	-92.62	-67.99

REMARKS:

1. Output Power (dBm) = S.G Value (dBm) + Correction Factor (dB).
2. Correction Factor (dB) = Substitution Antenna Gain (dB) + Cable Loss (dB)



Above 1GHz

GSM:

FREQUENCY RANGE	Above 1000MHz	INPUT POWER	120Vac, 60 Hz
ENVIRONMENTAL CONDITIONS	26deg. C, 65%RH	TESTED BY	Venless Long

ANTENNA POLARITY & TEST DISTANCE: HORIZONTAL AT 3 M						
No.	Freq. (MHz)	SPA READING (dBm)	Limit (dBm)	S.G Power Value (dBm)	Correction Factor (dB)	ERP (dBm)
1	1672	-31.31	-13.00	-26.05	0.46	-25.59
2	2509	-40.30	-13.00	-31.00	0.17	-30.83
3	3345	-36.10	-13.00	-26.17	1.49	-24.68
4	4182	-52.64	-13.00	-39.87	2.05	-37.82
5	5018	-49.53	-13.00	-32.78	2.41	-30.37
6	5854	-64.54	-13.00	-50.37	2.46	-47.91
7	6691	-60.78	-13.00	-42.83	2.46	-40.37
8	7527	-60.09	-13.00	-43.55	3.32	-40.23
9	8364	-58.87	-13.00	-38.73	3.55	-35.18
ANTENNA POLARITY & TEST DISTANCE: VERTICAL AT 3 M						
No.	Freq. (MHz)	SPA READING (dBm)	Limit (dBm)	S.G Power Value (dBm)	Correction Factor (dB)	ERP (dBm)
1	1672	-24.11	-13.00	-15.52	0.46	-15.06
2	2509	-38.08	-13.00	-27.59	0.17	-27.42
3	3345	-39.70	-13.00	-27.80	1.49	-26.31
4	4182	-53.89	-13.00	-40.01	2.05	-37.96
5	5018	-52.35	-13.00	-36.29	2.41	-33.88
6	5854	-66.81	-13.00	-51.53	2.46	-49.07
7	6691	-65.50	-13.00	-49.35	2.46	-46.89
8	7527	-62.52	-13.00	-45.81	3.32	-42.49
9	8364	-61.14	-13.00	-41.56	3.55	-38.01

REMARKS:

1. ERP(dBm) = S.G Power Value (dBm) + Correction Factor (dB).
2. Correction Factor = gain of substitution antenna + cable loss



BUREAU
VERITAS

Test Report No.: RF120831N010-2

5 PHOTOGRAPHS OF THE TEST CONFIGURATION

Please refer to the attached file (Test Setup Photo).



**BUREAU
VERITAS**

Test Report No.: RF120831N010-2

6 INFORMATION ON THE TESTING LABORATORIES

We, Bureau Veritas Shenzhen Co., Ltd. Dongguan Branch, were founded in 2002 to provide our best service in EMC, Radio, Telecom and Safety consultation. Our laboratories are accredited and approved according to ISO/IEC 17025.

If you have any comments, please feel free to contact us at the following:

Dongguan EMC/RF Lab:

Tel: +86-769-85935656

Fax: +86-769-85931080

Email: customerservice.dg@cn.bureauveritas.com

Web Site: www.adt.com.tw

The address and road map of all our labs can be found in our web site also.



**BUREAU
VERITAS**

Test Report No.: RF120831N010-2

7 APPENDIX A – MODIFICATIONS RECORDERS FOR ENGINEERING CHANGES TO THE EUT BY THE LAB

No any modifications are made to the EUT by the lab during the test.

---END---