

# FCC SAR Test Report

APPLICANT : CT Asia  
EQUIPMENT : Smart phone  
BRAND NAME : BLU  
MODEL NAME : LIFE 8 XL  
FCC ID : YHLBLULIFE8XL  
STANDARD : FCC 47 CFR Part 2 (2.1093)  
ANSI/IEEE C95.1-1992  
IEEE 1528-2003

We, SPORTON INTERNATIONAL (XI'AN) INC., would like to declare that the tested sample has been evaluated in accordance with the procedures and had been in compliance with the applicable technical standards.

The test results in this report apply exclusively to the tested model / sample. Without written approval of SPORTON INTERNATIONAL (XI'AN) INC., the test report shall not be reproduced except in full.

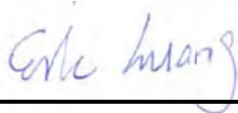

Reviewed by: Eric Huang / Deputy Manager

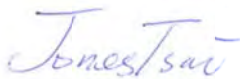

Approved by: Jones Tsai / Manager



**SPORTON INTERNATIONAL (XI'AN) INC.**

**1F, Building A3, No. 39 Chuangye Rd., Xi'an Hi-tech Zone, Shanxi Province, P. R. China**



Table of Contents

1. Statement of Compliance .....4
2. Administration Data .....5
3. Guidance Standard .....5
4. Equipment Under Test (EUT) .....6
4.1 General Information .....6
4.2 Maximum Tune-up Limit.....7
5. RF Exposure Limits .....8
5.1 Uncontrolled Environment.....8
5.2 Controlled Environment.....8
6. Specific Absorption Rate (SAR).....9
6.1 Introduction .....9
6.2 SAR Definition.....9
7. System Description and Setup .....10
8. Measurement Procedures .....11
8.1 Spatial Peak SAR Evaluation.....11
8.2 Power Reference Measurement.....12
8.3 Area Scan .....12
8.4 Zoom Scan.....13
8.5 Volume Scan Procedures.....13
8.6 Power Drift Monitoring.....13
9. Test Equipment List .....14
10. System Verification .....15
10.1 Tissue Verification .....15
10.2 System Performance Check Results.....16
11. RF Exposure Positions .....17
11.1 Ear and handset reference point .....17
11.2 Definition of the cheek position.....18
11.3 Definition of the tilt position.....19
11.4 Body Worn Accessory .....20
11.5 Wireless Router.....20
11.6 Extremity Exposure .....21
12. Conducted RF Output Power (Unit: dBm).....22
13. Bluetooth Exclusions Applied .....28
14. Antenna Location .....29
15. SAR Test Results .....30
15.1 Head SAR .....31
15.2 Hotspot SAR .....32
15.3 Body Worn Accessory SAR.....34
15.4 Extremity SAR.....35
15.5 Repeated SAR Measurement .....36
16. Simultaneous Transmission Analysis.....37
16.1 Head Exposure Conditions .....38
16.2 Hotspot Exposure Conditions.....40
16.3 Body-Worn Accessory Exposure Conditions .....42
17. Uncertainty Assessment .....43
18. References.....45
Appendix A. Plots of System Performance Check
Appendix B. Plots of High SAR Measurement
Appendix C. DASy Calibration Certificate
Appendix D. Test Setup Photos



### Revision History

REPORT NO.	VERSION	DESCRIPTION	ISSUED DATE
FA512804	Rev. 01	Initial issue of report	Mar. 12, 2015

**1. Statement of Compliance**

The maximum results of Specific Absorption Rate (SAR) found during testing for **CT Asia, Smart phone, LIFE 8 XL**, are as follows.

Equipment Class	Frequency Band	Highest SAR Summary			
		Head 1g SAR (W/kg) Gap(0cm)	Body-worn 1g SAR (W/kg) Gap(1cm)	Wireless Router 1g SAR (W/kg) Gap(1cm)	Simultaneous Transmission SAR (W/kg)
PCE	GSM850	0.63	0.99	0.99	1.45
	GSM1900	0.38	1.10	<b>1.31</b>	
	WCDMA Band V	0.36	0.55	0.55	
	WCDMA Band IV	0.27	<b>1.14</b>	1.27	
	WCDMA Band II	0.38	1.10	1.24	
DTS	WLAN 2.4GHz Band	<b>0.78</b>	0.31	0.34	1.45
Date of Testing:		02/05/2015 ~ 02/12/2015			

Frequency Band	Highest SAR Summary
	Extremity 10g SAR (W/kg) (Gap 0cm)
GSM1900	2.98
WCDMA Band IV	2.60
WCDMA Band II	<b>3.48</b>

This device is in compliance with Specific Absorption Rate (SAR) for general population/uncontrolled exposure limits (1.6W/kg as averaged over any 1 gram of tissue; 4.0W/kg as averaged over any 10 gram of tissue for extremity SAR) specified in FCC 47 CFR part 2 (2.1093) and ANSI/IEEE C95.1-1992, and had been tested in accordance with the measurement methods and procedures specified in IEEE 1528-2003.



## 2. Administration Data

Testing Laboratory	
Test Site	SPORTON INTERNATIONAL (XI'AN) INC.
Test Site Location	1F, Building A3, No. 39 Chuangye Rd., Xi'an Hi-tech Zone, Shanxi Province, P. R. China TEL: +86-029-8860-8767 FAX: +86-029-8860-8791

Applicant	
Company Name	CT Asia
Address	Unit 01, 15/F, Seaview Centre, 139-141 Hoi bun road, Kwun Tong, Kowloon, Hongkong

Manufacturer	
Company Name	BEIJING BENYWAVE TECHNOLOGY CO., LTD.
Address	NO.55 Jiachang 2 road, OPTO-Mechatronics Industrial Park, Tongzhou district, Beijing 101111

## 3. Guidance Standard

The Specific Absorption Rate (SAR) testing specification, method, and procedure for this device is in accordance with the following standards:

- FCC 47 CFR Part 2 (2.1093)
- ANSI/IEEE C95.1-1992
- IEEE 1528-2003
- FCC KDB 865664 D01 SAR Measurement 100 MHz to 6 GHz v01r03
- FCC KDB 865664 D02 SAR Reporting v01r01
- FCC KDB 447498 D01 General RF Exposure Guidance v05r02
- FCC KDB 648474 D04 SAR Evaluation Considerations for Wireless Handsets v01r02
- FCC KDB 248227 D01 SAR meas for 802 11abg v01r02
- FCC KDB 941225 D01 3G SAR Procedures v03
- FCC KDB 941225 D06 Hotspot Mode SAR v02

## 4. Equipment Under Test (EUT)

### 4.1 General Information

Product Feature & Specification	
Equipment Name	Smart phone
Brand Name	BLU
Model Name	LIFE 8 XL
FCC ID	YHLBLULIFE8XL
Wireless Technology and Frequency Range	GSM850: 824.2 MHz ~ 848.8 MHz GSM1900: 1850.2 MHz ~ 1909.8 MHz WCDMA Band V: 826.4 MHz ~ 846.6 MHz WCDMA Band IV: 1712.4 MHz ~ 1752.6 MHz WCDMA Band II: 1852.4 MHz ~ 1907.6 MHz WLAN 2.4GHz Band: 2412 MHz ~ 2462 MHz Bluetooth: 2402 MHz ~ 2480 MHz
Mode	<ul style="list-style-type: none"> <li>• GSM/GPRS/EGPRS</li> <li>• RMC/AMR 12.2Kbps</li> <li>• HSDPA</li> <li>• HSUPA</li> <li>• HSPA+ (Downlink Only)</li> <li>• 802.11b/g/n HT20/HT40</li> <li>• Bluetooth v3.0+EDR, Bluetooth v4.0 LE</li> </ul>
HW Version	TBW9785_P2_001
SW Version	BLU_L290U_V01_GENERIC
GSM / (E)GPRS Transfer mode	Class B – EUT cannot support Packet Switched and Circuit Switched Network simultaneously but can automatically switch between Packet and Circuit Switched Network.
EUT Stage	Pre-Production
<b>Remark:</b> <ol style="list-style-type: none"> <li>1. This device 2.4GHz WLAN supports Hotspot operation.</li> <li>2. This device supported VoIP in GPRS, EGPRS, WCDMA (e.g. 3rd party VoIP).</li> <li>3. This device supports GRPS/EGPRS mode up to multi-slot class12 and does not support DTM operation.</li> <li>4. This device has 2 SIM slots and supports dual SIM dual Standby. The WWAN radio transmission will be enabled by either one SIM at a time (Single active).</li> </ol>	

**4.2 Maximum Tune-up Limit**

Mode	Burst average power(dBm)	
	GSM 850	GSM 1900
GSM (GMSK, 1 Tx slot)	34.00	31.00
GPRS (GMSK, 1 Tx slot)	34.00	31.00
GPRS (GMSK, 2 Tx slots)	33.50	30.50
GPRS (GMSK, 3 Tx slots)	31.50	28.50
GPRS (GMSK, 4 Tx slots)	30.00	27.50
EDGE (8PSK, 1 Tx slot)	28.00	27.00
EDGE (8PSK, 2 Tx slots)	27.00	26.00
EDGE (8PSK, 3 Tx slots)	25.00	24.00
EDGE (8PSK, 4 Tx slots)	23.50	22.50

Mode	Average power(dBm)		
	WCDMA Band V	WCDMA Band II	WCDMA Band IV
AMR 12.2Kbps	24.50	24.00	22.50
RMC 12.2Kbps	24.50	24.00	22.50
HSDPA Subtest-1	23.00	23.00	20.50
HSDPA Subtest-2	23.00	23.00	20.50
HSDPA Subtest-3	22.50	22.50	20.50
HSDPA Subtest-4	22.50	22.50	20.50
HSUPA Subtest-1	21.00	21.00	19.50
HSUPA Subtest-2	21.00	21.00	19.50
HSUPA Subtest-3	22.00	22.00	20.50
HSUPA Subtest-4	20.50	20.50	19.50
HSUPA Subtest-5	23.00	23.00	21.50

Mode		Maximum Average Power (dBm)
2.4GHz	802.11b	13.0
	802.11g	12.0
	802.11n-HT20	12.0
	802.11n-HT40	12.0
Bluetooth v3.0+EDR		4.0
Bluetooth v4.0 LE		-3.5

**5. RF Exposure Limits**

**5.1 Uncontrolled Environment**

Uncontrolled Environments are defined as locations where there is the exposure of individuals who have no knowledge or control of their exposure. The general population/uncontrolled exposure limits are applicable to situations in which the general public may be exposed or in which persons who are exposed as a consequence of their employment may not be made fully aware of the potential for exposure or cannot exercise control over their exposure. Members of the general public would come under this category when exposure is not employment-related; for example, in the case of a wireless transmitter that exposes persons in its vicinity.

**5.2 Controlled Environment**

Controlled Environments are defined as locations where there is exposure that may be incurred by persons who are aware of the potential for exposure, (i.e. as a result of employment or occupation). In general, occupational/controlled exposure limits are applicable to situations in which persons are exposed as a consequence of their employment, who have been made fully aware of the potential for exposure and can exercise control over their exposure. The exposure category is also applicable when the exposure is of a transient nature due to incidental passage through a location where the exposure levels may be higher than the general population/uncontrolled limits, but the exposed person is fully aware of the potential for exposure and can exercise control over his or her exposure by leaving the area or by some other appropriate means.

**Limits for Occupational/Controlled Exposure (W/kg)**

Whole-Body	Partial-Body	Hands, Wrists, Feet and Ankles
0.4	8.0	20.0

**Limits for General Population/Uncontrolled Exposure (W/kg)**

Whole-Body	Partial-Body	Hands, Wrists, Feet and Ankles
0.08	1.6	4.0

1. Whole-Body SAR is averaged over the entire body, partial-body SAR is averaged over any 1gram of tissue defined as a tissue volume in the shape of a cube. SAR for hands, wrists, feet and ankles is averaged over any 10 grams of tissue defined as a tissue volume in the shape of a cube.



## **6. Specific Absorption Rate (SAR)**

### **6.1 Introduction**

SAR is related to the rate at which energy is absorbed per unit mass in an object exposed to a radio field. The SAR distribution in a biological body is complicated and is usually carried out by experimental techniques or numerical modeling. The standard recommends limits for two tiers of groups, occupational/controlled and general population/uncontrolled, based on a person's awareness and ability to exercise control over his or her exposure. In general, occupational/controlled exposure limits are higher than the limits for general population/uncontrolled.

### **6.2 SAR Definition**

The SAR definition is the time derivative (rate) of the incremental energy (dW) absorbed by (dissipated in) an incremental mass (dm) contained in a volume element (dv) of a given density ( $\rho$ ). The equation description is as below:

$$SAR = \frac{d}{dt} \left( \frac{dW}{dm} \right) = \frac{d}{dt} \left( \frac{dW}{\rho dv} \right)$$

SAR is expressed in units of Watts per kilogram (W/kg)

$$SAR = \frac{\sigma |E|^2}{\rho}$$

Where:  $\sigma$  is the conductivity of the tissue,  $\rho$  is the mass density of the tissue and E is the RMS electrical field strength.

## 7. System Description and Setup

The DASY system used for performing compliance tests consists of the following items:

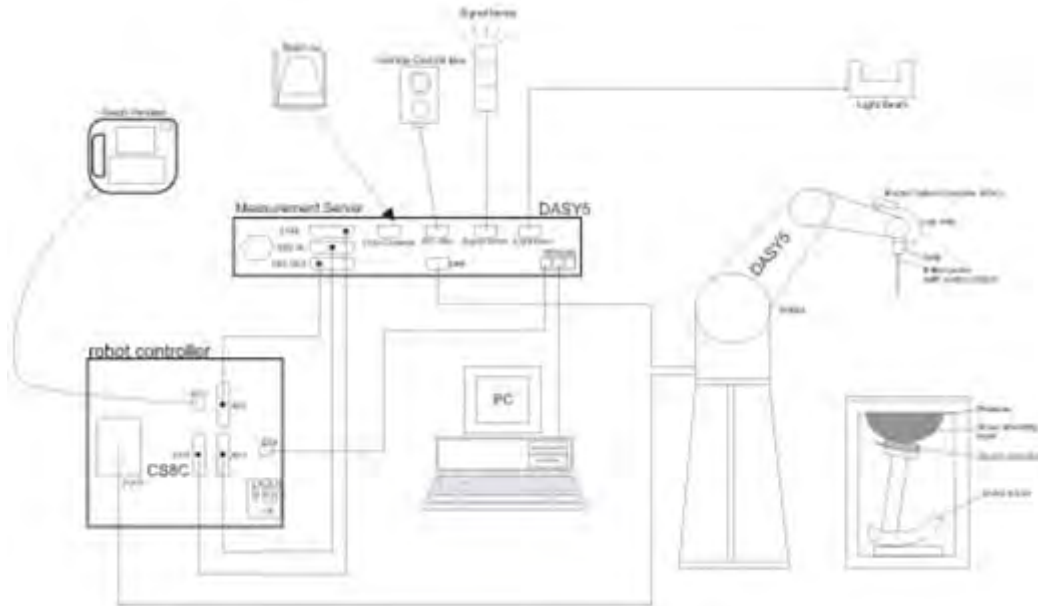

- A standard high precision 6-axis robot with controller, teach pendant and software. An arm extension for accommodating the data acquisition electronics (DAE).
- An isotropic Field probe optimized and calibrated for the targeted measurement.
- A data acquisition electronics (DAE) which performs the signal amplification, signal multiplexing, AD-conversion, offset measurements, mechanical surface detection, collision detection, etc. The unit is battery powered with standard or rechargeable batteries. The signal is optically transmitted to the EOC.
- The Electro-optical converter (EOC) performs the conversion from optical to electrical signals for the digital communication to the DAE. To use optical surface detection, a special version of the EOC is required. The EOC signal is transmitted to the measurement server.
- The function of the measurement server is to perform the time critical tasks such as signal filtering, control of the robot operation and fast movement interrupts.
- The Light Beam used is for probe alignment. This improves the (absolute) accuracy of the probe positioning.
- A computer running WinXP or Win7 and the DASY5 software.
- Remote control and teach pendant as well as additional circuitry for robot safety such as warning lamps, etc.
- The phantom, the device holder and other accessories according to the targeted measurement.

## **8. Measurement Procedures**

The measurement procedures are as follows:

### <Conducted power measurement>

- (a) For WWAN power measurement, use base station simulator to configure EUT WWAN transmission in conducted connection with RF cable, at maximum power in each supported wireless interface and frequency band.
- (b) Read the WWAN RF power level from the base station simulator.
- (c) For WLAN/BT power measurement, use engineering software to configure EUT WLAN/BT continuously transmission, at maximum RF power in each supported wireless interface and frequency band
- (d) Connect EUT RF port through RF cable to the power meter, and measure WLAN/BT output power

### <SAR measurement>

- (a) Use base station simulator to configure EUT WWAN transmission in radiated connection, and engineering software to configure EUT WLAN/BT continuously transmission, at maximum RF power, in the highest power channel.
- (b) Place the EUT in the positions as Appendix D demonstrates.
- (c) Set scan area, grid size and other setting on the DASY software.
- (d) Measure SAR results for the highest power channel on each testing position.
- (e) Find out the largest SAR result on these testing positions of each band
- (f) Measure SAR results for other channels in worst SAR testing position if the reported SAR of highest power channel is larger than 0.8 W/kg

According to the test standard, the recommended procedure for assessing the peak spatial-average SAR value consists of the following steps:

- (a) Power reference measurement
- (b) Area scan
- (c) Zoom scan
- (d) Power drift measurement

### **8.1 Spatial Peak SAR Evaluation**

The procedure for spatial peak SAR evaluation has been implemented according to the test standard. It can be conducted for 1g and 10g, as well as for user-specific masses. The DASY software includes all numerical procedures necessary to evaluate the spatial peak SAR value.

The base for the evaluation is a "cube" measurement. The measured volume must include the 1g and 10g cubes with the highest averaged SAR values. For that purpose, the center of the measured volume is aligned to the interpolated peak SAR value of a previously performed area scan.

The entire evaluation of the spatial peak values is performed within the post-processing engine (SEMCAD). The system always gives the maximum values for the 1g and 10g cubes. The algorithm to find the cube with highest averaged SAR is divided into the following stages:

- (a) Extraction of the measured data (grid and values) from the Zoom Scan
- (b) Calculation of the SAR value at every measurement point based on all stored data (A/D values and measurement parameters)
- (c) Generation of a high-resolution mesh within the measured volume
- (d) Interpolation of all measured values from the measurement grid to the high-resolution grid
- (e) Extrapolation of the entire 3-D field distribution to the phantom surface over the distance from sensor to surface
- (f) Calculation of the averaged SAR within masses of 1g and 10g

**8.2 Power Reference Measurement**

The Power Reference Measurement and Power Drift Measurements are for monitoring the power drift of the device under test in the batch process. The minimum distance of probe sensors to surface determines the closest measurement point to phantom surface. This distance cannot be smaller than the distance of sensor calibration points to probe tip as defined in the probe properties.

**8.3 Area Scan**

The area scan is used as a fast scan in two dimensions to find the area of high field values, before doing a fine measurement around the hot spot. The sophisticated interpolation routines implemented in DASY software can find the maximum found in the scanned area, within a range of the global maximum. The range (in dB) is specified in the standards for compliance testing. For example, a 2 dB range is required in IEEE standard 1528 and IEC 62209 standards, whereby 3 dB is a requirement when compliance is assessed in accordance with the ARIB standard (Japan), if only one zoom scan follows the area scan, then only the absolute maximum will be taken as reference. For cases where multiple maximums are detected, the number of zoom scans has to be increased accordingly.

Area scan parameters extracted from FCC KDB 865664 D01v01r03 SAR measurement 100 MHz to 6 GHz.

	≤ 3 GHz	> 3 GHz
Maximum distance from closest measurement point (geometric center of probe sensors) to phantom surface	5 ± 1 mm	$\frac{1}{2} \cdot \delta \cdot \ln(2) \pm 0.5$ mm
Maximum probe angle from probe axis to phantom surface normal at the measurement location	30° ± 1°	20° ± 1°
Maximum area scan spatial resolution: $\Delta x_{Area}, \Delta y_{Area}$	≤ 2 GHz: ≤ 15 mm 2 – 3 GHz: ≤ 12 mm	3 – 4 GHz: ≤ 12 mm 4 – 6 GHz: ≤ 10 mm
	When the x or y dimension of the test device, in the measurement plane orientation, is smaller than the above, the measurement resolution must be ≤ the corresponding x or y dimension of the test device with at least one measurement point on the test device.	

**8.4 Zoom Scan**

Zoom scans are used assess the peak spatial SAR values within a cubic averaging volume containing 1 gram and 10 gram of simulated tissue. The zoom scan measures points (refer to table below) within a cube shoes base faces are centered on the maxima found in a preceding area scan job within the same procedure. When the measurement is done, the zoom scan evaluates the averaged SAR for 1 gram and 10 gram and displays these values next to the job's label.

Zoom scan parameters extracted from FCC KDB 865664 D01v01r03 SAR measurement 100 MHz to 6 GHz.

		≤ 3 GHz	> 3 GHz	
Maximum zoom scan spatial resolution: $\Delta x_{Zoom}, \Delta y_{Zoom}$		$\leq 2$ GHz: $\leq 8$ mm 2 – 3 GHz: $\leq 5$ mm*	3 – 4 GHz: $\leq 5$ mm* 4 – 6 GHz: $\leq 4$ mm*	
Maximum zoom scan spatial resolution, normal to phantom surface	uniform grid: $\Delta z_{Zoom}(n)$	$\leq 5$ mm	3 – 4 GHz: $\leq 4$ mm 4 – 5 GHz: $\leq 3$ mm 5 – 6 GHz: $\leq 2$ mm	
	graded grid	$\Delta z_{Zoom}(1)$ : between 1 <sup>st</sup> two points closest to phantom surface	$\leq 4$ mm	3 – 4 GHz: $\leq 3$ mm 4 – 5 GHz: $\leq 2.5$ mm 5 – 6 GHz: $\leq 2$ mm
		$\Delta z_{Zoom}(n>1)$ : between subsequent points	$\leq 1.5 \cdot \Delta z_{Zoom}(n-1)$	
Minimum zoom scan volume	x, y, z	$\geq 30$ mm	3 – 4 GHz: $\geq 28$ mm 4 – 5 GHz: $\geq 25$ mm 5 – 6 GHz: $\geq 22$ mm	
Note: $\delta$ is the penetration depth of a plane-wave at normal incidence to the tissue medium; see draft standard IEEE P1528-2011 for details. * When zoom scan is required and the <i>reported</i> SAR from the <i>area scan based 1-g SAR estimation</i> procedures of KDB 447498 is $\leq 1.4$ W/kg, $\leq 8$ mm, $\leq 7$ mm and $\leq 5$ mm zoom scan resolution may be applied, respectively, for 2 GHz to 3 GHz, 3 GHz to 4 GHz and 4 GHz to 6 GHz.				

**8.5 Volume Scan Procedures**

The volume scan is used for assess overlapping SAR distributions for antennas transmitting in different frequency bands. It is equivalent to an oversized zoom scan used in standalone measurements. The measurement volume will be used to enclose all the simultaneous transmitting antennas. For antennas transmitting simultaneously in different frequency bands, the volume scan is measured separately in each frequency band. In order to sum correctly to compute the 1g aggregate SAR, the EUT remain in the same test position for all measurements and all volume scan use the same spatial resolution and grid spacing. When all volume scan were completed, the software, SEMCAD postprocessor can combine and subsequently superpose these measurement data to calculating the multiband SAR.

**8.6 Power Drift Monitoring**

All SAR testing is under the EUT install full charged battery and transmit maximum output power. In DASy measurement software, the power reference measurement and power drift measurement procedures are used for monitoring the power drift of EUT during SAR test. Both these procedures measure the field at a specified reference position before and after the SAR testing. The software will calculate the field difference in dB. If the power drifts more than 5%, the SAR will be retested.



**9. Test Equipment List**

Manufacturer	Name of Equipment	Type/Model	Serial Number	Calibration	
				Last Cal.	Due Date
SPEAG	835MHz System Validation Kit	D835V2	4d151	Mar. 25, 2013	Mar. 23, 2015
SPEAG	1750MHz System Validation Kit	D1750V2	1090	Mar. 27, 2013	Mar. 25, 2015
SPEAG	1900MHz System Validation Kit	D1900V2	5d170	Mar. 27, 2013	Mar. 25, 2015
SPEAG	2450MHz System Validation Kit	D2450V2	908	Mar. 26, 2013	Mar. 24, 2015
SPEAG	Data Acquisition Electronics	DAE4	1358	Apr. 30, 2014	Apr. 29, 2015
SPEAG	Dosimetric E-Field Probe	EX3DV4	3911	Oct. 02, 2014	Oct. 01, 2015
SPEAG	Phone Positioner	N/A	N/A	NCR	NCR
SPEAG	SAM Twin Phantom	QD 000 P40 CD	TP-1753	NCR	NCR
SPEAG	SAM Twin Phantom	QD 000 P40 CD	TP-1754	NCR	NCR
Agilent	Wireless Communication Test Set	E5515C	MY52102600	Dec. 09, 2014	Dec. 08, 2015
Agilent	ENA Series Network Analyzer	E5071C	MY46317418	Dec. 09, 2014	Dec. 08, 2015
Agilent	Dielectric Probe Kit	85070E	MY44300751	NCR	NCR
Anritsu	Power Meter	ML2495A	1005002	Feb. 27, 2014	Feb. 26, 2015
Anritsu	Power Sensor	MA2411B	917070	Feb. 27, 2014	Feb. 26, 2015
R&S	Spectrum Analyzer	FSP7	101045	Dec. 09, 2014	Dec. 08, 2015
Agilent	Dual Directional Coupler	778D	50422	Note1	
Woken	Attenuator 1	WK0602-XX	N/A	Note1	
PE	Attenuator 2	PE7005-10	N/A	Note1	
PE	Attenuator 3	PE7005- 3	N/A	Note1	
AR	Power Amplifier	5S1G4M2	0328767	Note1	
Mini-Circuits	Power Amplifier	ZVE-3W	162601250	Note1	
Mini-Circuits	Power Amplifier	ZHL-42W+	13440021344	Note1	

**General Note:**

1. Prior to system verification and validation, the path loss from the signal generator to the system check source and the power meter, which includes the amplifier, cable, attenuator and directional coupler, was measured by the network analyzer. The reading of the power meter was offset by the path loss difference between the path to the power meter and the path to the system check source to monitor the actual power level fed to the system check source.
2. Referring to KDB 865664 D01v01r03, the dipole calibration interval can be extended to 3 years with justification. The dipoles are also not physically damaged, or repaired during the interval.
3. The justification data of dipole D835V2, SN: 4d151, D1750V2, SN: 1090, D1900V2, SN: 5d170, D2450V2, SN: 908 can be found in appendix C. The return loss is < -20dB, within 20% of prior calibration, the impedance is within 5 ohm of prior calibration.

## **10. System Verification**

### **10.1 Tissue Verification**

The following tissue formulations are provided for reference only as some of the parameters have not been thoroughly verified. The composition of ingredients may be modified accordingly to achieve the desired target tissue parameters required for routine SAR evaluation.

Frequency (MHz)	Water (%)	Sugar (%)	Cellulose (%)	Salt (%)	Preventol (%)	DGBE (%)	Conductivity ( $\sigma$ )	Permittivity ( $\epsilon_r$ )
<b>For Head</b>								
835	40.3	57.9	0.2	1.4	0.2	0	0.90	41.5
1750	55.2	0	0	0.3	0	44.5	1.37	40.1
1800, 1900, 2000	55.2	0	0	0.3	0	44.5	1.40	40.0
2450	55.0	0	0	0	0	45.0	1.80	39.2
<b>For Body</b>								
835	50.8	48.2	0	0.9	0.1	0	0.97	55.2
1750	70.2	0	0	0.4	0	29.4	1.49	53.4
1800, 1900, 2000	70.2	0	0	0.4	0	29.4	1.52	53.3
2450	68.6	0	0	0	0	31.4	1.95	52.7

### **<Tissue Dielectric Parameter Check Results>**

Frequency (MHz)	Tissue Type	Liquid Temp. (°C)	Conductivity ( $\sigma$ )	Permittivity ( $\epsilon_r$ )	Conductivity Target ( $\sigma$ )	Permittivity Target ( $\epsilon_r$ )	Delta ( $\sigma$ ) (%)	Delta ( $\epsilon_r$ ) (%)	Limit (%)	Date
835	Head	22.6	0.900	42.153	0.90	41.50	0.00	1.57	±5	02/07/2015
1750	Head	22.6	1.356	40.423	1.37	40.10	-1.02	0.81	±5	02/11/2015
1900	Head	22.3	1.415	38.757	1.40	40.00	1.07	-3.11	±5	02/07/2015
2450	Head	22.5	1.832	37.700	1.80	39.20	1.78	-3.83	±5	02/12/2015
835	Body	22.5	0.970	53.680	0.97	55.20	0.00	-2.75	±5	02/07/2015
1750	Body	22.6	1.529	54.187	1.49	53.40	2.62	1.47	±5	02/11/2015
1900	Body	22.5	1.543	52.508	1.52	53.30	1.51	-1.49	±5	02/05/2015
2450	Body	22.6	1.949	53.894	1.95	52.70	-0.05	2.27	±5	02/12/2015

**10.2 System Performance Check Results**

Comparing to the original SAR value provided by SPEAG, the verification data should be within its specification of 10 %. Below table shows the target SAR and measured SAR after normalized to 1W input power. The table below indicates the system performance check can meet the variation criterion and the plots can be referred to Appendix A of this report.

Date	Frequency (MHz)	Tissue Type	Input Power (mW)	Dipole S/N	Probe S/N	DAE S/N	Measured SAR (W/kg)	Targeted SAR (W/kg)	Normalized SAR (W/kg)	Deviation (%)
02/07/2015	835	Head	250	4d151	3911	1358	2.38	9.49	9.52	0.32
02/11/2015	1750	Head	250	1090	3911	1358	8.51	36.90	34.04	-7.75
02/07/2015	1900	Head	250	5d170	3911	1358	9.55	40.20	38.2	-4.98
02/12/2015	2450	Head	250	908	3911	1358	13.80	54.00	55.2	2.22
02/07/2015	835	Body	250	4d151	3911	1358	2.45	9.43	9.8	3.92
02/11/2015	1750	Body	250	1090	3911	1358	9.35	38.10	37.4	-1.84
02/05/2015	1900	Body	250	5d170	3911	1358	10.00	41.20	40	-2.91
02/12/2015	2450	Body	250	908	3911	1358	13.20	50.40	52.8	4.76

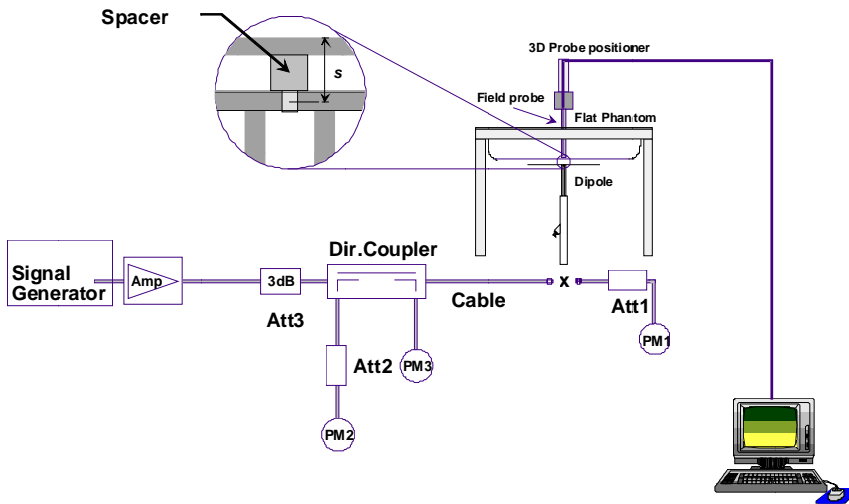

**Fig 8.3.1 System Performance Check Setup**



**Fig 8.3.2 Setup Photo**



## 11. RF Exposure Positions

### 11.1 Ear and handset reference point

Figure 9.1.1 shows the front, back, and side views of the SAM phantom. The center-of-mouth reference point is labeled "M," the left ear reference point (ERP) is marked "LE," and the right ERP is marked "RE." Each ERP is 15 mm along the B-M (back-mouth) line behind the entrance-to-ear-canal (EEC) point, as shown in Figure 9.1.2 The Reference Plane is defined as passing through the two ear reference points and point M. The line N-F (neck-front), also called the reference pivoting line, is normal to the Reference Plane and perpendicular to both a line passing through RE and LE and the B-M line (see Figure 9.1.3). Both N-F and B-M lines should be marked on the exterior of the phantom shell to facilitate handset positioning. Posterior to the N-F line the ear shape is a flat surface with 6 mm thickness at each ERP, and forward of the N-F line the ear is truncated, as illustrated in Figure 9.1.2. The ear truncation is introduced to preclude the ear lobe from interfering with handset tilt, which could lead to unstable positioning at the cheek.

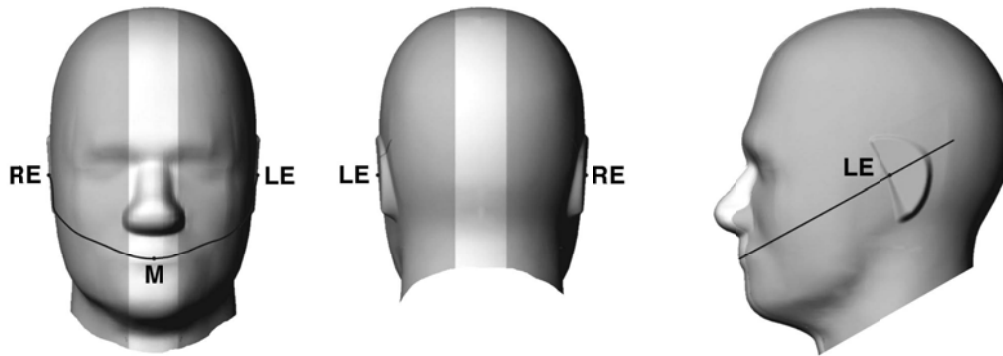

Fig 9.1.1 Front, back, and side views of SAM twin phantom

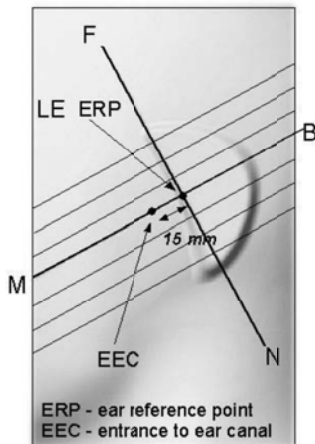

Fig 9.1.2 Close-up side view of phantom showing the ear region.

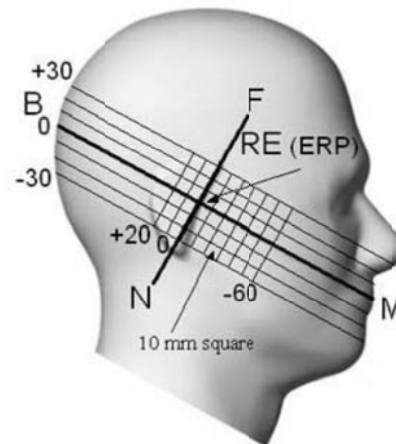
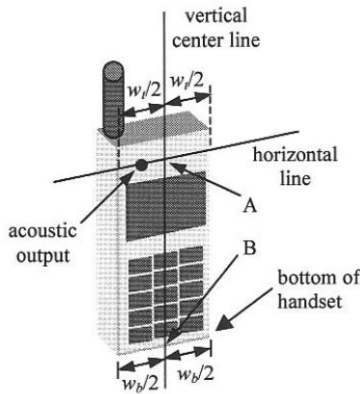

Fig 9.1.3 Side view of the phantom showing relevant markings and seven cross-sectional plane locations

**11.2 Definition of the cheek position**

1. Ready the handset for talk operation, if necessary. For example, for handsets with a cover piece (flip cover), open the cover. If the handset can transmit with the cover closed, both configurations must be tested.
2. Define two imaginary lines on the handset—the vertical centerline and the horizontal line. The vertical centerline passes through two points on the front side of the handset—the midpoint of the width  $w_t$  of the handset at the level of the acoustic output (point A in Figure 9.2.1 and Figure 9.2.2), and the midpoint of the width  $w_b$  of the bottom of the handset (point B). The horizontal line is perpendicular to the vertical centerline and passes through the center of the acoustic output (see Figure 9.2.1). The two lines intersect at point A. Note that for many handsets, point A coincides with the center of the acoustic output; however, the acoustic output may be located elsewhere on the horizontal line. Also note that the vertical centerline is not necessarily parallel to the front face of the handset (see Figure 9.2.2), especially for clamshell handsets, handsets with flip covers, and other irregularly-shaped handsets.
3. Position the handset close to the surface of the phantom such that point A is on the (virtual) extension of the line passing through points RE and LE on the phantom (see Figure 9.2.3), such that the plane defined by the vertical centerline and the horizontal line of the handset is approximately parallel to the sagittal plane of the phantom.
4. Translate the handset towards the phantom along the line passing through RE and LE until handset point A touches the pinna at the ERP.
5. While maintaining the handset in this plane, rotate it around the LE-RE line until the vertical centerline is in the plane normal to the plane containing B-M and N-F lines, i.e., the Reference Plane.
6. Rotate the handset around the vertical centerline until the handset (horizontal line) is parallel to the N-F line.
7. While maintaining the vertical centerline in the Reference Plane, keeping point A on the line passing through RE and LE, and maintaining the handset contact with the pinna, rotate the handset about the N-F line until any point on the handset is in contact with a phantom point below the pinna on the cheek. See Figure 9.2.3. The actual rotation angles should be documented in the test report.



**Fig 9.2.1 Handset vertical and horizontal reference lines—“fixed case”**

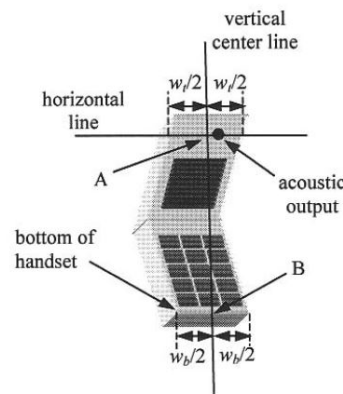

**Fig 9.2.2 Handset vertical and horizontal reference lines—“clam-shell case”**

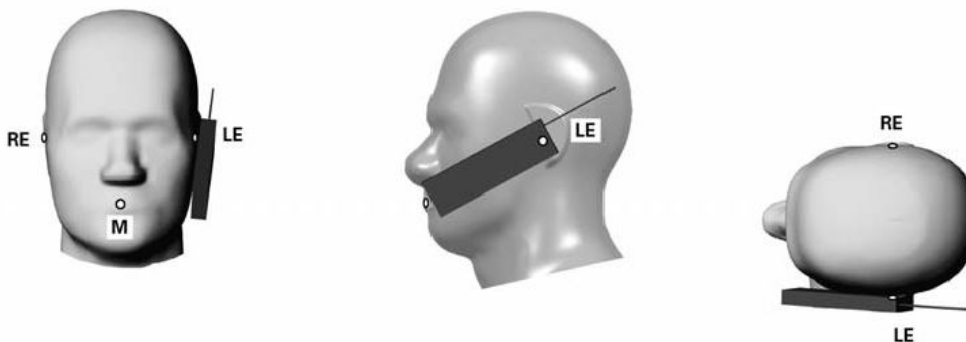

**Fig 9.2.3 cheek or touch position. The reference points for the right ear (RE), left ear (LE), and mouth (M), which establish the Reference Plane for handset positioning, are indicated.**

**11.3 Definition of the tilt position**

1. Ready the handset for talk operation, if necessary. For example, for handsets with a cover piece (flip cover), open the cover. If the handset can transmit with the cover closed, both configurations must be tested.
2. While maintaining the orientation of the handset, move the handset away from the pinna along the line passing through RE and LE far enough to allow a rotation of the handset away from the cheek by 15°.
3. Rotate the handset around the horizontal line by 15°.
4. While maintaining the orientation of the handset, move the handset towards the phantom on the line passing through RE and LE until any part of the handset touches the ear. The tilt position is obtained when the contact point is on the pinna. See Figure 9.3.1. If contact occurs at any location other than the pinna, e.g., the antenna at the back of the phantom head, the angle of the handset should be reduced. In this case, the tilt position is obtained if any point on the handset is in contact with the pinna and a second point

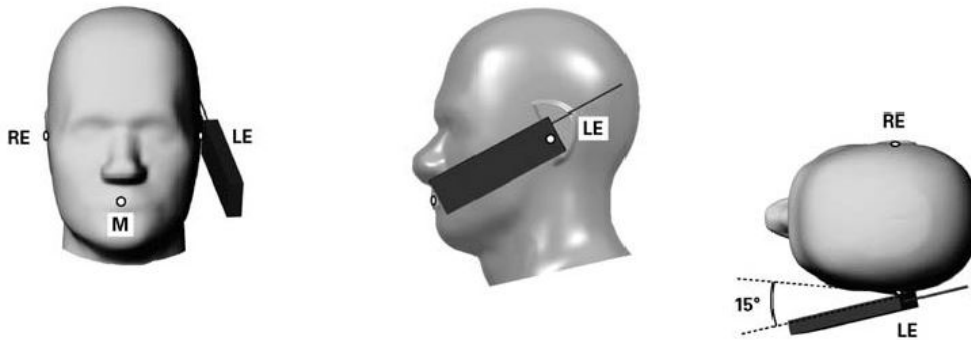
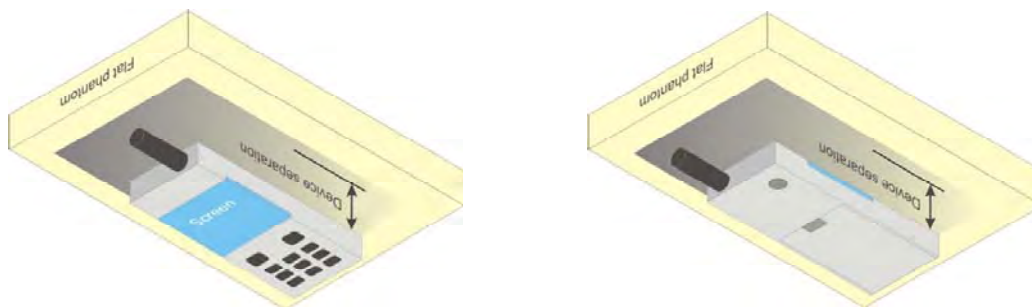

**Fig 9.3.1 Tilt position. The reference points for the right ear (RE), left ear (LE), and mouth (M), which define the Reference Plane for handset positioning, are indicated.**

**11.4 Body Worn Accessory**

Body-worn operating configurations are tested with the belt-clips and holsters attached to the device and positioned against a flat phantom in a normal use configuration (see Figure 9.4). Per KDB 648474 D04v01r02, body-worn accessory exposure is typically related to voice mode operations when handsets are carried in body-worn accessories. The body-worn accessory procedures in FCC KDB 447498 D01v05r02 should be used to test for body-worn accessory SAR compliance, without a headset connected to it. This enables the test results for such configuration to be compatible with that required for hotspot mode when the body-worn accessory test separation distance is greater than or equal to that required for hotspot mode, when applicable. When the reported SAR for body-worn accessory, measured without a headset connected to the handset is < 1.2 W/kg, the highest reported SAR configuration for that wireless mode and frequency band should be repeated for that body-worn accessory with a handset attached to the handset.

Accessories for body-worn operation configurations are divided into two categories: those that do not contain metallic components and those that do contain metallic components. When multiple accessories that do not contain metallic components are supplied with the device, the device is tested with only the accessory that dictates the closest spacing to the body. Then multiple accessories that contain metallic components are test with the device with each accessory. If multiple accessories share an identical metallic component (i.e. the same metallic belt-chip used with different holsters with no other metallic components) only the accessory that dictates the closest spacing to the body is tested.



**Fig 9.4 Body Worn Position**

**11.5 Wireless Router**

Some battery-operated handsets have the capability to transmit and receive user through simultaneous transmission of WIFI simultaneously with a separate licensed transmitter. The FCC has provided guidance in FCC HDB Publication 941225 D06 v02 where SAR test considerations for handsets (L x W ≥ 9 cm x 5 cm) are based on a composite test separation distance of 10mm from the front, back and edges of the device containing transmitting antennas within 2.5cm of their edges, determined from general mixed use conditions for this type of devices. Since the hotspot SAR results may overlap with the body-worn accessory SAR requirements, the more conservative configurations can be considered, thus excluding some body-worn accessory SAR tests.

When the user enables the personal wireless router functions for the handset, actual operations include simultaneous transmission of both the WIFI transmitter and another licensed transmitter. Both transmitters often do not transmit at the same transmitting frequency and thus cannot be evaluated for SAR under actual use conditions due to the limitations of the SAR assessment probes. Therefore, SAR must be evaluated for each frequency transmission and mode separately and spatially summed with the WIFI transmitter according to FCC KDB Publication 447498 D01v05r02 publication procedures. The "Portable Hotspot" feature on the handset was NOT activated during SAR assessments, to ensure the SAR measurements were evaluated for a single transmission frequency RF signal at a time.



### **11.6 Extremity Exposure**

For smart phones with a display diagonal dimension > 15.0 cm or an overall diagonal dimension > 16.0 cm that provide similar mobile web access and multimedia support found in mini-tablets or UMPC mini-tablets that support voice calls next to the ear, According to KDB648474D04v01r02, the following phablet procedures should be applied to evaluate SAR compliance for each applicable wireless modes and frequency band. Devices marketed as phablets, regardless of form factors and operating characteristics must be tested as a phablet to determine SAR compliance

1. The normally required head and body-worn accessory SAR test procedures for handsets, including hotspot mode, must be applied.
2. The UMPC mini-tablet procedures must also be applied to test the SAR of all surfaces and edges with an antenna located at  $\leq 25$  mm from that surface or edge, in direct contact with a flat phantom, for 10-g extremity SAR according to the body-equivalent tissue dielectric parameters in KDB 865664 to address interactive hand use exposure conditions.6 The UMPC mini-tablet 1-g SAR at 5 mm is not required. When hotspot mode applies, 10-g extremity SAR is required only for the surfaces and edges with hotspot mode 1-g reported SAR > 1.2 W/kg.



## 12. Conducted RF Output Power (Unit: dBm)

### <GSM Conducted Power>

**General Note:**

- Per KDB 447498 D01v05r02, the maximum output power channel is used for SAR testing and for further SAR test reduction.
- Per KDB 941225 D01v03, considering the possibility of e.g. 3rd party VoIP operation for Head and body-worn SAR test reduction for GSM and GPRS and EDGE modes is determined by the source-based time-averaged output power including tune-up tolerance. The mode with highest specified time-averaged output power should be tested for SAR compliance in the applicable exposure conditions. For modes with the same specified maximum output power and tolerance, the higher number time-slot configuration should be tested. Therefore, the EUT was set in GPRS (2Tx slots) for GSM850, GPRS (4Tx slots) for GSM1900.
- Per KDB 941225 D01v03, for Hotspot SAR test reduction for GPRS and EDGE modes is determined by the source-based time-averaged output power including tune-up tolerance, for modes with the same specified maximum output power and tolerance, the higher number time-slot configuration should be tested, therefore, the EUT was set in GPRS (2Tx slots) for GSM850, GPRS (4Tx slots) for GSM1900.

**SIM1 Card:**

Band GSM850	Burst Average Power (dBm)			Tune-up Limit (dBm)	Frame-Average Power (dBm)			Tune-up Limit (dBm)	
	128	189	251		128	189	251		
TX Channel	128	189	251	Limit	128	189	251	Limit	
Frequency (MHz)	824.2	836.4	848.8	(dBm)	824.2	836.4	848.8	(dBm)	
GSM (GMSK, 1 Tx slot)	<b>33.97</b>	33.82	33.79	34.00	24.97	24.82	24.79	25.00	
GPRS (GMSK, 1 Tx slot) – CS1	33.92	33.78	33.77	34.00	24.92	24.78	24.77	25.00	
GPRS (GMSK, 2 Tx slots) – CS1	33.23	33.02	33.00	33.50	<b>27.23</b>	27.02	27.00	27.50	
GPRS (GMSK, 3 Tx slots) – CS1	31.38	31.12	31.08	31.50	27.12	26.86	26.82	27.24	
GPRS (GMSK, 4 Tx slots) – CS1	29.98	29.71	29.66	30.00	26.98	26.71	26.66	27.00	
EDGE (8PSK, 1 Tx slot) – MCS5	27.92	27.79	27.76	28.00	18.92	18.79	18.76	19.00	
EDGE (8PSK, 2 Tx slots) – MCS5	26.89	26.73	26.67	27.00	20.89	20.73	20.67	21.00	
EDGE (8PSK, 3 Tx slots) – MCS5	24.56	24.54	24.40	25.00	20.30	20.28	20.14	20.74	
EDGE (8PSK, 4 Tx slots) – MCS5	23.22	23.20	23.15	23.50	20.22	20.20	20.15	20.50	
Band GSM1900		Burst Average Power (dBm)			Tune-up Limit (dBm)	Frame-Average Power (dBm)			Tune-up Limit (dBm)
TX Channel	512	661	810	512		661	810		
Frequency (MHz)	1850.2	1880	1909.8	(dBm)	1850.2	1880	1909.8	(dBm)	
GSM (GMSK, 1 Tx slot)	30.76	30.65	<b>30.88</b>	31.00	21.76	21.65	21.88	22.00	
GPRS (GMSK, 1 Tx slot) – CS1	30.73	30.59	30.83	31.00	21.73	21.59	21.83	22.00	
GPRS (GMSK, 2 Tx slots) – CS1	29.85	29.74	30.01	30.50	23.85	23.74	24.01	24.50	
GPRS (GMSK, 3 Tx slots) – CS1	28.00	27.91	28.25	28.50	23.74	23.65	23.99	24.24	
GPRS (GMSK, 4 Tx slots) – CS1	26.92	26.86	27.24	27.50	23.92	23.86	<b>24.24</b>	24.50	
EDGE (8PSK, 1 Tx slot) – MCS5	26.41	26.40	26.49	27.00	17.41	17.40	17.49	18.00	
EDGE (8PSK, 2 Tx slots) – MCS5	25.26	25.24	25.36	26.00	19.26	19.24	19.36	20.00	
EDGE (8PSK, 3 Tx slots) – MCS5	23.11	23.10	23.35	24.00	18.85	18.84	19.09	19.74	
EDGE (8PSK, 4 Tx slots) – MCS5	21.95	21.93	21.98	22.50	18.95	18.93	18.98	19.50	

Remark: The frame-averaged power is linearly scaled the maximum burst averaged power over 8 time slots. The calculated method are shown as below:

- Frame-averaged power = Maximum burst averaged power (1 Tx Slot) - 9 dB
- Frame-averaged power = Maximum burst averaged power (2 Tx Slots) - 6 dB
- Frame-averaged power = Maximum burst averaged power (3 Tx Slots) - 4.26 dB
- Frame-averaged power = Maximum burst averaged power (4 Tx Slots) - 3 dB



SIM2 Card:

Band GSM850	Burst Average Power (dBm)			Tune-up Limit (dBm)	Frame-Average Power (dBm)			Tune-up Limit (dBm)
	TX Channel	128	189		251	128	189	
Frequency (MHz)	824.2	836.4	848.8		824.2	836.4	848.8	
GSM (GMSK, 1 Tx slot)	33.93	33.81	33.78	34.00	24.93	24.81	24.78	25.00
GPRS (GMSK, 1 Tx slot) – CS1	33.89	33.75	33.72	34.00	24.89	24.75	24.72	25.00
GPRS (GMSK, 2 Tx slots) – CS1	33.20	32.98	32.94	33.50	27.20	26.98	26.94	27.50
GPRS (GMSK, 3 Tx slots) – CS1	31.36	31.09	31.04	31.50	27.10	26.83	26.78	27.24
GPRS (GMSK, 4 Tx slots) – CS1	29.95	29.67	29.61	30.00	26.95	26.67	26.61	27.00
EDGE (8PSK, 1 Tx slot) – MCS5	27.90	27.78	27.75	28.00	18.90	18.78	18.75	19.00
EDGE (8PSK, 2 Tx slots) – MCS5	26.83	26.70	26.66	27.00	20.83	20.70	20.66	21.00
EDGE (8PSK, 3 Tx slots) – MCS5	24.52	24.51	24.38	25.00	20.26	20.25	20.12	20.74
EDGE (8PSK, 4 Tx slots) – MCS5	23.20	23.15	23.11	23.50	20.20	20.15	20.11	20.50
Band GSM1900	Burst Average Power (dBm)			Tune-up Limit (dBm)	Frame-Average Power (dBm)			Tune-up Limit (dBm)
TX Channel	512	661	810		512	661	810	
Frequency (MHz)	1850.2	1880	1909.8		1850.2	1880	1909.8	
GSM (GMSK, 1 Tx slot)	30.75	30.64	30.87	31.00	21.75	21.64	21.87	22.00
GPRS (GMSK, 1 Tx slot) – CS1	30.71	30.57	30.80	31.00	21.71	21.57	21.80	22.00
GPRS (GMSK, 2 Tx slots) – CS1	29.84	29.72	29.98	30.50	23.84	23.72	23.98	24.50
GPRS (GMSK, 3 Tx slots) – CS1	27.98	27.90	28.23	28.50	23.72	23.64	23.97	24.24
GPRS (GMSK, 4 Tx slots) – CS1	26.89	26.84	27.22	27.50	23.89	23.84	24.22	24.50
EDGE (8PSK, 1 Tx slot) – MCS5	26.38	26.36	26.48	27.00	17.38	17.36	17.48	18.00
EDGE (8PSK, 2 Tx slots) – MCS5	25.25	25.22	25.35	26.00	19.25	19.22	19.35	20.00
EDGE (8PSK, 3 Tx slots) – MCS5	23.09	23.07	23.32	24.00	18.83	18.81	19.06	19.74
EDGE (8PSK, 4 Tx slots) – MCS5	21.94	21.90	21.96	22.50	18.94	18.90	18.96	19.50

Remark: The frame-averaged power is linearly scaled the maximum burst averaged power over 8 time slots.

The calculated method are shown as below:

Frame-averaged power = Maximum burst averaged power (1 Tx Slot) - 9 dB

Frame-averaged power = Maximum burst averaged power (2 Tx Slots) - 6 dB

Frame-averaged power = Maximum burst averaged power (3 Tx Slots) - 4.26 dB

Frame-averaged power = Maximum burst averaged power (4 Tx Slots) - 3 dB

**<WCDMA Conducted Power>**

1. The following tests were conducted according to the test requirements outlines in 3GPP TS 34.121 specification.
2. The procedures in KDB 941225 D01 are applied for 3GPP Rel. 6 HSPA to configure the device in the required sub-test mode(s) to determine SAR test exclusion.

A summary of these settings are illustrated below:

**HSDPA Setup Configuration:**

- a. The EUT was connected to Base Station Agilent E5515C referred to the Setup Configuration.
- b. The RF path losses were compensated into the measurements.
- c. A call was established between EUT and Base Station with following setting:
  - i. Set Gain Factors ( $\beta_c$  and  $\beta_d$ ) and parameters were set according to each
  - ii. Specific sub-test in the following table, C10.1.4, quoted from the TS 34.121
  - iii. Set RMC 12.2Kbps + HSDPA mode.
  - iv. Set Cell Power = -86 dBm
  - v. Set HS-DSCH Configuration Type to FRC (H-set 1, QPSK)
  - vi. Select HSDPA Uplink Parameters
  - vii. Set Delta ACK, Delta NACK and Delta CQI = 8
  - viii. Set Ack-Nack Repetition Factor to 3
  - ix. Set CQI Feedback Cycle (k) to 4 ms
  - x. Set CQI Repetition Factor to 2
  - xi. Power Ctrl Mode = All Up bits
- d. The transmitted maximum output power was recorded.

**Table C.10.1.4:  $\beta$  values for transmitter characteristics tests with HS-DPCCH**

Sub-test	$\beta_c$	$\beta_d$	$\beta_d$ (SF)	$\beta_c/\beta_d$	$\beta_{HS}$ (Note 1, Note 2)	CM (dB) (Note 3)	MPR (dB) (Note 3)
1	2/15	15/15	64	2/15	4/15	0.0	0.0
2	12/15 (Note 4)	15/15 (Note 4)	64	12/15 (Note 4)	24/15	1.0	0.0
3	15/15	8/15	64	15/8	30/15	1.5	0.5
4	15/15	4/15	64	15/4	30/15	1.5	0.5

Note 1:  $\Delta_{ACK}, \Delta_{NACK}$  and  $\Delta_{CQI} = 30/15$  with  $\beta_{HS} = 30/15 * \beta_c$ .

Note 2: For the HS-DPCCH power mask requirement test in clause 5.2C, 5.7A, and the Error Vector Magnitude (EVM) with HS-DPCCH test in clause 5.13.1A, and HSDPA EVM with phase discontinuity in clause 5.13.1AA,  $\Delta_{ACK}$  and  $\Delta_{NACK} = 30/15$  with  $\beta_{HS} = 30/15 * \beta_c$ , and  $\Delta_{CQI} = 24/15$  with  $\beta_{HS} = 24/15 * \beta_c$ .

Note 3: CM = 1 for  $\beta_c/\beta_d = 12/15, \beta_{HS}/\beta_c = 24/15$ . For all other combinations of DPDCCH, DPCCH and HS-DPCCH the MPR is based on the relative CM difference. This is applicable for only UEs that support HSDPA in release 6 and later releases.

Note 4: For subtest 2 the  $\beta_c/\beta_d$  ratio of 12/15 for the TFC during the measurement period (TF1, TF0) is achieved by setting the signalled gain factors for the reference TFC (TF1, TF1) to  $\beta_c = 11/15$  and  $\beta_d = 15/15$ .

**Setup Configuration**



**HSUPA Setup Configuration:**

- a. The EUT was connected to Base Station Agilent E5515C referred to the Setup Configuration.
- b. The RF path losses were compensated into the measurements.
- c. A call was established between EUT and Base Station with following setting \* :
  - i. Call Configs = 5.2B, 5.9B, 5.10B, and 5.13.2B with QPSK
  - ii. Set the Gain Factors ( $\beta_c$  and  $\beta_d$ ) and parameters (AG Index) were set according to each specific sub-test in the following table, C11.1.3, quoted from the TS 34.121
  - iii. Set Cell Power = -86 dBm
  - iv. Set Channel Type = 12.2k + HSPA
  - v. Set UE Target Power
  - vi. Power Ctrl Mode= Alternating bits
  - vii. Set and observe the E-TFCl
  - viii. Confirm that E-TFCl is equal to the target E-TFCl of 75 for sub-test 1, and other subtest's E-TFCl
- d. The transmitted maximum output power was recorded.

**Table C.11.1.3:  $\beta$  values for transmitter characteristics tests with HS-DPCCH and E-DCH**

Sub-test	$\beta_c$	$\beta_d$	$\beta_d$ (SF)	$\beta_c/\beta_d$	$\beta_{HS}$ (Note 1)	$\beta_{ec}$	$\beta_{ed}$ (Note 5) (Note 6)	$\beta_{ed}$ (SF)	$\beta_{ed}$ (Codes)	CM (dB) (Note 2)	MPR (dB) (Note 2)	AG Index (Note 6)	E-TFCl
1	11/15 (Note 3)	15/15 (Note 3)	64	11/15 (Note 3)	22/15	209/25	1309/225	4	1	1.0	0.0	20	75
2	6/15	15/15	64	6/15	12/15	12/15	94/75	4	1	3.0	2.0	12	67
3	15/15	9/15	64	15/9	30/15	30/15	$\beta_{ed1}: 47/15$ $\beta_{ed2}: 47/15$	4 4	2	2.0	1.0	15	92
4	2/15	15/15	64	2/15	4/15	2/15	56/75	4	1	3.0	2.0	17	71
5	15/15 (Note 4)	15/15 (Note 4)	64	15/15 (Note 4)	30/15	24/15	134/15	4	1	1.0	0.0	21	81

Note 1:  $\Delta_{ACK}, \Delta_{NACK}$  and  $\Delta_{CQI} = 30/15$  with  $\beta_{hs} = 30/15 * \beta_c$ .

Note 2: CM = 1 for  $\beta_c/\beta_d = 12/15$ ,  $\beta_{hs}/\beta_c = 24/15$ . For all other combinations of DPDCH, DPCCH, HS-DPCCH, E-DPDCH and E-DPCCH the MPR is based on the relative CM difference.

Note 3: For subtest 1 the  $\beta_c/\beta_d$  ratio of 11/15 for the TFC during the measurement period (TF1, TF0) is achieved by setting the signalled gain factors for the reference TFC (TF1, TF1) to  $\beta_c = 10/15$  and  $\beta_d = 15/15$ .

Note 4: For subtest 5 the  $\beta_c/\beta_d$  ratio of 15/15 for the TFC during the measurement period (TF1, TF0) is achieved by setting the signalled gain factors for the reference TFC (TF1, TF1) to  $\beta_c = 14/15$  and  $\beta_d = 15/15$ .

Note 5: In case of testing by UE using E-DPDCH Physical Layer category 1, Sub-test 3 is omitted according to TS25.306 Table 5.1g.

Note 6:  $\beta_{ed}$  can not be set directly, it is set by Absolute Grant Value.

**Setup Configuration**



**<WCDMA Conducted Power>**

**General Note:**

1. Per KDB 941225 D01v03, SAR for Head / Hotspot / Body-worn exposure is measured using a 12.2 kbps RMC with TPC bits configured to all "1"s".
2. Per KDB 941225 D01v03, RMC 12.2kbps setting is used to evaluate SAR. If the maximum output power and tune-up tolerance specified for production units in HSDPA / HSUPA is  $\leq \frac{1}{4}$  dB higher than RMC 12.2Kbps or when the highest reported SAR of the RMC12.2Kbps is scaled by the ratio of specified maximum output power and tune-up tolerance of HSDPA / HSUPA to RMC12.2Kbps and the adjusted SAR is  $\leq 1.2$  W/kg, SAR measurement is not required for HSDPA / HSUPA.

**SIM1 Card:**

Band			WCDMA V			WCDMA II			WCDMA IV		
TX Channel			4132	4182	4233	9262	9400	9538	1312	1413	1513
Rx Channel			4357	4407	4458	9662	9800	9938	1537	1638	1738
Frequency (MHz)			826.4	836.4	846.6	1852.4	1880	1907.6	1712.4	1732.6	1752.6
MPR (dB)	3GPP Rel 99	AMR 12.2Kbps	24.16	24.08	24.01	23.90	23.64	23.45	22.37	22.26	22.35
	3GPP Rel 99	RMC 12.2Kbps	<b>24.17</b>	24.09	24.02	<b>23.92</b>	23.65	23.46	<b>22.38</b>	22.27	22.36
0	3GPP Rel 6	HSDPA Subtest-1	22.84	22.85	22.79	22.54	22.29	22.09	20.41	20.33	20.39
0	3GPP Rel 6	HSDPA Subtest-2	22.87	22.85	22.79	22.53	22.29	22.07	20.38	20.35	20.36
0.5	3GPP Rel 6	HSDPA Subtest-3	22.38	22.40	22.36	22.07	21.83	21.63	20.40	20.37	20.38
0.5	3GPP Rel 6	HSDPA Subtest-4	22.34	22.35	22.33	22.06	21.78	21.59	20.39	20.35	20.37
0	3GPP Rel 6	HSUPA Subtest-1	20.89	20.89	20.89	20.63	20.42	20.26	19.45	19.42	19.44
2	3GPP Rel 6	HSUPA Subtest-2	20.87	20.90	20.82	20.60	20.39	20.23	19.44	19.41	19.42
1	3GPP Rel 6	HSUPA Subtest-3	21.89	21.89	21.88	21.61	21.37	21.19	20.36	20.34	20.35
2	3GPP Rel 6	HSUPA Subtest-4	20.36	20.36	20.29	20.07	19.84	19.71	18.99	18.95	18.96
0	3GPP Rel 6	HSUPA Subtest-5	22.80	22.90	22.80	22.60	22.40	22.20	21.06	21.00	21.03

**SIM2 Card:**

Band			WCDMA V			WCDMA II			WCDMA IV		
TX Channel			4132	4182	4233	9262	9400	9538	1312	1413	1513
Rx Channel			4357	4407	4458	9662	9800	9938	1537	1638	1738
Frequency (MHz)			826.4	836.4	846.6	1852.4	1880	1907.6	1712.4	1732.6	1752.6
MPR (dB)	3GPP Rel 99	AMR 12.2Kbps	24.09	24.07	23.98	23.88	23.62	23.44	22.35	22.24	22.34
	3GPP Rel 99	RMC 12.2Kbps	<b>24.10</b>	24.08	24.00	<b>23.90</b>	23.63	23.45	<b>22.36</b>	22.26	22.35
0	3GPP Rel 6	HSDPA Subtest-1	22.81	22.84	22.78	22.52	22.27	22.07	20.40	20.32	20.38
0	3GPP Rel 6	HSDPA Subtest-2	22.82	22.82	22.76	22.50	22.25	22.05	20.37	20.34	20.36
0.5	3GPP Rel 6	HSDPA Subtest-3	22.34	22.36	22.32	22.02	21.81	21.57	20.39	20.36	20.37
0.5	3GPP Rel 6	HSDPA Subtest-4	22.32	22.32	22.29	22.00	21.75	21.56	20.38	20.34	20.35
0	3GPP Rel 6	HSUPA Subtest-1	20.88	20.86	20.84	20.58	20.40	20.25	19.44	19.41	19.43
2	3GPP Rel 6	HSUPA Subtest-2	20.85	20.88	20.80	20.53	20.37	20.20	19.42	19.40	19.40
1	3GPP Rel 6	HSUPA Subtest-3	21.86	21.88	21.83	21.55	21.34	21.17	20.35	20.32	20.33
2	3GPP Rel 6	HSUPA Subtest-4	20.34	20.34	20.28	20.01	19.83	19.68	18.97	18.94	18.96
0	3GPP Rel 6	HSUPA Subtest-5	22.79	22.87	22.78	22.58	22.35	22.13	21.05	21.00	21.01



**<WLAN Conducted Power>**

**General Note:**

For 2.4GHz WLAN SAR testing, highest average RF output power channel for the lowest data rate for 802.11b were selected for SAR evaluation. 802.11g/n HT20/HT40 were not investigated since the average output powers over all channels and data rates were not more than 0.25 dB higher than the tested channel in the lowest data rate of 802.11b mode.

**<2.4GHz WLAN Antenna>**

WLAN 2.4GHz 802.11b Average Power (dBm)					
Power vs. Channel			Power vs. Data Rate		
Channel	Frequency (MHz)	Data Rate	2Mbps	5.5Mbps	11Mbps
		1Mbps			
CH 1	2412	12.56	12.81	12.82	12.72
CH 6	2437	12.77			
CH 11	2462	<b>12.84</b>			

WLAN 2.4GHz 802.11g Average Power (dBm)									
Power vs. Channel			Power vs. Data Rate						
Channel	Frequency (MHz)	Data Rate	9Mbps	12Mbps	18Mbps	24Mbps	36Mbps	48Mbps	54Mbps
		6Mbps							
CH 1	2412	11.81	11.70	11.76	11.86	11.75	11.49	11.84	11.69
CH 6	2437	11.83							
CH 11	2462	<b>11.88</b>							

WLAN 2.4GHz 802.11n-HT20 Average Power (dBm)									
Power vs. Channel			Power vs. MCS Index						
Channel	Frequency (MHz)	MCS Index	MCS1	MCS2	MCS3	MCS4	MCS5	MCS6	MCS7
		MCS0							
CH 1	2412	11.47	11.78	11.76	11.80	11.45	11.62	11.82	11.79
CH 6	2437	11.69							
CH 11	2462	<b>11.83</b>							

WLAN 2.4GHz 802.11n-HT40 Average Power (dBm)									
Power vs. Channel			Power vs. MCS Index						
Channel	Frequency (MHz)	MCS Index	MCS1	MCS2	MCS3	MCS4	MCS5	MCS6	MCS7
		MCS0							
CH 3	2422	9.43	11.65	11.71	11.83	11.58	11.65	11.71	11.85
CH 6	2437	<b>11.87</b>							
CH 9	2452	9.96							

### 13. Bluetooth Exclusions Applied

Mode Band	Average power(dBm)	
	Bluetooth v3.0+EDR	Bluetooth v4.0 LE
2.4GHz Bluetooth	4.0	-3.5

**Note:**

1. Per KDB 447498 D01v05r02, the 1-g and 10-g SAR test exclusion thresholds for 100 MHz to 6 GHz at *test separation distances* ≤ 50 mm are determined by:

$[(\text{max. power of channel, including tune-up tolerance, mW}) / (\text{min. test separation distance, mm})] \cdot [\sqrt{f(\text{GHz})}] \leq 3.0$  for 1-g SAR and ≤ 7.5 for 10-g extremity SAR

- f(GHz) is the RF channel transmit frequency in GHz
- Power and distance are rounded to the nearest mW and mm before calculation
- The result is rounded to one decimal place for comparison

Bluetooth Max Power (dBm)	Separation Distance (mm)	Frequency (GHz)	exclusion thresholds
4.0	< 5	2.48	0.9

**Note:**

Per KDB 447498 D01v05r02, when the minimum test separation distance is < 5 mm, a distance of 5 mm is applied to determine SAR test exclusion. The test exclusion threshold is 0.9 which is ≤ 3, SAR testing is not required.

### 14. Antenna Location

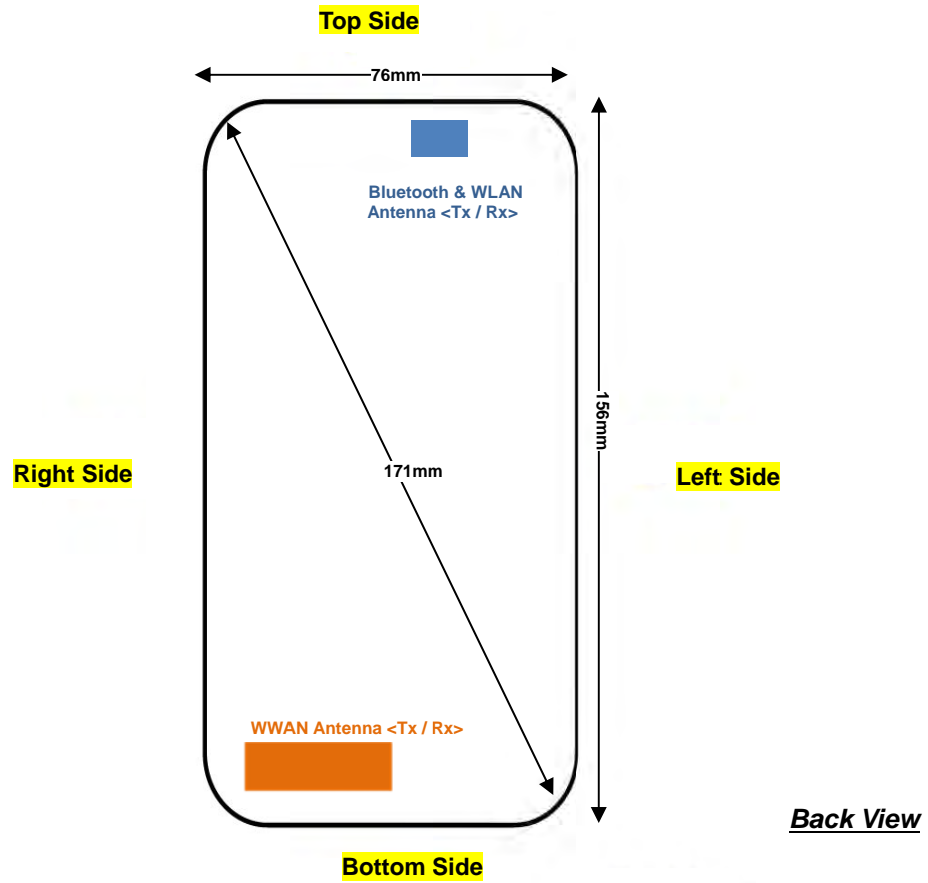

Distance of the Antenna to the EUT surface/edge						
Antennas	Back	Front	Top Side	Bottom Side	Right Side	Left Side
WWAN	≤ 25mm	≤ 25mm	144mm	≤ 25mm	≤ 25mm	46mm
BT&WLAN	≤ 25mm	≤ 25mm	≤ 25mm	148mm	40mm	≤ 25mm

Positions for SAR tests; Hotspot mode						
Antennas	Back	Front	Top Side	Bottom Side	Right Side	Left Side
WWAN	Yes	Yes	No	Yes	Yes	No
BT&WLAN	Yes	Yes	Yes	No	No	Yes

**General Note:** Referring to KDB 941225 D06 v02, when the overall device length and width are ≥ 9cm\*5cm, the test distance is 10 mm. SAR must be measured for all sides and surfaces with a transmitting antenna located within 25mm from that surface or edge

## 15. SAR Test Results

### General Note:

1. Per KDB 447498 D01v05r02, the reported SAR is the measured SAR value adjusted for maximum tune-up tolerance.
  - a. Tune-up scaling Factor = tune-up limit power (mW) / EUT RF power (mW), where tune-up limit is the maximum rated power among all production units.
  - b. Reported SAR(W/kg)= Measured SAR(W/kg)\*Tune-up Scaling Factor
2. Per KDB 447498 D01v05r02, for each exposure position, testing of other required channels within the operating mode of a frequency band is not required when the *reported* 1-g or 10-g SAR for the mid-band or highest output power channel is:
  - $\leq 0.8$  W/kg or 2.0 W/kg, for 1-g or 10-g respectively, when the transmission band is  $\leq 100$  MHz
  - $\leq 0.6$  W/kg or 1.5 W/kg, for 1-g or 10-g respectively, when the transmission band is between 100 MHz and 200 MHz
  - $\leq 0.4$  W/kg or 1.0 W/kg, for 1-g or 10-g respectively, when the transmission band is  $\geq 200$  MHz
3. Per KDB 941225 D01v03, considering the possibility of e.g. 3rd party VoIP operation for Head and body-worn SAR test reduction for GSM and GPRS and EDGE modes is determined by the source-based time-averaged output power including tune-up tolerance. The mode with highest specified time-averaged output power should be tested for SAR compliance in the applicable exposure conditions. For modes with the same specified maximum output power and tolerance, the higher number time-slot configuration should be tested. Therefore, the EUT was set in GPRS (2Tx slots) for GSM850, GPRS (4Tx slots) for GSM1900.
4. Per KDB 941225 D01v03, for Hotspot SAR test reduction for GPRS and EDGE modes is determined by the source-based time-averaged output power including tune-up tolerance, for modes with the same specified maximum output power and tolerance, the higher number time-slot configuration should be tested, therefore, the EUT was set in GPRS (2Tx slots) for GSM850, GPRS (4Tx slots) for GSM1900.
5. Per KDB 648474 D04v01r02, when the reported SAR for a body-worn accessory measured without a headset connected to the handset is  $\leq 1.2$  W/kg, SAR testing with a headset connected to the handset is not required.
6. Per KDB 941225 D01v03, SAR for next to the ear head / Hotspot / Body-worn exposure is measured using a 12.2 kbps RMC with TPC bits configured to all "1's".
7. Per KDB 941225 D01v03, RMC 12.2kbps setting is used to evaluate SAR. If the maximum output power and tune-up tolerance specified for production units in HSDPA / HSUPA is  $\leq \frac{1}{4}$  dB higher than RMC 12.2Kbps or when the highest reported SAR of the RMC12.2Kbps is scaled by the ratio of specified maximum output power and tune-up tolerance of HSDPA / HSUPA to RMC12.2Kbps and the adjusted SAR is  $\leq 1.2$  W/kg, SAR measurement is not required for HSDPA / HSUPA.
8. This device 2.4GHz WLAN supports Hotspot operation.
9. When hotspot mode applies, 10-g extremity SAR is required only for the surfaces and edges with hotspot mode 1-g SAR  $> 1.2$  W/kg, and the limit for extremity SAR is 4.0W/kg as averaged over any 10 gram of tissue.

**15.1 Head SAR**

**<GSM SAR>**

Plot No.	Band	Mode	Test Position	Ch.	Freq. (MHz)	Average Power (dBm)	Tune-Up Limit (dBm)	Tune-up Scaling Factor	Power Drift (dB)	Measured 1g SAR (W/kg)	Reported 1g SAR (W/kg)
#01	GSM850	GPRS (GMSK 2 Tx slots)	Right Cheek	128	824.2	33.23	33.50	1.064	0.09	0.595	<b>0.633</b>
	GSM850	GPRS (GMSK 2 Tx slots)	Right Tilted	128	824.2	33.23	33.50	1.064	0.17	0.400	0.426
	GSM850	GPRS (GMSK 2 Tx slots)	Left Cheek	128	824.2	33.23	33.50	1.064	0.06	0.591	0.629
	GSM850	GPRS (GMSK 2 Tx slots)	Left Tilted	128	824.2	33.23	33.50	1.064	0.05	0.218	0.232
	GSM1900	GPRS (GMSK 4 Tx slots)	Right Cheek	810	1909.8	27.24	27.50	1.062	-0.07	0.208	0.221
	GSM1900	GPRS (GMSK 4 Tx slots)	Right Tilted	810	1909.8	27.24	27.50	1.062	-0.08	0.290	0.308
#02	GSM1900	GPRS (GMSK 4 Tx slots)	Left Cheek	810	1909.8	27.24	27.50	1.062	0.02	0.357	<b>0.379</b>
	GSM1900	GPRS (GMSK 4 Tx slots)	Left Tilted	810	1909.8	27.24	27.50	1.062	0.01	0.169	0.179

**<WCDMA SAR>**

Plot No.	Band	Mode	Test Position	Ch.	Freq. (MHz)	Average Power (dBm)	Tune-Up Limit (dBm)	Tune-up Scaling Factor	Power Drift (dB)	Measured 1g SAR (W/kg)	Reported 1g SAR (W/kg)
#03	WCDMA Band V	RMC 12.2K	Right Cheek	4132	826.4	24.17	24.50	1.079	0.01	0.335	<b>0.361</b>
	WCDMA Band V	RMC 12.2K	Right Tilted	4132	826.4	24.17	24.50	1.079	-0.01	0.231	0.249
	WCDMA Band V	RMC 12.2K	Left Cheek	4132	826.4	24.17	24.50	1.079	0.08	0.327	0.353
	WCDMA Band V	RMC 12.2K	Left Tilted	4132	826.4	24.17	24.50	1.079	0.09	0.212	0.229
	WCDMA Band IV	RMC 12.2K	Right Cheek	1312	1712.4	22.38	22.50	1.028	-0.03	0.136	0.140
	WCDMA Band IV	RMC 12.2K	Right Tilted	1312	1712.4	22.38	22.50	1.028	-0.03	0.110	0.113
#04	WCDMA Band IV	RMC 12.2K	Left Cheek	1312	1712.4	22.38	22.50	1.028	0.12	0.265	<b>0.272</b>
	WCDMA Band IV	RMC 12.2K	Left Tilted	1312	1712.4	22.38	22.50	1.028	0.17	0.106	0.109
	WCDMA Band II	RMC 12.2K	Right Cheek	9262	1852.4	23.92	24.00	1.019	-0.18	0.206	0.210
	WCDMA Band II	RMC 12.2K	Right Tilted	9262	1852.4	23.92	24.00	1.019	-0.19	0.314	0.320
#05	WCDMA Band II	RMC 12.2K	Left Cheek	9262	1852.4	23.92	24.00	1.019	0.05	0.375	<b>0.382</b>
	WCDMA Band II	RMC 12.2K	Left Tilted	9262	1852.4	23.92	24.00	1.019	0.05	0.178	0.181

**<DTS WLAN SAR>**

Plot No.	Band	Mode	Test Position	Ch.	Freq. (MHz)	Average Power (dBm)	Tune-Up Limit (dBm)	Tune-up Scaling Factor	Power Drift (dB)	Measured 1g SAR (W/kg)	Reported 1g SAR (W/kg)
#06	WLAN 2.4GHz	802.11b 1Mbps	Right Cheek	11	2462	12.84	13.00	1.038	-0.01	0.735	0.763
	WLAN 2.4GHz	802.11b 1Mbps	Right Tilted	11	2462	12.84	13.00	1.038	0.16	0.751	<b>0.779</b>
	WLAN 2.4GHz	802.11b 1Mbps	Left Cheek	11	2462	12.84	13.00	1.038	-0.01	0.607	0.630
	WLAN 2.4GHz	802.11b 1Mbps	Left Tilted	11	2462	12.84	13.00	1.038	-0.13	0.626	0.649

**15.2 Hotspot SAR**

Distance of the Antenna to the EUT surface/edge						
Antennas	Back	Front	Top Side	Bottom Side	Right Side	Left Side
WWAN	≤ 25mm	≤ 25mm	144mm	≤ 25mm	≤ 25mm	46mm
BT&WLAN	≤ 25mm	≤ 25mm	≤ 25mm	148mm	40mm	≤ 25mm

Positions for SAR tests; Hotspot mode						
Antennas	Back	Front	Top Side	Bottom Side	Right Side	Left Side
WWAN	Yes	Yes	No	Yes	Yes	No
BT&WLAN	Yes	Yes	Yes	No	No	Yes

**General Note:** Referring to KDB 941225 D06 v02, when the overall device length and width are ≥ 9cm\*5cm, the test distance is 10 mm. SAR must be measured for all sides and surfaces with a transmitting antenna located within 25mm from that surface or edge

**<GSM SAR>**

Plot No.	Band	Mode	Test Position	Gap (cm)	Ch.	Freq. (MHz)	Average Power (dBm)	Tune-Up Limit (dBm)	Tune-up Scaling Factor	Power Drift (dB)	Measured 1g SAR (W/kg)	Reported 1g SAR (W/kg)
	GSM850	GPRS (GMSK 2 Tx slots)	Front	1	128	824.2	33.23	33.50	1.064	0.02	0.692	0.736
	GSM850	GPRS (GMSK 2 Tx slots)	Back	1	128	824.2	33.23	33.50	1.064	-0.01	0.888	0.945
	GSM850	GPRS (GMSK 2 Tx slots)	Right side	1	128	824.2	33.23	33.50	1.064	-0.01	0.744	0.792
	GSM850	GPRS (GMSK 2 Tx slots)	Bottom side	1	128	824.2	33.23	33.50	1.064	0.06	0.581	0.618
#07	GSM850	GPRS (GMSK 2 Tx slots)	Back	1	189	836.4	33.02	33.50	1.117	-0.01	0.882	<b>0.985</b>
	GSM850	GPRS (GMSK 2 Tx slots)	Back	1	251	848.8	33.00	33.50	1.122	0.01	0.839	0.941
	GSM1900	GPRS (GMSK 4 Tx slots)	Front	1	810	1909.8	27.24	27.50	1.062	-0.02	0.786	0.834
	GSM1900	GPRS (GMSK 4 Tx slots)	Back	1	810	1909.8	27.24	27.50	1.062	-0.04	0.969	1.029
	GSM1900	GPRS (GMSK 4 Tx slots)	Right side	1	810	1909.8	27.24	27.50	1.062	-0.03	0.297	0.315
	GSM1900	GPRS (GMSK 4 Tx slots)	Bottom side	1	810	1909.8	27.24	27.50	1.062	0.08	1.130	1.200
	GSM1900	GPRS (GMSK 4 Tx slots)	Front	1	512	1850.2	26.92	27.50	1.143	0.05	0.810	0.926
	GSM1900	GPRS (GMSK 4 Tx slots)	Front	1	661	1880	26.86	27.50	1.159	-0.01	0.775	0.898
	GSM1900	GPRS (GMSK 4 Tx slots)	Back	1	512	1850.2	26.92	27.50	1.143	-0.01	0.961	1.098
	GSM1900	GPRS (GMSK 4 Tx slots)	Back	1	661	1880	26.86	27.50	1.159	-0.08	0.922	1.068
#08	GSM1900	GPRS (GMSK 4 Tx slots)	Bottom side	1	512	1850.2	26.92	27.50	1.143	0.12	1.150	<b>1.314</b>
	GSM1900	GPRS (GMSK 4 Tx slots)	Bottom side	1	661	1880	26.86	27.50	1.159	0.15	1.090	1.263





**<WCDMA SAR>**

Plot No.	Band	Mode	Test Position	Gap (cm)	Ch.	Freq. (MHz)	Average Power (dBm)	Tune-Up Limit (dBm)	Tune-up Scaling Factor	Power Drift (dB)	Measured 1g SAR (W/kg)	Reported 1g SAR (W/kg)
	WCDMA Band V	RMC 12.2K	Front	1	4132	826.4	24.17	24.50	1.079	0.02	0.399	0.430
#09	WCDMA Band V	RMC 12.2K	Back	1	4132	826.4	24.17	24.50	1.079	-0.01	0.510	<b>0.550</b>
	WCDMA Band V	RMC 12.2K	Right side	1	4132	826.4	24.17	24.50	1.079	0.02	0.455	0.491
	WCDMA Band V	RMC 12.2K	Bottom side	1	4132	826.4	24.17	24.50	1.079	0.03	0.340	0.367
	WCDMA Band IV	RMC 12.2K	Front	1	1312	1712.4	22.38	22.50	1.028	0.1	0.809	0.832
	WCDMA Band IV	RMC 12.2K	Back	1	1312	1712.4	22.38	22.50	1.028	0.17	0.873	0.897
	WCDMA Band IV	RMC 12.2K	Right side	1	1312	1712.4	22.38	22.50	1.028	0.08	0.167	0.172
	WCDMA Band IV	RMC 12.2K	Bottom side	1	1312	1712.4	22.38	22.50	1.028	0.15	0.939	0.965
	WCDMA Band IV	RMC 12.2K	Front	1	1413	1732.6	22.27	22.50	1.054	0.08	1.020	1.075
	WCDMA Band IV	RMC 12.2K	Front	1	1513	1752.6	22.36	22.50	1.033	0.04	0.918	0.948
	WCDMA Band IV	RMC 12.2K	Back	1	1413	1732.6	22.27	22.50	1.054	0.04	1.080	1.139
	WCDMA Band IV	RMC 12.2K	Back	1	1513	1752.6	22.36	22.50	1.033	-0.01	0.985	1.017
#10	WCDMA Band IV	RMC 12.2K	Bottom side	1	1413	1732.6	22.27	22.50	1.054	0.06	1.200	<b>1.265</b>
	WCDMA Band IV	RMC 12.2K	Bottom side	1	1513	1752.6	22.36	22.50	1.033	0.07	1.070	1.105
	WCDMA Band II	RMC 12.2K	Front	1	9262	1852.4	23.92	24.00	1.019	0.02	0.974	0.992
	WCDMA Band II	RMC 12.2K	Back	1	9262	1852.4	23.92	24.00	1.019	0.01	1.080	1.100
	WCDMA Band II	RMC 12.2K	Right side	1	9262	1852.4	23.92	24.00	1.019	0.09	0.360	0.367
#11	WCDMA Band II	RMC 12.2K	Bottom side	1	9262	1852.4	23.92	24.00	1.019	0.09	1.220	<b>1.243</b>
	WCDMA Band II	RMC 12.2K	Front	1	9400	1880	23.65	24.00	1.084	0.06	0.775	0.840
	WCDMA Band II	RMC 12.2K	Front	1	9538	1907.6	23.46	24.00	1.132	0.03	0.733	0.830
	WCDMA Band II	RMC 12.2K	Back	1	9400	1880	23.65	24.00	1.084	0.05	0.861	0.933
	WCDMA Band II	RMC 12.2K	Back	1	9538	1907.6	23.46	24.00	1.132	0.01	0.862	0.976
	WCDMA Band II	RMC 12.2K	Bottom side	1	9400	1880	23.65	24.00	1.084	0.01	0.908	0.984
	WCDMA Band II	RMC 12.2K	Bottom side	1	9538	1907.6	23.46	24.00	1.132	0.1	0.944	1.069

**<DTS WLAN SAR>**

Plot No.	Band	Mode	Test Position	Gap (cm)	Ch.	Freq. (MHz)	Average Power (dBm)	Tune-Up Limit (dBm)	Tune-up Scaling Factor	Power Drift (dB)	Measured 1g SAR (W/kg)	Reported 1g SAR (W/kg)
	WLAN 2.4GHz	802.11b 1Mbps	Front	1	11	2462	12.84	13.00	1.038	-0.07	0.172	0.178
	WLAN 2.4GHz	802.11b 1Mbps	Back	1	11	2462	12.84	13.00	1.038	0.08	0.299	0.310
	WLAN 2.4GHz	802.11b 1Mbps	Left side	1	11	2462	12.84	13.00	1.038	0.19	0.035	0.036
#12	WLAN 2.4GHz	802.11b 1Mbps	Top side	1	11	2462	12.84	13.00	1.038	0.09	0.325	<b>0.337</b>

**15.3 Body Worn Accessory SAR**
**<GSM SAR>**

Plot No.	Band	Mode	Test Position	Gap (cm)	Ch.	Freq. (MHz)	Average Power (dBm)	Tune-Up Limit (dBm)	Tune-up Scaling Factor	Power Drift (dB)	Measured 1g SAR (W/kg)	Reported 1g SAR (W/kg)
	GSM850	GPRS (GMSK 2 Tx slots)	Front	1	128	824.2	33.23	33.50	1.064	0.02	0.692	0.736
	GSM850	GPRS (GMSK 2 Tx slots)	Back	1	128	824.2	33.23	33.50	1.064	-0.01	0.888	0.945
#07	GSM850	GPRS (GMSK 2 Tx slots)	Back	1	189	836.4	33.02	33.50	1.117	-0.01	0.882	<b>0.985</b>
	GSM850	GPRS (GMSK 2 Tx slots)	Back	1	251	848.8	33.00	33.50	1.122	0.01	0.839	0.941
	GSM1900	GPRS (GMSK 4 Tx slots)	Front	1	810	1909.8	27.24	27.50	1.062	-0.02	0.786	0.834
	GSM1900	GPRS (GMSK 4 Tx slots)	Back	1	810	1909.8	27.24	27.50	1.062	-0.04	0.969	1.029
	GSM1900	GPRS (GMSK 4 Tx slots)	Front	1	512	1850.2	26.92	27.50	1.143	0.05	0.810	0.926
	GSM1900	GPRS (GMSK 4 Tx slots)	Front	1	661	1880	26.86	27.50	1.159	-0.01	0.775	0.898
#13	GSM1900	GPRS (GMSK 4 Tx slots)	Back	1	512	1850.2	26.92	27.50	1.143	-0.01	0.961	<b>1.098</b>
	GSM1900	GPRS (GMSK 4 Tx slots)	Back	1	661	1880	26.86	27.50	1.159	-0.08	0.922	1.068

**<WCDMA SAR>**

Plot No.	Band	Mode	Test Position	Gap (cm)	Ch.	Freq. (MHz)	Average Power (dBm)	Tune-Up Limit (dBm)	Tune-up Scaling Factor	Power Drift (dB)	Measured 1g SAR (W/kg)	Reported 1g SAR (W/kg)
	WCDMA Band V	RMC 12.2K	Front	1	4132	826.4	24.17	24.50	1.079	0.02	0.399	0.430
#09	WCDMA Band V	RMC 12.2K	Back	1	4132	826.4	24.17	24.50	1.079	-0.01	0.510	<b>0.550</b>
	WCDMA Band IV	RMC 12.2K	Front	1	1312	1712.4	22.38	22.50	1.028	0.1	0.809	0.832
	WCDMA Band IV	RMC 12.2K	Back	1	1312	1712.4	22.38	22.50	1.028	0.17	0.873	0.897
	WCDMA Band IV	RMC 12.2K	Front	1	1413	1732.6	22.27	22.50	1.054	0.08	1.020	1.075
	WCDMA Band IV	RMC 12.2K	Front	1	1513	1752.6	22.36	22.50	1.033	0.04	0.918	0.948
#14	WCDMA Band IV	RMC 12.2K	Back	1	1413	1732.6	22.27	22.50	1.054	0.04	1.080	<b>1.139</b>
	WCDMA Band IV	RMC 12.2K	Back	1	1513	1752.6	22.36	22.50	1.033	-0.01	0.985	1.017
	WCDMA Band II	RMC 12.2K	Front	1	9262	1852.4	23.92	24.00	1.019	0.02	0.974	0.992
#15	WCDMA Band II	RMC 12.2K	Back	1	9262	1852.4	23.92	24.00	1.019	0.01	1.080	<b>1.100</b>
	WCDMA Band II	RMC 12.2K	Front	1	9400	1880	23.65	24.00	1.084	0.06	0.775	0.840
	WCDMA Band II	RMC 12.2K	Front	1	9538	1907.6	23.46	24.00	1.132	0.03	0.733	0.830
	WCDMA Band II	RMC 12.2K	Back	1	9400	1880	23.65	24.00	1.084	0.05	0.861	0.933
	WCDMA Band II	RMC 12.2K	Back	1	9538	1907.6	23.46	24.00	1.132	0.01	0.862	0.976

**<DTS WLAN SAR>**

Plot No.	Band	Mode	Test Position	Gap (cm)	Ch.	Freq. (MHz)	Average Power (dBm)	Tune-Up Limit (dBm)	Tune-up Scaling Factor	Power Drift (dB)	Measured 1g SAR (W/kg)	Reported 1g SAR (W/kg)
	WLAN 2.4GHz	802.11b 1Mbps	Front	1	11	2462	12.84	13.00	1.038	-0.07	0.172	0.178
#16	WLAN 2.4GHz	802.11b 1Mbps	Back	1	11	2462	12.84	13.00	1.038	0.08	0.299	<b>0.310</b>

**15.4 Extremity SAR****<GSM SAR>**

Plot No.	Band	Mode	Test Position	Gap (cm)	Ch.	Freq. (MHz)	Average Power (dBm)	Tune-Up Limit (dBm)	Tune-up Scaling Factor	Power Drift (dB)	Measured 10g SAR (W/kg)	Reported 10g SAR (W/kg)
#17	GSM1900	GPRS (GMSK 4 Tx slots)	Bottom side	0	512	1850.2	26.92	27.50	1.143	0.02	2.61	<b>2.983</b>
	GSM1900	GPRS (GMSK 4 Tx slots)	Bottom side	0	661	1880	26.86	27.50	1.159	0.17	2.47	2.862
	GSM1900	GPRS (GMSK 4 Tx slots)	Bottom side	0	810	1909.8	27.24	27.50	1.062	0.02	2.67	2.835

**<WCDMA SAR>**

Plot No.	Band	Mode	Test Position	Gap (cm)	Ch.	Freq. (MHz)	Average Power (dBm)	Tune-Up Limit (dBm)	Tune-up Scaling Factor	Power Drift (dB)	Measured 10g SAR (W/kg)	Reported 10g SAR (W/kg)
#18	WCDMA Band IV	RMC 12.2K	Bottom side	0	1413	1732.6	22.27	22.50	1.054	0.16	2.47	<b>2.604</b>
	WCDMA Band IV	RMC 12.2K	Bottom side	0	1312	1712.4	22.38	22.50	1.028	0.15	1.99	2.046
	WCDMA Band IV	RMC 12.2K	Bottom side	0	1513	1752.6	22.36	22.50	1.033	0.16	2.21	2.282
#19	WCDMA Band II	RMC 12.2K	Bottom side	0	9262	1852.4	23.92	24.00	1.019	0.15	3.42	<b>3.484</b>
	WCDMA Band II	RMC 12.2K	Bottom side	0	9400	1880	23.65	24.00	1.084	0.04	2.46	2.666
	WCDMA Band II	RMC 12.2K	Bottom side	0	9538	1907.6	23.46	24.00	1.132	0.16	2.81	3.182

**15.5 Repeated SAR Measurement**

No.	Band	Mode	Test Position	Gap (cm)	Ch.	Freq. (MHz)	Average Power (dBm)	Tune-Up Limit (dBm)	Tune-up Scaling Factor	Power Drift (dB)	Measured 1g SAR (W/kg)	Ratio	Reported 1g SAR (W/kg)
1st	GSM850	GPRS(GMSK 2 Tx slots)	Back	1	128	824.2	33.23	33.50	1.064	-0.01	0.888	1	0.945
2nd	GSM850	GPRS (GMSK 2 Tx slots)	Back	1	128	824.2	33.23	33.50	1.064	0.02	0.877	1.013	0.933
1st	WCDMA Band IV	RMC 12.2K	Bottom side	1	1413	1732.6	22.27	22.50	1.054	0.06	1.200	1	1.265
2nd	WCDMA Band IV	RMC 12.2K	Bottom side	1	1413	1732.6	22.27	22.50	1.054	0.04	1.190	1.008	1.255
1st	WCDMA Band II	RMC 12.2K	Bottom side	1	9262	1852.4	23.92	24.00	1.019	0.09	1.220	1	1.243
2nd	WCDMA Band II	RMC 12.2K	Bottom side	1	9262	1852.4	23.92	24.00	1.019	0.1	1.210	1.008	1.232

No.	Band	Mode	Test Position	Gap (cm)	Ch.	Freq. (MHz)	Average Power (dBm)	Tune-Up Limit (dBm)	Tune-up Scaling Factor	Power Drift (dB)	Measured 10g SAR (W/kg)	Ratio	Reported 10g SAR (W/kg)
1st	WCDMA Band IV	RMC 12.2K	Bottom side	0	1413	1732.6	22.27	22.50	1.054	0.16	2.47	1	2.604
2nd	WCDMA Band IV	RMC 12.2K	Bottom side	0	1413	1732.6	22.27	22.50	1.054	0.14	2.45	1.008	2.583
1st	WCDMA Band II	RMC 12.2K	Bottom side	0	9262	1852.4	23.92	24.00	1.019	0.15	3.42	1	3.484
2nd	WCDMA Band II	RMC 12.2K	Bottom side	0	9262	1852.4	23.92	24.00	1.019	0.04	3.31	1.033	3.372

**General Note:**

1. Per KDB 865664 D01v01r03, for each frequency band, repeated SAR measurement is required only when the measured SAR is  $\geq 0.8\text{W/kg}$  for 1g SAR and  $\geq 2.0\text{W/kg}$  for 10g SAR.
2. Per KDB 865664 D01v01r03, if the ratio among the repeated measurement is  $\leq 1.2$  and the measured SAR  $< 1.45\text{W/kg}$  for 1g SAR,  $< 3.625\text{W/kg}$  for 10g SAR, only one repeated measurement is required.
3. The ratio is the difference in percentage between original and repeated *measured SAR*.
4. All measurement SAR result is scaled-up to account for tune-up tolerance and is compliant.

## 16. Simultaneous Transmission Analysis

NO	Simultaneous Transmission Configurations	Smart phone			Note
		Head	Body-worn	Hotspot	
1.	GSM(Voice) + WLAN2.4GHz(data)	Yes	Yes		
2.	WCDMA(Voice) + WLAN2.4GHz(data)	Yes	Yes		
3.	GSM(Voice) + Bluetooth(data)	Yes	Yes		
4.	WCDMA((Voice) + Bluetooth(data)	Yes	Yes		
5.	GPRS/EDGE(Data) + WLAN2.4GHz(data)	Yes	Yes	Yes	2.4GHz Hotspot
6.	WCDMA(Data) + WLAN2.4GHz(data)	Yes	Yes	Yes	2.4GHz Hotspot
7.	GPRS/EDGE(Data) + Bluetooth(data)	Yes	Yes	Yes	Bluetooth Tethering
8.	WCDMA(Data) + Bluetooth(data)	Yes	Yes	Yes	Bluetooth Tethering

**General Note:**

- This device supported VoIP in GPRS, EGPRS, WCDMA (e.g. 3rd party VoIP).
- This device 2.4GHz WLAN supports Hotspot operation.
- WLAN and Bluetooth share the same antenna, and cannot transmit simultaneously.
- EUT will choose each GSM or WCDMA according to the network signal condition; therefore, they will not operate simultaneously at any moment.
- The Reported SAR summation is calculated based on the same configuration and test position.
- Per KDB 447498 D01v05r02, simultaneous transmission SAR is compliant if,
  - Scalar SAR summation < 1.6W/kg.
  - $SPLSR = (SAR1 + SAR2)^{1.5} / (\text{min. separation distance, mm})$ , and the peak separation distance is determined from the square root of  $[(x1-x2)^2 + (y1-y2)^2 + (z1-z2)^2]$ , where (x1, y1, z1) and (x2, y2, z2) are the coordinates of the extrapolated peak SAR locations in the zoom scan.
  - If  $SPLSR \leq 0.04$ , simultaneously transmission SAR measurement is not necessary.
  - Simultaneously transmission SAR measurement, and the reported multi-band SAR < 1.6W/kg.
- For simultaneous transmission analysis, Bluetooth SAR is estimated per KDB 447498 D01v05r02 based on the formula below.
  - $(\text{max. power of channel, including tune-up tolerance, mW}) / (\text{min. test separation distance, mm}) \cdot [\sqrt{f(\text{GHz})/x}] \text{ W/kg}$  for test separation distances  $\leq 50 \text{ mm}$ ; where  $x = 7.5$  for 1-g SAR, and  $x = 18.75$  for 10-g SAR.
  - When the minimum separation distance is < 5mm, the distance is used 5mm to determine SAR test exclusion.
  - 0.4 W/kg for 1-g SAR and 1.0 W/kg for 10-g SAR, when the test separation distances is > 50 mm.

Bluetooth Max Power	Exposure Position	Head	Hotspot	Body worn
	Test separation	0 mm	10 mm	10 mm
4.0 dBm	Estimated SAR (W/kg)	0.126 W/kg	0.063 W/kg	0.063 W/kg

**16.1 Head Exposure Conditions**

<WWAN + WLAN>

WWAN Band		Exposure Position	WWAN PCE	WLAN DTS	Summed SAR (W/kg)	SPLSR	Case No
			Max. WWAN SAR (W/kg)	Max. WLAN SAR (W/kg)			
GSM	GSM850	Right Cheek	0.633	0.763	1.40		
		Right Tilted	0.426	0.779	1.21		
		Left Cheek	0.629	0.630	1.26		
		Left Tilted	0.232	0.649	0.88		
	GSM1900	Right Cheek	0.221	0.763	0.98		
		Right Tilted	0.308	0.779	1.09		
		Left Cheek	0.379	0.630	1.01		
		Left Tilted	0.179	0.649	0.83		
WCDMA	Band V	Right Cheek	0.361	0.763	1.12		
		Right Tilted	0.249	0.779	1.03		
		Left Cheek	0.353	0.630	0.98		
		Left Tilted	0.229	0.649	0.88		
	Band IV	Right Cheek	0.140	0.763	0.90		
		Right Tilted	0.113	0.779	0.89		
		Left Cheek	0.272	0.630	0.90		
		Left Tilted	0.109	0.649	0.76		
	Band II	Right Cheek	0.210	0.763	0.97		
		Right Tilted	0.320	0.779	1.10		
		Left Cheek	0.382	0.630	1.01		
		Left Tilted	0.181	0.649	0.83		



**<WWAN + Bluetooth>**

WWAN Band		Exposure Position	WWAN PCE	Bluetooth DSS	Summed SAR (W/kg)	SPLSR	Case No
			Max. WWAN SAR (W/kg)	Estimated SAR (W/kg)			
GSM	GSM850	Right Cheek	0.633	0.126	0.76		
		Right Tilted	0.426	0.126	0.55		
		Left Cheek	0.629	0.126	0.76		
		Left Tilted	0.232	0.126	0.36		
	GSM1900	Right Cheek	0.221	0.126	0.35		
		Right Tilted	0.308	0.126	0.43		
		Left Cheek	0.379	0.126	0.51		
		Left Tilted	0.179	0.126	0.31		
WCDMA	Band V	Right Cheek	0.361	0.126	0.49		
		Right Tilted	0.249	0.126	0.38		
		Left Cheek	0.353	0.126	0.48		
		Left Tilted	0.229	0.126	0.36		
	Band IV	Right Cheek	0.140	0.126	0.27		
		Right Tilted	0.113	0.126	0.24		
		Left Cheek	0.272	0.126	0.40		
		Left Tilted	0.109	0.126	0.24		
	Band II	Right Cheek	0.210	0.126	0.34		
		Right Tilted	0.320	0.126	0.45		
		Left Cheek	0.382	0.126	0.51		
		Left Tilted	0.181	0.126	0.31		

**16.2 Hotspot Exposure Conditions**

<WWAN + WLAN>

WWAN Band		Exposure Position	WWAN PCE	WLAN DTS	Summed SAR (W/kg)	SPLSR	Case No
			Max. WWAN SAR (W/kg)	Max. WLAN SAR (W/kg)			
GSM	GSM850	Front	0.736	0.178	0.91		
		Back	0.985	0.310	1.30		
		Left side		0.036	0.04		
		Right side	0.792		0.79		
		Top side		0.337	0.34		
		Bottom side	0.618		0.62		
	GSM1900	Front	0.926	0.178	1.10		
		Back	1.098	0.310	1.41		
		Left side		0.036	0.04		
		Right side	0.315		0.32		
		Top side		0.337	0.34		
		Bottom side	1.314		1.31		
WCDMA	Band V	Front	0.430	0.178	0.61		
		Back	0.550	0.310	0.86		
		Left side		0.036	0.04		
		Right side	0.491		0.49		
		Top side		0.337	0.34		
		Bottom side	0.367		0.37		
	Band IV	Front	1.075	0.178	1.25		
		Back	1.139	0.310	<b>1.45</b>		
		Left side		0.036	0.04		
		Right side	0.172		0.17		
		Top side		0.337	0.34		
		Bottom side	1.265		1.27		
	Band II	Front	0.992	0.178	1.17		
		Back	1.100	0.310	1.41		
		Left side		0.036	0.04		
		Right side	0.367		0.37		
		Top side		0.337	0.34		
		Bottom side	1.243		1.24		





**<WWAN + Bluetooth>**

WWAN Band		Exposure Position	WWAN PCE	Bluetooth DSS	Summed SAR (W/kg)	SPLSR	Case No
			Max. WWAN SAR (W/kg)	Estimated SAR (W/kg)			
GSM	GSM850	Front	0.736	0.063	0.80		
		Back	0.985	0.063	1.05		
		Left side		0.063	0.06		
		Right side	0.792		0.79		
		Top side		0.063	0.06		
		Bottom side	0.618		0.62		
	GSM1900	Front	0.926	0.063	0.99		
		Back	1.098	0.063	1.16		
		Left side		0.063	0.06		
		Right side	0.315		0.32		
		Top side		0.063	0.06		
		Bottom side	1.314		1.31		
WCDMA	Band V	Front	0.430	0.063	0.49		
		Back	0.550	0.063	0.61		
		Left side		0.063	0.06		
		Right side	0.491		0.49		
		Top side		0.063	0.06		
		Bottom side	0.367		0.37		
	Band IV	Front	1.075	0.063	1.14		
		Back	1.139	0.063	1.20		
		Left side		0.063	0.06		
		Right side	0.172		0.17		
		Top side		0.063	0.06		
		Bottom side	1.265		1.27		
	Band II	Front	0.992	0.063	1.06		
		Back	1.100	0.063	1.16		
		Left side		0.063	0.06		
		Right side	0.367		0.37		
		Top side		0.063	0.06		
		Bottom side	1.243		1.24		

**16.3 Body-Worn Accessory Exposure Conditions**

**< WWAN + WLAN >**

WWAN Band		Exposure Position	WWAN PCE	WLAN DTS	Summed SAR (W/kg)	SPLSR	Case No
			Max. WWAN SAR (W/kg)	Max. WLAN SAR (W/kg)			
GSM	GSM850	Front	0.736	0.178	0.91		
		Back	0.985	0.310	1.30		
	GSM1900	Front	0.926	0.178	1.10		
		Back	1.098	0.310	1.41		
WCDMA	Band V	Front	0.430	0.178	0.61		
		Back	0.550	0.310	0.86		
	Band IV	Front	1.075	0.178	1.25		
		Back	1.139	0.310	1.45		
	Band II	Front	0.992	0.178	1.17		
		Back	1.100	0.310	1.41		

**< WWAN + Bluetooth >**

WWAN Band		Exposure Position	WWAN PCE	Bluetooth DSS	Summed SAR (W/kg)	SPLSR	Case No
			Max. WWAN SAR (W/kg)	Estimated SAR (W/kg)			
GSM	GSM850	Front	0.736	0.063	0.80		
		Back	0.985	0.063	1.05		
	GSM1900	Front	0.926	0.063	0.99		
		Back	1.098	0.063	1.16		
WCDMA	Band V	Front	0.430	0.063	0.49		
		Back	0.550	0.063	0.61		
	Band IV	Front	1.075	0.063	1.14		
		Back	1.139	0.063	1.20		
	Band II	Front	0.992	0.063	1.06		
		Back	1.100	0.063	1.16		

**Test Engineer : Kat Yin**

## 17. Uncertainty Assessment

The component of uncertainty may generally be categorized according to the methods used to evaluate them. The evaluation of uncertainty by the statistical analysis of a series of observations is termed a Type A evaluation of uncertainty. The evaluation of uncertainty by means other than the statistical analysis of a series of observation is termed a Type B evaluation of uncertainty. Each component of uncertainty, however evaluated, is represented by an estimated standard deviation, termed standard uncertainty, which is determined by the positive square root of the estimated variance.

A Type A evaluation of standard uncertainty may be based on any valid statistical method for treating data. This includes calculating the standard deviation of the mean of a series of independent observations; using the method of least squares to fit a curve to the data in order to estimate the parameter of the curve and their standard deviations; or carrying out an analysis of variance in order to identify and quantify random effects in certain kinds of measurement.

A type B evaluation of standard uncertainty is typically based on scientific judgment using all of the relevant information available. These may include previous measurement data, experience, and knowledge of the behavior and properties of relevant materials and instruments, manufacture’s specification, data provided in calibration reports and uncertainties assigned to reference data taken from handbooks. Broadly speaking, the uncertainty is either obtained from an outdoor source or obtained from an assumed distribution, such as the normal distribution, rectangular or triangular distributions indicated in table below.

Uncertainty Distributions	Normal	Rectangular	Triangular	U-Shape
Multi-plying Factor <sup>(a)</sup>	1/k <sup>(b)</sup>	1/√3	1/√6	1/√2

(a) standard uncertainty is determined as the product of the multiplying factor and the estimated range of variations in the measured quantity

(b)  $\kappa$  is the coverage factor

**Table 16.1. Standard Uncertainty for Assumed Distribution**

The combined standard uncertainty of the measurement result represents the estimated standard deviation of the result. It is obtained by combining the individual standard uncertainties of both Type A and Type B evaluation using the usual “root-sum-squares” (RSS) methods of combining standard deviations by taking the positive square root of the estimated variances.

Expanded uncertainty is a measure of uncertainty that defines an interval about the measurement result within which the measured value is confidently believed to lie. It is obtained by multiplying the combined standard uncertainty by a coverage factor. Typically, the coverage factor ranges from 2 to 3. Using a coverage factor allows the true value of a measured quantity to be specified with a defined probability within the specified uncertainty range. For purpose of this document, a coverage factor two is used, which corresponds to confidence interval of about 95 %. The DASY uncertainty Budget is shown in the following tables.

Error Description	Uncertainty Value (±%)	Probability Distribution	Divisor	Ci (1g)	Ci (10g)	Standard Uncertainty (1g)	Standard Uncertainty (10g)
<b>Measurement System</b>							
Probe Calibration	6.0	Normal	1	1	1	± 6.0 %	± 6.0 %
Axial Isotropy	4.7	Rectangular	√3	0.7	0.7	± 1.9 %	± 1.9 %
Hemispherical Isotropy	9.6	Rectangular	√3	0.7	0.7	± 3.9 %	± 3.9 %
Boundary Effects	1.0	Rectangular	√3	1	1	± 0.6 %	± 0.6 %
Linearity	4.7	Rectangular	√3	1	1	± 2.7 %	± 2.7 %
System Detection Limits	1.0	Rectangular	√3	1	1	± 0.6 %	± 0.6 %
Readout Electronics	0.3	Normal	1	1	1	± 0.3 %	± 0.3 %
Response Time	0.8	Rectangular	√3	1	1	± 0.5 %	± 0.5 %
Integration Time	2.6	Rectangular	√3	1	1	± 1.5 %	± 1.5 %
RF Ambient Noise	3.0	Rectangular	√3	1	1	± 1.7 %	± 1.7 %
RF Ambient Reflections	3.0	Rectangular	√3	1	1	± 1.7 %	± 1.7 %
Probe Positioner	0.4	Rectangular	√3	1	1	± 0.2 %	± 0.2 %
Probe Positioning	2.9	Rectangular	√3	1	1	± 1.7 %	± 1.7 %
Max. SAR Eval.	1.0	Rectangular	√3	1	1	± 0.6 %	± 0.6 %
<b>Test Sample Related</b>							
Device Positioning	2.9	Normal	1	1	1	± 2.9 %	± 2.9 %
Device Holder	3.6	Normal	1	1	1	± 3.6 %	± 3.6 %
Power Drift	5.0	Rectangular	√3	1	1	± 2.9 %	± 2.9 %
<b>Phantom and Setup</b>							
Phantom Uncertainty	4.0	Rectangular	√3	1	1	± 2.3 %	± 2.3 %
Liquid Conductivity (Target)	5.0	Rectangular	√3	0.64	0.43	± 1.8 %	± 1.2 %
Liquid Conductivity (Meas.)	2.5	Normal	1	0.64	0.43	± 1.6 %	± 1.1 %
Liquid Permittivity (Target)	5.0	Rectangular	√3	0.6	0.49	± 1.7 %	± 1.4 %
Liquid Permittivity (Meas.)	2.5	Normal	1	0.6	0.49	± 1.5 %	± 1.2 %
<b>Combined Standard Uncertainty</b>						± 11.0 %	± 10.8 %
<b>Coverage Factor for 95 %</b>						K=2	
<b>Expanded Uncertainty</b>						± 22.0 %	± 21.5 %

**Table 16.2. Uncertainty Budget for frequency range 300 MHz to 3 GHz**



## **18. References**

- [1] FCC 47 CFR Part 2 "Frequency Allocations and Radio Treaty Matters; General Rules and Regulations"
- [2] ANSI/IEEE Std. C95.1-1992, "IEEE Standard for Safety Levels with Respect to Human Exposure to Radio Frequency Electromagnetic Fields, 3 kHz to 300 GHz", September 1992
- [3] IEEE Std. 1528-2003, "Recommended Practice for Determining the Peak Spatial-Average Specific Absorption Rate (SAR) in the Human Head from Wireless Communications Devices: Measurement Techniques", December 2003
- [4] SPEAG DASY System Handbook
- [5] FCC KDB 248227 D01 v01r02, "SAR Measurement Procedures for 802.11 a/b/g Transmitters", May 2007
- [6] FCC KDB 447498 D01 v05r02, "Mobile and Portable Device RF Exposure Procedures and Equipment Authorization Policies", Feb 2014
- [7] FCC KDB 648474 D04 v01r02, "SAR Evaluation Considerations for Wireless Handsets", Dec 2013.
- [8] FCC KDB 941225 D01 v03, "3G SAR MEAUREMENT PROCEDURES", Oct 2014
- [9] FCC KDB 941225 D06 v02, "SAR Evaluation Procedures for Portable Devices with Wireless Router Capabilities", Oct 2014.
- [10] FCC KDB 865664 D01 v01r03, "SAR Measurement Requirements for 100 MHz to 6 GHz", Feb 2014.
- [11] FCC KDB 865664 D02 v01r01, "RF Exposure Compliance Reporting and Documentation Considerations" May 2013.



---

**Appendix A. Plots of System Performance Check**

The plots are shown as follows.

**System Check\_Head\_835MHz\_150207**

**DUT: D835V2 - SN: 4d151**

Communication System: CW; Frequency: 835 MHz; Duty Cycle: 1:1

Medium: HSL\_835\_150207 Medium parameters used:  $f = 835 \text{ MHz}$ ;  $\sigma = 0.9 \text{ S/m}$ ;  $\epsilon_r = 42.153$ ;  $\rho = 1000 \text{ kg/m}^3$

Ambient Temperature :  $23.5 \text{ }^\circ\text{C}$ ; Liquid Temperature :  $22.6 \text{ }^\circ\text{C}$

DASY5 Configuration:

- Probe: EX3DV4 - SN3911; ConvF(9.62, 9.62, 9.62); Calibrated: 2014/10/2;
- Sensor-Surface: 2mm (Mechanical Surface Detection)
- Electronics: DAE4 Sn1358; Calibrated: 2014/4/30
- Phantom: SAM1; Type: QD000P40CD; Serial: TP:1753
- Measurement SW: DASY52, Version 52.8 (5); SEMCAD X Version 14.6.8 (7028)

**Pin=250mW/Area Scan (61x61x1):** Interpolated grid:  $dx=15\text{mm}$ ,  $dy=15\text{mm}$   
Maximum value of SAR (interpolated) =  $3.04 \text{ W/kg}$

**Pin=250mW/Zoom Scan (5x5x7)/Cube 0:** Measurement grid:  $dx=8\text{mm}$ ,  $dy=8\text{mm}$ ,  $dz=5\text{mm}$   
Reference Value =  $55.049 \text{ V/m}$ ; Power Drift =  $0.01 \text{ dB}$   
Peak SAR (extrapolated) =  $3.62 \text{ W/kg}$   
**SAR(1 g) =  $2.38 \text{ W/kg}$ ; SAR(10 g) =  $1.55 \text{ W/kg}$**   
Maximum value of SAR (measured) =  $3.05 \text{ W/kg}$

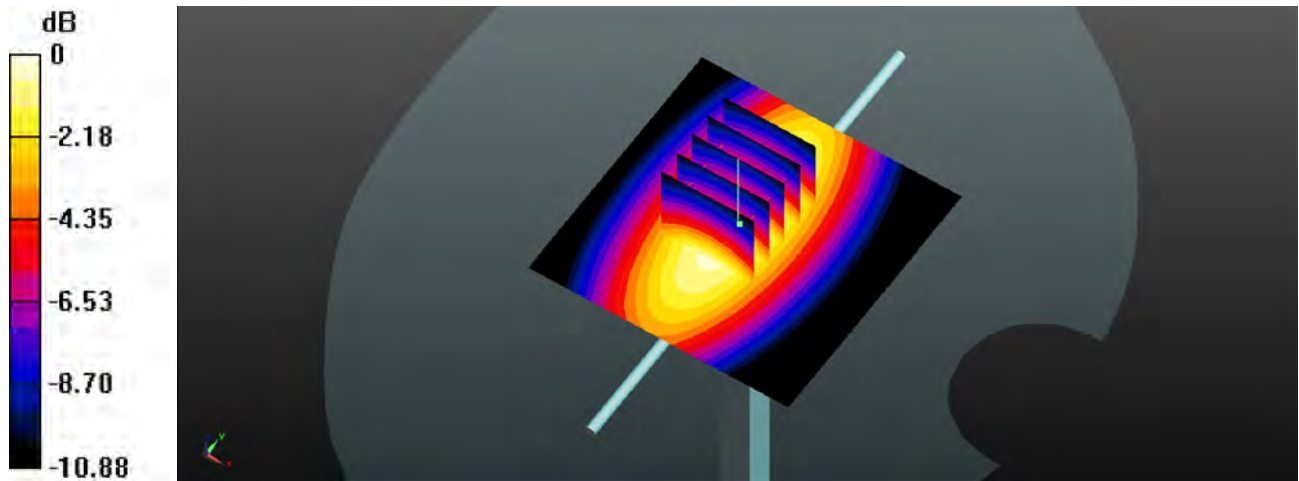

0 dB =  $3.05 \text{ W/kg}$

### System Check\_Head\_1750MHz\_150211

**DUT: D1750V2 - SN: 1090**

Communication System: CW; Frequency: 1750 MHz; Duty Cycle: 1:1

Medium: HSL\_1750\_150211 Medium parameters used:  $f = 1750$  MHz;  $\sigma = 1.356$  S/m;  $\epsilon_r = 40.423$ ;  $\rho = 1000$  kg/m<sup>3</sup>

Ambient Temperature : 23.5 °C ; Liquid Temperature : 22.6 °C

DASY5 Configuration:

- Probe: EX3DV4 - SN3911; ConvF(8.18, 8.18, 8.18); Calibrated: 2014/10/2;
- Sensor-Surface: 2mm (Mechanical Surface Detection)
- Electronics: DAE4 Sn1358; Calibrated: 2014/4/30
- Phantom: SAM2; Type: QD000P40CD; Serial: TP:1754
- Measurement SW: DASY52, Version 52.8 (5); SEMCAD X Version 14.6.8 (7028)

**Pin=250mW/Area Scan (61x61x1):** Interpolated grid: dx=15mm, dy=15mm  
Maximum value of SAR (interpolated) = 11.9 W/kg

**Pin=250mW/Zoom Scan (5x5x7)/Cube 0:** Measurement grid: dx=8mm, dy=8mm, dz=5mm  
Reference Value = 93.236 V/m; Power Drift = -0.01 dB  
Peak SAR (extrapolated) = 15.1 W/kg  
**SAR(1 g) = 8.51 W/kg; SAR(10 g) = 4.37 W/kg**  
Maximum value of SAR (measured) = 11.7 W/kg

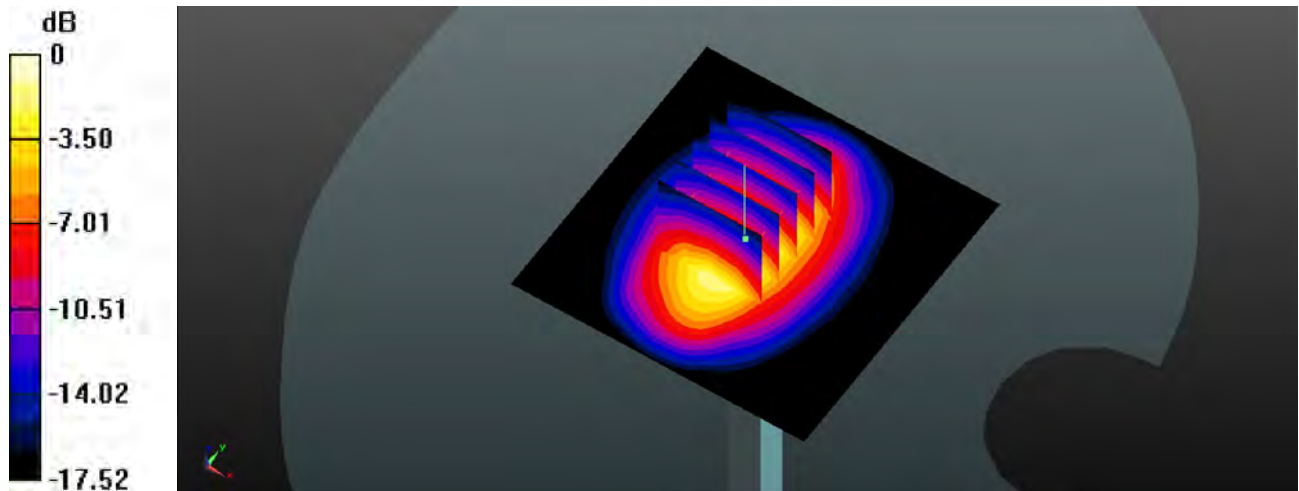

0 dB = 11.7 W/kg



### System Check\_Head\_1900MHz\_150207

**DUT: D1900V2 - SN: 5d170**

Communication System: CW; Frequency: 1900 MHz; Duty Cycle: 1:1

Medium: HSL\_1900\_150207 Medium parameters used:  $f = 1900$  MHz;  $\sigma = 1.415$  S/m;  $\epsilon_r = 38.757$ ;  $\rho = 1000$  kg/m<sup>3</sup>

Ambient Temperature : 23.5 °C ; Liquid Temperature : 22.3 °C

DASY5 Configuration:

- Probe: EX3DV4 - SN3911; ConvF(7.95, 7.95, 7.95); Calibrated: 2014/10/2;
- Sensor-Surface: 2mm (Mechanical Surface Detection)
- Electronics: DAE4 Sn1358; Calibrated: 2014/4/30
- Phantom: SAM1; Type: QD000P40CD; Serial: TP:1753
- Measurement SW: DASY52, Version 52.8 (5); SEMCAD X Version 14.6.8 (7028)

**Pin=250mW/Area Scan (61x61x1):** Interpolated grid: dx=15mm, dy=15mm  
Maximum value of SAR (interpolated) = 13.9 W/kg

**Pin=250mW/Zoom Scan (5x5x7)/Cube 0:** Measurement grid: dx=8mm, dy=8mm, dz=5mm  
Reference Value = 96.634 V/m; Power Drift = 0.07 dB  
Peak SAR (extrapolated) = 17.5 W/kg  
**SAR(1 g) = 9.55 W/kg; SAR(10 g) = 4.96 W/kg**  
Maximum value of SAR (measured) = 13.4 W/kg

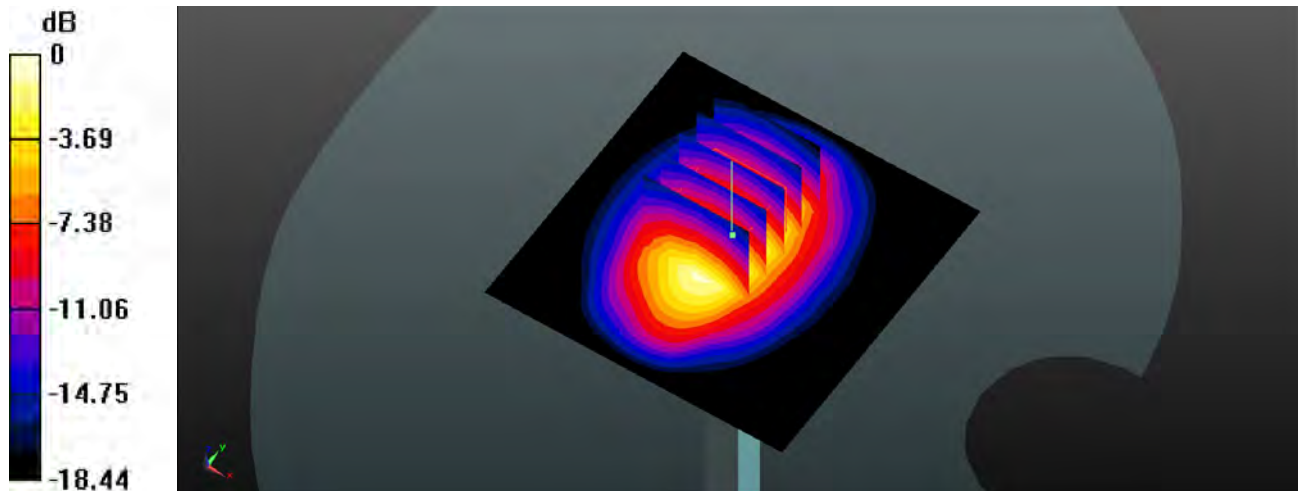

0 dB = 13.4 W/kg

### System Check\_Head\_2450MHz\_150212

**DUT: D2450V2 - SN: 908**

Communication System: CW; Frequency: 2450 MHz; Duty Cycle: 1:1

Medium: HSL\_2450\_150212 Medium parameters used:  $f = 2450$  MHz;  $\sigma = 1.832$  S/m;  $\epsilon_r = 37.7$ ;  $\rho = 1000$  kg/m<sup>3</sup>

Ambient Temperature : 23.6 °C ; Liquid Temperature : 22.5 °C

DASY5 Configuration:

- Probe: EX3DV4 - SN3911; ConvF(7.05, 7.05, 7.05); Calibrated: 2014/10/2;
- Sensor-Surface: 2mm (Mechanical Surface Detection)
- Electronics: DAE4 Sn1358; Calibrated: 2014/4/30
- Phantom: SAM1; Type: QD000P40CD; Serial: TP:1753
- Measurement SW: DASY52, Version 52.8 (5); SEMCAD X Version 14.6.8 (7028)

**Pin=250mW/Area Scan (81x81x1):** Interpolated grid: dx=12mm, dy=12mm  
Maximum value of SAR (interpolated) = 20.8 W/kg

**Pin=250mW/Zoom Scan (7x7x7)/Cube 0:** Measurement grid: dx=5mm, dy=5mm, dz=5mm  
Reference Value = 89.567 V/m; Power Drift = 0.04 dB  
Peak SAR (extrapolated) = 28.9 W/kg  
**SAR(1 g) = 13.8 W/kg; SAR(10 g) = 6.11 W/kg**  
Maximum value of SAR (measured) = 21.1 W/kg

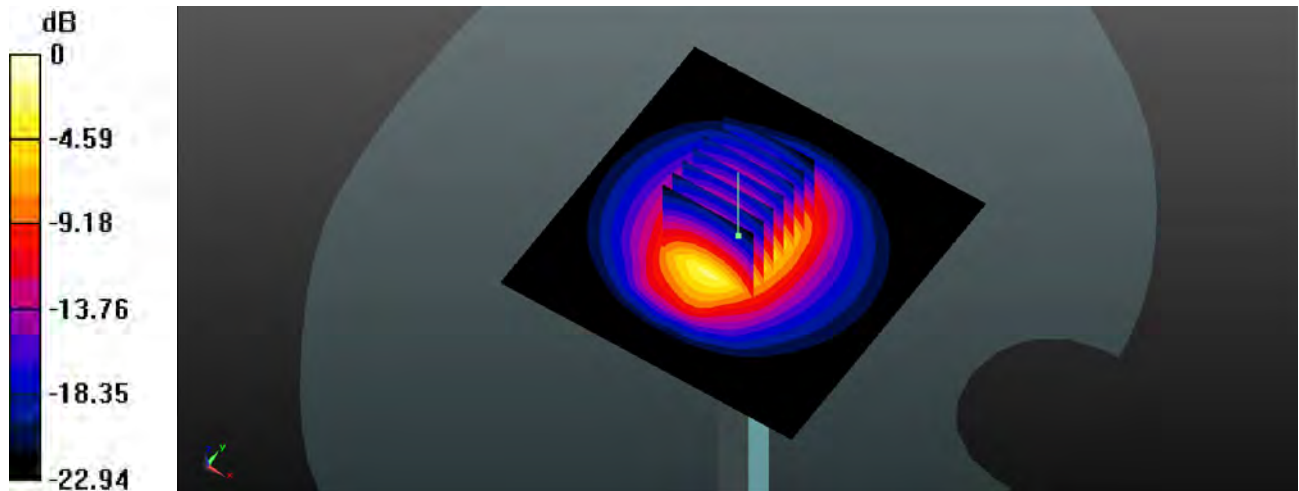

0 dB = 21.1 W/kg

### System Check\_Body\_835MHz\_150207

**DUT: D835V2 - SN: 4d151**

Communication System: CW; Frequency: 835 MHz; Duty Cycle: 1:1

Medium: MSL\_835\_150207 Medium parameters used:  $f = 835 \text{ MHz}$ ;  $\sigma = 0.97 \text{ S/m}$ ;  $\epsilon_r = 53.68$ ;  $\rho = 1000 \text{ kg/m}^3$

Ambient Temperature :  $23.5 \text{ }^\circ\text{C}$ ; Liquid Temperature :  $22.5 \text{ }^\circ\text{C}$

DASY5 Configuration:

- Probe: EX3DV4 - SN3911; ConvF(9.66, 9.66, 9.66); Calibrated: 2014/10/2;
- Sensor-Surface: 2mm (Mechanical Surface Detection)
- Electronics: DAE4 Sn1358; Calibrated: 2014/4/30
- Phantom: SAM2; Type: QD000P40CD; Serial: TP:1754
- Measurement SW: DASY52, Version 52.8 (5); SEMCAD X Version 14.6.8 (7028)

**Pin=250mW/Area Scan (61x61x1):** Interpolated grid:  $dx=15\text{mm}$ ,  $dy=15\text{mm}$   
Maximum value of SAR (interpolated) =  $3.12 \text{ W/kg}$

**Pin=250mW/Zoom Scan (5x5x7)/Cube 0:** Measurement grid:  $dx=8\text{mm}$ ,  $dy=8\text{mm}$ ,  $dz=5\text{mm}$   
Reference Value =  $50.821 \text{ V/m}$ ; Power Drift =  $0.03 \text{ dB}$   
Peak SAR (extrapolated) =  $3.70 \text{ W/kg}$   
**SAR(1 g) =  $2.45 \text{ W/kg}$ ; SAR(10 g) =  $1.6 \text{ W/kg}$**   
Maximum value of SAR (measured) =  $3.12 \text{ W/kg}$

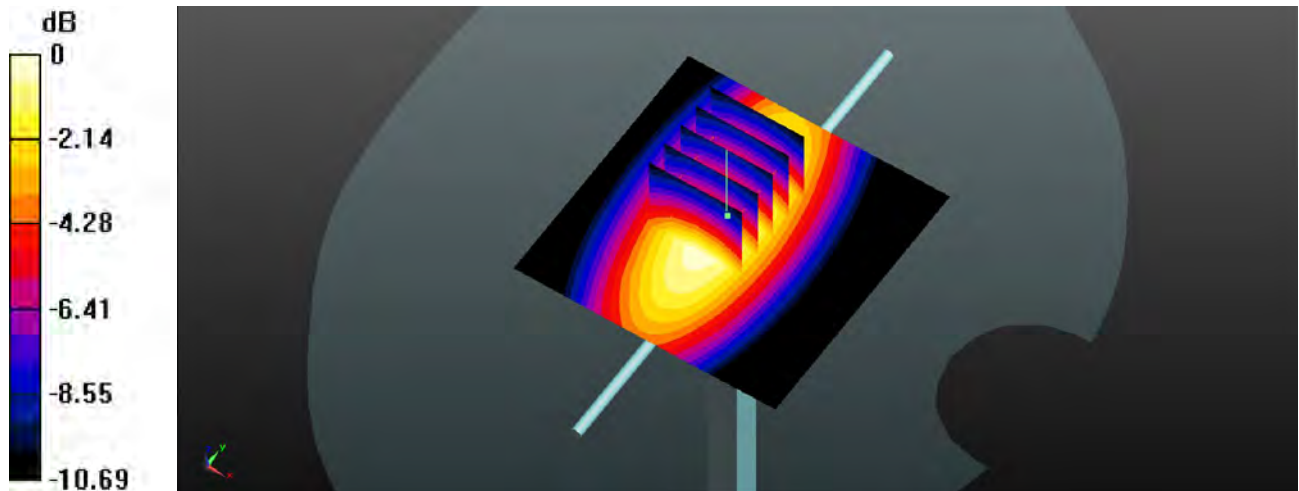

0 dB =  $3.12 \text{ W/kg}$

### System Check\_Body\_1750MHz\_150211

**DUT: D1750V2 - SN: 1090**

Communication System: CW; Frequency: 1750 MHz; Duty Cycle: 1:1

Medium: MSL\_1750\_150211 Medium parameters used:  $f = 1750$  MHz;  $\sigma = 1.529$  S/m;  $\epsilon_r = 54.187$ ;  $\rho = 1000$  kg/m<sup>3</sup>

Ambient Temperature : 23.5 °C ; Liquid Temperature : 22.6 °C

DASY5 Configuration:

- Probe: EX3DV4 - SN3911; ConvF(7.93, 7.93, 7.93); Calibrated: 2014/10/2;
- Sensor-Surface: 2mm (Mechanical Surface Detection)
- Electronics: DAE4 Sn1358; Calibrated: 2014/4/30
- Phantom: SAM2; Type: QD000P40CD; Serial: TP:1754
- Measurement SW: DASY52, Version 52.8 (5); SEMCAD X Version 14.6.8 (7028)

**Pin=250mW/Area Scan (61x61x1):** Interpolated grid: dx=15mm, dy=15mm  
Maximum value of SAR (interpolated) = 13.1 W/kg

**Pin=250mW/Zoom Scan (5x5x7)/Cube 0:** Measurement grid: dx=8mm, dy=8mm, dz=5mm  
Reference Value = 85.911 V/m; Power Drift = 0.11 dB  
Peak SAR (extrapolated) = 16.7 W/kg  
**SAR(1 g) = 9.35 W/kg; SAR(10 g) = 4.94 W/kg**  
Maximum value of SAR (measured) = 12.9 W/kg

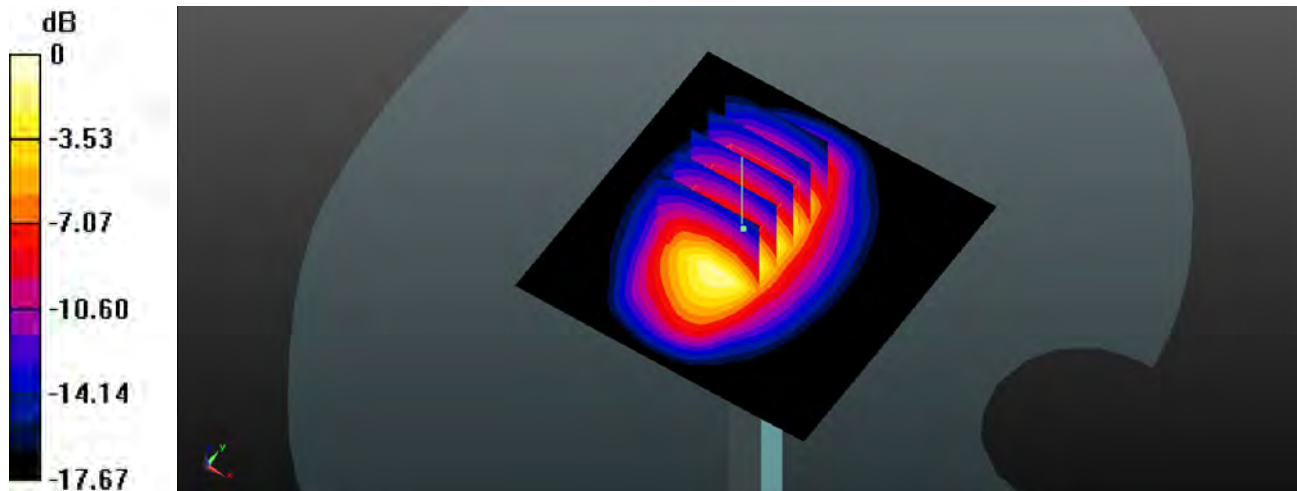

0 dB = 12.9 W/kg

**System Check\_Body\_1900MHz\_150205**

**DUT: D1900V2 - SN: 5d170**

Communication System: CW; Frequency: 1900 MHz; Duty Cycle: 1:1

Medium: MSL\_1900\_150205 Medium parameters used:  $f = 1900 \text{ MHz}$ ;  $\sigma = 1.543 \text{ S/m}$ ;  $\epsilon_r = 52.508$ ;  $\rho = 1000 \text{ kg/m}^3$

Ambient Temperature :  $23.5 \text{ }^\circ\text{C}$ ; Liquid Temperature :  $22.5 \text{ }^\circ\text{C}$

DASY5 Configuration:

- Probe: EX3DV4 - SN3911; ConvF(7.57, 7.57, 7.57); Calibrated: 2014/10/2;
- Sensor-Surface: 2mm (Mechanical Surface Detection)
- Electronics: DAE4 Sn1358; Calibrated: 2014/4/30
- Phantom: SAM2; Type: QD000P40CD; Serial: TP:1754
- Measurement SW: DASY52, Version 52.8 (5); SEMCAD X Version 14.6.8 (7028)

**Pin=250mW/Area Scan (61x61x1):** Interpolated grid:  $dx=15\text{mm}$ ,  $dy=15\text{mm}$   
Maximum value of SAR (interpolated) =  $14.1 \text{ W/kg}$

**Pin=250mW/Zoom Scan (5x5x7)/Cube 0:** Measurement grid:  $dx=8\text{mm}$ ,  $dy=8\text{mm}$ ,  $dz=5\text{mm}$   
Reference Value =  $80.526 \text{ V/m}$ ; Power Drift =  $0.11 \text{ dB}$   
Peak SAR (extrapolated) =  $17.9 \text{ W/kg}$   
**SAR(1 g) =  $10 \text{ W/kg}$ ; SAR(10 g) =  $5.22 \text{ W/kg}$**   
Maximum value of SAR (measured) =  $14.2 \text{ W/kg}$

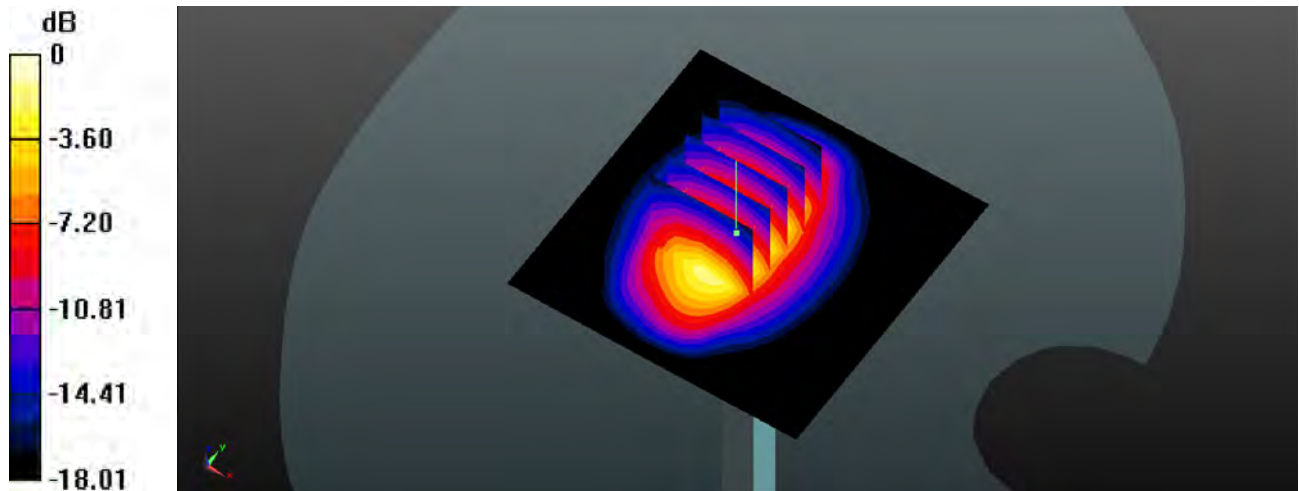

0 dB =  $14.2 \text{ W/kg}$

### System Check\_Body\_2450MHz\_150212

**DUT: D2450V2 - SN: 908**

Communication System: CW; Frequency: 2450 MHz; Duty Cycle: 1:1

Medium: MSL\_2450\_150212 Medium parameters used:  $f = 2450$  MHz;  $\sigma = 1.949$  S/m;  $\epsilon_r = 53.894$ ;  $\rho = 1000$  kg/m<sup>3</sup>

Ambient Temperature : 23.5 °C ; Liquid Temperature : 22.6 °C

DASY5 Configuration:

- Probe: EX3DV4 - SN3911; ConvF(7.18, 7.18, 7.18); Calibrated: 2014/10/2;
- Sensor-Surface: 2mm (Mechanical Surface Detection)
- Electronics: DAE4 Sn1358; Calibrated: 2014/4/30
- Phantom: SAM2; Type: QD000P40CD; Serial: TP:1754
- Measurement SW: DASY52, Version 52.8 (5); SEMCAD X Version 14.6.8 (7028)

**Pin=250mW/Area Scan (81x81x1):** Interpolated grid: dx=12mm, dy=12mm  
Maximum value of SAR (interpolated) = 20.1 W/kg

**Pin=250mW/Zoom Scan (7x7x7)/Cube 0:** Measurement grid: dx=5mm, dy=5mm, dz=5mm  
Reference Value = 82.252 V/m; Power Drift = 0.08 dB  
Peak SAR (extrapolated) = 27.0 W/kg  
**SAR(1 g) = 13.2 W/kg; SAR(10 g) = 6.14 W/kg**  
Maximum value of SAR (measured) = 20.0 W/kg

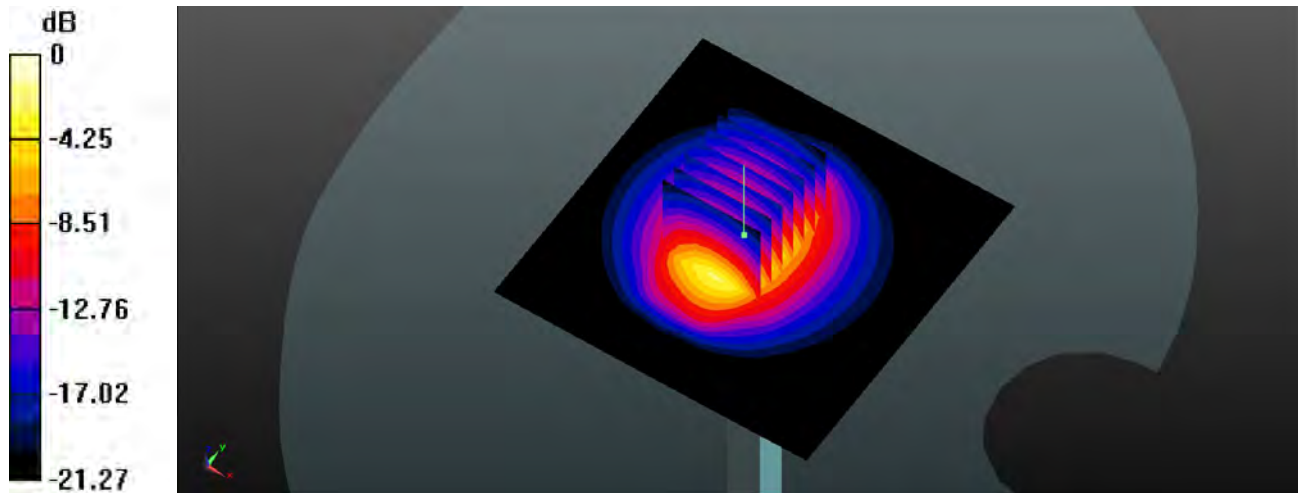

0 dB = 20.0 W/kg



---

**Appendix B. Plots of SAR Measurement**

The plots are shown as follows.

### #01 GSM850\_GPRS (GMSK 2 Tx slots)\_Right Cheek\_Ch128

Communication System: GPRS (GMSK 2 Tx slot); Frequency: 824.2 MHz; Duty Cycle: 1:4.15  
Medium: HSL\_835\_150207 Medium parameters used:  $f = 824.2$  MHz;  $\sigma = 0.889$  S/m;  $\epsilon_r = 42.305$ ;  $\rho = 1000$  kg/m<sup>3</sup>  
Ambient Temperature : 23.5 °C ; Liquid Temperature : 22.6 °C

#### DASY5 Configuration:

- Probe: EX3DV4 - SN3911; ConvF(9.62, 9.62, 9.62); Calibrated: 2014/10/2;
- Sensor-Surface: 2mm (Mechanical Surface Detection)
- Electronics: DAE4 Sn1358; Calibrated: 2014/4/30
- Phantom: SAM1; Type: QD000P40CD; Serial: TP:1753
- Measurement SW: DASY52, Version 52.8 (5); SEMCAD X Version 14.6.8 (7028)

**Ch128/Area Scan (71x121x1):** Interpolated grid: dx=15mm, dy=15mm  
Maximum value of SAR (interpolated) = 0.670 W/kg

**Ch128/Zoom Scan (5x5x7)/Cube 0:** Measurement grid: dx=8mm, dy=8mm, dz=5mm  
Reference Value = 10.803 V/m; Power Drift = 0.09 dB  
Peak SAR (extrapolated) = 0.743 W/kg  
**SAR(1 g) = 0.595 W/kg; SAR(10 g) = 0.462 W/kg**  
Maximum value of SAR (measured) = 0.674 W/kg

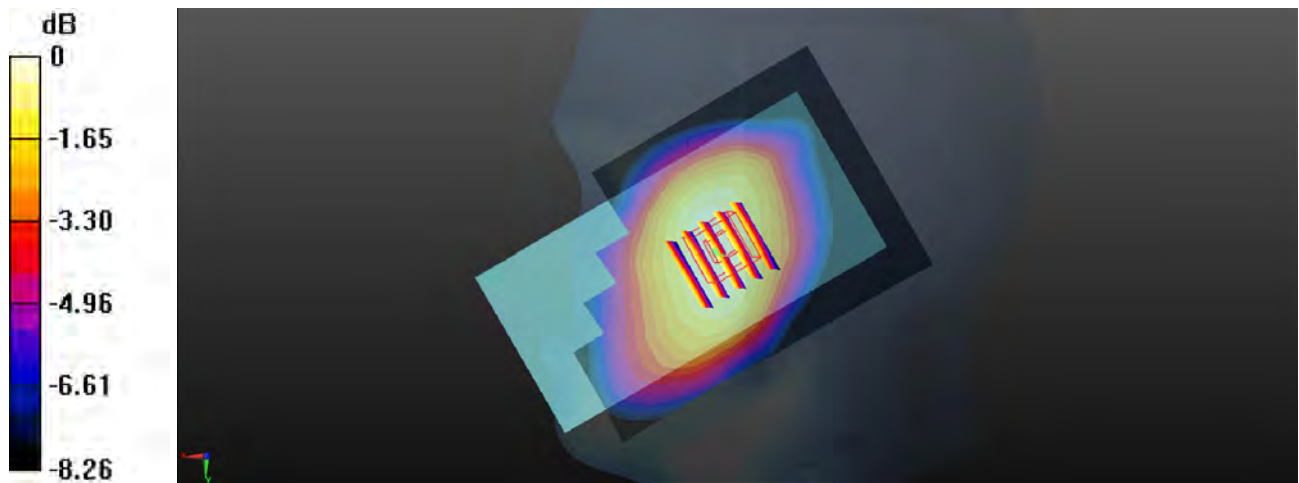

0 dB = 0.674 W/kg



## #02 GSM1900\_GPRS (GMSK 4 Tx slots)\_Left Cheek\_Ch810

Communication System: GPRS (GMSK 4 Tx slot); Frequency: 1909.8 MHz; Duty Cycle: 1:2.08  
Medium: HSL\_1900\_150207 Medium parameters used:  $f = 1909.8$  MHz;  $\sigma = 1.424$  S/m;  $\epsilon_r = 38.668$ ;  $\rho = 1000$  kg/m<sup>3</sup>  
Ambient Temperature : 23.5 °C ; Liquid Temperature : 22.3 °C

### DASY5 Configuration:

- Probe: EX3DV4 - SN3911; ConvF(7.95, 7.95, 7.95); Calibrated: 2014/10/2;
- Sensor-Surface: 2mm (Mechanical Surface Detection)
- Electronics: DAE4 Sn1358; Calibrated: 2014/4/30
- Phantom: SAM1; Type: QD000P40CD; Serial: TP:1753
- Measurement SW: DASY52, Version 52.8 (5); SEMCAD X Version 14.6.8 (7028)

**Ch810/Area Scan (71x121x1):** Interpolated grid: dx=15mm, dy=15mm  
Maximum value of SAR (interpolated) = 0.452 W/kg

**Ch810/Zoom Scan (5x5x7)/Cube 0:** Measurement grid: dx=8mm, dy=8mm, dz=5mm  
Reference Value = 7.091 V/m; Power Drift = 0.02 dB  
Peak SAR (extrapolated) = 0.536 W/kg  
**SAR(1 g) = 0.357 W/kg; SAR(10 g) = 0.224 W/kg**  
Maximum value of SAR (measured) = 0.453 W/kg

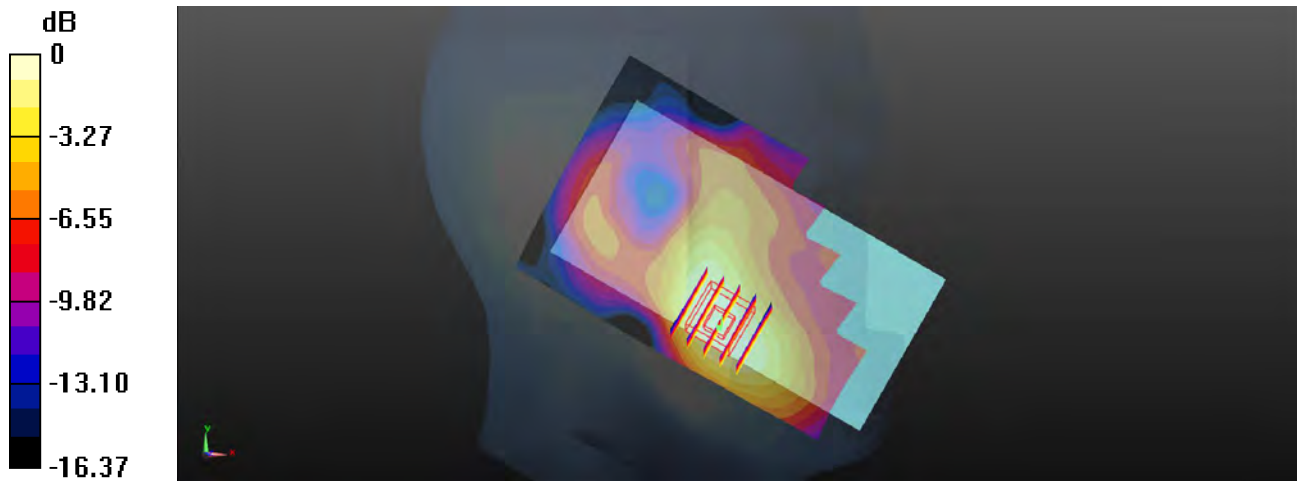

0 dB = 0.453 W/kg

### #03 WCDMA Band V\_RMC 12.2K\_Right Cheek\_Ch4132

Communication System: WCDMA ; Frequency: 826.4 MHz; Duty Cycle: 1:1

Medium: HSL\_835\_150207 Medium parameters used:  $f = 826.4$  MHz;  $\sigma = 0.891$  S/m;  $\epsilon_r = 42.265$ ;  $\rho = 1000$  kg/m<sup>3</sup>

Ambient Temperature : 23.5 °C ; Liquid Temperature : 22.6 °C

DASY5 Configuration:

- Probe: EX3DV4 - SN3911; ConvF(9.62, 9.62, 9.62); Calibrated: 2014/10/2;
- Sensor-Surface: 2mm (Mechanical Surface Detection)
- Electronics: DAE4 Sn1358; Calibrated: 2014/4/30
- Phantom: SAM1; Type: QD000P40CD; Serial: TP:1753
- Measurement SW: DASY52, Version 52.8 (5); SEMCAD X Version 14.6.8 (7028)

**Ch4132/Area Scan (71x121x1):** Interpolated grid: dx=15mm, dy=15mm

Maximum value of SAR (interpolated) = 0.369 W/kg

**Ch4132/Zoom Scan (5x5x7)/Cube 0:** Measurement grid: dx=8mm, dy=8mm, dz=5mm

Reference Value = 8.244 V/m; Power Drift = 0.01 dB

Peak SAR (extrapolated) = 0.417 W/kg

**SAR(1 g) = 0.335 W/kg; SAR(10 g) = 0.259 W/kg**

Maximum value of SAR (measured) = 0.378 W/kg

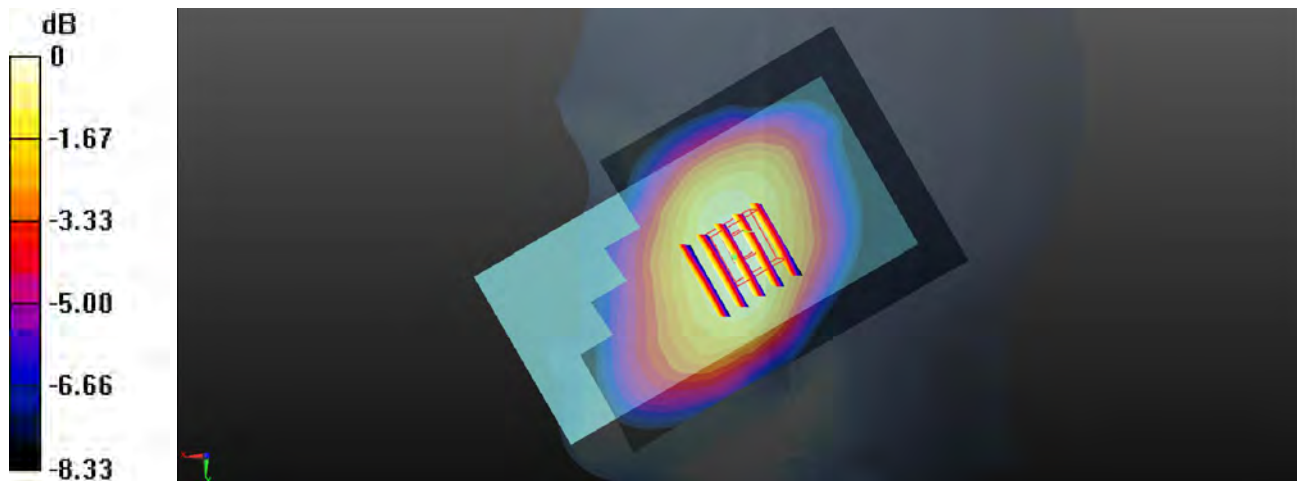

0 dB = 0.378 W/kg

### #04 WCDMA Band IV\_RMC 12.2K\_Left Cheek\_Ch1312

Communication System: WCDMA ; Frequency: 1712.4 MHz;Duty Cycle: 1:1

Medium: HSL\_1750\_150211 Medium parameters used:  $f = 1712.4$  MHz;  $\sigma = 1.32$  S/m;  $\epsilon_r = 40.587$ ;  $\rho = 1000$  kg/m<sup>3</sup>

Ambient Temperature : 23.5 °C ; Liquid Temperature : 22.6 °C

#### DASY5 Configuration:

- Probe: EX3DV4 - SN3911; ConvF(8.18, 8.18, 8.18); Calibrated: 2014/10/2;
- Sensor-Surface: 2mm (Mechanical Surface Detection)
- Electronics: DAE4 Sn1358; Calibrated: 2014/4/30
- Phantom: SAM2; Type: QD000P40CD; Serial: TP:1754
- Measurement SW: DASY52, Version 52.8 (5); SEMCAD X Version 14.6.8 (7028)

**Ch1312/Area Scan (71x121x1):** Interpolated grid: dx=15mm, dy=15mm

Maximum value of SAR (interpolated) = 0.331 W/kg

**Ch1312/Zoom Scan (5x5x7)/Cube 0:** Measurement grid: dx=8mm, dy=8mm, dz=5mm

Reference Value = 6.345 V/m; Power Drift = 0.12 dB

Peak SAR (extrapolated) = 0.382 W/kg

**SAR(1 g) = 0.265 W/kg; SAR(10 g) = 0.172 W/kg**

Maximum value of SAR (measured) = 0.329 W/kg

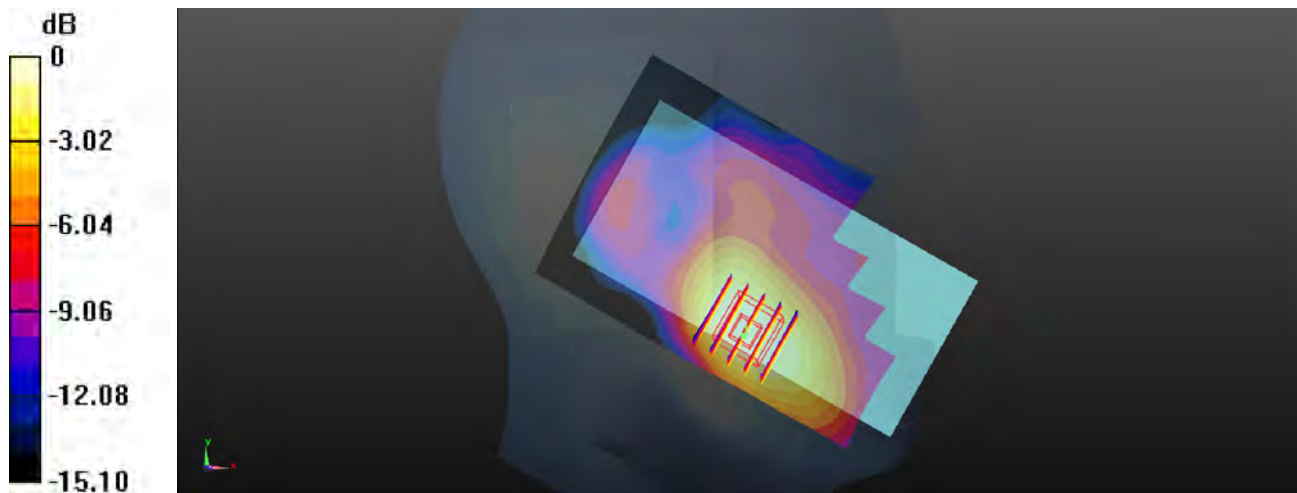

0 dB = 0.329 W/kg

### #05 WCDMA Band II\_RMC 12.2K\_Left Cheek\_Ch9262

Communication System: WCDMA ; Frequency: 1852.4 MHz;Duty Cycle: 1:1

Medium: HSL\_1900\_150207 Medium parameters used:  $f = 1852.4$  MHz;  $\sigma = 1.381$  S/m;  $\epsilon_r = 38.864$ ;

$\rho = 1000$  kg/m<sup>3</sup>

Ambient Temperature : 23.5 °C ; Liquid Temperature : 22.3 °C

DASY5 Configuration:

- Probe: EX3DV4 - SN3911; ConvF(7.95, 7.95, 7.95); Calibrated: 2014/10/2;
- Sensor-Surface: 2mm (Mechanical Surface Detection)
- Electronics: DAE4 Sn1358; Calibrated: 2014/4/30
- Phantom: SAM1; Type: QD000P40CD; Serial: TP:1753
- Measurement SW: DASY52, Version 52.8 (5); SEMCAD X Version 14.6.8 (7028)

**Ch9262/Area Scan (71x121x1):** Interpolated grid: dx=15mm, dy=15mm

Maximum value of SAR (interpolated) = 0.478 W/kg

**Ch9262/Zoom Scan (5x5x7)/Cube 0:** Measurement grid: dx=8mm, dy=8mm, dz=5mm

Reference Value = 8.288 V/m; Power Drift = 0.05 dB

Peak SAR (extrapolated) = 0.557 W/kg

**SAR(1 g) = 0.375 W/kg; SAR(10 g) = 0.237 W/kg**

Maximum value of SAR (measured) = 0.472 W/kg

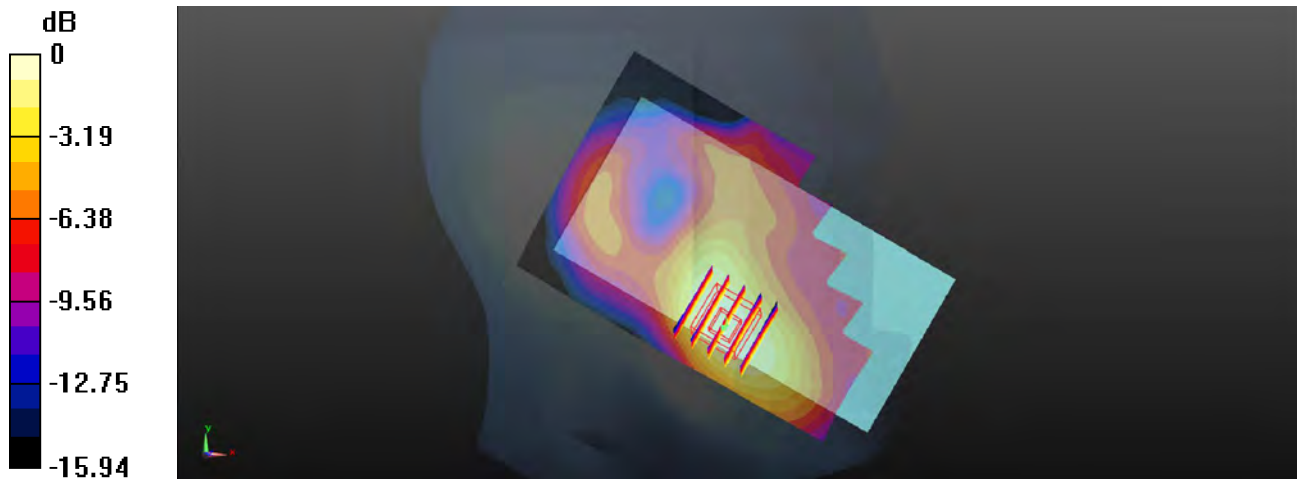

0 dB = 0.472 W/kg

### #06 WLAN 2.4GHz\_802.11b\_Right Tilted\_Ch11

Communication System: 802.11b; Frequency: 2462 MHz; Duty Cycle: 1:1

Medium: HSL\_2450\_150212 Medium parameters used:  $f = 2462$  MHz;  $\sigma = 1.851$  S/m;  $\epsilon_r = 37.602$ ;  $\rho = 1000$  kg/m<sup>3</sup>

Ambient Temperature : 23.6 °C ; Liquid Temperature : 22.5 °C

DASY5 Configuration:

- Probe: EX3DV4 - SN3911; ConvF(7.05, 7.05, 7.05); Calibrated: 2014/10/2;
- Sensor-Surface: 2mm (Mechanical Surface Detection)
- Electronics: DAE4 Sn1358; Calibrated: 2014/4/30
- Phantom: SAM1; Type: QD000P40CD; Serial: TP:1753
- Measurement SW: DASY52, Version 52.8 (5); SEMCAD X Version 14.6.8 (7028)

**Ch11/Area Scan (81x161x1):** Interpolated grid: dx=12mm, dy=12mm

Maximum value of SAR (interpolated) = 1.14 W/kg

**Ch11/Zoom Scan (7x7x7)/Cube 0:** Measurement grid: dx=5mm, dy=5mm, dz=5mm

Reference Value = 15.069 V/m; Power Drift = 0.16 dB

Peak SAR (extrapolated) = 1.67 W/kg

**SAR(1 g) = 0.751 W/kg; SAR(10 g) = 0.330 W/kg**

Maximum value of SAR (measured) = 1.20 W/kg

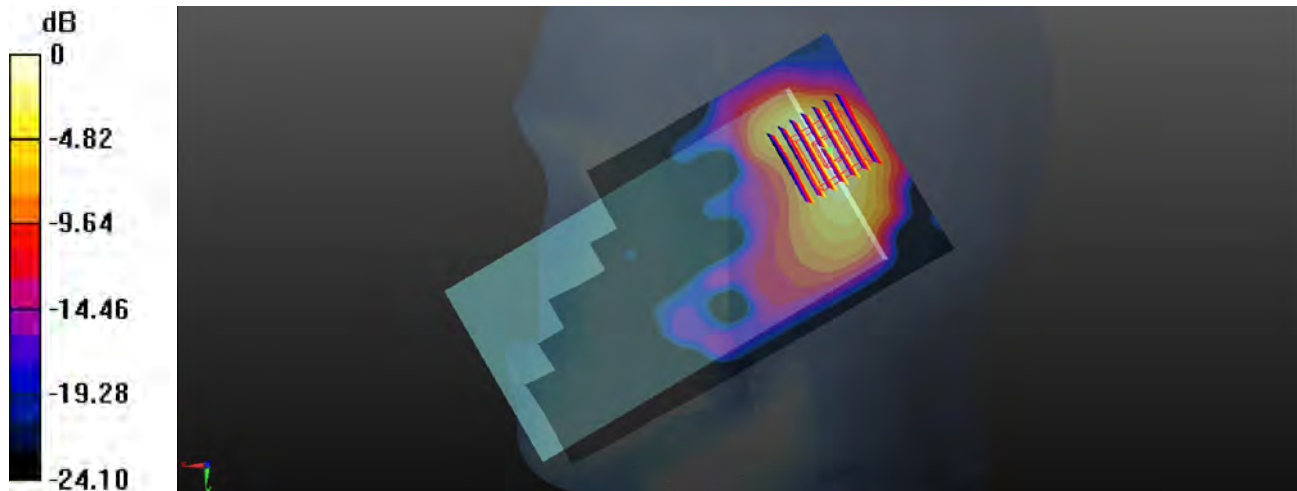

**#07 GSM850\_GPRS (GMSK 2 Tx slots)\_Back\_1.0cm\_Ch189**

Communication System: GPRS (GMSK 2 Tx slot); Frequency: 836.4 MHz; Duty Cycle: 1:4.15  
Medium: MSL\_835\_150207 Medium parameters used:  $f = 836.4$  MHz;  $\sigma = 0.972$  S/m;  $\epsilon_r = 53.666$ ;  $\rho = 1000$  kg/m<sup>3</sup>  
Ambient Temperature : 23.5 °C ; Liquid Temperature : 22.5 °C

DASY5 Configuration:

- Probe: EX3DV4 - SN3911; ConvF(9.66, 9.66, 9.66); Calibrated: 2014/10/2;
- Sensor-Surface: 2mm (Mechanical Surface Detection)
- Electronics: DAE4 Sn1358; Calibrated: 2014/4/30
- Phantom: SAM2; Type: QD000P40CD; Serial: TP:1754
- Measurement SW: DASY52, Version 52.8 (5); SEMCAD X Version 14.6.8 (7028)

**Ch189/Area Scan (61x121x1):** Interpolated grid: dx=15mm, dy=15mm  
Maximum value of SAR (interpolated) = 1.02 W/kg

**Ch189/Zoom Scan (5x5x7)/Cube 0:** Measurement grid: dx=8mm, dy=8mm, dz=5mm  
Reference Value = 30.046 V/m; Power Drift = -0.01 dB  
Peak SAR (extrapolated) = 1.13 W/kg  
**SAR(1 g) = 0.882 W/kg; SAR(10 g) = 0.679 W/kg**  
Maximum value of SAR (measured) = 1.02 W/kg

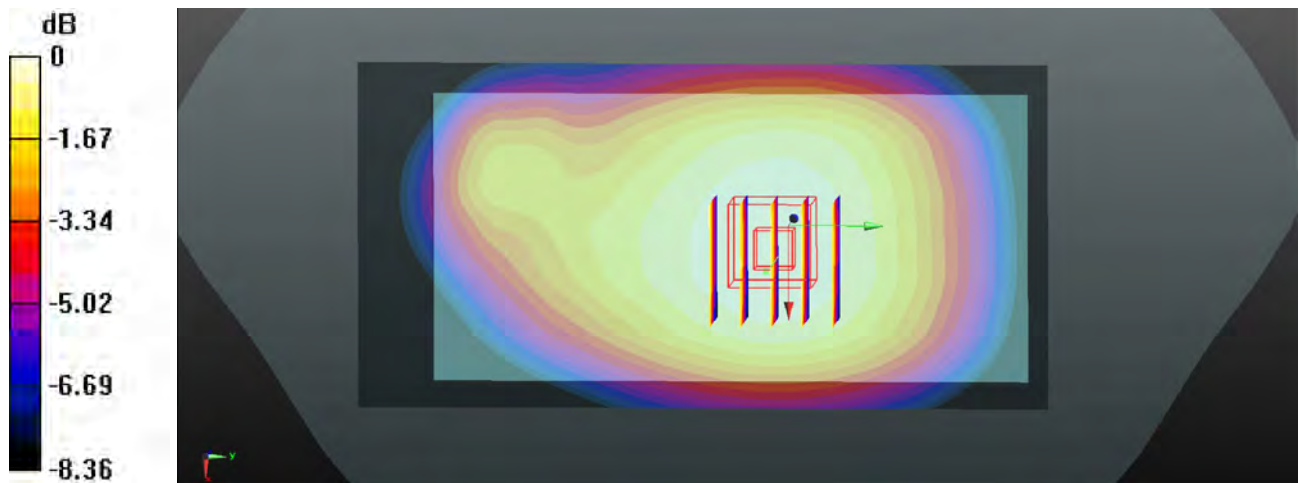

0 dB = 1.02 W/kg

**#08 GSM1900\_GPRS (GMSK 4 Tx slots)\_Bottom side\_1.0cm\_Ch512**

Communication System: GPRS (GMSK 4 Tx slot); Frequency: 1850.2 MHz; Duty Cycle: 1:2.08  
Medium: MSL\_1900\_150205 Medium parameters used:  $f = 1850.2$  MHz;  $\sigma = 1.493$  S/m;  $\epsilon_r = 52.639$ ;  
 $\rho = 1000$  kg/m<sup>3</sup>  
Ambient Temperature : 23.5 °C ; Liquid Temperature : 22.5 °C

DASY5 Configuration:

- Probe: EX3DV4 - SN3911; ConvF(7.57, 7.57, 7.57); Calibrated: 2014/10/2;
- Sensor-Surface: 2mm (Mechanical Surface Detection)
- Electronics: DAE4 Sn1358; Calibrated: 2014/4/30
- Phantom: SAM2; Type: QD000P40CD; Serial: TP:1754
- Measurement SW: DASY52, Version 52.8 (5); SEMCAD X Version 14.6.8 (7028)

**Ch512/Area Scan (31x71x1):** Interpolated grid: dx=15mm, dy=15mm  
Maximum value of SAR (interpolated) = 1.62 W/kg

**Ch512/Zoom Scan (5x5x7)/Cube 0:** Measurement grid: dx=8mm, dy=8mm, dz=5mm  
Reference Value = 25.743 V/m; Power Drift = 0.12 dB  
Peak SAR (extrapolated) = 2.05 W/kg  
**SAR(1 g) = 1.15 W/kg; SAR(10 g) = 0.598 W/kg**  
Maximum value of SAR (measured) = 1.56 W/kg

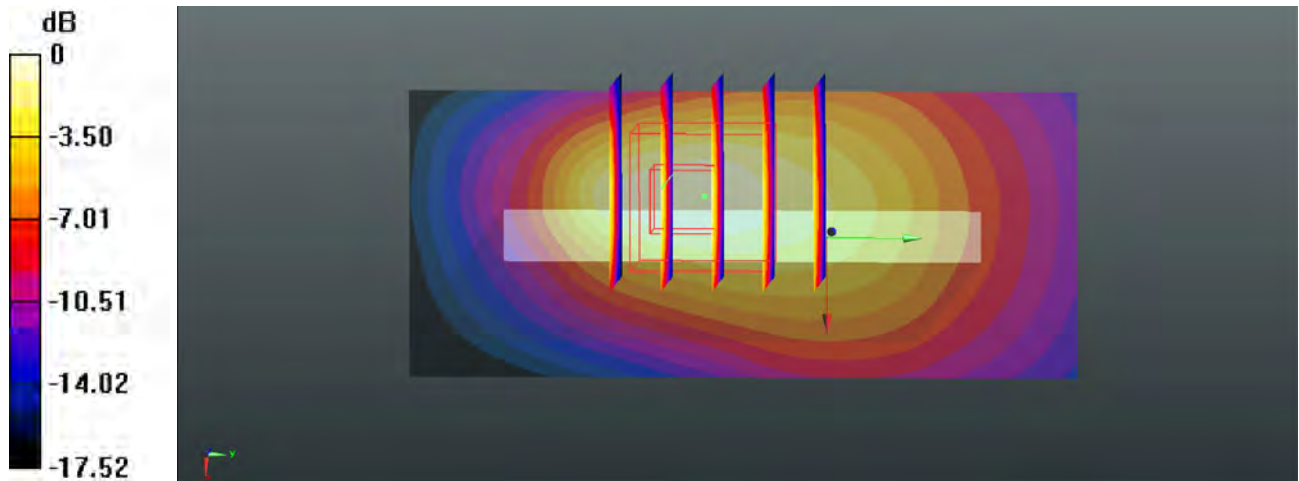

0 dB = 1.56 W/kg

### #09 WCDMA Band V\_RMC 12.2k\_Back\_1.0cm\_Ch4132

Communication System: WCDMA ; Frequency: 826.4 MHz; Duty Cycle: 1:1

Medium: MSL\_835\_150207 Medium parameters used:  $f = 826.4$  MHz;  $\sigma = 0.962$  S/m;  $\epsilon_r = 53.761$ ;  $\rho = 1000$  kg/m<sup>3</sup>

Ambient Temperature : 23.5 °C ; Liquid Temperature : 22.5 °C

DASY5 Configuration:

- Probe: EX3DV4 - SN3911; ConvF(9.66, 9.66, 9.66); Calibrated: 2014/10/2;
- Sensor-Surface: 2mm (Mechanical Surface Detection)
- Electronics: DAE4 Sn1358; Calibrated: 2014/4/30
- Phantom: SAM2; Type: QD000P40CD; Serial: TP:1754
- Measurement SW: DASY52, Version 52.8 (5); SEMCAD X Version 14.6.8 (7028)

**Ch4132/Area Scan (61x121x1):** Interpolated grid: dx=15mm, dy=15mm  
Maximum value of SAR (interpolated) = 0.588 W/kg

**Ch4132/Zoom Scan (5x5x7)/Cube 0:** Measurement grid: dx=8mm, dy=8mm, dz=5mm  
Reference Value = 23.205 V/m; Power Drift = -0.01 dB  
Peak SAR (extrapolated) = 0.651 W/kg  
**SAR(1 g) = 0.510 W/kg; SAR(10 g) = 0.394 W/kg**  
Maximum value of SAR (measured) = 0.586 W/kg

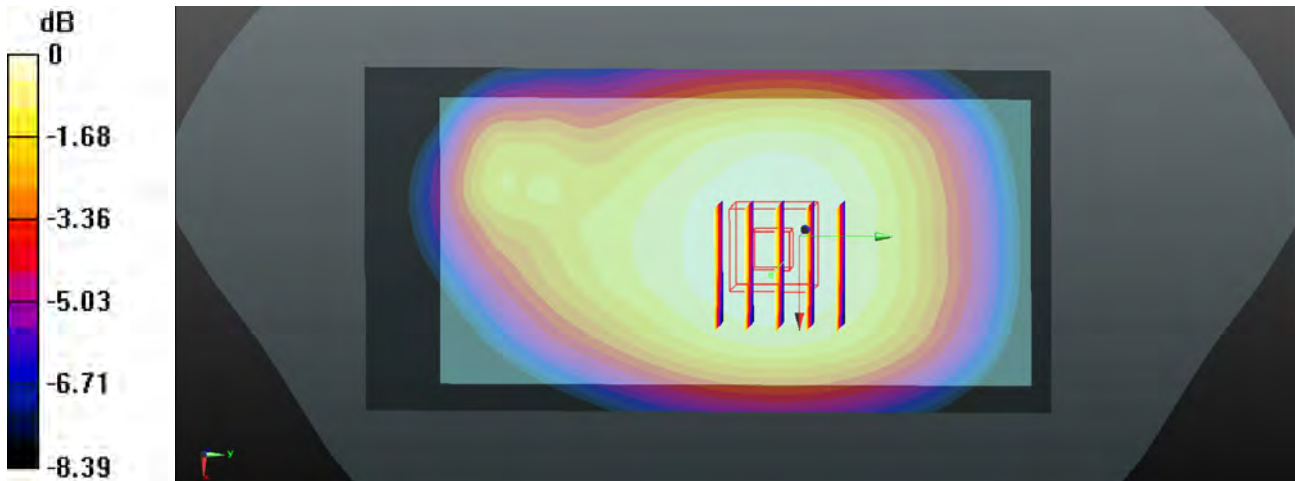

0 dB = 0.586 W/kg



### #10 WCDMA Band IV\_RMC 12.2k\_Bottom side\_1.0cm\_Ch1413

Communication System: WCDMA ; Frequency: 1732.6 MHz;Duty Cycle: 1:1

Medium: MSL\_1750\_150211 Medium parameters used:  $f = 395408$  MHz;  $\sigma = 1.511$  S/m;  $\epsilon_r = 54.266$ ;  $\rho = 1000$  kg/m<sup>3</sup>

Ambient Temperature : 23.5 °C ; Liquid Temperature : 22.6 °C

DASY5 Configuration:

- Probe: EX3DV4 - SN3911; ConvF(7.93, 7.93, 7.93); Calibrated: 2014/10/2;
- Sensor-Surface: 2mm (Mechanical Surface Detection)
- Electronics: DAE4 Sn1358; Calibrated: 2014/4/30
- Phantom: SAM2; Type: QD000P40CD; Serial: TP:1754
- Measurement SW: DASY52, Version 52.8 (5); SEMCAD X Version 14.6.8 (7028)

**Ch1413/Area Scan (31x71x1):** Interpolated grid: dx=15mm, dy=15mm

Maximum value of SAR (interpolated) = 1.73 W/kg

**Ch1413/Zoom Scan (5x5x7)/Cube 0:** Measurement grid: dx=8mm, dy=8mm, dz=5mm

Reference Value = 24.576 V/m; Power Drift = 0.06 dB

Peak SAR (extrapolated) = 2.22 W/kg

**SAR(1 g) = 1.2 W/kg; SAR(10 g) = 0.598 W/kg**

Maximum value of SAR (measured) = 1.72 W/kg

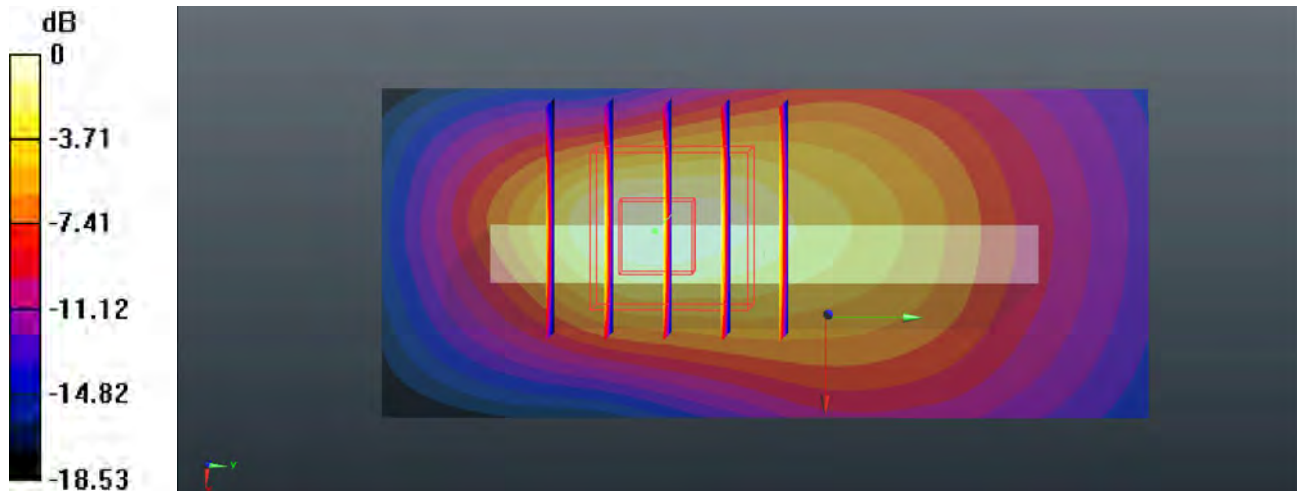

0 dB = 1.72 W/kg

**#11 WCDMA Band II\_RMC 12.2K\_Bottom side\_1.0cm\_Ch9262**

Communication System: WCDMA ; Frequency: 1852.4 MHz;Duty Cycle: 1:1

Medium: MSL\_1900\_150205 Medium parameters used:  $f = 1852.4$  MHz;  $\sigma = 1.496$  S/m;  $\epsilon_r = 52.635$ ;

$\rho = 1000$  kg/m<sup>3</sup>

Ambient Temperature : 23.5 °C ; Liquid Temperature : 22.5 °C

DASY5 Configuration:

- Probe: EX3DV4 - SN3911; ConvF(7.57, 7.57, 7.57); Calibrated: 2014/10/2;
- Sensor-Surface: 2mm (Mechanical Surface Detection)
- Electronics: DAE4 Sn1358; Calibrated: 2014/4/30
- Phantom: SAM2; Type: QD000P40CD; Serial: TP:1754
- Measurement SW: DASY52, Version 52.8 (5); SEMCAD X Version 14.6.8 (7028)

**Ch9262/Area Scan (31x71x1):** Interpolated grid: dx=15mm, dy=15mm

Maximum value of SAR (interpolated) = 1.76 W/kg

**Ch9262/Zoom Scan (5x5x7)/Cube 0:** Measurement grid: dx=8mm, dy=8mm, dz=5mm

Reference Value = 25.610 V/m; Power Drift = 0.09 dB

Peak SAR (extrapolated) = 2.16 W/kg

**SAR(1 g) = 1.22 W/kg; SAR(10 g) = 0.643 W/kg**

Maximum value of SAR (measured) = 1.71 W/kg

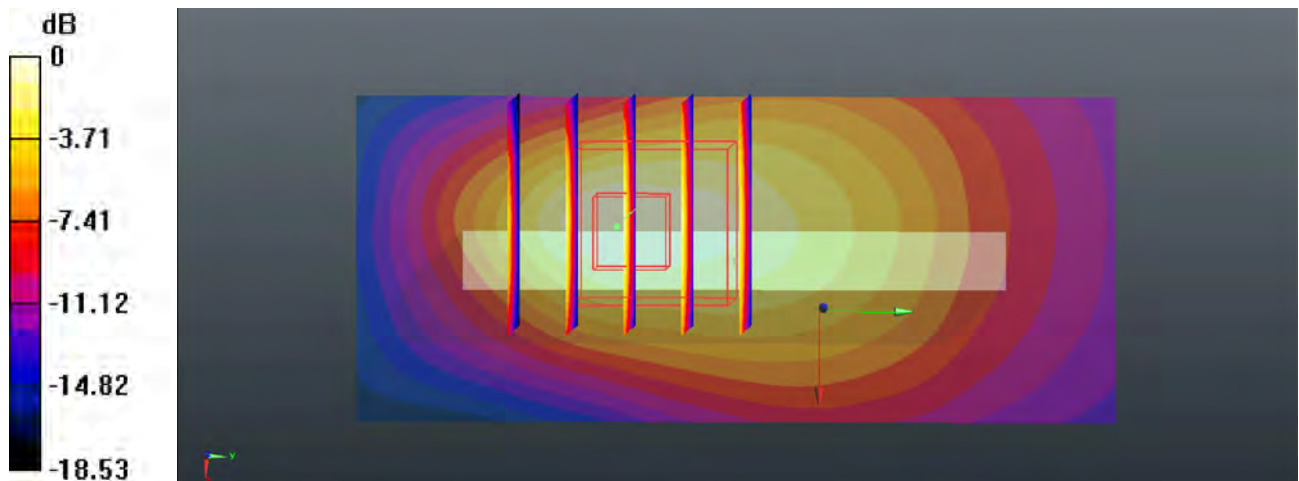

0 dB = 1.71 W/kg

### #12 WLAN 2.4GHz\_802.11b\_Top side\_1.0cm\_Ch11

Communication System: 802.11b; Frequency: 2462 MHz; Duty Cycle: 1:1

Medium: MSL\_2450\_150212 Medium parameters used:  $f = 2462$  MHz;  $\sigma = 1.974$  S/m;  $\epsilon_r = 53.843$ ;  $\rho = 1000$  kg/m<sup>3</sup>

Ambient Temperature : 23.5 °C ; Liquid Temperature : 22.6 °C

#### DASY5 Configuration:

- Probe: EX3DV4 - SN3911; ConvF(7.18, 7.18, 7.18); Calibrated: 2014/10/2;
- Sensor-Surface: 2mm (Mechanical Surface Detection)
- Electronics: DAE4 Sn1358; Calibrated: 2014/4/30
- Phantom: SAM2; Type: QD000P40CD; Serial: TP:1754
- Measurement SW: DASY52, Version 52.8 (5); SEMCAD X Version 14.6.8 (7028)

**Ch11/Area Scan (31x81x1):** Interpolated grid: dx=12mm, dy=12mm

Maximum value of SAR (interpolated) = 0.478 W/kg

**Ch11/Zoom Scan (7x7x7)/Cube 0:** Measurement grid: dx=5mm, dy=5mm, dz=5mm

Reference Value = 13.220 V/m; Power Drift = 0.09 dB

Peak SAR (extrapolated) = 0.642 W/kg

**SAR(1 g) = 0.325 W/kg; SAR(10 g) = 0.157 W/kg**

Maximum value of SAR (measured) = 0.487 W/kg

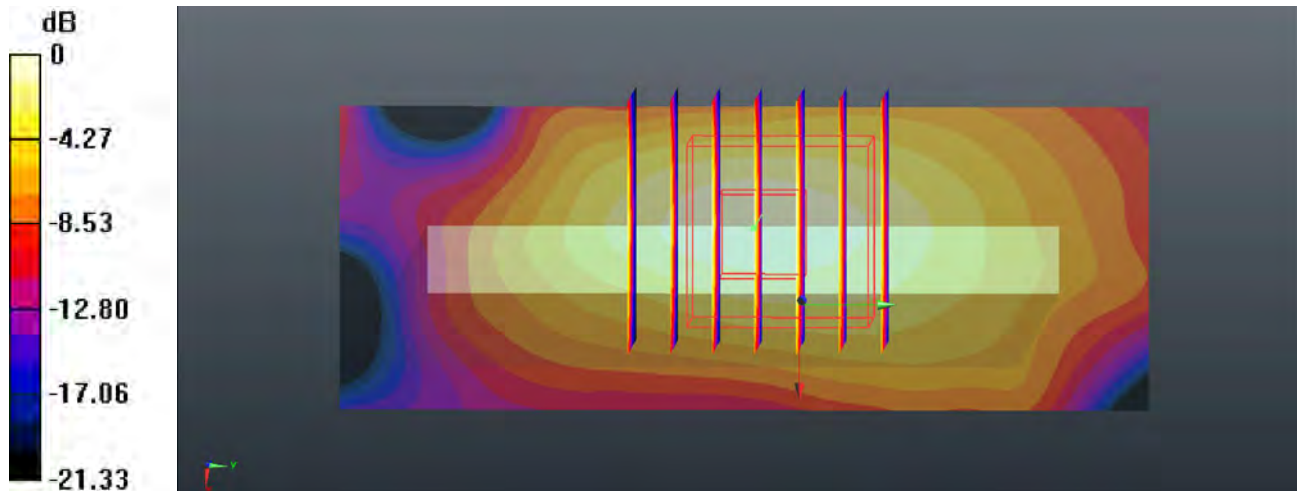

0 dB = 0.487 W/kg

### #13 GSM1900\_GPRS (GMSK 4 Tx slots)\_Back\_1.0cm\_Ch512

Communication System: GPRS (GMSK 4 Tx slot); Frequency: 1850.2 MHz; Duty Cycle: 1:2.08

Medium: MSL\_1900\_150205 Medium parameters used:  $f = 1850.2$  MHz;  $\sigma = 1.493$  S/m;  $\epsilon_r = 52.639$ ;

$\rho = 1000$  kg/m<sup>3</sup>

Ambient Temperature : 23.5 °C ; Liquid Temperature : 22.5 °C

DASY5 Configuration:

- Probe: EX3DV4 - SN3911; ConvF(7.57, 7.57, 7.57); Calibrated: 2014/10/2;
- Sensor-Surface: 2mm (Mechanical Surface Detection)
- Electronics: DAE4 Sn1358; Calibrated: 2014/4/30
- Phantom: SAM2; Type: QD000P40CD; Serial: TP:1754
- Measurement SW: DASY52, Version 52.8 (5); SEMCAD X Version 14.6.8 (7028)

**Ch512/Area Scan (61x121x1):** Interpolated grid: dx=15mm, dy=15mm

Maximum value of SAR (interpolated) = 1.28 W/kg

**Ch512/Zoom Scan (5x5x7)/Cube 0:** Measurement grid: dx=8mm, dy=8mm, dz=5mm

Reference Value = 13.271 V/m; Power Drift = -0.01 dB

Peak SAR (extrapolated) = 1.64 W/kg

**SAR(1 g) = 0.961 W/kg; SAR(10 g) = 0.527 W/kg**

Maximum value of SAR (measured) = 1.25 W/kg

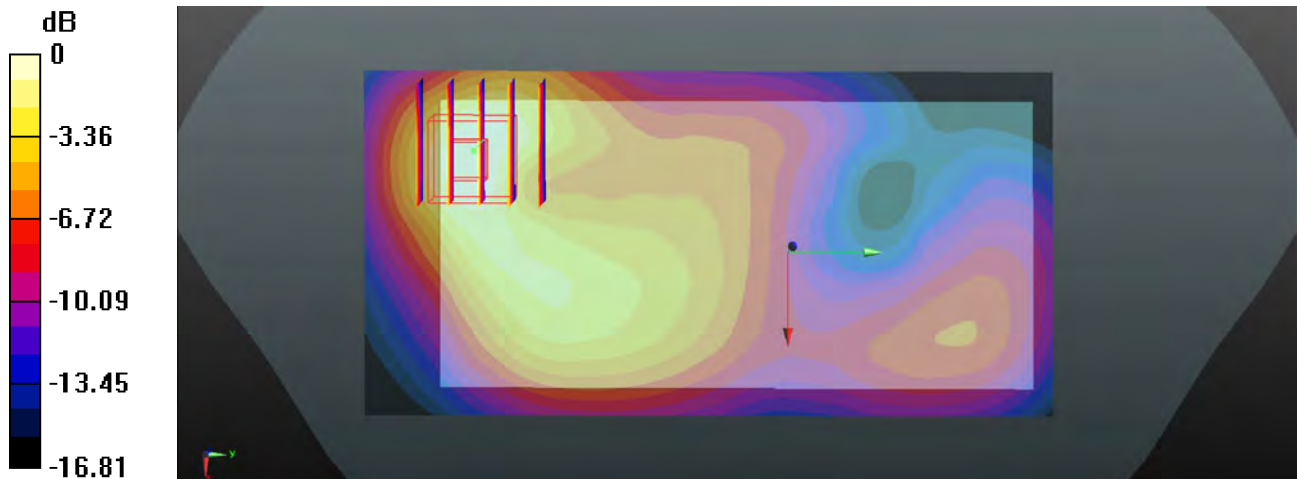

0 dB = 1.25 W/kg

### #14 WCDMA Band IV\_RMC 12.2k\_Back\_1.0cm\_Ch1413

Communication System: WCDMA ; Frequency: 1732.6 MHz;Duty Cycle: 1:1

Medium: MSL\_1750\_150211 Medium parameters used:  $f = 395408$  MHz;  $\sigma = 1.511$  S/m;  $\epsilon_r = 54.266$ ;  $\rho = 1000$  kg/m<sup>3</sup>

Ambient Temperature : 23.5 °C ; Liquid Temperature : 22.6 °C

DASY5 Configuration:

- Probe: EX3DV4 - SN3911; ConvF(7.93, 7.93, 7.93); Calibrated: 2014/10/2;
- Sensor-Surface: 2mm (Mechanical Surface Detection)
- Electronics: DAE4 Sn1358; Calibrated: 2014/4/30
- Phantom: SAM2; Type: QD000P40CD; Serial: TP:1754
- Measurement SW: DASY52, Version 52.8 (5); SEMCAD X Version 14.6.8 (7028)

**Ch1413/Area Scan (61x121x1):** Interpolated grid: dx=15mm, dy=15mm

Maximum value of SAR (interpolated) = 1.43 W/kg

**Ch1413/Zoom Scan (5x5x7)/Cube 0:** Measurement grid: dx=8mm, dy=8mm, dz=5mm

Reference Value = 10.497 V/m; Power Drift = 0.04 dB

Peak SAR (extrapolated) = 1.93 W/kg

**SAR(1 g) = 1.08 W/kg; SAR(10 g) = 0.569 W/kg**

Maximum value of SAR (measured) = 1.50 W/kg

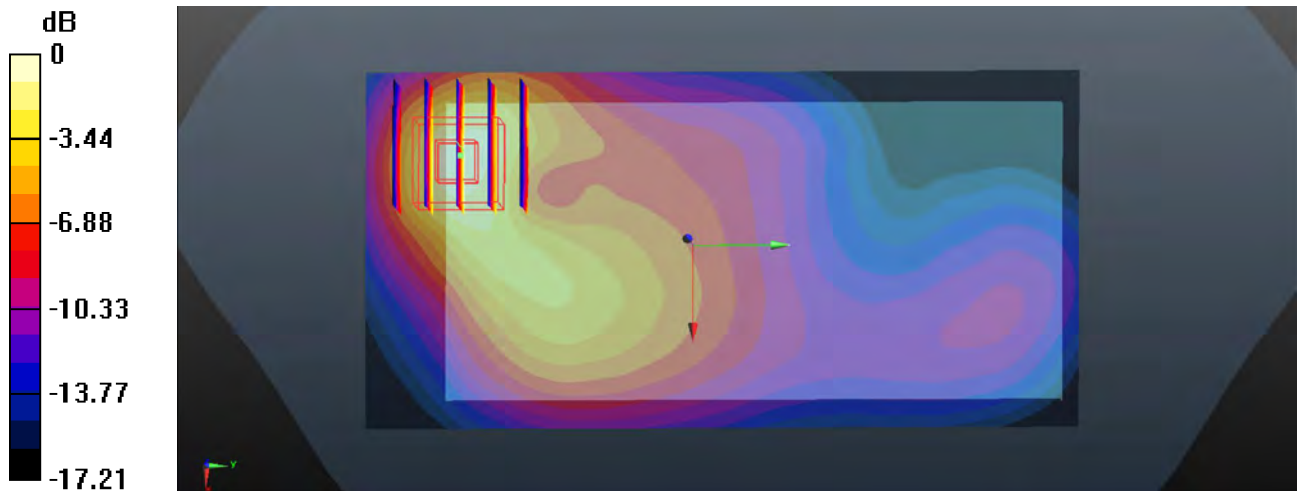

0 dB = 1.50 W/kg

### #15 WCDMA Band II\_RMC 12.2K\_Back\_1.0cm\_Ch9262

Communication System: WCDMA ; Frequency: 1852.4 MHz;Duty Cycle: 1:1

Medium: MSL\_1900\_150205 Medium parameters used:  $f = 1852.4$  MHz;  $\sigma = 1.496$  S/m;  $\epsilon_r = 52.635$ ;

$\rho = 1000$  kg/m<sup>3</sup>

Ambient Temperature : 23.5 °C ; Liquid Temperature : 22.5 °C

DASY5 Configuration:

- Probe: EX3DV4 - SN3911; ConvF(7.57, 7.57, 7.57); Calibrated: 2014/10/2;
- Sensor-Surface: 2mm (Mechanical Surface Detection)
- Electronics: DAE4 Sn1358; Calibrated: 2014/4/30
- Phantom: SAM2; Type: QD000P40CD; Serial: TP:1754
- Measurement SW: DASY52, Version 52.8 (5); SEMCAD X Version 14.6.8 (7028)

**Ch9262/Area Scan (61x121x1):** Interpolated grid: dx=15mm, dy=15mm

Maximum value of SAR (interpolated) = 1.41 W/kg

**Ch9262/Zoom Scan (5x5x7)/Cube 0:** Measurement grid: dx=8mm, dy=8mm, dz=5mm

Reference Value = 14.600 V/m; Power Drift = 0.01 dB

Peak SAR (extrapolated) = 1.83 W/kg

**SAR(1 g) = 1.08 W/kg; SAR(10 g) = 0.588 W/kg**

Maximum value of SAR (measured) = 1.39 W/kg

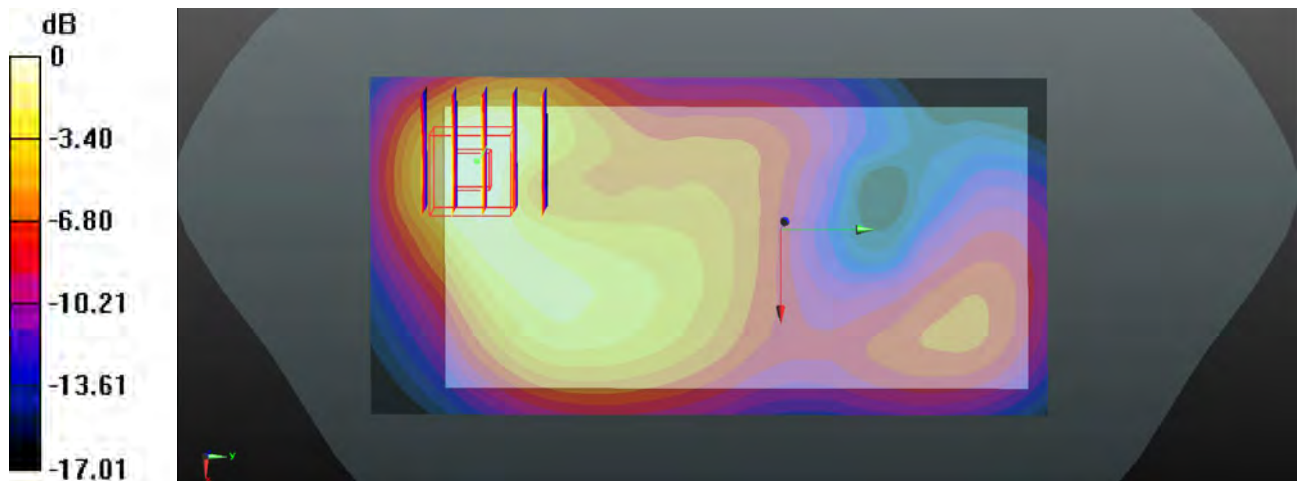

0 dB = 1.39 W/kg

### #16 WLAN 2.4GHz\_802.11b\_Back\_1.0cm\_Ch11

Communication System: 802.11b; Frequency: 2462 MHz; Duty Cycle: 1:1

Medium: MSL\_2450\_150212 Medium parameters used:  $f = 2462$  MHz;  $\sigma = 1.974$  S/m;  $\epsilon_r = 53.843$ ;  $\rho = 1000$  kg/m<sup>3</sup>

Ambient Temperature : 23.5 °C ; Liquid Temperature : 22.6 °C

DASY5 Configuration:

- Probe: EX3DV4 - SN3911; ConvF(7.18, 7.18, 7.18); Calibrated: 2014/10/2;
- Sensor-Surface: 2mm (Mechanical Surface Detection)
- Electronics: DAE4 Sn1358; Calibrated: 2014/4/30
- Phantom: SAM2; Type: QD000P40CD; Serial: TP:1754
- Measurement SW: DASY52, Version 52.8 (5); SEMCAD X Version 14.6.8 (7028)

**Ch11/Area Scan (81x151x1):** Interpolated grid: dx=12mm, dy=12mm

Maximum value of SAR (interpolated) = 0.412 W/kg

**Ch11/Zoom Scan (7x7x7)/Cube 0:** Measurement grid: dx=5mm, dy=5mm, dz=5mm

Reference Value = 3.007 V/m; Power Drift = 0.08 dB

Peak SAR (extrapolated) = 0.573 W/kg

**SAR(1 g) = 0.299 W/kg; SAR(10 g) = 0.153 W/kg**

Maximum value of SAR (measured) = 0.427 W/kg

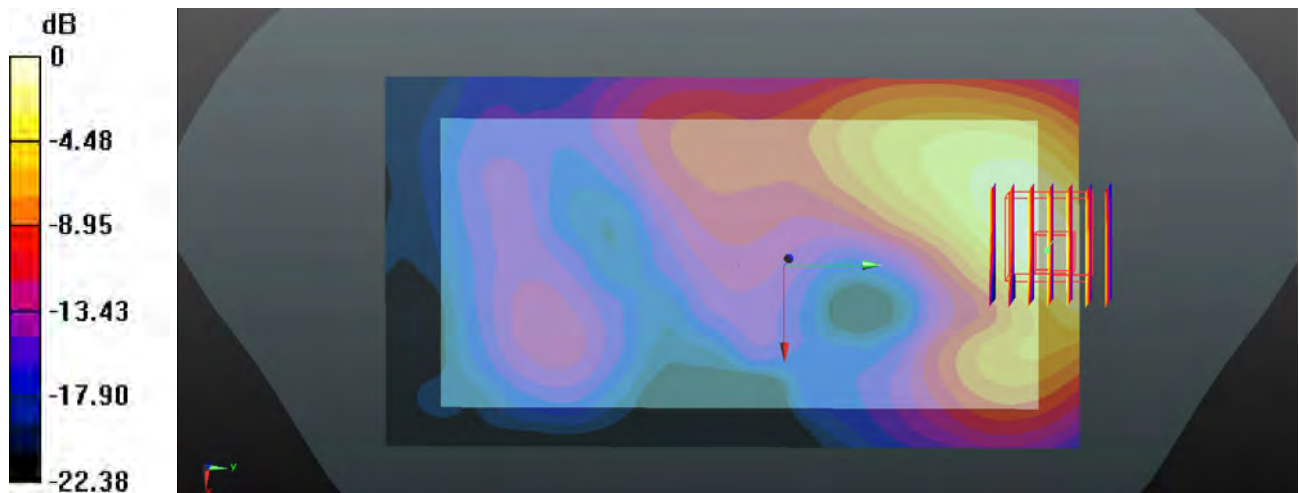

0 dB = 0.427 W/kg

### #17 GSM1900\_GPRS (GMSK 4 Tx slots)\_Bottom side\_0cm\_Ch512\_Hand SAR

Communication System: GPRS (GMSK 4 Tx slot); Frequency: 1850.2 MHz; Duty Cycle: 1:2.08

Medium: MSL\_1900\_150205 Medium parameters used:  $f = 1850.2$  MHz;  $\sigma = 1.493$  S/m;  $\epsilon_r = 52.639$ ;

$\rho = 1000$  kg/m<sup>3</sup>

Ambient Temperature : 23.5 °C ; Liquid Temperature : 22.5 °C

DASY5 Configuration:

- Probe: EX3DV4 - SN3911; ConvF(7.57, 7.57, 7.57); Calibrated: 2014/10/2;
- Sensor-Surface: 2mm (Mechanical Surface Detection)
- Electronics: DAE4 Sn1358; Calibrated: 2014/4/30
- Phantom: SAM2; Type: QD000P40CD; Serial: TP:1754
- Measurement SW: DASY52, Version 52.8 (5); SEMCAD X Version 14.6.8 (7028)

**Ch512/Area Scan (31x71x1):** Interpolated grid: dx=15mm, dy=15mm

Maximum value of SAR (interpolated) = 11.4 W/kg

**Ch512/Zoom Scan (5x5x7)/Cube 0:** Measurement grid: dx=8mm, dy=8mm, dz=5mm

Reference Value = 40.472 V/m; Power Drift = 0.02 dB

Peak SAR (extrapolated) = 15.6 W/kg

**SAR(1 g) = 6.71 W/kg; SAR(10 g) = 2.61 W/kg**

Maximum value of SAR (measured) = 8.93 W/kg

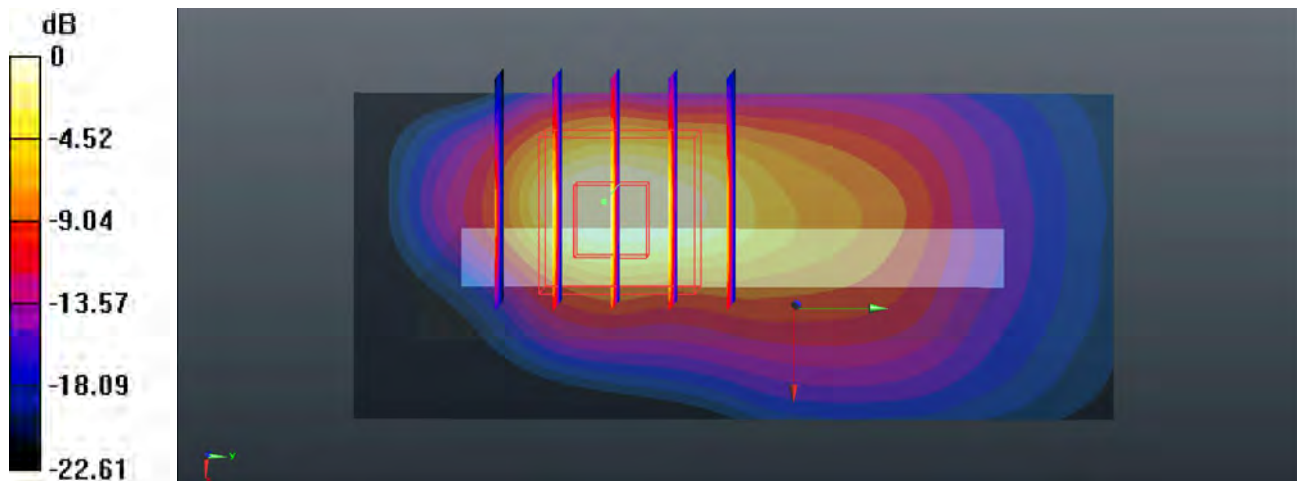

0 dB = 8.93 W/kg



### #18 WCDMA Band IV\_RMC 12.2k\_Bottom side\_1.0cm\_Ch1413\_Hand SAR

Communication System: WCDMA ; Frequency: 1732.6 MHz;Duty Cycle: 1:1

Medium: MSL\_1750\_150211 Medium parameters used:  $f = 3954\text{8 MHz}$ ;  $\sigma = 1.511 \text{ S/m}$ ;  $\epsilon_r = 54.266$ ;  $\rho = 1000 \text{ kg/m}^3$

Ambient Temperature : 23.5 °C ; Liquid Temperature : 22.6 °C

DASY5 Configuration:

- Probe: EX3DV4 - SN3911; ConvF(7.93, 7.93, 7.93); Calibrated: 2014/10/2;
- Sensor-Surface: 2mm (Mechanical Surface Detection)
- Electronics: DAE4 Sn1358; Calibrated: 2014/4/30
- Phantom: SAM2; Type: QD000P40CD; Serial: TP:1754
- Measurement SW: DASY52, Version 52.8 (5); SEMCAD X Version 14.6.8 (7028)

**Ch1413/Area Scan (31x71x1):** Interpolated grid: dx=15mm, dy=15mm

Maximum value of SAR (interpolated) = 9.78 W/kg

**Ch1413/Zoom Scan (5x5x7)/Cube 0:** Measurement grid: dx=8mm, dy=8mm, dz=5mm

Reference Value = 36.141 V/m; Power Drift = 0.16 dB

Peak SAR (extrapolated) = 15.9 W/kg

**SAR(1 g) = 6.49 W/kg; SAR(10 g) = 2.47 W/kg**

Maximum value of SAR (measured) = 9.74 W/kg

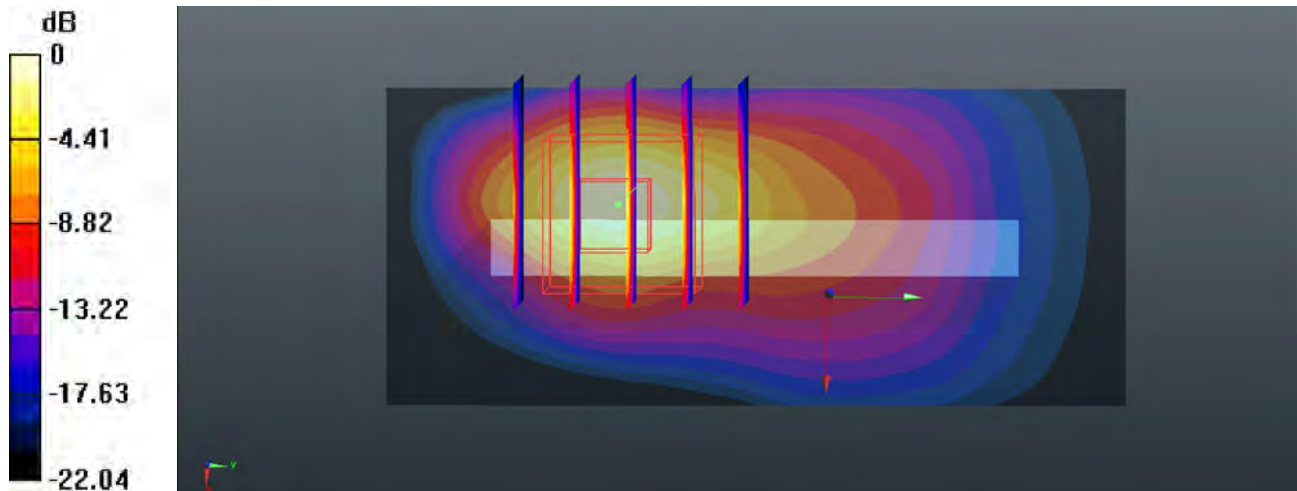

0 dB = 9.74 W/kg

**#19 WCDMA Band II\_RMC 12.2K\_Bottom side\_0cm\_Ch9262\_Hand SAR**

Communication System: WCDMA ; Frequency: 1852.4 MHz;Duty Cycle: 1:1

Medium: MSL\_1900\_150205 Medium parameters used:  $f = 1852.4$  MHz;  $\sigma = 1.496$  S/m;  $\epsilon_r = 52.635$ ;

$\rho = 1000$  kg/m<sup>3</sup>

Ambient Temperature : 23.5 °C ; Liquid Temperature : 22.5 °C

DASY5 Configuration:

- Probe: EX3DV4 - SN3911; ConvF(7.57, 7.57, 7.57); Calibrated: 2014/10/2;
- Sensor-Surface: 2mm (Mechanical Surface Detection)
- Electronics: DAE4 Sn1358; Calibrated: 2014/4/30
- Phantom: SAM2; Type: QD000P40CD; Serial: TP:1754
- Measurement SW: DASY52, Version 52.8 (5); SEMCAD X Version 14.6.8 (7028)

**Ch9262/Area Scan (31x71x1):** Interpolated grid: dx=15mm, dy=15mm

Maximum value of SAR (interpolated) = 13.7 W/kg

**Ch9262/Zoom Scan (5x5x7)/Cube 0:** Measurement grid: dx=8mm, dy=8mm, dz=5mm

Reference Value = 43.854 V/m; Power Drift = 0.15 dB

Peak SAR (extrapolated) = 21.2 W/kg

**SAR(1 g) = 8.92 W/kg; SAR(10 g) = 3.42 W/kg**

Maximum value of SAR (measured) = 13.2 W/kg

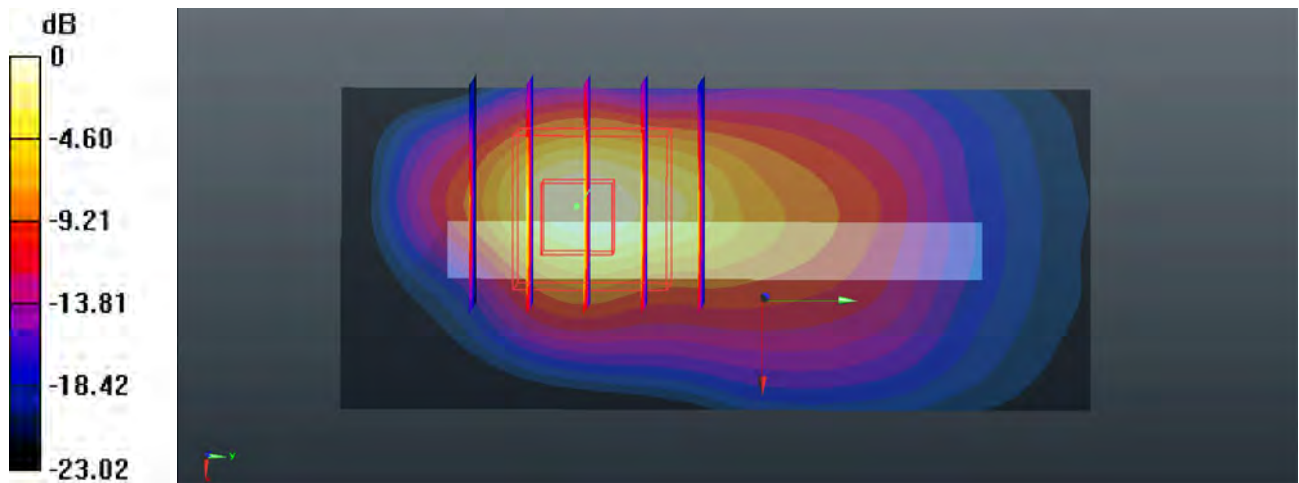

0 dB = 13.2 W/kg



---

**Appendix C. DASYS Calibration Certificate**

The DASYS calibration certificates are shown as follows.



Accredited by the Swiss Accreditation Service (SAS)  
The Swiss Accreditation Service is one of the signatories to the EA  
Multilateral Agreement for the recognition of calibration certificates

Accreditation No.: **SCS 108**

Client **Sporton-KS (Auden)**

Certificate No: **D835V2-4d151\_Mar13**

## CALIBRATION CERTIFICATE

Object **D835V2 - SN: 4d151**

Calibration procedure(s) **QA CAL-05.v9  
Calibration procedure for dipole validation kits above 700 MHz**

Calibration date: **March 25, 2013**

This calibration certificate documents the traceability to national standards, which realize the physical units of measurements (SI).  
The measurements and the uncertainties with confidence probability are given on the following pages and are part of the certificate.

All calibrations have been conducted in the closed laboratory facility; environment temperature  $(22 \pm 3)^{\circ}\text{C}$  and humidity  $< 70\%$ .

Calibration Equipment used (M&TE critical for calibration)

Primary Standards	ID #	Cal Date (Certificate No.)	Scheduled Calibration
Power meter EPM-442A	GS37480704	01-Nov-12 (No. 217-01940)	Oct-13
Power sensor HP 8481A	US37292783	01-Nov-12 (No. 217-01640)	Oct-13
Reference 20 dB Attenuator	SN: 5058 (20k)	27-Mar-12 (No. 217-01530)	Apr-13
Type-N mismatch combination	SN: 5047.3 / 06327	27-Mar-12 (No. 217-01533)	Apr-13
Reference Probe ES3DV3	SN: 3205	28-Dec-12 (No. ES3-3205_Dec12)	Dec-13
D4E4	SN: 601	27-Jun-12 (No. D4E4-601_Jun12)	Jun-13

Secondary Standards	ID #	Check Date (in house)	Scheduled Check
Power sensor HP 8481A	MY41092317	18-Oct-02 (in house check Oct-11)	In house check: Oct-13
RF generator R&S SMT-06	100005	04-Aug-99 (in house check Oct-11)	In house check: Oct-13
Network Analyzer HP 8753E	US37990585 S4206	18-Oct-01 (in house check Oct-12)	In house check: Oct-13

	Name	Function	Signature
Calibrated by:	Jeton Kastati	Laboratory Technician	
Approved by:	Katja Pokovic	Technical Manager	

Issued: March 26, 2013

This calibration certificate shall not be reproduced except in full without written approval of the laboratory.

## Calibration Laboratory of

Schmid & Partner

Engineering AG

Zeughausstrasse 43, 8004 Zurich, Switzerland



S Schweizerischer Kalibrierdienst  
C Service suisse d'étalonnage  
S Servizio svizzero di taratura  
S Swiss Calibration Service

Accredited by the Swiss Accreditation Service (SAS)

The Swiss Accreditation Service is one of the signatories to the EA Multilateral Agreement for the recognition of calibration certificates

Accreditation No.: SCS 108

### Glossary:

TSL	tissue simulating liquid
ConvF	sensitivity in TSL / NORM $x,y,z$
N/A	not applicable or not measured

### Calibration is Performed According to the Following Standards:

- IEEE Std 1528-2003, "IEEE Recommended Practice for Determining the Peak Spatial-Averaged Specific Absorption Rate (SAR) in the Human Head from Wireless Communications Devices: Measurement Techniques", December 2003
- IEC 62209-1, "Procedure to measure the Specific Absorption Rate (SAR) for hand-held devices used in close proximity to the ear (frequency range of 300 MHz to 3 GHz)", February 2005
- Federal Communications Commission Office of Engineering & Technology (FCC OET), "Evaluating Compliance with FCC Guidelines for Human Exposure to Radiofrequency Electromagnetic Fields; Additional Information for Evaluating Compliance of Mobile and Portable Devices with FCC Limits for Human Exposure to Radiofrequency Emissions", Supplement C (Edition 01-01) to Bulletin 65

### Additional Documentation:

- DASY4/5 System Handbook

### Methods Applied and Interpretation of Parameters:

- Measurement Conditions:** Further details are available from the Validation Report at the end of the certificate. All figures stated in the certificate are valid at the frequency indicated.
- Antenna Parameters with TSL:** The dipole is mounted with the spacer to position its feed point exactly below the center marking of the flat phantom section, with the arms oriented parallel to the body axis.
- Feed Point Impedance and Return Loss:** These parameters are measured with the dipole positioned under the liquid filled phantom. The impedance stated is transformed from the measurement at the SMA connector to the feed point. The Return Loss ensures low reflected power. No uncertainty required.
- Electrical Delay:** One-way delay between the SMA connector and the antenna feed point. No uncertainty required.
- SAR measured:** SAR measured at the stated antenna input power.
- SAR normalized:** SAR as measured, normalized to an input power of 1 W at the antenna connector.
- SAR for nominal TSL parameters:** The measured TSL parameters are used to calculate the nominal SAR result.

The reported uncertainty of measurement is stated as the standard uncertainty of measurement multiplied by the coverage factor  $k=2$ , which for a normal distribution corresponds to a coverage probability of approximately 95%.

## Measurement Conditions

DASY system configuration, as far as not given on page 1.

DASY Version	DASY5	V52.8.5
Extrapolation	Advanced Extrapolation	
Phantom	Modular Flat Phantom	
Distance Dipole Center - TSL	15 mm	with Spacer
Zoom Scan Resolution	dx, dy, dz = 5 mm	
Frequency	835 MHz $\pm$ 1 MHz	

## Head TSL parameters

The following parameters and calculations were applied.

	Temperature	Permittivity	Conductivity
Nominal Head TSL parameters	22.0 °C	41.5	0.90 mho/m
Measured Head TSL parameters	(22.0 $\pm$ 0.2) °C	40.9 $\pm$ 6 %	0.94 mho/m $\pm$ 6 %
Head TSL temperature change during test	< 0.5 °C	—	—

## SAR result with Head TSL

SAR averaged over 1 cm <sup>3</sup> (1 g) of Head TSL	Condition	
SAR measured	250 mW input power	2.46 W/kg
SAR for nominal Head TSL parameters	normalized to 1W	<b>9.49 W/kg <math>\pm</math> 17.0 % (k=2)</b>

SAR averaged over 10 cm <sup>3</sup> (10 g) of Head TSL	condition	
SAR measured	250 mW input power	1.59 W/kg
SAR for nominal Head TSL parameters	normalized to 1W	<b>6.18 W/kg <math>\pm</math> 16.5 % (k=2)</b>

## Body TSL parameters

The following parameters and calculations were applied.

	Temperature	Permittivity	Conductivity
Nominal Body TSL parameters	22.0 °C	55.2	0.97 mho/m
Measured Body TSL parameters	(22.0 $\pm$ 0.2) °C	54.1 $\pm$ 6 %	1.02 mho/m $\pm$ 6 %
Body TSL temperature change during test	< 0.5 °C	—	—

## SAR result with Body TSL

SAR averaged over 1 cm <sup>3</sup> (1 g) of Body TSL	Condition	
SAR measured	250 mW input power	2.46 W/kg
SAR for nominal Body TSL parameters	normalized to 1W	<b>9.43 W/kg <math>\pm</math> 17.0 % (k=2)</b>

SAR averaged over 10 cm <sup>3</sup> (10 g) of Body TSL	condition	
SAR measured	250 mW input power	1.61 W/kg
SAR for nominal Body TSL parameters	normalized to 1W	<b>6.23 W/kg <math>\pm</math> 16.5 % (k=2)</b>

## Appendix

### Antenna Parameters with Head TSL

Impedance, transformed to feed point	51.7 $\Omega$ - 2.2 $j\Omega$
Return Loss	- 31.2 dB

### Antenna Parameters with Body TSL

Impedance, transformed to feed point	47.1 $\Omega$ - 4.3 $j\Omega$
Return Loss	- 25.4 dB

### General Antenna Parameters and Design

Electrical Delay (one direction)	1.391 ns
----------------------------------	----------

After long term use with 100W radiated power, only a slight warming of the dipole near the feedpoint can be measured.

The dipole is made of standard semirigid coaxial cable. The center conductor of the feeding line is directly connected to the second arm of the dipole. The antenna is therefore short-circuited for DC-signals. On some of the dipoles, small end caps are added to the dipole arms in order to improve matching when loaded according to the position as explained in the "Measurement Conditions" paragraph. The SAR data are not affected by this change. The overall dipole length is still according to the Standard.

No excessive force must be applied to the dipole arms, because they might bend or the soldered connections near the feedpoint may be damaged.

### Additional EUT Data

Manufactured by	SPEAG
Manufactured on	March 27, 2012

## DASY5 Validation Report for Head TSL

Date: 25.03.2013

Test Laboratory: SPEAG, Zurich, Switzerland

**DUT: Dipole 835 MHz; Type: D835V2; Serial: D835V2 - SN: 4d151**

Communication System: CW; Frequency: 835 MHz

Medium parameters used:  $f = 835$  MHz;  $\sigma = 0.94$  S/m;  $\epsilon_r = 40.9$ ;  $\rho = 1000$  kg/m<sup>3</sup>

Phantom section: Flat Section

Measurement Standard: DASY5 (IEEE/IEC/ANSI C63.19-2007)

DASY52 Configuration:

- Probe: ES3DV3 - SN3205; ConvF(6.05, 6.05, 6.05); Calibrated: 28.12.2012;
- Sensor-Surface: 3mm (Mechanical Surface Detection)
- Electronics: DAE4 Sn601; Calibrated: 27.06.2012
- Phantom: Flat Phantom 4.9L; Type: QD000P49AA; Serial: 1001
- DASY52 52.8.5(1059); SEMCAD X 14.6.8(7028)

### Dipole Calibration for Head Tissue/Pin=250 mW, d=15mm/Zoom Scan (7x7x7)/Cube 0:

Measurement grid:  $dx=5$ mm,  $dy=5$ mm,  $dz=5$ mm

Reference Value = 56.742 V/m; Power Drift = 0.01 dB

Peak SAR (extrapolated) = 3.74 W/kg

**SAR(1 g) = 2.46 W/kg; SAR(10 g) = 1.59 W/kg**

Maximum value of SAR (measured) = 2.88 W/kg

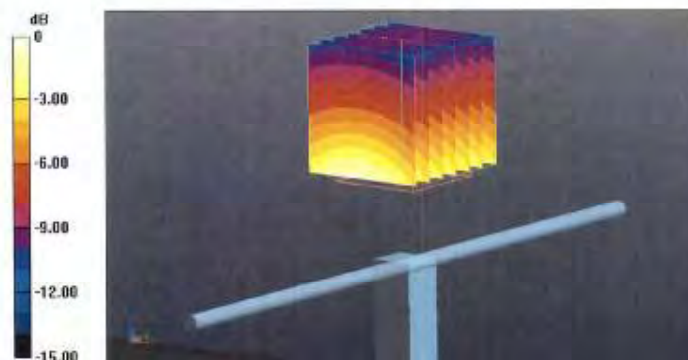

0 dB = 2.88 W/kg = 4.59 dBW/kg



# Impedance Measurement Plot for Head TSL

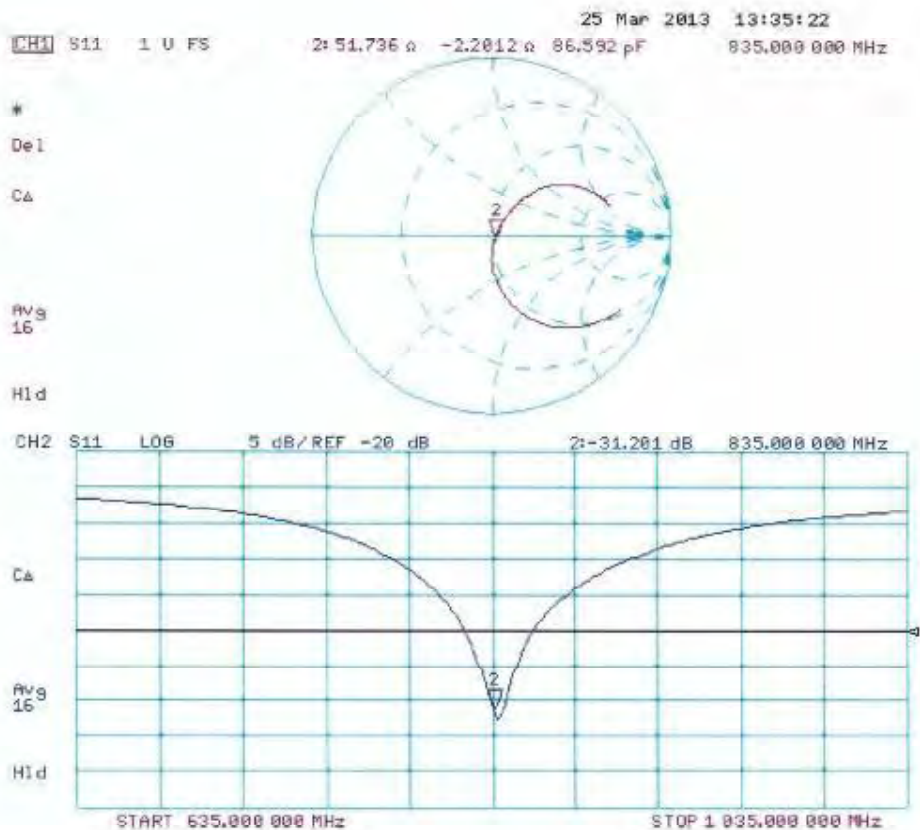

## DASY5 Validation Report for Body TSL

Date: 25.03.2013

Test Laboratory: SPEAG, Zurich, Switzerland

**DUT: Dipole 835 MHz; Type: D835V2; Serial: D835V2 - SN: 4d151**

Communication System: CW; Frequency: 835 MHz

Medium parameters used:  $f = 835$  MHz;  $\sigma = 1.02$  S/m;  $\epsilon_r = 54.1$ ;  $\rho = 1000$  kg/m<sup>3</sup>

Phantom section: Flat Section

Measurement Standard: DASY5 (IEEE/IEC/ANSI C63.19-2007)

DASY52 Configuration:

- Probe: ES3DV3 - SN3205; ConvF(6.04, 6.04, 6.04); Calibrated: 28.12.2012;
- Sensor-Surface: 3mm (Mechanical Surface Detection)
- Electronics: DAE4 Sn601; Calibrated: 27.06.2012
- Phantom: Flat Phantom 4.9L; Type: QD000P49AA; Serial: 1001
- DASY52 52.8.5(1059); SEMCAD X 14.6.8(7028)

### Dipole Calibration for Body Tissue/Pin=250 mW, d=15mm/Zoom Scan (7x7x7)/Cube 0:

Measurement grid: dx=5mm, dy=5mm, dz=5mm

Reference Value = 54.816 V/m; Power Drift = 0.01 dB

Peak SAR (extrapolated) = 3.63 W/kg

**SAR(1 g) = 2.46 W/kg; SAR(10 g) = 1.61 W/kg**

Maximum value of SAR (measured) = 2.87 W/kg

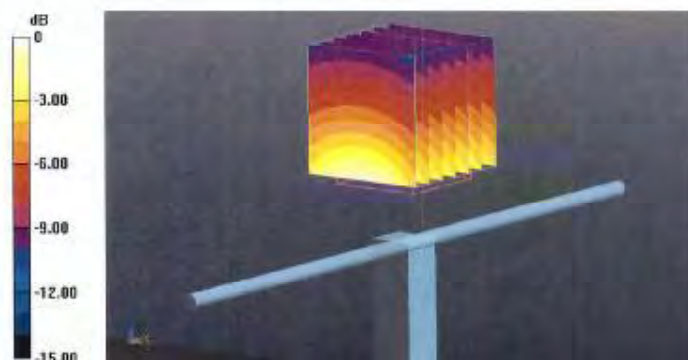

0 dB = 2.87 W/kg = 4.58 dBW/kg

# Impedance Measurement Plot for Body TSL

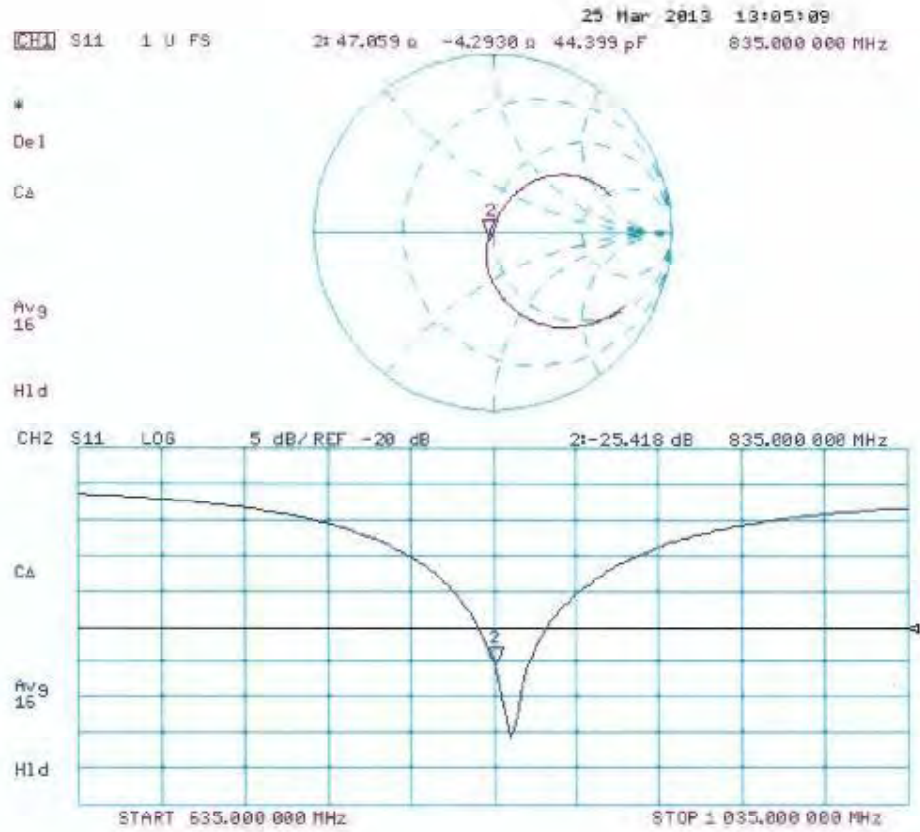



## Extended Dipole Calibrations

Referring to KDB 865664 D01 v01r03, if dipoles are verified in return loss ( $< -20\text{dB}$ , within 20% of prior calibration), and in impedance (within 5 ohm of prior calibration), the annual calibration is not necessary and the calibration interval can be extended.

**<Dipole Verification Data> - D835V2, serial no. 4d151(Date of Measurement 03.24.2014)**

### 835MHz - Head

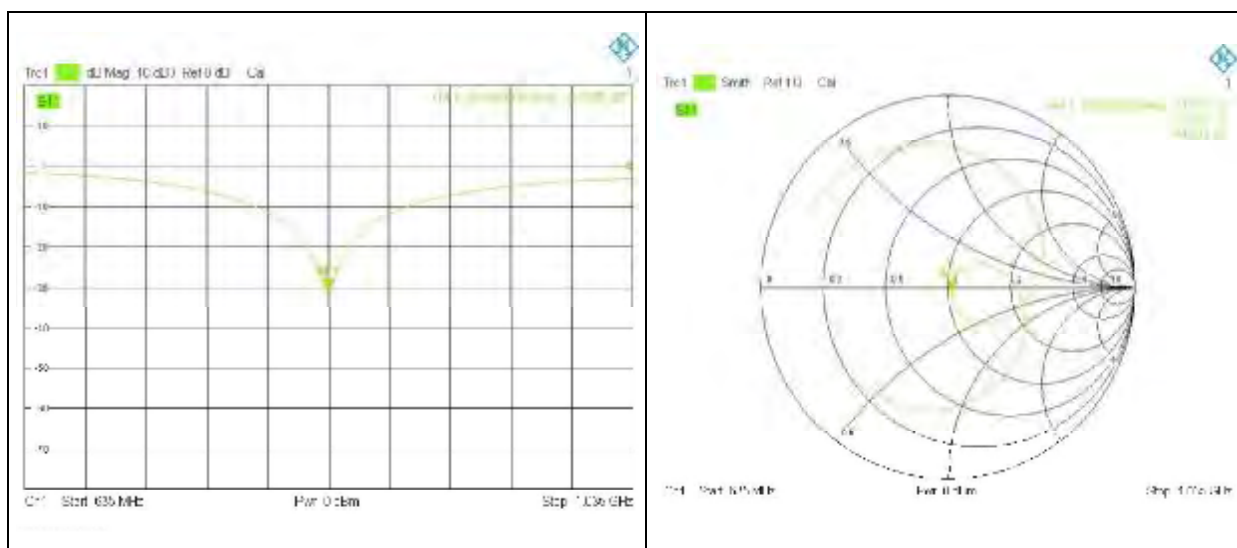

### 835MHz - Body

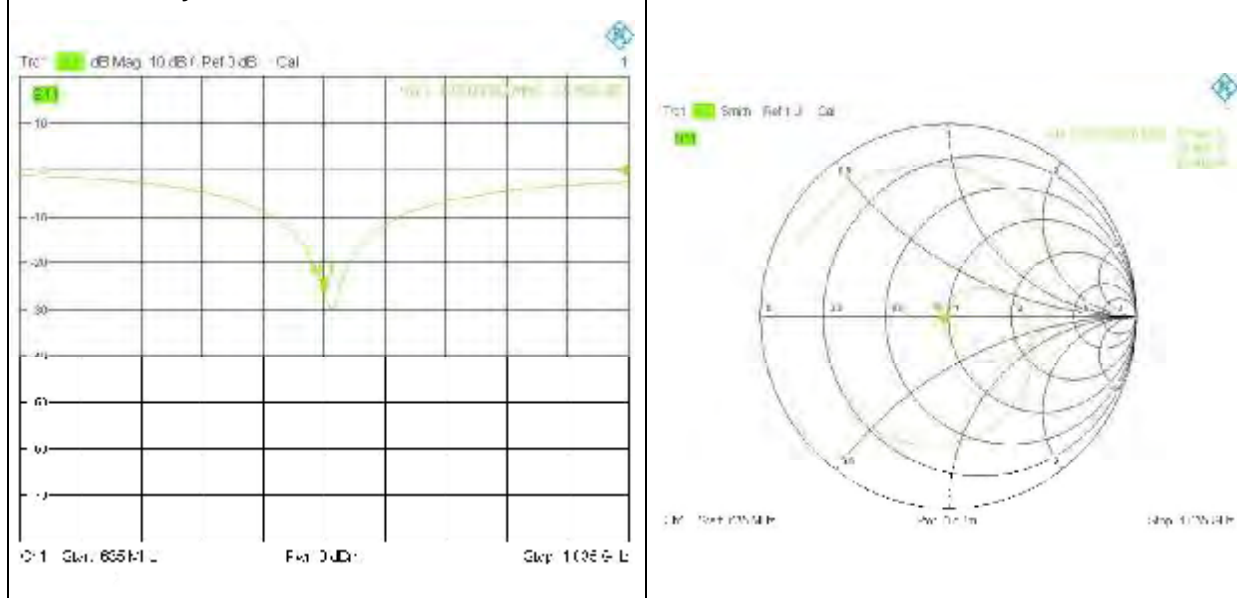

**SPORTON INTERNATIONAL INC.**

TEL : 886-3-327-3456

FAX : 886-3-328-4978



**<Justification of the extended calibration>**

D835V2 – serial no. 4d151												
TSL	Head						Body					
Date of Measurement	Return-Loss (dB)	Delta (%)	Real Impedance (ohm)	Delta (ohm)	Imaginary Impedance (ohm)	Delta (ohm)	Return-Loss (dB)	Delta (%)	Real Impedance (ohm)	Delta (ohm)	Imaginary Impedance (ohm)	Delta (ohm)
03.25.2013	-31.201		51.736		-2.201		-25.418		47.059		-4.2930	
03.24.2014	-30.505	2.23	51.767	0.031	-2.252	-0.051	-25.828	-1.613	47.599	0.54	-4.453	-0.16

The return loss is < -20dB, within 20% of prior calibration; the impedance is within 5 ohm of prior calibration.

Therefore the verification result should support extended calibration.



Accredited by the Swiss Accreditation Service (SAS)  
The Swiss Accreditation Service is one of the signatories to the EA  
Multilateral Agreement for the recognition of calibration certificates

Accreditation No.: **SCS 108**

Client **Sporton KS (Auden)**

Certificate No: **D1750V2-1090\_Mar13**

## CALIBRATION CERTIFICATE

Object **D1750V2 - SN: 1090**

Calibration procedure(s) **QA CAL-05.v9  
Calibration procedure for dipole validation kits above 700 MHz**

Calibration date: **March 27, 2013**

This calibration certificate documents the traceability to national standards, which realize the physical units of measurements (SI).  
The measurements and the uncertainties with confidence probability are given on the following pages and are part of the certificate.

All calibrations have been conducted in the closed laboratory facility: environment temperature (22 ± 3)°C and humidity < 70%.

Calibration Equipment used (M&TE critical for calibration)

Primary Standards	ID #	Cal Date (Certificate No.)	Scheduled Calibration
Power meter EPM-412A	GB37480704	01-Nov-12 (No. 217-01640)	Oct-13
Power sensor HP 8481A	US37292783	01-Nov-12 (No. 217-01640)	Oct-13
Reference 20 dB Attenuator	SN: 5058 (20k)	27-Mar-12 (No. 217-01530)	Apr-13
Type-N mismatch combination	SN: 5047.3 / 06327	27-Mar-12 (No. 217-01533)	Apr-13
Reference Probe ES3DV3	SN: 3205	28-Dec-12 (No. ES3-3205_Dec12)	Dec-13
DAE4	SN: 601	27-Jun-12 (No. DAE4-601_Jun12)	Jun-13
Secondary Standards	ID #	Check Date (in house)	Scheduled Check
Power sensor HP 8481A	MY41092317	18-Oct-02 (in house check Oct-11)	In house check: Oct-13
RF generator R&S SMT-08	100005	04-Aug-99 (in house check Oct-11)	In house check: Oct-13
Network Analyzer HP 8753E	US37390585 S4206	18-Oct-01 (in house check Oct-12)	In house check: Oct-13

Calibrated by:	<b>Name</b> Leif Klysner	<b>Function</b> Laboratory Technician	<b>Signature</b> 
Approved by:	<b>Name</b> Katja Pokovic	<b>Function</b> Technical Manager	<b>Signature</b> 

Issued: March 27, 2013

This calibration certificate shall not be reproduced except in full without written approval of the laboratory.



Accredited by the Swiss Accreditation Service (SAS)  
The Swiss Accreditation Service is one of the signatories to the EA  
Multilateral Agreement for the recognition of calibration certificates

Accreditation No.: **SCS 108**

**Glossary:**

TSL	tissue simulating liquid
ConvF	sensitivity in TSL / NORM x,y,z
N/A	not applicable or not measured

**Calibration is Performed According to the Following Standards:**

- IEEE Std 1528-2003, "IEEE Recommended Practice for Determining the Peak Spatial-Averaged Specific Absorption Rate (SAR) in the Human Head from Wireless Communications Devices: Measurement Techniques", December 2003
- IEC 62209-1, "Procedure to measure the Specific Absorption Rate (SAR) for hand-held devices used in close proximity to the ear (frequency range of 300 MHz to 3 GHz)", February 2005
- Federal Communications Commission Office of Engineering & Technology (FCC OET), "Evaluating Compliance with FCC Guidelines for Human Exposure to Radiofrequency Electromagnetic Fields; Additional Information for Evaluating Compliance of Mobile and Portable Devices with FCC Limits for Human Exposure to Radiofrequency Emissions", Supplement C (Edition 01-01) to Bulletin 65

**Additional Documentation:**

- DASY4/5 System Handbook

**Methods Applied and Interpretation of Parameters:**

- Measurement Conditions:* Further details are available from the Validation Report at the end of the certificate. All figures stated in the certificate are valid at the frequency indicated.
- Antenna Parameters with TSL:* The dipole is mounted with the spacer to position its feed point exactly below the center marking of the flat phantom section, with the arms oriented parallel to the body axis.
- Feed Point Impedance and Return Loss:* These parameters are measured with the dipole positioned under the liquid filled phantom. The impedance stated is transformed from the measurement at the SMA connector to the feed point. The Return Loss ensures low reflected power. No uncertainty required.
- Electrical Delay:* One-way delay between the SMA connector and the antenna feed point. No uncertainty required.
- SAR measured:* SAR measured at the stated antenna input power.
- SAR normalized:* SAR as measured, normalized to an input power of 1 W at the antenna connector.
- SAR for nominal TSL parameters:* The measured TSL parameters are used to calculate the nominal SAR result.

The reported uncertainty of measurement is stated as the standard uncertainty of measurement multiplied by the coverage factor  $k=2$ , which for a normal distribution corresponds to a coverage probability of approximately 95%.

## Measurement Conditions

DASY system configuration, as far as not given on page 1.

DASY Version	DASY5	V52.8.5
Extrapolation	Advanced Extrapolation	
Phantom	Modular Flat Phantom	
Distance Dipole Center - TSL	10 mm	with Spacer
Zoom Scan Resolution	dx, dy, dz = 5 mm	
Frequency	1750 MHz ± 1 MHz	

## Head TSL parameters

The following parameters and calculations were applied

	Temperature	Permittivity	Conductivity
Nominal Head TSL parameters	22.0 °C	40.1	1.37 mho/m
Measured Head TSL parameters	(22.0 ± 0.2) °C	39.1 ± 6 %	1.35 mho/m ± 6 %
Head TSL temperature change during test	< 0.5 °C	----	----

## SAR result with Head TSL

SAR averaged over 1 cm <sup>3</sup> (1 g) of Head TSL	Condition	
SAR measured	250 mW input power	9.20 W/kg
SAR for nominal Head TSL parameters	normalized to 1W	<b>36.9 W/kg ± 17.0 % (k=2)</b>

SAR averaged over 10 cm <sup>3</sup> (10 g) of Head TSL	condition	
SAR measured	250 mW input power	4.90 W/kg
SAR for nominal Head TSL parameters	normalized to 1W	<b>19.6 W/kg ± 16.5 % (k=2)</b>

## Body TSL parameters

The following parameters and calculations were applied.

	Temperature	Permittivity	Conductivity
Nominal Body TSL parameters	22.0 °C	53.4	1.49 mho/m
Measured Body TSL parameters	(22.0 ± 0.2) °C	51.5 ± 6 %	1.48 mho/m ± 6 %
Body TSL temperature change during test	< 0.5 °C	----	----

## SAR result with Body TSL

SAR averaged over 1 cm <sup>3</sup> (1 g) of Body TSL	Condition	
SAR measured	250 mW input power	9.57 W/kg
SAR for nominal Body TSL parameters	normalized to 1W	<b>38.1 W/kg ± 17.0 % (k=2)</b>

SAR averaged over 10 cm <sup>3</sup> (10 g) of Body TSL	condition	
SAR measured	250 mW input power	5.14 W/kg
SAR for nominal Body TSL parameters	normalized to 1W	<b>20.5 W/kg ± 16.5 % (k=2)</b>



## Appendix

### Antenna Parameters with Head TSL

Impedance, transformed to feed point	49.8 $\Omega$ - 0.8 $j\Omega$
Return Loss	- 41.8 dB

### Antenna Parameters with Body TSL

Impedance, transformed to feed point	45.3 $\Omega$ + 0.2 $j\Omega$
Return Loss	- 26.2 dB

### General Antenna Parameters and Design

Electrical Delay (one direction)	1.221 ns
----------------------------------	----------

After long term use with 100W radiated power, only a slight warming of the dipole near the feedpoint can be measured.

The dipole is made of standard semirigid coaxial cable. The center conductor of the feeding line is directly connected to the second arm of the dipole. The antenna is therefore short-circuited for DC-signals. On some of the dipoles, small end caps are added to the dipole arms in order to improve matching when loaded according to the position as explained in the "Measurement Conditions" paragraph. The SAR data are not affected by this change. The overall dipole length is still according to the Standard.

No excessive force must be applied to the dipole arms, because they might bend or the soldered connections near the feedpoint may be damaged.

### Additional EUT Data

Manufactured by	SPEAG
Manufactured on	November 07, 2012

## DASY5 Validation Report for Head TSL

Date: 27.03.2013

Test Laboratory: SPEAG, Zurich, Switzerland

**DUT: Dipole 1750 MHz; Type: D1750V2; Serial: D1750V2 - SN: 1090**

Communication System: CW; Frequency: 1750 MHz

Medium parameters used:  $f = 1750$  MHz;  $\sigma = 1.35$  S/m;  $\epsilon_r = 39.1$ ;  $\rho = 1000$  kg/m<sup>3</sup>

Phantom section: Flat Section

Measurement Standard: DASY5 (IEEE/IEC/ANSI C63.19-2007)

DASY52 Configuration:

- Probe: ES3DV3 - SN3205; ConvF(5.18, 5.18, 5.18); Calibrated: 28.12.2012;
- Sensor-Surface: 3mm (Mechanical Surface Detection)
- Electronics: DAE4 Sn601; Calibrated: 27.06.2012
- Phantom: Flat Phantom 5.0 (front); Type: QD000P50AA; Serial: 1001
- DASY52 52.8.5(1059); SEMCAD X 14.6.8(7028)

### Dipole Calibration for Head Tissue/Pin=250 mW, d=10mm/Zoom Scan (7x7x7)/Cube 0:

Measurement grid: dx=5mm, dy=5mm, dz=5mm

Reference Value = 94.130 V/m; Power Drift = 0.00 dB

Peak SAR (extrapolated) = 16.6 W/kg

**SAR(1 g) = 9.2 W/kg; SAR(10 g) = 4.9 W/kg**

Maximum value of SAR (measured) = 11.3 W/kg

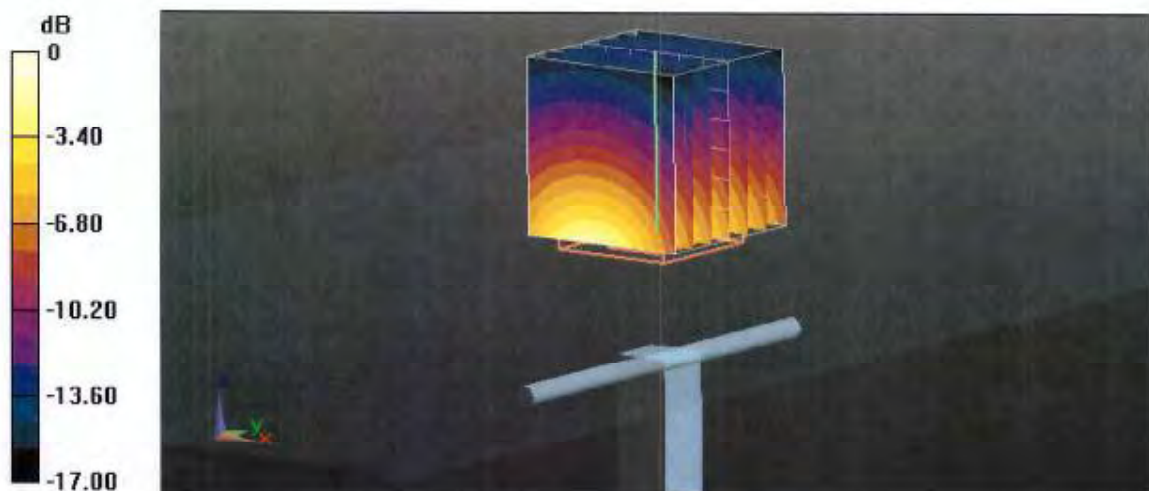

0 dB = 11.3 W/kg = 10.53 dBW/kg

# Impedance Measurement Plot for Head TSL

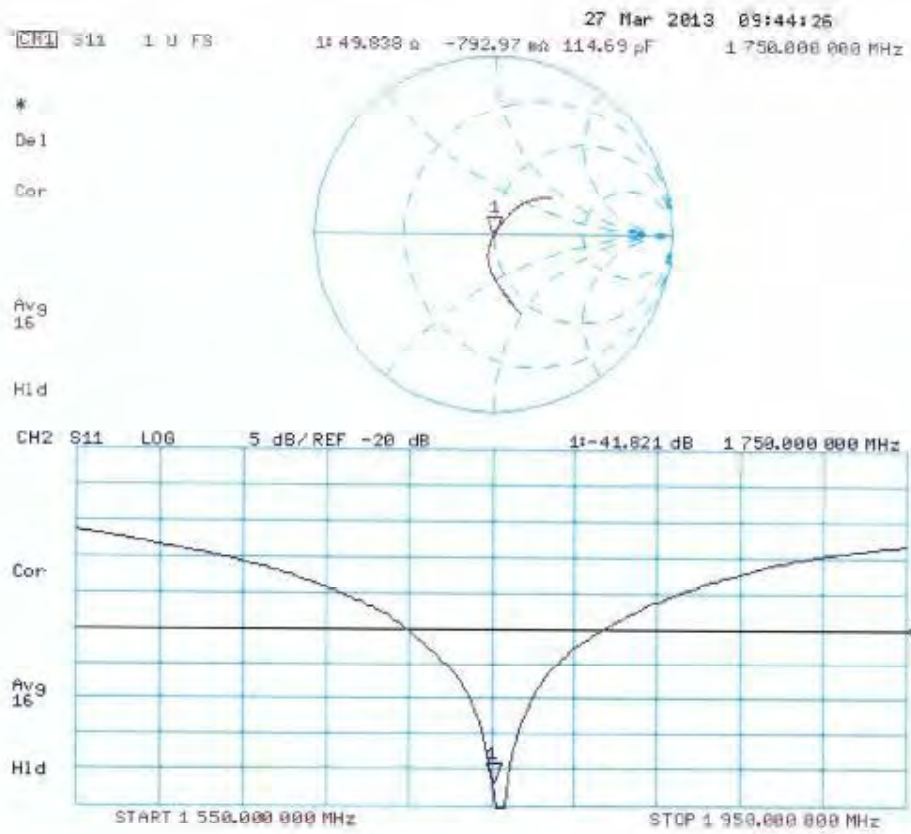

## DASY5 Validation Report for Body TSL

Date: 27.03.2013

Test Laboratory: SPEAG, Zurich, Switzerland

**DUT: Dipole 1750 MHz; Type: D1750V2; Serial: D1750V2 - SN: 1090**

Communication System: CW; Frequency: 1750 MHz

Medium parameters used:  $f = 1750$  MHz;  $\sigma = 1.48$  S/m;  $\epsilon_r = 51.5$ ;  $\rho = 1000$  kg/m<sup>3</sup>

Phantom section: Flat Section

Measurement Standard: DASY5 (IEEE/IEC/ANSI C63.19-2007)

DASY52 Configuration:

- Probe: ES3DV3 - SN3205; ConvF(4.83, 4.83, 4.83); Calibrated: 28.12.2012;
- Sensor-Surface: 3mm (Mechanical Surface Detection)
- Electronics: DAF4 Sn601; Calibrated: 27.06.2012
- Phantom: Flat Phantom 5.0 (back); Type: QD000P50AA; Serial: 1002
- DASY52 52.8.5(1059); SEMCAD X 14.6.8(7028)

### Dipole Calibration for Body Tissue/Pin=250 mW, d=10mm/Zoom Scan (7x7x7)/Cube 0:

Measurement grid: dx=5mm, dy=5mm, dz=5mm

Reference Value = 94.130 V/m; Power Drift = 0.00 dB

Peak SAR (extrapolated) = 16.5 W/kg

**SAR(1 g) = 9.57 W/kg; SAR(10 g) = 5.14 W/kg**

Maximum value of SAR (measured) = 12.0 W/kg

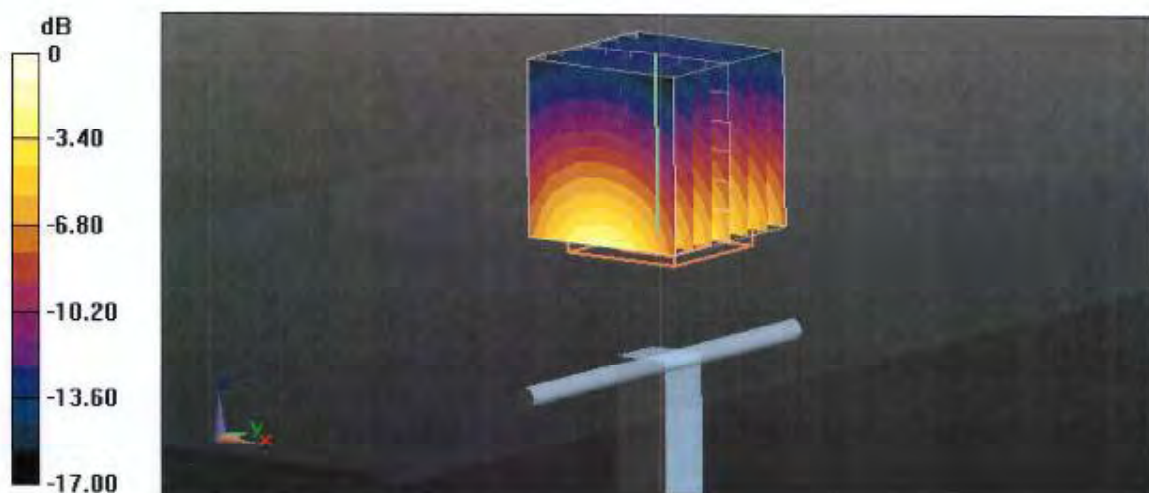

# Impedance Measurement Plot for Body TSL

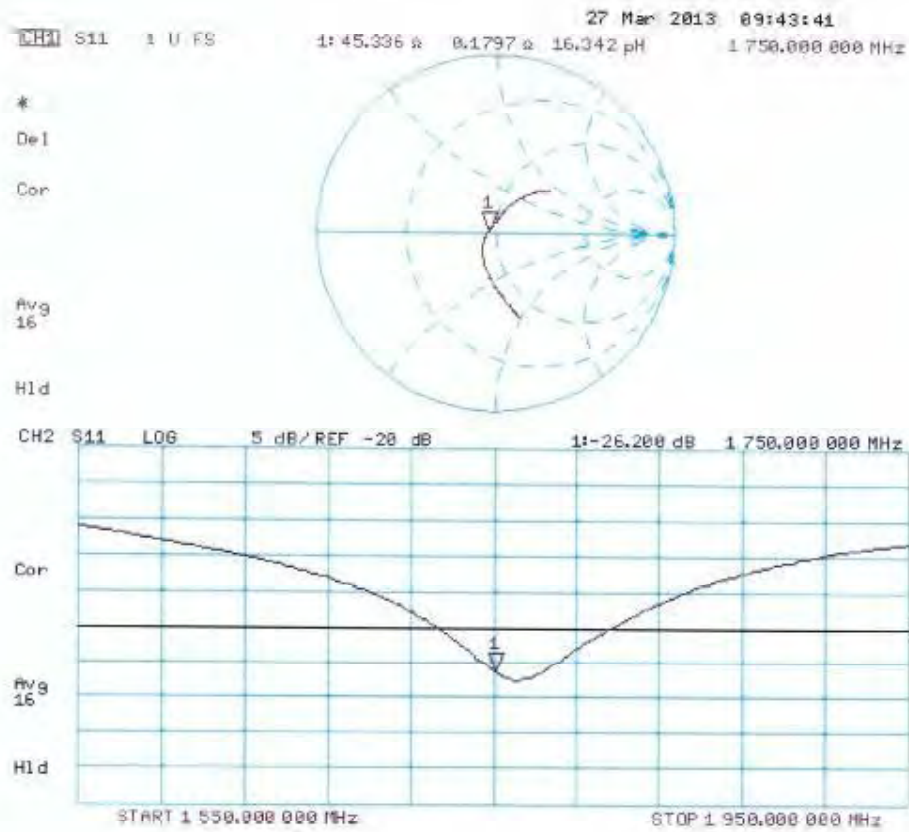



## Extended Dipole Calibrations

Referring to KDB 865664 D01 v01r03, if dipoles are verified in return loss ( $< -20\text{dB}$ , within 20% of prior calibration), and in impedance (within 5 ohm of prior calibration), the annual calibration is not necessary and the calibration interval can be extended.

**<Dipole Verification Data> - D1750V2, serial no. 1090(Date of Measurement 03.26.2014)**

**1750MHz - Head**

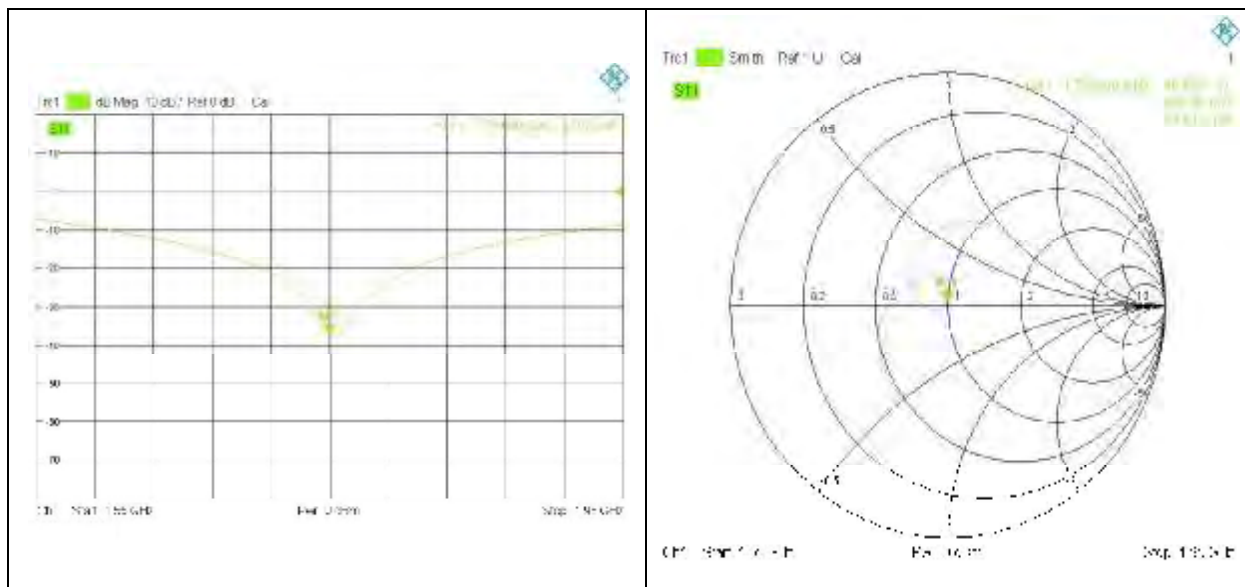

**1750MHz - Body**

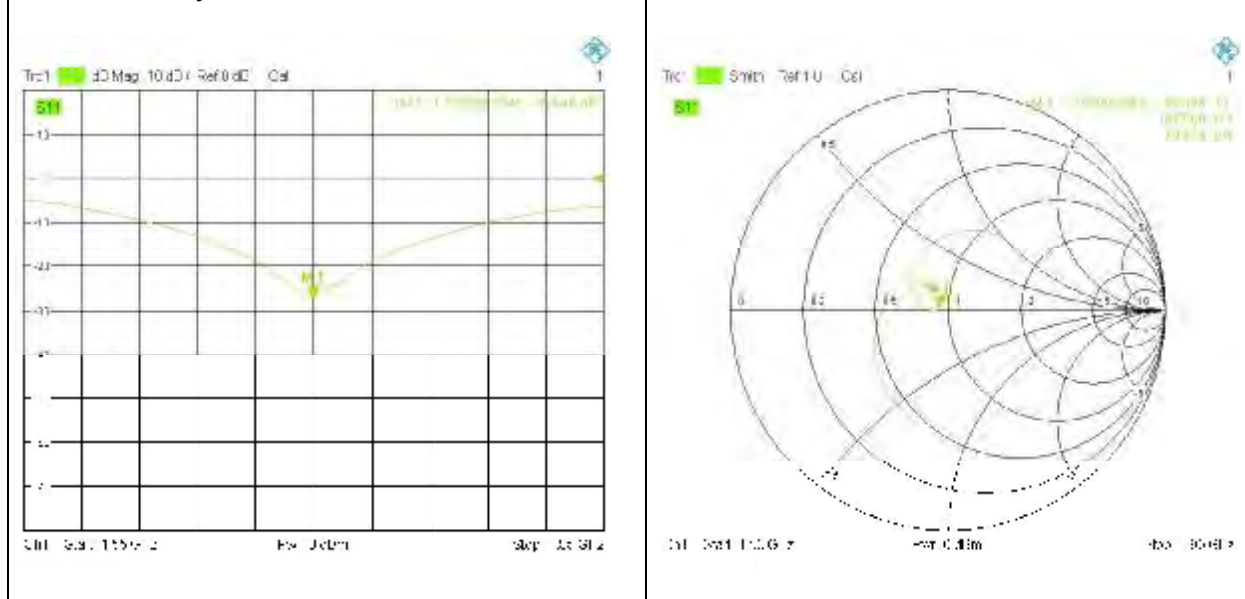

**SPORTON INTERNATIONAL INC.**

TEL : 886-3-327-3456

FAX : 886-3-328-4978



**<Justification of the extended calibration>**

D1750V2 – serial no. 1090												
TSL	Head						Body					
Date of Measurement	Return-Loss (dB)	Delta (%)	Real Impedance (ohm)	Delta (ohm)	Imaginary Impedance (ohm)	Delta (ohm)	Return-Loss (dB)	Delta (%)	Real Impedance (ohm)	Delta (ohm)	Imaginary Impedance (ohm)	Delta (ohm)
03.27.2013	-41.821		49.838		-0.793		-26.2		45.336		0.1797	
03.26.2014	-37.025	11.45	49.553	-0.285	0.808	1.601	-26.949	-2.86	46.183	0.874	0.8776	0.698

The return loss is < -20dB, within 20% of prior calibration; the impedance is within 5 ohm of prior calibration.

Therefore the verification result should support extended calibration.



Accredited by the Swiss Accreditation Service (SAS)  
The Swiss Accreditation Service is one of the signatories to the EA  
Multilateral Agreement for the recognition of calibration certificates

Accreditation No.: **SCS 108**

Client **Sporton KS (Auden)**

Certificate No: **D1900V2-5d170\_Mar13**

## CALIBRATION CERTIFICATE

Object **D1900V2 - SN: 5d170**

Calibration procedure(s) **QA CAL-05.v9  
Calibration procedure for dipole validation kits above 700 MHz**

Calibration date: **March 27, 2013**

This calibration certificate documents the traceability to national standards, which realize the physical units of measurements (SI).  
The measurements and the uncertainties with confidence probability are given on the following pages and are part of the certificate.

All calibrations have been conducted in the closed laboratory facility; environment temperature  $(22 \pm 3)^\circ\text{C}$  and humidity  $< 70\%$ .

Calibration Equipment used (M&TE critical for calibration)

Primary Standards	ID #	Cal Date (Certificate No.)	Scheduled Calibration
Power meter EPM-442A	GB37480704	01-Nov-12 (No. 217-01640)	Oct-13
Power sensor HP 8481A	US37292783	01-Nov-12 (No. 217-01640)	Oct-13
Reference 20 dB Attenuator	SN: 5058 (20k)	27-Mar-12 (No. 217-01530)	Apr-13
Type-N mismatch combination	SN: 5047.3 / 06327	27-Mar-12 (No. 217-01533)	Apr-13
Reference Probe ES3DV3	SN: 3205	28-Dec-12 (No. ES3-3205_Dec12)	Dec-13
DAE4	SN: 601	27-Jun-12 (No. DAE4-601_Jun12)	Jun-13
Secondary Standards	ID #	Check Date (in house)	Scheduled Check
Power sensor HP 8481A	MY41092317	18-Oct-02 (in house check Oct-11)	In house check: Oct-13
RF generator R&S SMT-06	100005	04-Aug-99 (in house check Oct-11)	In house check: Oct-13
Network Analyzer HP 8753E	US37390585 54206	18-Oct-01 (in house check Oct-12)	In house check: Oct-13

	Name	Function	Signature
Calibrated by:	Leif Klysner	Laboratory Technician	
Approved by:	Katja Pokovic	Technical Manager	

Issued: March 27, 2013

This calibration certificate shall not be reproduced except in full without written approval of the laboratory.



**Calibration Laboratory of  
Schmid & Partner  
Engineering AG**  
Zeughausstrasse 43, 8004 Zurich, Switzerland



**S** Schweizerischer Kalibrierdienst  
**C** Service suisse d'étalonnage  
**S** Servizio svizzero di taratura  
**S** Swiss Calibration Service

Accredited by the Swiss Accreditation Service (SAS)

The Swiss Accreditation Service is one of the signatories to the EA  
Multilateral Agreement for the recognition of calibration certificates

Accreditation No.: **SCS 108**

**Glossary:**

TSL	tissue simulating liquid
ConvF	sensitivity in TSL / NORM x,y,z
N/A	not applicable or not measured

**Calibration is Performed According to the Following Standards:**

- IEEE Std 1528-2003, "IEEE Recommended Practice for Determining the Peak Spatial-Averaged Specific Absorption Rate (SAR) in the Human Head from Wireless Communications Devices: Measurement Techniques", December 2003
- IEC 62209-1, "Procedure to measure the Specific Absorption Rate (SAR) for hand-held devices used in close proximity to the ear (frequency range of 300 MHz to 3 GHz)", February 2005
- Federal Communications Commission Office of Engineering & Technology (FCC OET), "Evaluating Compliance with FCC Guidelines for Human Exposure to Radiofrequency Electromagnetic Fields; Additional Information for Evaluating Compliance of Mobile and Portable Devices with FCC Limits for Human Exposure to Radiofrequency Emissions", Supplement C (Edition 01-01) to Bulletin 65

**Additional Documentation:**

- DASY4/5 System Handbook

**Methods Applied and Interpretation of Parameters:**

- Measurement Conditions:** Further details are available from the Validation Report at the end of the certificate. All figures stated in the certificate are valid at the frequency indicated.
- Antenna Parameters with TSL:** The dipole is mounted with the spacer to position its feed point exactly below the center marking of the flat phantom section, with the arms oriented parallel to the body axis.
- Feed Point Impedance and Return Loss:** These parameters are measured with the dipole positioned under the liquid filled phantom. The impedance stated is transformed from the measurement at the SMA connector to the feed point. The Return Loss ensures low reflected power. No uncertainty required.
- Electrical Delay:** One-way delay between the SMA connector and the antenna feed point. No uncertainty required.
- SAR measured:** SAR measured at the stated antenna input power.
- SAR normalized:** SAR as measured, normalized to an input power of 1 W at the antenna connector.
- SAR for nominal TSL parameters:** The measured TSL parameters are used to calculate the nominal SAR result.

The reported uncertainty of measurement is stated as the standard uncertainty of measurement multiplied by the coverage factor  $k=2$ , which for a normal distribution corresponds to a coverage probability of approximately 95%.

## Measurement Conditions

DASY system configuration, as far as not given on page 1.

DASY Version	DASY5	V52.8.5
Extrapolation	Advanced Extrapolation	
Phantom	Modular Flat Phantom	
Distance Dipole Center - TSL	10 mm	with Spacer
Zoom Scan Resolution	dx, dy, dz = 5 mm	
Frequency	1900 MHz $\pm$ 1 MHz	

## Head TSL parameters

The following parameters and calculations were applied.

	Temperature	Permittivity	Conductivity
Nominal Head TSL parameters	22.0 °C	40.0	1.40 mho/m
Measured Head TSL parameters	(22.0 $\pm$ 0.2) °C	39.3 $\pm$ 6 %	1.38 mho/m $\pm$ 6 %
Head TSL temperature change during test	< 0.5 °C	----	----

## SAR result with Head TSL

SAR averaged over 1 cm <sup>3</sup> (1 g) of Head TSL	Condition	
SAR measured	250 mW input power	10.0 W/kg
SAR for nominal Head TSL parameters	normalized to 1W	40.2 W/kg $\pm$ 17.0 % (k=2)

SAR averaged over 10 cm <sup>3</sup> (10 g) of Head TSL	condition	
SAR measured	250 mW input power	5.25 W/kg
SAR for nominal Head TSL parameters	normalized to 1W	21.1 W/kg $\pm$ 16.5 % (k=2)

## Body TSL parameters

The following parameters and calculations were applied.

	Temperature	Permittivity	Conductivity
Nominal Body TSL parameters	22.0 °C	53.3	1.52 mho/m
Measured Body TSL parameters	(22.0 $\pm$ 0.2) °C	51.8 $\pm$ 6 %	1.53 mho/m $\pm$ 6 %
Body TSL temperature change during test	< 0.5 °C	----	----

## SAR result with Body TSL

SAR averaged over 1 cm <sup>3</sup> (1 g) of Body TSL	Condition	
SAR measured	250 mW input power	10.4 W/kg
SAR for nominal Body TSL parameters	normalized to 1W	41.2 W/kg $\pm$ 17.0 % (k=2)

SAR averaged over 10 cm <sup>3</sup> (10 g) of Body TSL	condition	
SAR measured	250 mW input power	5.49 W/kg
SAR for nominal Body TSL parameters	normalized to 1W	21.8 W/kg $\pm$ 16.5 % (k=2)

## Appendix

### Antenna Parameters with Head TSL

Impedance, transformed to feed point	$53.8 \Omega + 4.7 j\Omega$
Return Loss	- 24.7 dB

### Antenna Parameters with Body TSL

Impedance, transformed to feed point	$49.6 \Omega + 5.0 j\Omega$
Return Loss	- 26.0 dB

### General Antenna Parameters and Design

Electrical Delay (one direction)	1 202 ns
----------------------------------	----------

After long term use with 100W radiated power, only a slight warming of the dipole near the feedpoint can be measured.

The dipole is made of standard semirigid coaxial cable. The center conductor of the feeding line is directly connected to the second arm of the dipole. The antenna is therefore short-circuited for DC-signals. On some of the dipoles, small end caps are added to the dipole arms in order to improve matching when loaded according to the position as explained in the "Measurement Conditions" paragraph. The SAR data are not affected by this change. The overall dipole length is still according to the Standard.

No excessive force must be applied to the dipole arms, because they might bend or the soldered connections near the feedpoint may be damaged.

### Additional EUT Data

Manufactured by	SPEAG
Manufactured on	June 08, 2012

## DASY5 Validation Report for Head TSL

Date: 27.03.2013

Test Laboratory: SPEAG, Zurich, Switzerland

**DUT: Dipole 1900 MHz; Type: D1900V2; Serial: D1900V2 - SN: 5d170**

Communication System: CW; Frequency: 1900 MHz

Medium parameters used:  $f = 1900$  MHz;  $\sigma = 1.38$  S/m;  $\epsilon_r = 39.3$ ;  $\rho = 1000$  kg/m<sup>3</sup>

Phantom section: Flat Section

Measurement Standard: DASY5 (IEEE/IEC/ANSI C63.19-2007)

DASY52 Configuration:

- Probe: ES3DV3 - SN3205; ConvF(4.98, 4.98, 4.98); Calibrated: 28.12.2012;
- Sensor-Surface: 3mm (Mechanical Surface Detection)
- Electronics: DAE4 Sn601; Calibrated: 27.06.2012
- Phantom: Flat Phantom 5.0 (front); Type: QD000P50AA; Serial: 1001
- DASY52 52.8.5(1059); SEMCAD X 14.6.8(7028)

### Dipole Calibration for Head Tissue/ $P_{in}=250$ mW, $d=10$ mm/Zoom Scan (7x7x7)/Cube 0:

Measurement grid:  $dx=5$ mm,  $dy=5$ mm,  $dz=5$ mm

Reference Value = 96.871 V/m; Power Drift = 0.05 dB

Peak SAR (extrapolated) = 18.2 W/kg

**SAR(1 g) = 10 W/kg; SAR(10 g) = 5.25 W/kg**

Maximum value of SAR (measured) = 12.4 W/kg

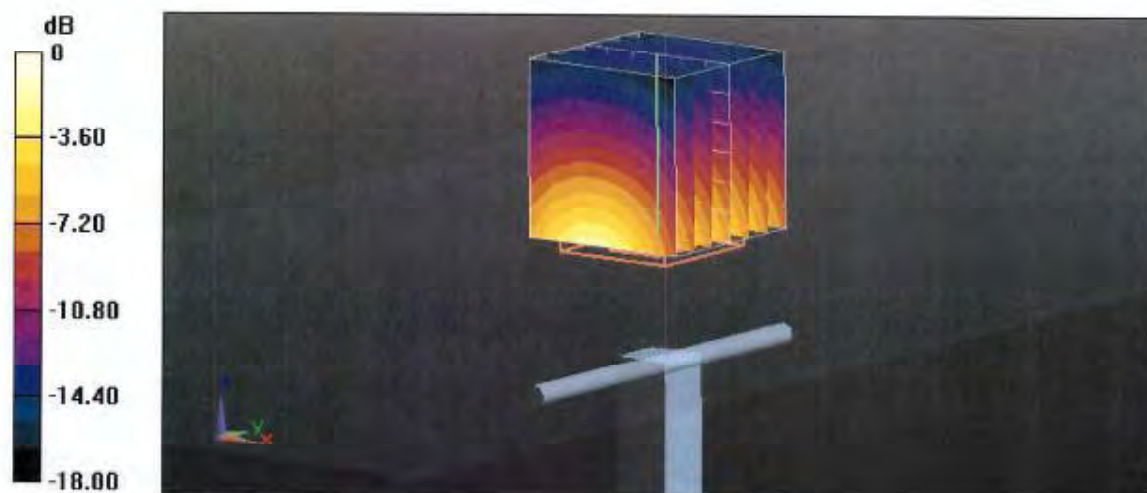

0 dB = 12.4 W/kg = 10.93 dBW/kg

# Impedance Measurement Plot for Head TSL

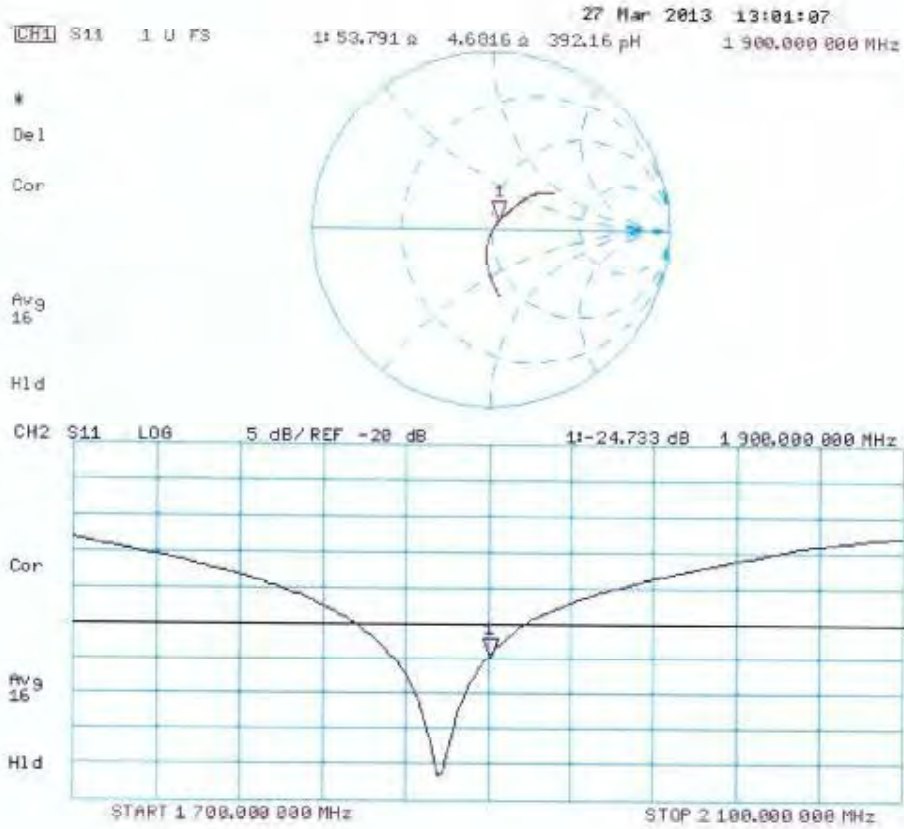

## DASY5 Validation Report for Body TSL

Date: 27.03.2013

Test Laboratory: SPEAG, Zurich, Switzerland

**DUT: Dipole 1900 MHz; Type: D1900V2; Serial: D1900V2 - SN: 5d170**

Communication System: CW; Frequency: 1900 MHz

Medium parameters used;  $f = 1900$  MHz;  $\sigma = 1.53$  S/m;  $\epsilon_r = 51.8$ ;  $\rho = 1000$  kg/m<sup>3</sup>

Phantom section: Flat Section

Measurement Standard: DASY5 (IEEE/IEC/ANSI C63.19-2007)

DASY52 Configuration:

- Probe: ES3DV3 - SN3205; ConvF(4.6, 4.6, 4.6); Calibrated: 28.12.2012;
- Sensor-Surface: 3mm (Mechanical Surface Detection)
- Electronics: DAF4 Sn601; Calibrated: 27.06.2012
- Phantom: Flat Phantom 5.0 (back); Type: QD000P50AA; Serial: 1002
- DASY52 52.8.5(1059); SEMCAD X 14.6.8(7028)

### Dipole Calibration for Body Tissue/Pin=250 mW, d=10mm/Zoom Scan (7x7x7)/Cube 0:

Measurement grid: dx=5mm, dy=5mm, dz=5mm

Reference Value = 96.871 V/m; Power Drift = 0.01 dB

Peak SAR (extrapolated) = 18.0 W/kg

**SAR(1 g) = 10.4 W/kg; SAR(10 g) = 5.49 W/kg**

Maximum value of SAR (measured) = 13.2 W/kg

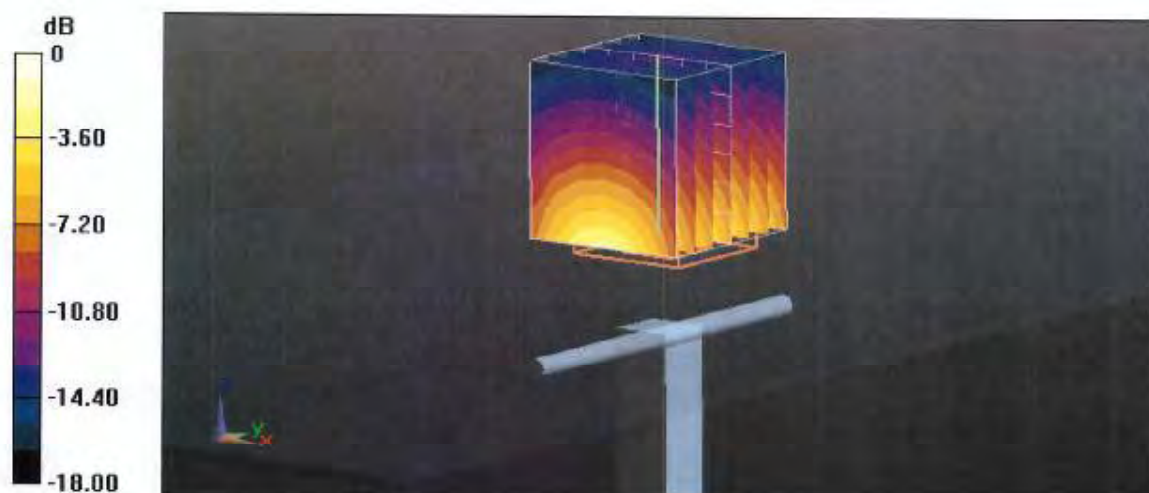

# Impedance Measurement Plot for Body TSL

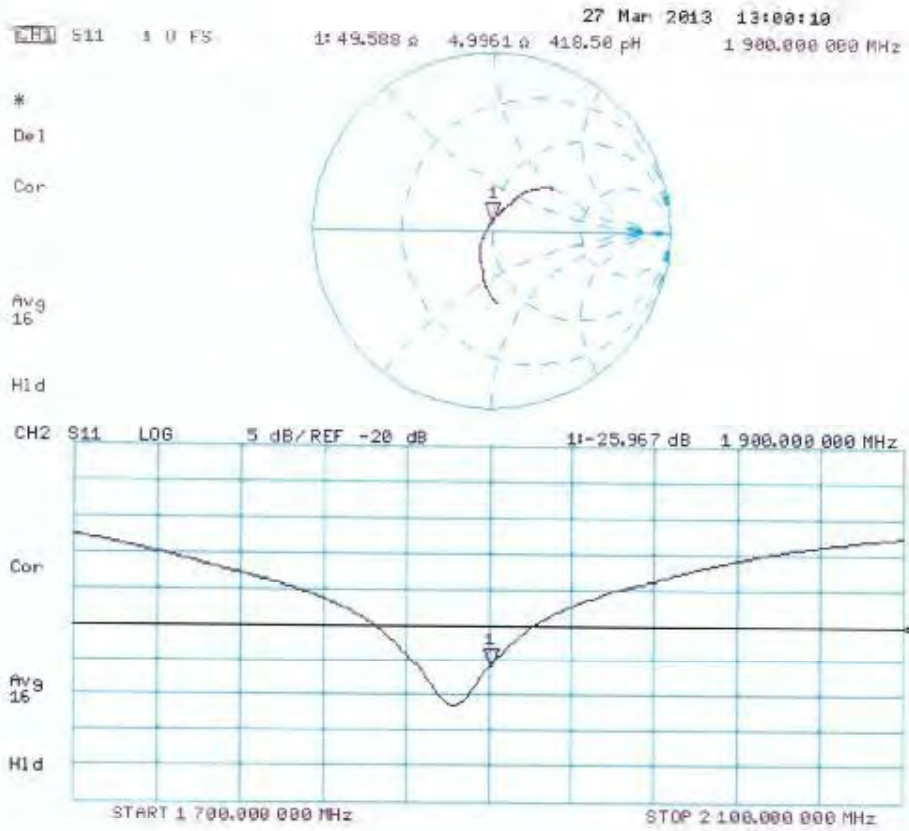



## Extended Dipole Calibrations

Referring to KDB 865664 D01 v01r03, if dipoles are verified in return loss ( $< -20\text{dB}$ , within 20% of prior calibration), and in impedance (within 5 ohm of prior calibration), the annual calibration is not necessary and the calibration interval can be extended.

**<Dipole Verification Data> - D1900V2, serial no. 5d170(Date of Measurement 03.26.2014)**

### 1900MHz - Head

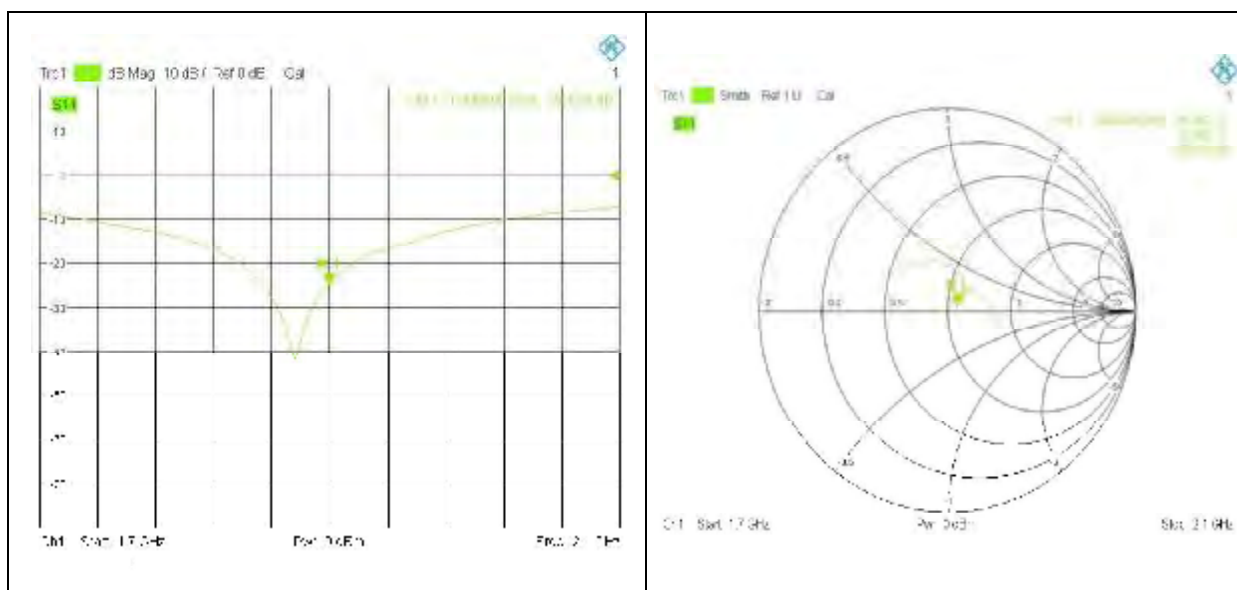

### 1900MHz - Body

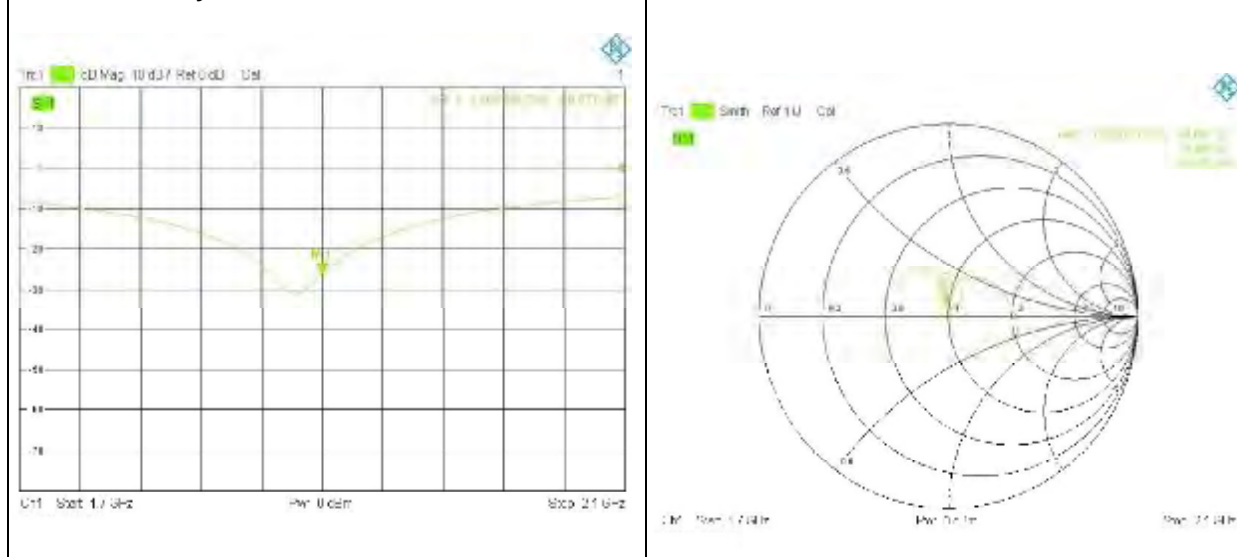

**SPORTON INTERNATIONAL INC.**

TEL : 886-3-327-3456

FAX : 886-3-328-4978





**<Justification of the extended calibration>**

D1900V2 – serial no. 5d170												
TSL	Head						Body					
Date of Measurement	Return-Loss (dB)	Delta (%)	Real Impedance (ohm)	Delta (ohm)	Imaginary Impedance (ohm)	Delta (ohm)	Return-Loss (dB)	Delta (%)	Real Impedance (ohm)	Delta (ohm)	Imaginary Impedance (ohm)	Delta (ohm)
03.27.2013	-24.733		53.791		4.682		-25.967		49.588		4.996	
03.26.2014	-24.628	0.425	55.002	1.211	3.868	-0.814	-26.017	-0.193	49.067	-0.521	5.486	0.490

The return loss is < -20dB, within 20% of prior calibration; the impedance is within 5 ohm of prior calibration.

Therefore the verification result should support extended calibration.



Accredited by the Swiss Accreditation Service (SAS)  
The Swiss Accreditation Service is one of the signatories to the EA  
Multilateral Agreement for the recognition of calibration certificates

Accreditation No.: **SCS 108**

Client **Sporton-KS (Auden)**

Certificate No: **D2450V2-908\_Mar13**

## CALIBRATION CERTIFICATE

Object **D2450V2 - SN: 908**

Calibration procedure(s) **QA CAL-05.v9  
Calibration procedure for dipole validation kits above 700 MHz**

Calibration date: **March 26, 2013**

This calibration certificate documents the traceability to national standards, which realize the physical units of measurements (SI).  
The measurements and the uncertainties with confidence probability are given on the following pages and are part of the certificate.

All calibrations have been conducted in the closed laboratory facility: environment temperature (22 ± 3)°C and humidity < 70%.

Calibration Equipment used (M&TE critical for calibration)

Primary Standards	ID #	Cal Date (Certificate No.)	Scheduled Calibration
Power meter EPM-442A	GB37480704	01-Nov-12 (No. 217-01640)	Oct-13
Power sensor HP 8481A	US37292783	01-Nov-12 (No. 217-01640)	Oct-13
Reference 20 dB Attenuator	SN: 5058 (20k)	27-Mar-12 (No. 217-01530)	Apr-13
Type-N mismatch combination	SN: 5047.3 / 06327	27-Mar-12 (No. 217-01533)	Apr-13
Reference Probe ES3DV3	SN: 3205	28-Dec-12 (No. ES3-3205_Dec12)	Dec-13
DAE4	SN: 601	27-Jun-12 (No. DAE4-601_Jun12)	Jun-13

Secondary Standards	ID #	Check Date (in house)	Scheduled Check
Power sensor HP 8481A	MY41092317	18-Oct-02 (in house check Oct-11)	In house check: Oct-13
RF generator R&S SMT-06	100005	04-Aug-99 (in house check Oct-11)	In house check: Oct-13
Network Analyzer HP 8753E	US37390585 S4206	18-Oct-01 (in house check Oct-12)	In house check: Oct-13

Calibrated by: **Name** Claudio Leubler **Function** Laboratory Technician

Signature

Approved by: **Name** Katja Pokovic **Function** Technical Manager

Issued: March 26, 2013

This calibration certificate shall not be reproduced except in full without written approval of the laboratory.

**Calibration Laboratory of  
Schmid & Partner  
Engineering AG**  
Zeughausstrasse 43, 8004 Zurich, Switzerland



**S** Schweizerischer Kalibrierdienst  
**C** Service suisse d'étalonnage  
**S** Servizio svizzero di taratura  
**S** Swiss Calibration Service

Accredited by the Swiss Accreditation Service (SAS)

The Swiss Accreditation Service is one of the signatories to the EA  
Multilateral Agreement for the recognition of calibration certificates

Accreditation No.: **SCS 108**

**Glossary:**

TSL	tissue simulating liquid
ConvF	sensitivity in TSL / NORM x,y,z
N/A	not applicable or not measured

**Calibration is Performed According to the Following Standards:**

- IEEE Std 1528-2003, "IEEE Recommended Practice for Determining the Peak Spatial-Averaged Specific Absorption Rate (SAR) in the Human Head from Wireless Communications Devices: Measurement Techniques", December 2003
- IEC 62209-1, "Procedure to measure the Specific Absorption Rate (SAR) for hand-held devices used in close proximity to the ear (frequency range of 300 MHz to 3 GHz)", February 2005
- Federal Communications Commission Office of Engineering & Technology (FCC OET), "Evaluating Compliance with FCC Guidelines for Human Exposure to Radiofrequency Electromagnetic Fields; Additional Information for Evaluating Compliance of Mobile and Portable Devices with FCC Limits for Human Exposure to Radiofrequency Emissions", Supplement C (Edition 01-01) to Bulletin 65

**Additional Documentation:**

- DASY4/5 System Handbook

**Methods Applied and Interpretation of Parameters:**

- Measurement Conditions:** Further details are available from the Validation Report at the end of the certificate. All figures stated in the certificate are valid at the frequency indicated.
- Antenna Parameters with TSL:** The dipole is mounted with the spacer to position its feed point exactly below the center marking of the flat phantom section, with the arms oriented parallel to the body axis.
- Feed Point Impedance and Return Loss:** These parameters are measured with the dipole positioned under the liquid filled phantom. The impedance stated is transformed from the measurement at the SMA connector to the feed point. The Return Loss ensures low reflected power. No uncertainty required.
- Electrical Delay:** One-way delay between the SMA connector and the antenna feed point. No uncertainty required.
- SAR measured:** SAR measured at the stated antenna input power.
- SAR normalized:** SAR as measured, normalized to an input power of 1 W at the antenna connector.
- SAR for nominal TSL parameters:** The measured TSL parameters are used to calculate the nominal SAR result.

The reported uncertainty of measurement is stated as the standard uncertainty of measurement multiplied by the coverage factor  $k=2$ , which for a normal distribution corresponds to a coverage probability of approximately 95%.

## Measurement Conditions

DASY system configuration, as far as not given on page 1.

DASY Version	DASY5	V52.8.5
Extrapolation	Advanced Extrapolation	
Phantom	Modular Flat Phantom	
Distance Dipole Center - TSL	10 mm	with Spacer
Zoom Scan Resolution	dx, dy, dz = 5 mm	
Frequency	2450 MHz $\pm$ 1 MHz	

## Head TSL parameters

The following parameters and calculations were applied.

	Temperature	Permittivity	Conductivity
Nominal Head TSL parameters	22.0 °C	39.2	1.80 mho/m
Measured Head TSL parameters	(22.0 $\pm$ 0.2) °C	37.8 $\pm$ 6 %	1.85 mho/m $\pm$ 6 %
Head TSL temperature change during test	< 0.5 °C	---	---

## SAR result with Head TSL

SAR averaged over 1 cm <sup>3</sup> (1 g) of Head TSL	Condition	
SAR measured	250 mW input power	13.8 W/kg
SAR for nominal Head TSL parameters	normalized to 1W	<b>54.0 W/kg <math>\pm</math> 17.0 % (k=2)</b>

SAR averaged over 10 cm <sup>3</sup> (10 g) of Head TSL	condition	
SAR measured	250 mW input power	6.36 W/kg
SAR for nominal Head TSL parameters	normalized to 1W	<b>25.1 W/kg <math>\pm</math> 16.5 % (k=2)</b>

## Body TSL parameters

The following parameters and calculations were applied.

	Temperature	Permittivity	Conductivity
Nominal Body TSL parameters	22.0 °C	52.7	1.95 mho/m
Measured Body TSL parameters	(22.0 $\pm$ 0.2) °C	50.7 $\pm$ 6 %	2.01 mho/m $\pm$ 6 %
Body TSL temperature change during test	< 0.5 °C	---	---

## SAR result with Body TSL

SAR averaged over 1 cm <sup>3</sup> (1 g) of Body TSL	Condition	
SAR measured	250 mW input power	12.9 W/kg
SAR for nominal Body TSL parameters	normalized to 1W	<b>50.4 W/kg <math>\pm</math> 17.0 % (k=2)</b>

SAR averaged over 10 cm <sup>3</sup> (10 g) of Body TSL	condition	
SAR measured	250 mW input power	5.94 W/kg
SAR for nominal Body TSL parameters	normalized to 1W	<b>23.4 W/kg <math>\pm</math> 16.5 % (k=2)</b>

## Appendix

### Antenna Parameters with Head TSL

Impedance, transformed to feed point	56.5 $\Omega$ - 0.1 $j\Omega$
Return Loss	- 24.3 dB

### Antenna Parameters with Body TSL

Impedance, transformed to feed point	52.6 $\Omega$ + 1.9 $j\Omega$
Return Loss	- 30.0 dB

### General Antenna Parameters and Design

Electrical Delay (one direction)	1.156 ns
----------------------------------	----------

After long term use with 100W radiated power, only a slight warming of the dipole near the feedpoint can be measured.

The dipole is made of standard semirigid coaxial cable. The center conductor of the feeding line is directly connected to the second arm of the dipole. The antenna is therefore short-circuited for DC-signals. On some of the dipoles, small end caps are added to the dipole arms in order to improve matching when loaded according to the position as explained in the "Measurement Conditions" paragraph. The SAR data are not affected by this change. The overall dipole length is still according to the Standard.

No excessive force must be applied to the dipole arms, because they might bend or the soldered connections near the feedpoint may be damaged.

### Additional EUT Data

Manufactured by	SPEAG
Manufactured on	December 19, 2012

## DASY5 Validation Report for Head TSL

Date: 26.03.2013

Test Laboratory: SPEAG, Zurich, Switzerland

**DUT: Dipole 2450 MHz; Type: D2450V2; Serial: D2450V2 - SN: 908**

Communication System: CW; Frequency: 2450 MHz

Medium parameters used:  $f = 2450$  MHz;  $\sigma = 1.85$  S/m;  $\epsilon_r = 37.8$ ;  $\rho = 1000$  kg/m<sup>3</sup>

Phantom section: Flat Section

Measurement Standard: DASY5 (IEEE/IEC/ANSI C63.19-2007)

DASY52 Configuration:

- Probe: ES3DV3 - SN3205; ConvF(4.52, 4.52, 4.52); Calibrated: 28.12.2012;
- Sensor-Surface: 3mm (Mechanical Surface Detection)
- Electronics: DAE4 Sn601; Calibrated: 27.06.2012
- Phantom: Flat Phantom 5.0 (front); Type: QD000P50AA; Serial: 1001
- DASY52 52.8.5(1059); SEMCAD X 14.6.8(7028)

### Dipole Calibration for Head Tissue/Pin=250 mW, d=10mm/Zoom Scan (7x7x7)/Cube 0:

Measurement grid: dx=5mm, dy=5mm, dz=5mm

Reference Value = 94.957 V/m; Power Drift = 0.04 dB

Peak SAR (extrapolated) = 28.8 W/kg

**SAR(1 g) = 13.8 W/kg; SAR(10 g) = 6.36 W/kg**

Maximum value of SAR (measured) = 17.9 W/kg

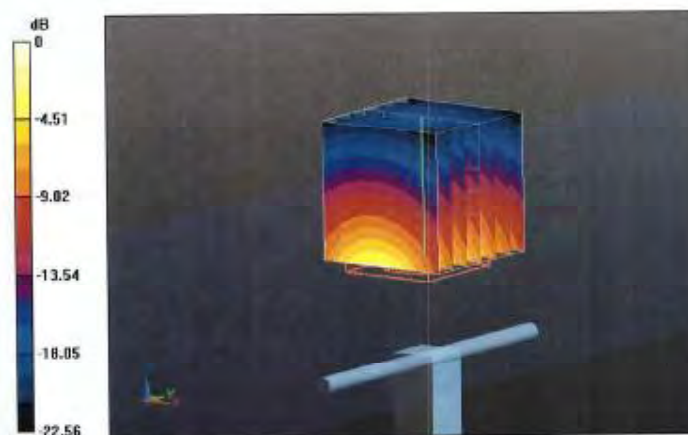

0 dB = 17.9 W/kg = 12.53 dBW/kg

# Impedance Measurement Plot for Head TSL

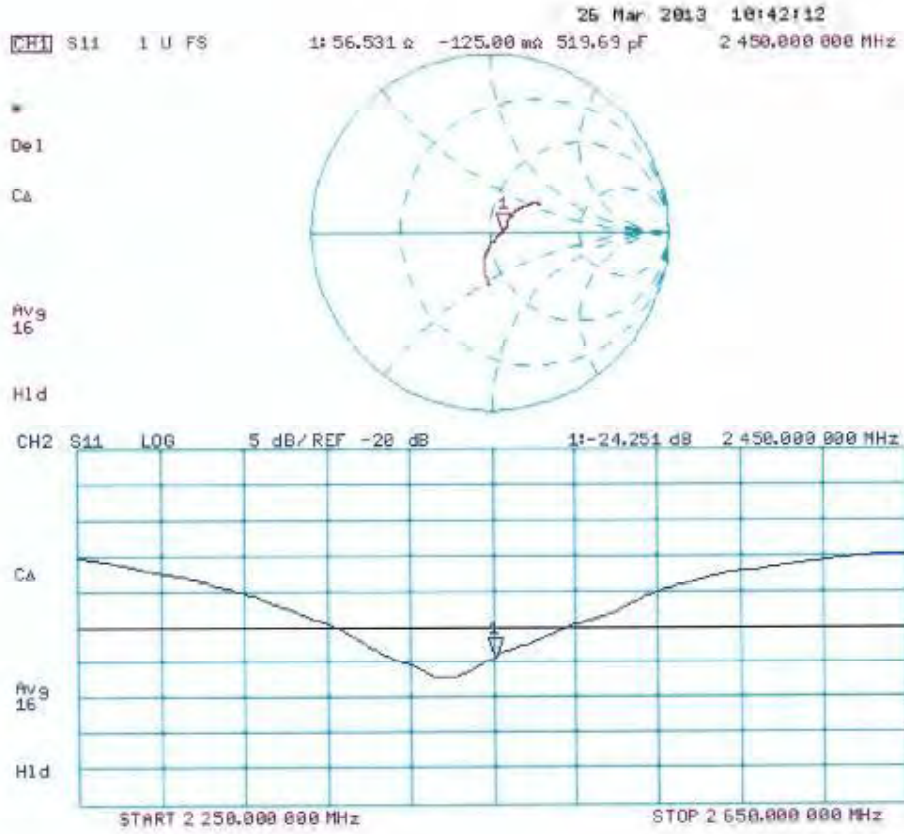

## DASY5 Validation Report for Body TSL

Date: 26.03.2013

Test Laboratory: SPEAG, Zurich, Switzerland

**DUT: Dipole 2450 MHz; Type: D2450V2; Serial: D2450V2 - SN: 908**

Communication System: CW; Frequency: 2450 MHz

Medium parameters used:  $f = 2450$  MHz;  $\sigma = 2.01$  S/m;  $\epsilon_r = 50.7$ ;  $\rho = 1000$  kg/m<sup>3</sup>

Phantom section: Flat Section

Measurement Standard: DASY5 (IEEE/IEC/ANSI C63.19-2007)

DASY52 Configuration:

- Probe: ES3DV3 - SN3205; ConvF(4.42, 4.42, 4.42); Calibrated: 28.12.2012;
- Sensor-Surface: 3mm (Mechanical Surface Detection)
- Electronics: DAE4 Sn601; Calibrated: 27.06.2012
- Phantom: Flat Phantom 5.0 (back); Type: QD000P50AA; Serial: 1002
- DASY52 52.8.5(1059); SEMCAD X 14.6.8(7028)

### Dipole Calibration for Body Tissue/Pin=250 mW, d=10mm/Zoom Scan (7x7x7)/Cube 0:

Measurement grid:  $dx=5$ mm,  $dy=5$ mm,  $dz=5$ mm

Reference Value = 94.957 V/m; Power Drift = 0.00 dB

Peak SAR (extrapolated) = 27.0 W/kg

**SAR(1 g) = 12.9 W/kg; SAR(10 g) = 5.94 W/kg**

Maximum value of SAR (measured) = 17.1 W/kg



0 dB = 17.1 W/kg = 12.33 dBW/kg



# Impedance Measurement Plot for Body TSL

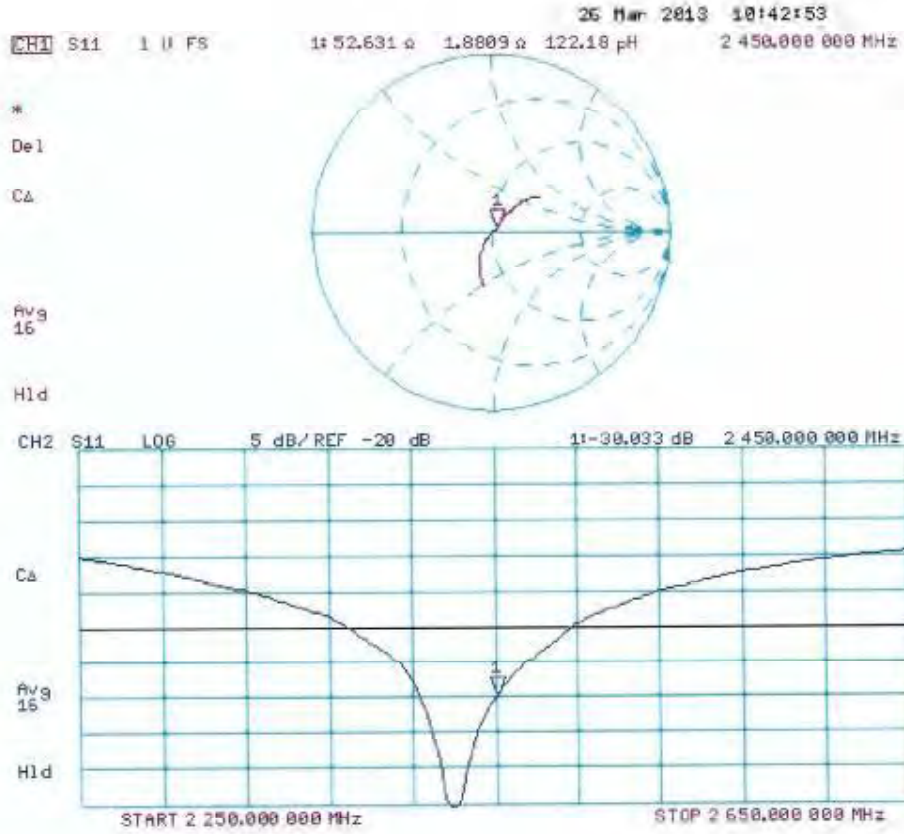



## Extended Dipole Calibrations

Referring to KDB 865664 D01 v01r03, if dipoles are verified in return loss ( $< -20\text{dB}$ , within 20% of prior calibration), and in impedance (within 5 ohm of prior calibration), the annual calibration is not necessary and the calibration interval can be extended.

**<Dipole Verification Data> - D2450V2, serial no. 908(Date of Measurement 03.25.2014)**

### 2450MHz - Head

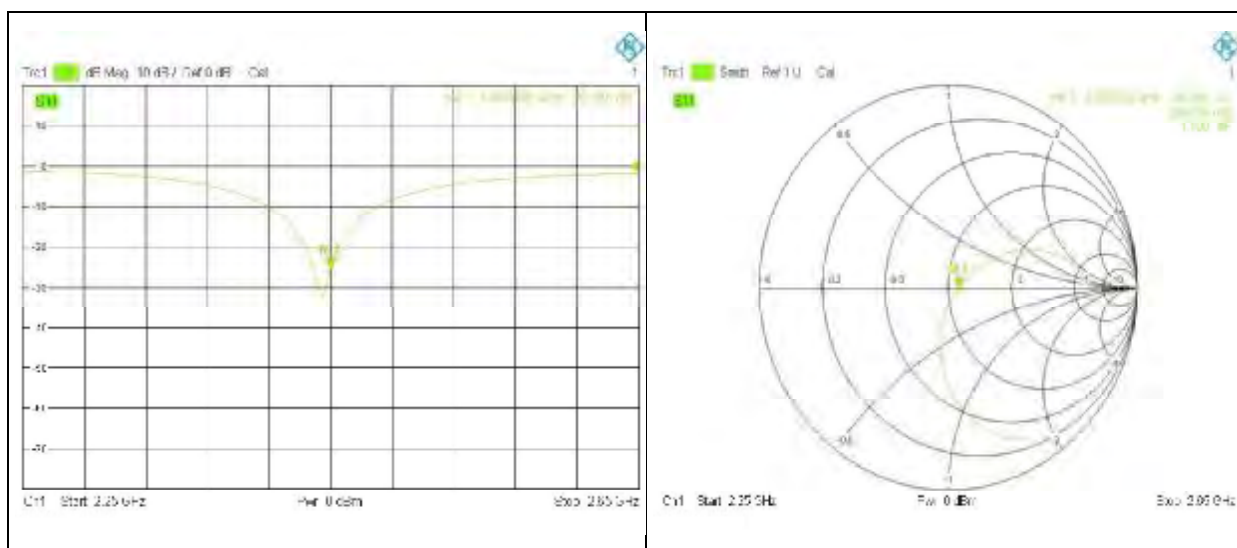

### 2450MHz - Body

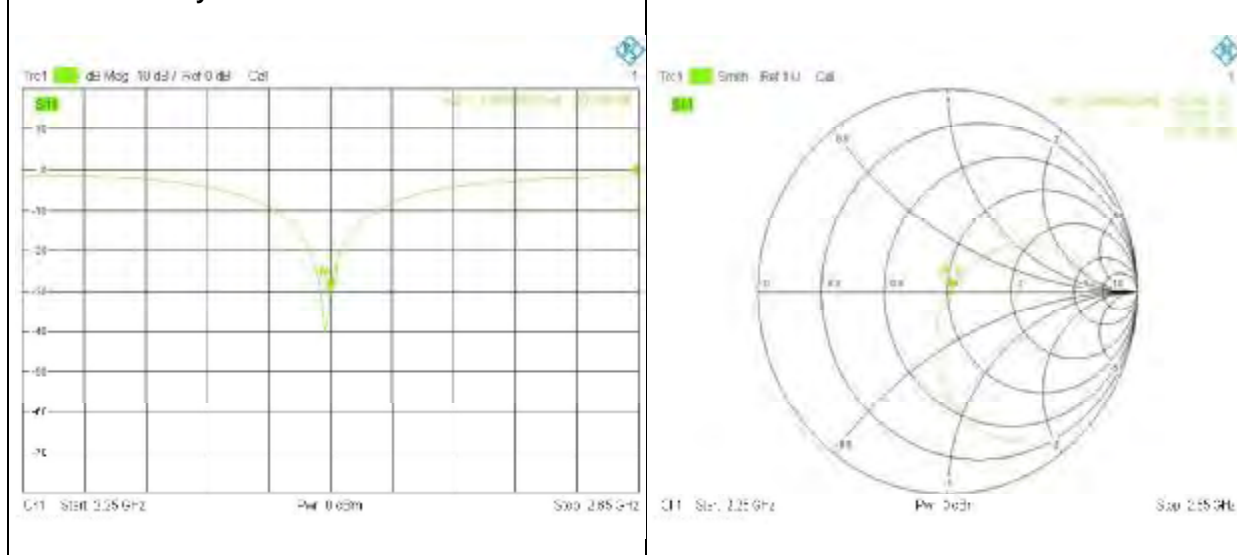



**<Justification of the extended calibration>**

D2450V2 – serial no. 908												
TSL	Head						Body					
Date of Measurement	Return-Loss (dB)	Delta (%)	Real Impedance (ohm)	Delta (ohm)	Imaginary Impedance (ohm)	Delta (ohm)	Return-Loss (dB)	Delta (%)	Real Impedance (ohm)	Delta (ohm)	Imaginary Impedance (ohm)	Delta (ohm)
03.26.2013	-24.251		56.531		-0.125		-30.033		52.631		1.881	
03.25.2014	-25.155	-0.373	56.061	-0.47	-0.059	0.066	-29.785	0.826	52.379	-0.252	1.510	-0.371

The return loss is < -20dB, within 20% of prior calibration; the impedance is within 5 ohm of prior calibration.

Therefore the verification result should support extended calibration.

## IMPORTANT NOTICE

### USAGE OF THE DAE 4

The DAE unit is a delicate, high precision instrument and requires careful treatment by the user. There are no serviceable parts inside the DAE. Special attention shall be given to the following points:

**Battery Exchange:** The battery cover of the DAE4 unit is closed using a screw, over tightening the screw may cause the threads inside the DAE to wear out.

**Shipping of the DAE:** Before shipping the DAE to SPEAG for calibration, remove the batteries and pack the DAE in an antistatic bag. This antistatic bag shall then be packed into a larger box or container which protects the DAE from impacts during transportation. The package shall be marked to indicate that a fragile instrument is inside.

**E-Stop Failures:** Touch detection may be malfunctioning due to broken magnets in the E-stop. Rough handling of the E-stop may lead to damage of these magnets. Touch and collision errors are often caused by dust and dirt accumulated in the E-stop. To prevent E-stop failure, the customer shall always mount the probe to the DAE carefully and keep the DAE unit in a non-dusty environment if not used for measurements.

**Repair:** Minor repairs are performed at no extra cost during the annual calibration. However, SPEAG reserves the right to charge for any repair especially if rough unprofessional handling caused the defect.

**DASY Configuration Files:** Since the exact values of the DAE input resistances, as measured during the calibration procedure of a DAE unit, are not used by the DASY software, a nominal value of 200 MOhm is given in the corresponding configuration file.

**Important Note:**

**Warranty and calibration is void if the DAE unit is disassembled partly or fully by the Customer.**

**Important Note:**

**Never attempt to grease or oil the E-stop assembly. Cleaning and readjusting of the E-stop assembly is allowed by certified SPEAG personnel only and is part of the annual calibration procedure.**

**Important Note:**

**To prevent damage of the DAE probe connector pins, use great care when installing the probe to the DAE. Carefully connect the probe with the connector notch oriented in the mating position. Avoid any rotational movement of the probe body versus the DAE while turning the locking nut of the connector. The same care shall be used when disconnecting the probe from the DAE.**



Accredited by the Swiss Accreditation Service (SAS)  
The Swiss Accreditation Service is one of the signatories to the EA  
Multilateral Agreement for the recognition of calibration certificates

Accreditation No.: **SCS 108**

Client **Sporton CN (Auden)**

Certificate No: **DAE4-1358\_Apr14**

## CALIBRATION CERTIFICATE

Object **DAE4 - SD 000 D04 BJ - SN: 1358**

Calibration procedure(s) **QA CAL-06.v26  
Calibration procedure for the data acquisition electronics (DAE)**

Calibration date: **April 30, 2014**

This calibration certificate documents the traceability to national standards, which realize the physical units of measurements (SI).  
The measurements and the uncertainties with confidence probability are given on the following pages and are part of the certificate.

All calibrations have been conducted in the closed laboratory facility: environment temperature  $(22 \pm 3)^\circ\text{C}$  and humidity  $< 70\%$ .

Calibration Equipment used (M&TE critical for calibration)

Primary Standards	ID #	Cal Date (Certificate No.)	Scheduled Calibration
Kelthley Multimeter Type 2001	SN: 0810278	01-Oct-13 (No:13976)	Oct-14

Secondary Standards	ID #	Check Date (In house)	Scheduled Check
Auto DAE Calibration Unit	SE UWS 053 AA 1001	07-Jan-14 (in house check)	In house check: Jan-15
Calibrator Box V2.1	SE UMS 006 AA 1002	07-Jan-14 (In house check)	In house check: Jan-15

	Name	Function	Signature
Calibrated by:	R.Mayoraz	Technician	<i>R. Mayoraz</i>
Approved by:	Flin Bornholt	Deputy Technical Manager	<i>Flin Bornholt</i>

Issued: April 30, 2014

This calibration certificate shall not be reproduced except in full without written approval of the laboratory.



Accredited by the Swiss Accreditation Service (SAS)

The Swiss Accreditation Service is one of the signatories to the EA  
Multilateral Agreement for the recognition of calibration certificates

Accreditation No.: **SCS 108**

## Glossary

DAE data acquisition electronics  
Connector angle information used in DASY system to align probe sensor X to the robot coordinate system.

## Methods Applied and Interpretation of Parameters

- *DC Voltage Measurement:* Calibration Factor assessed for use in DASY system by comparison with a calibrated instrument traceable to national standards. The figure given corresponds to the full scale range of the voltmeter in the respective range.
- *Connector angle:* The angle of the connector is assessed measuring the angle mechanically by a tool inserted. Uncertainty is not required.
- The following parameters as documented in the Appendix contain technical information as a result from the performance test and require no uncertainty.
  - *DC Voltage Measurement Linearity:* Verification of the Linearity at +10% and -10% of the nominal calibration voltage. Influence of offset voltage is included in this measurement.
  - *Common mode sensitivity:* Influence of a positive or negative common mode voltage on the differential measurement.
  - *Channel separation:* Influence of a voltage on the neighbor channels not subject to an input voltage.
  - *AD Converter Values with inputs shorted:* Values on the internal AD converter corresponding to zero input voltage
  - *Input Offset Measurement:* Output voltage and statistical results over a large number of zero voltage measurements.
  - *Input Offset Current:* Typical value for information; Maximum channel input offset current, not considering the input resistance.
  - *Input resistance:* Typical value for information: DAE input resistance at the connector, during internal auto-zeroing and during measurement.
  - *Low Battery Alarm Voltage:* Typical value for information. Below this voltage, a battery alarm signal is generated.
  - *Power consumption:* Typical value for information. Supply currents in various operating modes.

## DC Voltage Measurement

A/D - Converter Resolution nominal

High Range: 1LSB = 6.1 $\mu$ V, full range = -100...+300 mV

Low Range: 1LSB = 61nV, full range = -1.....+3mV

DASY measurement parameters: Auto Zero Time: 3 sec; Measuring time: 3 sec

Calibration Factors	X	Y	Z
High Range	403.476 $\pm$ 0.02% (k=2)	403.505 $\pm$ 0.02% (k=2)	403.509 $\pm$ 0.02% (k=2)
Low Range	3.96075 $\pm$ 1.50% (k=2)	3.98590 $\pm$ 1.50% (k=2)	3.99195 $\pm$ 1.50% (k=2)

## Connector Angle

Connector Angle to be used in DASY system	136.0 $^{\circ}$ $\pm$ 1 $^{\circ}$
---	-------------------------------------

## Appendix

### 1. DC Voltage Linearity

High Range	Reading ( $\mu\text{V}$ )	Difference ( $\mu\text{V}$ )	Error (%)
Channel X + Input	200038.03	1.76	0.00
Channel X + Input	20005.43	1.37	0.01
Channel X - Input	-20004.06	1.92	-0.01
Channel Y + Input	200034.40	-1.98	-0.00
Channel Y + Input	20002.81	-0.99	-0.00
Channel Y - Input	-20005.22	0.94	-0.00
Channel Z + Input	200037.68	1.44	0.00
Channel Z + Input	20002.59	-1.11	-0.01
Channel Z - Input	-20007.07	-0.94	0.00

Low Range	Reading ( $\mu\text{V}$ )	Difference ( $\mu\text{V}$ )	Error (%)
Channel X + Input	2000.15	-0.26	-0.01
Channel X + Input	201.04	0.44	0.22
Channel X - Input	-198.78	0.53	-0.27
Channel Y + Input	2000.38	0.18	0.01
Channel Y + Input	200.06	-0.29	-0.15
Channel Y - Input	-200.10	-0.50	0.25
Channel Z + Input	2000.16	-0.17	-0.01
Channel Z + Input	198.55	-1.98	-0.99
Channel Z - Input	-201.27	-1.72	0.86

### 2. Common mode sensitivity

DASY measurement parameters: Auto Zero Time: 3 sec; Measuring time: 3 sec

	Common mode Input Voltage (mV)	High Range Average Reading ( $\mu\text{V}$ )	Low Range Average Reading ( $\mu\text{V}$ )
Channel X	200	23.14	21.30
	-200	-20.01	-21.49
Channel Y	200	-27.07	-27.39
	-200	27.21	26.98
Channel Z	200	-11.40	-11.75
	-200	9.24	9.23

### 3. Channel separation

DASY measurement parameters: Auto Zero Time: 3 sec; Measuring time: 3 sec

	Input Voltage (mV)	Channel X ( $\mu\text{V}$ )	Channel Y ( $\mu\text{V}$ )	Channel Z ( $\mu\text{V}$ )
Channel X	200	-	3.10	-3.59
Channel Y	200	9.08	-	3.89
Channel Z	200	9.17	6.05	-



#### 4. AD-Converter Values with inputs shorted

DASY measurement parameters: Auto Zero Time: 3 sec; Measuring time: 3 sec

	High Range (LSB)	Low Range (LSB)
Channel X	15575	16462
Channel Y	16051	15758
Channel Z	16070	16201

#### 5. Input Offset Measurement

DASY measurement parameters: Auto Zero Time: 3 sec; Measuring time: 3 sec

Input 10M $\Omega$

	Average ( $\mu$ V)	min. Offset ( $\mu$ V)	max. Offset ( $\mu$ V)	Std. Deviation ( $\mu$ V)
Channel X	-1.05	-2.31	-0.30	0.37
Channel Y	-0.30	-1.37	0.51	0.40
Channel Z	-1.60	-2.40	-0.66	0.37

#### 6. Input Offset Current

Nominal input circuitry offset current on all channels: <25fA

#### 7. Input Resistance (Typical values for information)

	Zeroing (kOhm)	Measuring (MOhm)
Channel X	200	200
Channel Y	200	200
Channel Z	200	200

#### 8. Low Battery Alarm Voltage (Typical values for information)

Typical values	Alarm Level (VDC)
Supply (+ Vcc)	+7.9
Supply (- Vcc)	-7.6

#### 9. Power Consumption (Typical values for information)

Typical values	Switched off (mA)	Stand by (mA)	Transmitting (mA)
Supply (+ Vcc)	+0.01	+6	+14
Supply (- Vcc)	-0.01	-8	-9



Accredited by the Swiss Accreditation Service (SAS)  
The Swiss Accreditation Service is one of the signatories to the EA  
Multilateral Agreement for the recognition of calibration certificates

Accreditation No.: **SCS 108**

Client **Sporton-CN (Auden)**

Certificate No: **EX3-3911\_Oct14**

## CALIBRATION CERTIFICATE

Object **EX3DV4 - SN:3911**

Calibration procedure(s) **QA CAL-01.v9, QA CAL-23.v5, QA CAL-25.v6  
Calibration procedure for dosimetric E-field probes**

Calibration date: **October 2, 2014**

This calibration certificate documents the traceability to national standards, which realize the physical units of measurements (SI).  
The measurements and the uncertainties with confidence probability are given on the following pages and are part of the certificate.

All calibrations have been conducted in the closed laboratory facility: environment temperature (22 ± 3)°C and humidity < 70%.

Calibration Equipment used (M&TE critical for calibration)

Primary Standards	ID	Cal Date (Certificate No.)	Scheduled Calibration
Power meter E4419B	GB41293874	03-Apr-14 (No. 217-01911)	Apr-15
Power sensor E4412A	MY41498087	03-Apr-14 (No. 217-01911)	Apr-15
Reference 3 dB Attenuator	SN: S5054 (3c)	03-Apr-14 (No. 217-01915)	Apr-15
Reference 20 dB Attenuator	SN: S5277 (20x)	03-Apr-14 (No. 217-01919)	Apr-15
Reference 30 dB Attenuator	SN: S5129 (30b)	03-Apr-14 (No. 217-01920)	Apr-15
Reference Probe ES3DV2	SN: 3013	30-Dec-13 (No. ES3-3013_Dec13)	Dec-14
DAE4	SN: 660	13-Dec-13 (No. DAE4-660_Dec13)	Dec-14
Secondary Standards	ID	Check Date (in house)	Scheduled Check
RF generator HP 8648C	US3642U01700	4-Aug-99 (in house check Apr-13)	In house check: Apr-16
Network Analyzer HP 8753E	US37390585	18-Oct-01 (in house check Oct-13)	In house check: Oct-14

	Name	Function	Signature
Calibrated by:	Jeton Kastrati	Laboratory Technician	
Approved by:	Katja Pokovic	Technical Manager	

Issued: October 2, 2014

This calibration certificate shall not be reproduced except in full without written approval of the laboratory.



Accredited by the Swiss Accreditation Service (SAS)  
The Swiss Accreditation Service is one of the signatories to the EA  
Multilateral Agreement for the recognition of calibration certificates

Accreditation No.: **SCS 108**

**Glossary:**

TSL	tissue simulating liquid
NORM <sub>x,y,z</sub>	sensitivity in free space
ConvF	sensitivity in TSL / NORM <sub>x,y,z</sub>
DCP	diode compression point
CF	crest factor (1/duty_cycle) of the RF signal
A, B, C, D	modulation dependent linearization parameters
Polarization φ	φ rotation around probe axis
Polarization ϑ	ϑ rotation around an axis that is in the plane normal to probe axis (at measurement center), i.e., ϑ = 0 is normal to probe axis
Connector Angle	information used in DASY system to align probe sensor X to the robot coordinate system

**Calibration is Performed According to the Following Standards:**

- a) IEEE Std 1528-2013, "IEEE Recommended Practice for Determining the Peak Spatial-Averaged Specific Absorption Rate (SAR) in the Human Head from Wireless Communications Devices: Measurement Techniques", June 2013
- b) IEC 62209-1, "Procedure to measure the Specific Absorption Rate (SAR) for hand-held devices used in close proximity to the ear (frequency range of 300 MHz to 3 GHz)", February 2005

**Methods Applied and Interpretation of Parameters:**

- **NORM<sub>x,y,z</sub>**: Assessed for E-field polarization ϑ = 0 (f ≤ 900 MHz in TEM-cell; f > 1800 MHz: R22 waveguide). NORM<sub>x,y,z</sub> are only intermediate values, i.e., the uncertainties of NORM<sub>x,y,z</sub> does not affect the E<sup>2</sup>-field uncertainty inside TSL (see below *ConvF*).
- **NORM(f)<sub>x,y,z</sub> = NORM<sub>x,y,z</sub> \* frequency\_response** (see Frequency Response Chart). This linearization is implemented in DASY4 software versions later than 4.2. The uncertainty of the frequency response is included in the stated uncertainty of *ConvF*.
- **DCP<sub>x,y,z</sub>**: DCP are numerical linearization parameters assessed based on the data of power sweep with CW signal (no uncertainty required). DCP does not depend on frequency nor media.
- **PAR**: PAR is the Peak to Average Ratio that is not calibrated but determined based on the signal characteristics
- **A<sub>x,y,z</sub>; B<sub>x,y,z</sub>; C<sub>x,y,z</sub>; D<sub>x,y,z</sub>; VR<sub>x,y,z</sub>**: A, B, C, D are numerical linearization parameters assessed based on the data of power sweep for specific modulation signal. The parameters do not depend on frequency nor media. VR is the maximum calibration range expressed in RMS voltage across the diode.
- **ConvF and Boundary Effect Parameters**: Assessed in flat phantom using E-field (or Temperature Transfer Standard for f ≤ 800 MHz) and inside waveguide using analytical field distributions based on power measurements for f > 800 MHz. The same setups are used for assessment of the parameters applied for boundary compensation (alpha, depth) of which typical uncertainty values are given. These parameters are used in DASY4 software to improve probe accuracy close to the boundary. The sensitivity in TSL corresponds to NORM<sub>x,y,z</sub> \* ConvF whereby the uncertainty corresponds to that given for ConvF. A frequency dependent ConvF is used in DASY version 4.4 and higher which allows extending the validity from ± 50 MHz to ± 100 MHz.
- **Spherical isotropy (3D deviation from isotropy)**: in a field of low gradients realized using a flat phantom exposed by a patch antenna.
- **Sensor Offset**: The sensor offset corresponds to the offset of virtual measurement center from the probe tip (on probe axis). No tolerance required.
- **Connector Angle**: The angle is assessed using the information gained by determining the NORM<sub>x</sub> (no uncertainty required).

# Probe EX3DV4

## SN:3911

Manufactured:	September 4, 2012
Repaired:	September 26, 2014
Calibrated:	October 2, 2014

Calibrated for DASY/EASY Systems  
(Note: non-compatible with DASY2 system!)

## DASY/EASY - Parameters of Probe: EX3DV4 - SN:3911

### Basic Calibration Parameters

	Sensor X	Sensor Y	Sensor Z	Unc (k=2)
Norm ( $\mu\text{V}/(\text{V}/\text{m})^2$ ) <sup>A</sup>	0.32	0.42	0.49	$\pm 10.1\%$
DCP (mV) <sup>B</sup>	102.9	96.3	97.7	

### Modulation Calibration Parameters

UID	Communication System Name		A dB	B dB $\sqrt{\mu\text{V}}$	C	D dB	VR mV	Unc <sup>E</sup> (k=2)
0	CW	X	0.0	0.0	1.0	0.00	145.4	$\pm 2.5\%$
		Y	0.0	0.0	1.0		141.8	
		Z	0.0	0.0	1.0		136.8	

The reported uncertainty of measurement is stated as the standard uncertainty of measurement multiplied by the coverage factor  $k=2$ , which for a normal distribution corresponds to a coverage probability of approximately 95%.

<sup>A</sup> The uncertainties of NormX,Y,Z do not affect the  $E^2$ -field uncertainty inside TSL (see Pages 5 and 6).

<sup>B</sup> Numerical linearization parameter: uncertainty not required.

<sup>E</sup> Uncertainty is determined using the max. deviation from linear response applying rectangular distribution and is expressed for the square of the field value.

## DASY/EASY - Parameters of Probe: EX3DV4 - SN:3911

### Calibration Parameter Determined in Head Tissue Simulating Media

f (MHz) <sup>C</sup>	Relative Permittivity <sup>F</sup>	Conductivity (S/m) <sup>F</sup>	ConvF X	ConvF Y	ConvF Z	Alpha <sup>G</sup>	Depth <sup>G</sup> (mm)	Unct. (k=2)
750	41.9	0.89	9.89	9.89	9.89	0.48	0.76	± 12.0 %
835	41.5	0.90	9.62	9.62	9.62	0.55	0.70	± 12.0 %
900	41.5	0.97	9.38	9.38	9.38	0.23	1.18	± 12.0 %
1750	40.1	1.37	8.18	8.18	8.18	0.26	1.01	± 12.0 %
1900	40.0	1.40	7.95	7.95	7.95	0.27	1.01	± 12.0 %
2000	40.0	1.40	7.92	7.92	7.92	0.34	0.88	± 12.0 %
2300	39.5	1.67	7.53	7.53	7.53	0.44	0.73	± 12.0 %
2450	39.2	1.80	7.05	7.05	7.05	0.31	0.92	± 12.0 %
2600	39.0	1.96	6.92	6.92	6.92	0.36	0.92	± 12.0 %

<sup>C</sup> Frequency validity above 300 MHz of ± 100 MHz only applies for DASY v4.4 and higher (see Page 2), else it is restricted to ± 50 MHz. The uncertainty is the RSS of the ConvF uncertainty at calibration frequency and the uncertainty for the indicated frequency band. Frequency validity below 300 MHz is ± 10, 25, 40, 50 and 70 MHz for ConvF assessments at 30, 64, 128, 150 and 220 MHz respectively. Above 5 GHz frequency validity can be extended to ± 110 MHz.

<sup>F</sup> At frequencies below 3 GHz, the validity of tissue parameters ( $\epsilon$  and  $\sigma$ ) can be relaxed to ± 10% if liquid compensation formula is applied to measured SAR values. At frequencies above 3 GHz, the validity of tissue parameters ( $\epsilon$  and  $\sigma$ ) is restricted to ± 5%. The uncertainty is the RSS of the ConvF uncertainty for indicated target tissue parameters.

<sup>G</sup> Alpha/Depth are determined during calibration. SPEAG warrants that the remaining deviation due to the boundary effect after compensation is always less than ± 1% for frequencies below 3 GHz and below ± 2% for frequencies between 3-6 GHz at any distance larger than half the probe tip diameter from the boundary.

## DASY/EASY - Parameters of Probe: EX3DV4 - SN:3911

### Calibration Parameter Determined in Body Tissue Simulating Media

f (MHz) <sup>C</sup>	Relative Permittivity <sup>F</sup>	Conductivity (S/m) <sup>F</sup>	ConvF X	ConvF Y	ConvF Z	Alpha <sup>G</sup>	Depth <sup>G</sup> (mm)	Unct. (k=2)
750	55.5	0.96	9.61	9.61	9.61	0.20	1.44	± 12.0 %
835	55.2	0.97	9.66	9.66	9.66	0.61	0.65	± 12.0 %
900	55.0	1.05	9.36	9.36	9.36	0.32	1.07	± 12.0 %
1750	53.4	1.49	7.93	7.93	7.93	0.70	0.66	± 12.0 %
1900	53.3	1.52	7.57	7.57	7.57	0.31	0.98	± 12.0 %
2000	53.3	1.52	7.76	7.76	7.76	0.35	0.92	± 12.0 %
2300	52.9	1.81	7.39	7.39	7.39	0.41	0.88	± 12.0 %
2450	52.7	1.95	7.18	7.18	7.18	0.72	0.61	± 12.0 %
2600	52.5	2.16	7.03	7.03	7.03	0.80	0.50	± 12.0 %

<sup>C</sup> Frequency validity above 300 MHz of ± 100 MHz only applies for DASY v4.4 and higher (see Page 2), else it is restricted to ± 50 MHz. The uncertainty is the RSS of the ConvF uncertainty at calibration frequency and the uncertainty for the indicated frequency band. Frequency validity below 300 MHz is ± 10, 25, 40, 50 and 70 MHz for ConvF assessments at 30, 64, 128, 150 and 220 MHz respectively. Above 5 GHz frequency validity can be extended to ± 110 MHz.

<sup>F</sup> At frequencies below 3 GHz, the validity of tissue parameters ( $\epsilon$  and  $\sigma$ ) can be relaxed to ± 10% if liquid compensation formula is applied to measured SAR values. At frequencies above 3 GHz, the validity of tissue parameters ( $\epsilon$  and  $\sigma$ ) is restricted to ± 5%. The uncertainty is the RSS of the ConvF uncertainty for indicated target tissue parameters.

<sup>G</sup> Alpha/Depth are determined during calibration. SPEAG warrants that the remaining deviation due to the boundary effect after compensation is always less than ± 1% for frequencies below 3 GHz and below ± 2% for frequencies between 3-6 GHz at any distance larger than half the probe tip diameter from the boundary.

### Frequency Response of E-Field (TEM-Cell:ifi110 EXX, Waveguide: R22)

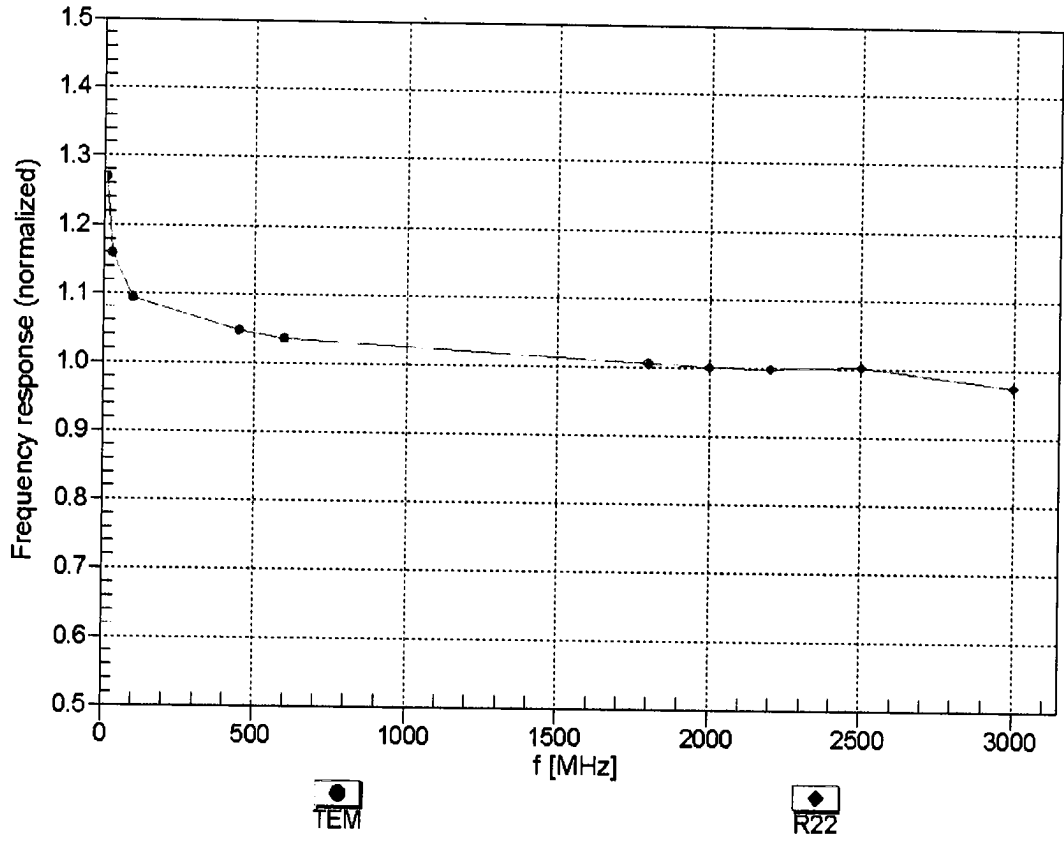

Uncertainty of Frequency Response of E-field:  $\pm 6.3\%$  (k=2)



# Receiving Pattern ( $\phi$ ), $\vartheta = 0^\circ$

f=600 MHz, TEM

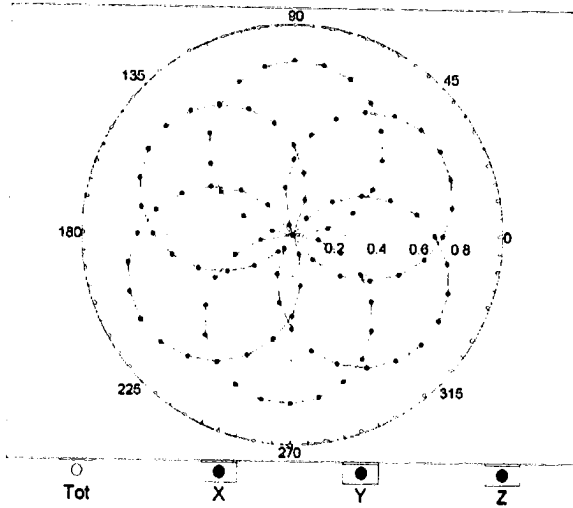

f=1800 MHz, R22

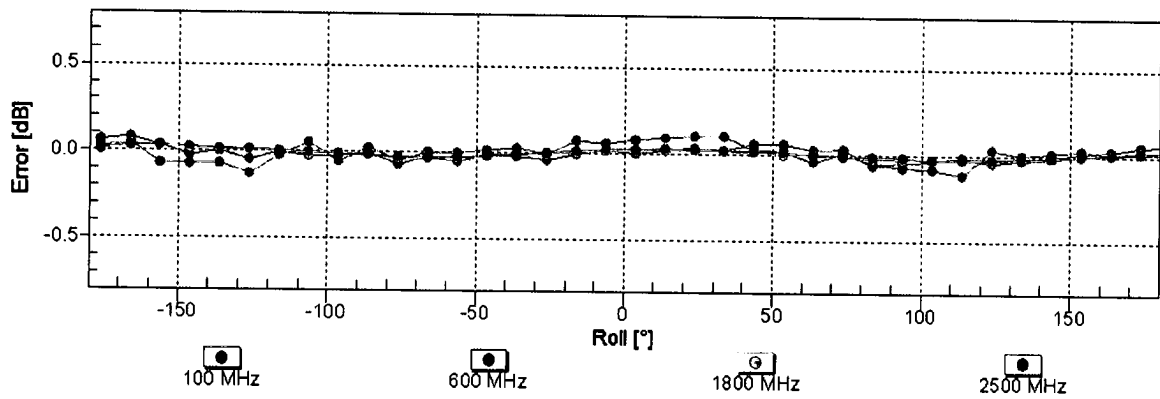
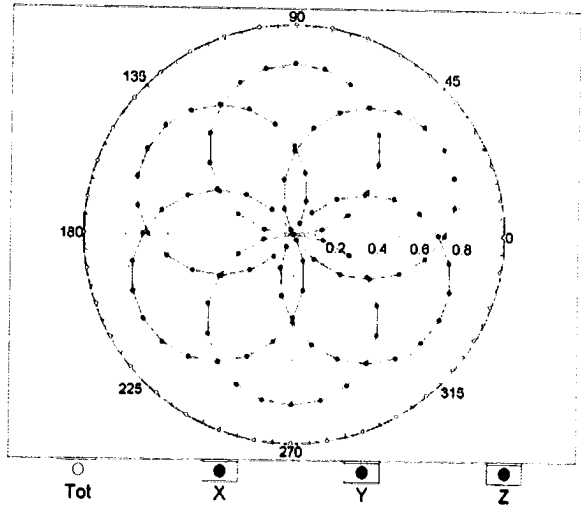

Uncertainty of Axial Isotropy Assessment:  $\pm 0.5\%$  (k=2)

### Dynamic Range $f(\text{SAR}_{\text{head}})$ (TEM cell , $f_{\text{eval}}= 1900 \text{ MHz}$ )

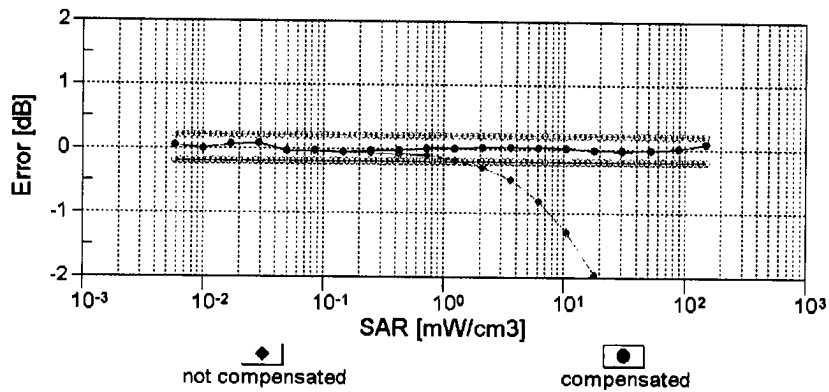
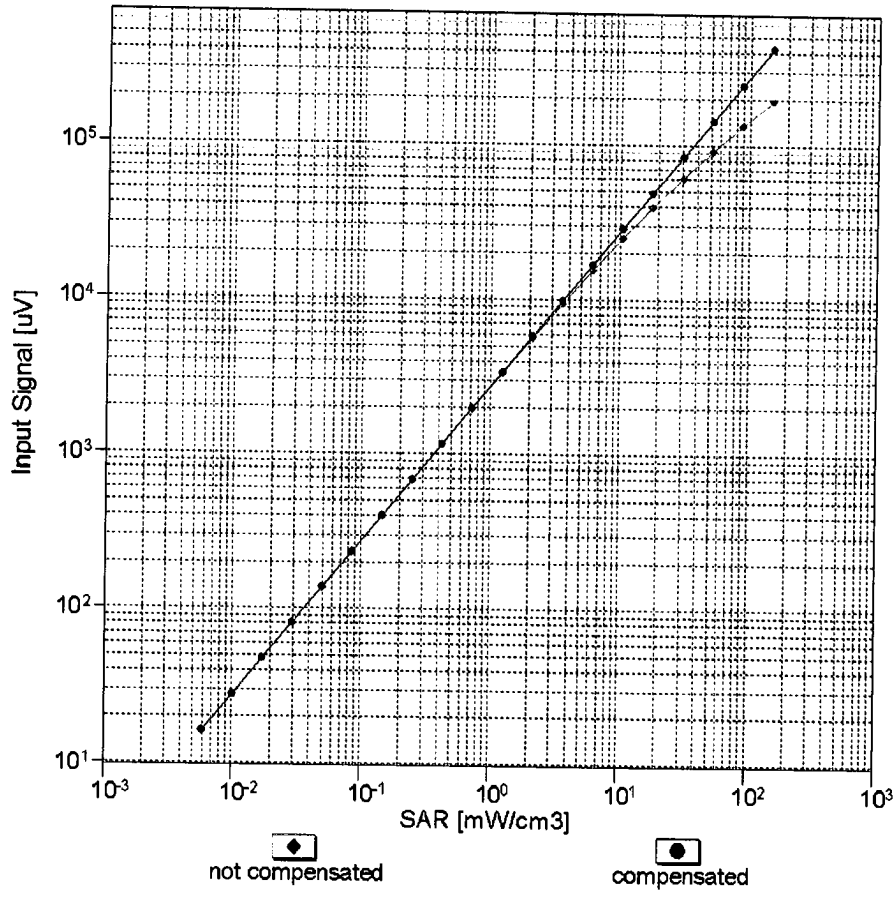

Uncertainty of Linearity Assessment:  $\pm 0.6\%$  (k=2)

# Conversion Factor Assessment

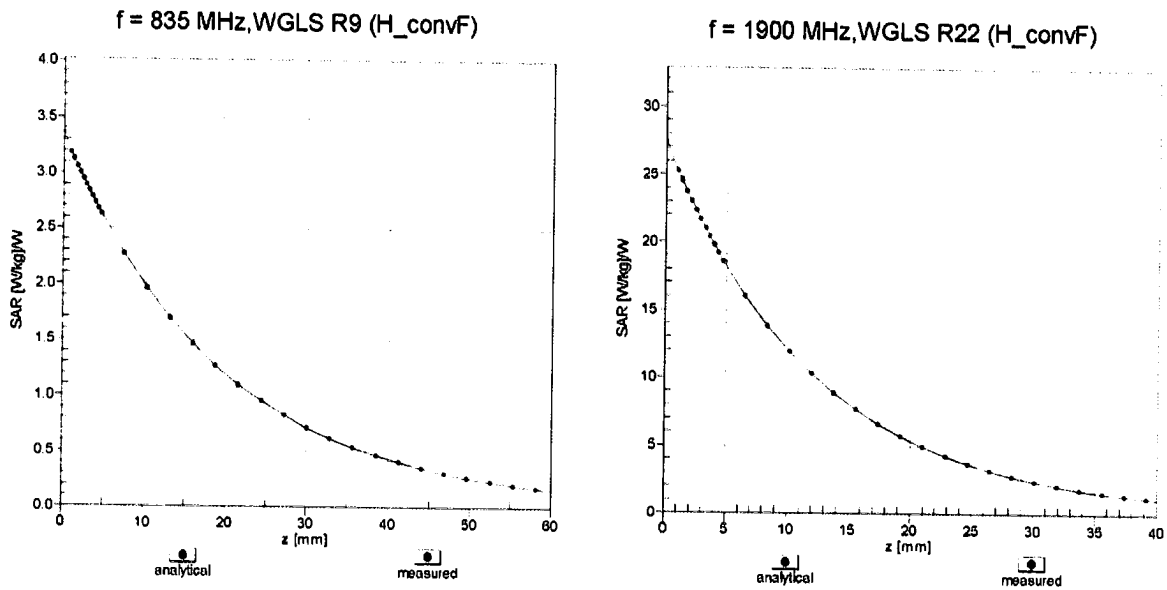

## Deviation from Isotropy in Liquid Error ( $\phi, \theta$ ), f = 900 MHz

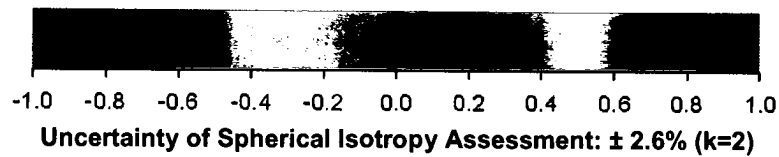
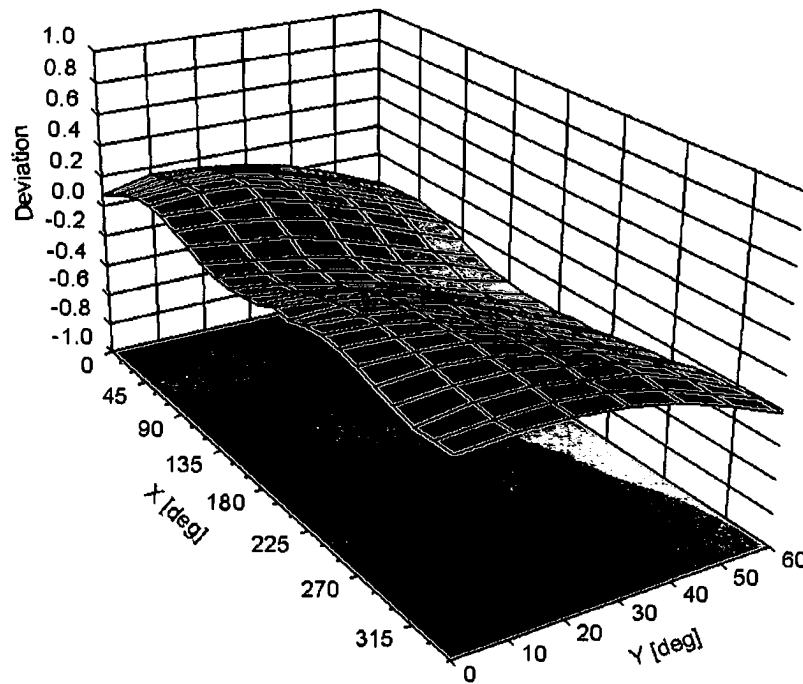

## DASY/EASY - Parameters of Probe: EX3DV4 - SN:3911

### Other Probe Parameters

Sensor Arrangement	Triangular
Connector Angle (°)	-76.3
Mechanical Surface Detection Mode	enabled
Optical Surface Detection Mode	disabled
Probe Overall Length	337 mm
Probe Body Diameter	10 mm
Tip Length	9 mm
Tip Diameter	2.5 mm
Probe Tip to Sensor X Calibration Point	1 mm
Probe Tip to Sensor Y Calibration Point	1 mm
Probe Tip to Sensor Z Calibration Point	1 mm
Recommended Measurement Distance from Surface	1.4 mm