

K50 Antenna

Specifications

► Contents ◀

1. Passive Data

1.1 Wifi Antenna

1.1.1 Antenna type

1.1.2 Gain

1.1.3 Radiation Pattern

1.2 Cellular Antenna

1.2.1 Antenna type

1.2.2 Gain

1.2.3 Radiation Pattern

2 Test Condition

2.1 Test Environment (Condition/Method)

3 Antenna Description

3.1 Type

3.2 Model number

4 List of Measuring Equipment

5 Manufacturer

1.1 Wifi Antenna

1.1.1 Antenna type

Internal antenna

1.1.2 Gain

BAND	Freq[MHZ]	Avg Gain (dbi)	PEAK Gain[dbi]	TX ANT
WIFI2.4/BT	2402-2480	-5.2	-1	ANT7

BAND	Freq[MHZ]	Avg Gain[dbi]	PEAK Gain[dbi]	TX ANT
WIFI 5G	5150-5850	-5	-1.2	ANT0

1.1.3 Radiation Pattern

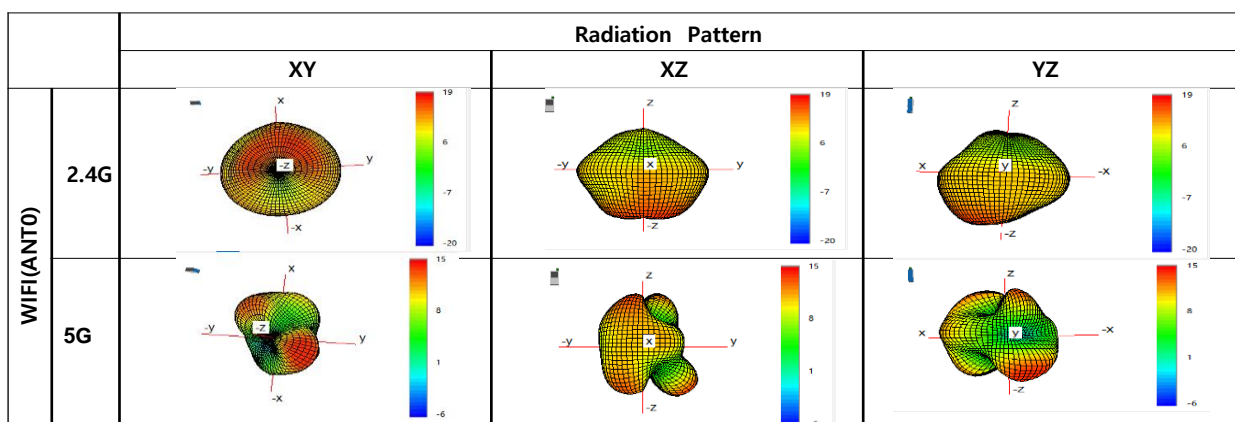

1.2 Cellular Antenna

1.2.1 Antenna type

Internal antenna

1.2.2 Gain

BAND	Freq[MHZ]	Avg Gain[dbi]	PEAK Gain[dbi]	TX ANT
B1	1920-2170	-5	-1.9	ANT5
B25(2)	1850-1995	-4.8	-1.5	ANT5
B3	1710-1880	-5.3	-1.7	ANT5
B66(4)	1710-2180	-5.3	-1.7	ANT5
B26(5)	814-894	-7.4	-3.7	ANT5
B7	2500-2690	-5	-0.8	ANT5
B8	880-960	-7.6	-3	ANT5
B12(17)	699-746	-7.8	-5.2	ANT5
B13	746-787	-7.5	-5.4	ANT5
B28	703-803	-7.6	-4.8	ANT5
B41(38)	2500-2690	-5.1	-1.2	ANT5
B71	617-698	-8	-6.2	ANT5
N2(25)	1850-1995	-4.8	-2.2	ANT1
N66	1710-2180	-4.9	-2.4	ANT1
N77	3300-4200	-5.6	-0.5	ANT3

1.2.3 Radiation Pattern

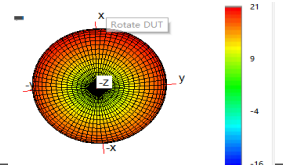
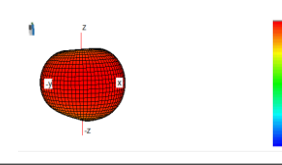
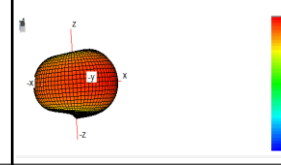
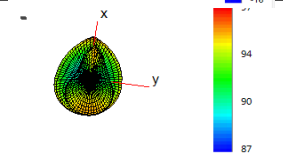
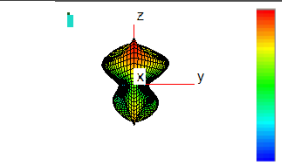
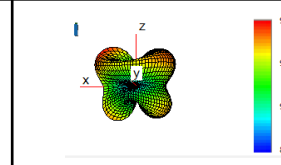
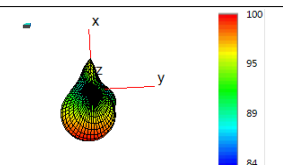
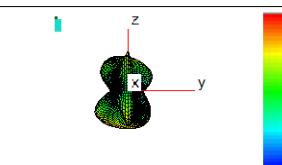
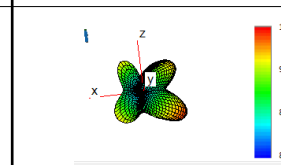
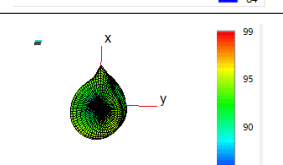
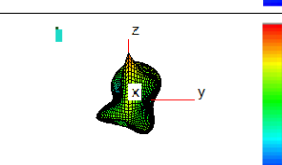
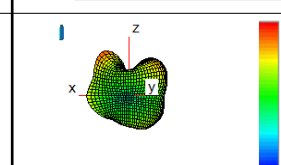
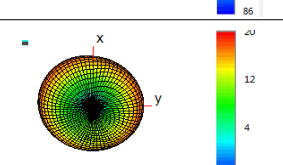
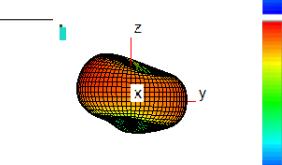
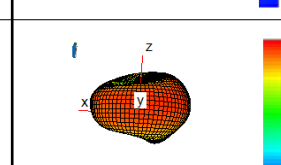
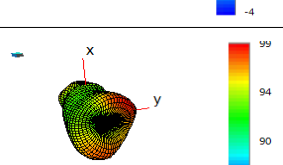
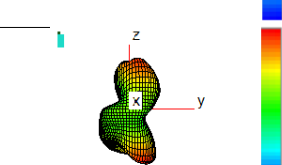
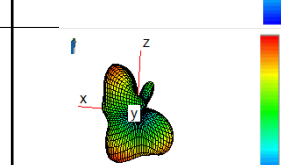
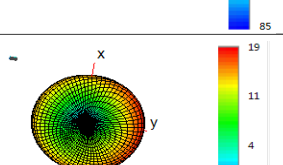
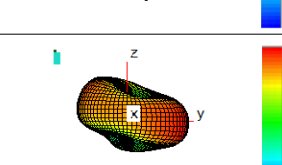
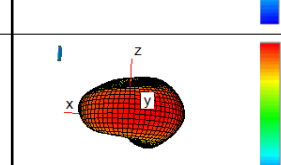
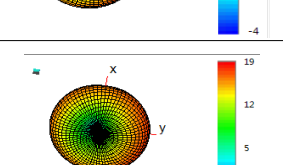
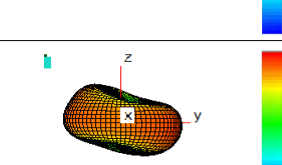
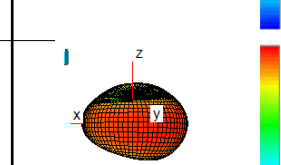
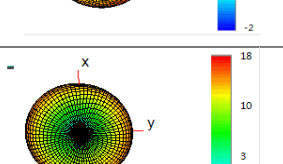
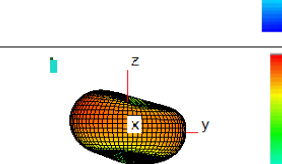
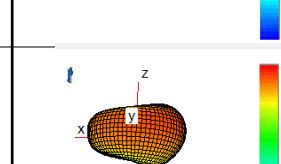
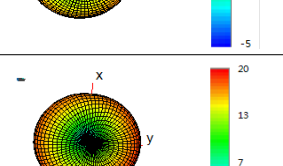
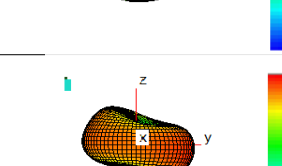
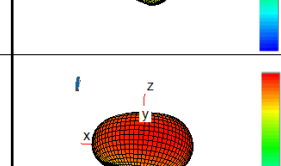
		Radiation Pattern		
		XY	XZ	YZ
Main(ANTO)	B71			
	B25 (2)			
	B3			
	B4 (66)			
	B5(26)			
	B41(38)			
	B8			
	B12 (17)			
	B13			
	B17			

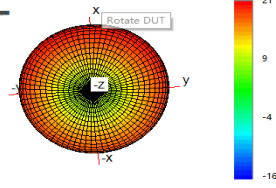
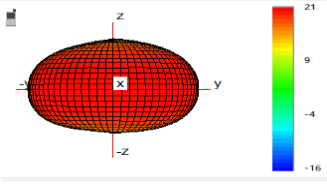
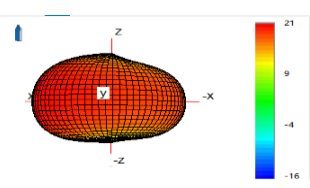
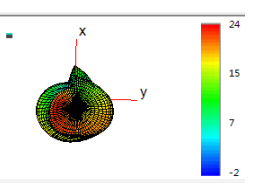
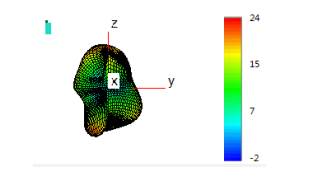
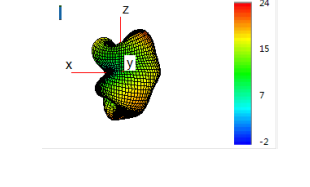
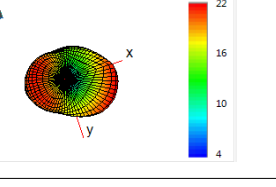
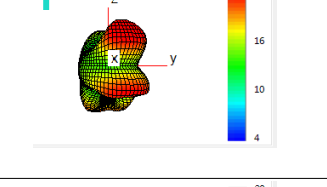
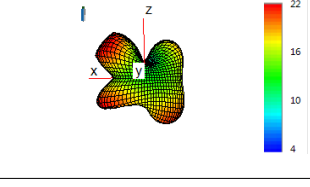
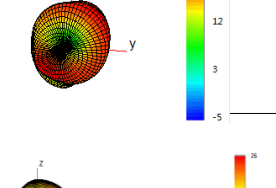
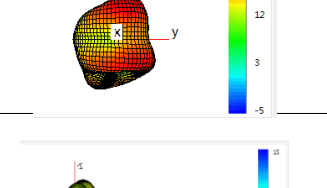
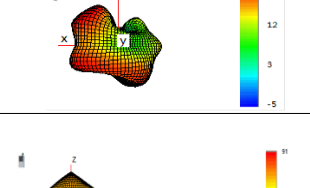
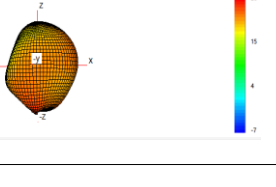
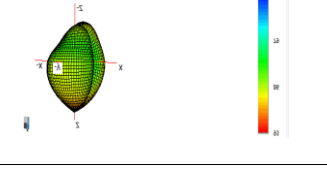
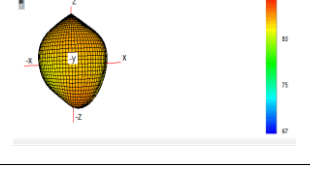
B28			
B7			
N2 (25)			
N66			
N77			

2 Test Condition

2.1 Test Environment (Condition/Method Radiation & Gain)

Step 1. Calibrate the Chamber system using Horn antenna, and set up the software to control the Chamber system at the same time.

Step 2. Keep the measuring antenna to holder.

Step 3. Measure Gain & efficiency.

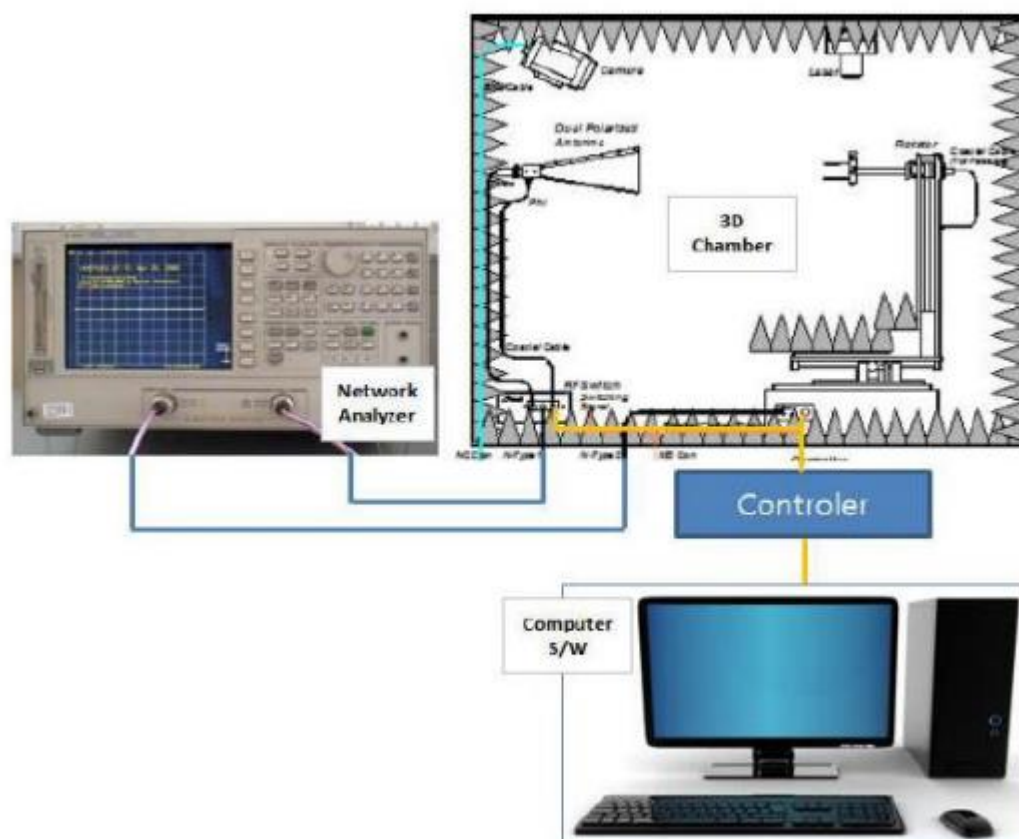

3 Antenna description

Type : Internal Antenna

4 List of Measuring Equipment

Multi-Probe OTA Measurement System

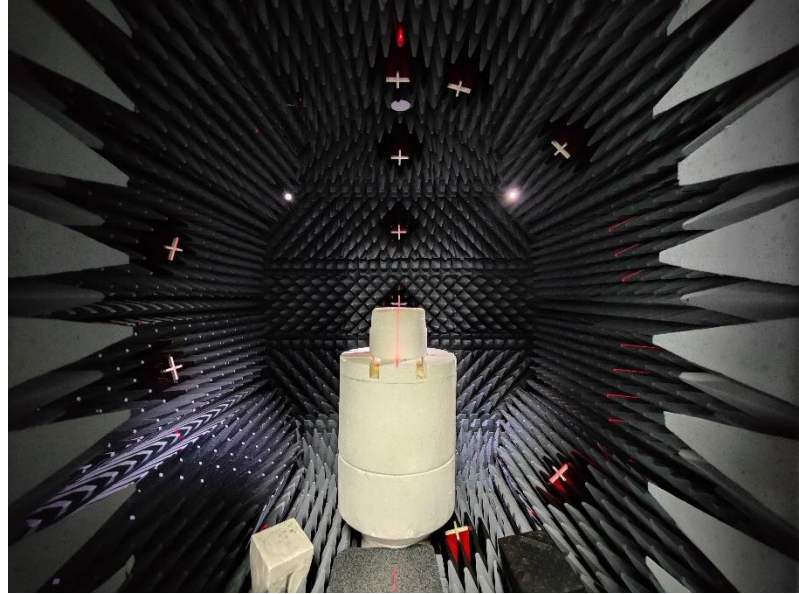
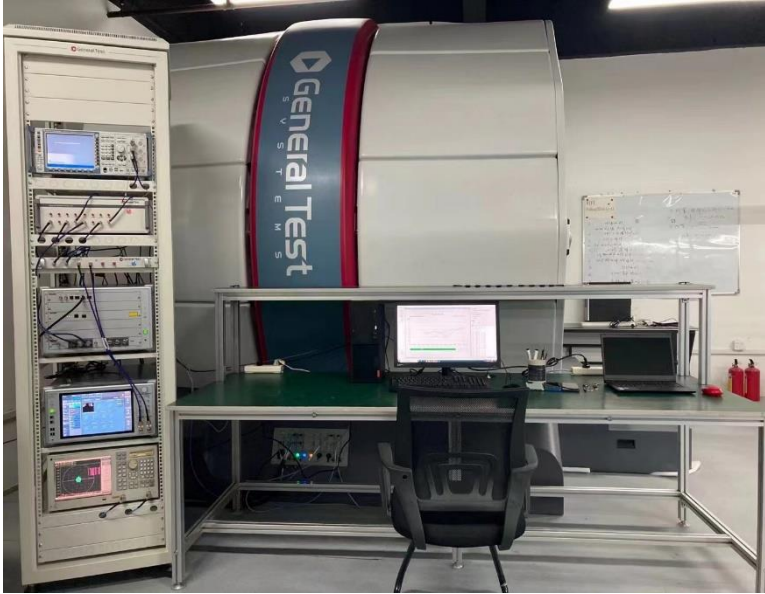

DUT setup photo of free space OTA testing

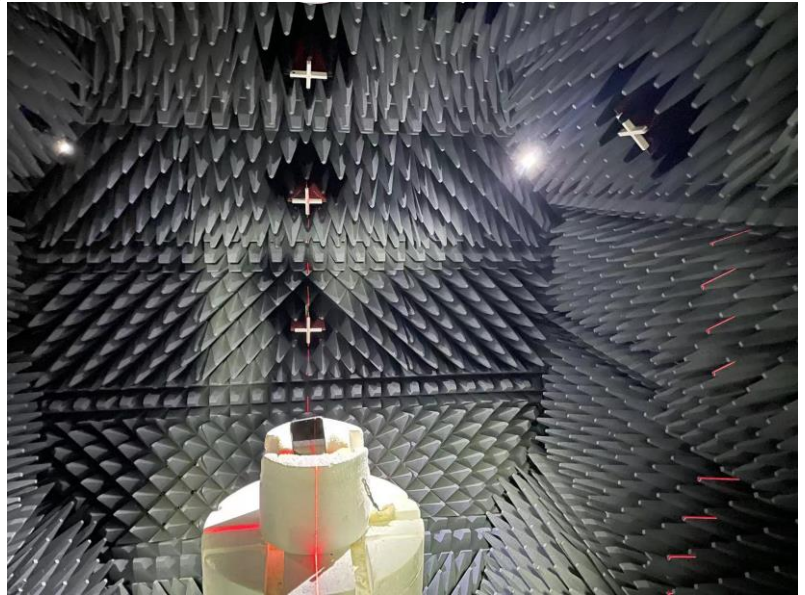
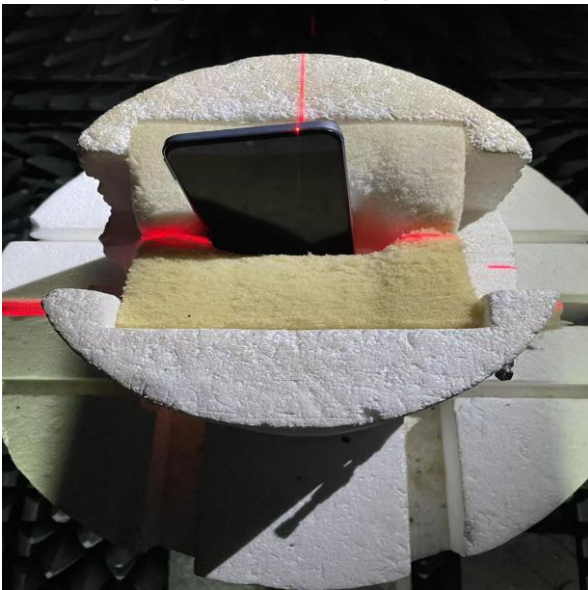

5

Name	shenzhen Fu Bang Wireless Technical Limited Company
Address	3th Floor, Building T1, Lianjian Industrial Park,Huaxing Road, longhuadalang District,Shenzhen
Tel	13691727201
E-mail	eting2007@163.com
Equipment	GTS2800

Model Name	K50	Coosea Group Co.,Ltd.	Fu Bang	Part Number	ALDMARG
Revision	1.0			Revision date	2024-05-24

5.2.Product Specification

5.2.1 Size and shape_Pattern

