

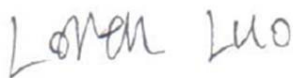

RF TEST REPORT

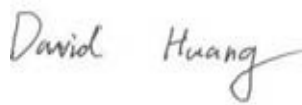

Report No.: 16071331-FCC-R1-V1

Supersede Report No: N/A

Applicant	BLU Products, Inc.	
Product Name	Mobile Phone	
Model No.	GRAND M	
Serial No.	N/A	
Test Standard	FCC Part 22(H):2015 ;FCC Part 24(E):2015; FCC Part 27:2015; ANSI/TIA-603-D: 2010	
Test Date	November 19 to 28, 2016	
Issue Date	December 05, 2016	
Test Result	<input checked="" type="checkbox"/> Pass <input type="checkbox"/> Fail	
Equipment complied with the specification	<input checked="" type="checkbox"/>	
Equipment did not comply with the specification	<input type="checkbox"/>	
		
Loren Luo Test Engineer	David Huang Checked By	
This test report may be reproduced in full only Test result presented in this test report is applicable to the tested sample only		

Issued by:

SIEMIC (SHENZHEN-CHINA) LABORATORIES

Zone A, Floor 1, Building 2 Wan Ye Long Technology Park

South Side of Zhoushi Road, Bao' an District, Shenzhen, Guangdong China 518108

Phone: +86 0755 2601 4629801 Email: China@siemic.com.cn

Laboratories Introduction

SIEMIC, headquartered in the heart of Silicon Valley, with superior facilities in US and Asia, is one of the leading independent testing and certification facilities providing customers with one-stop shop services for Compliance Testing and Global Certifications.



In addition to testing and certification, SIEMIC provides initial design reviews and compliance management throughout a project. Our extensive experience with China, Asia Pacific, North America, European, and International compliance requirements, assures the fastest, most cost effective way to attain regulatory compliance for the global markets.

Accreditations for Conformity Assessment

Country/Region	Scope
USA	EMC, RF/Wireless, SAR, Telecom
Canada	EMC, RF/Wireless, SAR, Telecom
Taiwan	EMC, RF, Telecom, SAR, Safety
Hong Kong	RF/Wireless, SAR, Telecom
Australia	EMC, RF, Telecom, SAR, Safety
Korea	EMI, EMS, RF, SAR, Telecom, Safety
Japan	EMI, RF/Wireless, SAR, Telecom
Singapore	EMC, RF, SAR, Telecom
Europe	EMC, RF, SAR, Telecom, Safety

Test Report	16071331-FCC-R1-V1
Page	3 of 97

This page has been left blank intentionally.

CONTENTS

1. REPORT REVISION HISTORY	5
2. CUSTOMER INFORMATION	5
3. TEST SITE INFORMATION	5
4. EQUIPMENT UNDER TEST (EUT) INFORMATION	6
5. TEST SUMMARY	10
6. MEASUREMENTS, EXAMINATION AND DERIVED RESULTS	11
6.1 RF EXPOSURE (SAR).....	11
6.2 RF OUTPUT POWER.....	12
6.3 PEAK-AVERAGE RATIO.....	23
6.4 OCCUPIED BANDWIDTH.....	28
6.5 SPURIOUS EMISSIONS AT ANTENNA TERMINALS.....	43
6.6 SPURIOUS RADIATED EMISSIONS.....	59
6.7 BAND EDGE.....	66
6.8 FREQUENCY STABILITY	80
ANNEX A. TEST INSTRUMENT.....	85
ANNEX B. EUT AND TEST SETUP PHOTOGRAPHS.....	87
ANNEX C. TEST SETUP AND SUPPORTING EQUIPMENT.....	93
ANNEX C.II. EUT OPERATING CONKITIONS.....	95
ANNEX D. USER MANUAL / BLOCK DIAGRAM / SCHEMATICS / PARTLIST.....	96
ANNEX E. DECLARATION OF SIMILARITY.....	97

1. Report Revision History

Report No.	Report Version	Description	Issue Date
16071331-FCC-R1	NONE	Original	November 29, 2016
16071331-FCC-R1-V1	V1	Updated the antenna type	December 05, 2016

2. Customer information

Applicant Name	BLU Products, Inc.
Applicant Add	10814 NW 33rd St # 100 Doral, FL 33172
Manufacturer	BLU Products, Inc.
Manufacturer Add	10814 NW 33rd St # 100 Doral, FL 33172

3. Test site information

Lab performing tests	SIEMIC (Shenzhen-China) LABORATORIES
Lab Address	Zone A, Floor 1, Building 2 Wan Ye Long Technology Park South Side of Zhoushi Road, Bao' an District, Shenzhen, Guangdong China 518108
FCC Test Site No.	718246
IC Test Site No.	4842E-1
Test Software	Radiated Emission Program-To Shenzhen v2.0

4. Equipment under Test (EUT) Information

Description of EUT:	Mobile Phone
Main Model:	GRAND M
Serial Model:	N/A
Date EUT received:	November 18, 2016
Test Date(s):	November 19 to 28, 2016
Equipment Category :	PCE
Antenna Gain:	GSM850: -1.0dBi PCS1900: -0.6dBi UMTS-FDD Band V: -0.6dBi UMTS-FDD Band II: -1.0dBi UMTS-FDD Band IV: -1.0dBi Bluetooth/BLE/WIFI: -1.0dBi GPS: -1.0dBi
Antenna Type:	GSM/PCS/UMTS-FDD : PIFA antenna WIFI/BT/BLE/GPS: Metallic antenna
Type of Modulation:	GSM / GPRS: GMSK EGPRS: GMSK UMTS-FDD: QPSK 802.11b/g/n: DSSS, OFDM Bluetooth: GFSK, π /4DQPSK, 8DPSK BLE: GFSK GPS:BPSK

Input Power:
 Adapter:
 Model: US-ZC-1005
 Input: AC100-240V~50/60Hz,0.4A
 Output: DC 5.0V-1.0A
 Battery:
 Model: C806239220L
 Voltage: 3.8V
 Capacity: 2200mAh,8.36Wh

**Maximum Conducted
 AV Power to Antenna:**

GSM Voice: GSM850: 32.65 dBm
 PCS1900: 28.95 dBm
 GPRS: GSM850: 32.63 dBm
 PCS1900: 28.93 dBm
 EGPRS: GSM850: 32.63 dBm
 PCS1900: 28.93 dBm
 RMC: UMTS-FDD Band V: 22.67 dBm
 UMTS-FDD Band II: 23.05 dBm
 UMTS-FDD Band IV: 22.66 dBm
 HSUPA: UMTS-FDD Band V: 21.75 dBm
 UMTS-FDD Band II: 22.19 dBm
 UMTS-FDD Band IV: 21.9 dBm
 HSDPA: UMTS-FDD Band V: 21.76 dBm
 UMTS-FDD Band II: 22.03 dBm
 UMTS-FDD Band IV: 21.89 dBm

GSM Voice:GSM850: 29.68 dBm / ERP
 PCS1900: 28.24 dBm / EIRP
 GPRS:GSM850: 29.62 dBm / ERP
 PCS1900: 28.3 dBm / EIRP
 EGPRS:GSM850: 29.57 dBm / ERP
 PCS1900: 28.35 dBm / EIRP
 RMC:UMTS-FDD Band V: 19.99 dBm / ERP
 UTM/FDD Band II: 21.96 dBm / EIRP
 UTM/FDD Band IV: 21.56 dBm / EIRP
 HSUPA:UMTS-FDD Band V: 19.02 dBm / ERP
 UTM/FDD Band II: 21.22 dBm / EIRP
 UTM/FDD Band IV: 20.9 dBm / EIRP
 HSDPA:UMTS-FDD Band V: 19.06 dBm / ERP
 UTM/FDD Band II: 21.04 dBm / EIRP
 UTM/FDD Band IV:20.89 dBm / EIRP

ERP/EIRP:

Port: Power Port, Earphone Port, USB Port

FCC ID: YHLBLUGRANDM

GSM850 TX: 824.2 ~ 848.8 MHz; RX: 869.2 ~ 893.8 MHz
 PCS1900 TX: 1850.2 ~ 1909.8 MHz; RX: 1930.2 ~ 1989.8 MHz
 UTM/FDD Band V TX: 826.4 ~ 846.6 MHz; RX: 871.4 ~ 891.6 MHz
 UTM/FDD Band II TX:1852.4 ~ 1907.6 MHz;
 RX: 1932.4 ~ 1987.6 MHz
 UTM/FDD Band IV TX :1712.4 ~ 1752.6 MHz;
 RX : 2112.4 ~ 2152.6 MHz

RF Operating Frequency (ies):

WIFI: 802.11b/g/n(20M): 2412-2462 MHz
 WIFI: 802.11n(40M): 2422-2452 MHz
 Bluetooth& BLE: 2402-2480 MHz
 GPS: 1575.42 MHz

Test Report	16071331-FCC-R1-V1
Page	9 of 97

Number of Channels: GSM 850: 124CH
PCS1900: 299CH
UMTS-FDD Band V: 102CH
UMTS-FDD Band IV: 202CH
UMTS-FDD Band II: 277CH
WIFI :802.11b/g/n(20M): 11CH
WIFI :802.11n(40M): 7CH
Bluetooth: 79CH
BLE: 40CH
GPS:1CH

Trade Name : BLU

GPRS/EGPRS Multi-slot class 8/10/12

5. Test Summary

The product was tested in accordance with the following specifications.

All testing has been performed according to below product classification:

FCC Rules	Description of Test	Result
§ 1.1307; § 2.1093	RF Exposure (SAR)	Compliance
§2.1046; § 22.913(a); § 24.232(c); § 27.50(c.10) ; § 27.50(d.4)	RF Output Power	Compliance
§ 24.232 (d) ; § 27.50(d)	Peak-Average Ratio	Compliance
§ 2.1049; § 22.905; § 22.917; § 24.238; § 27.53(a.5)	99% & -26 dB Occupied Bandwidth	Compliance
§ 2.1051; § 22.917(a); § 24.238(a); § 27.53(h)	Spurious Emissions at Antenna Terminal	Compliance
§ 2.1053; § 22.917(a); § 24.238(a); § 27.53(h)	Field Strength of Spurious Radiation	Compliance
§ 22.917(a); § 24.238(a); § 27.53(h)	Out of band emission, Band Edge	Compliance
§ 2.1055; § 22.355; § 24.235; § 27.5(h); § 27.54	Frequency stability vs. temperature Frequency stability vs. voltage	Compliance

Note: Testing was performed by configuring EUT to maximum output power status, the declared output power class for different

Measurement Uncertainty

Emissions		
Test Item	Description	Uncertainty
Band Edge and Radiated Spurious Emissions	Confidence level of approximately 95% (in the case where distributions are normal), with a coverage factor of 2 (for EUTs < 0.5m X 0.5m X 0.5m)	+5.6dB/-4.5dB
-	-	-

6. MEASUREMENTS, EXAMINATION AND DERIVED RESULTS

6.1 RF Exposure (SAR)

Test Result: Pass

The EUT is a portable device, thus requires SAR evaluation;

Please refer to RF Exposure Evaluation Report: 16071331-FCC-H.

6.2 RF Output Power

Temperature	25°C
Relative Humidity	57%
Atmospheric Pressure	1024mbar
Test date :	November 24, 2016
Tested By :	Loren Luo

Requirement(s):

Spec	Item	Requirement	Applicable
§22.913 (a)	a)	ERP:38.45dBm	<input checked="" type="checkbox"/>
§24.232 (c)	b)	EIRP:33dBm	<input checked="" type="checkbox"/>
§27.50 (c)	c)	EIRP: 30dBm	<input checked="" type="checkbox"/>

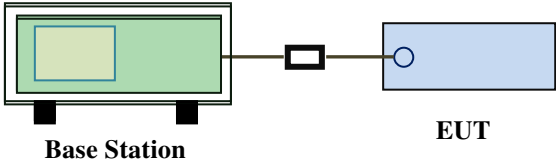
Test Setup	 <p>The diagram illustrates the test setup. On the left is a green rectangular box labeled 'Base Station'. A line connects it to a small black square, which is connected to a blue rectangular box labeled 'EUT'.</p>
------------	--

Test Procedure	<p>For Conducted Power:</p> <ul style="list-style-type: none"> - The transmitter output port was connected to base station. - Set EUT at maximum power through base station. - Select lowest, middle, and highest channels for each band and different test mode. <p>For ERP/EIRP:</p> <p>According with KDB 971168 v02r02</p> <ul style="list-style-type: none"> - The transmitter was placed on a wooden turntable, and it was transmitting into a non-radiating load which was also placed on the turntable. - The measurement antenna was placed at a distance of 3 meters from the EUT. During the tests, the antenna height and polarization as well as EUT azimuth were varied in order to identify the maximum level of emissions from the EUT. The test was performed by placing the EUT on 3-orthogonal axis. - The frequency range up to tenth harmonic of the fundamental
----------------	---

	<p>frequency was investigated.</p> <ul style="list-style-type: none"> - Remove the EUT and replace it with substitution antenna. A signal generator was connected to the substitution antenna by a non-radiating cable. The absolute levels of the spurious emissions were measured by the substitution. - Spurious emissions in dB = 10 log (TX power in Watts/0.001) – the absolute level - Spurious attenuation limit in dB = 43 + 10 Log10 (power out in Watts).
Remark	
Result	<input checked="" type="checkbox"/> Pass <input type="checkbox"/> Fail

Test Data Yes N/A

Test Plot Yes (See below) N/A

Conducted Power

GSM Mode:

Burst Average Power (dBm);								
Band	GSM850				PCS1900			
Channel	128	190	251	Tune up Power tolerant	512	661	810	Tune up Power tolerant
Frequency (MHz)	824.2	836.6	848.8	/	1850.2	1880	1909.8	/
GSM Voice (1 uplink),GMSK	32.65	32.57	32.52	32±1	28.49	28.65	28.95	28.5±1
GPRS Multi-Slot Class 8 (1 uplink),GMSK	32.63	32.57	32.47	32±1	28.42	28.6	28.93	28.5±1
GPRS Multi-Slot Class 10 (2 uplink) GMSK	31.85	31.8	31.79	31±1	27.69	27.89	28.21	27.5±1
GPRS Multi-Slot Class 12 (4 uplink) GMSK	29.05	29.01	28.99	29±1	24.81	25.07	25.46	25±1
EGPRS Multi-Slot Class 8 (1 uplink) GMSK MCS1	32.63	32.55	32.45	32±1	28.4	28.59	28.93	28±1
EGPRS Multi-Slot Class 10 (2 uplink) GMSK MCS1	31.83	31.79	31.75	31±1	27.65	27.83	28.18	28±1
EGPRS Multi-Slot Class 12 (4 uplink) GMSK MCS1	29.05	29	28.92	29±1	24.71	24.95	25.37	25±1

Remark :

GPRS, CS1 coding scheme.

EGPRS, MCS1 coding scheme.

Multi-Slot Class 8 , Support Max 4 downlink, 1 uplink , 5 working link

Multi-Slot Class 10 , Support Max 4 downlink, 2 uplink , 5 working link

Multi-Slot Class 12 , Support Max 4 downlink, 4 uplink , 5 working link

UMTS Mode:

UMTS-FDD Band V

Band/ Time Slot configuration	Channel	Frequency	Average power (dBm)	Tune up Power tolerant
RMC 12.2kbps	4132	826.4	22.67	22.5±1
	4175	835	22.62	22.5±1
	4233	846.6	22.65	22.5±1
HSDPA Subtest1	4132	826.4	21.69	21.5±1
	4175	835	21.73	21.5±1
	4233	846.6	21.72	21.5±1
HSDPA Subtest2	4132	826.4	21.70	21.5±1
	4175	835	21.66	21.5±1
	4233	846.6	21.69	21.5±1
HSDPA Subtest3	4132	826.4	21.73	21.5±1
	4175	835	21.76	21.5±1
	4233	846.6	21.71	21.5±1
HSDPA Subtest4	4132	826.4	21.70	21.5±1
	4175	835	21.75	21.5±1
	4233	846.6	21.69	21.5±1
HSUPA Subtest1	4132	826.4	21.68	21.5±1
	4175	835	21.73	21.5±1
	4233	846.6	21.71	21.5±1
HSUPA Subtest2	4132	826.4	21.69	21.5±1
	4175	835	21.70	21.5±1
	4233	846.6	21.74	21.5±1
HSUPA Subtest3	4132	826.4	21.69	21.5±1
	4175	835	21.71	21.5±1
	4233	846.6	21.73	21.5±1
HSUPA Subtest4	4132	826.4	21.69	21.5±1
	4175	835	21.72	21.5±1
	4233	846.6	21.68	21.5±1
HSUPA Subtest5	4132	826.4	21.73	21.5±1
	4175	835	21.75	21.5±1
	4233	846.6	21.64	21.5±1

UMTS-FDD Band II

Band/ Time Slot configuration	Channel	Frequency	Average power (dBm)	Tune up Power tolerant
RMC 12.2kbps	9262	1852.4	22.94	23±1
	9400	1880	23.05	23±1
	9538	1907.6	22.76	23±1
HSDPA Subtest1	9262	1852.4	22.03	22±1
	9400	1880	21.95	22±1
	9538	1907.6	21.99	22±1
HSDPA Subtest2	9262	1852.4	21.86	22±1
	9400	1880	21.81	22±1
	9538	1907.6	21.85	22±1
HSDPA Subtest3	9262	1852.4	21.95	22±1
	9400	1880	21.91	22±1
	9538	1907.6	21.96	22±1
HSDPA Subtest4	9262	1852.4	21.77	22±1
	9400	1880	21.74	22±1
	9538	1907.6	21.72	22±1
HSUPA Subtest1	9262	1852.4	21.88	22±1
	9400	1880	21.89	22±1
	9538	1907.6	21.92	22±1
HSUPA Subtest2	9262	1852.4	21.96	22±1
	9400	1880	21.94	22±1
	9538	1907.6	21.97	22±1
HSUPA Subtest3	9262	1852.4	21.99	22±1
	9400	1880	21.93	22±1
	9538	1907.6	22.05	22±1
HSUPA Subtest4	9262	1852.4	22.14	22±1
	9400	1880	22.11	22±1
	9538	1907.6	22.19	22±1
HSUPA Subtest5	9262	1852.4	21.93	22±1
	9400	1880	21.96	22±1
	9538	1907.6	21.92	22±1

UMTS-FDD Band IV

Band/ Time Slot configuration	Channel	Frequency	Average power (dBm)	Tune up Power tolerant
RMC 12.2kbps	1313	1712.6	22.66	22±1
	1413	1732.6	22.21	22±1
	1512	1752.4	22.66	22±1
HSDPA Subtest1	1313	1712.6	21.87	21.8±1
	1413	1732.6	21.88	21.8±1
	1512	1752.4	21.85	21.8±1
HSDPA Subtest2	1313	1712.6	21.87	21.8±1
	1413	1732.6	21.88	21.8±1
	1512	1752.4	21.82	21.8±1
HSDPA Subtest3	1313	1712.6	21.87	21.8±1
	1413	1732.6	21.81	21.8±1
	1512	1752.4	21.83	21.8±1
HSDPA Subtest4	1313	1712.6	21.84	21.8±1
	1413	1732.6	21.84	21.8±1
	1512	1752.4	21.89	21.8±1
HSUPA Subtest1	1313	1712.6	21.90	21.8±1
	1413	1732.6	21.87	21.8±1
	1512	1752.4	21.83	21.8±1
HSUPA Subtest2	1313	1712.6	21.84	21.8±1
	1413	1732.6	21.82	21.8±1
	1512	1752.4	21.85	21.8±1
HSUPA Subtest3	1313	1712.6	21.83	21.8±1
	1413	1732.6	21.88	21.8±1
	1512	1752.4	21.89	21.8±1
HSUPA Subtest4	1313	1712.6	21.85	21.8±1
	1413	1732.6	21.82	21.8±1
	1512	1752.4	21.85	21.8±1
HSUPA Subtest5	1313	1712.6	21.83	21.8±1
	1413	1732.6	21.87	21.8±1
	1512	1752.4	21.89	21.8±1

ERP & EIRP

GSM Voice

ERP for Cellular Band (Part 22H)

Frequency (MHz)	Substituted level (dBm)	Antenna Polarization	Antenna Gain correction (dBi)	Cable Loss (dB)	Absolute Level (dBm)	Limit (dBm)
824.2	23.28	V	6.8	0.53	29.55	38.45
824.2	21.64	H	6.8	0.53	27.91	38.45
836.6	23.22	V	6.8	0.53	29.49	38.45
836.6	21.56	H	6.8	0.53	27.83	38.45
848.8	23.31	V	6.9	0.53	29.68	38.45
848.8	21.68	H	6.9	0.53	28.05	38.45

EIRP for PCS Band (Part 24E)

Frequency (MHz)	Substituted level (dBm)	Antenna Polarization	Antenna Gain correction (dBi)	Cable Loss (dB)	Absolute Level (dBm)	Limit (dBm)
1850.2	20.85	V	7.88	0.85	27.88	33
1850.2	19.53	H	7.88	0.85	26.56	33
1880	20.96	V	7.88	0.85	27.99	33
1880	19.62	H	7.88	0.85	26.65	33
1909.8	21.23	V	7.86	0.85	28.24	33
1909.8	19.96	H	7.86	0.85	26.97	33

GPRS:

ERP for Cellular Band (Part 22H)

Frequency (MHz)	Substituted level (dBm)	Antenna Polarization	Antenna Gain correction (dBi)	Cable Loss (dB)	Absolute Level (dBm)	Limit (dBm)
824.2	23.27	V	6.8	0.53	29.54	38.45
824.2	21.63	H	6.8	0.53	27.90	38.45
836.6	23.35	V	6.8	0.53	29.62	38.45
836.6	21.74	H	6.8	0.53	28.01	38.45
848.8	23.16	V	6.9	0.53	29.53	38.45
848.8	21.53	H	6.9	0.53	27.90	38.45

EIRP for PCS Band (Part 24E)

Frequency (MHz)	Substituted level (dBm)	Antenna Polarization	Antenna Gain correction (dBi)	Cable Loss (dB)	Absolute Level (dBm)	Limit (dBm)
1850.2	20.87	V	7.88	0.85	27.90	33
1850.2	19.55	H	7.88	0.85	26.58	33
1880	20.99	V	7.88	0.85	28.02	33
1880	19.65	H	7.88	0.85	26.68	33
1909.8	21.29	V	7.86	0.85	28.30	33
1909.8	20.04	H	7.86	0.85	27.05	33

EGPRS(MCS1):

ERP for Cellular Band (Part 22H)

Frequency (MHz)	Substituted level (dBm)	Antenna Polarization	Antenna Gain correction (dBi)	Cable Loss (dB)	Absolute Level (dBm)	Limit (dBm)
824.2	23.19	V	6.8	0.53	29.46	38.45
824.2	21.56	H	6.8	0.53	27.83	38.45
836.6	23.24	V	6.8	0.53	29.51	38.45
836.6	21.61	H	6.8	0.53	27.88	38.45
848.8	23.2	V	6.9	0.53	29.57	38.45
848.8	21.55	H	6.9	0.53	27.92	38.45

EIRP for PCS Band (Part 24E)

Frequency (MHz)	Substituted level (dBm)	Antenna Polarization	Antenna Gain correction (dBi)	Cable Loss (dB)	Absolute Level (dBm)	Limit (dBm)
1850.2	20.91	V	7.88	0.85	27.94	33
1850.2	19.59	H	7.88	0.85	26.62	33
1880	20.04	V	7.88	0.85	27.07	33
1880	19.71	H	7.88	0.85	26.74	33
1909.8	21.34	V	7.86	0.85	28.35	33
1909.8	20.11	H	7.86	0.85	27.12	33

RMC

ERP for UMTS-FDD Band V (Part 22H)

Frequency (MHz)	Substituted level (dBm)	Antenna Polarization	Antenna Gain correction (dBi)	Cable Loss (dB)	Absolute Level (dBm)	Limit (dBm)
826.4	13.54	V	6.8	0.53	19.81	38.45
826.4	12.43	H	6.8	0.53	18.70	38.45
835	13.59	V	6.8	0.53	19.86	38.45
835	12.48	H	6.8	0.53	18.75	38.45
846.6	13.62	V	6.9	0.53	19.99	38.45
846.6	12.51	H	6.9	0.53	18.88	38.45

EIRP for UMTS-FDD Band II (Part 24E)

Frequency (MHz)	Substituted level (dBm)	Antenna Polarization	Antenna Gain correction (dBi)	Cable Loss (dB)	Absolute Level (dBm)	Limit (dBm)
1852.4	14.86	V	7.88	0.85	21.89	33
1852.4	13.72	H	7.88	0.85	20.75	33
1880	14.93	V	7.88	0.85	21.96	33
1880	13.82	H	7.88	0.85	20.85	33
1907.6	14.78	V	7.86	0.85	21.79	33
1907.6	13.64	H	7.86	0.85	20.65	33

EIRP for UMTS-FDD Band IV (Part 27H)

Frequency (MHz)	Substituted level (dBm)	Antenna Polarization	Antenna Gain correction (dBi)	Cable Loss (dB)	Absolute Level (dBm)	Limit (dBm)
1712.4	14.62	V	7.76	0.82	21.56	30
1712.4	13.57	H	7.76	0.82	20.51	30
1740	14.31	V	7.76	0.82	21.25	30
1740	13.15	H	7.76	0.82	20.09	30
1752.6	14.58	V	7.74	0.82	21.50	30
1752.6	13.52	H	7.74	0.82	20.44	30

HSDPA

ERP for UMTS-FDD Band V (Part 22H)

Frequency (MHz)	Substituted level (dBm)	Antenna Polarization	Antenna Gain correction (dBi)	Cable Loss (dB)	Absolute Level (dBm)	Limit (dBm)
826.4	12.78	V	6.8	0.53	19.05	38.45
826.4	11.64	H	6.8	0.53	17.91	38.45
835	12.73	V	6.8	0.53	19.00	38.45
835	11.59	H	6.8	0.53	17.86	38.45
846.6	12.69	V	6.9	0.53	19.06	38.45
846.6	11.52	H	6.9	0.53	17.89	38.45

EIRP for UMTS-FDD Band II (Part 24E)

Frequency (MHz)	Substituted level (dBm)	Antenna Polarization	Antenna Gain correction (dBi)	Cable Loss (dB)	Absolute Level (dBm)	Limit (dBm)
1852.4	13.85	V	7.88	0.85	20.88	33
1852.4	12.7	H	7.88	0.85	19.73	33
1880	13.94	V	7.88	0.85	20.97	33
1880	12.84	H	7.88	0.85	19.87	33
1907.6	14.03	V	7.86	0.85	21.04	33
1907.6	12.91	H	7.86	0.85	19.92	33

EIRP for UMTS-FDD Band IV (Part 27H)

Frequency (MHz)	Substituted level (dBm)	Antenna Polarization	Antenna Gain correction (dBi)	Cable Loss (dB)	Absolute Level (dBm)	Limit (dBm)
1712.4	13.82	V	7.76	0.82	20.76	30
1712.4	12.76	H	7.76	0.82	19.70	30
1740	13.95	V	7.76	0.82	20.89	30
1740	12.87	H	7.76	0.82	19.81	30
1752.6	13.92	V	7.74	0.82	20.84	30
1752.6	12.83	H	7.74	0.82	19.75	30

HSUPA

ERP for UMTS-FDD Band V (Part 22H)

Frequency (MHz)	Substituted level (dBm)	Antenna Polarization	Antenna Gain correction (dBi)	Cable Loss (dB)	Absolute Level (dBm)	Limit (dBm)
826.4	12.75	V	6.8	0.53	19.02	38.45
826.4	11.62	H	6.8	0.53	17.89	38.45
835	12.68	V	6.8	0.53	18.95	38.45
835	11.51	H	6.8	0.53	17.78	38.45
846.6	12.63	V	6.9	0.53	19.00	38.45
846.6	11.47	H	6.9	0.53	17.84	38.45

EIRP for UMTS-FDD Band II (Part 24E)

Frequency (MHz)	Substituted level (dBm)	Antenna Polarization	Antenna Gain correction (dBi)	Cable Loss (dB)	Absolute Level (dBm)	Limit (dBm)
1852.4	13.94	V	7.88	0.85	20.97	33
1852.4	12.86	H	7.88	0.85	19.89	33
1880	14.14	V	7.88	0.85	21.17	33
1880	12.98	H	7.88	0.85	20.01	33
1907.6	14.21	V	7.86	0.85	21.22	33
1907.6	13.03	H	7.86	0.85	20.04	33

EIRP for UMTS-FDD Band IV (Part 27H)

Frequency (MHz)	Substituted level (dBm)	Antenna Polarization	Antenna Gain correction (dBi)	Cable Loss (dB)	Absolute Level (dBm)	Limit (dBm)
1712.4	13.86	V	7.76	0.82	20.80	30
1712.4	12.79	H	7.76	0.82	19.73	30
1740	13.91	V	7.76	0.82	20.85	30
1740	12.82	H	7.76	0.82	19.76	30
1752.6	13.98	V	7.74	0.82	20.90	30
1752.6	12.9	H	7.74	0.82	19.82	30

6.3 Peak-Average Ratio

Temperature	25°C
Relative Humidity	57%
Atmospheric Pressure	1024mbar
Test date :	November 24, 2016
Tested By :	Loren Luo

Requirement(s):

Spec	Item	Requirement	Applicable
§24.232(d) § 27.50(d)	a)	The peak-to-average ratio (PAR) of the transmission may not exceed 13 dB.	<input checked="" type="checkbox"/>

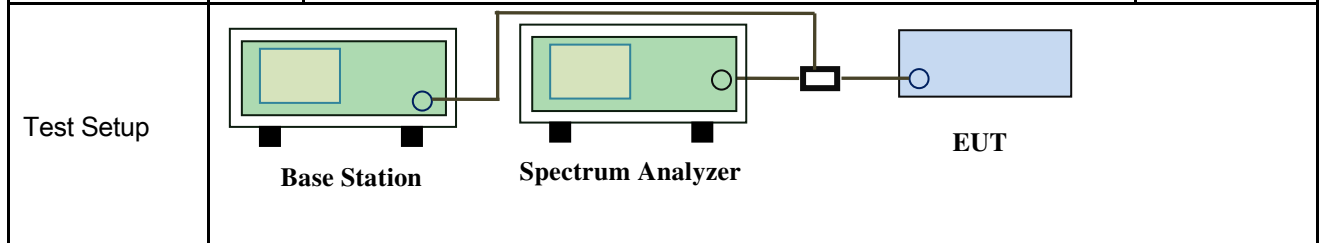

Test Procedure	<p>According with KDB 971168 v02r02</p> <p>5.7.2 Alternate procedure for PAPR</p> <p>5.1.2 Peak power measurements with a peak power meter</p> <p>The total peak output power may be measured using a broadband peak RF power meter. The power meter must have a video bandwidth that is greater than or equal to the emission bandwidth and utilize a fast-responding diode detector.</p> <p>5.2.3 Average power measurement with average power meter</p> <p>As an alternative to the use of a spectrum/signal analyzer or EMI receiver to perform a measurement of the total in-band average output power, a wideband RF average power meter with a thermocouple detector or equivalent can be used under certain conditions</p> <p>If the EUT can be configured to transmit continuously (i.e., the burst duty cycle $\geq 98\%$) and at all times the EUT is transmitting at its maximum output</p>
----------------	--

	<p>power level, then a conventional wide-band RF power meter can be used.</p> <p>If the EUT cannot be configured to transmit continuously (i.e., the burst duty cycle < 98%), then there are two options for the use of an average power meter. First, a gated average power meter can be used to perform the measurement if the gating parameters can be adjusted such that the power is measured only over active transmission bursts at maximum output power levels. A conventional average power meter can also be used if the measured burst duty cycle is constant (i.e., duty cycle variations are less than ± 2 percent) by performing the measurement over the on/off burst cycles and then correcting (increasing) the measured level by a factor equal to $10\log(1/\text{duty cycle})$</p>
Remark	
Result	<input checked="" type="checkbox"/> Pass <input type="checkbox"/> Fail

Test Data Yes N/A
 Test Plot Yes (See below) N/A

GSM : GSM 1900 PK-AV POWER(PART 24E)

Frequency (MHz)	Conducted power(dBm)		Peak-Average Ratio(PAR)
	Peak	Average	
1850.2	26.7	28.49	-1.79
1880	26.88	28.85	-1.97
1909.8	26.94	28.95	-2.01

GPRS 1900 PK-AV POWER (PART 24E)

Frequency (MHz)	Conducted power(dBm)		Peak-Average Ratio(PAR)
	Peak	Average	
1850.2	26.28	28.42	-2.14
1880	26.19	28.6	-2.41
1909.8	26.46	28.93	-2.47

RMC : UMTS-FDD Band 2 PK-AV POWER (PART 24E)

Frequency (MHz)	Conducted power(dBm)		Peak-Average Ratio(PAR)
	Peak	Average	
1852.4	23.33	22.94	0.39
1880	23.51	23.05	0.46
1907.6	23.12	22.76	0.36

UMTS-FDD Band 4 PK-AV POWER (PART 24E)

Frequency (MHz)	Conducted power(dBm)		Peak-Average Ratio(PAR)
	Peak	Average	
1712.6	23.21	22.66	0.55
1732.6	22.6	22.21	0.39
1752.4	23.17	22.66	0.51

HSUPA : UMTS-FDD Band 2 PK-AV POWER (PART 24E)

Frequency (MHz)	Conducted power(dBm)		Peak-Average Ratio(PAR)
	Peak	Average	
1852.4	22.31	21.88	0.43
1880	22.25	21.89	0.36
1907.6	22.38	21.92	0.46

UMTS-FDD Band 4 PK-AV POWER (PART 24E)

Frequency (MHz)	Conducted power(dBm)		Peak-Average Ratio(PAR)
	Peak	Average	
1712.6	22.2	21.9	0.30
1732.6	22.26	21.87	0.39
1752.4	22.22	21.83	0.39

HSDPA : UMTS-FDD Band 2 PK-AV POWER (PART 24E)

Frequency (MHz)	Conducted power(dBm)		Peak-Average Ratio(PAR)
	Peak	Average	
1852.4	22.68	22.03	0.65
1880	22.68	21.95	0.73
1907.6	22.74	21.99	0.75

UMTS-FDD Band 4 PK-AV POWER (PART 24E)

Frequency (MHz)	Conducted power(dBm)		Peak-Average Ratio(PAR)
	Peak	Average	
1712.6	22.36	21.87	0.49
1732.6	22.29	21.88	0.41
1752.4	22.38	21.85	0.53

6.4 Occupied Bandwidth

Temperature	25°C
Relative Humidity	57%
Atmospheric Pressure	1024mbar
Test date :	November 24, 2016
Tested By :	Loren Luo

Requirement(s):

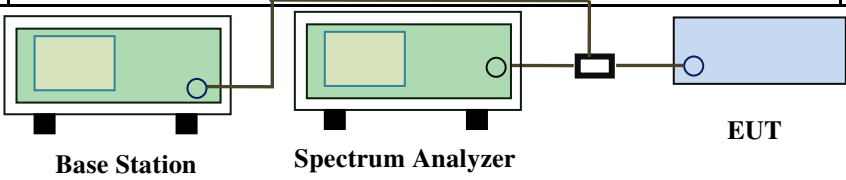
Spec	Item	Requirement	Applicable
§2.1049, §22.917, §22.905 §24.238 §27.53(a)	a)	99% Occupied Bandwidth(kHz)	<input checked="" type="checkbox"/>
	b)	26 dB Bandwidth(kHz)	<input checked="" type="checkbox"/>
Test Setup	 <p>The diagram illustrates the test setup. On the left is a green box labeled 'Base Station'. A line connects it to a central green box labeled 'Spectrum Analyzer'. From the Spectrum Analyzer, a line goes to a small black box representing a power divider. From the power divider, a line connects to a blue box labeled 'EUT'.</p>		
Test Procedure	<ul style="list-style-type: none"> - The EUT was connected to Spectrum Analyzer and Base Station via power divider. - The 99% and 26 dB occupied bandwidth (BW) of the middle channel for the highest RF powers. 		
Remark			
Result	<input checked="" type="checkbox"/> Pass <input type="checkbox"/> Fail		

Test Data Yes N/A

Test Plot Yes (See below) N/A

GSM Voice:

Cellular Band (Part 22H) result

Channel	Frequency (MHz)	99% Occupied Bandwidth (kHz)	26 dB Bandwidth (kHz)
128	824.2	250.55	323.0
190	836.6	248.16	321.3
251	848.8	246.06	320.3

PCS Band (Part 24E) result

Channel	Frequency (MHz)	99% Occupied Bandwidth (kHz)	26 dB Bandwidth (kHz)
512	1850.2	245.16	319.9
661	1880.0	245.17	314.5
810	1909.8	246.47	318.5

GPRS:

Cellular Band (Part 22H) result

Channel	Frequency (MHz)	99% Occupied Bandwidth (kHz)	26 dB Bandwidth (kHz)
128	824.2	244.99	318.5
190	836.6	247.62	319.6
251	848.8	246.13	318.7

PCS Band (Part 24E) result

Channel	Frequency (MHz)	99% Occupied Bandwidth (kHz)	26 dB Bandwidth (kHz)
512	1850.2	244.96	317.8
661	1880.0	246.83	318.8
810	1909.8	245.58	318.5

EGPRS (MCS 1):

Cellular Band (Part 22H) result

Channel	Frequency (MHz)	99% Occupied Bandwidth (kHz)	26 dB Bandwidth (kHz)
128	824.2	249.10	321.1
190	836.6	247.97	317.8
251	848.8	244.05	320.4

PCS Band (Part 24E) result

Channel	Frequency (MHz)	99% Occupied Bandwidth (kHz)	26 dB Bandwidth (kHz)
512	1850.2	245.49	321.9
661	1880.0	244.77	320.5
810	1909.8	248.55	319.8

RMC:

UMTS-FDD Band V (Part 22H)

Channel	Frequency (MHz)	99% Occupied Bandwidth (MHz)	26 dB Bandwidth (MHz)
4132	826.4	4.1540	4.650
4175	835.0	4.1510	4.675
4233	846.6	4.1551	4.673

UMTS-FDD Band II (Part 24E)

Channel	Frequency (MHz)	99% Occupied Bandwidth (MHz)	26 dB Bandwidth (MHz)
9262	1852.4	4.1548	4.659
9400	1880.0	4.1582	4.666
9538	1907.6	4.1541	4.686

UMTS-FDD Band IV (Part 27)

Channel	Frequency (MHz)	99% Occupied Bandwidth (MHz)	26 dB Bandwidth (MHz)
1313	1712.6	4.1534	4.694
1413	1732.6	4.1633	4.666
1512	1752.4	4.1589	4.683

HSUPA:

UMTS-FDD Band V (Part 22H)

Channel	Frequency (MHz)	99% Occupied Bandwidth (MHz)	26 dB Bandwidth (MHz)
4132	826.4	4.1525	4.681
4175	835.0	4.1500	4.673
4233	846.6	4.1484	4.670

UMTS-FDD Band II (Part 24E)

Channel	Frequency (MHz)	99% Occupied Bandwidth (MHz)	26 dB Bandwidth (MHz)
9262	1852.4	4.1606	4.658
9400	1880.0	4.1584	4.659
9538	1907.6	4.1644	4.686

UMTS-FDD Band IV (Part 27)

Channel	Frequency (MHz)	99% Occupied Bandwidth (MHz)	26 dB Bandwidth (MHz)
1313	1712.6	4.1587	4.661
1413	1732.6	4.1488	4.654
1512	1752.4	4.1559	4.655

HSDPA:

UMTS-FDD Band V (Part 22H)

Channel	Frequency (MHz)	99% Occupied Bandwidth (MHz)	26 dB Bandwidth (MHz)
4132	826.4	4.1585	4.690
4175	835.0	4.1547	4.679
4233	846.6	4.1589	4.676

UMTS-FDD Band II (Part 24E)

Channel	Frequency (MHz)	99% Occupied Bandwidth (MHz)	26 dB Bandwidth (MHz)
9262	1852.4	4.1541	4.674
9400	1880.0	4.1655	4.672
9538	1907.6	4.1566	4.644

UMTS-FDD Band IV (Part 27)

Channel	Frequency (MHz)	99% Occupied Bandwidth (MHz)	26 dB Bandwidth (MHz)
1313	1712.6	4.1661	4.671
1413	1732.6	4.1612	4.684
1512	1752.4	4.1741	4.685

Test Plots

GMS Voice:

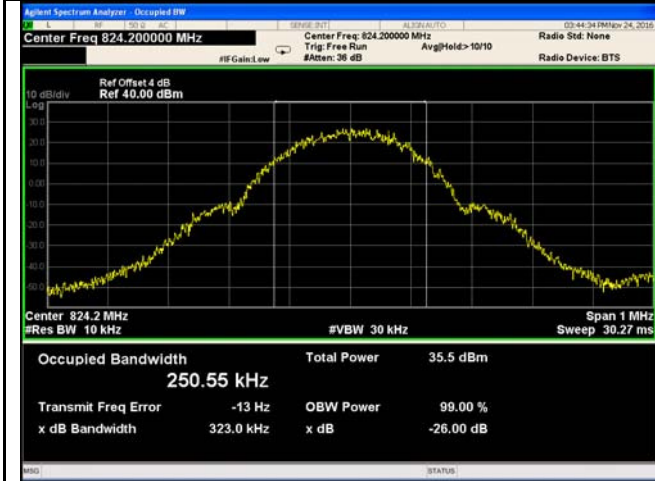

GSM 850 BW - Low CH 824.2MHz

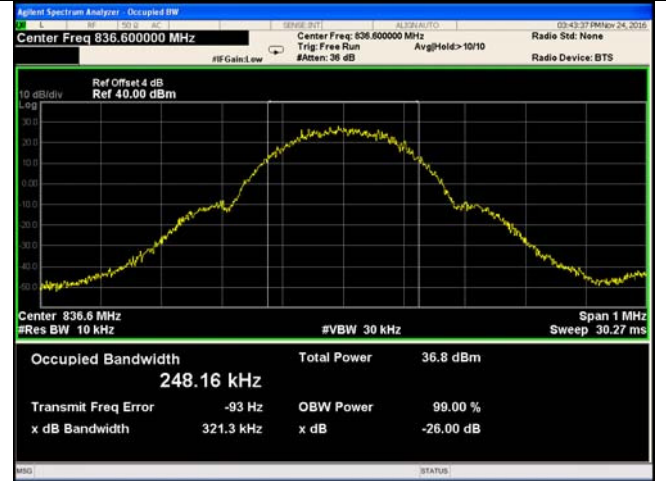

GSM 850 BW - Mid CH 836.6MHz

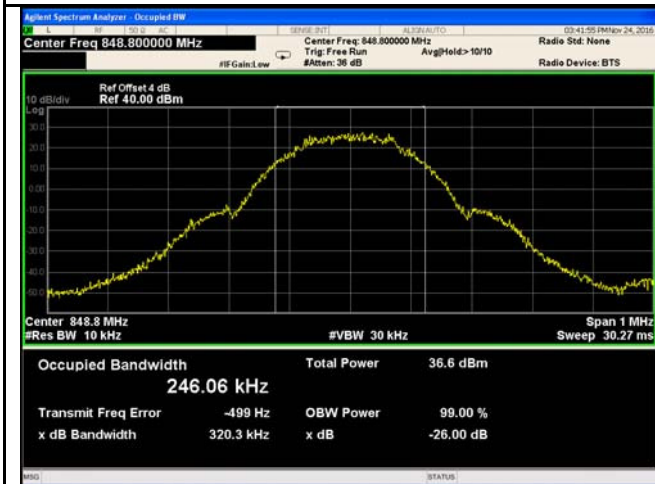

GSM 850 BW - High CH 848.8MHz

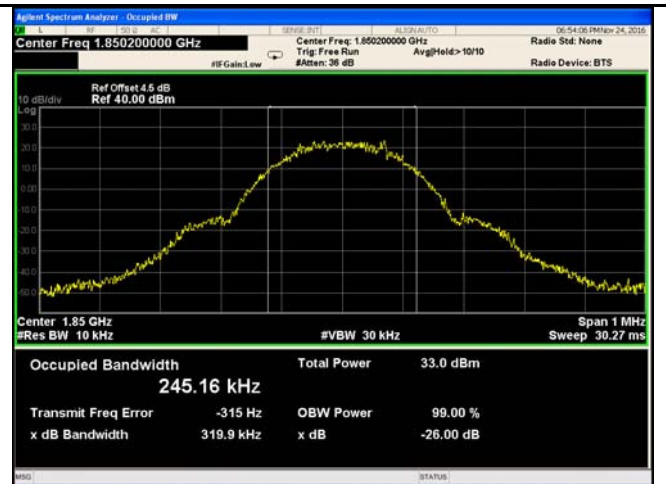

PCS 1900 BW - Low CH 1850.2MHz

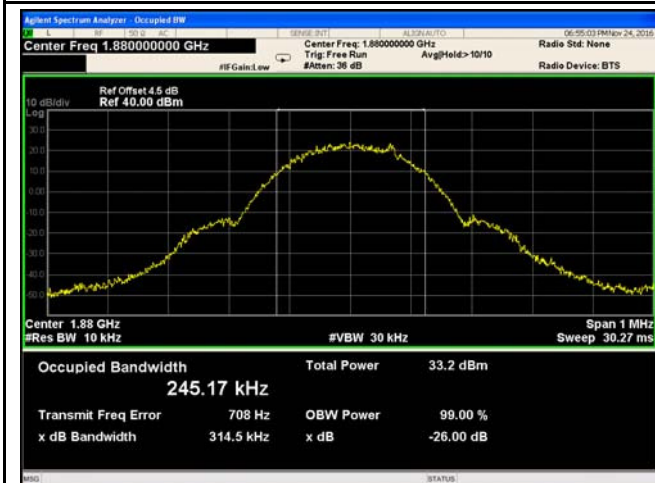

PCS 1900 BW - Mid CH 1880MHz

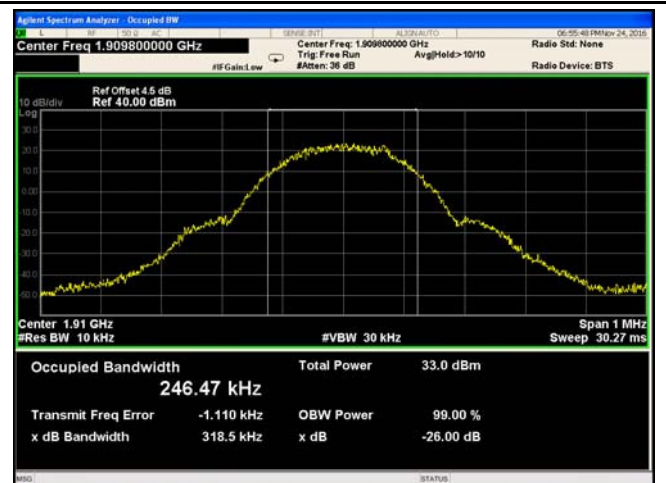

PCS 1900 BW - High CH 1909.8MHz

GPRS:

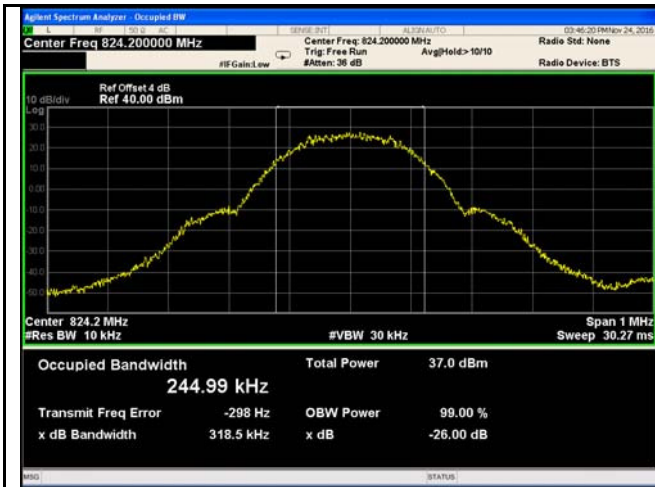

GSM 850 BW - Low CH 824.2MHz

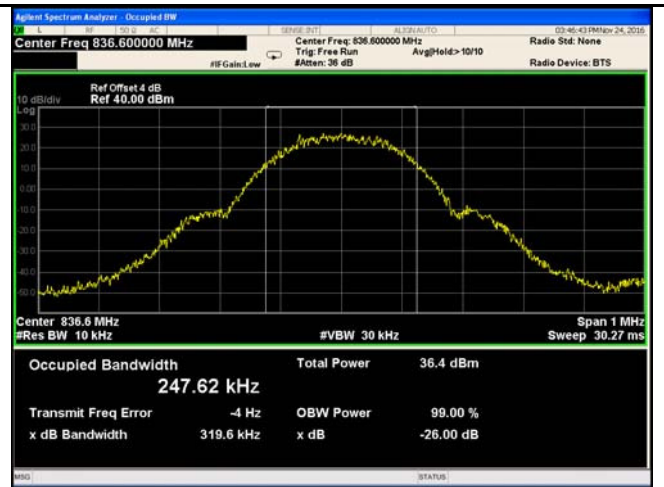

GSM 850 BW - Mid CH 836.6MHz

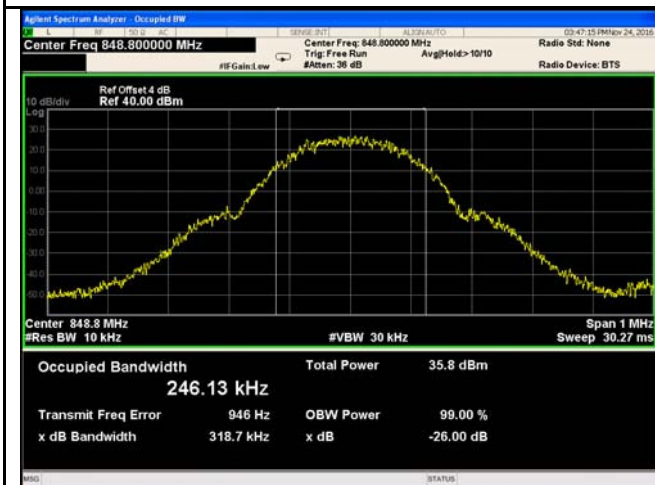

GSM 850 BW - High CH 848.8MHz

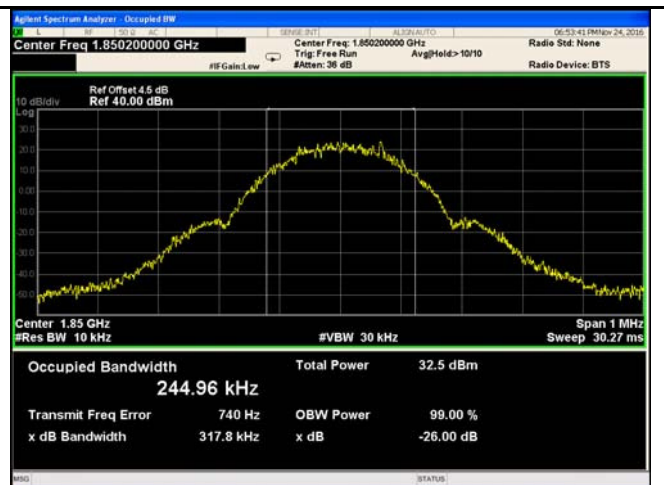

PCS 1900 BW - Low CH 1850.2MHz

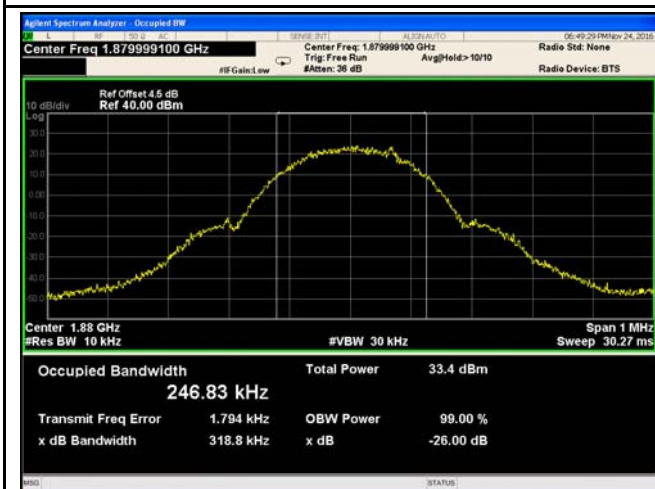

PCS 1900 BW - Mid CH 1880MHz

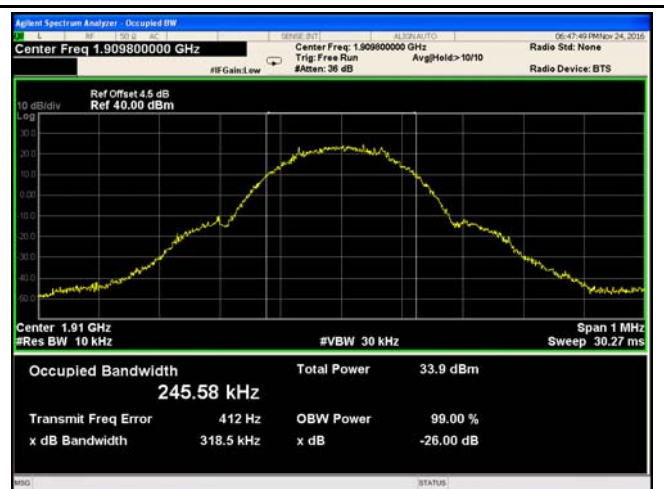

PCS 1900 BW - High CH 1909.8MHz

EGPRS:

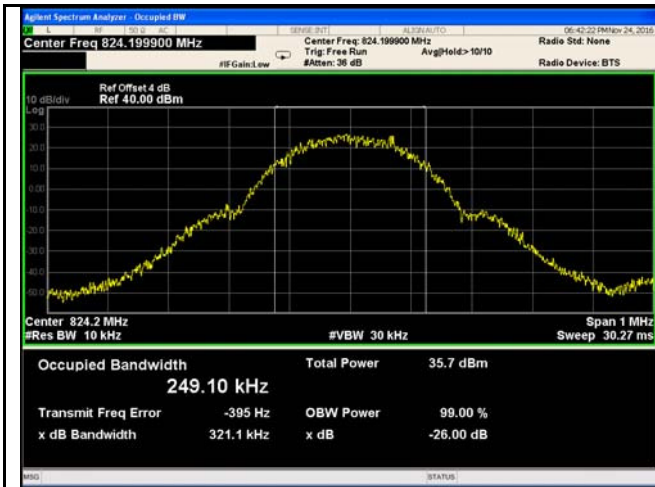

GSM 850 BW - Low CH 824.2MHz

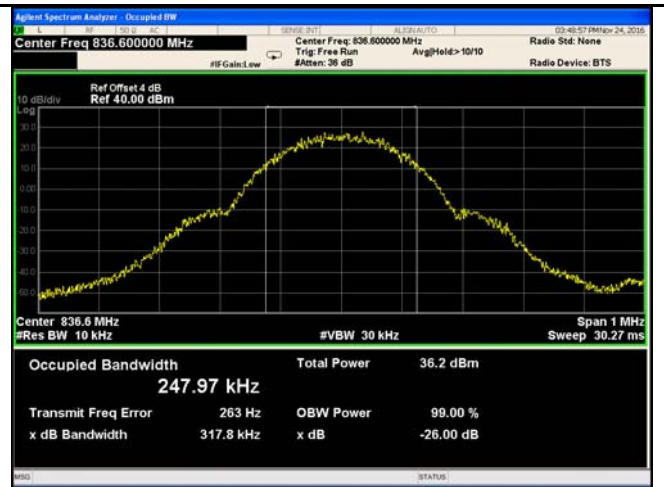

GSM 850 BW - Mid CH 836.6MHz

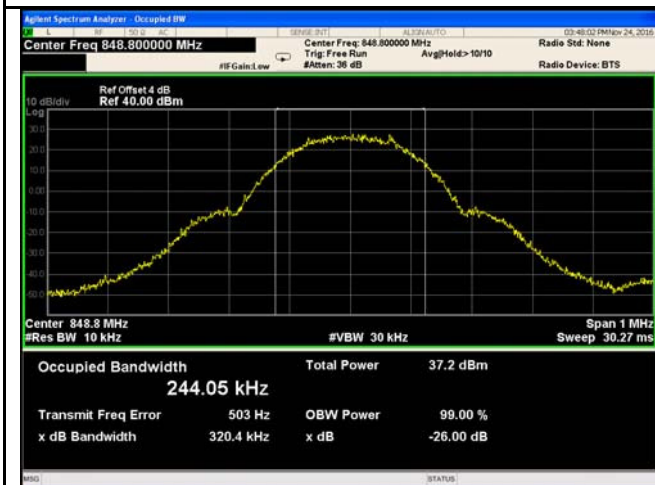

GSM 850 BW - High CH 848.8MHz

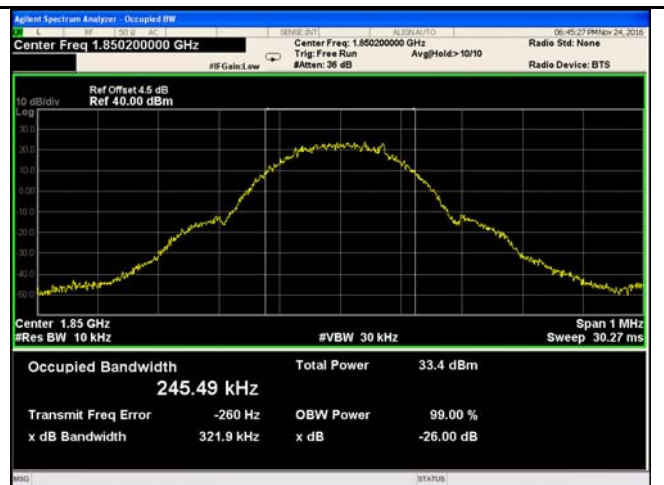

PCS 1900 BW - Low CH 1850.2MHz

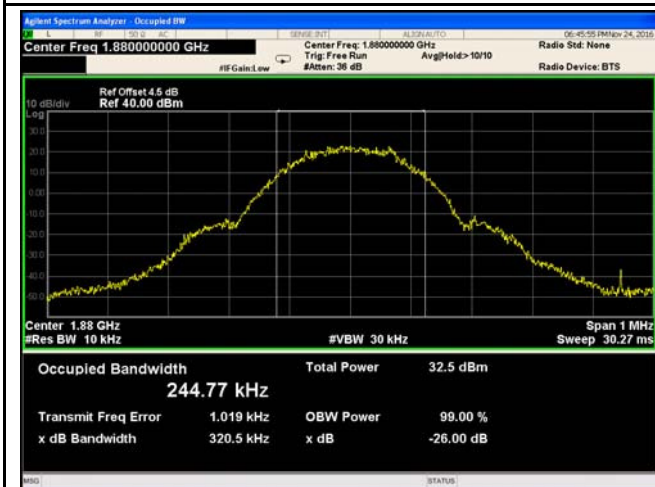

PCS 1900 BW - Mid CH 1880MHz

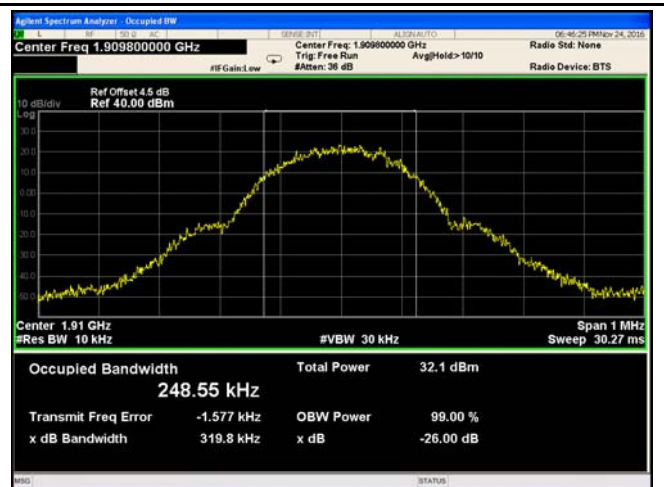

PCS 1900 BW - High CH 1909.8MHz

RMC:

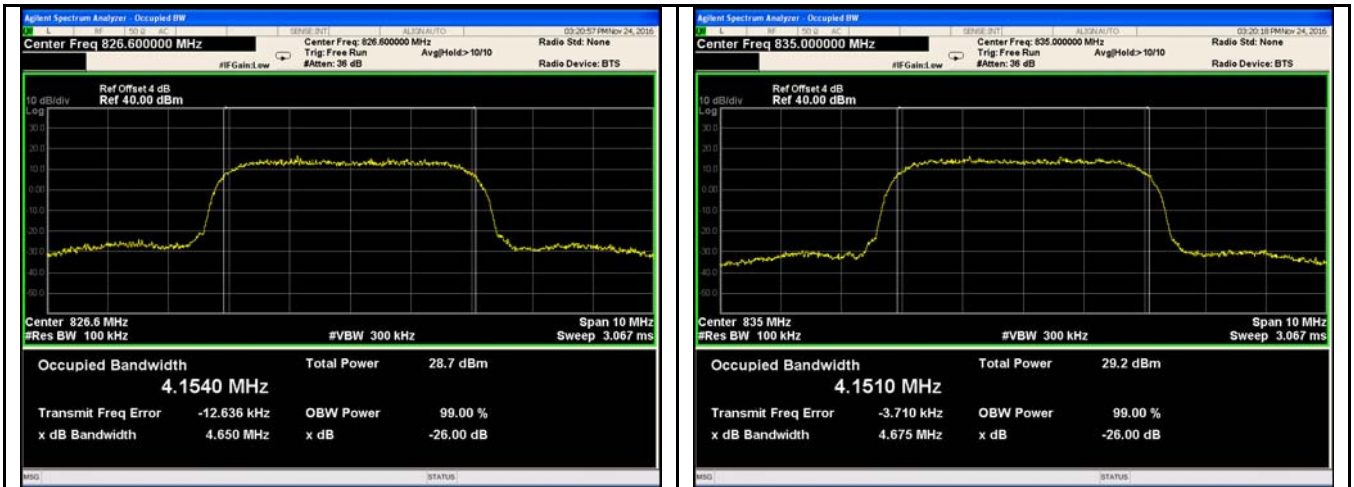

Band V BW - Low CH 826.6 MHz

Band V BW - Mid CH 835.0 MHz

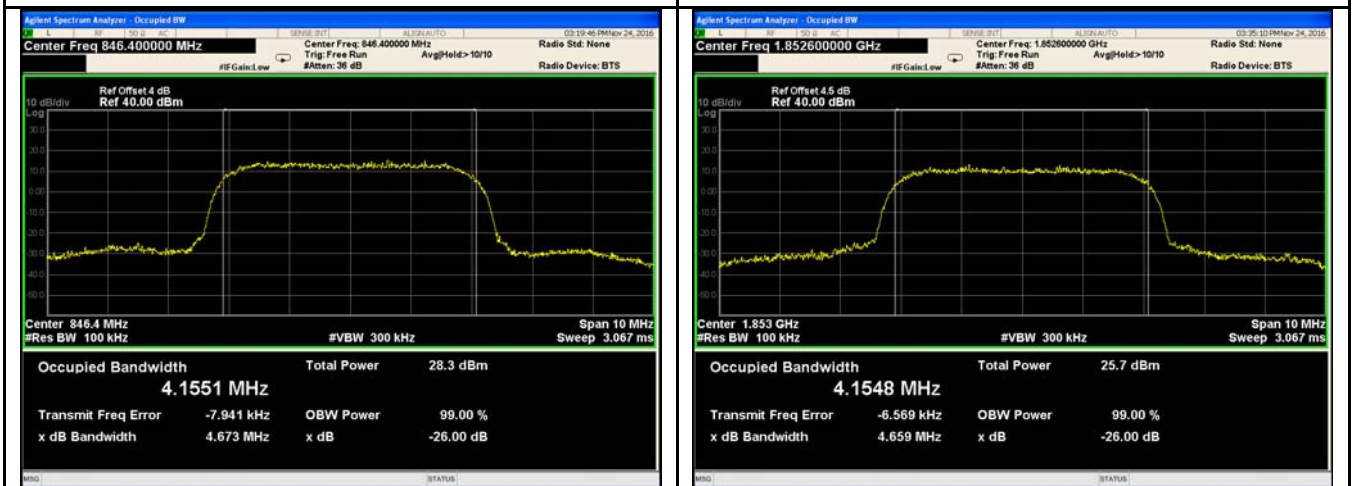

Band V BW - High CH 846.4 MHz

Band II BW - Low CH 1852.4MHz

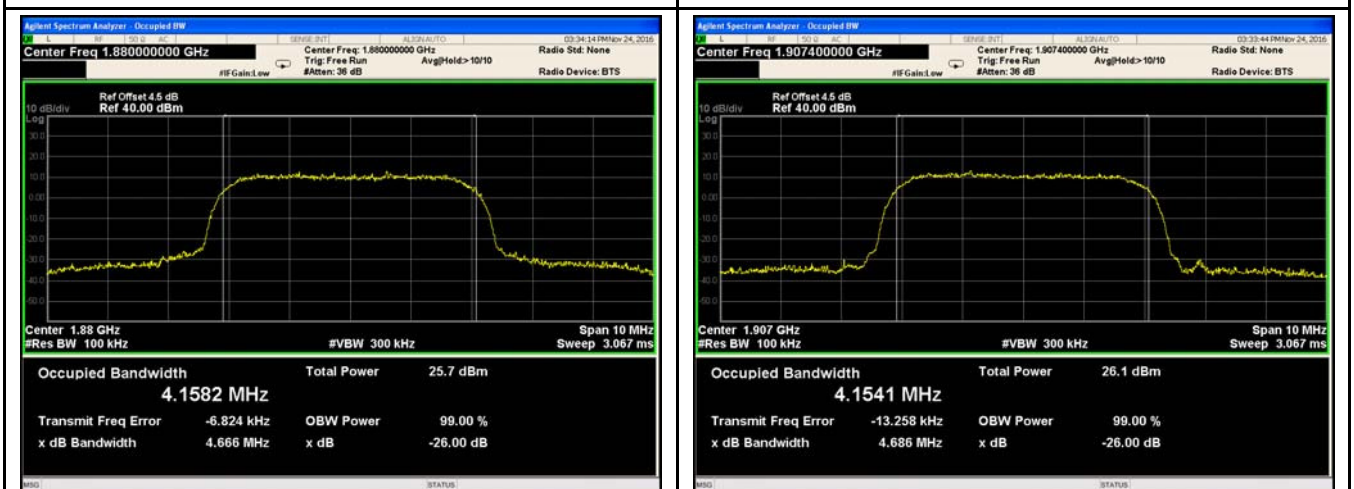

Band II BW - Mid CH 1880MHz

Band II BW - High CH 1907.6MHz

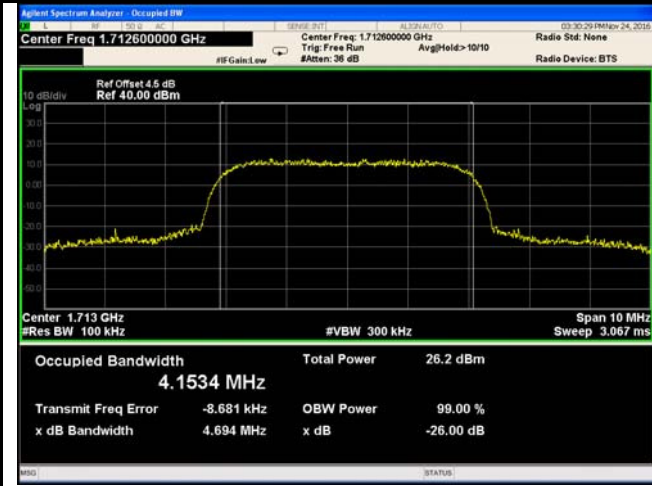

Band IV BW - Low CH 1852.4MHz

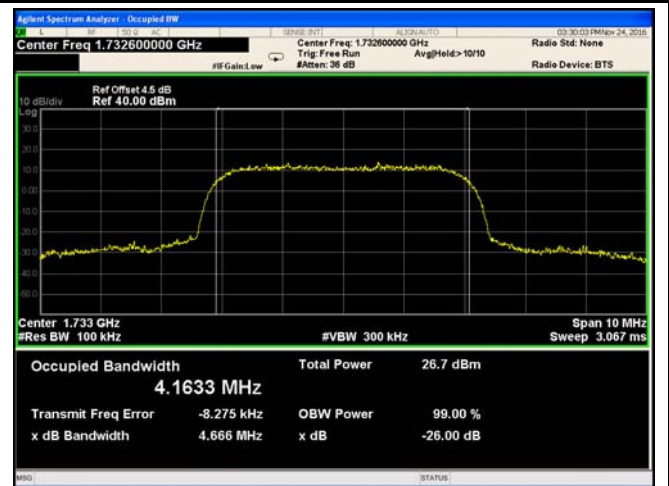

Band IVBW - Mid CH 1880MHz

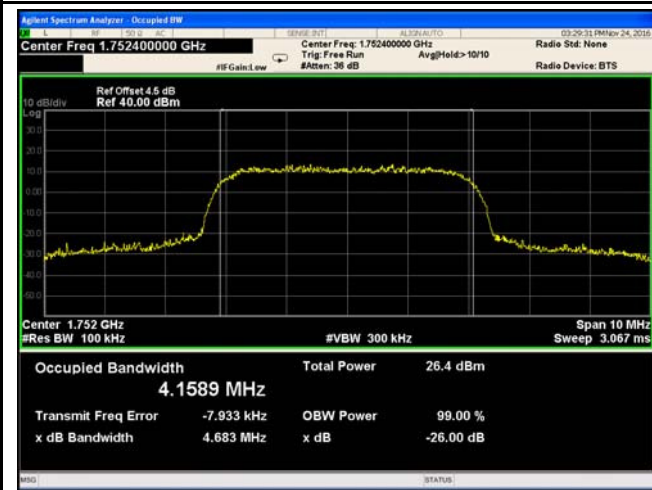

Band IV BW - High CH 1907.6MHz

HSUPA:

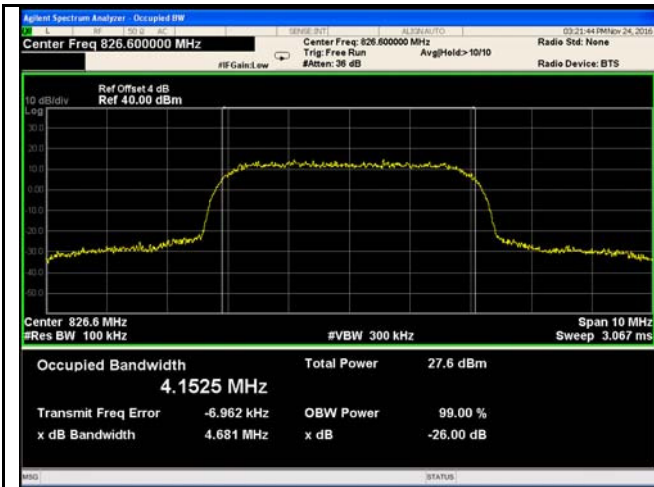

Band V BW - Low CH 826.6 MHz

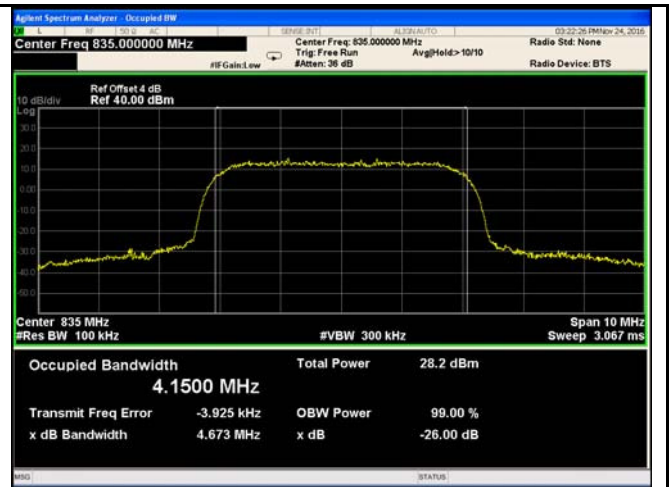

Band V BW - Mid CH 835.0 MHz

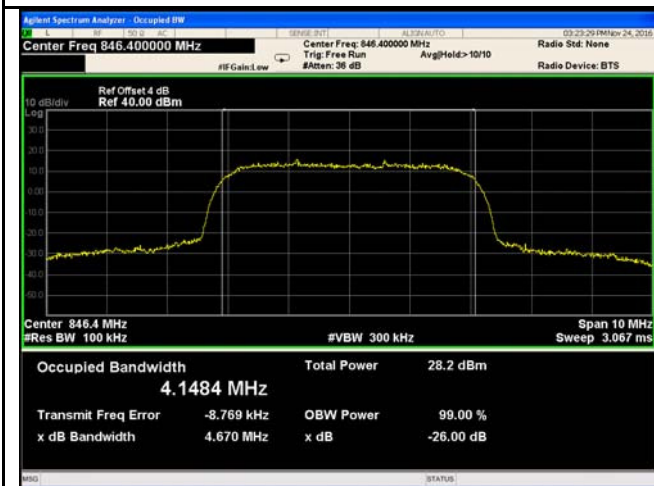

Band V BW - High CH 846.4 MHz

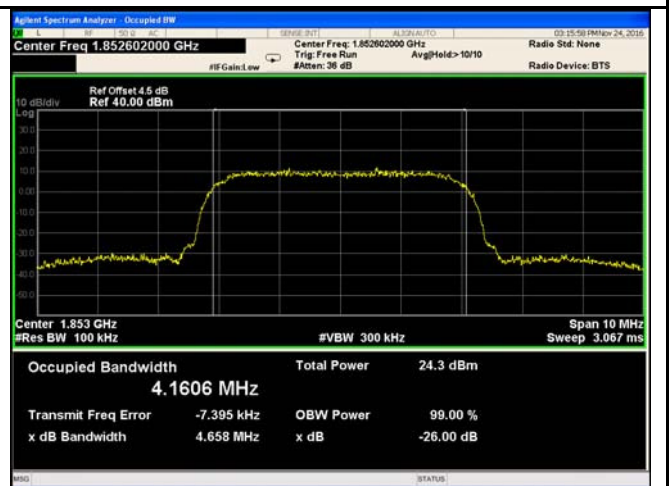

Band II BW - Low CH 1852.4MHz

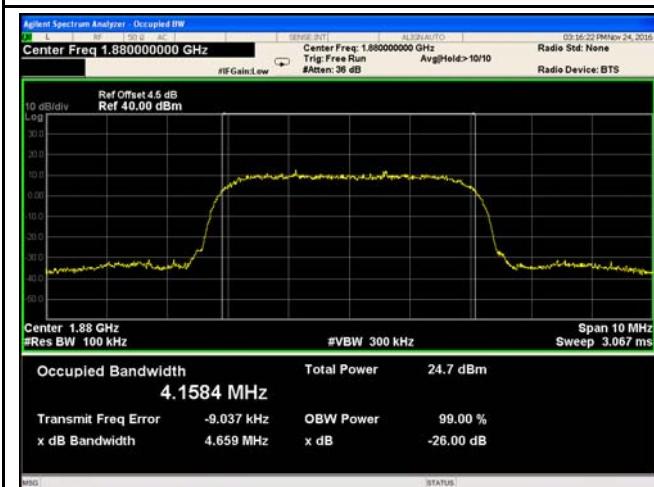

Band II BW - Mid CH 1880MHz

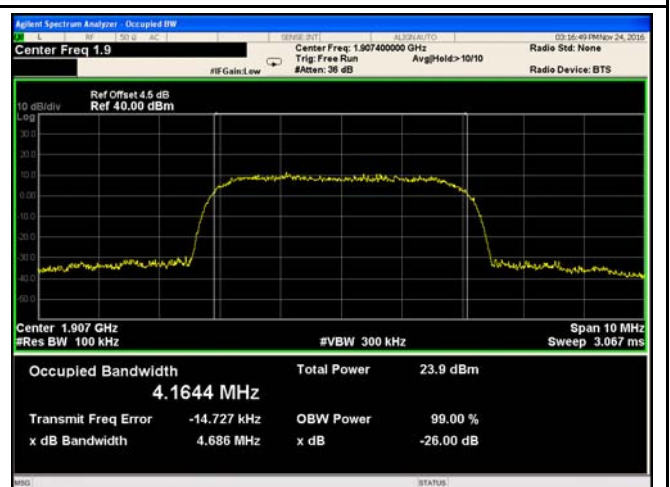

Band II BW - High CH 1907.6MHz

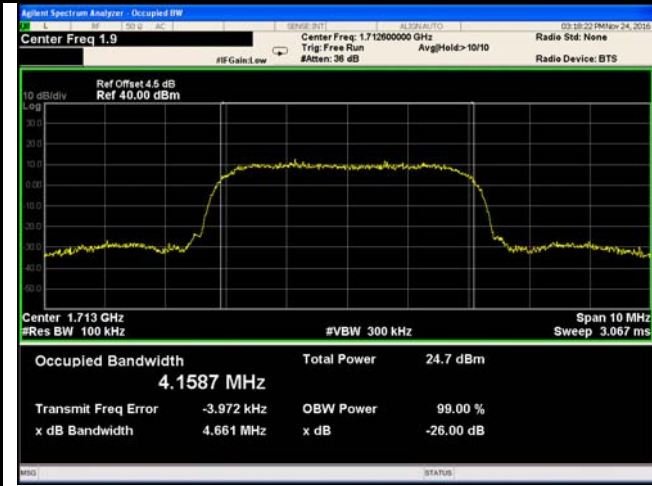

Band IV BW - Low CH 1713MHz

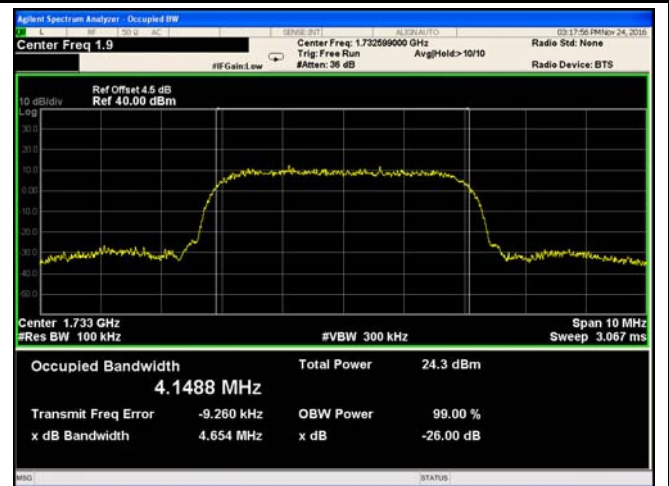

Band IVBW - Mid CH 1733MHz

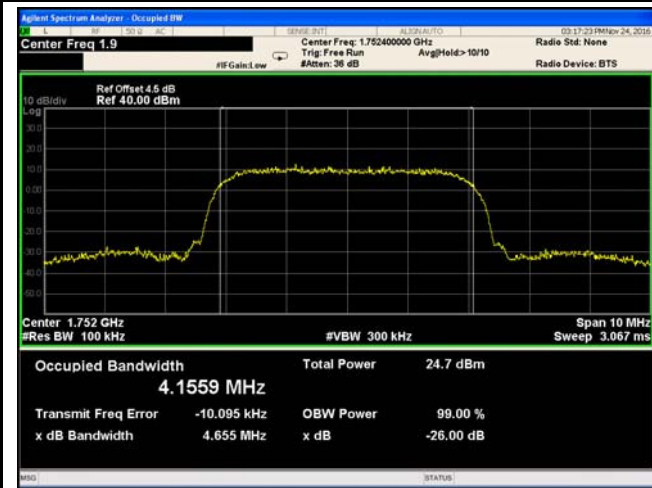

Band IV BW - High CH 1752MHz

HSDPA:

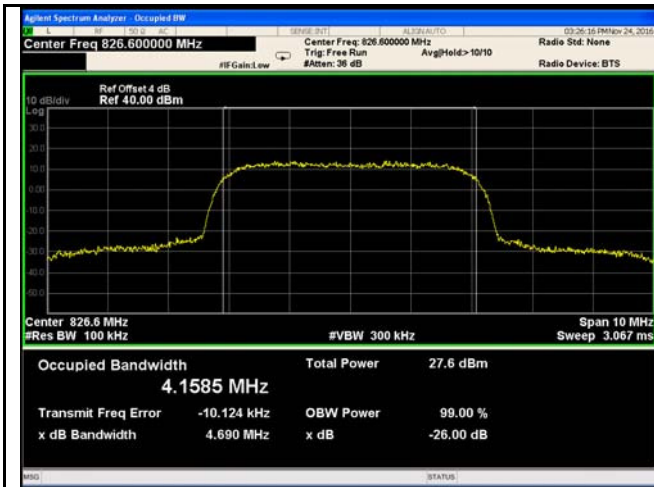

Band V BW - Low CH 826.6 MHz

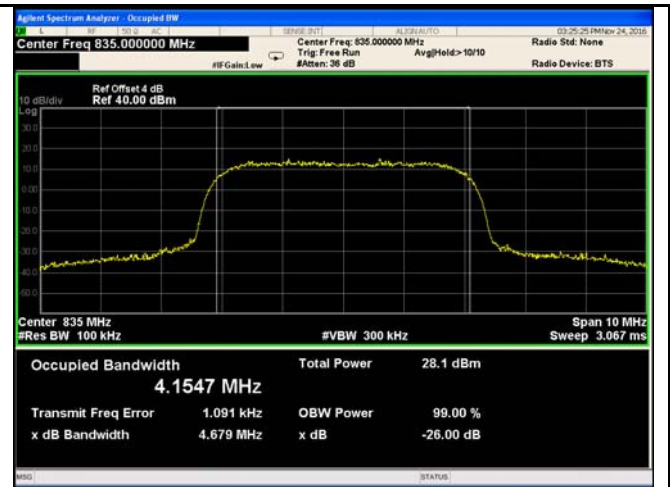

Band V BW - Mid CH 835.0 MHz

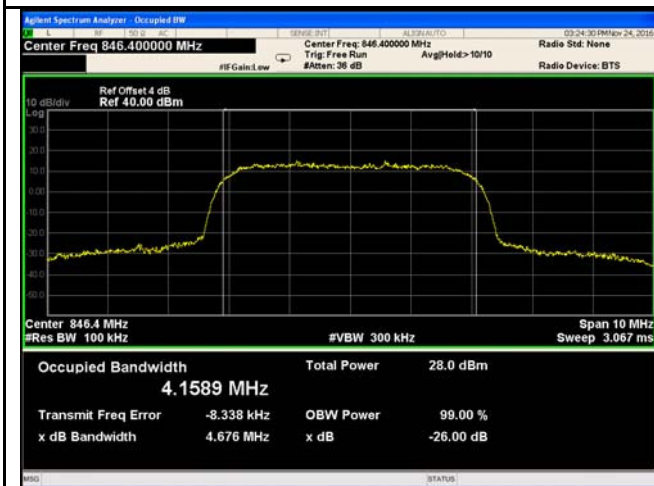

Band V BW - High CH 846.4 MHz

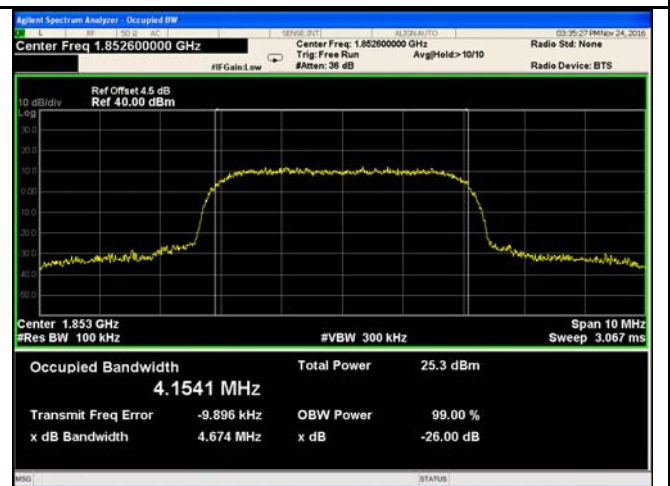

Band II BW - Low CH 1852.4MHz

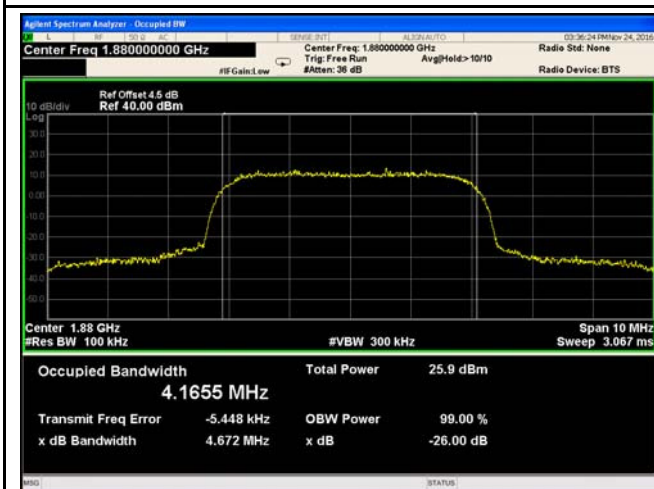

Band II BW - Mid CH 1880MHz

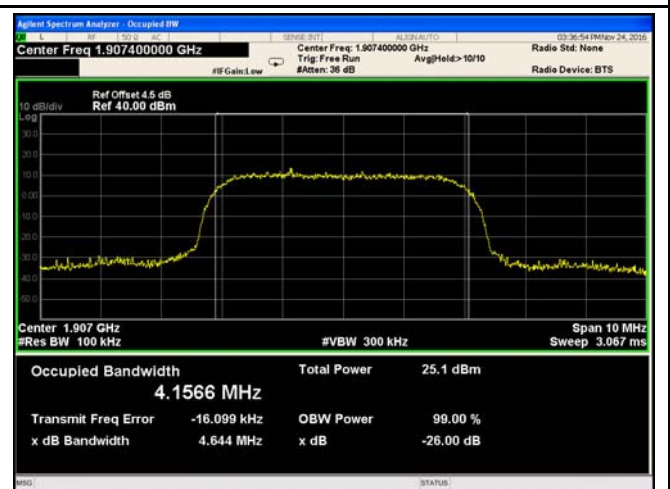

Band II BW - High CH 1907.6MHz

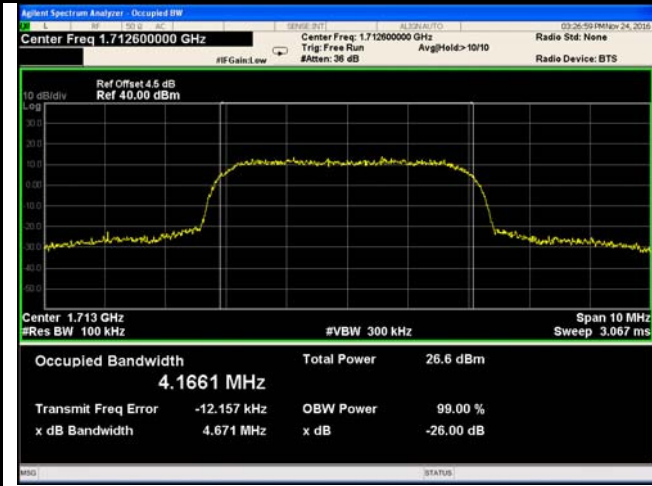

Band IV BW - Low CH 1713MHz

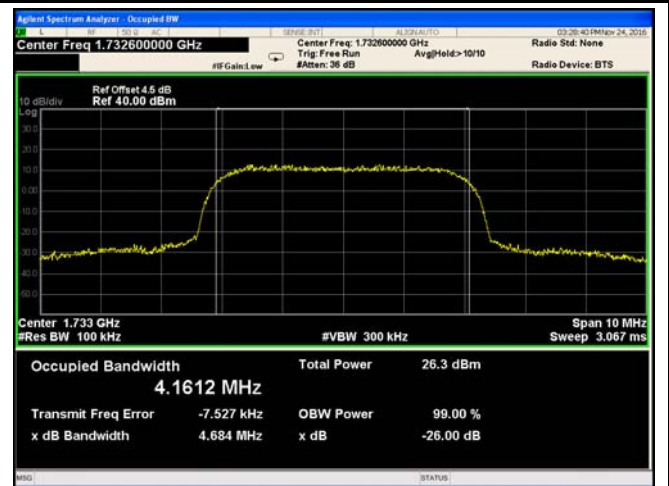

Band IVBW - Mid CH 1733MHz

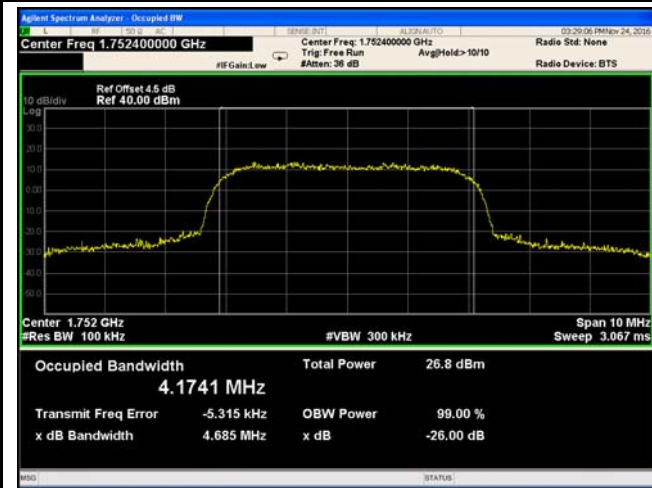

Band IV BW - High CH 1752MHz

6.5 Spurious Emissions at Antenna Terminals

Temperature	25°C
Relative Humidity	57%
Atmospheric Pressure	1024mbar
Test date :	November 24, 2016
Tested By :	Loren Luo

Requirement(s):

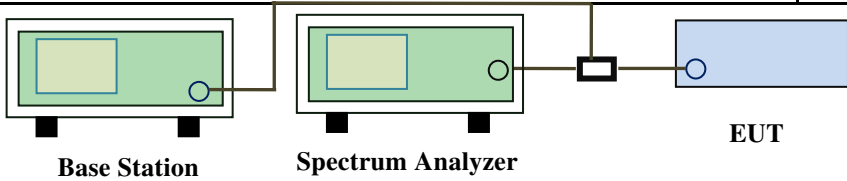
Spec	Item	Requirement	Applicable
§2.1051, §22.917(a)& §24.238(a) § 27.53(h)	a)	The power of any emission outside of the authorized operating frequency ranges must be lower than the transmitter power (P) by a factor of at least $43 + 10 \log(P)$ dB	<input checked="" type="checkbox"/>
Test Setup	 <p>The diagram illustrates the test setup. On the left is a green box labeled 'Base Station'. In the middle is a green box labeled 'Spectrum Analyzer'. On the right is a blue box labeled 'EUT'. A power divider is connected between the Spectrum Analyzer and the EUT. The Base Station is connected to the Spectrum Analyzer.</p>		
Test Procedure	<ul style="list-style-type: none"> - The EUT was connected to Spectrum Analyzer and Base Station via power divider. - The Band Edges of low and high channels for the highest RF powers were measured. - Setting RBW as roughly BW/100. 		
Remark			
Result	<input checked="" type="checkbox"/> Pass <input type="checkbox"/> Fail		

Test Data Yes N/A
 Test Plot Yes (See below) N/A

Test Plots

GSM Voice:

Cellular Band (Part 22H) result

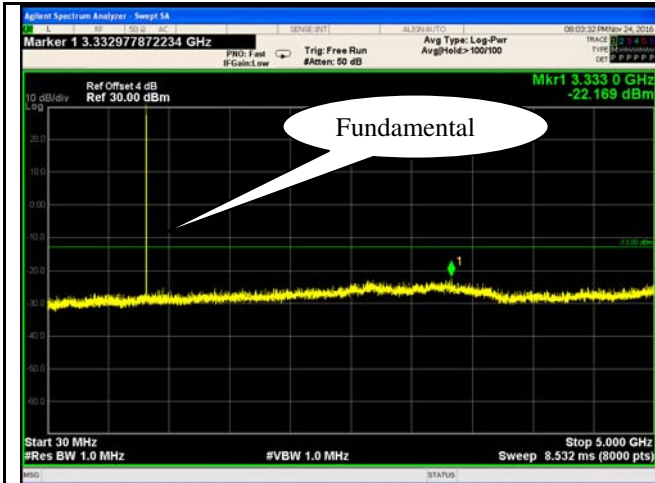

GSM 850 - Low Channel-1

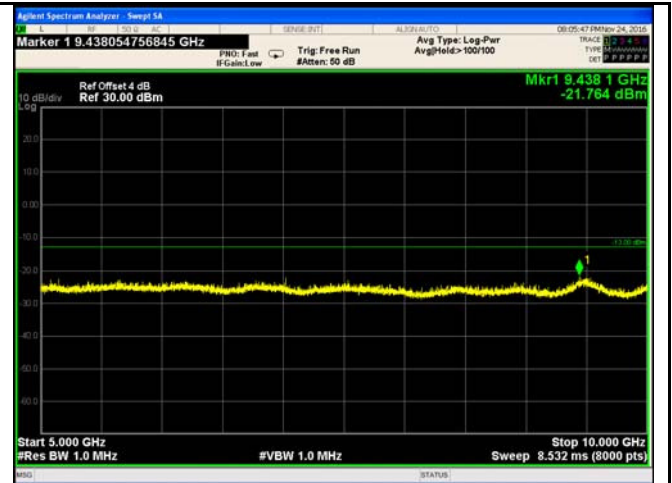

GSM 850 - Low Channel-2

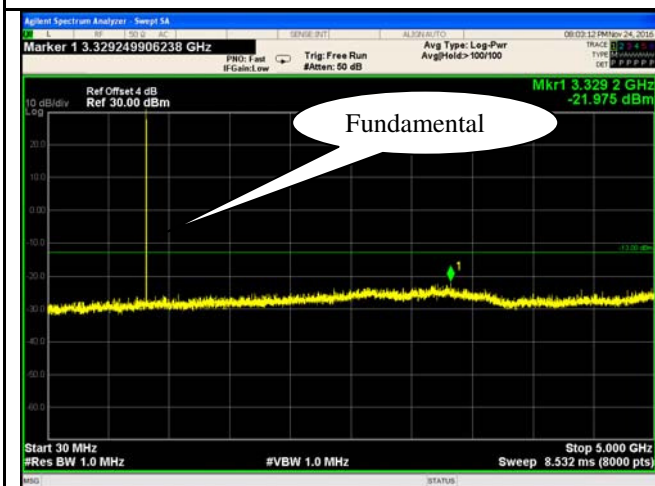

GSM 850 Middle Channel-1

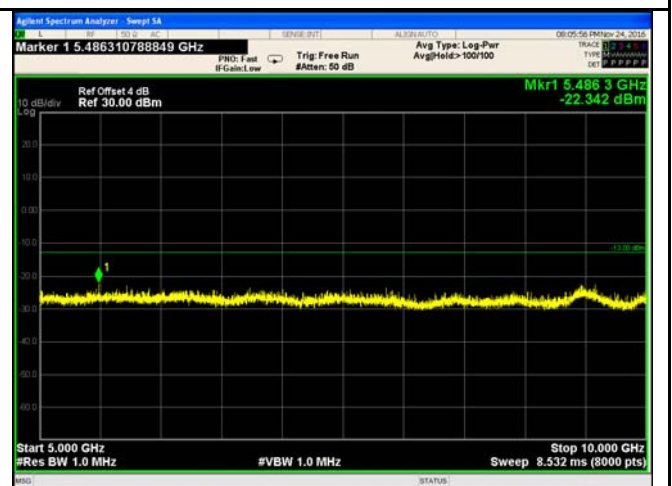

GSM 850 Middle Channel-2

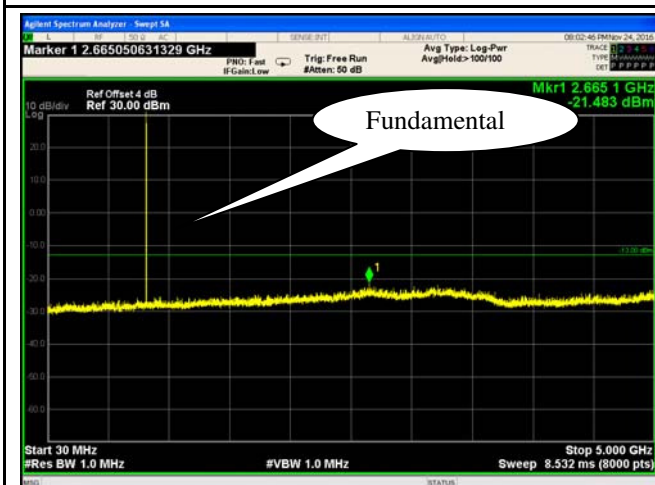

GSM 850 - High Channel-1

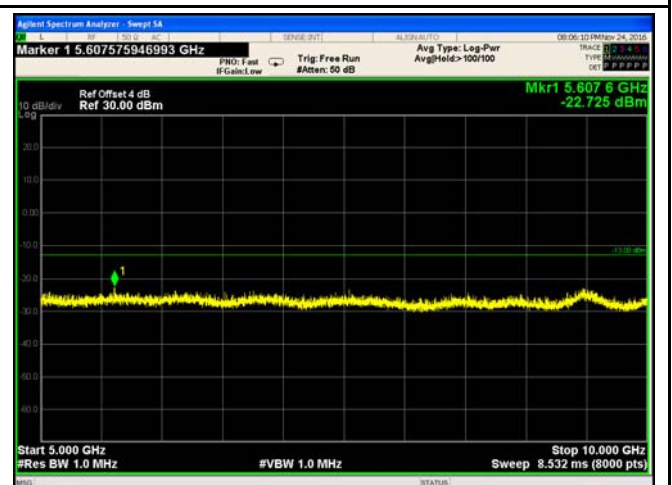

GSM 850 - High Channel-2

PCS Band (Part24E) result

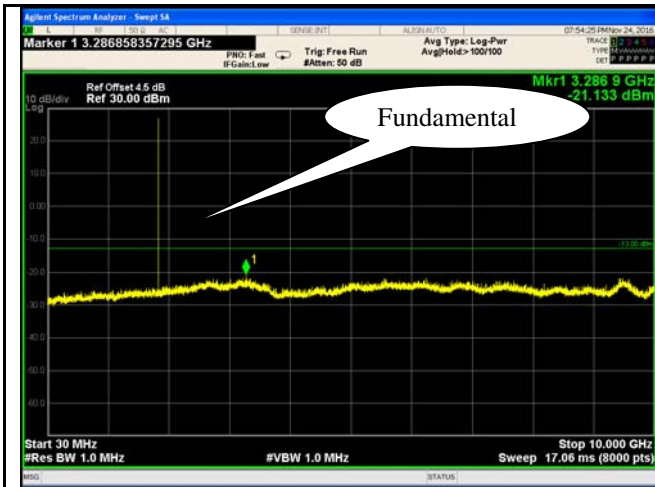

PCS1900 - Low Channel-1

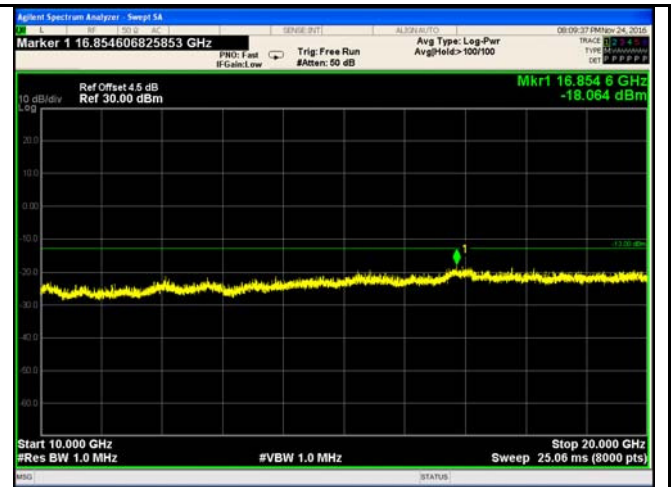

PCS 1900 - Low Channel-2

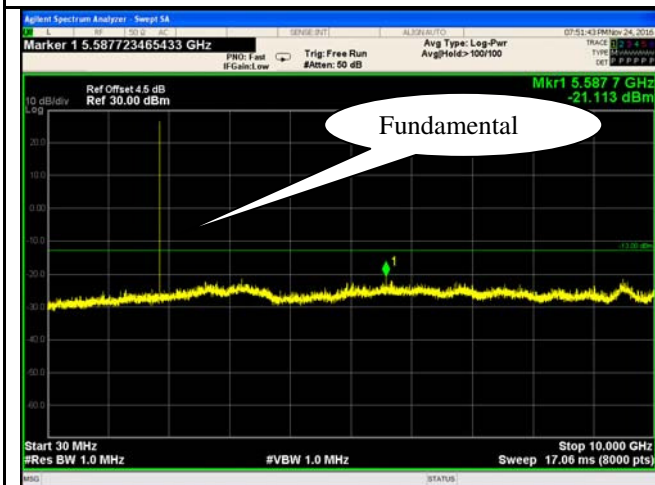

PCS1900 - Middle Channel-1

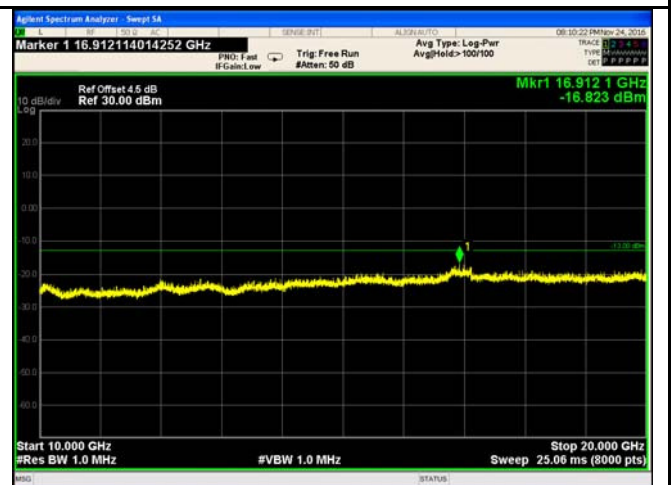

PCS 1900 - Middle Channel-2

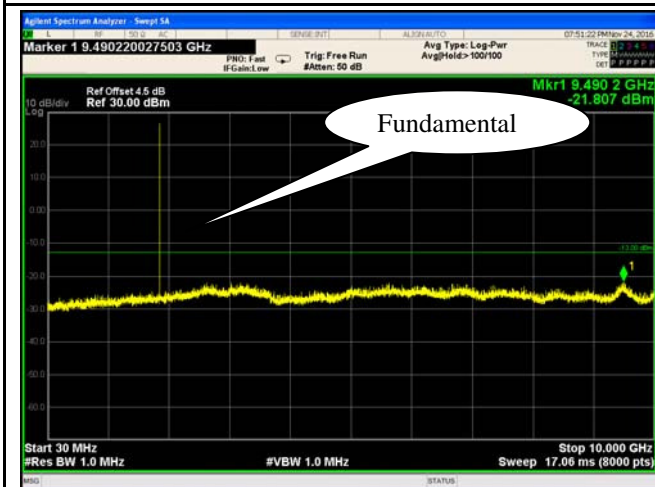

PCS1900 - High Channel-1

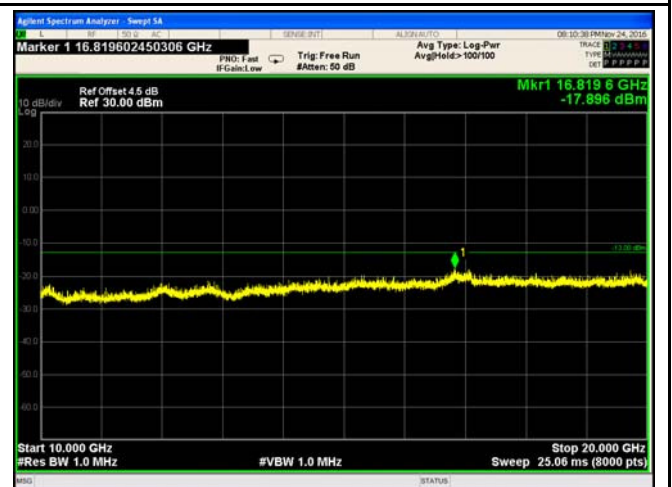

PCS 1900 - High Channel-2

GPRS:

Cellular Band (Part 22H) result

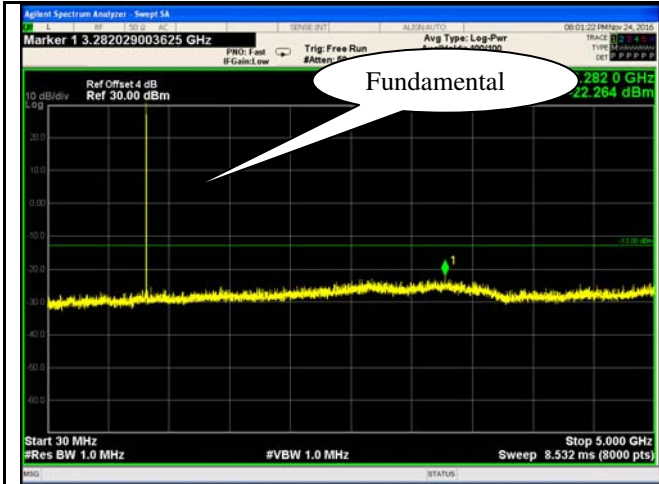

GSM 850 - Low Channel-1

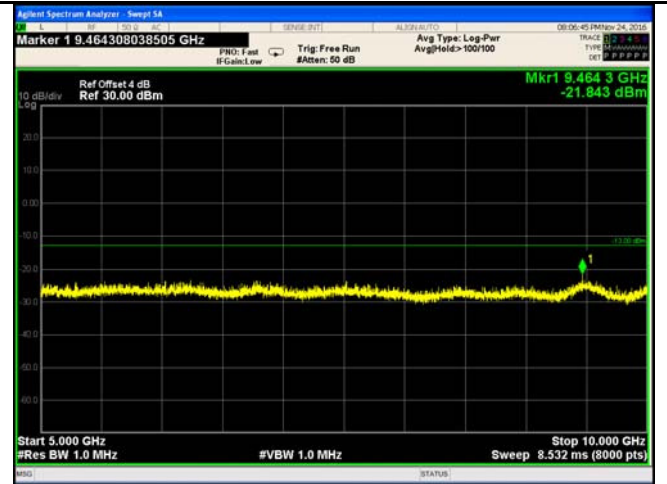

GSM 850 - Low Channel-2

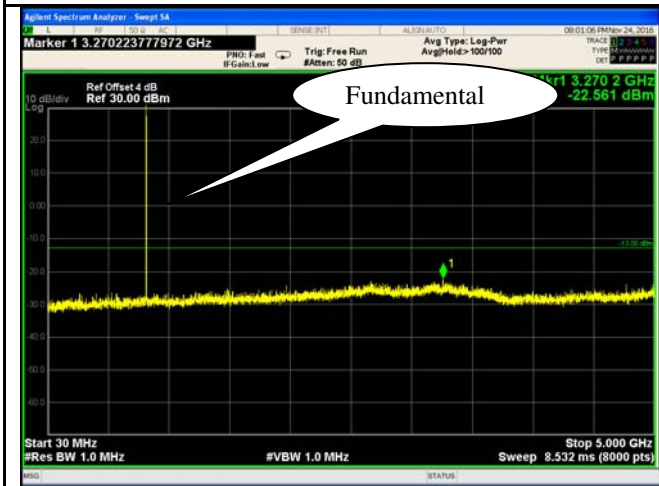

GSM 850 Middle Channel-1

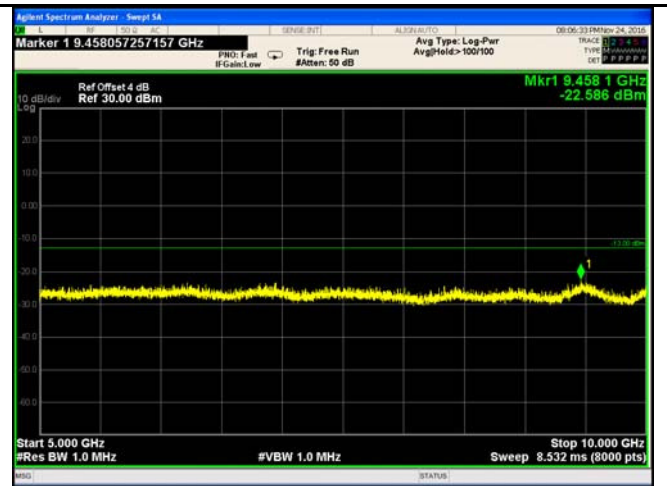

GSM 850 Middle Channel-2

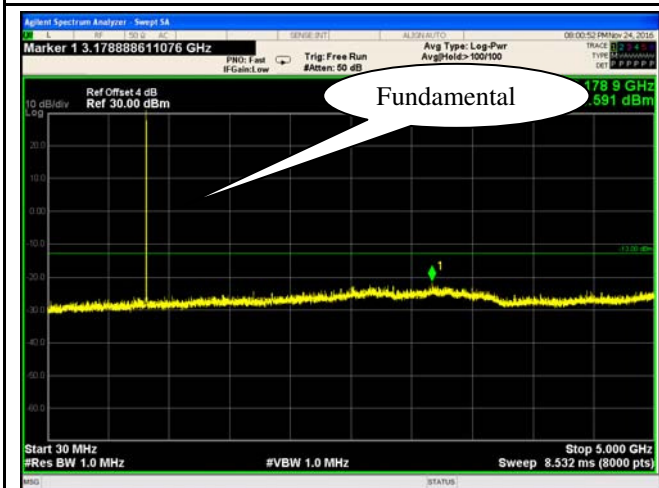

GSM 850 - High Channel-1

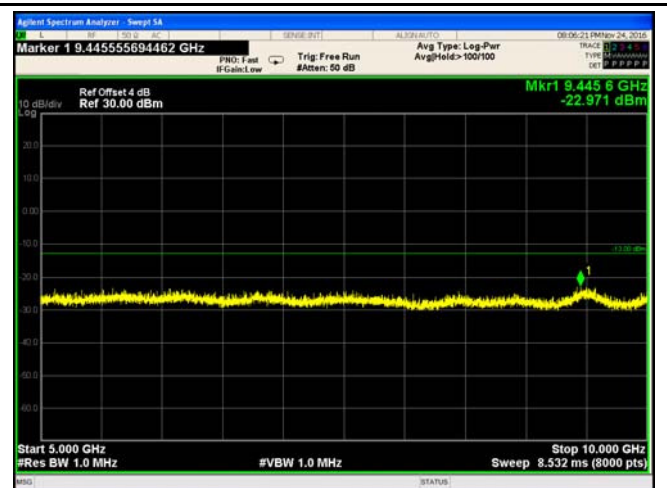

GSM 850 - High Channel-2

PCS Band (Part24E) result

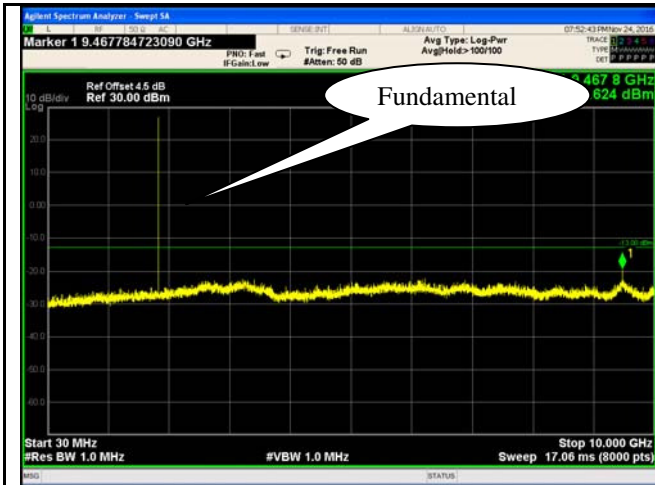

PCS1900 - Low Channel-1

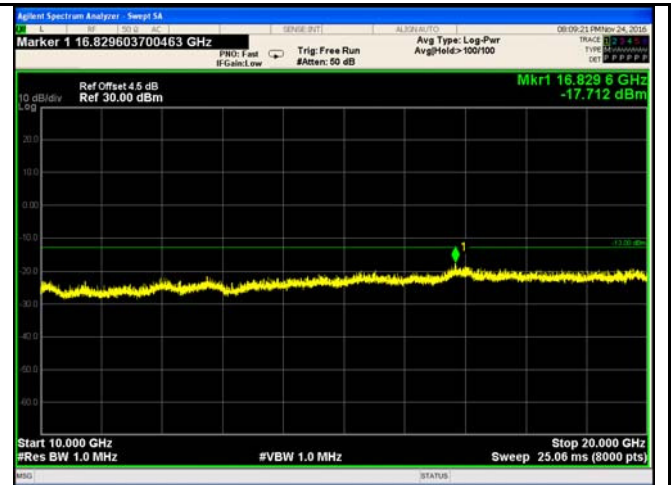

PCS 1900 - Low Channel-2

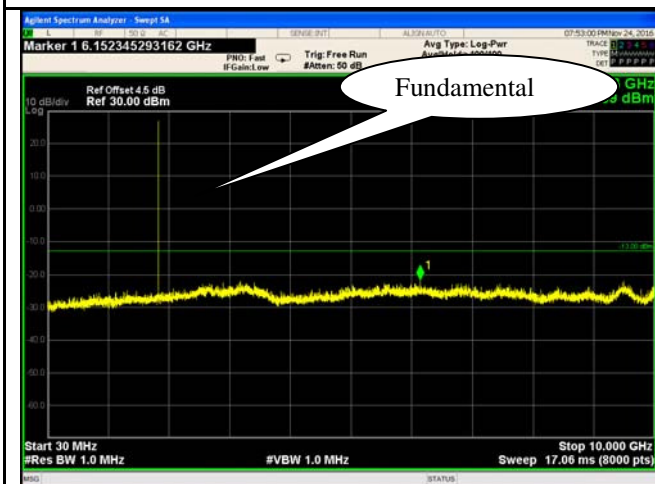

PCS1900 - Middle Channel-1

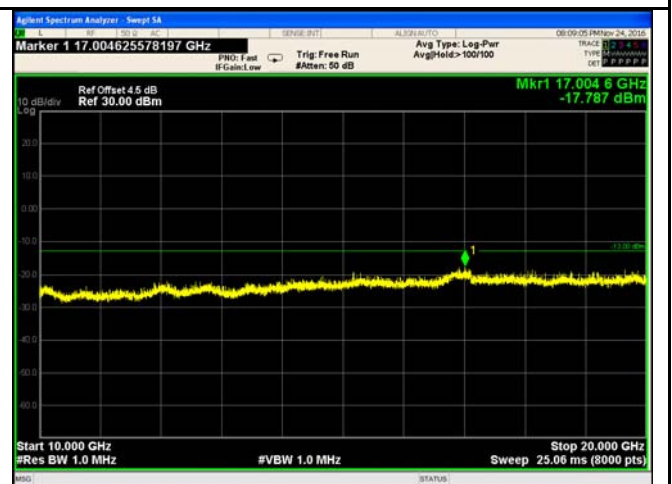

PCS 1900 - Middle Channel-2

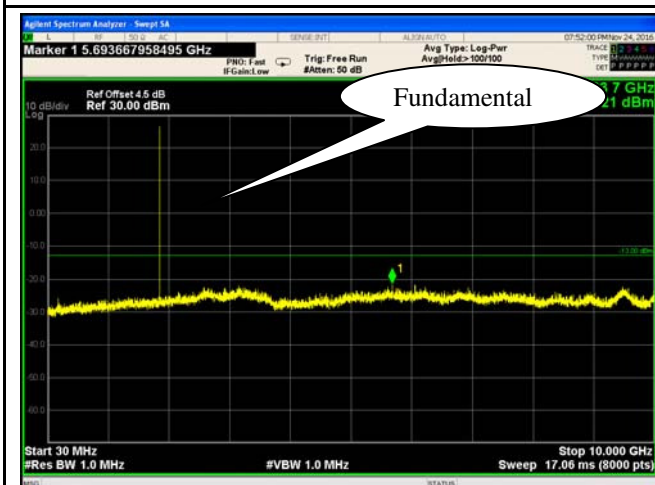

PCS1900 - High Channel-1

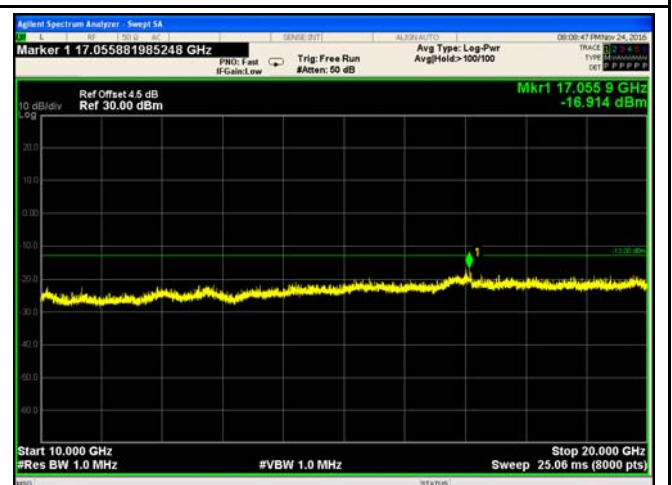

PCS 1900 - High Channel-2

**EGPRS (MCS 1):
Cellular Band (Part 22H) result**

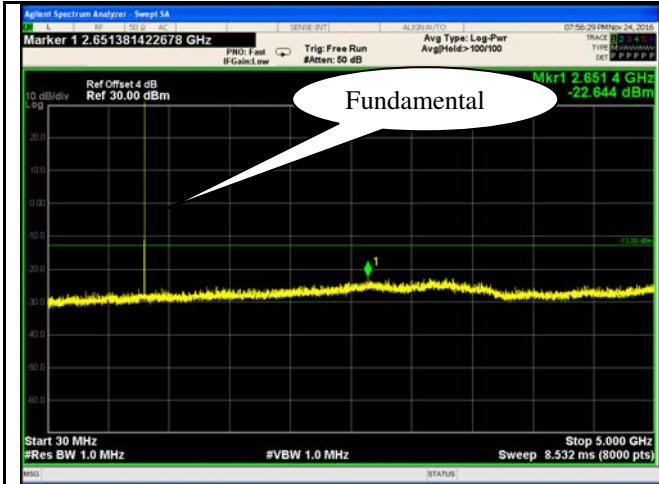

GSM 850 - Low Channel-1

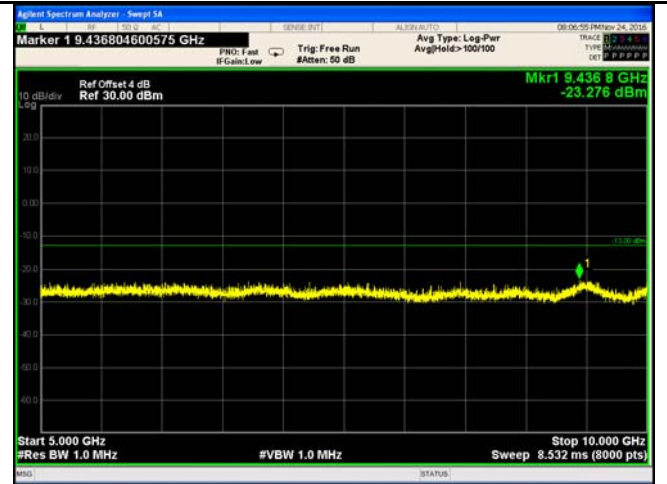

GSM 850 - Low Channel-2

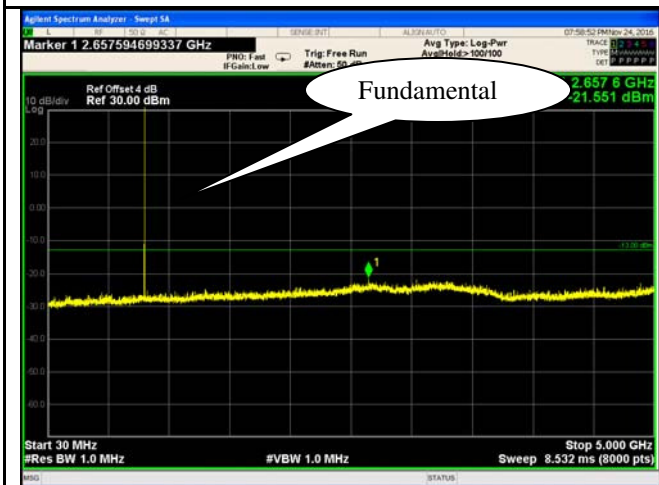

GSM 850 Middle Channel-1

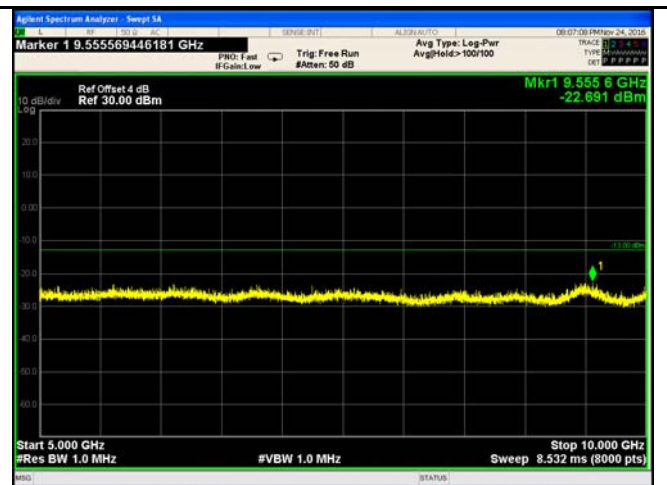

GSM 850 Middle Channel-2

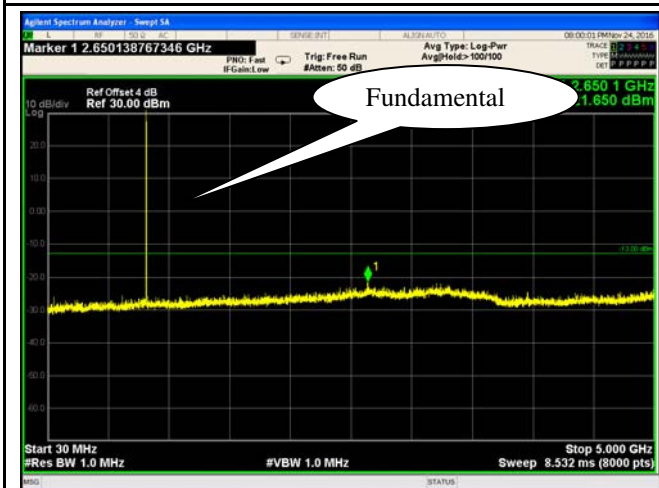

GSM 850 - High Channel-1

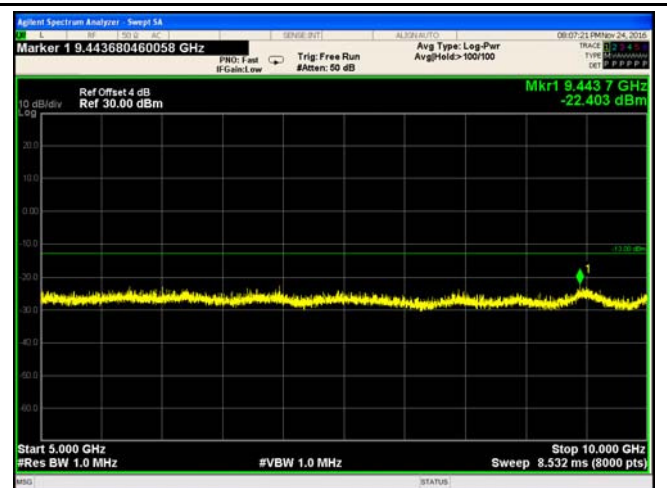

GSM 850 - High Channel-2

PCS Band (Part24E) result

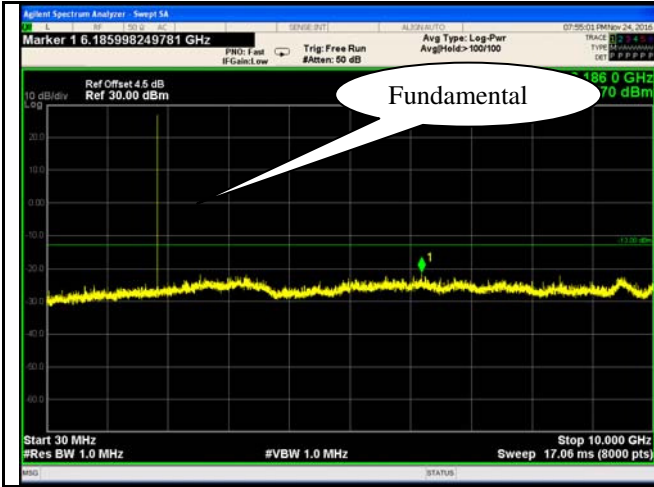

PCS1900 - Low Channel-1



PCS 1900 - Low Channel-2

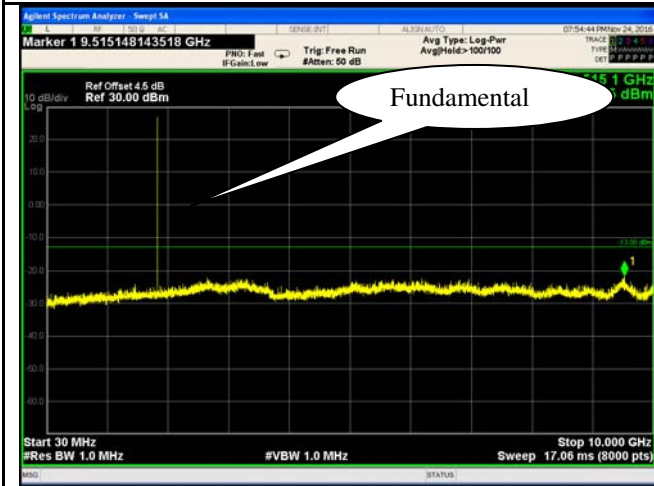

PCS1900 - Middle Channel-1



PCS 1900 - Middle Channel-2

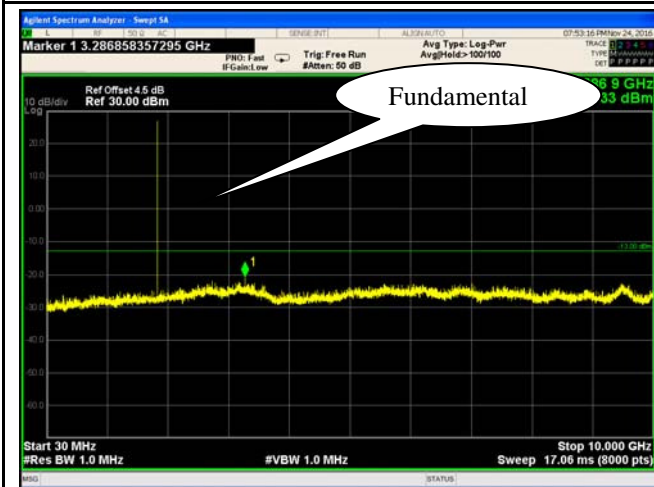

PCS1900 - High Channel-1

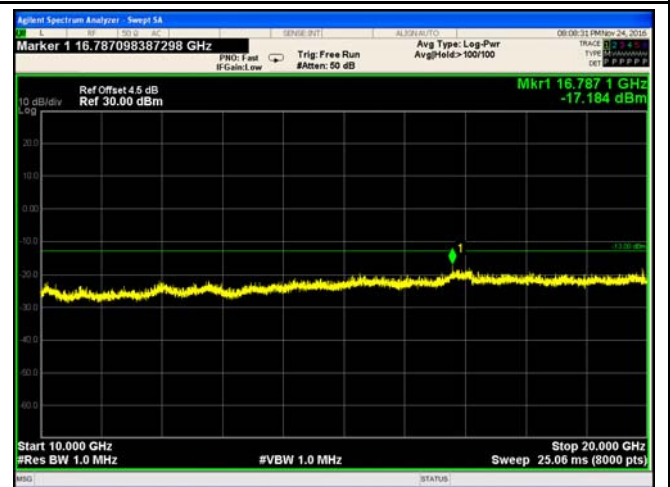

PCS 1900 - High Channel-2

RMC

UMTS-FDD Band V (Part 22H)

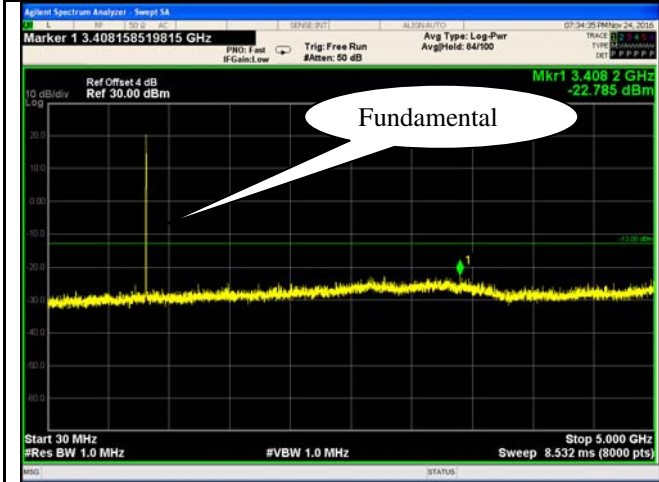

Band V - Low Channel-1

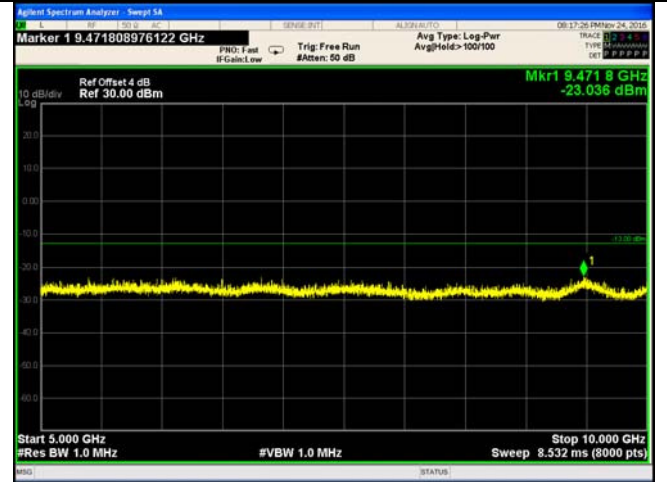

Band V - Low Channel-2

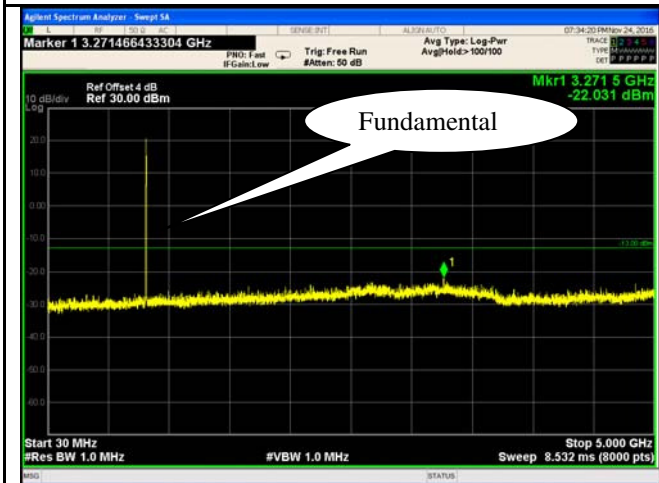

Band V - Middle Channel-1

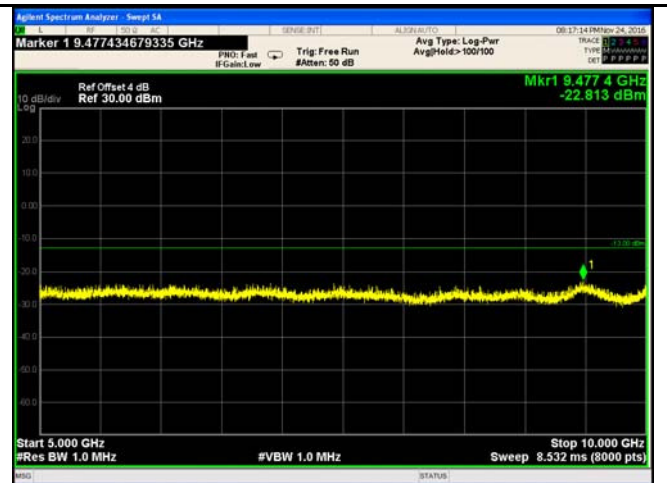

Band V - Middle Channel-2

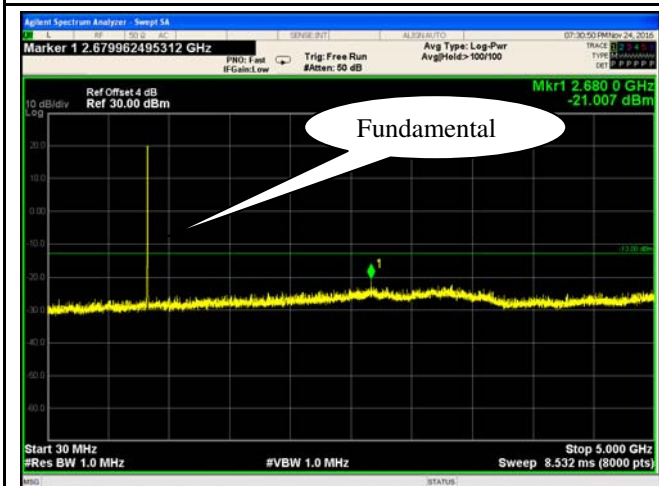

Band V - High Channel-1

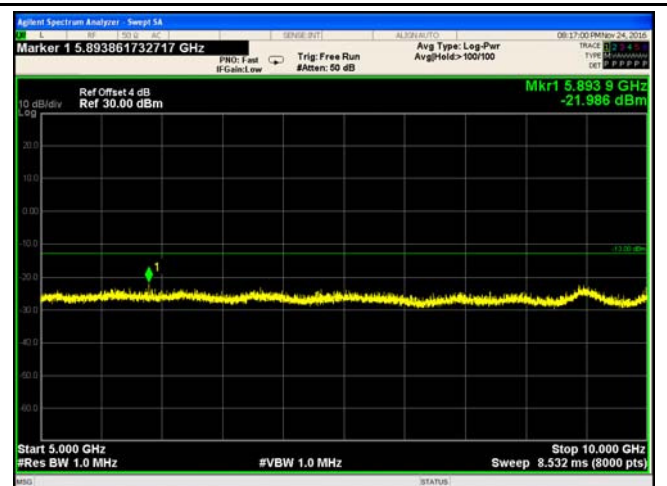

Band V - High Channel-2

UMTS-FDD Band II (Part 24E)

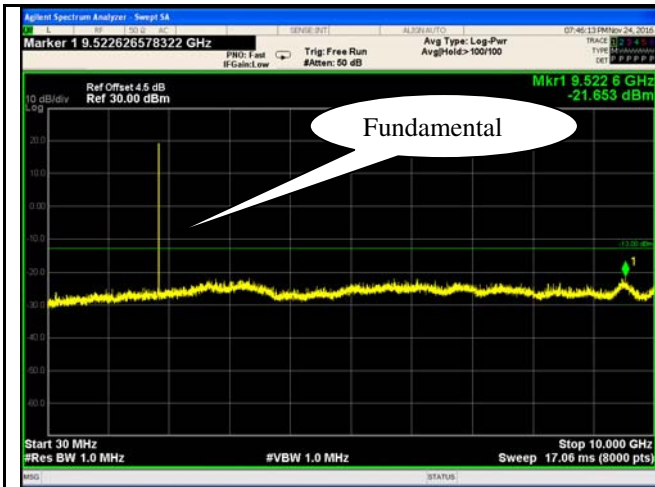

Band II - Low Channel-1

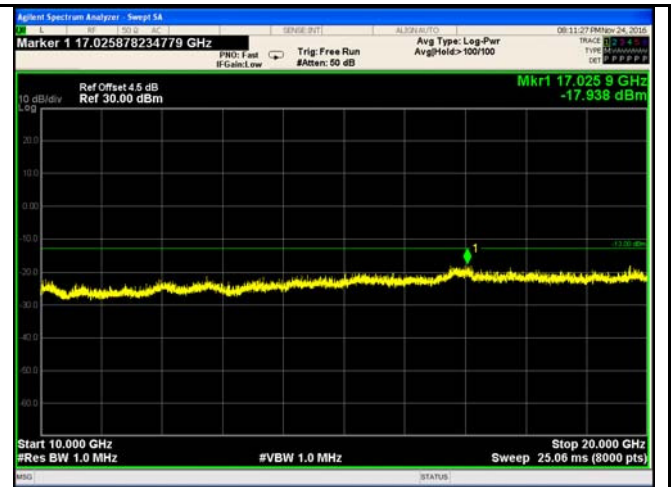

Band II - Low Channel-2

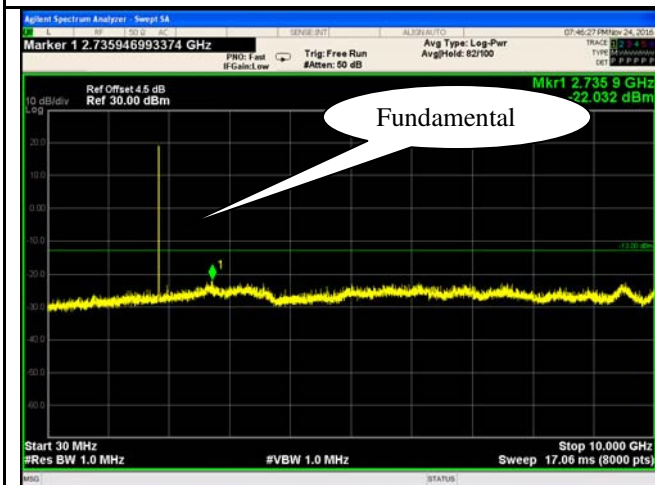

Band II - Middle Channel-1

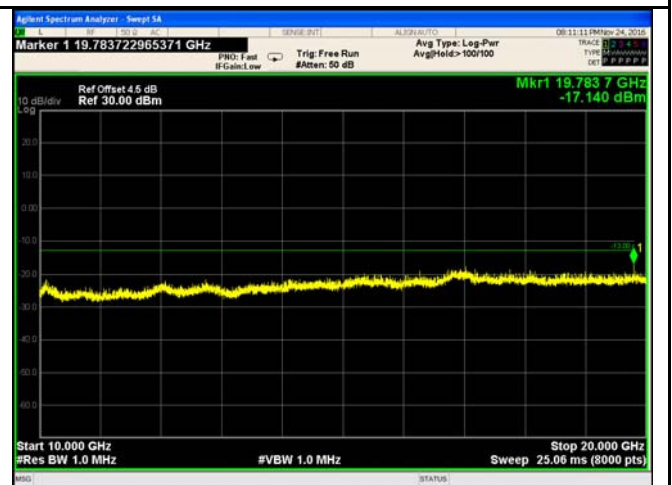

Band II - Middle Channel-2

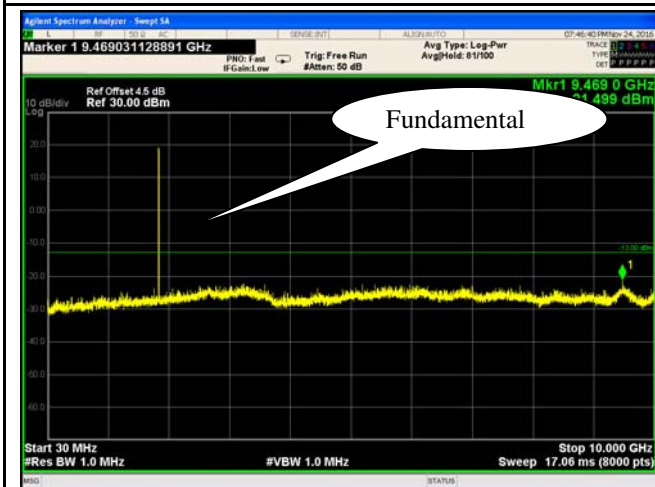

Band II - High Channel-1

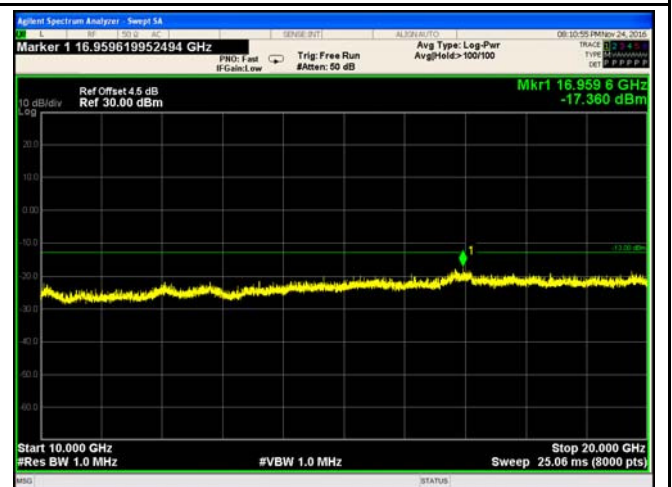

Band II - High Channel-2

UMTS-FDD Band IV (Part 27)

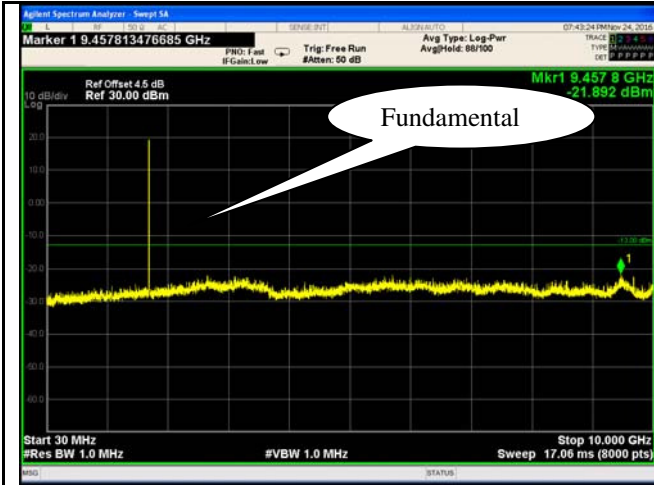

Band IV - Low Channel-1

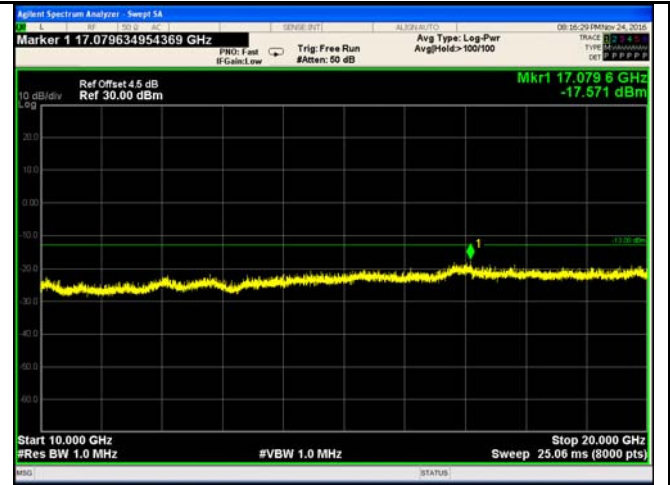

Band IV - Low Channel-2

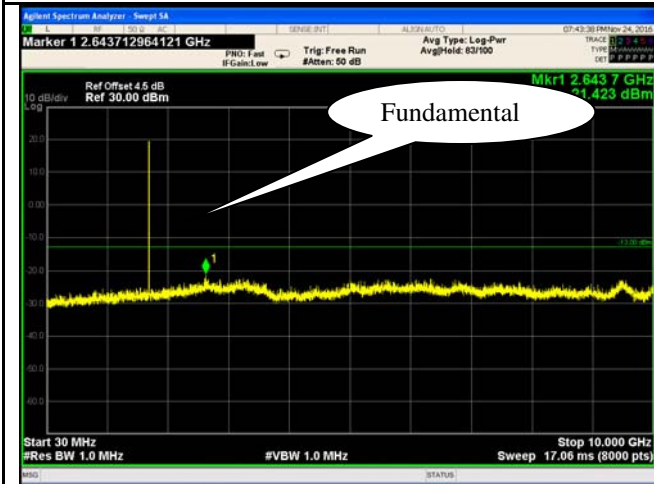

Band IV - Middle Channel-1



Band IV - Middle Channel-2

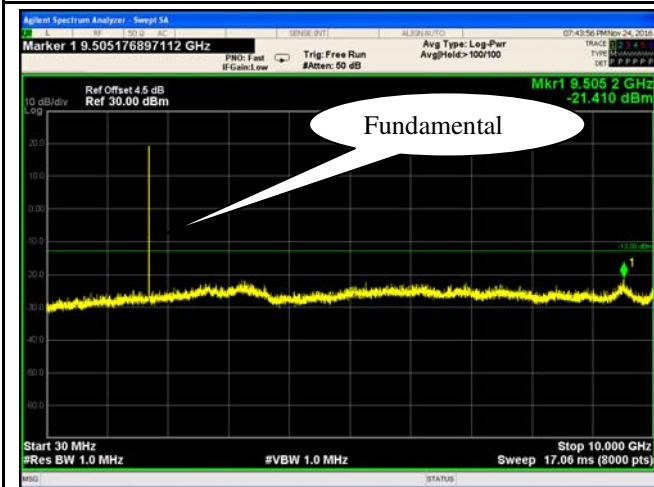

Band IV - High Channel-1

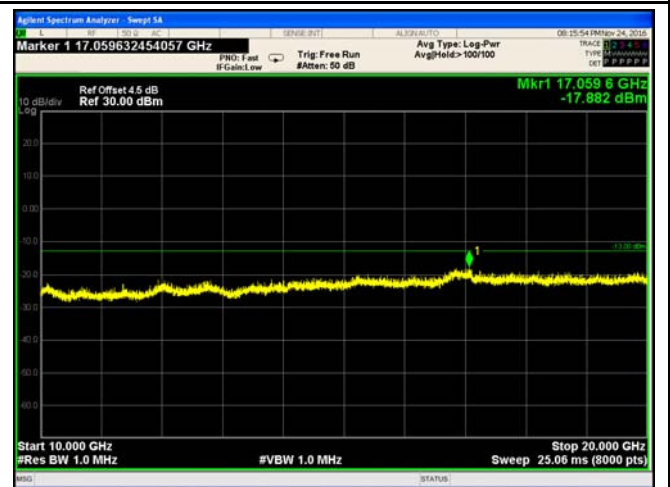

Band IV - High Channel-2

HSUPA:

UMTS-FDD Band V (Part 22H)

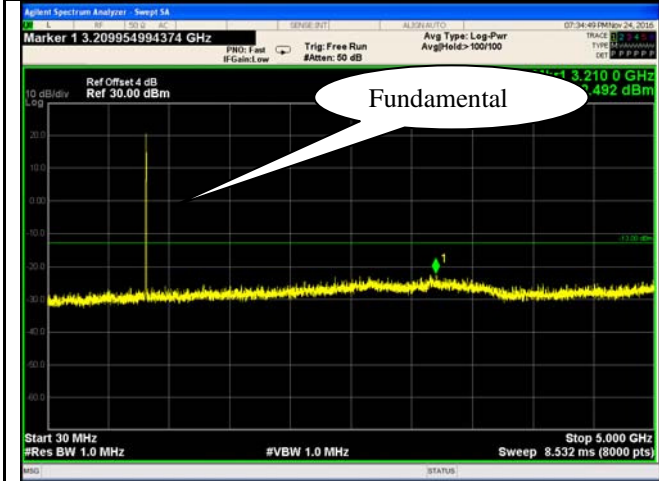

Band V - Low Channel-1

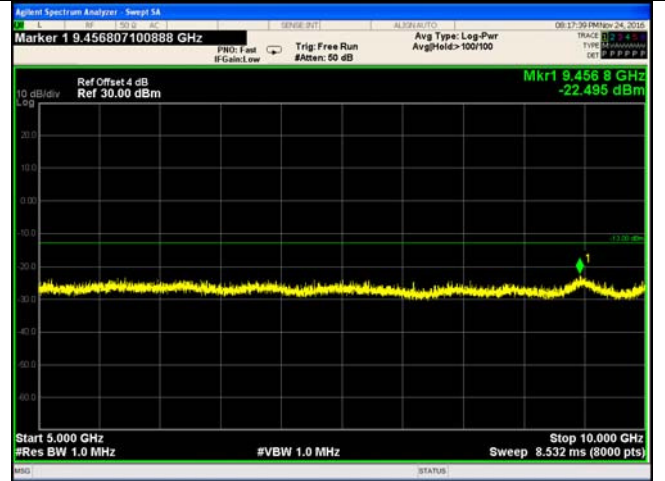

Band V - Low Channel-2

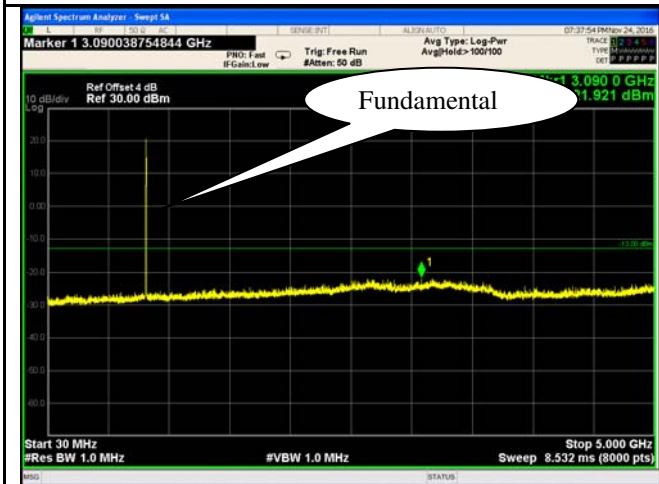

Band V - Middle Channel-1

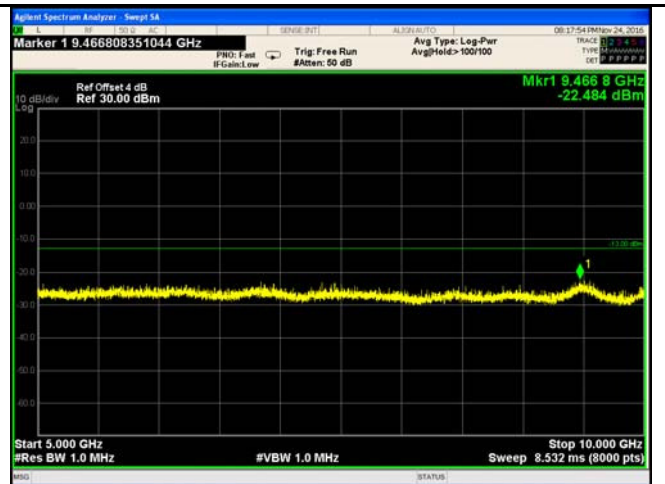

Band V - Middle Channel-2

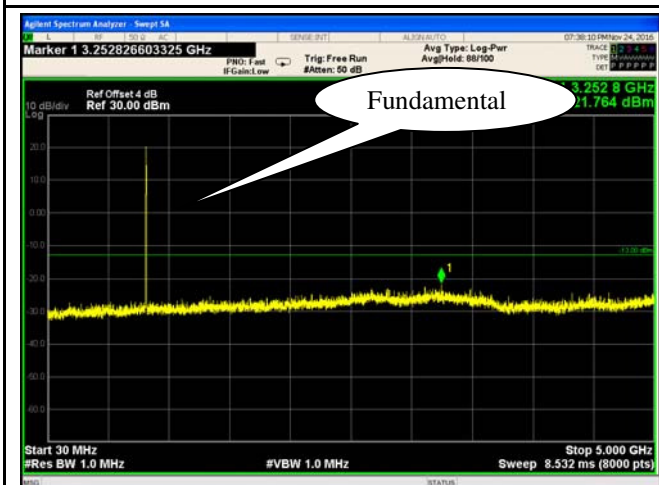

Band V - High Channel-1

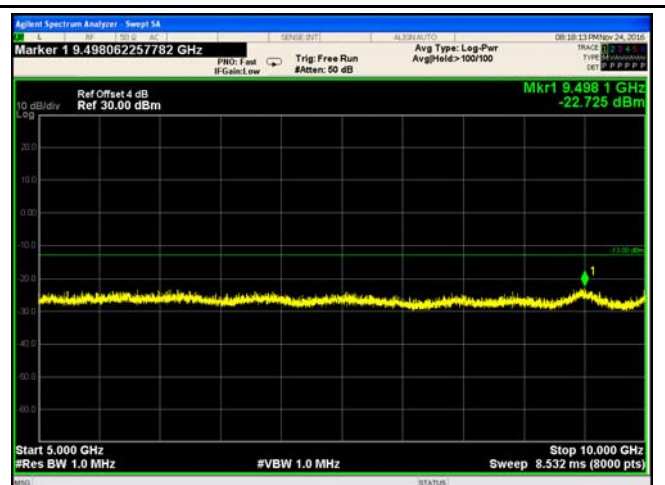

Band V - High Channel-2

UMTS-FDD Band II (Part 24E)

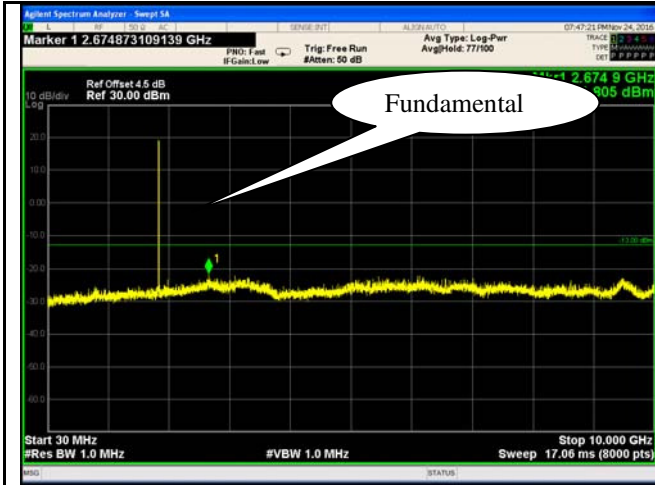

Band II - Low Channel-1



Band II - Low Channel-2

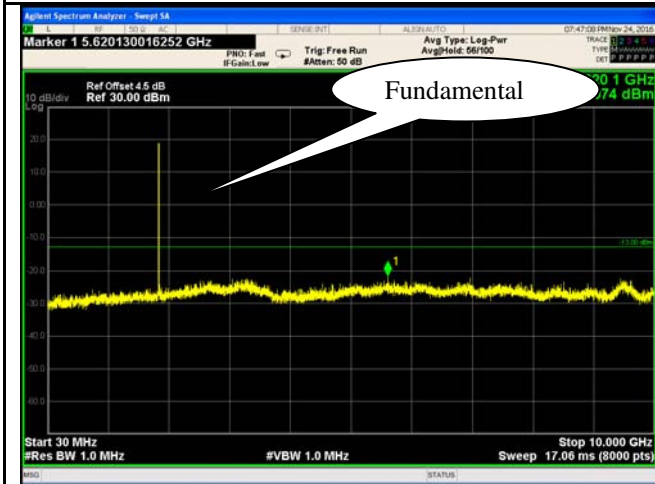

Band II - Middle Channel-1

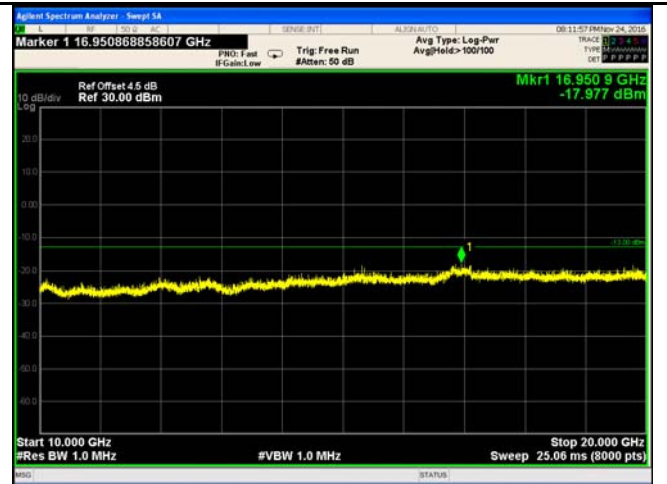

Band II - Middle Channel-2

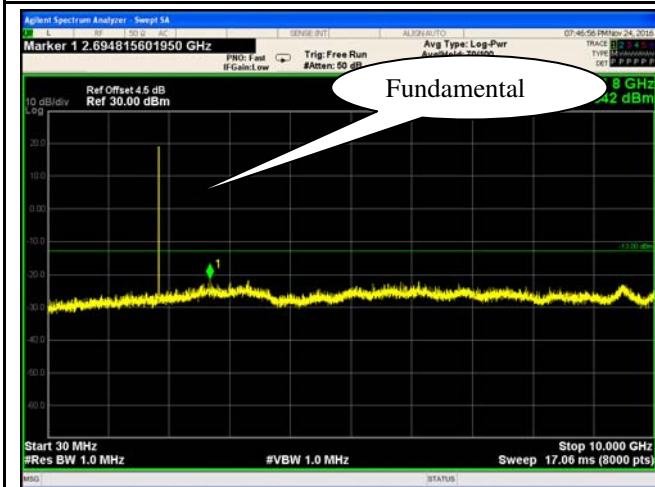

Band II - High Channel-1

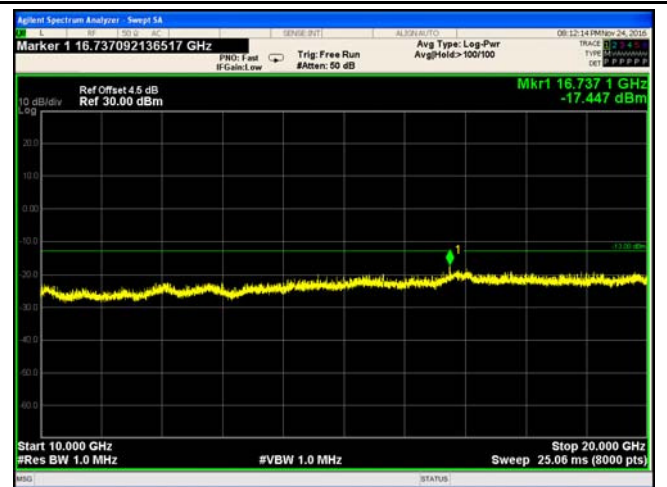

Band II - High Channel-2

UMTS-FDD Band IV (Part 27)

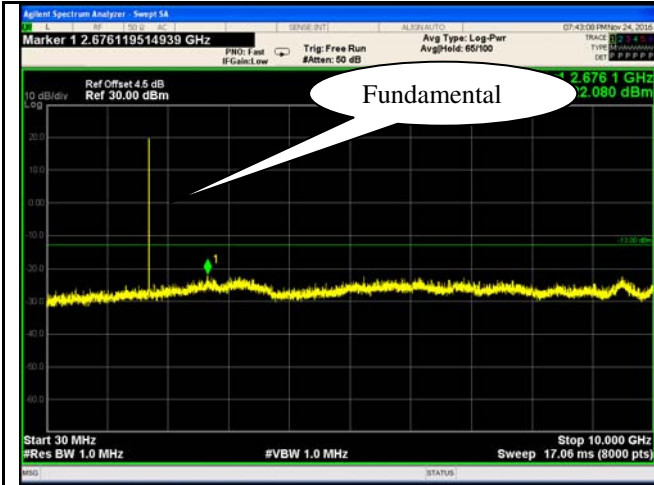

Band IV - Low Channel-1



Band IV - Low Channel-2

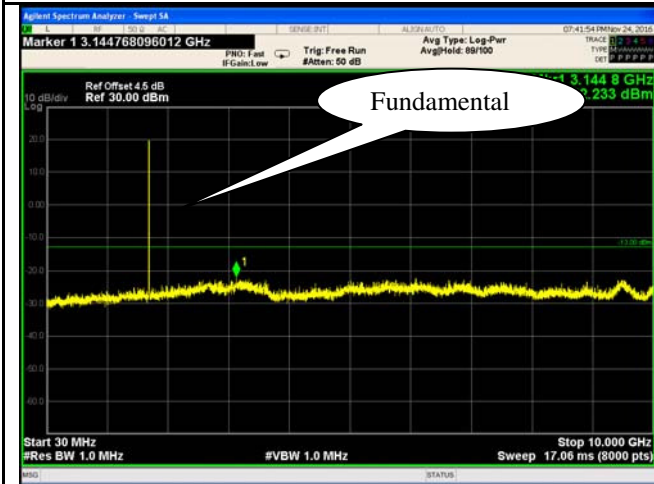

Band IV - Middle Channel-1

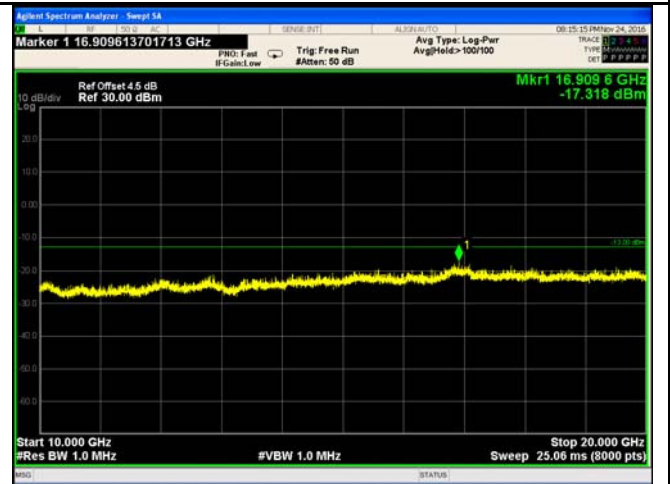

Band IV - Middle Channel-2

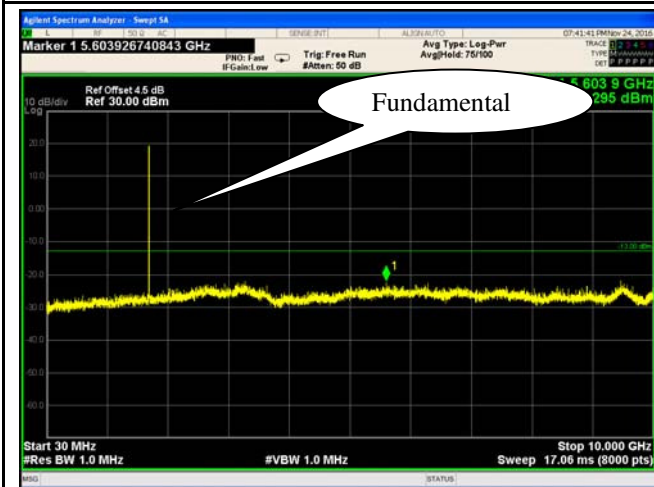

Band IV - High Channel-1

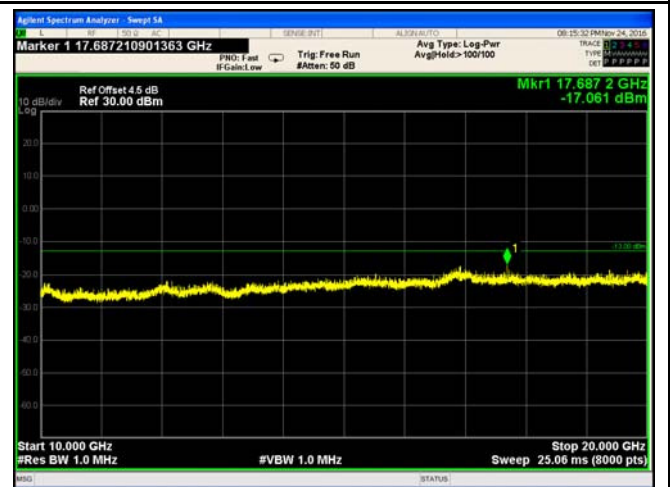

Band IV - High Channel-2

HSDPA:

UMTS-FDD Band V (Part 22H)

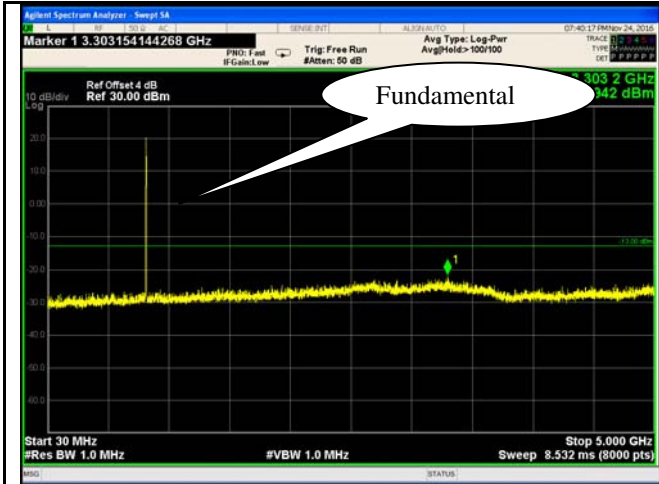

Band V - Low Channel-1



Band V - Low Channel-2

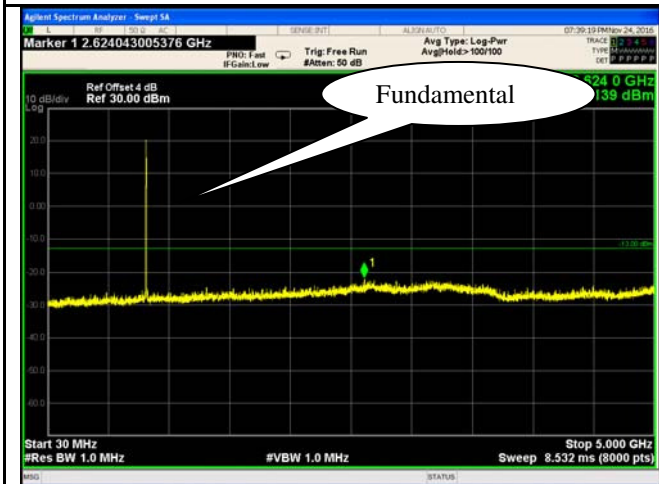

Band V - Middle Channel-1

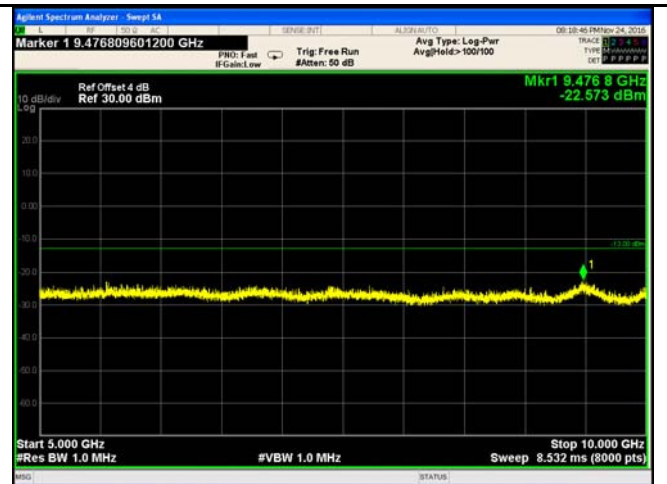

Band V - Middle Channel-2

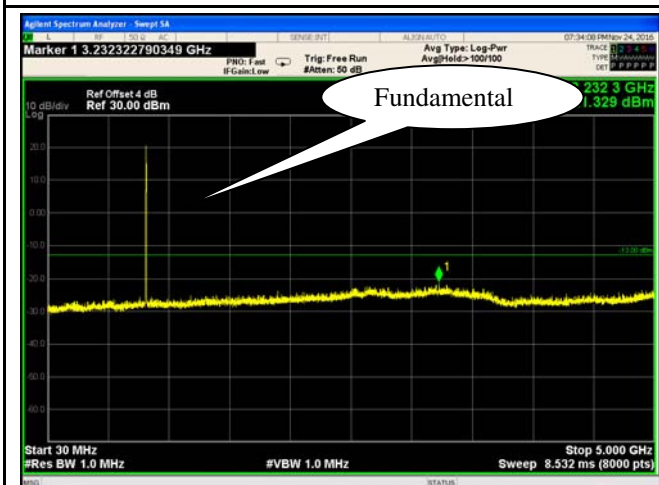

Band V - High Channel-1

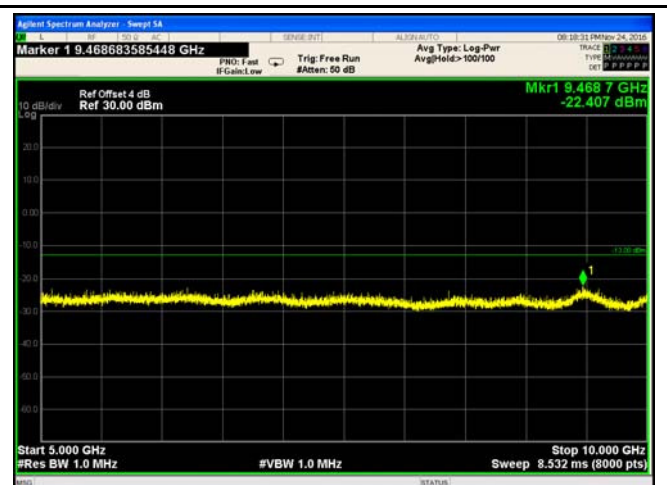

Band V - High Channel-2

UMTS-FDD Band II (Part 24E)

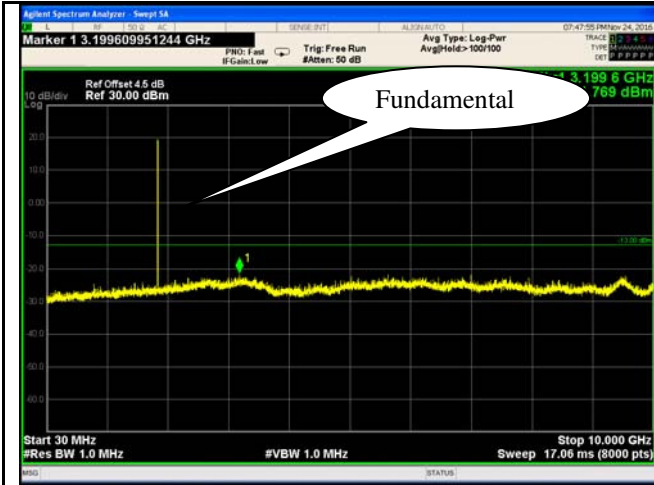

Band II - Low Channel-1

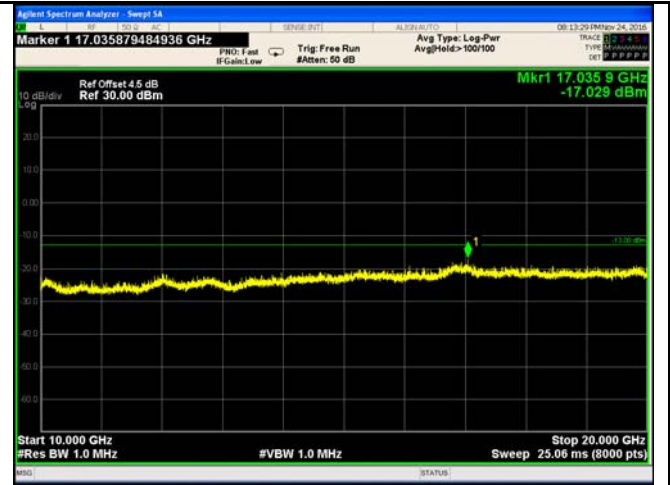

Band II - Low Channel-2

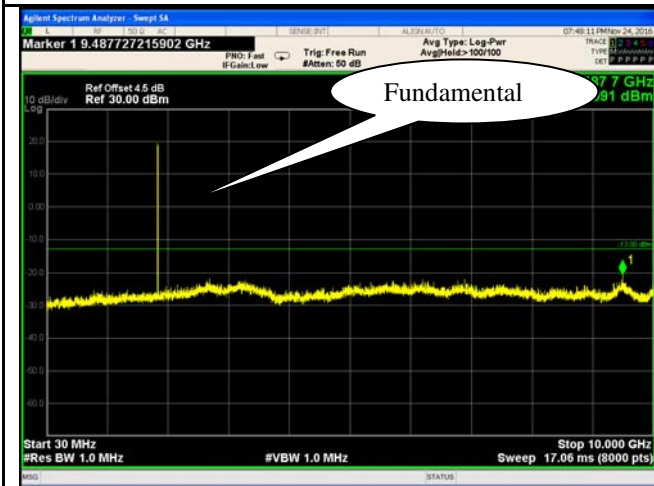

Band II - Middle Channel-1

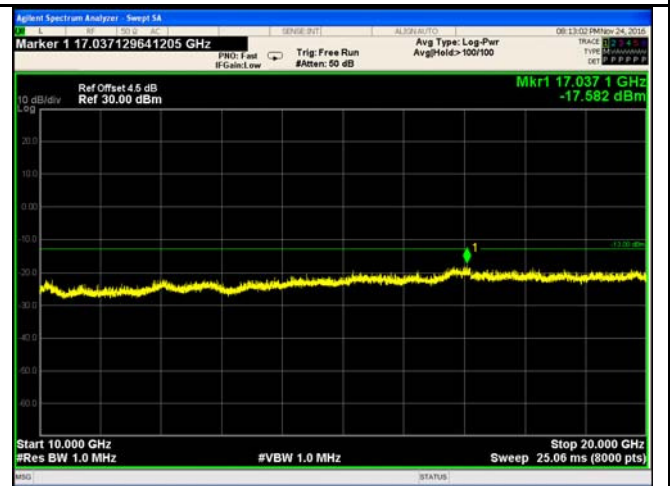

Band II - Middle Channel-2

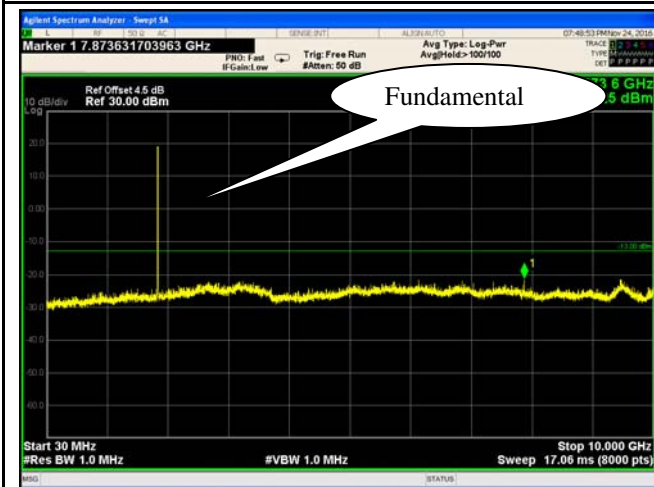

Band II - High Channel-1

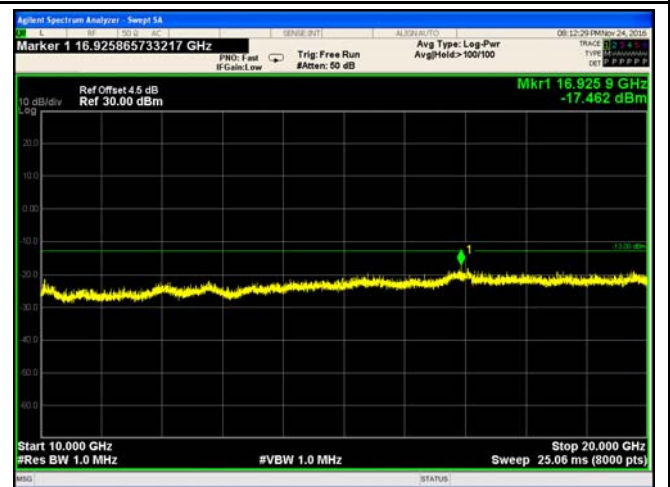

Band II - High Channel-2

UMTS-FDD Band IV (Part 27)

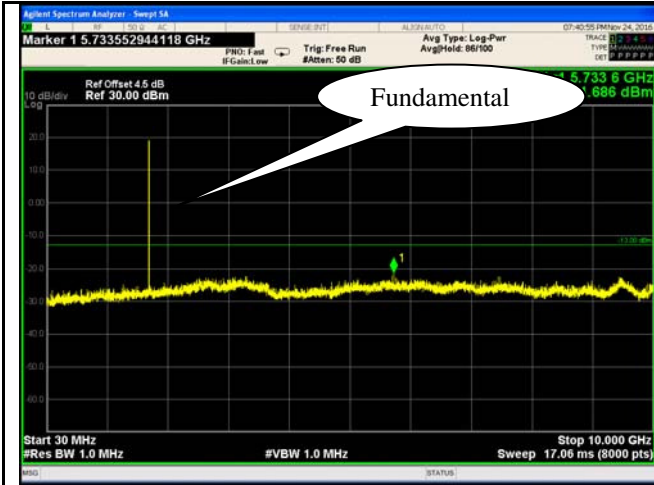

Band IV - Low Channel-1



Band IV - Low Channel-2

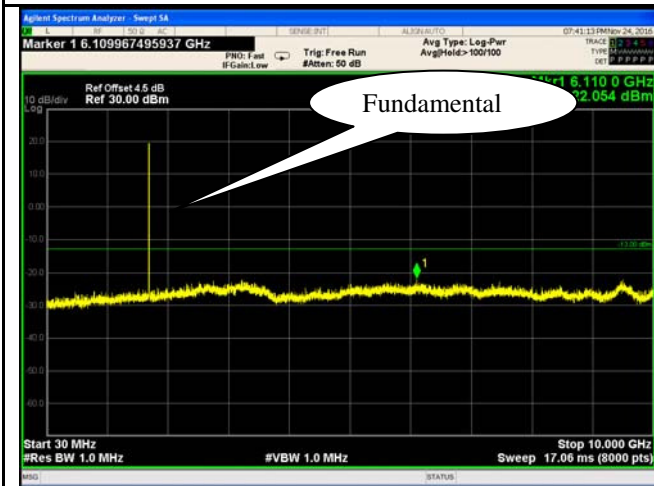

Band IV - Middle Channel-1

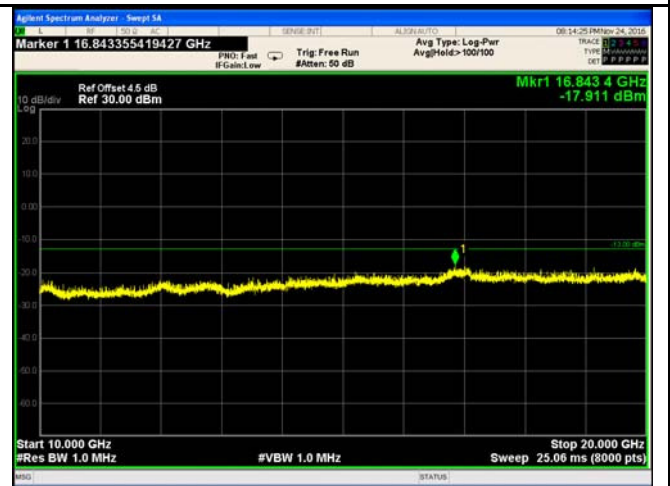

Band IV - Middle Channel-2

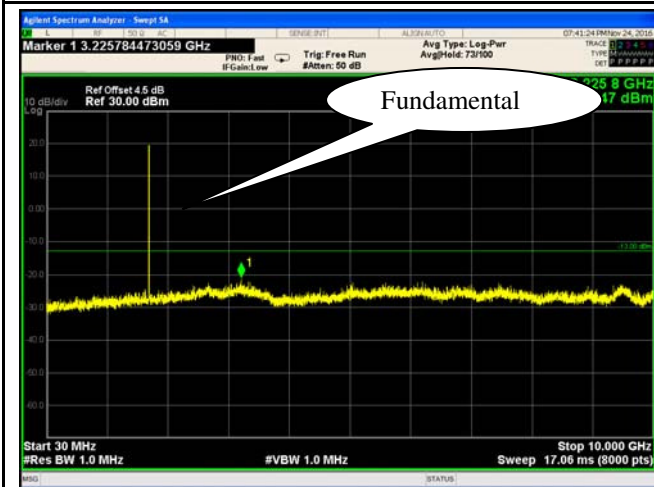

Band IV - High Channel-1

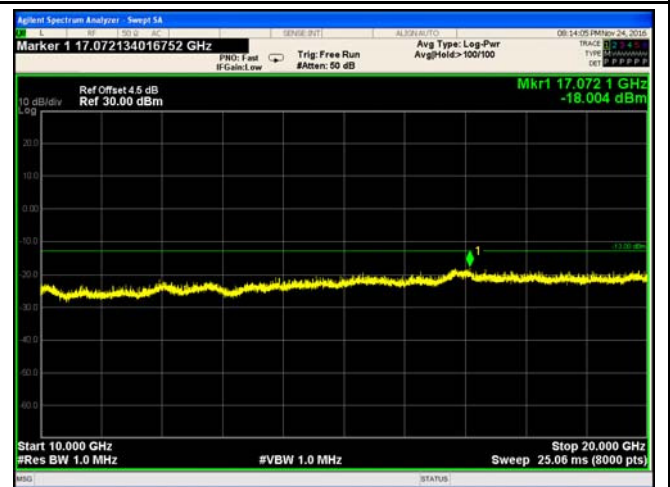

Band IV - High Channel-2

6.6 Spurious Radiated Emissions

Temperature	25°C
Relative Humidity	52%
Atmospheric Pressure	1028mbar
Test date :	November 28, 2016
Tested By :	Loren Luo

Requirement(s):

Spec	Item	Requirement	Applicable
§2.1053, §22.917 & §24.238 § 27.53(h)	a)	The power of any emission outside of the authorized operating frequency ranges must be attenuated below the transmitter power (P) by a factor of at least $43 + 10 \log (P)$ dB. The spectrum is scanned from 30 MHz up to a frequency including its 10th harmonic.	<input checked="" type="checkbox"/>

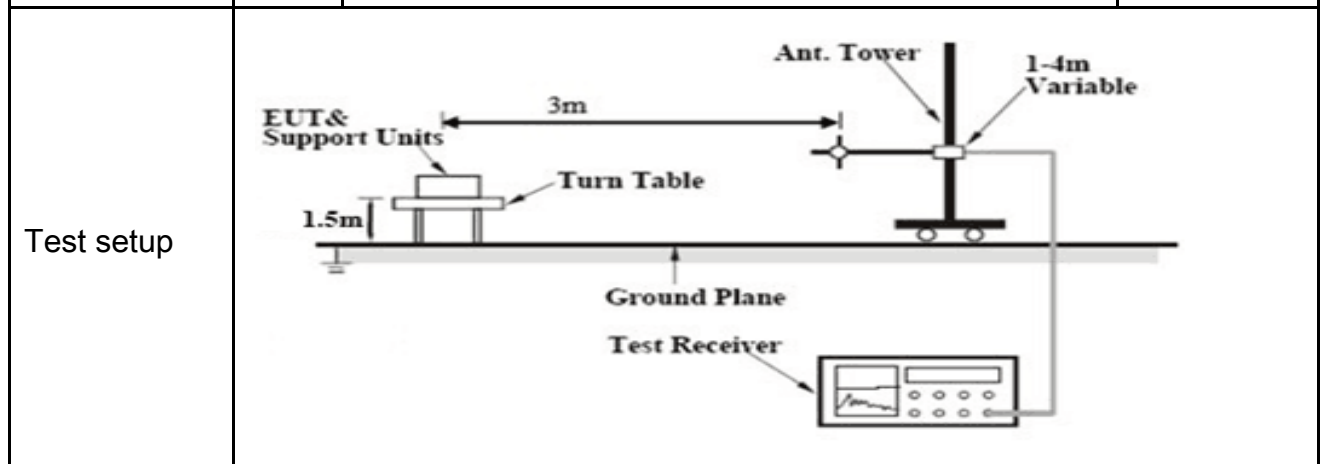

Test Procedure	<ol style="list-style-type: none"> The transmitter was placed on a wooden turntable, and it was transmitting into a non-radiating load which was also placed on the turntable. The measurement antenna was placed at a distance of 3 meters from the EUT. During the tests, the antenna height and polarization as well as EUT azimuth were varied in order to identify the maximum level of emissions from the EUT. The test was performed by placing the EUT on 3-orthogonal axis. Remove the EUT and replace it with substitution antenna. A signal generator was connected to the substitution antenna by a non-radiating cable. The absolute levels of the spurious emissions were measured by the substitution. Sample Calculation: EUT Field Strength = Raw Amplitude (dBµV/m) – Amplifier Gain (dB) + Antenna Factor (dB) + Cable Loss (dB) + Filter Attenuation (dB, if used)
----------------	---

Remark	
--------	--

Test Report	16071331-FCC-R1-V1
Page	60 of 97

Result	<input checked="" type="checkbox"/> Pass	<input type="checkbox"/> Fail
--------	--	-------------------------------

Test Data Yes N/A

Test Plot Yes (See below) N/A

Cellular Band (Part 22H) result

Low channel

Frequency (MHz)	Substituted level (dBm)	Polarity (H/V)	Antenna Gain Correction (dB)	Cable Loss (dB)	Corrected Reading (dBm)	Limit (dBm)	Margin (dB)
1648.4	-43.68	V	7.95	0.78	-36.51	-13	-23.51
1648.4	-44.13	H	7.95	0.78	-36.96	-13	-23.96
329.5	-52.89	V	6.4	0.26	-46.75	-13	-33.75
606.3	-53.12	H	6.8	0.37	-46.69	-13	-33.69

Middle channel

Frequency (MHz)	Substituted level (dBm)	Polarity (H/V)	Antenna Gain Correction (dB)	Cable Loss (dB)	Corrected Reading (dBm)	Limit (dBm)	Margin (dB)
1673.2	-43.56	V	7.95	0.78	-36.39	-13	-23.39
1673.2	-44.25	H	7.95	0.78	-37.08	-13	-24.08
326.7	-53.62	V	6.4	0.26	-47.48	-13	-34.48
605.4	-53.21	H	6.8	0.37	-46.78	-13	-33.78

High channel

Frequency (MHz)	Substituted level (dBm)	Polarity (H/V)	Antenna Gain Correction (dB)	Cable Loss (dB)	Corrected Reading (dBm)	Limit (dBm)	Margin (dB)
1697.6	-43.65	V	7.95	0.78	-36.48	-13	-23.48
1697.6	-44.13	H	7.95	0.78	-36.96	-13	-23.96
325.8	-52.67	V	6.4	0.26	-46.53	-13	-33.53
604.8	-52.79	H	6.8	0.37	-46.36	-13	-33.36

Note:

- 1, The testing has been conformed to $10 \times 848.8 \text{ MHz} = 8,488 \text{ MHz}$
- 2, All other emissions more than 30 dB below the limit
- 3, GSM voice, GPRS and EGPRS mode were investigated. The results above show only the worse cases
- 4, X-Axis, Y-Axis and Z-Axis were investigated. The results above show only the worst case.

PCS Band (Part24E) result

Low channel

Frequency (MHz)	Substituted level (dBm)	Polarity (H/V)	Antenna Gain Correction (dB)	Cable Loss (dB)	Corrected Reading (dBm)	Limit (dBm)	Margin (dB)
3700.4	-48.79	V	10.25	2.73	-41.27	-13	-28.27
3700.4	-49.05	H	10.25	2.73	-41.53	-13	-28.53
325.4	-53.62	V	6.4	0.26	-47.48	-13	-34.48
601.3	-53.86	H	6.8	0.37	-47.43	-13	-34.43

Middle channel

Frequency (MHz)	Substituted level (dBm)	Polarity (H/V)	Antenna Gain Correction (dB)	Cable Loss (dB)	Corrected Reading (dBm)	Limit (dBm)	Margin (dB)
3760	-48.69	V	10.25	2.73	-41.17	-13	-28.17
3760	-49.46	H	10.25	2.73	-41.94	-13	-28.94
329.7	-53.28	V	6.4	0.26	-47.14	-13	-34.14
604.5	-53.67	H	6.8	0.37	-47.24	-13	-34.24

High channel

Frequency (MHz)	Substituted level (dBm)	Polarity (H/V)	Antenna Gain Correction (dB)	Cable Loss (dB)	Corrected Reading (dBm)	Limit (dBm)	Margin (dB)
3819.6	-48.75	V	10.36	2.73	-41.12	-13	-28.12
3819.6	-49.52	H	10.36	2.73	-41.89	-13	-28.89
326.6	-53.37	V	6.4	0.26	-47.23	-13	-34.23
602.7	-52.16	H	6.8	0.37	-45.73	-13	-32.73

Note:

- 1, The testing has been conformed to $10 \times 1909.8 \text{MHz} = 19,098 \text{MHz}$
- 2, All other emissions more than 30 dB below the limit
- 3, GSM voice, GPRS and EGPRS mode were investigated. The results above show only the worse cases
- 4, X-Axis, Y-Axis and Z-Axis were investigated. The results above show only the worst case.

UMTS-FDD Band V (Part 22H)

Low channel

Frequency (MHz)	Substituted level (dBm)	Polarity (H/V)	Antenna Gain Correction (dB)	Cable Loss (dB)	Corrected Reading (dBm)	Limit (dBm)	Margin (dB)
1652.8	-46.89	V	7.95	0.78	-39.72	-13	-26.72
1652.8	-46.13	H	7.95	0.78	-38.96	-13	-25.96
329.7	-52.86	V	6.4	0.26	-46.72	-13	-33.72
604.6	-53.34	H	6.8	0.37	-46.91	-13	-33.91

Middle channel

Frequency (MHz)	Substituted level (dBm)	Polarity (H/V)	Antenna Gain Correction (dB)	Cable Loss (dB)	Corrected Reading (dBm)	Limit (dBm)	Margin (dB)
1670	-46.59	V	7.95	0.78	-39.42	-13	-26.42
1670	-45.86	H	7.95	0.78	-38.69	-13	-25.69
324.7	-53.16	V	6.4	0.26	-47.02	-13	-34.02
605.9	-52.97	H	6.8	0.37	-46.54	-13	-33.54

High channel

Frequency (MHz)	Substituted level (dBm)	Polarity (H/V)	Antenna Gain Correction (dB)	Cable Loss (dB)	Corrected Reading (dBm)	Limit (dBm)	Margin (dB)
1693.2	-46.79	V	7.95	0.78	-39.62	-13	-26.62
1693.2	-45.82	H	7.95	0.78	-38.65	-13	-25.65
325.9	-53.17	V	6.4	0.26	-47.03	-13	-34.03
607.5	-53.26	H	6.8	0.37	-46.83	-13	-33.83

Note:

- 1, The testing has been conformed to $10 \times 846.6 \text{MHz} = 8,466 \text{MHz}$
- 2, All other emissions more than 30 dB below the limit
- 3, RMC, HSUPA and HSDPA mode were investigated. The results above show only the worse cases
- 4, X-Axis, Y-Axis and Z-Axis were investigated. The results above show only the worst case.

UMTS-FDD Band II (Part 24E)

Low channel

Frequency (MHz)	Substituted level (dBm)	Polarity (H/V)	Antenna Gain Correction (dB)	Cable Loss (dB)	Corrected Reading (dBm)	Limit (dBm)	Margin (dB)
3704.8	-49.58	V	10.25	2.73	-42.06	-13	-29.06
3704.8	-50.21	H	10.25	2.73	-42.69	-13	-29.69
330.4	-53.57	V	6.4	0.26	-47.43	-13	-34.43
598.3	-53.62	H	6.8	0.37	-47.19	-13	-34.19

Middle channel

Frequency (MHz)	Substituted level (dBm)	Polarity (H/V)	Antenna Gain Correction (dB)	Cable Loss (dB)	Corrected Reading (dBm)	Limit (dBm)	Margin (dB)
3760	-46.59	V	10.25	2.73	-39.07	-13	-26.07
3760	-49.82	H	10.25	2.73	-42.3	-13	-29.3
331.4	-53.68	V	6.4	0.26	-47.54	-13	-34.54
608.5	-53.79	H	6.8	0.37	-47.36	-13	-34.36

High channel

Frequency (MHz)	Substituted level (dBm)	Polarity (H/V)	Antenna Gain Correction (dB)	Cable Loss (dB)	Corrected Reading (dBm)	Limit (dBm)	Margin (dB)
3815.2	-49.56	V	10.36	2.73	-41.93	-13	-28.93
3815.2	-49.73	H	10.36	2.73	-42.1	-13	-29.1
326.7	-53.82	V	6.4	0.26	-47.68	-13	-34.68
606.4	-53.94	H	6.8	0.37	-47.51	-13	-34.51

Note:

- 1, The testing has been conformed to $10 \times 1907.6 \text{ MHz} = 19,076 \text{ MHz}$
- 2, All other emissions more than 30 dB below the limit
- 3, RMC, HSUPA and HSDPA mode were investigated. The results above show only the worse cases
- 4, X-Axis, Y-Axis and Z-Axis were investigated. The results above show only the worst case

UMTS-FDD Band IV (Part 27)

Low channel

Frequency (MHz)	Substituted level (dBm)	Polarity (H/V)	Antenna Gain Correction (dB)	Cable Loss (dB)	Corrected Reading (dBm)	Limit (dBm)	Margin (dB)
3424.8	-45.97	V	10.07	2.52	-38.42	-13	-25.42
3424.8	-48.56	H	10.07	2.52	-41.01	-13	-28.01
324.6	-57.62	V	6.4	0.26	-51.48	-13	-38.48
736.5	-52.84	H	7.1	0.42	-46.16	-13	-33.16

Middle channel

Frequency (MHz)	Substituted level (dBm)	Polarity (H/V)	Antenna Gain Correction (dB)	Cable Loss (dB)	Corrected Reading (dBm)	Limit (dBm)	Margin (dB)
3480	-46.37	V	10.09	2.52	-38.8	-13	-25.8
3480	-46.12	H	10.09	2.52	-38.55	-13	-25.55
325.9	-56.87	V	6.4	0.26	-50.73	-13	-37.73
734.6	-53.26	H	7.1	0.42	-46.58	-13	-33.58

High channel

Frequency (MHz)	Substituted level (dBm)	Polarity (H/V)	Antenna Gain Correction (dB)	Cable Loss (dB)	Corrected Reading (dBm)	Limit (dBm)	Margin (dB)
3505.2	-45.89	V	10.09	2.52	-38.32	-13	-25.32
3505.2	-45.67	H	10.09	2.52	-38.1	-13	-25.1
325.8	-57.68	V	6.4	0.26	-51.54	-13	-38.54
739.5	-52.34	H	7.1	0.42	-45.66	-13	-32.66

Note:

- 1, The testing has been conformed to $10 \times 1752.6 \text{ MHz} = 17.526 \text{ MHz}$
- 2, All other emissions more than 30 dB below the limit
- 3, RMC, HSUPA and HSDPA mode were investigated. The results above show only the worse cases.
- 4, X-Axis, Y-Axis and Z-Axis were investigated. The results above show only the worst case.

6.7 Band Edge

Temperature	25°C
Relative Humidity	57%
Atmospheric Pressure	1024mbar
Test date :	November 24, 2016
Tested By :	Loren Luo

Requirement(s):

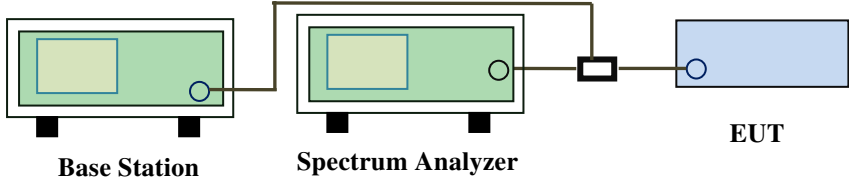
Spec	Item	Requirement	Applicable
§22.917(a) §24.238(a) § 27.53(h)	a)	The power of any emission outside of the authorized operating frequency ranges must be lower than the transmitter power (P) by a factor of at least $43 + 10 \log (P)$ dB.	<input checked="" type="checkbox"/>
Test setup	 <p style="text-align: center;"> Base Station Spectrum Analyzer EUT </p>		
Procedure	<ul style="list-style-type: none"> - The EUT was connected to Spectrum Analyzer and Base Station via power divider. - The Band Edges of low and high channels for the highest RF powers were measured. Setting RBW as roughly BW/100. 		
Remark			
Result	<input checked="" type="checkbox"/> Pass <input type="checkbox"/> Fail		

Test Data Yes N/A

Test Plot Yes (See below) N/A

GSM Voice:

Cellular Band (Part 22H) result

Frequency (MHz)	Emission (dBm)	Limit (dBm)
823.996	-17.654	-13
849.018	-18.768	-13

PCS Band (Part24E) result

Frequency (MHz)	Emission (dBm)	Limit (dBm)
1849.983	-17.221	-13
1910.018	-16.666	-13

GPRS:

Cellular Band (Part 22H) result

Frequency (MHz)	Emission (dBm)	Limit (dBm)
823.997	-16.823	-13
849.022	-17.555	-13

PCS Band (Part24E) result

Frequency (MHz)	Emission (dBm)	Limit (dBm)
1849.994	-17.124	-13
1910.016	-17.590	-13

EGPRS (MCS1):

Cellular Band (Part 22H) result

Frequency (MHz)	Emission (dBm)	Limit (dBm)
823.997	-18.145	-13
849.019	-18.559	-13

PCS Band (Part24E) result

Frequency (MHz)	Emission (dBm)	Limit (dBm)
1849.999	-15.689	-13
1910.017	-17.397	-13

RCM:

UMTS-FDD Band V (Part 22H)

Frequency (MHz)	Emission (dBm)	Limit (dBm)
822.63	-27.116	-13
850.12	-31.593	-13

UMTS-FDD Band II (Part 24E)

Frequency (MHz)	Emission (dBm)	Limit (dBm)
1849.02	-27.736	-13
1910.07	-26.924	-13

UMTS-FDD Band IV (Part 27)

Frequency (MHz)	Emission (dBm)	Limit (dBm)
1709.12	-25.859	-13
1756.36	-27.543	-13

HSUPA:

UMTS-FDD Band V (Part 22H)

Frequency (MHz)	Emission (dBm)	Limit (dBm)
823.02	-26.600	-13
849.99	-32.285	-13

UMTS-FDD Band II (Part 24E)

Frequency (MHz)	Emission (dBm)	Limit (dBm)
1849.02	-27.591	-13
1910.03	-27.658	-13

UMTS-FDD Band IV (Part 27)

Frequency (MHz)	Emission (dBm)	Limit (dBm)
1708.82	-26.108	-13
1756.11	-27.650	-13

HSDPA:

UMTS-FDD Band V (Part 22H)

Frequency (MHz)	Emission (dBm)	Limit (dBm)
823.03	-26.685	-13
849.27	-31.816	-13

UMTS-FDD Band II (Part 24E)

Frequency (MHz)	Emission (dBm)	Limit (dBm)
1849.12	-27.912	-13
1910.04	-27.849	-13

UMTS-FDD Band IV (Part 27)

Frequency (MHz)	Emission (dBm)	Limit (dBm)
1708.64	-25.988	-13
1755.92	-27.892	-13