

**G91**

**User Guide**

## Contents

<b>I. CAUTIONS ON MOBILE PHONE USE</b> .....	<b>4</b>
<b>1.1 INTERFERENCE</b> .....	<b>4</b>
<b>1.2 REASONABLE USE</b> .....	<b>4</b>
<b>1.3 QUALIFIED MAINTENANCE SERVICE</b> .....	<b>4</b>
<b>1.4 WATER-RESISTANCE</b> .....	<b>4</b>
<b>1.5 EMERGENCY CALLS</b> .....	<b>4</b>
<b>2 PRECAUTIONS FOR USE OF BATTERY</b> .....	<b>4</b>
<b>3 CAUTIONS FOR CHILDREN</b> .....	<b>5</b>
<b>II. KEYS AND PARTS</b> .....	<b>6</b>
<b>III. START TO USE</b> .....	<b>7</b>
<b>3.1 TO INSERT SIM CARD(S)</b> :.....	<b>7</b>
<b>3.2 CHARGE THE BATTERY</b> .....	<b>9</b>
<b>IV. BASIC FUNCTIONS</b> .....	<b>9</b>
<b>1. LOCK AND UNLOCK THE SCREEN</b> .....	<b>9</b>
<b>2. MAKE IT YOURS</b> .....	<b>10</b>
<b>3. SWITCH TO RECENTLY USED APPLICATION</b> .....	<b>17</b>
<b>4. MAKE A CALL</b> .....	<b>18</b>
<b>5. CALL LOG</b> .....	<b>19</b>

<b>6. ANSWERING PHONE CALLS AND REJECTION .....</b>	<b>20</b>
<b>7. ADD A CONTACT.....</b>	<b>21</b>
<b>8. SEND AND RECEIVE MESSAGE(S) .....</b>	<b>22</b>
<b>9. BROWSER THE WEB.....</b>	<b>24</b>
<b>10. ENJOY MUSIC .....</b>	<b>25</b>
<b>11. DOWNLOAD APPLICATIONS FROM PLAY STORE.....</b>	<b>26</b>
<b>12. MANAGE APPLICATIONS .....</b>	<b>27</b>
<b>13. APPLICATIONS &amp; UTILITIES.....</b>	<b>28</b>
<b>14. SETTINGS .....</b>	<b>29</b>

## **I. Cautions on mobile phone use**

### **1.1 Interference**

All phones may be interfered, which affect phone calls.

### **1.2 Reasonable use**

Use only in the normal position. Do not touch the antenna area unnecessarily.

### **1.3 Qualified maintenance service**

Only qualified personnel may install or repair this product.

### **1.4 Water-resistance**

Your device is non water-resistant. Keep it dry.

### **1.5 Emergency calls**

Ensure the phone is switched on and in service. Enter the emergency number and press the Dialer icon.

## **2 Precautions for use of battery**

**2.1** Do not dispose of batteries near or in a fire to avoid dangers.

**2.2** Do not dispose of batteries in the garbage. Dispose of batteries to assigned battery recycling center.

### **3 Cautions for children**

Keep your device out the reach of children in case of accidental injury caused by incorrect use of the device as toys.

## II. Keys and parts

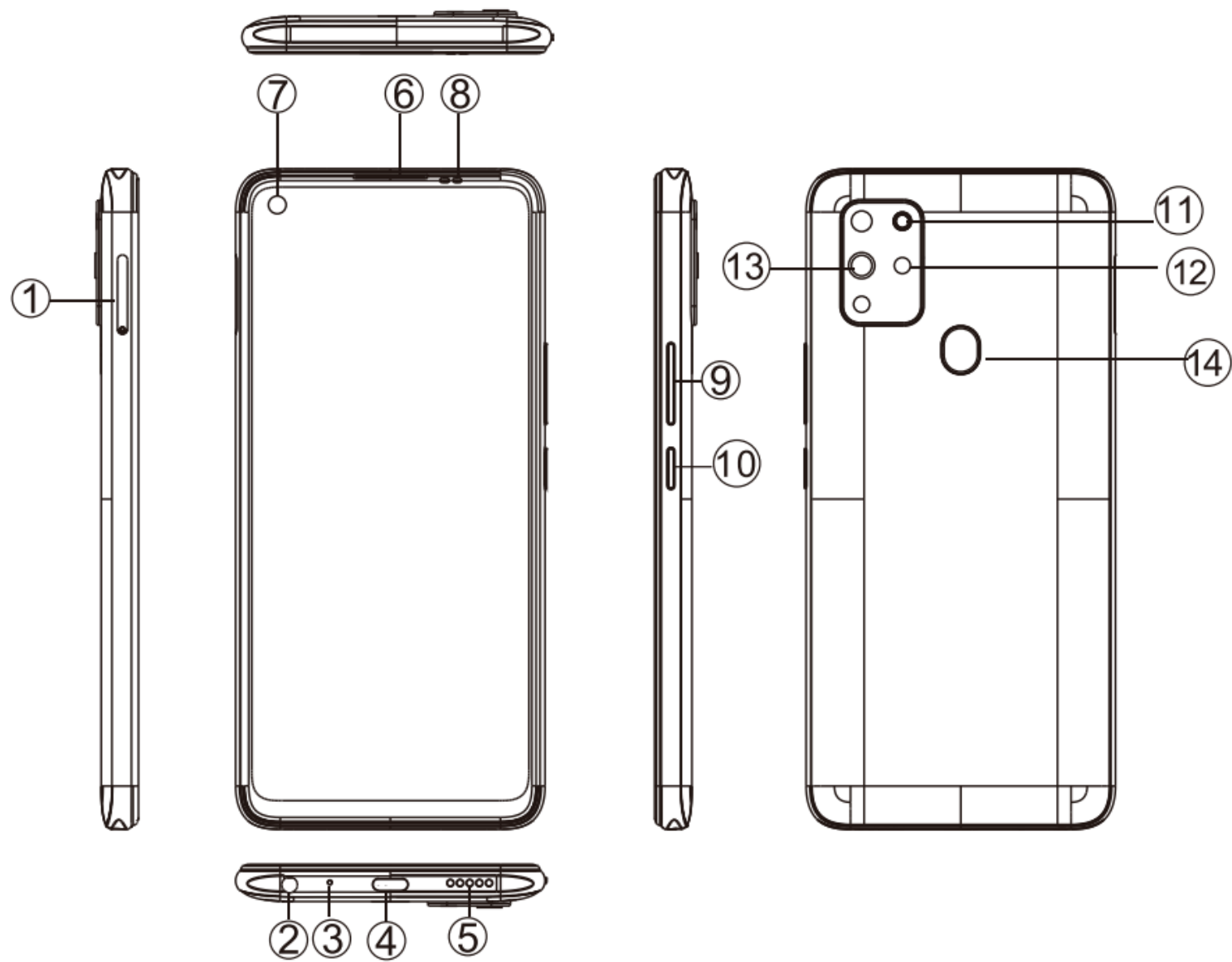

- 1. SIM card tray
- 2. Audio jack
- 3. Mic
- 4. USB connector
- 5. Speaker
- 6. Receiver
- 7. Front camera
- 8. Light sensor / Proximity sensor
- 9. Volume key
- 10. Power key
- 11. Flashlight
- 12. Rear camera
- 13. Rear camera
- 14. Finger printer

### **III. Start to use**

#### **3.1 To insert SIM card(S):**

Insert the SIM card correctly in the card slot(s) (See figure below), suggest switch off the phone when you insert SIM card.

Insert the Micro SD card into the slot with the correct direction (See figure below), suggest switch off the phone when you insert SIM card.

Note: Use only compatible memory cards with this device. Incompatible memory cards may damage the card or the device and corrupt the data stored in the card.

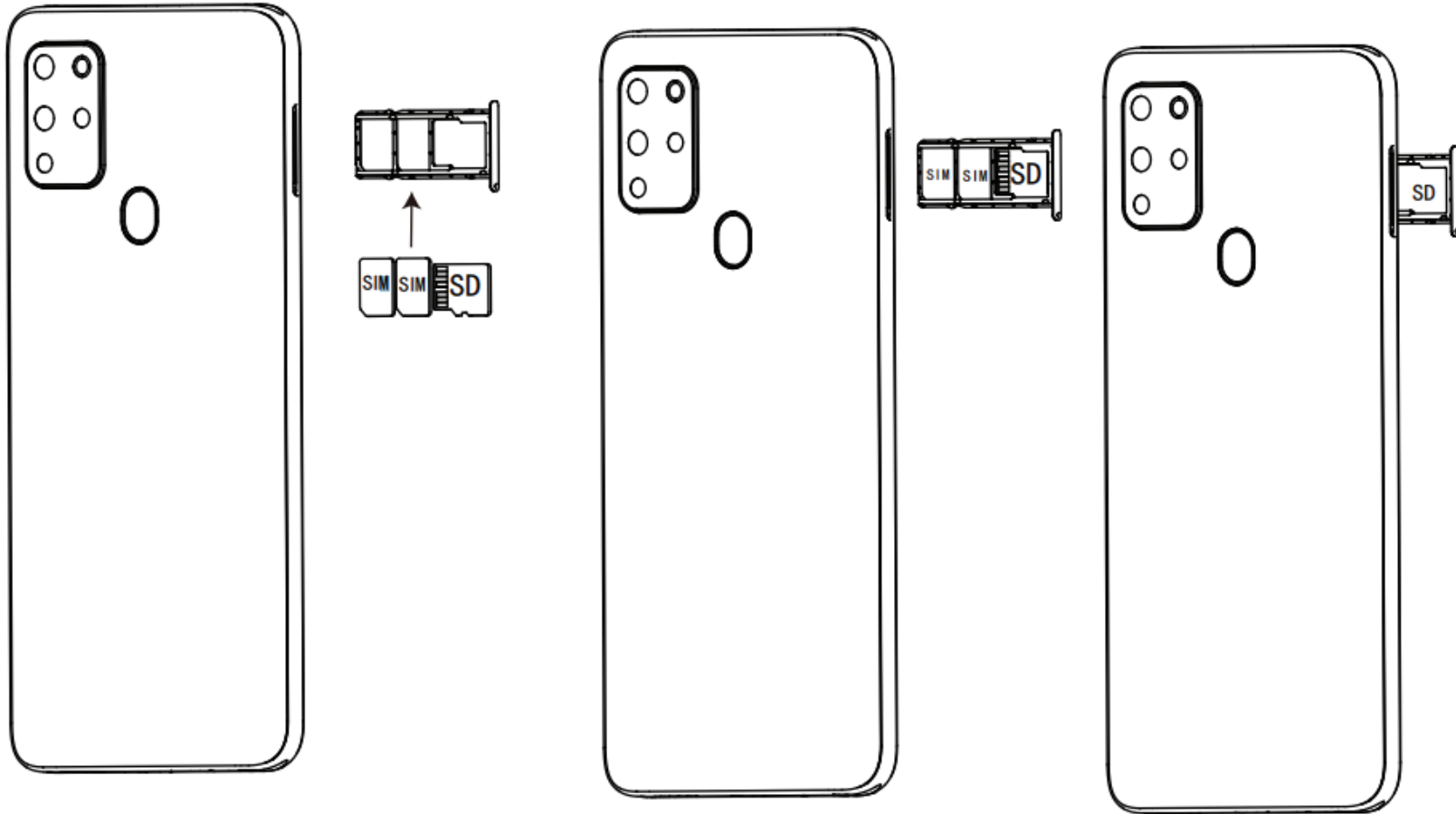



### **3.2 Charge the battery**

During charging, the battery indicator on the phone is a thunder icon. If the device is switched off during charging, there will still be a charging indication on the screen that shows the phone is being charged. If the device is overused when the battery is low, the charging icon might take some time to appear.

When the battery indicator on the screen display 'Battery is full', thunder icon will disappear, which means the completion of charging. If the phone is switched off during charging, the screen will display ' Battery is full '. It generally takes 4 hours to charge the battery. During charging, the battery, the device and the charger will get hot. This is normal.

Unplug the charger from the AC electrical outlet and disconnect the wiring between the phone and the charger after charging. .

**Cautions:** Charge the phone in a well ventilated place in which the temperature is between -10°C to +55°C. Use the charger provided by the manufacturer only. The use of unconfirmed charger may lead to dangers and violate the manufacturer's warranty clause. If the temperature is too high or too low during charging, the device will automatically send a warning and stop charging to avoid damage to the battery or any danger.

## **IV. Basic functions**

### **1. Lock and unlock the screen**

Press power button to enter Sleep mode and meanwhile the screen will be locked; press power button again to wake up and then swipe up for unlock.

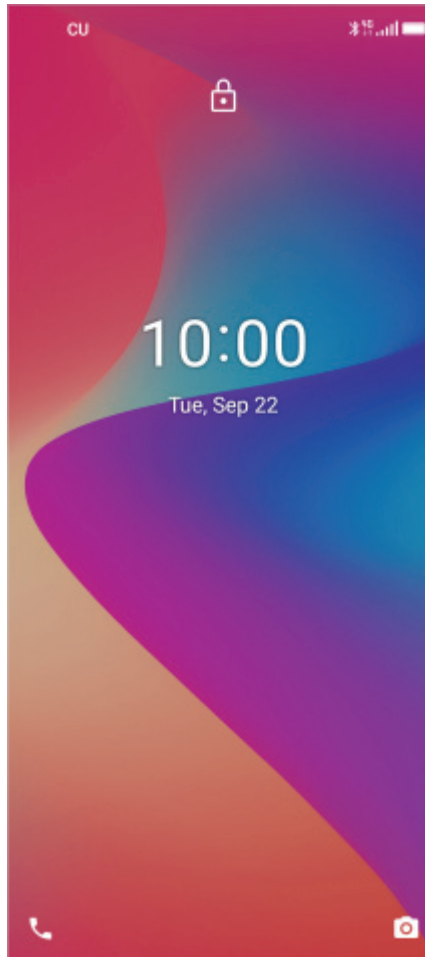

## 2. Make it yours

2.1 Home screen: It is your starting point to access all the features on your phone. It displays application icons, widgets, shortcuts, and other features. Long press home screen and Modify Wallpaper.

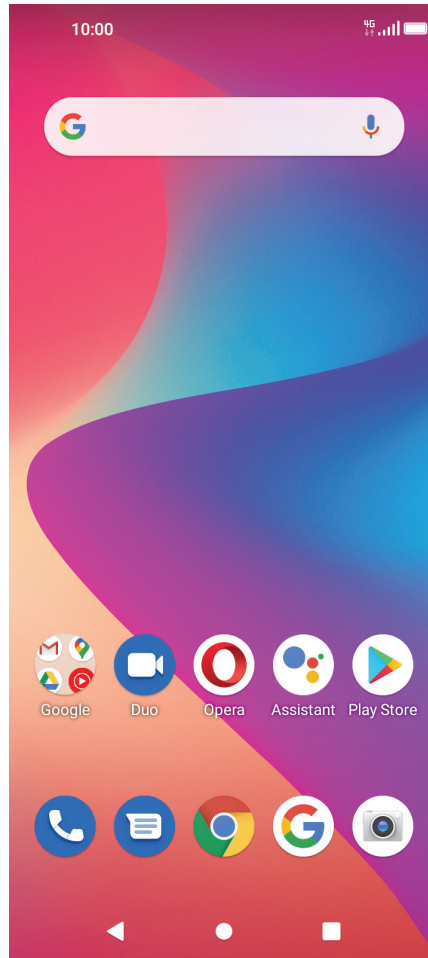

2.2 Long press **Home** screen, and then you can Modify Wallpaper; or enter Launcher and long press and hold an application till the screen vibrates, and then loosen your hold finger.



Long press and hold the widget or icon you want to move. Once the phone vibrates, don't loosen your hold on the icon. Drag the widget or icon to a new location on the screen Press and hold on

an icon till the phone vibrates, and drag the widgets or icon to the trash for remove!



Swipe up and enter the application list

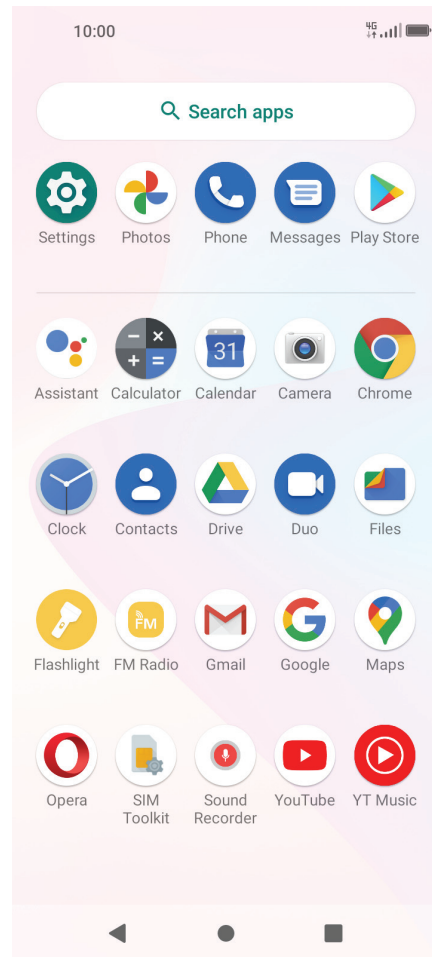

**2.3 Notification Bar:** At the top of the screen, the Status Bar displays the time, status, and notifications. If there is a new message, missed call or something in the notification bar, you can drag it down to open notification panel and click the desired one to have a view. When you finished, you can close it by dragging the panel up or pressing “Back”.

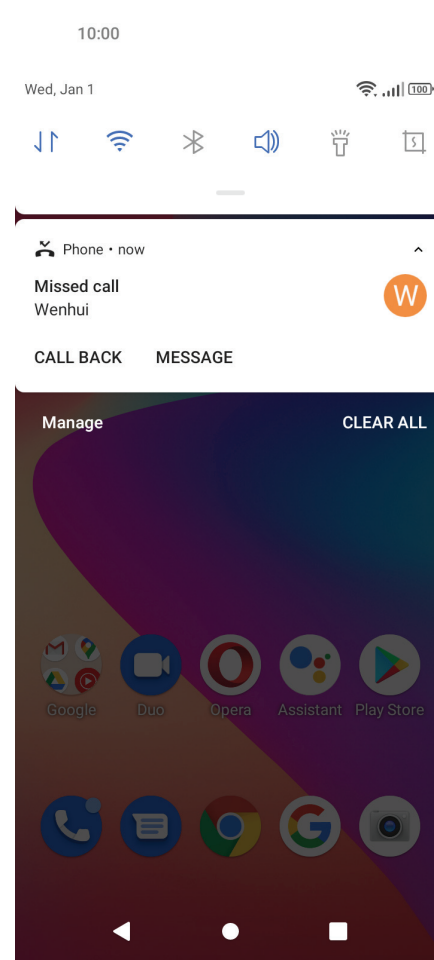



## 2.4 Android™ and computer connection

If you connect your phone to PC via USB, you can find the USB options, choose This Device file Transfer option, you can see your phone memory in PC, this is same function like USB storage.

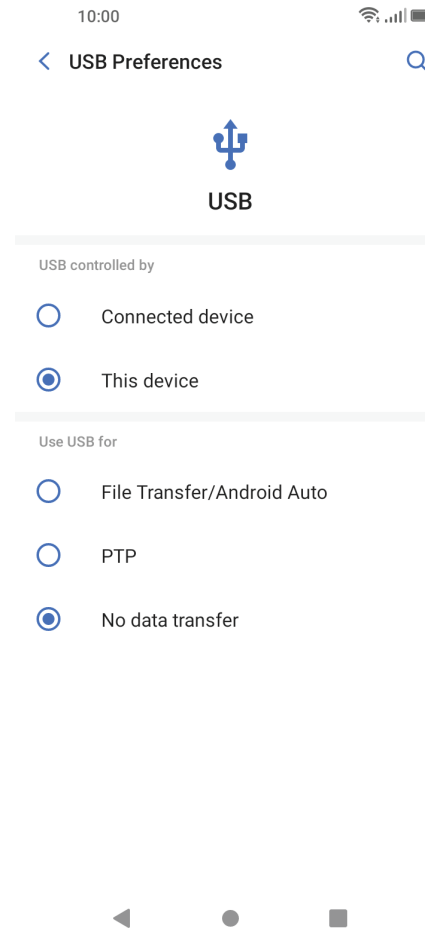
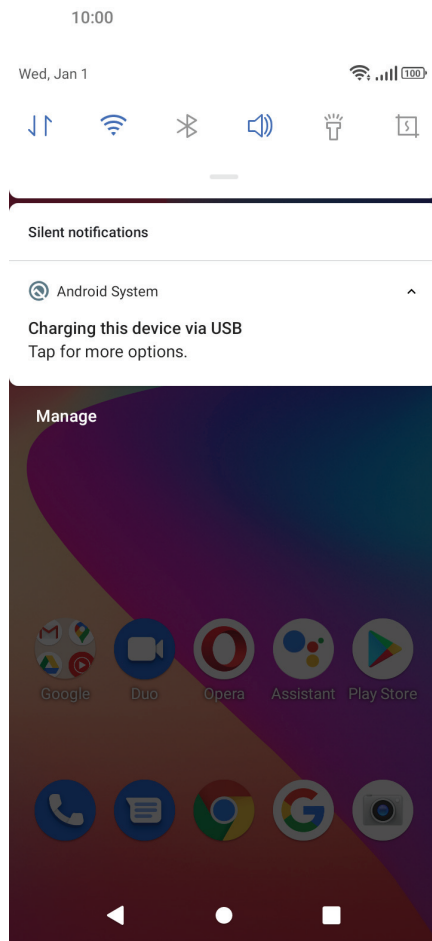



### 3. Switch to Recently Used Application

Press menu key.

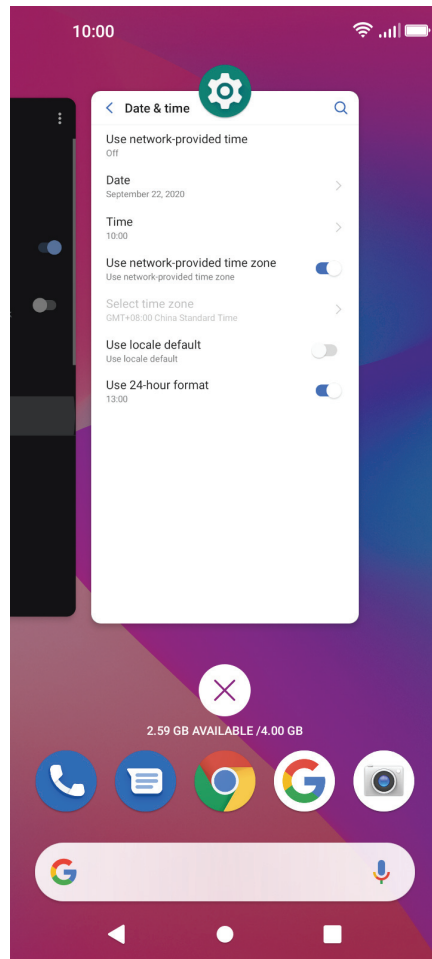

Touch and slide this place can choose to open the history application

Touch this icon to close all history application

#### 4. Make a call

Click  and enter a complete phone number to make a call. Your phone supports smart search.

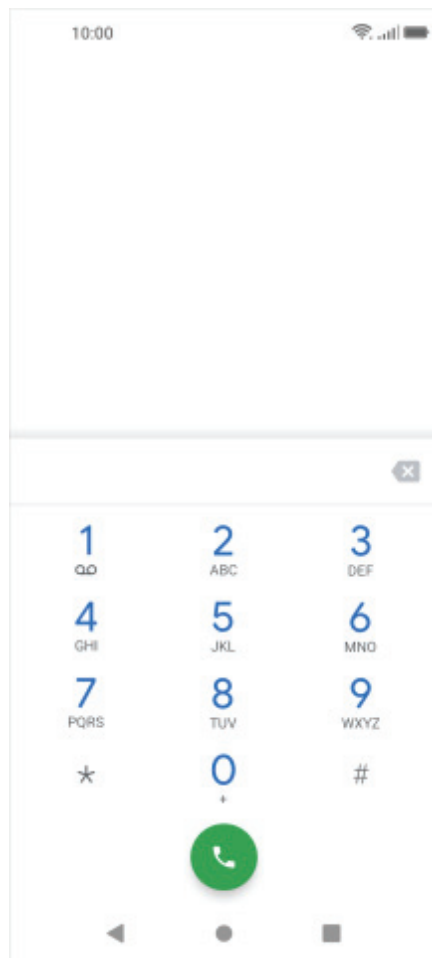

Swipe to right to view Call history and Contacts.

## 5. Call log

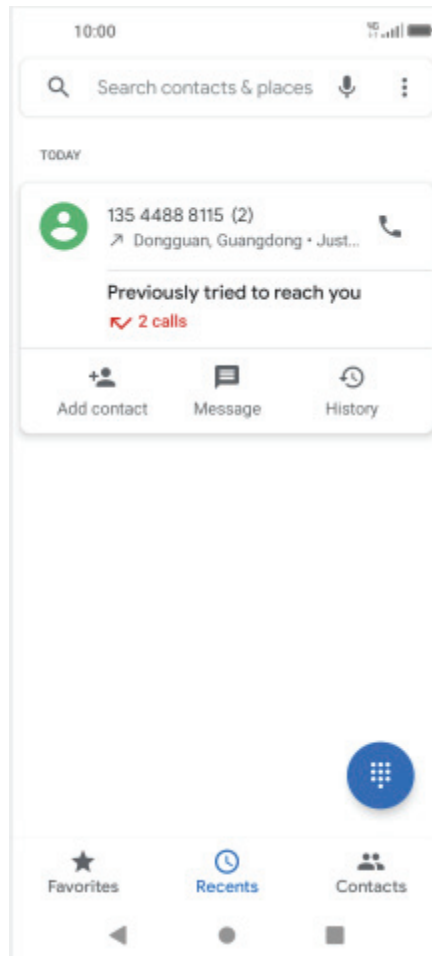

Press the number if you want to see the details , send message or call back, there are three options for you.

Press the number, you can view the contact details, send a message or call back.

## 6. Answering phone calls and rejection

When there is an incoming call, you can drag the icon up or down to answer or hang up it directly.



Call from

135 4488 8115

Dongguan, Guangdong



*Swipe up to answer*



*Swipe down to reject*

## 7. Add a contact

Touch  to enter contact

Touch  to add a new contact

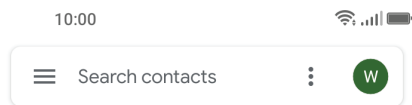

No contacts yet

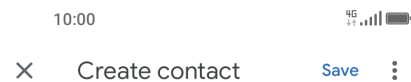
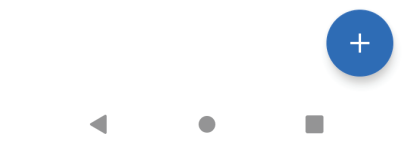



Label  
 

Label  
 

[More fields](#)



Click here to add new contact and in this page press menu key to enter menu view, setting, etc.

## **8. Send and Receive message(s)**

Touch  enter to messaging, touch “Start chat”.

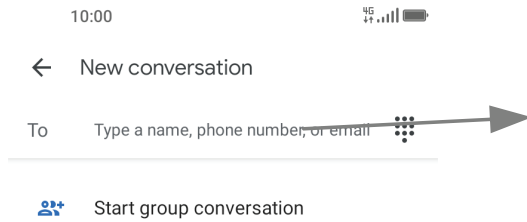

Tap this icon to select desired contact from phone

Touch to switch the digital input and symbols

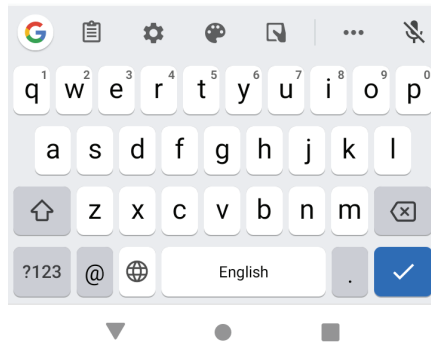

Press space or a punctuation mark to enter the highlighted suggestion

When you are composing a new text message, you can select text for cutting or copying. The selected text is highlighted in blue

Tap  to add “Attach” including Pictures, Videos, Audios, etc to send MMS.SMS

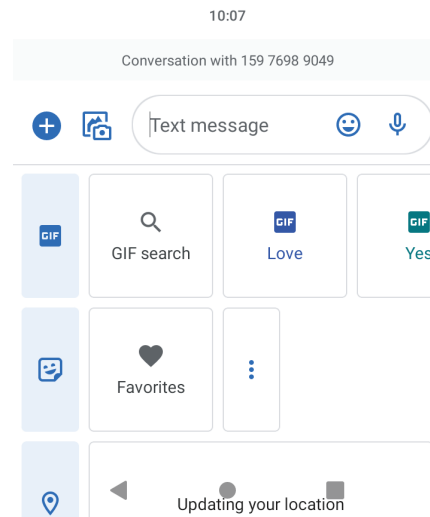
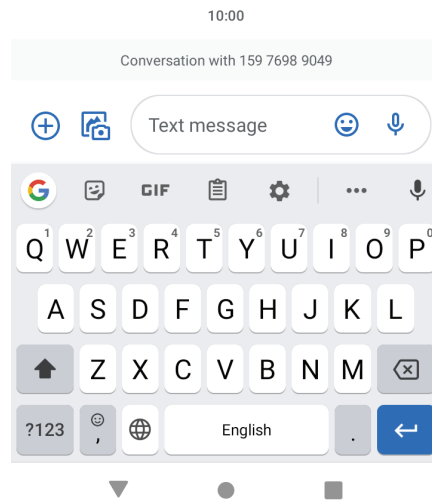
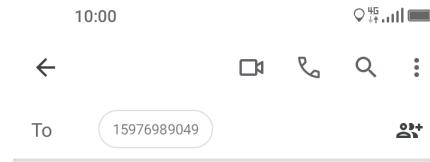
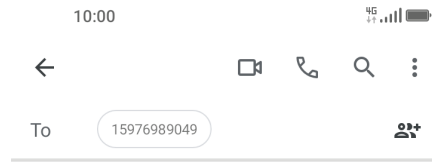

When a new message comes, you can read by dragging notification panel and click the message, or entering Message to read it directly.

Long press one of the all message threads, you can delete it”.

## 9. Browser the Web

### 9.1 Set up Internet/Data connection



Enter Settings > More..., scroll down to find out Mobile network, and then enter “Access Points Names, choose the desired WAP account.

### **9.2 Switch on Data connection or Wi-Fi**

To browse the web, you need to switch on Data connection. If there is Wi-Fi around, you can switch on Wi-Fi to use it browse the web.

## **10. Enjoy music**

When you copy music to your SD card, the Music player searches the card for music files and builds a catalog of your music, based on information about each file that is stored in the file itself.

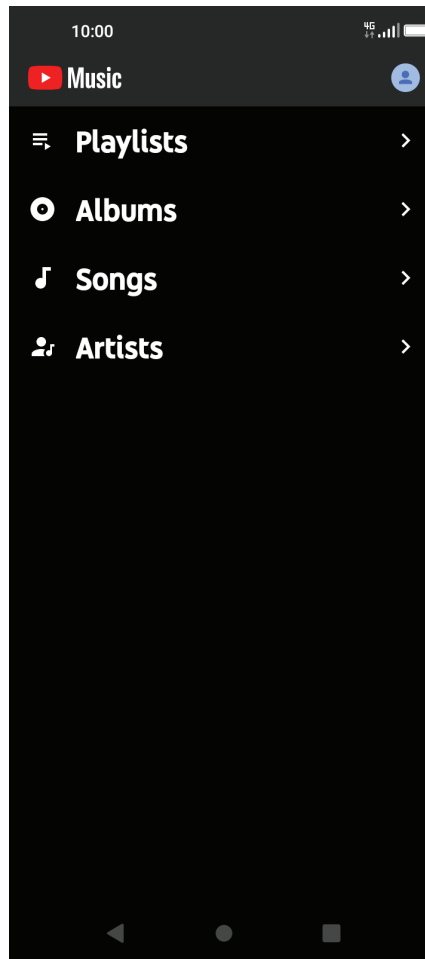

## **11. Download applications from Play Store**

**11.1** Add Google™ account

**11.2** Enter play store and download apps

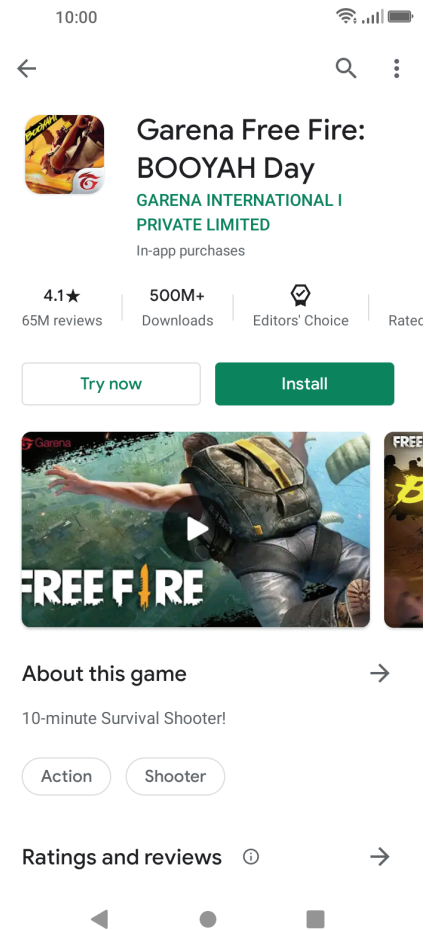
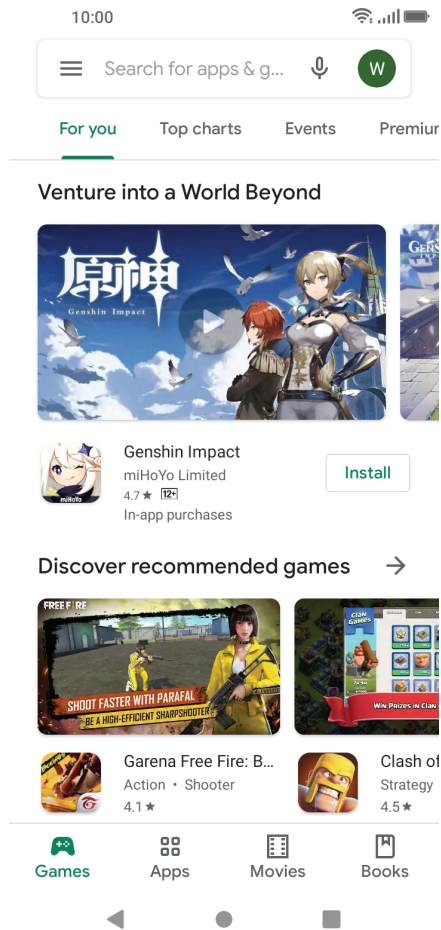

## 12. Manage Applications

Enter Setting > App.

You can see

.

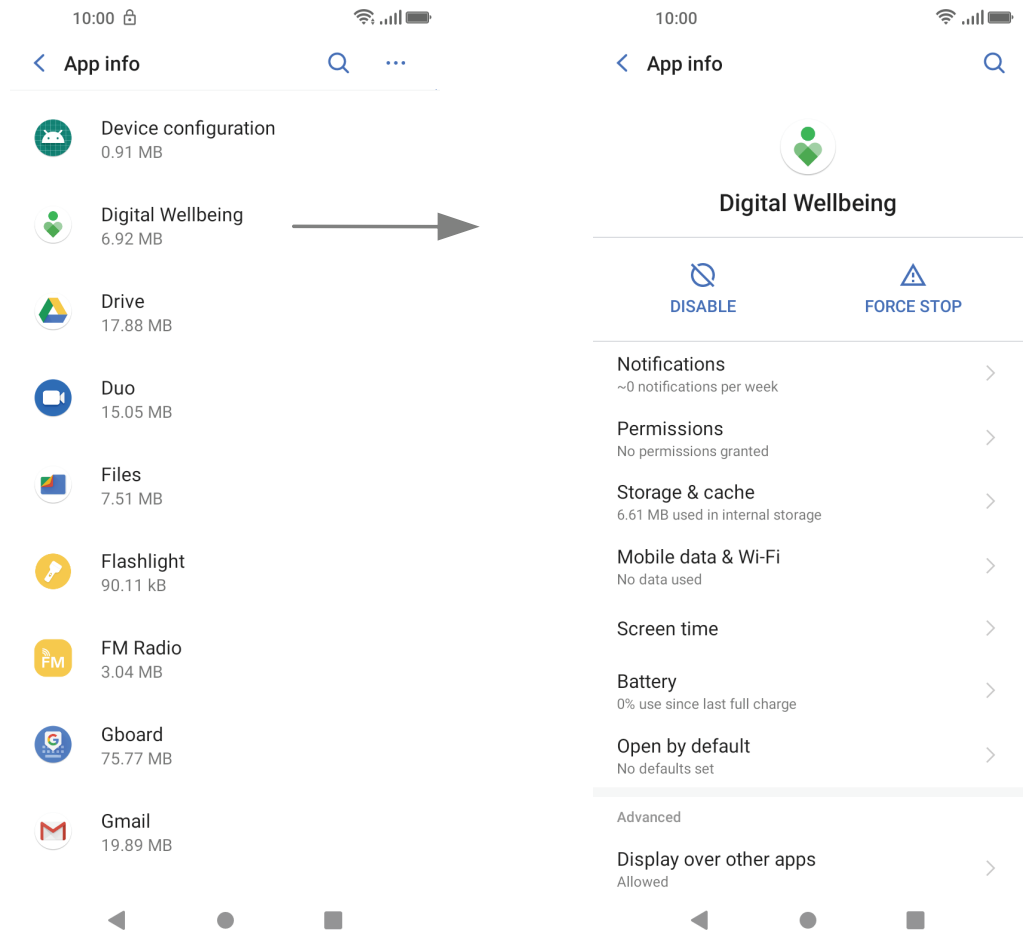

### 13. APPLICATIONS & UTILITIES

For your entertainment purpose, your device is provided with several interesting games, applications and utilities, such as Gmail, Email, Play Store. Before accessing the applications, please turn on the data connection or connect to wifi.

## 14. Settings

### 14.1 Wi-Fi

Open Wi-Fi, search nearby Wi-Fi and connect it, then you can use Internet or download apps for free.

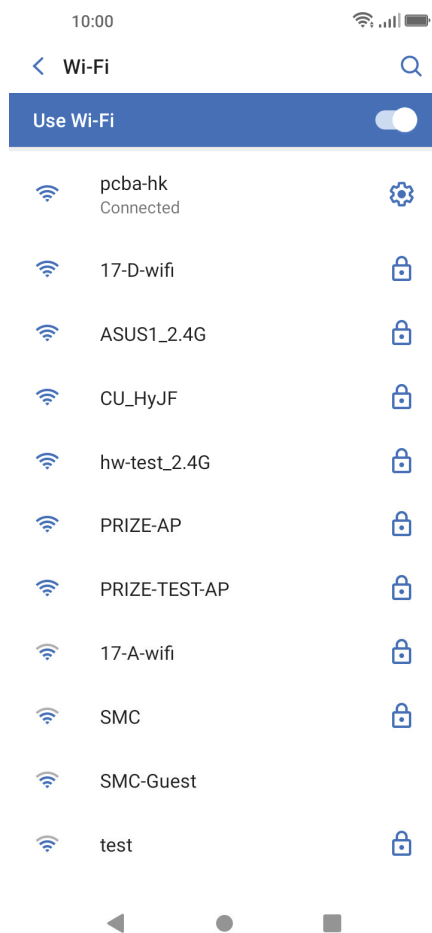

### 14.2 Bluetooth

Open Bluetooth, connect to other phone, you can share something like music, photos, movies etc to other people.

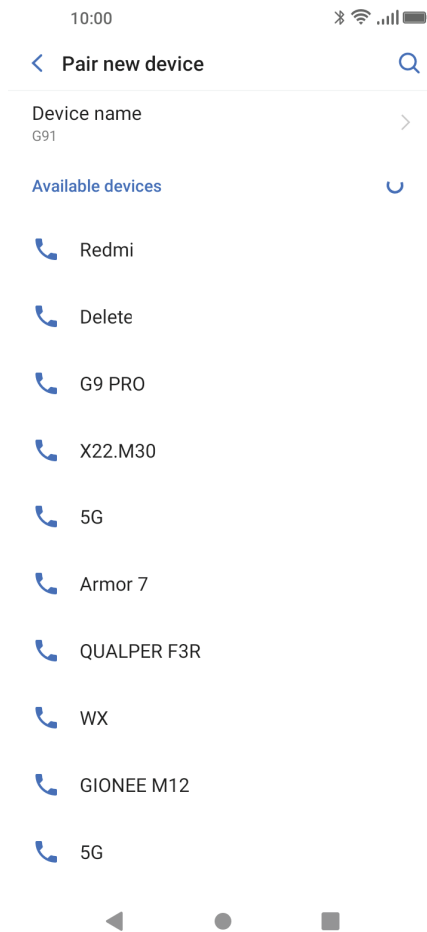
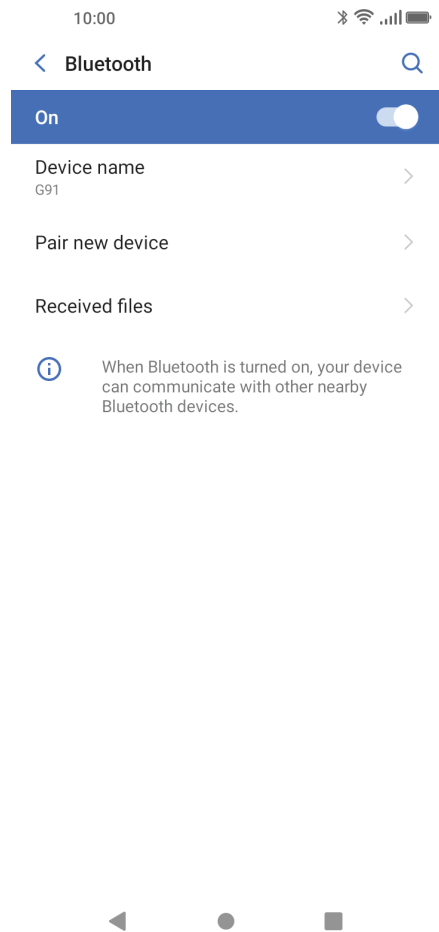

### 14.3 Security

Screen lock.

There are four screen lock ways for you to choose :Slide, Pattern, PIN, Password.

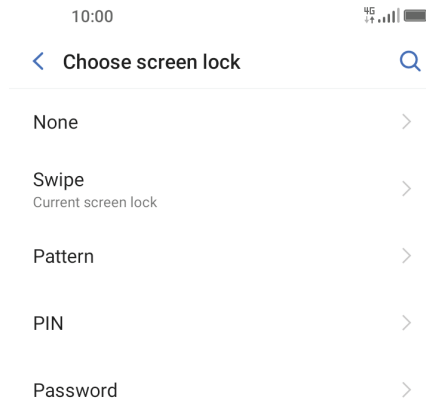

## 14.4 Face ID

Click Settings - Security and Location - Face Unlock, follow the prompts ,after completing the face recording, you can use the face unlock function.

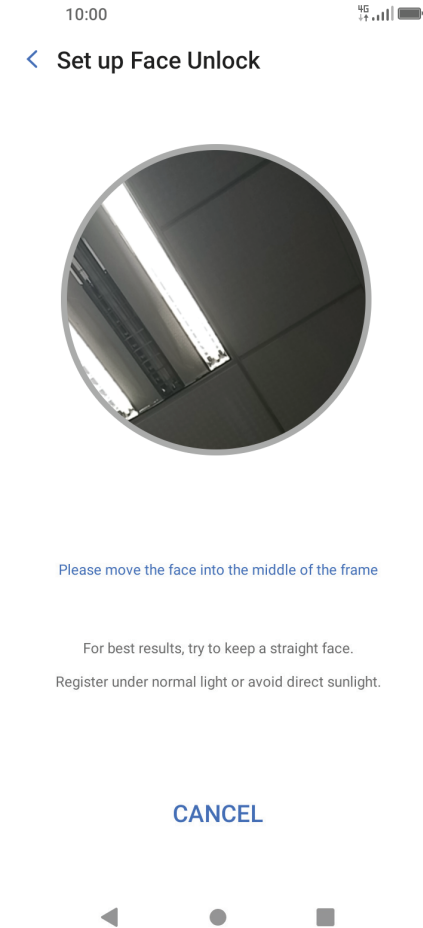
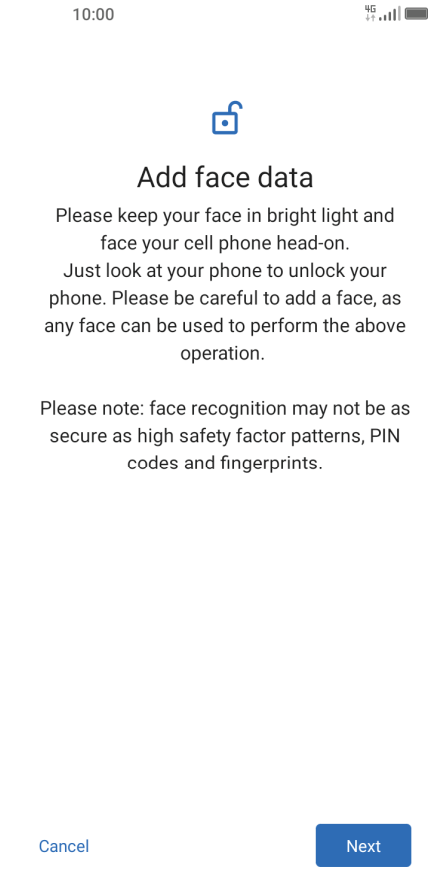
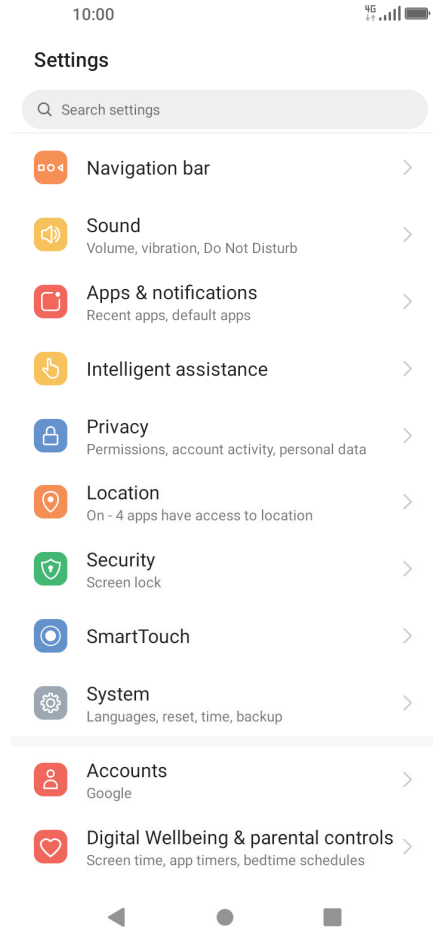

## 14.5 Fingerprint



Click Settings - Security and Location - fingerprint, follow the prompts ,after completing the fingerprint recording, you can use the fingerprint unlock function.

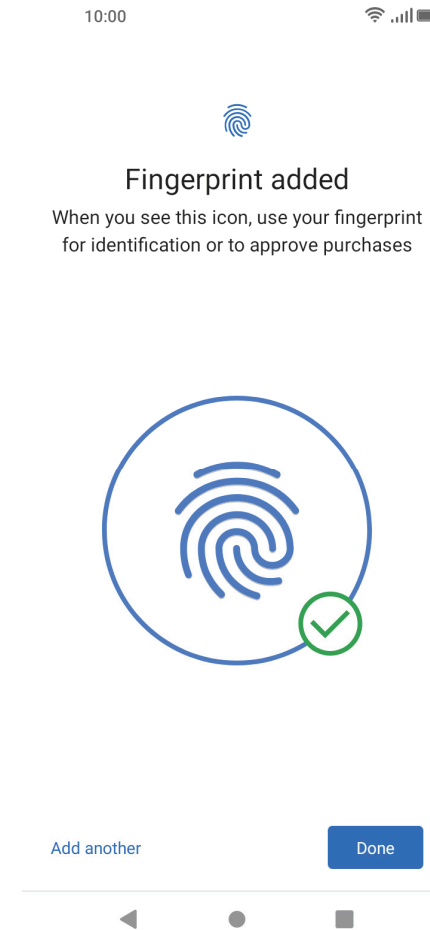
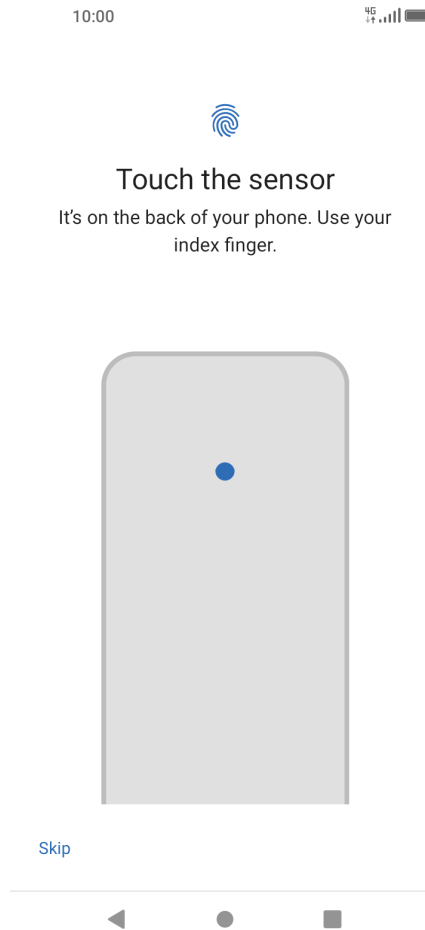
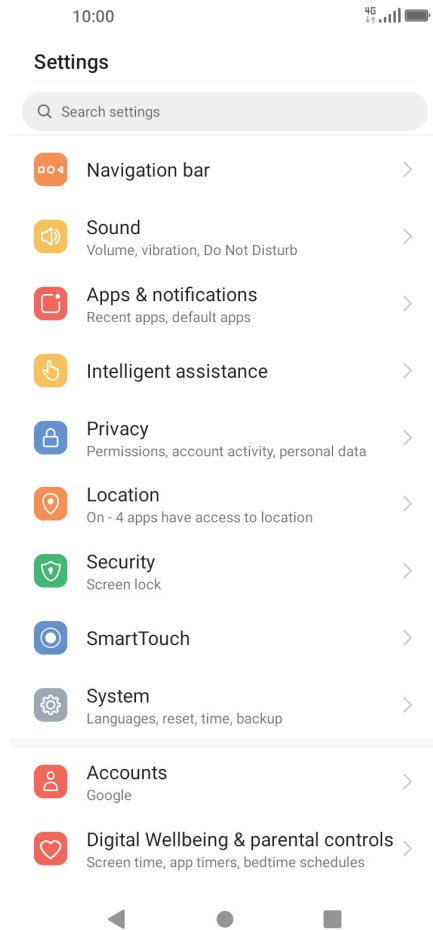

## ■ **FCC Regulations:**

This mobile phone complies with part 15 of the FCC Rules. Operation is subject to the following two conditions: (1) This device may not cause harmful interference, and (2) this device must accept any interference received, including interference that may cause undesired operation.

This mobile phone has been tested and found to comply with the limits for a Class B digital device, pursuant to Part 15 of the FCC Rules. These limits are designed to provide reasonable protection against harmful interference in a residential installation. This equipment generates, uses and can radiated radio frequency energy and, if not installed and used in accordance with the instructions, may cause harmful interference to radio communications. However, there is no guarantee that interference will not occur in a particular installation. If this equipment does cause harmful interference to radio or television reception, which can be determined by turning the equipment off and on, the user is encouraged to try to correct the interference by one or more of the following measures:

- Reorient or relocate the receiving antenna.
- Increase the separation between the equipment and receiver.
- Connect the equipment into an outlet on a circuit different from that to which the receiver is connected.
- Consult the dealer or an experienced radio/TV technician for help.

Changes or modifications not expressly approved by the party responsible for compliance could

void the user's authority to operate the equipment.

The antenna(s) used for this transmitter must not be co-located or operating in conjunction with any other antenna or transmitter.

## ▶ **RF Exposure Information (SAR)**

This mobile phone meets the government's requirements for exposure to radio waves.

This phone is designed and manufactured not to exceed the emission limits for exposure to radio frequency (RF) energy set by the Federal Communications Commission of the U.S. Government.

The exposure standard for wireless mobile phones employs a unit of measurement known as the Specific Absorption Rate, or SAR. The SAR limit set by the FCC is 1.6W/kg. \*Tests for SAR are conducted using standard operating positions accepted by the FCC with the phone transmitting at its highest certified power level in all tested frequency bands. Although the SAR is determined at the highest certified power level, the actual SAR level of the phone while operating can be well below the maximum value. This is because the phone is designed to operate at multiple power levels so as to use only the power required to reach the network. In general, the closer you are to a wireless base station antenna, the lower the power output.

The highest SAR value for the model phone as reported to the FCC when tested for use at the ear is 0.35W/kg and when worn on the body, as described in this user guide, is 0.78W/kg

(Body-worn measurements differ among phone models, depending upon available accessories and FCC requirements.)

While there may be differences between the SAR levels of various phones and at various positions, they all meet the government requirement.

The FCC has granted an Equipment Authorization for this model phone with all reported SAR levels evaluated as in compliance with the FCC RF exposure guidelines. SAR information on this model phone is on file with the FCC and can be found under the Display Grant section of [www.fcc.gov/oet/ea/fccid](http://www.fcc.gov/oet/ea/fccid) after searching on FCC ID: YHLBLUG91

For body worn operation, this phone has been tested and meets the FCC RF exposure guidelines for use with an accessory that contains no metal and the positions the handset a minimum of 1.0 cm from the body. Use of other accessories may not ensure compliance with FCC RF exposure guidelines. If you do not use a body-worn accessory and are not holding the phone at the ear, position the handset a minimum of 1.0 cm from your body when the phone is switched on.