



TEST REPORT

APPLICANT : BLU Products, Inc.
PRODUCT NAME : Smart Phone
MODEL NAME : G71L
BRAND NAME : BLU
FCC ID : YHLBLUG71L
STANDARD(S) : FCC 47 CFR Part 2(2.1093)
IEEE 1528-2013
RECEIPT DATE : 2021-12-27
TEST DATE : 2022-01-05 to 2022-01-22
ISSUE DATE : 2022-02-07

Edited by : Gan Yueming
Gan Yueming (Rapporteur)

Approved by: Shen Junsheng
Shen Junsheng (Supervisor)

NOTE: This document is issued by Shenzhen Morlab Communications Technology Co., the test report shall not be reproduced except in full without prior written permission of the company. The test results apply only to the particular sample(s) tested and to the specific tests carried out which is available on request for validation and information confirmed at our website.





DIRECTORY

- 1. SAR Results Summary 5
- 2. Technical Information 6
 - 2.1. Applicant and Manufacturer Information 6
 - 2.2. Equipment under Test (EUT) Description 6
 - 2.3. Environment of Test Site/Conditions 8
- 3. Specific Absorption Rate (SAR) 9
 - 3.1. Introduction 9
 - 3.2. SAR Definition 9
- 4. RF Exposure Limits 10
 - 4.1. Uncontrolled Environment 10
 - 4.2. Controlled Environment 10
- 5. Applied Reference Documents 11
- 6. SAR Measurement System 12
 - 6.1. E-Field Probe 13
 - 6.2. Data Acquisition Electronics (DAE) 14
 - 6.3. Robot 14
 - 6.4. Measurement Server 15
 - 6.5. Light Beam Unit 15
 - 6.6. Phantom 15
 - 6.7. Device Holder 16
 - 6.8. Data Storage and Evaluation 17
 - 6.9. Test Equipment List 19
- 7. Tissue Simulating Liquids 21
- 8. SAR System Verification 23
 - 8.1. Purpose of System Performance check 23
 - 8.2. System Setup 23



8.3. Validation Results 24

9. EUT Testing Position 26

9.1. Handset Reference Points 26

9.2. Positioning for Cheek / Touch 27

9.3. Positioning for Ear / 15° Tilt 28

9.4. SAR Evaluation near the Mouth/Jaw Regions of the Phantom 28

9.5. Body-worn Configurations 29

9.6. Hotspot Mode Exposure Position Conditions 29

10. Measurement Procedures 30

10.1. Spatial Peak SAR Evaluation 30

10.2. Power Reference Measurement 31

10.3. Area Scan Procedures 31

10.4. Zoom Scan Procedures 31

10.5. SAR Averaged Methods 32

10.6. Power Drift Monitoring 32

11. SAR Test Procedure 33

11.1. General Scan Requirements 33

11.2. Test Procedure 34

11.3. Description of Interpolation/Extrapolation Scheme 34

11.4. Wireless Router 34

12. SAR Test Configuration 36

13. Conducted Power List 48

14. Hotspot Mode Evaluation Procedure 48

15. Block Diagram of the Tests to be Performed 50

15.1. Head 50

15.2. Body 51

16. Test Results List 52

16.1. Test Guidance 52



16.2. Head SAR Data 53

16.3. Body SAR Data 57

16.4. Repeated SAR Assessment 61

17. Simultaneous Transmission Evaluation 62

17.1. Simultaneous Transmission Consideration 62

17.2. Simultaneous Transmission Analysis 63

18. Uncertainty Assessment 67

Annex A General Information 68

Annex B Test Setup Photos

Annex C Plots of System Performance Check

Annex D Plots of Maximum SAR Test Results

Annex E Conducted Power

Annex F DASY Calibration Certificate

Changed History		
Version	Date	Reason for Change
1.0	2022-02-07	First edition



1. SAR Results Summary

The maximum results of Specific Absorption Rate (SAR) found during test as bellows:

<Highest Reported SAR Summary>

Frequency Band		Highest SAR Summary			
		Head (Gap 0mm)	Body-worn (Gap 10mm)	Hotspot (Gap 10mm)	Extremity (Gap 0mm)
		1g SAR (W/kg)			10g SAR (W/kg)
GSM	GSM850	0.069	0.177	0.267	N/A
	GSM1900	0.119	0.483	0.809	N/A
WCDMA	WCDMA II	0.03	0.113	0.332	N/A
	WCDMA IV	0.12	0.256	0.683	N/A
	WCDMA V	0.049	0.145	0.145	N/A
LTE	LTE Band 2	0.081	0.261	0.660	N/A
	LTE Band 4	0.142	0.781	1.367	N/A
	LTE Band 5	0.039	0.075	0.284	N/A
	LTE Band 7	0.098	0.188	0.413	N/A
	LTE Band 12	0.148	0.407	0.407	N/A
	LTE Band 17	0.171	0.454	0.454	N/A
	LTE Band 66	0.152	0.366	0.729	N/A
WLAN	2.4GHz WLAN	0.365	0.259	0.259	N/A
2.4GHz Band	Bluetooth	N/A	0.159	0.159	N/A

Highest Simultaneous Transmission SAR _{1g} (W/Kg):	1.367 W/kg	Limit(W/kg): 1.6 W/kg
---	------------	-----------------------

Note:

1. This device is in compliance with Specific Absorption Rate (SAR) for general population or uncontrolled exposure limits (1.6W/kg as averaged over any 1 gram of tissue; specified in FCC 47 CFR part 1 (1.1310) and IEEE C95.1-1991), and had been tested in accordance with the measurement methods and procedures specified in IEEE 1528-2013 and FCC KDB publications.
2. When the test result is a critical value, we will use the measurement uncertainty give the judgment result based on the 95% confidence intervals.



2. Technical Information

Note: Provide by applicant.

2.1. Applicant and Manufacturer Information

Applicant:	BLU Products, Inc.
Applicant Address:	10814 NW 33rd St # 100 Doral, FL 33172,USA
Manufacturer:	BLU Products, Inc.
Manufacturer Address:	10814 NW 33rd St # 100 Doral, FL 33172,USA

2.2. Equipment under Test (EUT) Description

Product Name:	Smart Phone
IMEI:	867400020316612/01 867400020316620/01
Hardware Version:	V4.0
Software Version:	BLU_G0710WW_V11.0.01.01_GENERIC 16-12-2021 01:35
Frequency Bands:	GSM 850: 824 MHz ~ 849 MHz GSM 1900: 1850 MHz ~ 1910 MHz WCDMA Band II: 1850 MHz ~ 1910 MHz WCDMA Band IV: 1710 MHz ~ 1755 MHz WCDMA Band V: 824 MHz ~ 849 MHz LTE Band 2: 1850 MHz ~ 1910 MHz LTE Band 4: 1710 MHz ~ 1755 MHz LTE Band 5: 824 MHz ~ 849 MHz LTE Band 7: 2500 MHz ~ 2570 MHz LTE Band 12: 699 MHz ~ 716 MHz LTE Band 17: 704 MHz ~ 716 MHz LTE Band 66: 1710 MHz ~ 1780 MHz WLAN 2.4GHz: 2412 MHz ~ 2472 MHz Bluetooth: 2402 MHz ~ 2480 MHz
Modulation Mode:	GSM/GPRS: GMSK EDGE: 8PSK WCDMA: QPSK, 16QAM LTE: QPSK, 16QAM, 64QAM 802.11b: DSSS 802.11g/n-HT20: OFDM BR+EDR: GFSK(1Mbps), $\pi/4$ -DQPSK(2Mbps), 8-DPSK(3Mbps)



	Bluetooth LE: GFSK(1Mbps)	
Multi-slot Class:	GPRS: Multi-slot Class 12 EDGE: Multi-slot Class 12	
Operation Class:	Class B	
Hotspot Mode:	Support	
Antenna Type:	WWAN: Fixed Internal Antenna WLAN: PIFA Antenna Bluetooth: PIFA Antenna	
SIM Cards Description:	SIM 1	GSM+WCDMA+LTE
	SIM 2	GSM+WCDMA+LTE

Note: For more detailed description, please refer to specification or user manual supplied by the applicant and/or manufacturer.



2.3. Environment of Test Site/Conditions

Normal Temperature (NT):	20-25 °C
Relative Humidity:	30-75 %
Air Pressure:	980-1020 hPa

Test Frequency:	GSM 850MHz/1900MHz WCDMA Band II/IV/V FDD-LTE Band 2/4/5/7/12/17/66 WLAN 2.4GHz Bluetooth
Operation Mode:	Call established
Power Level:	GSM 850 MHz Maximum output power(level 5) GSM 1900MHz Maximum output power(level 0) WCDMA Band II/IV/V (All Up Bits) FDD-LTE Band 2/4/5/7/12/17/66 (Maximum output power) WLAN 2.4GHz Bluetooth

During SAR test, EUT is in Traffic Mode (Channel Allocated) at Normal Voltage Condition. A communication link is set up with a System Simulator (SS) by air link, and a call is established.

The EUT shall use its internal transmitter. The antenna(s), battery and accessories shall be those specified by the Factory. The EUT battery must be fully charged and checked periodically during the test to ascertain uniform power output. If a wireless link is used, the antenna connected to the output of the base station simulator shall be placed at least 50 cm away from the handset.

The signal transmitted by the simulator to the antenna feeding point shall be lower than the output power level of the handset by at least 35 dB.

3. Specific Absorption Rate (SAR)

3.1. Introduction

SAR is related to the rate at which energy is absorbed per unit mass in an object exposed to a radio field. The SAR distribution in a biological body is complicated and is usually carried out by experimental techniques or numerical modeling. The standard recommends limits for two tiers of groups, occupational or controlled and general population or uncontrolled, based on a person's awareness and ability to exercise control over his or her exposure. In general, occupational or controlled exposure limits are Middle than the limits for general population or uncontrolled.

3.2. SAR Definition

The SAR definition is the time derivative (rate) of the incremental energy (dW) absorbed by(dissipated in) an incremental mass (dm) contained in a volume element (dv) of a given density. (ρ). The equation description is as below:

$$\text{SAR} = \frac{d}{dt} \left(\frac{dW}{dm} \right) = \frac{d}{dt} \left(\frac{dW}{\rho dv} \right)$$

SAR is expressed in units of Watts per kilogram (W/kg).

SAR measurement can be either related to the temperature elevation in tissue by,

$$\text{SAR} = C \left(\frac{\delta T}{\delta t} \right)$$

Where C is the specific head capacity, δT is the temperature rise and δt the exposure duration, or related to the electrical field in the tissue by

$$\text{SAR} = \frac{\sigma |E|^2}{\rho}$$

Where ζ is the conductivity of the tissue, ρ is the mass density of the tissue and $|E|$ is the rmselectrical field strength.

However for evaluating SAR of low power transmitter, electrical field measurement is typically applied.



4. RF Exposure Limits

4.1. Uncontrolled Environment

Uncontrolled Environments are defined as locations where there is the exposure of individuals who have no knowledge or control of their exposure. The general population/uncontrolled exposure limits are applicable to situations in which the general public may be exposed or in which persons who are exposed as a consequence of their employment may not be made fully aware of the potential for exposure or cannot exercise control over their exposure. Members of the general public would come under this category when exposure is not employment-related; for example, in the case of a wireless transmitter that exposes persons in its vicinity.

4.2. Controlled Environment

Controlled Environments are defined as locations where there is exposure that may be incurred by persons who are aware of the potential for exposure, (i.e. as a result of employment or occupation). In general, occupational/controlled exposure limits are applicable to situations in which persons are exposed as a consequence of their employment, who have been made fully aware of the potential for exposure and can exercise control over their exposure. The exposure category is also applicable when the exposure is of a transient nature due to incidental passage through a location where the exposure levels may be higher than the general population/uncontrolled limits, but the exposed person is fully aware of the potential for exposure and can exercise control over his or her exposure by leaving the area or by some other appropriate means.

Limits for General Population/Uncontrolled Exposure (W/kg)

Type Exposure	Uncontrolled Environment Limit
Spatial Peak SAR (1g cube tissue for head and trunk)	1.6 W/kg
Spatial Peak SAR (10g cube tissue for limbs)	4.0 W/kg
Spatial Peak SAR (1g cube tissue for whole body)	0.08 W/kg

Note:

- Occupational/Uncontrolled Environments are defined as locations where there is exposure that may be incurred by people who are aware of the potential for exposure (i.e. as a result of employment or occupation).
- Whole-Body SAR is averaged over the entire body, partial-body SAR is averaged over any 1gram of tissue defined as a tissue volume in the shape of a cube. SAR for hands, wrists, feet and ankles is averaged over any 10 grams of tissue defined as a tissue volume in the shape of a cube.

5. Applied Reference Documents

Leading reference documents for testing:

Identity	Document Title	Method Determination /Remark
FCC 47CFR Part 2(2.1093)	Radio Frequency Radiation Exposure Evaluation: Portable Devices	No deviation
IEEE 1528-2013	IEEE Recommended Practice for Determining the Peak Spatial-Average Specific Absorption Rate (SAR) in the Human Head from Wireless Communications Devices: Measurement Techniques	No deviation
KDB 447498 D01v06	General RF Exposure Guidance	No deviation
KDB 248227 D01v02r02	SAR Measurement Procedures for 802.11 Transmitters	No deviation
KDB 865664 D01v01r04	SAR Measurement 100 MHz to 6 GHz	No deviation
KDB 865664 D02v01r02	RF Exposure Reporting	No deviation
KDB 648474 D04v01r03	Handset SAR	No deviation
KDB 941225 D01v03r01	3G SAR MEAUREMENT PROCEDURES	No deviation
KDB 941225 D05v02r05	SAR Evaluation Consideration for LTE Devices	No deviation
KDB 941225 D06v02r01	SAR Evaluation Procedures For Portable Devices With Wireless Router Capabilities	No deviation

Note 1: The test item is not applicable.

Note 2: Additions to, deviation, or exclusions from the method shall be judged in the "method determination" column of add, deviate or exclude from the specific method shall be explained in the "Remark" of the above table.

6. SAR Measurement System

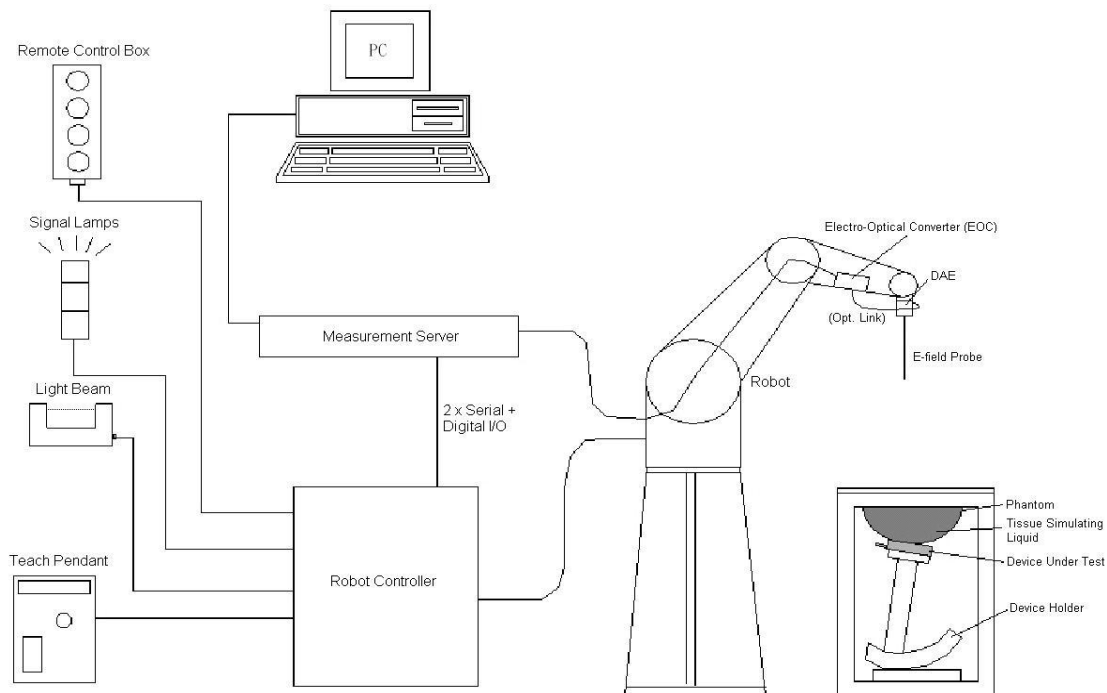

Fig 6.1 SPEAG DASY System Configurations

The DASY system for performance compliance tests is illustrated above graphically. This system consists of the following items:

- A standard high precision 6-axis robot with controller, a teach pendant and software.
- A data acquisition electronic (DAE) attached to the robot arm extension.
- A dosimetric probe equipped with an optical surface detector system.
- The electro-optical converter (ECO) performs the conversion between optical and electrical signals
- A measurement server performs the time critical tasks such as signal filtering, control of the robot operation and fast movement interrupts.
- A probe alignment unit which improves the accuracy of the probe positioning.
- A computer operating Windows XP.
- DASY software.
- Remote control with teach pendant and additional circuitry for robot safety such as warning lamps, etc.
- The SAM twin phantom.
- A device holder.
- Tissue simulating liquid.
- Dipole for evaluating the proper functioning of the system.
- Some of the components are described in details in the following sub-sections.

6.1. E-Field Probe

The SAR measurement is conducted with the dosimetric probe (manufactured by SPEAG). The probe is specially designed and calibrated for use in liquid with high permittivity. The dosimetric probe has special calibration in liquid at different frequency. This probe has a built in optical surface detection system to prevent from collision with phantom.

➤ E-Field Probe Specification

<ES3DV3 Probe>

Construction	Symmetrical design with triangular core Built-in optical fiber for surface detection system. Built-in shielding against static charges. PEEK enclosure material (resistant to organic solvents, e.g., DGBE)	 <p>Fig 6.2 Photo of ES3DV3</p>
Frequency	10 MHz to 3 GHz; Linearity: ± 0.2 dB	
Directivity	± 0.2 dB in HSL (rotation around probe axis) ± 0.4 dB in HSL (rotation normal to probe axis)	
Dynamic Range	5 μ W/g to 100 mW/g; Linearity: ± 0.2 dB	
Dimensions	Overall length: 330 mm (Tip: 16 mm) Tip diameter: 6.8 mm (Body: 12 mm) Distance from probe tip to dipole centers: 2.7 mm	

<EX3DV4 Probe>

Construction	Symmetrical design with triangular core Built-in shielding against static charges PEEK enclosure material (resistant to organic solvents, e.g., DGBE)	 <p>Fig 6.3 Photo of EX3DV4</p>
Frequency	10 MHz to 6 GHz; Linearity: ± 0.2 dB	
Directivity	± 0.3 dB in HSL (rotation around probe axis) ± 0.5 dB in tissue material (rotation normal to probe axis)	
Dynamic Range	10 μ W/g to 100 mW/g; Linearity: ± 0.2 dB	
Dimensions	Overall length: 330 mm (Tip: 20 mm) Tip diameter: 2.5 mm (Body: 12 mm) Typical distance from probe tip to dipole centers: 1 mm	

➤ E-Field Probe Calibration

Each probe needs to be calibrated according to a dosimetric assessment procedure with accuracy better than $\pm 10\%$. The spherical isotropy shall be evaluated and within ± 0.25 dB. The sensitivity parameters (NormX, NormY, and NormZ), the diode compression parameter (DCP) and the conversion factor (ConvF) of the probe are tested. The calibration data can be referred to appendix C of this report.

6.2. Data Acquisition Electronics (DAE)

The data acquisition electronics (DAE) consists of a highly sensitive electrometer-grade preamplifier with auto-zeroing, a channel and gain-switching multiplexer, a fast 16 bit AD-converter and a command decoder and control logic unit. AD-converter and a command decoder and control logic unit. Transmission to the measurement server is accomplished through an optical downlink for data and status information as well as an optical uplink for commands and the clock. The input impedance of the DAE is 200M Ω ; the inputs are symmetrical and floating. Common mode rejection is above 80 dB.



Fig 6.4 Photo of DAE

6.3. Robot

The SPEAG DASY system uses the high precision robots (DASY4: RX90BL; DASY5: TX90XL) type from Stäubli SA (France). For the 6-axis controller system, the robot controller version (DASY4: CS7MB; DASY5: CS8c) from Stäubli is used. The Stäubli robot series have many features that are important for our application:

High precision (repeatability ± 0.035 mm)

High reliability (industrial design)

Jerk-free straight movements

Low ELF interference (the closed metallic construction shields against motor control fields)



Fig 6.5 Photo of DASY5

6.4. Measurement Server

The measurement server is based on a PC/104 CPU board with CPU (DASY4: 166 MHz, Intel Pentium; DASY5: 400 MHz, Intel Celeron), chip disk (DASY4: 32 MB; DASY5: 128 MB), RAM (DASY4: 64 MB, DASY5: 128 MB). The necessary circuits for communication with the DAE electronic box, as well as the 16 bit AD converter system for optical detection and digital I/O interface are contained on the DASY I/O board, which is directly connected to the PC/104 bus of the CPU board. The measurement server performs all the real-time data evaluation for field measurements and surface detection, controls robot movements and handles safety operations.



Fig 6.6 Photo of Server for DASY5

6.5. Light Beam Unit

The light beam switch allows automatic "tooling" of the probe. During the process, the actual position of the probe tip with respect to the robot arm is measured, as well as the probe length and the horizontal probe offset. The software then corrects all movements, such that the robot coordinates are valid for the probe tip.

The repeatability of this process is better than 0.1 mm. If a position has been taught with an aligned probe, the same position will be reached with another aligned probe within 0.1 mm, even if the other probe has different dimensions. During probe rotations, the probe tip will keep its actual position.



Fig. 6.7 Photo of Light Beam

6.6. Phantom

<SAM Twin Phantom>

Shell Thickness	2 ± 0.2 mm (sagging: <1%) Center ear point: 6 ± 0.2 mm
Filling Volume	Approx. 25 liters
Dimensions	Length: 1000 mm; Width: 500 mm; Height: adjustable feet
Measurement Areas	Left Head, Right Head, Flat Phantom



Fig. 6.8 Photo of SAM Phantom

The bottom plate contains three pair of bolts for locking the device holder. The device holder positions are adjusted to the standard measurement positions in the three sections. A white cover is provided to tap the phantom during off-periods to prevent water evaporation and changes in the liquid parameters. On the phantom top, three reference markers are provided to identify the phantom position with respect to the robot.

6.7. Device Holder

<Device Holder for SAM Twin Phantom>

The SAR in the phantom is approximately inversely proportional to the square of the distance between the source and the liquid surface. For a source at 5 mm distance, a positioning uncertainty of ± 0.5 mm would produce a SAR uncertainty of ± 20 %. Accurate device positioning is therefore crucial for accurate and repeatable measurements. The positions in which the devices must be measured are defined by the standards.

The DASY device holder is designed to cope with different positions given in the standard. It has two scales for the device rotation (with respect to the body axis) and the device inclination (with respect to the line between the ear reference points). The rotation center for both scales is the ear reference point (EPR). Thus the device needs no repositioning when changing the angles.

The DASY device holder is constructed of low-loss POM material having the following dielectric parameters: relative permittivity $\epsilon = 3$ and loss tangent $\delta = 0.02$. The amount of dielectric material has been reduced in the closest vicinity of the device, since measurements have suggested that the influence of the clamp on the test results could thus be lowered.

<Laptop Extension Kit>

The extension is lightweight and made of POM, acrylic glass and foam. It fits easily on the upper part of the mounting device in place of the phone positioned. The extension is fully compatible with the SAM Twin and ELI phantoms.



Fig 6.9 Device Holder

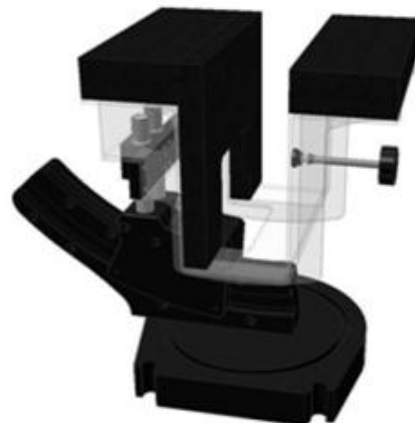

Fig 6.10 Laptop Extension Kit



6.8. Data Storage and Evaluation

➤ Data Storage

The DASY software stores the assessed data from the data acquisition electronics as raw data (in microvolt readings from the probe sensors), together with all the necessary software parameters for the data evaluation (probe calibration data, liquid parameters and device frequency and modulation data) in measurement files. The post-processing software evaluates the desired unit and format for output each time the data is visualized or exported. This allows verification of the complete software setup even after the measurement and allows correction of erroneous parameter settings. For example, if a measurement has been performed with an incorrect crest factor parameter in the device setup, the parameter can be corrected afterwards and the data can be reevaluated.

The measured data can be visualized or exported in different units or formats, depending on the selected probe type (e.g., [V/m], [A/m], [mW/g]). Some of these units are not available in certain situations or give meaningless results, e.g., a SAR-output in a non-lose media, will always be zero. Raw data can also be exported to perform the evaluation with other software packages.

➤ Data Evaluation

The DASY post-processing software (SEMCAD) automatically executes the following procedures to calculate the field units from the microvolt readings at the probe connector. The parameters used in the evaluation are stored in the configuration modules of the software.

Probe parameters:	- Sensitivity	$Norm_i, a_{i0}, a_{i1}, a_{i2}$
	- Conversion factor	$ConvF_i$
	- Diode compression point	$dcpi$
Device parameters:	- Frequency	f
	- Crest factor	cf
Media parameters:	- Conductivity	ζ
	- Density	ρ

These parameters must be set correctly in the software. They can be found in the component documents or they can be imported into the software from the configuration files issued for the DASY components. In the direct measuring mode of the multi-meter option, the parameters of the actual system setup are used. In the scan visualization and export modes, the parameters stored in the corresponding document files are used.

The first step of the evaluation is a linearization of the filtered input signal to account for the compression characteristics of the detector diode. The compensation depends on the input signal, the diode type and the DC-transmission factor from the diode to the evaluation electronics. If the



exciting field is pulsed, the crest factor of the signal must be known to correctly compensate for peak power.

The formula for each channel can be given as:

$$V_i = U_i + U_i^2 \times \frac{cf}{dcp_i}$$

With V_i = compensated signal of channel i , ($i = x, y, z$)
 U_i = input signal of channel i , ($i = x, y, z$)
 cf = crest factor of exciting field (DASY parameter)
 dcp_i = diode compression point (DASY parameter)

From the compensated input signals, the primary field data for each channel can be evaluated:

$$\text{E-field Probes: } E_i = \sqrt{\frac{V_i}{\text{Norm}_i \times \text{ConvF}}}$$

$$\text{H-field Probes: } H_i = \sqrt{V_i} \times \frac{a_{i0} + a_{i1} + a_{i2} f^2}{f}$$

With V_i = compensated signal of channel i , ($i = x, y, z$)
 Norm_i = sensor sensitivity of channel i , ($i = x, y, z$), $\mu\text{V}/(\text{V}/\text{m})^2$ for E-field
 Probes ConvF = sensitivity enhancement in solution
 a_{ij} = sensor sensitivity factors for H-field probes
 f = carrier frequency [GHz]
 E_i = electric field strength of channel i in V/m
 H_i = magnetic field strength of channel i in A/m

The RSS value of the field components gives the total field strength (Hermitian magnitude):

$$E_{\text{tot}} = \sqrt{E_x^2 + E_y^2 + E_z^2}$$

The primary field data are used to calculate the derived field units.

$$\text{SAR} = E_{\text{tot}}^2 \times \frac{\sigma}{\rho \times 1000}$$

with SAR = local specific absorption rate in mW/g

E_{tot} = total field strength in V/m

ζ = conductivity in [mho/m] or [Siemens/m]

ρ = equivalent tissue density in g/cm^3

Note that the density is set to 1, to account for actual head tissue density rather than the density of the tissue simulating liquid.



6.9. Test Equipment List

Manufacturer	Name of Equipment	Type/Model	Serial Number	Calibration	
				Last Cal.	Due Date
SPEAG	750MHz System Validation Kit	D750V3	1173	2021.06.21	2024.06.20
SPEAG	900MHz System Validation Kit	D900V2	1d064	2021.12.17	2024.12.16
SPEAG	1800MHz System Validation Kit	D1800V2	2d158	2021.12.17	2024.12.16
SPEAG	2000MHz System Validation Kit	D2000V2	1050	2021.12.18	2024.12.17
SPEAG	2450MHz System Validation Kit	D2450V2	805	2021.12.17	2024.12.16
SPEAG	2600MHz System Validation Kit	D2600V2	1139	2021.06.25	2024.06.24
SPEAG	DOSIMETRIC ASSESSMENT SYSTEM	DASY52	52.10.4.1527	NCR	NCR
SPEAG	Dosimetric E-Field Probe	EX3DV4	3753	2021.07.26	2022.07.25
SPEAG	Data Acquisition Electronics	DAE4	1353	2021.10.19	2022.10.1
SPEAG	Dielectric Assessment KIT	DAK-3.5	1279	2021.11.03	2022.11.02
SPEAG	SAM 2	QD000P40CC	1464	NCR	NCR
SPEAG	Phone Positioner	N/A	N/A	NCR	NCR
R&S	Network Emulator	CMW500	165755	2021.02.25	2022.02.24
Agilent	Network Analyzer	E5071B	MY42404762	2021.03.29	2022.03.28
mini-circuits	Amplifier	ZHL-42W+	608501717	NCR	NCR
Agilent	Signal Generator	N5182B	MY53050509	2021.03.25	2022.03.24
Agilent	Power Sensor	N8482A	MY41090849	2021.10.21	2022.10.20
Agilent	Power Meter	E4416A	MY45102093	2021.10.21	2022.10.20
Anritsu	Power Sensor	MA2411B	N/A	2021.10.21	2022.10.20
Anritsu	Power Meter	NRVD	101066	2021.10.21	2022.10.20
Agilent	Dual Directional Coupler	778D	50422	NA	NA
MCL	Attenuation1	351-218-010	N/A	NA	NA
KTJ	Thermo meter	TA298	N/A	2021.12.21	2022.12.20
SPEAG	Tissue Simulating Liquids	HBBL600-10000V6		24H	

Note:

1. The calibration certificate of DASY can be referred to appendix E of this report.
2. The Insertion Loss calibration of Dual Directional Coupler and Attenuator were characterized via the network analyzer and compensated during system check.
3. The dielectric probe kit was calibrated via the network analyzer, with the specified procedure (calibrated in pure water) and calibration kit (standard) short circuit, before the dielectric measurement. The specific procedure and calibration kit are provided by Speag.



4. In system check we need to monitor the level on the power meter, and adjust the power amplifier level to have precise power level to the dipole; the measured SAR will be normalized to 1W input power according to the ratio of 1W to the input power to the dipole. For system check, the calibration of the power amplifier is deemed not critically required for correct measurement; the power meter is critical and we do have calibration for it.
5. Attenuator insertion loss is calibrated by the network Analyzer, which the calibration is valid, before system check.
6. N.C.R means No Calibration Requirement.

7. Tissue Simulating Liquids

For SAR measurement of the field distribution inside the phantom, the phantom must be filled with homogeneous tissue simulating liquid to a depth of at least 15cm. For head SAR testing, the liquid height from the ear reference point (ERP) of the phantom to the liquid top surface is larger than 15cm. For body SAR testing, the liquid height from the center of the flat phantom to the liquid top surface is larger than 15cm, which is shown in Fig. 7.1. For body SAR testing, the liquid height from the center of the flat phantom to the liquid top surface is larger than 15 cm, which is shown in Fig. 7.2. The nominal dielectric values of the tissue simulating liquids in the phantom and the tolerance of 5% are listed in below table.

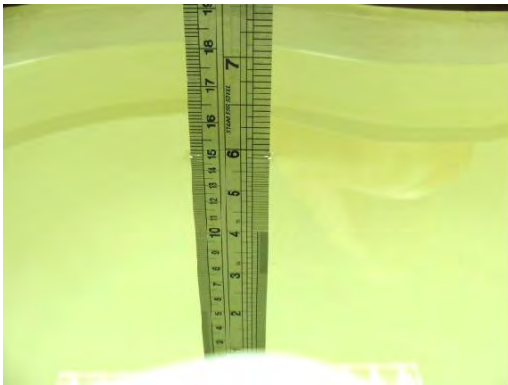

Fig 7.1 Photo of Liquid Height for Head SAR



Fig 7.2 Photo of Liquid Height for Body SAR

The following table gives the recipes for tissue simulating liquids

Frequency (MHz)	Water (%)	Sugar (%)	Cellulose (%)	Salt (%)	Preventol (%)	DGBE (%)	Conductivity (ζ)	Permittivity (εr)
Head								
750	41.1	57.0	0.2	1.4	0.2	0	0.89	41.9
835	40.3	57.9	0.2	1.4	0.2	0	0.90	41.5
1800,1900,2000	55.2	0	0	0.3	0	44.5	1.40	40.0
2450	55.0	0	0	0	0	45.0	1.80	39.2
2600	54.8	0	0	0.1	0	45.1	1.96	39.0
Body								
750	51.7	47.2	0	0.9	0.1	0	0.96	55.5
835	50.8	48.2	0	0.9	0.1	0	0.97	55.2
1800,1900,2000	70.2	0	0	0.4	0	29.4	1.52	53.3
2450	68.6	0	0	0	0	31.4	1.95	52.7
2600	68.1	0	0	0.1	0	31.8	2.16	52.5

Simulating Liquid for 5GHz, Manufactured by SPEAG.

Ingredients	(% by weight)
Water	64~78%
Mineral oil	11~18%
Emulsifiers	9~15%
Additives and Salt	2~3%



Note: Please refer to the validation results for dielectric parameters of each frequency band. The dielectric properties of the tissue simulating liquids were verified prior to the SAR evaluation using a SPEAG Dielectric Assessment KIT and an Agilent Network Analyzer.

Table 1: Dielectric Performance of Tissue Simulating Liquid

Frequency (MHz)	Tissue Type	Liquid Temp.(°C)	Conductivity (σ)	Conductivity Target (σ)	Delta (σ) (%)	Limit (%)	Date
750	HSL	22.1	0.875	0.89	-1.69	± 5	2022.1.8
900	HSL	22.2	0.964	0.97	-0.62	± 5	2022.1.5
1800	HSL	22.2	1.411	1.40	0.79	± 5	2022.1.12
2000	HSL	22.1	1.414	1.40	1.00	± 5	2022.1.15
2450	HSL	22.3	1.773	1.80	-1.50	± 5	2022.1.18
2600	HSL	22.1	1.923	1.96	-1.89	± 5	2022.1.22

Frequency (MHz)	Tissue Type	Liquid Temp.(°C)	Permittivity (ϵ_r)	Permittivity Target (ϵ_r)	Delta (ϵ_r) (%)	Limit (%)	Date
750	HSL	22.1	40.824	41.90	-2.57	± 5	2022.1.8
900	HSL	22.2	41.564	41.50	0.15	± 5	2022.1.5
1800	HSL	22.2	40.374	40.00	0.94	± 5	2022.1.12
2000	HSL	22.1	40.176	40.00	0.44	± 5	2022.1.15
2450	HSL	22.3	39.446	39.20	0.63	± 5	2022.1.18
2600	HSL	22.1	38.947	39.00	-0.14	± 5	2022.1.22

8. SAR System Verification

Each DASY system is equipped with one or more system validation kits. These units, together with the predefined measurement procedures within the DASY software, enable the user to conduct the system performance check and system validation. System validation kit includes a dipole, tripod holder to fix it underneath the flat phantom and a corresponding distance holder.

8.1. Purpose of System Performance check

The system performance check verifies that the system operates within its specifications. System and operator errors can be detected and corrected. It is recommended that the system performance check be performed prior to any usage of the system in order to guarantee reproducible results. The system performance check uses normal SAR measurements in a simplified setup with a well characterized source. This setup was selected to give a high sensitivity to all parameters that might fail or vary over time. The system check does not intend to replace the calibration of the components, but indicates situations where the system uncertainty is exceeded due to drift or failure.

8.2. System Setup

The output power on dipole port must be calibrated to 24 dBm (250 mW) before dipole is connected. In the simplified setup for system evaluation, the DUT is replaced by a calibrated dipole and the power source is replaced by a continuous wave which comes from a signal generator. The calibrated dipole must be placed beneath the flat phantom section of the SAM twin phantom with the correct distance holder. The distance holder should touch the phantom surface with a light pressure at the reference marking and be oriented parallel to the long side of the phantom. The system check verifies that the system operates within its specifications. It is performed daily or before every SAR measurement. The system check uses normal SAR measurements in the flat section of the phantom with a matched dipole at a specified distance. The system verification setup is shown as below.



Fig 8.1 Photo of Dipole Setup

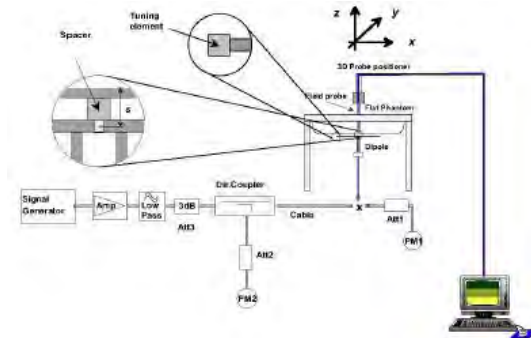

Fig 8.2 System Setup for System Evaluation



8.3. Validation Results

After system check testing, the SAR result will be normalized to 1W forward input power and compared with the reference SAR value derived from validation dipole certificate report. The deviation of system check should be within 10%.

<Validation Setup>

Frequency (MHz)	Tissue Type	Input Power(mW)	Dipole S/N	Probe S/N	DAE S/N
750	HSL	250	D750V3-1173	3753	1353
900	HSL	250	D900V2-1d064	3753	1353
1800	HSL	250	D1800V2-2d158	3753	1353
2000	HSL	250	D2000V2-1050	3753	1353
2450	HSL	250	D2450V2-805	3753	1353
2600	HSL	250	D2600V2-1139	3753	1353

<System Validation>

Frequency (MHz)	Tissue Type	Conductivity (σ)	Permittivity (ϵ_r)	CW Signal Validation		
				Sensitivity	Probe Linearity	Probe Isotropy
750	HSL	0.851	42.43	PASS	PASS	PASS
835	HSL	0.898	41.88	PASS	PASS	PASS
1750	HSL	1.386	39.91	PASS	PASS	PASS
1800	HSL	1.449	41.26	PASS	PASS	PASS
1900	HSL	1.435	39.65	PASS	PASS	PASS
2000	HSL	1.451	39.42	PASS	PASS	PASS
2300	HSL	1.764	38.99	PASS	PASS	PASS
2450	HSL	1.863	38.85	PASS	PASS	PASS
2600	HSL	1.973	38.58	PASS	PASS	PASS
5250	HSL	4.528	35.32	PASS	PASS	PASS
5600	HSL	4.905	34.89	PASS	PASS	PASS
5750	HSL	5.077	34.28	PASS	PASS	PASS



Frequency (MHz)	Tissue Type	Conductivity (σ)	Permittivity (ϵ_r)	Modulation Signal Validation		
				Mod. Type	Duty Factor	PAR
750	HSL	0.851	42.43	N/A	N/A	N/A
835	HSL	0.898	41.88	GMSK	PASS	N/A
1750	HSL	1.386	39.91	N/A	N/A	N/A
1800	HSL	1.449	41.26	N/A	N/A	N/A
1900	HSL	1.435	39.65	GMSK	PASS	N/A
2000	HSL	1.451	39.42	GMSK	PASS	N/A
2300	HSL	1.764	38.99	OFDM	PASS	PASS
2450	HSL	1.863	38.85	OFDM	PASS	PASS
2600	HSL	1.973	38.58	TDD	PASS	N/A
5250	HSL	4.528	35.32	OFDM	N/A	PASS
5600	HSL	4.905	34.89	OFDM	N/A	PASS
5750	HSL	5.077	34.28	OFDM	N/A	PASS

<Validation Results>

Date	Frequency (MHz)	Tissue Type	Input Power (mW)	Measured 1g SAR (W/kg)	Targeted 1g SAR (W/kg)	Normalized 1g SAR (W/kg)	Deviation (%)
2022.1.8	750	HSL	250	2.09	8.26	8.36	1.21
2022.1.5	900	HSL	250	2.72	11.20	10.88	-2.86
2022.1.12	1800	HSL	250	9.83	39.20	39.32	0.31
2022.1.15	2000	HSL	250	10.12	41.60	40.48	-2.69
2022.1.18	2450	HSL	250	13.05	52.30	52.2	-0.19
2022.1.22	2600	HSL	250	13.31	54.00	53.24	-1.41

Date	Frequency (MHz)	Tissue Type	Input Power (mW)	Measured 10g SAR (W/kg)	Targeted 10g SAR (W/kg)	Normalized 10g SAR (W/kg)	Deviation (%)
2022.1.8	750	HSL	250	1.35	5.45	5.4	-0.92
2022.1.5	900	HSL	250	1.74	7.19	6.96	-3.20
2022.1.12	1800	HSL	250	5.25	20.10	21	4.48
2022.1.15	2000	HSL	250	5.31	20.70	21.24	2.61
2022.1.18	2450	HSL	250	6.11	23.90	24.44	2.26
2022.1.22	2600	HSL	250	6.27	24.50	25.08	2.37

Note: System checks the specific test data please see Annex C.

9. EUT Testing Position

This EUT was tested in six different positions. They are right cheek/right tilted/left cheek/left tilted for head, Front/Back of the EUT with phantom 10 mm gap, as illustrated below, please refer to Appendix B for the test setup photos.

9.1. Handset Reference Points

The vertical centre line passes through two points on the front side of the handset – the midpoint of the width w_t of the handset at the level of the acoustic output, and the midpoint of the width w_b of the bottom of the handset.

The horizontal line is perpendicular to the vertical centre line and passes the center of the acoustic output. The horizontal line is also tangential to the handset at point A.

The two lines intersect at point A. Note that for many handsets, point A coincides with the center of the acoustic output; however, the acoustic output may be located elsewhere on the horizontal line.

Also note that the vertical centre line is not necessarily parallel to the front face of the handset, especially for clamshell handsets, handsets with flip covers, and other irregularly shaped handsets.



Fig. 9.1 Illustration for Cheek Position

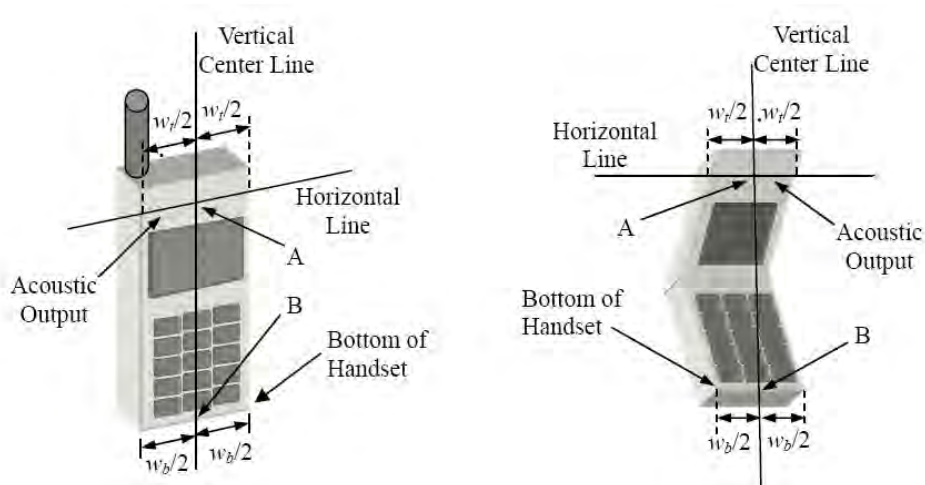

Fig. 9.2 Illustration for Handset Vertical and Horizontal Reference Lines

9.2. Positioning for Cheek / Touch

To position the device with the vertical center line of the body of the device and the horizontal line crossing the center piece in a plane parallel to the sagittal plane of the phantom. While maintaining the device in this plane, align the vertical center line with the reference plane containing the three ear and mouth reference point (M: Mouth, RE: Right Ear and LE: Left Ear) and align the center of the ear piece with the line RE-LE.

To move the device towards the phantom with the ear piece aligned with the line LE-RE until the phone touched the ear. While maintaining the device in the reference plane and maintaining the phone contact with the ear, move the bottom of the phone until any point on the front side is in contact with the cheek of the phantom or until contact with the ear is lost (see below figure)

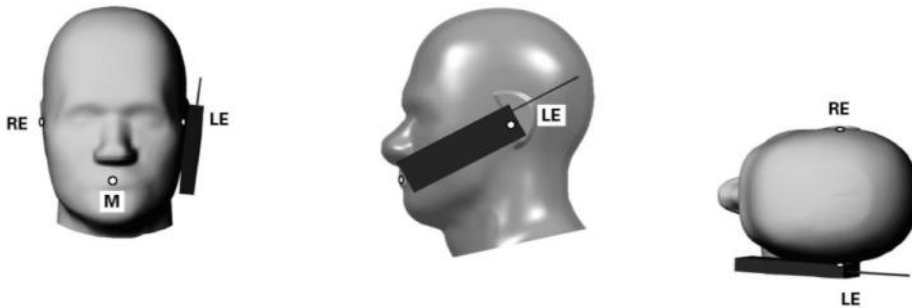

Fig 9.3 Illustration for Cheek Position

9.3. Positioning for Ear / 15° Tilt

To position the device in the “cheek” position described above.

While maintaining the device the reference plane described above and pivoting against the ear, moves it outward away from the mouth by an angle of 15 degrees or until contact with the ear is lost (see figure below).

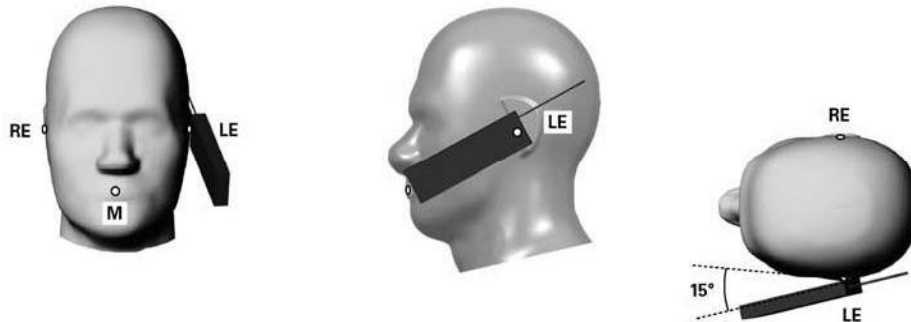

Fig 9.4 Illustration for Tilted Position

9.4. SAR Evaluation near the Mouth/Jaw Regions of the Phantom

Antennas located near the bottom of a phone may require SAR measurements around the mouth and jaw regions of the SAM head phantom. This typically applies to clam-shell style phones that are generally longer in the unfolded normal use positions or to certain older style long rectangular phones.

Under these circumstances, the following procedures apply, adopted from the FCC guidance on SAR handsets document FCC KDB Publication 648474 D04v01r03. The SAR required in these regions of SAM should be measured using a flat phantom. The phone should be positioned with a separation distance of 4 mm between the ear reference point (ERP) and the outer surface of the flat phantom shell. While maintaining this distance at the ERP location, the low (bottom) edge of the phone should be lowered from the phantom to establish the same separation distance between the peak SAR locations identified by the truncated partial SAR distribution measured with the SAM phantom. The distance from the peak SAR location to the phone is determined by the straight line passing perpendicularly through the phantom surface. When it is not feasible to maintain 4 mm separation at the ERP while also establishing the required separation at the peak SAR location, the top edge of the phone will be allowed to touch the phantom with a separation < 4 mm at the ERP. The phone should not be tilted to the left or right while placed in this inclined position to the flat phantom.

9.5. Body-worn Configurations

The body-worn configurations shall be tested with the supplied accessories (belt-clips, holsters, etc.) attached to the device in normal use configuration.

For body-worn and other configurations a flat phantom shall be used which is comprised of material with electrical properties similar to the corresponding tissues.

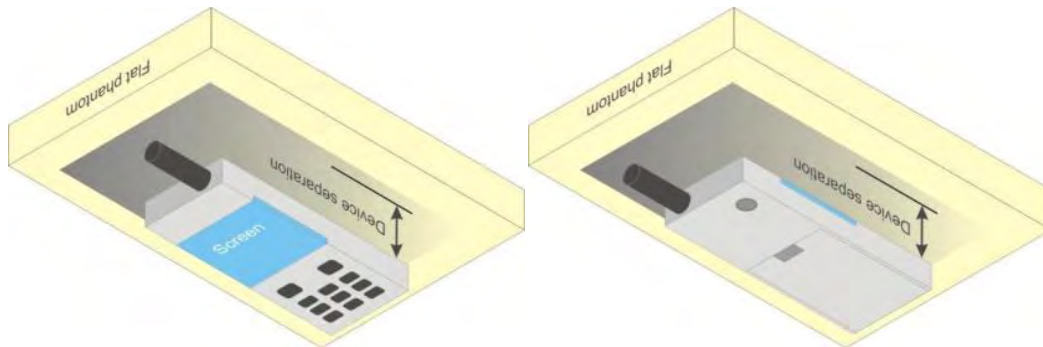

Fig 9.5 Illustration for Body Worn Position

9.6. Hotspot Mode Exposure Position Conditions

For handsets that support hotspot mode operations, with wireless router capabilities and various web browsing functions, the relevant hand and body exposure conditions are tested according to the hotspot SAR procedures in KDB 941225. A test separation distance of 10 mm is required between the phantom and all surfaces and edges with a transmitting antenna located within 25 mm from that surface or edge. When the form factor of a handset is smaller than 9 cm x 5 cm, a test separation distance of 5 mm (instead of 10 mm) is required for testing hotspot mode. When the separation distance required for body-worn accessory testing is larger than or equal to that tested for hotspot mode, in the same wireless mode and for the same surface of the phone, the hotspot mode SAR data may be used to support body-worn accessory SAR compliance for that particular configuration (surface).

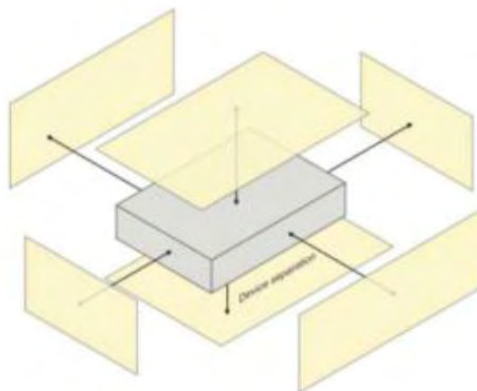

Fig 9.6 Illustration for Hotspot Position

10. Measurement Procedures

The measurement procedures are as follows:

<Conducted power measurement>

- (a) For WWAN power measurement, use base station simulator to configure EUT WWAN transmission in conducted connection with RF cable, at maximum power in each supported wireless interface and frequency band.
- (b) Read the WWAN RF power level from the base station simulator.
- (c) For WLAN/BT power measurement, use engineering software to configure EUT WLAN/BT continuously transmission, at maximum RF power in each supported wireless interface and frequency band.
- (d) Connect EUT RF port through RF cable to the power meter, and measure WLAN/BT output power.

<SAR measurement>

- (a) Use base station simulator to configure EUT WWAN transmission in radiated connection, and engineering software to configure EUT WLAN/BT continuously transmission, at maximum RF power, in the highest power channel.
- (b) Place the EUT in the positions as Appendix D demonstrates.
- (c) Set scan area, grid size and other setting on the DASY software.
- (d) Measure SAR results for the highest power channel on each testing position.
- (e) Find out the largest SAR result on these testing positions of each band.
- (f) Measure SAR results for other channels in worst SAR testing position if the reported SAR of highest power channel is larger than 0.8 W/kg.

According to the test standard, the recommended procedure for assessing the peak spatial-average SAR value consists of the following steps:

- (a) Power reference measurement.
- (b) Area scan.
- (c) Zoom scan.
- (d) Power drift measurement.

10.1. Spatial Peak SAR Evaluation

The procedure for spatial peak SAR evaluation has been implemented according to the test standard. It can be conducted for 1g and 10g, as well as for user-specific masses. The DASY software includes all numerical procedures necessary to evaluate the spatial peak SAR value.

The base for the evaluation is a "cube" measurement. The measured volume must include the 1g and 10g cubes with the highest averaged SAR values. For that purpose, the center of the measured volume is aligned to the interpolated peak SAR value of a previously performed area scan.



The entire evaluation of the spatial peak values is performed within the post-processing engine (SEMCAD). The system always gives the maximum values for the 1g and 10g cubes. The algorithm to find the cube with highest averaged SAR is divided into the following stages:

- (a) Extraction of the measured data (grid and values) from the Zoom Scan.
- (b) Calculation of the SAR value at every measurement point based on all stored data (A/D values and measurement parameters).
- (c) Generation of a high-resolution mesh within the measured volume.
- (d) Interpolation of all measured values from the measurement grid to the high-resolution grid.
- (e) Extrapolation of the entire 3-D field distribution to the phantom surface over the distance from sensor to surface.
- (f) Calculation of the averaged SAR within masses of 1g and 10g.

10.2. Power Reference Measurement

The Power Reference Measurement and Power Drift Measurements are for monitoring the power drift of the device under test in the batch process. The minimum distance of probe sensors to surface determines the closest measurement point to phantom surface. This distance cannot be smaller than the distance of sensor calibration points to probe tip as defined in the probe properties.

10.3. Area Scan Procedures

Area scans are defined prior to the measurement process being executed with a user defined variable spacing between each measurement point (integral) allowing low uncertainty measurements to be conducted. Scans defined for FCC applications utilize a 10mm² step integral, with 1mm interpolation used to locate the peak SAR area used for zoom scan assessments.

When an Area Scan has measured all reachable points, it computes the field maxima founding the scanned area, within a range of the global maximum. The range (in dB) is specified in the standards for compliance testing. For example, a 2 dB range is required in IEEE1528-2003.

10.4. Zoom Scan Procedures

Zoom Scans are used to assess the peak spatial SAR values within a cubic averaging volume containing 1 g and 10 g of simulated tissue. A density of 1000 kg/m³ is used to represent the head and body tissue density and not the phantom liquid density, in order to be consistent with the definition of the liquid dielectric properties, i.e. the side length of the 1g cube is 10mm, with the side



length of the 10 g cube 21,5mm. The zoom scan integer steps can be user defined so as to reduce uncertainty, but normal practice for typical test applications utilize a physical step of 5x5x7 (8mmx8mmx5mm) providing a volume of 32mm in the X & Y axis, and 30mm in the Z axis.

10.5. SAR Averaged Methods

In DASYS, the interpolation and extrapolation are both based on the modified Quadratic Sheppard's method. The interpolation scheme combines a least-square fitted function method and a weighted average method which are the two basic types of computational interpolation and approximation.

Extrapolation routines are used to obtain SAR values between the lowest measurement points and the inner phantom surface. The extrapolation distance is determined by the surface detection distance and the probe sensor offset. The uncertainty increases with the extrapolation distance. To keep the uncertainty within 1% for the 1 g and 10 g cubes, the extrapolation distance should not be larger than 5 mm.

10.6. Power Drift Monitoring

All SAR testing is under the DUT install full charged battery and transmit maximum output power. In DASYS measurement software, the power reference measurement and power drift measurement procedures are used for monitoring the power drift of DUT during SAR test. Both these procedures measure the field at a specified reference position before and after the SAR testing. The software will calculate the field difference in dB. If the power drift more than 5%, the SAR will be retested.

11. SAR Test Procedure

11.1. General Scan Requirements

Probe boundary effect error compensation is required for measurements with the probe tip closer than half a probe tip diameter to the phantom surface. Both the probe tip diameter and sensor offset distance must satisfy measurement protocols; to ensure probe boundary effect errors are minimized and the higher fields closest to the phantom surface can be correctly measured and extrapolated to the phantom surface for computing 1-g SAR. Tolerances of the post-processing algorithms must be verified by the test laboratory for the scan resolutions used in the SAR measurements, according to the reference distribution functions specified in IEEE Std. 1528-2013.

		≤ 3 GHz	> 3 GHz	
Maximum distance from closest measurement point (geometric center of probe sensors) to phantom surface		5 mm \pm 1 mm	$\frac{1}{2} \cdot \delta \cdot \ln(2)$ mm \pm 0.5 mm	
Maximum probe angle from probe axis to phantom surface normal at the measurement location		$30^\circ \pm 1^\circ$	$20^\circ \pm 1^\circ$	
Maximum area scan spatial resolution: ΔX_{Area} , ΔY_{Area}		≤ 2 GHz: ≤ 15 mm 2 – 3 GHz: ≤ 12 mm	3 – 4 GHz: ≤ 12 mm 4 – 6 GHz: ≤ 10 mm	
		When the x or y dimension of the test device, in the measurement plane orientation, is smaller than the above, the measurement resolution must be \leq the corresponding x or y dimension of the test device with at least one measurement point on the test device.		
Maximum zoom scan spatial resolution: ΔX_{Zoom} , ΔY_{Zoom}		≤ 2 GHz: ≤ 8 mm 2 – 3 GHz: ≤ 5 mm*	3 – 4 GHz: ≤ 5 mm* 4 – 6 GHz: ≤ 4 mm*	
Maximum zoom scan spatial resolution, normal to phantom surface	uniform grid: $\Delta Z_{Zoom}(n)$	≤ 5 mm	3 – 4 GHz: ≤ 4 mm 4 – 5 GHz: ≤ 3 mm 5 – 6 GHz: ≤ 2 mm	
	graded grid	$\Delta Z_{Zoom}(1)$: between 1 st two points closest to phantom surface	≤ 4 mm	3 – 4 GHz: ≤ 3 mm 4 – 5 GHz: ≤ 2.5 mm 5 – 6 GHz: ≤ 2 mm
		$\Delta Z_{Zoom}(n>1)$: between subsequent points	$\leq 1.5 \cdot \Delta Z_{Zoom}(n-1)$ mm	
Minimum zoom scan volume	x, y, z	≥ 30 mm	3 – 4 GHz: ≥ 28 mm 4 – 5 GHz: ≥ 25 mm 5 – 6 GHz: ≥ 22 mm	
Note: δ is the penetration depth of a plane-wave at normal incidence to the tissue medium; see IEEE Std 1528-2013 for details. * When zoom scan is required and the <i>reported</i> SAR from the <i>area scan based 1-g SAR estimation</i> procedures of KDB Publication 447498 is ≤ 1.4 W/kg, ≤ 8 mm, ≤ 7 mm and ≤ 5 mm zoom scan resolution may be applied, respectively, for 2 GHz to 3 GHz, 3 GHz to 4 GHz and 4 GHz to 6 GHz.				



11.2. Test Procedure

The Following steps are used for each test position

1. Establish a call with the maximum output power with a base station simulator. The connection between the mobile and the base station simulator is established via air interface.
2. Measurement of the local E-field value at a fixed location. This value serves as a reference value for calculating a possible power drift.
3. Measurement of the SAR distribution with a grid of 8 to 16mm * 8 to 16 mm and a constant distance to the inner surface of the phantom. Since the sensors cannot directly measure at the inner phantom surface, the values between the sensors and the inner phantom surface are extrapolated. With these values the area of the maximum SAR is calculated by an interpolation scheme.
4. Around this point, a cube of 30 * 30 * 30 mm or 32 * 32 * 32 mm is assessed by measuring 5 or 8 * 5 or 8*4 or 5 mm. With these data, the peak spatial-average SAR value can be calculated.

11.3. Description of Interpolation/Extrapolation Scheme

The local SAR inside the phantom is measured using small dipole sensing elements inside a probe body. The probe tip must not be in contact with the phantom surface in order to minimize measurements errors, but the highest local SAR will occur at the surface of the phantom.

An extrapolation is using to determinate this highest local SAR values. The extrapolation is based on a fourth-order least-square polynomial fit of measured data. The local SAR value is then extrapolated from the liquid surface with a 1mm step.

The measurements have to be performed over a limited time (due to the duration of the battery) so the step of measurement is high. It could vary between 5 and 8 mm. To obtain an accurate assessment of the maximum SAR averaged over 10 grams and 1 gram requires a very fine resolution in the three dimensional scanned data array.

11.4. Wireless Router

Some battery-operated handsets have the capability to transmit and receive user through simultaneous transmission of WIFI simultaneously with a separate licensed transmitter. The FCC has provided guidance in FCC KDB Publication 941225 D06 v02r01 where SAR test considerations for handsets ($L \times W \geq 9 \text{ cm} \times 5 \text{ cm}$) are based on a composite test separation distance of 10 from the front, back and edges of the device containing transmitting antennas within 2.5cm of their edges,



determined from general mixed use conditions for this type of devices. Since the hotspot SAR results may overlap with the body-worn accessory SAR requirements, the more conservative configurations can be considered, thus excluding some body-worn accessory SAR tests.

When the user enables the personal wireless router functions for the handset, actual operations include simultaneous transmission of both the WIFI transmitter and another licensed transmitter. Both transmitters often do not transmit at the same transmitting frequency and thus cannot be evaluated for SAR under actual use conditions due to the limitations of the SAR assessment probes. Therefore, SAR must be evaluated for each frequency transmission and mode separately and spatially summed with the WIFI transmitter according to FCC KDB Publication 447498 D01v06 publication procedures. The "Portable Hotspot" feature on the handset was NOT activated during SAR assessments, to ensure the SAR measurements were evaluated for a single transmission frequency RF signal at a time.



12. SAR Test Configuration

<GSM Mode>

A summary of these settings are illustrated below:

For GSM850 frequency band, the power control is set to 5 for GSM/GPRS mode (GSMK-CS1) and set to 8 for EDGE mode (MCS5); For GSM1900 frequency band, the power control is set to 0 for GSM/GPRS mode (GSMK-CS1) and set to 2 for EDGE mode (MCS5).

1. Per KDB 447498 D01v06, the maximum output power channel is used for SAR testing and for further SAR test reduction.
2. Per KDB 941225 D01v03r01, SAR test reduction for GSM / GPRS / EDGE modes is determined by the source-based time-averaged output power including tune-up tolerance. The mode with highest specified time-averaged output power should be tested for SAR compliance in the applicable exposure conditions. For modes with the same specified maximum output power and tolerance, the higher number time-slot configuration should be tested. Therefore, the GPRS (4Tx slots) for GSM850/GSM1900 is considered as the primary mode.
3. Other configurations of GSM / GPRS / EDGE are considered as secondary modes.

Timeslot consignations:

Remark:				
1. The frame-averaged power is linearly reported the maximum burst averaged power over 8 time slots. The calculated method are shown as below: The duty cycle "x" of different time slots as below: 1 TX slot is 1/8, 2 TX slots is 2/8, 3 TX slots is 3/8 and 4 TX slots is 4/8 Based on the calculation formula: Frame-averaged power = Burst averaged power + 10 log (x) So, Frame-averaged power (1 TX slot) = Burst averaged power (1 TX slot)– 9.03 Frame-averaged power (2 TX slots) = Burst averaged power (2 TX slots)– 6.02 Frame-averaged power (3 TX slots) = Burst averaged power (3 TX slots)– 4.26 Frame-averaged power (4 TX slots) = Burst averaged power (4 TX slots) – 3.01				
2. CS1 coding scheme was used in GPRS conducted power measurements and SAR testing, MCS5 coding scheme was used in EGPRS conducted power measurements and SAR testing (if necessary).				
No. of Slots:	Slot 1	Slot 2	Slot 3	Slot 4
Slot Consignation:	1Up 4Down	2Up 3Down	3Up 2Down	4Up 1Down
Duty Cycle:	1:8.3	1:4.15	1:2.77	1:2.08
Correct Factor:	-9.03dB	-6.02dB	-4.26dB	-3.01dB



<WCDMA Mode>

Summary of UMTS conducted power measurement:

1. The 3G SAR test reduction procedure is applied, when the maximum output power and tune-up tolerance specified for production units in a secondary mode is $\leq \frac{1}{4}$ dB higher than the primary mode, SAR measurement is not required for the secondary mode.
2. The following tests were conducted according to the test requirements outlines in 3GPP TS 34.121 specification.
3. The procedures in KDB 941225 D01v03r01 are applied for 3GPP Rel. 6 HSPA to configure the device in the required sub-test mode(s) to determine SAR test exclusion.
4. For HSPA+ devices supporting 16 QAM in the uplink, power measurements procedure is according to the configurations in Table C.11.1.4 of 3GPP TS 34.121-1.
5. Per KDB 941225 D01v03r01, RMC 12.2kbps setting is used to evaluate SAR. The maximum output power and tune-up tolerance specified for production units in HSDPA / HSUPA / DC-HSDPA / HSPA+ is $\leq \frac{1}{4}$ dB higher than RMC 12.2Kbps or when the highest reported SAR of the RMC12.2Kbps is scaled by the ratio of specified maximum output power and tune-up tolerance of HSDPA / HSUPA / DC-HSDPA / HSPA+ to RMC12.2Kbps and the adjusted SAR is ≤ 1.2 W/kg, SAR measurement is not required for HSDPA / HSUPA / DC-HSDPA / HSPA+, and according to the following RF output power, the output power results of the secondary modes (HSDPA / HSUPA / DC-HSDPA / HSPA+) are less than $\frac{1}{4}$ dB higher than the primary modes; therefore, SAR measurement is not required for HSDPA / HSUPA / DC-HSDPA / HSPA+.
6. A fixed level power reduction is applied for WCDMA Band II when handset open Hotspot mode, the power reduction triggered.

HSDPA Setup Configuration

Sub-test	β_c	β_d	β_d (SF)	β_c/β_d	$\beta_{hc}^{(2)}$	CM (dB) ⁽²⁾
1	2/15	15/15	64	2/15	4/15	0.0
2	12/15 ⁽³⁾	15/15 ⁽³⁾	64	12/15 ⁽³⁾	24/15	1.0
3	15/15	8/15	64	15/8	30/15	1.5
4	15/15	4/15	64	15/4	30/15	1.5

Note 1: $\Delta_{ACK}, \Delta_{NACK}$ and $\Delta_{CQI} = 8 \Leftrightarrow A_{hr} = \beta_{hr}/\beta_c = 30/15 \Leftrightarrow \beta_{hr} = 30/15 * \beta_c$
 Note 2: CM = 1 for $\beta_c/\beta_d = 12/15, \beta_{hr}/\beta_c = 24/15$.
 Note 3: For subtest 2 the β_c/β_d ratio of 12/15 for the TFC during the measurement period (TF1, TF0) is achieved by setting the signaled gain factors for the reference TFC (TF1, TF1) to $\beta_c = 11/15$ and $\beta_d = 15/15$.

HSUPA Setup Configuration

Sub-test	β_c	β_d	β_d (SF)	β_c/β_d	$\beta_{hs}^{(1)}$	β_{ec}	β_{ed}	β_{ed} (SF)	β_{ed} (codes)	CM ⁽²⁾ (dB)	MPR (dB)	AG ⁽⁴⁾ Index	E-TFCI
1	11/15 ⁽³⁾	15/15 ⁽³⁾	64	11/15 ⁽³⁾	22/15	209/225	1039/225	4	1	1.0	0.0	20	75
2	6/15	15/15	64	6/15	12/15	12/15	94/75	4	1	3.0	2.0	12	67
3	15/15	9/15	64	15/9	30/15	30/15	β_{ed1} : 47/15 β_{ed2} : 47/15	4	2	2.0	1.0	15	92
4	2/15	15/15	64	2/15	4/15	2/15	56/75	4	1	3.0	2.0	17	71
5	15/15 ⁽⁴⁾	15/15 ⁽⁴⁾	64	15/15 ⁽⁴⁾	30/15	24/15	134/15	4	1	1.0	0.0	21	81

Note 1: Δ_{ACK} , Δ_{NACK} and $\Delta_{CQI} = 8 \Leftrightarrow A_{hs} = \beta_{hs}/\beta_c = 30/15 \Leftrightarrow \beta_{hs} = 30/15 * \beta_c$.

Note 2: CM = 1 for $\beta_c/\beta_d = 12/15$, $\beta_{hs}/\beta_c = 24/15$. For all other combinations of DPDCH, DPCCH, HS-DPCCH, E-DPDCH and E-DPCCH the MPR is based on the relative CM difference.

Note 3: For subtest 1 the β_c/β_d ratio of 11/15 for the TFC during the measurement period (TF1, TF0) is achieved by setting the signaled gain factors for the reference TFC (TF1, TF0) to $\beta_c = 10/15$ and $\beta_d = 15/15$.

Note 4: For subtest 5 the β_c/β_d ratio of 15/15 for the TFC during the measurement period (TF1, TF0) is achieved by setting the signaled gain factors for the reference TFC (TF1, TF0) to $\beta_c = 14/15$ and $\beta_d = 15/15$.

Note 5: Testing UE using E-DPDCH Physical Layer category 1 Sub-test 3 is not required according to TS 25.306 Table 5.1g.

Note 6: β_{ed} cannot be set directly; it is set by Absolute Grant Value.

HSPA+ 3GPP release 7 (uplink category 7) 16QAM, Setup Configuration:
Table C.11.1.4: β values for transmitter characteristics tests with HS-DPCCH and E-DCH with 16QAM

Sub-test	β_c (Note 3)	β_d	β_{hs} (Note 1)	β_{ec}	β_{ed} (2xSF2) (Note 4)	β_{ed} (2xSF4) (Note 4)	CM (dB) (Note 2)	MPR (dB) (Note 2)	AG Index (Note 4)	E-TFCI (Note 5)	E-TFCI (boost)
1	1	0	30/15	30/15	β_{ed1} : 30/15 β_{ed2} : 30/15	β_{ed3} : 24/15 β_{ed4} : 24/15	3.5	2.5	14	105	105

Note 1: Δ_{ACK} , Δ_{NACK} and $\Delta_{CQI} = 30/15$ with $\beta_{hs} = 30/15 * \beta_c$.

Note 2: CM = 3.5 and the MPR is based on the relative CM difference, MPR = MAX(CM-1,0).

Note 3: DPDCH is not configured, therefore the β_c is set to 1 and $\beta_d = 0$ by default.

Note 4: β_{ed} can not be set directly; it is set by Absolute Grant Value.

Note 5: All the sub-tests require the UE to transmit 2SF2+2SF4 16QAM EDCH and they apply for UE using E-DPDCH category 7. E-DCH TTI is set to 2ms TTI and E-DCH table index = 2. To support these E-DCH configurations DPDCH is not allocated. The UE is signaled to use the extrapolation algorithm.

**DC-HSDPA Setup Configuration**

The following tests were completed according to procedures in section 7.3.13 of 3GPP TS34.108 v9.5.0. A summary of these settings are illustrated below:

Downlink Physical Channels are set as per 3GPP TS34.121-1 v9.0.0 E.5.

Table E.5.0: Levels for HSDPA connection setup

Parameter During Connection setup	Unit	Value
P-CPICH_Ec/Ior	dB	-10
P-CCPCH and SCH_Ec/Ior	dB	-12
PICH_Ec/Ior	dB	-15
HS-PDSCH	dB	off
HS-SCCH_1	dB	off
DPCH_Ec/Ior	dB	-5
OCNS_Ec/Ior	dB	-3.1

Call is set up as per 3GPP TS34.108 v9.5.0 sub clause 7.3.13

The configurations of the fixed reference channels for HSDPA RF tests are described in 3GPP TS 34.121, annex C for FDD and 3GPP TS 34.122.

Table C.8.1.12: Fixed Reference Channel H-Set 12

Parameter	Unit	Value
Nominal Avg. Inf. Bit Rate	kbps	60
inter-TTI Distance	TTI's	1
Number of HARQ Processes	Processes	6
Information Bit Payload (N_{INF})	Bits	120
Number Code Blocks	Blocks	1
Binary Channel Bits Per TTI	Bits	960
Total Available SML's in UE	SML's	19200
Number of SML's per HARQ Proc.	SML's	3200
Coding Rate		0.15
Number of Physical Channel Codes	Codes	1
Modulation		QPSK
Note 1: The RMC is intended to be used for DC-HSDPA mode and both cells shall transmit with identical parameters as listed in the table. Note 2: Maximum number of transmission is limited to 1, i.e., retransmission is not allowed. The redundancy and constellation version 0 shall be used.		

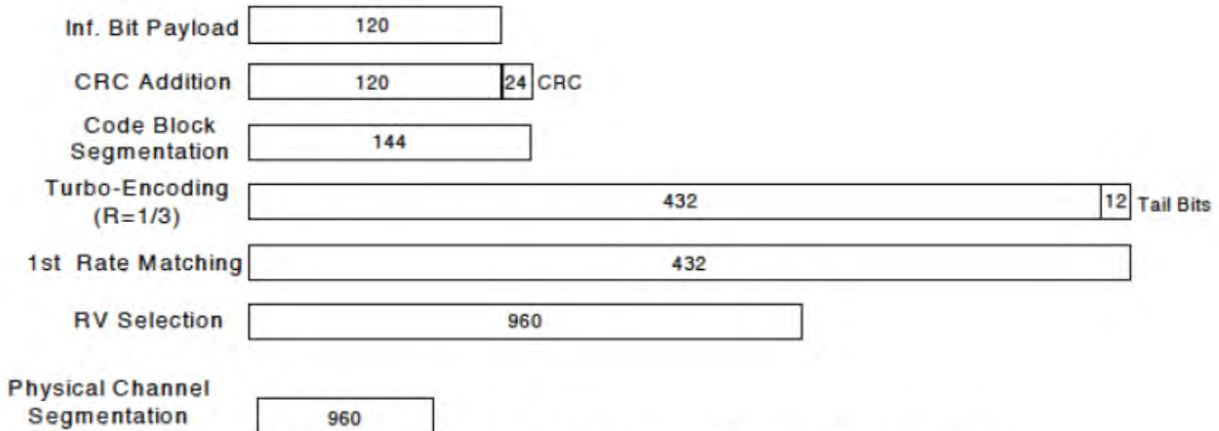
Figure C.8.19: Coding rate for Fixed reference Channel H-Set 12 (QPSK)



<CDMA Mode>

1xEV-DO Rev. B

Call box setup procedure

1xEV-DO Release B

1> CMW 500 Signal Generator > 1xEV-DO Taskbar Enable

2> CMW 500 1xEV-DO Signaling Configuration Window >

3> 1xEV-DO Signaling On Window:

Under Access Network Control:

Band Class: BC0: US Cellular

RF Channel: 31

1xEV-DO Power: -70 dBm

4> 1xEV-DO Signaling Configuration Window

Under RF Frequency Band / Channel: Enter Ch. Frequency

- Under Carrier Configuration: RF Frequency
For Two Carriers: Low Channel (1013)

	<u>RF Channel</u>	<u>RF Channel Offset</u>
Carrier [0]	31	0
Carrier [1]	1013	982

- Under Carrier Configuration: RF Pilot
- | | <u>Carrier Sector</u> | <u>Active on AN</u> | <u>Assigned to AT</u> |
|-----------|-----------------------|---------------------|-----------------------|
| Pilot [0] | C0/S0 | ✓ | ✓ |
| | CA/S1 | ✓ | ✓ |

For Three Carriers: Low Channel (1013)

	<u>RF Channel</u>	<u>RF Channel Offset</u>
Carrier [0]	72	0
Carrier [1]	31	-41
Carrier [2]	1013	941

- Under Carrier Configuration: RF Pilot
- | | <u>Carrier Sector</u> | <u>Active on AN</u> | <u>Assigned to AT</u> |
|-----------|-----------------------|---------------------|-----------------------|
| Pilot [0] | C0/S0 | ✓ | ✓ |
| Pilot [1] | C1/S1 | ✓ | ✓ |
| Pilot [2] | C2/S2 | ✓ | ✓ |

**<LTE Mode>****LTE Target MPR level**

The device implements maximum power reduction per 3GPP 36.101 requirements where the MPR target is as below table. The MPR settings are implemented configured into firmware and cannot be disabled by the end user or LTE carrier network.

Modulation	Channel bandwidth / Transmission bandwidth configuration [RB]						MPR	3GPP
	1.4	3.0	5	10	15	20	Target	MPR
	MHz	MHz	MHz	MHz	MHz	MHz	(dB)	(dB)
QPSK	> 5	> 4	> 8	> 12	> 16	> 18	1	≤ 1
16 QAM	≤ 5	≤ 4	≤ 8	≤ 12	≤ 16	≤ 18	1	≤ 1
64 QAM	> 5	> 4	> 8	> 12	> 16	> 18	2	≤ 2

Note: The measurement result showed some difference from the target MPR level, due to expected 0.5dB measurement tolerance

LTE Bands

LTE Bands	Channel bandwidth / Transmission bandwidth configuration [RB]					
	1.4	3.0	5	10	15	20
	MHz	MHz	MHz	MHz	MHz	MHz
2	√	√	√	√	√	√
4	√	√	√	√	√	√
5	√	√	√	√	N/A	N/A
7	N/A	N/A	√	√	√	√
12	N/A	N/A	√	√	N/A	N/A
17	N/A	N/A	√	√	N/A	N/A
66	√	√	√	√	√	√

Note:

1. Per KDB 941225 D05v02r05, when a properly configured base station simulator is used for the SAR and power measurements, spectrum plots for each RB allocation and offset configuration is not required.
2. Per KDB 941225 D05v02r05, start with the largest channel bandwidth and measure SAR for QPSK with 1 RB allocation, using the RB offset and required test channel combination with the highest maximum output power for RB offsets at the upper edge, middle and lower edge of each required test channel.
3. Per KDB 941225 D05v02r05, 50% RB allocation for QPSK SAR testing follows 1RB QPSK allocation procedure.
4. Per KDB 941225 D05v02r05, for QPSK with 100% RB allocation, SAR is not required when the highest maximum output power for 100 % RB allocation is less than the highest maximum output power in 50% and 1 RB allocations and the highest reported SAR for 1 RB and 50% RB allocation are ≤ 0.8 W/kg. Otherwise, SAR is measured for the highest output power channel; and if the



- reported SAR is > 1.45 W/kg, the remaining required test channels must also be tested.
5. Per KDB 941225 D05v02r05, 16QAM/64QAM output power for each RB allocation configuration is $>$ not $\frac{1}{2}$ dB higher than the same configuration in QPSK and the reported SAR for the QPSK configuration is ≤ 1.45 W/kg; Per KDB941225 D05v02r05, 16QAM/64QAM SAR testing is not required.
 6. Per KDB 941225 D05v02r05, smaller bandwidth output power for each RB allocation configuration is $>$ not $\frac{1}{2}$ Db higher than the same configuration in the largest supported bandwidth, and the reported SAR for the largest supported band width is ≤ 1.45 W/kg; Per KDB 941225 D05v02r05, smaller bandwidth SAR testing is not required.
 7. For LTE B4 / B5 / B7 / B17 the maximum bandwidth does not support three non-overlapping channels, per KDB941225 D05v02r05, when a device supports overlapping channel assignment in a channel bandwidth configuration, the middle channel of the group of overlapping channels should be selected for testing.
 8. LTE band 2 / 12 SAR test was covered by Band 25 / 17; according to April 2015 TCB workshop, SAR test for overlapping LTE bands can be reduced if
 - a. The maximum output power, including tolerance, for the smaller band is \leq the larger band to qualify for the SAR test exclusion.
 - b. The channel bandwidth and other operating parameters for the smaller band are fully supported by the larger band.
 9. According to 2017 TCB workshop, for 64 QAM and 16 QAM should be verified by checking the signal constellation with a call box to avoid incorrect maximum power levels due to MPR and other requirements associated with signal modulation, and the following figure is taken from the "Fundamental Measurement >> Modulation Analysis >>constellation" mode of the device connect to the CMW500 base station, therefore, the device 64QAM and 16QAM signal modulation are correct. Identify if Maximum Power Reduction (MPR) is optional or mandatory, i.e. built-in by design: only mandatory MPR may be considered during SAR testing, when the maximum output power is permanently limited by the MPR implemented within the UE; and only for the applicable RB (resource block) configurations specified in LTE standards: b) A-MPR (additional MPR) must be disabled.
 10. Per KDB 447498 D01v06, the reported SAR is the measured SAR value adjusted for maximum tune-up tolerance.
 - a. Tune-up scaling Factor = tune-up limit power (mW) / EUT RF power (mW), where tune-up limit is the maximum rated power among all production units.
 - b. For SAR testing of WLAN signal with non-100% duty cycle, the measured SAR is scaled-up by the duty cycle scaling factor which is equal to "1/(duty cycle)"
 - c. For WWAN: Reported SAR(W/kg)= Measured SAR(W/kg)*Tune-up Scaling Factor
 - d. For WLAN/Bluetooth: Reported SAR(W/kg)= Measured SAR(W/kg)* Duty Cycle scaling factor * Tune-up scaling factor
 - e. For TDD LTE SAR measurement, the duty cycle 1:1.59 (62.9 %) was used perform testing



and considering the theoretical duty cycle of 63.3% for extended cyclic prefix in the uplink, and the theoretical duty cycle of 62.9% for normal cyclic prefix in uplink, a scaling factor of extended cyclic prefix $63.3\%/62.9\% = 1.006$ is applied to scale-up the measured SAR result.

The Reported TDD LTE SAR = measured SAR (W/kg)* Tune-up Scaling Factor* scaling factor for extended cyclic prefix.

11. Per KDB 447498 D01v06, for each exposure position, testing of other required channels within the operating mode of a frequency band is not required when the reported 1-g or 10-g SAR for the mid-band or highest output power channel is: ≤ 0.8 W/kg or 2.0 W/kg, for 1-g or 10-g respectively, when the transmission band is ≤ 100 MHz ≤ 0.6 W/kg or 1.5 W/kg, for 1-g or 10-g respectively, when the transmission band is between 100 MHz and 200 MHz ≤ 0.4 W/kg or 1.0 W/kg, for 1-g or 10-g respectively, when the transmission band is ≥ 200 MHz
12. Per KDB 865664 D01v01r04, for each frequency band, repeated SAR measurement is required only when the measured SAR is ≥ 0.8 W/kg.
13. Per KDB 648474 D04v01r03, when the reported SAR for a body-worn accessory measured without a headset connected to the handset is ≤ 1.2 W/kg, SAR testing with a headset connected to the handset is not required.

<WLAN 2.4GHz>

1. SAR is measured for 2.4 GHz 802.11b DSSS using either the fixed test position or, when applicable, the initial test position procedure. SAR test reduction is determined according to the following:
 - a. When the reported SAR of the highest measured maximum output power channel for the exposure configuration is ≤ 0.8 W/kg, no further SAR testing is required for 802.11b DSSS in that exposure configuration.
 - b. When the reported SAR is > 0.8 W/kg, SAR is required for that position using the next highest measured output power channel. When any reported SAR is > 1.2 W/kg, SAR is required for the third channel; i.e., all channels require testing.
2. 2.4 GHz 802.11 g/n OFDM are additionally evaluated for SAR if the highest reported SAR for 802.11b, adjusted by the ratio of the OFDM to DSSS specified maximum output power, is > 1.2 W/kg. When SAR is required for OFDM modes in 2.4 GHz band, the Initial Test configuration Procedures should be followed.
3. For held-to-ear and hotspot operations, the initial test position procedures were applied. The test position with the highest extrapolated peak SAR will be used as the initial test position. When reported SAR for the initial test position is ≤ 0.4 W/kg, no additional testing for the remaining test positions was required. Otherwise, SAR is evaluated at the subsequent highest peak SAR positions until the reported SAR result is ≤ 0.8 W/kg or all test positions are measured.
4. Justification for test configurations for WLAN per KDB Publication 248227 D02DR02-41929 for 2.4 GHz WI-FI single transmission chain operations, the highest measured maximum output power channel for DSSS was selected for SAR measurement. SAR for OFDM modes (2.4



GHz802.11g/n) was not required due to the maximum allowed powers and the highest reported DSSSSAR.

5. A fixed level power reduction is applied for WiFi when handset operates "held to the body" condition or "held to the ear" condition, the power reduction triggered by audio receiver detection and call establish status.
6. Per KDB 248227 D01v02r02, In the 2.4 GHz band, separate SAR procedures are applied to DSSS and OFDM configurations to simplify DSSS test requirements. SAR is not required for the following 2.4 GHz OFDM conditions:
 - a. When KDB Publication 447498 SAR test exclusion applies to the OFDM configuration.
 - b. When the highest reported SAR for DSSS is adjusted by the ratio of OFDM to DSSS specified maximum output power and the adjusted SAR is ≤ 1.2 W/kg.

<WLAN 5GHz>

A) U-NII-1 and U-NII-2A Bands

For devices that operate in only one of the U-NII-1 and U-NII-2A bands, the normally required SAR procedures for OFDM configurations are applied. For devices that operate in both U-NII bands using the same transmitter and antenna(s), SAR test reduction is determined according to the following:

1. When the same maximum output power is specified for both bands, begin SAR measurement in U-NII-2A band by applying the OFDM SAR requirements. If the highest reported SAR for a test configuration is ≤ 1.2 W/kg, SAR is not required for U-NII-1 band for that configuration (802.11 mode and exposure condition); otherwise, both bands are tested independently for SAR.
2. When different maximum output power is specified for the bands, begin SAR measurement in the band with higher specified maximum output power. The highest reported SAR for the tested configuration is adjusted by the ratio of lower to higher specified maximum output power for the two bands. When the adjusted SAR is ≤ 1.2 W/kg, SAR is not required for the band with lower maximum output power in that test configuration; otherwise, both bands are tested independently for SAR.
3. The two U-NII bands may be aggregated to support a 160 MHz channel on channel number 50.
4. Without additional testing, the maximum output power for this is limited to the lower of the maximum output power certified for the two bands. When SAR measurement is required for at least one of the bands and the highest reported SAR adjusted by the ratio of specified maximum output power of aggregated to standalone band is > 1.2 W/kg, SAR is required for the 160 MHz channel. This procedure does not apply to an aggregated band with maximum output higher than the standalone band(s); the aggregated band must be tested independently for SAR. SAR is not required when the 160 MHz channel is operating at a reduced maximum power and also qualifies for SAR test exclusion.

**B) U-NII-2C and U-NII-3 Bands**

The frequency range covered by these bands is 380 MHz (5.47 – 5.85 GHz), which requires a minimum of at least two SAR probe calibration frequency points to support SAR measurements. when Terminal Doppler Weather Radar (TDWR) restriction applies, all channels that operate at 5.60 – 5.65 GHz must be included to apply the SAR test reduction and measurement procedures. When the same transmitter and antenna(s) are used for U-NII-2C band and U-NII-3 band or 5.8 GHz band of §15.247, the bands may be aggregated to enable additional channels with 20, 40 or 80 MHz bandwidth to span across the band gap, as illustrated in Appendix B. The maximum output power for the additional band gap channels is limited to the lower of those certified for the bands. Unless band gap channels are permanently disabled, they must be considered for SAR testing. The frequency range covered by these bands is 380 MHz (5.47 – 5.85 GHz), which requires a minimum of at least two SAR probe calibration frequency points to support SAR measurements. To maintain SAR measurement accuracy and to facilitate test reduction, the channels in U-NII-2C band above 5.65 GHz may be grouped with the 5.8 GHz channels in U-NII-3 or §15.247 band to enable two SAR probe calibration frequency points to cover the bands, including the band gap channels. When band gap channels are supported and the bands are not aggregated for SAR testing, band gap channels must be considered independently in each band according to the normally required OFDM SAR measurement and probe calibration frequency points requirements.

C) OFDM Transmission Mode SAR Test Configuration and Channel Selection Requirements

The initial test configuration for 5 GHz OFDM transmission modes is determined by the 802.11 configuration with the highest maximum output power specified for production units, including tune-up tolerance, in each standalone and aggregated frequency band. SAR for the initial test configuration is measured using the highest maximum output power channel determined by the default power measurement procedures. When multiple configurations in a frequency band have the same specified maximum output power, the initial test configuration is determined according to the following steps applied sequentially.

1. The largest channel bandwidth configuration is selected among the multiple configurations with the same specified maximum output power.
2. If multiple configurations have the same specified maximum output power and largest channel bandwidth, the lowest order modulation among the largest channel bandwidth configurations is selected.
3. If multiple configurations have the same specified maximum output power, largest channel bandwidth and lowest order modulation, the lowest data rate configuration among these configurations is selected.
4. When multiple transmission modes (802.11a/g/n/ac) have the same specified maximum output power, largest channel bandwidth, lowest order modulation and lowest data rate, the lowest order 802.11 mode is selected; i.e., 802.11a is chosen over 802.11n then 802.11ac or 802.11g is chosen over 802.11n. After an initial test configuration is determined, if multiple test channels have



the same measured maximum output power, the channel chosen for SAR measurement is determined according to the following. These channel selection procedures apply to both the initial test configuration and subsequent test configuration(s), with respect to the default power measurement procedures or additional power measurements required for further SAR test reduction. The same procedures also apply to subsequent highest output power channel(s) selection.

5. The channel closest to mid-band frequency is selected for SAR measurement.
6. For channels with equal separation from mid-band frequency; for example, high and low channels or two mid-band channels, the higher frequency (number) channel is selected for SAR measurement.

D) SAR Test Requirements for OFDM configurations

When SAR measurement is required for 802.11 a/n/ac OFDM configurations, each standalone and frequency aggregated band is considered separately for SAR test reduction. When the same transmitter and antenna(s) are used for U-NII-1 and U-NII-2A bands, additional SAR test reduction applies. When band gap channels between U-NII-2C band and 5.8 GHz U-NII-3 or §15.247 band are supported, the highest maximum output power transmission mode configuration and maximum output power channel across the bands must be used to determine SAR test reduction, according to the initial test configuration and subsequent test configuration requirements. In applying the initial test configuration and subsequent test configuration procedures, the 802.11 transmission configuration with the highest specified maximum output power and the channel within a test configuration with the highest measured maximum output power should be clearly distinguished to apply the procedures.

13. Conducted Power List

Remark: The output power of GSM/WCDMA/LTE refers to the annex E of this report.

14. Hotspot Mode Evaluation Procedure

➤ EUT Antenna Location

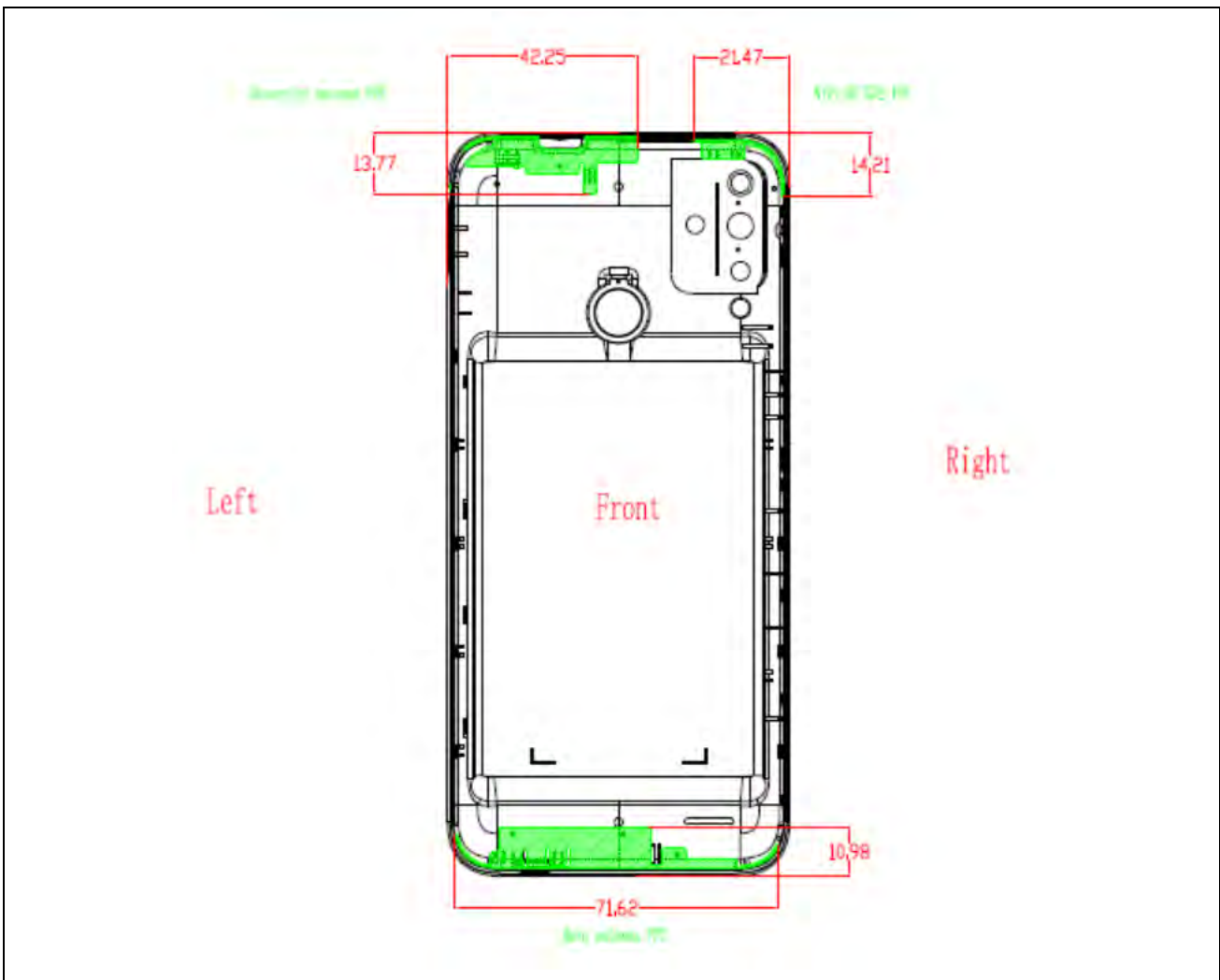

Main Antenna TX bands:
 GSM 850/1900, UMTS Band II/IV/V, LTE Band 2/4/5/7/12/17/66
 WiFi/BT: WLAN 2.4GHz, Bluetooth

Diversity Antenna: RX

**➤ EUT Antenna Distance**

Antenna Location	Front	Back	Left	Right	Top	Bottom
Main Antenna	<5mm	<5mm	<5mm	<5mm	>25mm	<5mm
WiFi/BT Antenna	<5mm	<5mm	>25mm	<5mm	<5mm	>25mm

➤ Hotspot Evaluation

Assessment	Hotspot side for SAR Test distance: 10mm					
Antennas	Front	Back	Left	Right	Top	Bottom
Main Antenna	Yes	Yes	Yes	Yes	No	Yes
WiFi/BT Antenna	Yes	Yes	No	Yes	Yes	No

Note :

1. The SAR evaluation procedures for Portable Devices with Wireless Router function is according to KDB 941225 D06 Hotspot SAR v02r01.
2. Head/Body-worn/Hotspot mode SAR assessments are required.
3. Referring to KDB 941225 D06, when the overall device length and width are $\geq 9\text{cm} \times 5\text{cm}$, the test distance is 10 mm. SAR must be measured for all sides and surfaces with a transmitting antenna located within 25mm from that surface or edge.

15. Block Diagram of the Tests to be Performed

15.1. Head

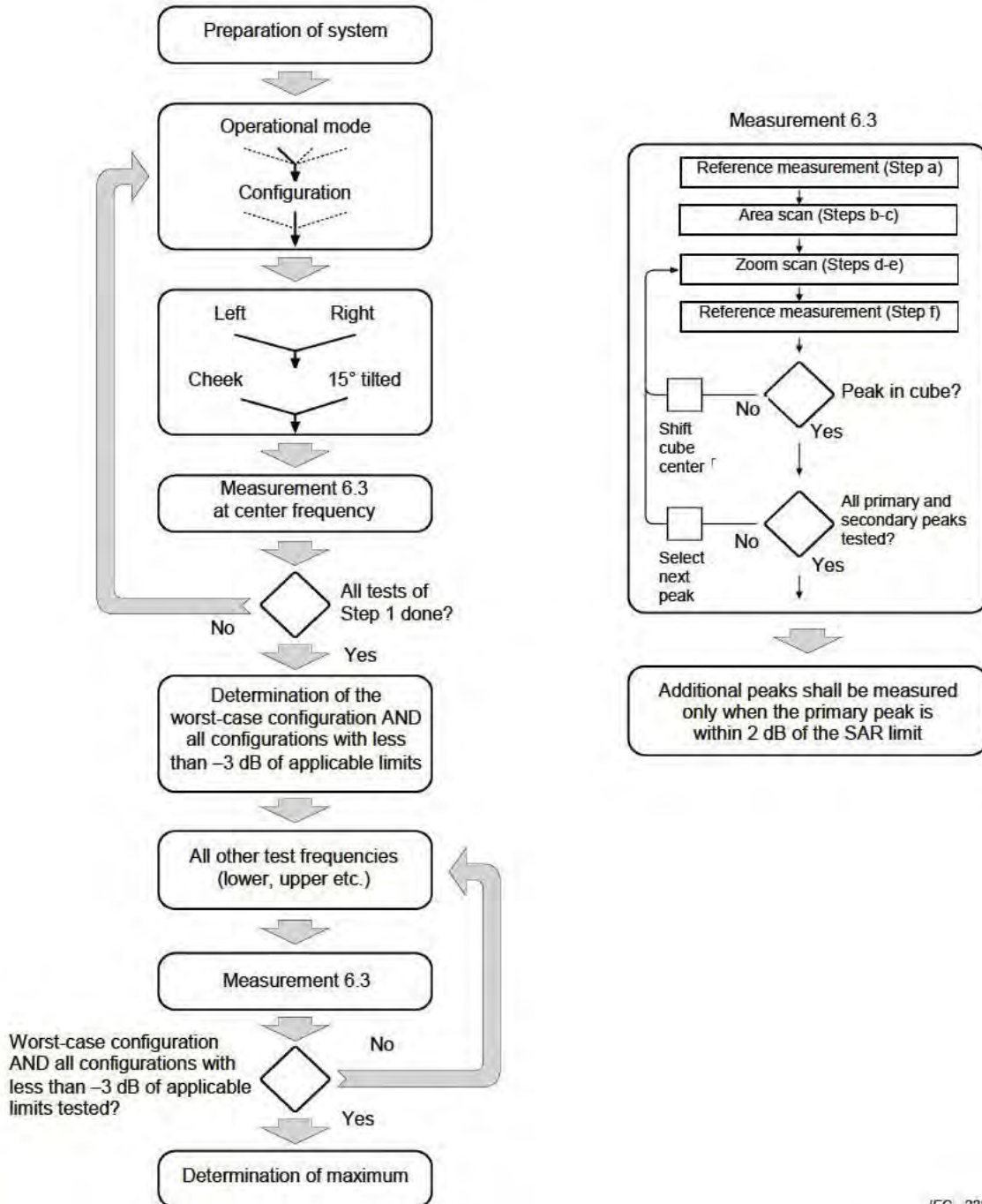

IEC 228/05

15.2. Body

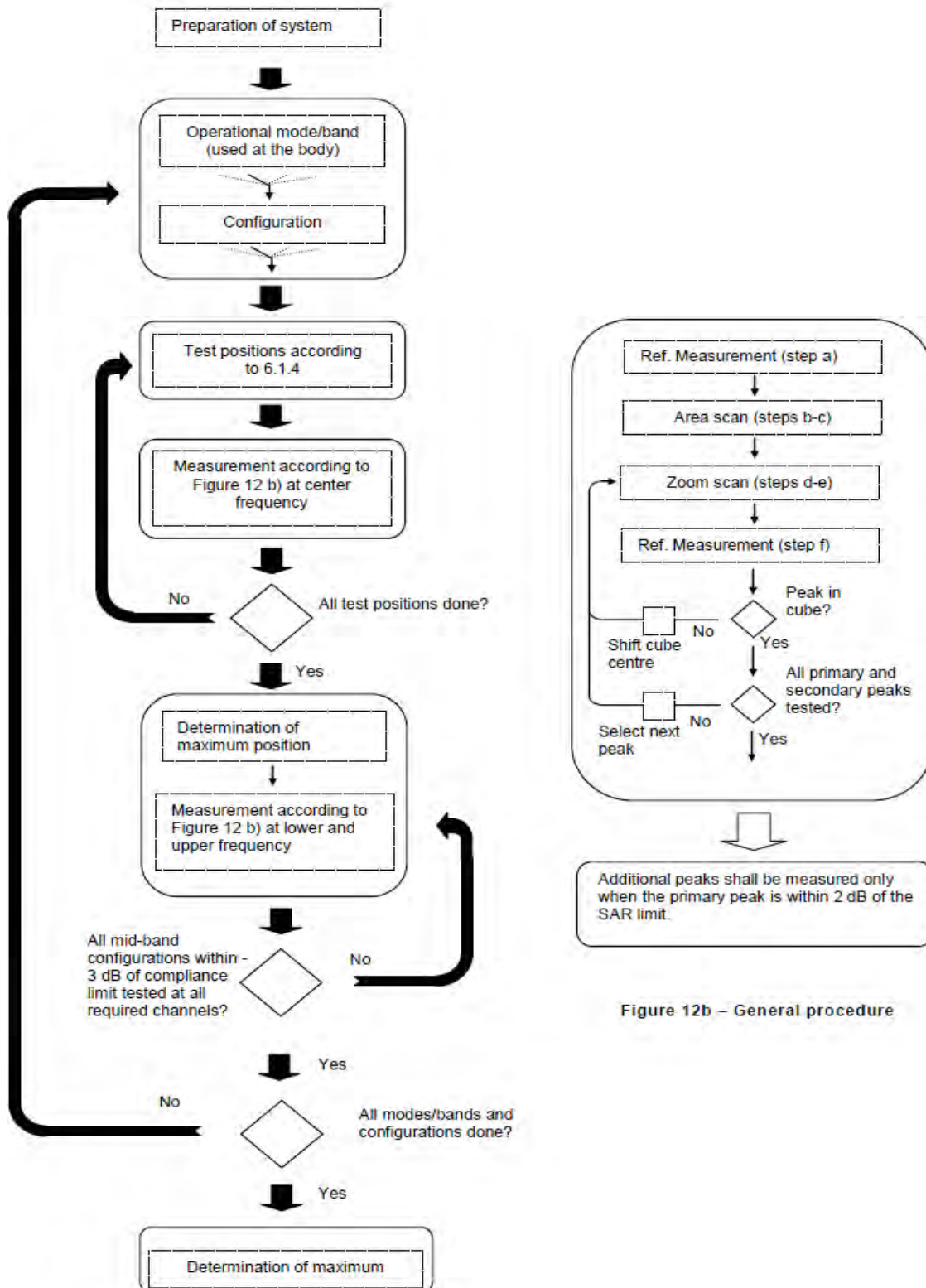

Figure 12b – General procedure



16. Test Results List

16.1. Test Guidance

1. Per KDB 447498 D01v06, the reported SAR is the measured SAR value adjusted for maximum tune-up tolerance.
 - a. Tune-up scaling Factor = tune-up limit power (mW) / EUT RF power (mW), where tune-up limit is the maximum rated power among all production units.
 - b. For SAR testing of WLAN signal with non-100% duty cycle, the measured SAR is scaled-up by the duty cycle scaling factor which is equal to "1/(duty cycle)".
 - c. For WWAN: Reported SAR(W/kg)= Measured SAR(W/kg)*Tune-up Scaling Factor.
 - d. For WLAN/Bluetooth: Reported SAR(W/kg)= Measured SAR(W/kg)* Duty Cycle scaling factor * Tune-up scaling factor.
2. Per KDB 447498 D01v06, for each exposure position, testing of other required channels within the operating mode of a frequency band is not required when the *reported* 1-g or 10-g SAR for the mid-band or highest output power channel is:
 - a. ≤ 0.8 W/kg or 2.0 W/kg, for 1-g or 10-g respectively, when the transmission band is ≤ 100 MHz
 - b. ≤ 0.6 W/kg or 1.5 W/kg, for 1-g or 10-g respectively, when the transmission band is between 100 MHz and 200 MHz
 - c. ≤ 0.4 W/kg or 1.0 W/kg, for 1-g or 10-g respectively, when the transmission band is ≥ 200 MHz
3. Per KDB 865664 D01v01r04, for each frequency band, repeated SAR measurement is required only when the measured SAR is ≥ 0.8 W/kg.
4. Per KDB 648474 D04v01r03, when the reported SAR for a body-worn accessory measured without a headset connected to the handset is ≤ 1.2 W/kg, SAR testing with a headset connected to the handset is not required.
5. Per KDB648474 D04v01r03, for smart phones with a display diagonal dimension > 15.0 cm or an overall diagonal dimension > 16.0 cm, when hotspot mode applies, 10-g extremity SAR is required only for the surfaces and edges with hotspot mode 1-g reported SAR > 1.2 W/kg, however, when power reduction applies to hotspot mode the measured SAR must be scaled to the maximum output power, including tolerance, allowed for tablet modes to compare with the 1.2 W/kg SAR test reduction threshold.
6. Per KDB248227 D01v02r02, a Wi-Fi device must be configured to transmit continuously at the required data rate, channel bandwidth and signal modulation, using the highest transmission duty factor supported by the test mode tools for SAR measurement. The test frequencies established using test mode must correspond to the actual channel frequencies required for operations in the U.S. When 802.11 frame gaps are accounted for in the transmission, a maximum transmission duty factor of 92 - 96% is typically achievable in most test mode configurations. A minimum transmission duty factor of 85% is required to avoid certain hardware and device implementation issues related to wide range SAR scaling. In addition, a periodic



transmission duty factor is required for current generation SAR systems to measure SAR correctly. Unless it is permitted by specific KDB procedures or continuous transmission is specifically restricted by the device, the reported SAR must be scaled to 100% transmission duty factor to determine compliance at the maximum tune-up tolerance limit. When a device is not capable of sustaining continuous transmission or the output can become nonlinear, and it is limited by hardware design and unable to transmit at higher than 85% duty factor, a periodic duty factor within 15% of the maximum duty factor the device is capable of transmitting should be used. The reported SAR must be scaled to the maximum transmission duty factor to determine compliance. Descriptions of the procedures applied to establish the specific duty factor used for SAR testing are required in SAR reports to support the test results.

16.2. Head SAR Data

> GSM Head SAR

Plot No.	Band/Mode	Test Position	CH.	Ave. Power (dBm)	Tune-up Limit (dBm)	Tune-up Scaling Factor	Meas. SAR _{1g} (W/kg)	Reported SAR _{1g} (W/kg)
1#	GPRS 850(2 TX slots)	Right Cheek	189	30.11	30.50	1.094	0.063	0.069
	GPRS 850(2 TX slots)	Right Tilt	189	30.11	30.50	1.094	0.030	0.032
	GPRS 850(2 TX slots)	Left Cheek	189	30.11	30.50	1.094	0.051	0.056
	GPRS 850(2 TX slots)	Left Tilt	189	30.11	30.50	1.094	0.028	0.030
	GPRS 1900(2 TX slots)	Right Cheek	661	27.01	27.50	1.119	0.104	0.116
	GPRS 1900(2 TX slots)	Right Tilt	661	27.01	27.50	1.119	0.060	0.067
2#	GPRS 1900(2 TX slots)	Left Cheek	661	27.01	27.50	1.119	0.106	0.119
	GPRS 1900(2 TX slots)	Left Tilt	661	27.01	27.50	1.119	0.078	0.087

> WCDMA Head SAR

Plot No.	Band/Mode	Test Position	CH.	Ave. Power (dBm)	Tune-up Limit (dBm)	Tune-up Scaling Factor	Meas. SAR _{1g} (W/kg)	Reported SAR _{1g} (W/kg)
	Band II/RMC 12.2Kbps	Right Cheek	9400	20.54	21.00	1.112	0.022	0.024
	Band II/RMC 12.2Kbps	Right Tilt	9400	20.54	21.00	1.112	0.013	0.014
3#	Band II/RMC 12.2Kbps	Left Cheek	9400	20.54	21.00	1.112	0.027	0.030
	Band II/RMC 12.2Kbps	Left Tilt	9400	20.54	21.00	1.112	0.009	0.011
4#	Band IV/RMC 12.2Kbps	Right Cheek	1413	20.51	21.00	1.119	0.107	0.120
	Band IV/RMC 12.2Kbps	Right Tilt	1413	20.51	21.00	1.119	0.055	0.061



	Band IV/RMC 12.2Kbps	Left Cheek	1413	20.51	21.00	1.119	0.106	0.119
	Band IV/RMC 12.2Kbps	Left Tilt	1413	20.51	21.00	1.119	0.053	0.060
5#	Band V/RMC 12.2Kbps	Right Cheek	4182	23.18	24.00	1.208	0.041	0.049
	Band V/RMC 12.2Kbps	Right Tilt	4182	23.18	24.00	1.208	0.018	0.022
	Band V/RMC 12.2Kbps	Left Cheek	4182	23.18	24.00	1.208	0.033	0.040
	Band V/RMC 12.2Kbps	Left Tilt	4182	23.18	24.00	1.208	0.017	0.021

➤ LTE QPSK Head SAR

Plot No.	Band/Mode	Test Position	CH.	Ave. Power (dBm)	Tune-up Limit (dBm)	Tune-up Scaling Factor	Meas. SAR _{1g} (W/kg)	Reported SAR _{1g} (W/kg)
	LTE Band 2/1RB#0 20M	Right Cheek	18900	20.05	20.50	1.109	0.055	0.061
	LTE Band 2/1RB#0 20M	Right Tilt	18900	20.05	20.50	1.109	0.030	0.034
6#	LTE Band 2/1RB#0 20M	Left Cheek	18900	20.05	20.50	1.109	0.073	0.081
	LTE Band 2/1RB#0 20M	Left Tilt	18900	20.05	20.50	1.109	0.029	0.032
	LTE Band 2/50RB#0 20M	Right Cheek	18900	19.05	19.50	1.109	0.042	0.047
	LTE Band 2/50RB#0 20M	Right Tilt	18900	19.05	19.50	1.109	0.023	0.025
	LTE Band 2/50RB#0 20M	Left Cheek	18900	19.05	19.50	1.109	0.059	0.065
	LTE Band 2/50RB#0 20M	Left Tilt	18900	19.05	19.50	1.109	0.021	0.023
7#	LTE Band 4/1RB#0 20M	Right Cheek	20175	23.02	23.50	1.117	0.127	0.142
	LTE Band 4/1RB#0 20M	Right Tilt	20175	23.02	23.50	1.117	0.071	0.079
	LTE Band 4/1RB#0 20M	Left Cheek	20175	23.02	23.50	1.117	0.095	0.106
	LTE Band 4/1RB#0 20M	Left Tilt	20175	23.02	23.50	1.117	0.082	0.092
	LTE Band 4/50RB#0 20M	Right Cheek	20175	21.98	22.50	1.127	0.101	0.114
	LTE Band 4/50RB#0 20M	Right Tilt	20175	21.98	22.50	1.127	0.088	0.099
	LTE Band 4/50RB#0 20M	Left Cheek	20175	21.98	22.50	1.127	0.077	0.087
	LTE Band 4/50RB#0 20M	Left Tilt	20175	21.98	22.50	1.127	0.064	0.072
	LTE Band 5/1RB#0 10M	Right Cheek	20525	22.89	23.50	1.151	0.031	0.035
	LTE Band 5/1RB#0 10M	Right Tilt	20525	22.89	23.50	1.151	0.016	0.018
8#	LTE Band 5/1RB#0 10M	Left Cheek	20525	22.89	23.50	1.151	0.034	0.039
	LTE Band 5/1RB#0 10M	Left Tilt	20525	22.89	23.50	1.151	0.018	0.020
	LTE Band 5/25RB#0 10M	Right Cheek	20525	21.91	22.50	1.146	0.024	0.027
	LTE Band 5/25RB#0 10M	Right Tilt	20525	21.91	22.50	1.146	0.013	0.014
	LTE Band 5/25RB#0 10M	Left Cheek	20525	21.91	22.50	1.146	0.028	0.032
	LTE Band 5/25RB#0 10M	Left Tilt	20525	21.91	22.50	1.146	0.014	0.016



	LTE Band 7/1RB#0 20M	Right Cheek	21100	19.94	20.50	1.138	0.011	0.012
	LTE Band 7/1RB#0 20M	Right Tilt	21100	19.94	20.50	1.138	0.010	0.011
	LTE Band 7/1RB#0 20M	Left Cheek	21100	19.94	20.50	1.138	0.018	0.020
9#	LTE Band 7/1RB#0 20M	Left Tilt	21100	19.94	20.50	1.138	0.086	0.098
	LTE Band 7/50RB#0 20M	Right Cheek	21100	19.04	19.50	1.112	0.010	0.011
	LTE Band 7/50RB#0 20M	Right Tilt	21100	19.04	19.50	1.112	0.008	0.008
	LTE Band 7/50RB#0 20M	Left Cheek	21100	19.04	19.50	1.112	0.013	0.015
	LTE Band 7/50RB#0 20M	Left Tilt	21100	19.04	19.50	1.112	0.006	0.007
	LTE Band 12/1RB#0 10M	Right Cheek	23095	22.80	23.50	1.175	0.105	0.123
	LTE Band 12/1RB#0 10M	Right Tilt	23095	22.80	23.50	1.175	0.078	0.092
10#	LTE Band 12/1RB#0 10M	Left Cheek	23095	22.80	23.50	1.175	0.126	0.148
	LTE Band 12/1RB#0 10M	Left Tilt	23095	22.80	23.50	1.175	0.075	0.088
	LTE Band 12/25RB#0 10M	Right Cheek	23095	21.73	22.50	1.194	0.106	0.127
	LTE Band 12/25RB#0 10M	Right Tilt	23095	21.73	22.50	1.194	0.065	0.078
	LTE Band 12/25RB#0 10M	Left Cheek	23095	21.73	22.50	1.194	0.102	0.122
	LTE Band 12/25RB#0 10M	Left Tilt	23095	21.73	22.50	1.194	0.062	0.074
11#	LTE Band 17/1RB#0 10M	Right Cheek	23790	22.88	23.50	1.153	0.148	0.171
	LTE Band 17/1RB#0 10M	Right Tilt	23790	22.88	23.50	1.153	0.084	0.097
	LTE Band 17/1RB#0 10M	Left Cheek	23790	22.88	23.50	1.153	0.139	0.160
	LTE Band 17/1RB#0 10M	Left Tilt	23790	22.88	23.50	1.153	0.086	0.100
	LTE Band 17/25RB#0 10M	Right Cheek	23790	21.80	22.50	1.175	0.120	0.141
	LTE Band 17/25RB#0 10M	Right Tilt	23790	21.80	22.50	1.175	0.065	0.077
	LTE Band 17/25RB#0 10M	Left Cheek	23790	21.80	22.50	1.175	0.111	0.130
	LTE Band 17/25RB#0 10M	Left Tilt	23790	21.80	22.50	1.175	0.068	0.080
12#	LTE Band 66/1RB#0 20M	Right Cheek	132322	21.02	21.50	1.117	0.136	0.152
	LTE Band 66/1RB#0 20M	Right Tilt	132322	21.02	21.50	1.117	0.070	0.078
	LTE Band 66/1RB#0 20M	Left Cheek	132322	21.02	21.50	1.117	0.116	0.130
	LTE Band 66/1RB#0 20M	Left Tilt	132322	21.02	21.50	1.117	0.058	0.065
	LTE Band 66/50RB#0 20M	Right Cheek	132322	19.77	20.50	1.183	0.106	0.125
	LTE Band 66/50RB#0 20M	Right Tilt	132322	19.77	20.50	1.183	0.054	0.064
	LTE Band 66/50RB#0 20M	Left Cheek	132322	19.77	20.50	1.183	0.092	0.109
	LTE Band 66/50RB#0 20M	Left Tilt	132322	19.77	20.50	1.183	0.045	0.053

**➤ WLAN Head SAR**

Plot No.	Band/Mode	Test Position	CH.	Ave. Power (dBm)	Tune-up Limit (dBm)	Tune-up Scaling Factor	Meas. SAR _{1g} (W/kg)	Reported SAR _{1g} (W/kg)
	WLAN2.4GHz/802.11b	Right Cheek	13	13.33	13.50	1.040	0.155	0.162
	WLAN2.4GHz/802.11b	Right Tilt	13	13.33	13.50	1.040	0.143	0.149
	WLAN2.4GHz/802.11b	Left Cheek	13	13.33	13.50	1.040	0.267	0.279
13#	WLAN2.4GHz/802.11b	Left Tilt	13	13.33	13.50	1.040	0.350	0.365

Note:

1. Per KDB 447498 D01v06, for each exposure position, if the highest output power channel Reported SAR ≤ 0.8 W/kg, other channels SAR testing is not necessary.
2. Per KDB 865664 D01v01r04, for each frequency band, repeated SAR measurement is required when the measured SAR is ≥ 0.8 W/kg.
3. Per KDB 941225 D05v02r05, 100% RB allocation SAR measurement is not required when the highest reported SAR for 1 RB and 50% RB allocation are ≤ 0.8 W/kg.
4. Per KDB 248227 D01v02r02, for 802.11b DSSS , when the reported SAR of the highest measured maximum output power channel for the exposure configuration is ≤ 0.8 W/kg, no further SAR testing is required in that exposure configuration.
5. Per KDB 248227 D01v02r02, OFDM SAR is not required when the highest reported SAR for DSSS is adjusted by the ratio of OFDM to DSSS specified maximum output power and the adjusted SAR is ≤ 1.2 W/kg.
6. According to KDB 865664 D02v01r02, SAR plot is required for the highest measured SAR in each exposure configuration, wireless mode and frequency band combination.
7. The 2.4G WLAN reported 1g SAR (W/kg) should be scaled with the duty cycle scaling factor 1.004.



16.3. Body SAR Data

➤ **GSM Body SAR**

Plot No.	Band/Mode	Test Position	CH.	Ave. Power (dBm)	Tune-up Limit (dBm)	Tune-up Scaling Factor	Meas. SAR _{1g} (W/kg)	Reported SAR _{1g} (W/kg)
	GPRS 850(2 TX slots)	Front Side	189	30.11	30.50	1.094	0.044	0.048
14#	GPRS 850(2 TX slots)	Back Side	189	30.11	30.50	1.094	0.162	0.177
	GPRS 850(2 TX slots)	Left Side	189	30.11	30.50	1.094	0.041	0.044
	GPRS 850(2 TX slots)	Right Side	189	30.11	30.50	1.094	0.072	0.079
15#	GPRS 850(2 TX slots)	Bottom Side	189	30.11	30.50	1.094	0.244	0.267
	GPRS 1900(2 TX slots)	Front Side	661	26.76	27.50	1.186	0.325	0.385
16#	GPRS 1900(2 TX slots)	Back Side	661	26.76	27.50	1.186	0.407	0.483
	GPRS 1900(2 TX slots)	Left Side	661	26.76	27.50	1.186	0.129	0.153
	GPRS 1900(2 TX slots)	Right Side	661	26.76	27.50	1.186	0.061	0.072
17#	GPRS 1900(2 TX slots)	Bottom Side	661	26.76	27.50	1.186	0.682	0.809

➤ **WCDMA Body SAR**

Plot No.	Band/Mode	Test Position	CH.	Ave. Power (dBm)	Tune-up Limit (dBm)	Tune-up Scaling Factor	Meas. SAR _{1g} (W/kg)	Reported SAR _{1g} (W/kg)
	Band II/RMC 12.2Kbps	Front Side	9400	20.54	21.00	1.112	0.052	0.058
18#	Band II/RMC 12.2Kbps	Back Side	9400	20.54	21.00	1.112	0.102	0.113
	Band II/RMC 12.2Kbps	Left Side	9400	20.54	21.00	1.112	0.030	0.033
	Band II/RMC 12.2Kbps	Right Side	9400	20.54	21.00	1.112	0.019	0.021
19#	Band II/RMC 12.2Kbps	Bottom Side	9400	20.54	21.00	1.112	0.299	0.332
20#	Band IV/RMC 12.2Kbps	Front Side	1413	20.51	21.00	1.119	0.229	0.256
	Band IV/RMC 12.2Kbps	Back Side	1413	20.51	21.00	1.119	0.218	0.244
	Band IV/RMC 12.2Kbps	Left Side	1413	20.51	21.00	1.119	0.112	0.125
	Band IV/RMC 12.2Kbps	Right Side	1413	20.51	21.00	1.119	0.093	0.104
21#	Band IV/RMC 12.2Kbps	Bottom Side	1413	20.51	21.00	1.119	0.610	0.683
	Band V/RMC 12.2Kbps	Front Side	4182	23.18	24.00	1.208	0.030	0.036
22#	Band V/RMC 12.2Kbps	Back Side	4182	23.18	24.00	1.208	0.120	0.145
	Band V/RMC 12.2Kbps	Left Side	4182	23.18	24.00	1.208	0.053	0.064
	Band V/RMC 12.2Kbps	Right Side	4182	23.18	24.00	1.208	0.024	0.029
	Band V/RMC 12.2Kbps	Bottom Side	4182	23.18	24.00	1.208	0.097	0.117



➤ LTE QPSK Body SAR

Plot No.	Band/Mode	Test Position	CH.	Ave. Power (dBm)	Tune-up Limit (dBm)	Tune-up Scaling Factor	Meas. SAR _{1g} (W/kg)	Reported SAR _{1g} (W/kg)
	LTE Band 2/1RB#0 20M	Front Side	18900	20.05	20.50	1.109	0.166	0.184
23#	LTE Band 2/1RB#0 20M	Back Side	18900	20.05	20.50	1.109	0.235	0.261
	LTE Band 2/1RB#0 20M	Left Side	18900	20.05	20.50	1.109	0.084	0.093
	LTE Band 2/1RB#0 20M	Right Side	18900	20.05	20.50	1.109	0.050	0.056
24#	LTE Band 2/1RB#0 20M	Bottom Side	18900	20.05	20.50	1.109	0.595	0.660
	LTE Band 2/50RB#0 20M	Front Side	18900	19.05	19.50	1.109	0.131	0.145
	LTE Band 2/50RB#0 20M	Back Side	18900	19.05	19.50	1.109	0.183	0.203
	LTE Band 2/50RB#0 20M	Left Side	18900	19.05	19.50	1.109	0.067	0.074
	LTE Band 2/50RB#0 20M	Right Side	18900	19.05	19.50	1.109	0.040	0.044
	LTE Band 2/50RB#0 20M	Bottom Side	18900	19.05	19.50	1.109	0.470	0.521
	LTE Band 4/1RB#0 20M	Front Side	20175	23.02	23.50	1.117	0.457	0.510
25#	LTE Band 4/1RB#0 20M	Back Side	20175	23.02	23.50	1.117	0.699	0.781
	LTE Band 4/1RB#0 20M	Left Side	20175	23.02	23.50	1.117	0.193	0.216
	LTE Band 4/1RB#0 20M	Right Side	20175	23.02	23.50	1.117	0.177	0.198
	LTE Band 4/1RB#0 20M	Bottom Side	20175	23.02	23.50	1.117	0.902	1.007
	LTE Band 4/1RB#0 20M	Bottom Side	20050	22.95	23.50	1.135	0.876	0.994
26#	LTE Band 4/1RB#0 20M	Bottom Side	20300	22.97	23.50	1.130	1.020	1.152
	LTE Band 4/50RB#0 20M	Front Side	20175	21.98	22.50	1.127	0.321	0.362
	LTE Band 4/50RB#0 20M	Back Side	20175	21.98	22.50	1.127	0.513	0.578
	LTE Band 4/50RB#0 20M	Left Side	20175	21.98	22.50	1.127	0.160	0.180
	LTE Band 4/50RB#0 20M	Right Side	20175	21.98	22.50	1.127	0.144	0.162
	LTE Band 4/50RB#0 20M	Bottom Side	20175	21.98	22.50	1.127	0.727	0.819
	LTE Band 4/50RB#0 20M	Bottom Side	20050	21.80	22.50	1.175	0.840	0.987
	LTE Band 4/50RB#0 20M	Bottom Side	20300	21.84	22.50	1.164	0.945	1.100
	LTE Band 4/100RB#0 20M	Bottom Side	20175	21.87	22.50	1.156	0.701	0.810
	LTE Band 5/1RB#0 10M	Front Side	20525	22.89	23.50	1.151	0.030	0.034
27#	LTE Band 5/1RB#0 10M	Back Side	20525	22.89	23.50	1.151	0.065	0.075
	LTE Band 5/1RB#0 10M	Left Side	20525	22.89	23.50	1.151	0.026	0.029
	LTE Band 5/1RB#0 10M	Right Side	20525	22.89	23.50	1.151	0.053	0.061
28#	LTE Band 5/1RB#0 10M	Bottom Side	20525	22.89	23.50	1.151	0.247	0.284
	LTE Band 5/25RB#0 10M	Front Side	20525	21.91	22.50	1.146	0.023	0.027
	LTE Band 5/25RB#0 10M	Back Side	20525	21.91	22.50	1.146	0.054	0.061
	LTE Band 5/25RB#0 10M	Left Side	20525	21.91	22.50	1.146	0.020	0.023



	LTE Band 5/25RB#0 10M	Right Side	20525	21.91	22.50	1.146	0.042	0.048
	LTE Band 5/25RB#0 10M	Bottom Side	20525	21.91	22.50	1.146	0.200	0.229
	LTE Band 7/1RB#0 10M	Front Side	21100	19.94	20.50	1.138	0.069	0.078
29#	LTE Band 7/1RB#0 10M	Back Side	21100	19.94	20.50	1.138	0.165	0.188
	LTE Band 7/1RB#0 10M	Left Side	21100	19.94	20.50	1.138	0.047	0.054
	LTE Band 7/1RB#0 10M	Right Side	21100	19.94	20.50	1.138	0.189	0.215
30#	LTE Band 7/1RB#0 10M	Bottom Side	21100	19.94	20.50	1.138	0.363	0.413
	LTE Band 7/50RB#0 10M	Front Side	21100	19.04	19.50	1.112	0.052	0.058
	LTE Band 7/50RB#0 10M	Back Side	21100	19.04	19.50	1.112	0.129	0.143
	LTE Band 7/50RB#0 10M	Left Side	21100	19.04	19.50	1.112	0.041	0.045
	LTE Band 7/50RB#0 10M	Right Side	21100	19.04	19.50	1.112	0.119	0.132
	LTE Band 7/50RB#0 10M	Bottom Side	21100	19.04	19.50	1.112	0.287	0.319
	LTE Band 12/1RB#0 10M	Front Side	23095	22.80	23.50	1.175	0.142	0.167
31#	LTE Band 12/1RB#0 10M	Back Side	23095	22.80	23.50	1.175	0.346	0.407
	LTE Band 12/1RB#0 10M	Left Side	23095	22.80	23.50	1.175	0.144	0.169
	LTE Band 12/1RB#0 10M	Right Side	23095	22.80	23.50	1.175	0.217	0.255
	LTE Band 12/1RB#0 10M	Bottom Side	23095	22.80	23.50	1.175	0.139	0.163
	LTE Band 12/25RB#0 10M	Front Side	23095	21.73	22.50	1.194	0.115	0.137
	LTE Band 12/25RB#0 10M	Back Side	23095	21.73	22.50	1.194	0.273	0.326
	LTE Band 12/25RB#0 10M	Left Side	23095	21.73	22.50	1.194	0.119	0.142
	LTE Band 12/25RB#0 10M	Right Side	23095	21.73	22.50	1.194	0.174	0.208
	LTE Band 12/25RB#0 10M	Bottom Side	23095	21.73	22.50	1.194	0.117	0.140
	LTE Band 17/1RB#0 10M	Front Side	23790	22.88	23.50	1.153	0.208	0.240
32#	LTE Band 17/1RB#0 10M	Back Side	23790	22.88	23.50	1.153	0.394	0.454
	LTE Band 17/1RB#0 10M	Left Side	23790	22.88	23.50	1.153	0.147	0.170
	LTE Band 17/1RB#0 10M	Right Side	23790	22.88	23.50	1.153	0.215	0.248
	LTE Band 17/1RB#0 10M	Bottom Side	23790	22.88	23.50	1.153	0.140	0.161
	LTE Band 17/25RB#0 10M	Front Side	23790	21.80	22.50	1.175	0.165	0.194
	LTE Band 17/25RB#0 10M	Back Side	23790	21.80	22.50	1.175	0.278	0.327
	LTE Band 17/25RB#0 10M	Left Side	23790	21.80	22.50	1.175	0.116	0.136
	LTE Band 17/25RB#0 10M	Right Side	23790	21.80	22.50	1.175	0.174	0.204
	LTE Band 17/25RB#0 10M	Bottom Side	23790	21.80	22.50	1.175	0.125	0.147
33#	LTE Band 66/1RB#0 20M	Front Side	132322	21.02	21.50	1.117	0.328	0.366
	LTE Band 66/1RB#0 20M	Back Side	132322	21.02	21.50	1.117	0.322	0.360



	LTE Band 66/1RB#0 20M	Left Side	132322	21.02	21.50	1.117	0.127	0.142
	LTE Band 66/1RB#0 20M	Right Side	132322	21.02	21.50	1.117	0.111	0.124
25#	LTE Band 66/1RB#0 20M	Bottom Side	132322	21.02	21.50	1.117	0.653	0.729
	LTE Band 66/50RB#0 20M	Front Side	132322	19.77	20.50	1.183	0.256	0.303
	LTE Band 66/50RB#0 20M	Back Side	132322	19.77	20.50	1.183	0.254	0.300
	LTE Band 66/50RB#0 20M	Left Side	132322	19.77	20.50	1.183	0.099	0.117
	LTE Band 66/50RB#0 20M	Right Side	132322	19.77	20.50	1.183	0.083	0.098
	LTE Band 66/50RB#0 20M	Bottom Side	132322	19.77	20.50	1.183	0.502	0.594

➤ **WLAN Body SAR**

Plot No.	Band/Mode	Test Position	CH.	Ave. Power (dBm)	Tune-up Limit (dBm)	Tune-up Scaling Factor	Meas. SAR _{1g} (W/kg)	Reported SAR _{1g} (W/kg)
	WLAN2.4GHz/802.11b	Front Side	13	13.33	13.5	1.040	0.206	0.215
26#	WLAN2.4GHz/802.11b	Back Side	13	13.33	13.5	1.040	0.248	0.259
	WLAN2.4GHz/802.11b	Right Side	13	13.33	13.5	1.040	0.236	0.246
	WLAN2.4GHz/802.11b	Top Side	13	13.33	13.5	1.040	0.204	0.213

Note:

The 2.4G WLAN reported 1g SAR (W/kg) should be scaled with the duty cycle scaling factor 1.019.

➤ **Bluetooth Body SAR**

When standalone SAR is not required to be measured, per FCC KDB 447498 D01v06 4.3.2), the following equation must be used to estimate the standalone 1g SAR.

$$\text{Estimated SAR} = \frac{\sqrt{f(\text{GHz})}}{7.5} \cdot \frac{\text{Max. power of channel, mW}}{\text{Min. Separation Distance, mm}}$$

Channel	Frequency (GHz)	Max. Tune-up Power (dBm)	Max. Power(mW)	Test Distance (mm)	Result	Exclusion Thresholds for 1-g SAR
CH 0	2.402	7.5	4.0	10	0.93	3.0

Mode	Max. Tune-up Power (dBm)	Exposure Position	
		Test Distance (mm)	Body
Bluetooth	7.5	Estimated SAR (W/kg)	0.124

Plot No.	Band/Mode	Test Position	CH.	Ave. Power (dBm)	Tune-up Limit (dBm)	Tune-up Scaling Factor	Meas. SAR _{1g} (W/kg)	Reported SAR _{1g} (W/kg)
	Bluetooth/1Mbps	Front Side	0	6.73	7.5	1.194	0.124	0.159
	Bluetooth/1Mbps	Back Side	0	6.73	7.5	1.194	0.124	0.159

Note: The reported SAR should be scaled with the duty cycle factor of 1.077.



16.4. Repeated SAR Assessment

➤ General Note

In accordance with published RF Exposure KDB procedure 865664 D01 SAR measurement 100 MHz to 6 GHz. These additional measurements are repeated after the completion of all measurements requiring the same head or body tissue-equivalent medium in a frequency band. The test device should be returned to ambient conditions (normal room temperature) with the battery fully charged before it is re-mounted on the device holder for the repeated measurement(s) to minimize any unexpected variations in the repeated results.

1. Repeated measurement is not required when the original highest measured SAR is < 0.80 W/kg; When the original highest measured SAR is ≥ 0.80 W/kg, repeat that measurement once. If the measured SAR value of the initial repeated measurement is < 1.45 W/kg with $\leq 20\%$ variation, only one repeated measurement is required to reaffirm that the results are not expected to have substantial variations, which may introduce significant compliance concerns.
2. Perform a second repeated measurement only if the ratio of largest to smallest SAR for the original and first repeated measurements is > 1.20 or when the original or repeated measurement is ≥ 1.45 W/kg ($\sim 10\%$ from the 1-g SAR limit).
3. Perform a third repeated measurement only if the original, first or second repeated measurement is ≥ 1.5 W/kg and the ratio of largest to smallest SAR for the original, first and second repeated measurements is > 1.20 .

➤ Test Results

Plot No.	Band/Mode	Test Position	CH.	Ave. Power (dBm)	Tune-up Limit (dBm)	Tune-up Scaling Factor	Meas. SAR _{1g} (W/kg)	Reported SAR _{1g} (W/kg)
OR.	LTE Band 4/1RB#0 20M	Bottom Side	20300	22.97	23.50	1.130	1.02	1.152
1 st	LTE Band 4/1RB#0 20M	Bottom Side	20300	22.97	23.50	1.130	1.21	1.367



17. Simultaneous Transmission Evaluation

17.1. Simultaneous Transmission Consideration

No.	Simultaneous Transmission Consideration	Head	Body-Worn	Hotspot
1	WWAN + WLAN 2.4GHz	Yes	Yes	Yes
2	WWAN + Bluetooth	No	Yes	No

Note:

1. When the user enables the personal wireless router functions for the handset, actual operations include simultaneous transmission of the WWAN and WLAN transmitters. The "Portable Hotspot" feature on the handset was NOT activated, to ensure the SAR measurements were evaluated for a single transmission frequency RF signal.
2. The hotspot SAR result may overlap with the body-worn accessory SAR requirements, per KDB 941225 D06, the more conservative configurations can be considered, thus excluding some unnecessary body-worn accessory SAR tests.
3. Simultaneous Transmission SAR evaluation is not required for BT and WLAN, because the software mechanism have been incorporated to guarantee that the WLAN and Bluetooth transmitters would not simultaneously operate.
4. Per KDB 447498D01v06, simultaneous transmission SAR evaluation procedures is as followed:
Step 1: If sum of 1 g SAR < 1.6 W/kg, Simultaneous SAR measurement is not required.
Step 2: If sum of 1 g SAR > 1.6 W/kg, ratio of SAR to peak separation distance for pair of transmitters calculated.
Step 3: If the ratio of SAR to peak separation distance is ≤ 0.04 , Simultaneous SAR measurement is not required.
Step 4: If the ratio of SAR to peak separation distance is > 0.04 , Simultaneous SAR measurement is required and simultaneous transmission SAR value is calculated.
(The ratio is determined by: $(SAR1 + SAR2) \wedge 1.5/Ri \leq 0.04$,
Ri is the separation distance between the peak SAR locations for the antenna pair in mm.



17.2. Simultaneous Transmission Analysis

➤ Head Simultaneous Transmission for WWAN(2/3/4G)+WLAN

WWAN Band	Exposure Position	1	2	1+2 Summed 1g SAR (W/kg)
		WWAN	2.4GHz WLAN	
		1g SAR(W/kg)	1g SAR(W/kg)	
GSM850	Right Cheek	0.069	0.162	0.231
	Right Tilt	0.032	0.149	0.181
	Left Cheek	0.056	0.279	0.335
	Left Tilt	0.030	0.365	0.395
GSM1900	Right Cheek	0.116	0.162	0.278
	Right Tilt	0.067	0.149	0.216
	Left Cheek	0.119	0.279	0.398
	Left Tilt	0.087	0.365	0.452
WCDMA II	Right Cheek	0.024	0.162	0.186
	Right Tilt	0.014	0.149	0.163
	Left Cheek	0.030	0.279	0.309
	Left Tilt	0.011	0.365	0.376
WCDMA IV	Right Cheek	0.120	0.162	0.282
	Right Tilt	0.061	0.149	0.210
	Left Cheek	0.119	0.279	0.398
	Left Tilt	0.060	0.365	0.425
WCDMA V	Right Cheek	0.049	0.162	0.211
	Right Tilt	0.022	0.149	0.171
	Left Cheek	0.040	0.279	0.319
	Left Tilt	0.021	0.365	0.386
LTE Band 2	Right Cheek	0.061	0.162	0.223
	Right Tilt	0.034	0.149	0.183
	Left Cheek	0.081	0.279	0.360
	Left Tilt	0.032	0.365	0.397
LTE Band 4	Right Cheek	0.142	0.162	0.304
	Right Tilt	0.099	0.149	0.248
	Left Cheek	0.106	0.279	0.385
	Left Tilt	0.092	0.365	0.457
LTE Band 5	Right Cheek	0.036	0.162	0.198
	Right Tilt	0.018	0.149	0.167
	Left Cheek	0.039	0.279	0.318



	Left Tilt	0.020	0.365	0.385
LTE Band 7	Right Cheek	0.012	0.162	0.174
	Right Tilt	0.011	0.149	0.160
	Left Cheek	0.020	0.279	0.299
	Left Tilt	0.098	0.365	0.463
LTE Band 12	Right Cheek	0.127	0.162	0.289
	Right Tilt	0.092	0.149	0.241
	Left Cheek	0.148	0.279	0.427
	Left Tilt	0.088	0.365	0.453
LTE Band 17	Right Cheek	0.171	0.162	0.333
	Right Tilt	0.097	0.149	0.246
	Left Cheek	0.160	0.279	0.439
	Left Tilt	0.100	0.365	0.465
LTE Band 66	Right Cheek	0.152	0.162	0.314
	Right Tilt	0.078	0.149	0.227
	Left Cheek	0.130	0.279	0.409
	Left Tilt	0.065	0.365	0.430

➤ **Body Simultaneous Transmission for WWAN+WLAN/Bluetooth**

WWAN Band	Exposure Position	1	2	3	1+2 Summed 1g SAR (W/kg)	1+3 Summed 1g SAR (W/kg)
		WWAN	2.4GHz WLAN	Bluetooth (Estimated)		
		1g SAR (W/kg)	1g SAR (W/kg)	1g SAR (W/kg)		
GSM 850	Front Side	0.048	0.215	0.159	0.263	0.207
	Back Side	0.177	0.259	0.159	0.436	0.336
	Left Side	0.044			0.044	0.044
	Right Side	0.079	0.246		0.325	0.079
	Top Side		0.213		0.213	
	Bottom Side	0.267			0.267	0.267
GSM 1900	Front Side	0.385	0.215	0.159	0.600	0.544
	Back Side	0.483	0.259	0.159	0.742	0.642
	Left Side	0.153			0.153	0.153
	Right Side	0.072	0.246		0.318	0.072
	Top Side		0.213		0.213	
	Bottom Side	0.809			0.809	0.809
WCDMA II	Front Side	0.058	0.215	0.159	0.273	0.217
	Back Side	0.113	0.259	0.159	0.372	0.272
	Left Side	0.033			0.033	0.033
	Right Side	0.021	0.246		0.267	0.021



	Top Side		0.213		0.213	
	Bottom Side	0.332			0.332	0.332
WCDMA IV	Front Side	0.256	0.215	0.159	0.471	0.415
	Back Side	0.244	0.259	0.159	0.503	0.403
	Left Side	0.125			0.125	0.125
	Right Side	0.104	0.246		0.350	0.104
	Top Side		0.213		0.213	
	Bottom Side	0.683			0.683	0.683
WCDMA V	Front Side	0.036	0.215	0.159	0.251	0.195
	Back Side	0.145	0.259	0.159	0.404	0.304
	Left Side	0.064			0.064	0.064
	Right Side	0.029	0.246		0.275	0.029
	Top Side		0.213		0.213	
	Bottom Side	0.117			0.117	0.117
LTE Band 2	Front Side	0.184	0.215	0.159	0.399	0.343
	Back Side	0.261	0.259	0.159	0.520	0.420
	Left Side	0.093			0.093	0.093
	Right Side	0.056	0.246		0.302	0.056
	Top Side		0.213		0.213	
	Bottom Side	0.660			0.660	0.660
LTE Band 4	Front Side	0.510	0.215	0.159	0.725	0.669
	Back Side	0.781	0.259	0.159	1.040	0.940
	Left Side	0.216			0.216	0.216
	Right Side	0.198	0.246		0.444	0.198
	Top Side		0.213		0.213	0.000
	Bottom Side	1.367			1.367	1.367
LTE Band 5	Front Side	0.034	0.215	0.159	0.249	0.193
	Back Side	0.075	0.259	0.159	0.334	0.234
	Left Side	0.029			0.029	0.029
	Right Side	0.061	0.246		0.307	0.061
	Top Side		0.213		0.213	
	Bottom Side	0.284			0.284	0.284
LTE Band 7	Front Side	0.078	0.215	0.159	0.293	0.237
	Back Side	0.188	0.259	0.159	0.447	0.347
	Left Side	0.054			0.054	0.054
	Right Side	0.215	0.246		0.461	0.215
	Top Side		0.213		0.213	
	Bottom Side	0.413			0.413	0.413
LTE Band 12	Front Side	0.167	0.215	0.159	0.382	0.326
	Back Side	0.407	0.259	0.159	0.666	0.566
	Left Side	0.169			0.169	0.169



	Right Side	0.255	0.246		0.501	0.255
	Top Side		0.213		0.213	
	Bottom Side	0.163			0.163	0.163
LTE Band 17	Front Side	0.240	0.215	0.159	0.455	0.399
	Back Side	0.454	0.259	0.159	0.713	0.613
	Left Side	0.170			0.170	0.170
	Right Side	0.248	0.246		0.494	0.248
	Top Side		0.213		0.213	
	Bottom Side	0.161			0.161	0.161
LTE Band 66	Front Side	0.366	0.215	0.159	0.581	0.525
	Back Side	0.360	0.259	0.159	0.619	0.519
	Left Side	0.142			0.142	0.142
	Right Side	0.124	0.246		0.370	0.124
	Top Side		0.213		0.213	
	Bottom Side	0.729			0.729	0.729



18. Uncertainty Assessment

According to KDB 865664 D01 SAR measurement 100 MHz to 6GHz, when the highest measured 1-g SAR is less than 1.5 W/kg and 10-g extremity SAR less than 3.75 W/kg, the expanded SAR measurement uncertainty must be less than 30% with a confidence interval of $k=2$. When these conditions are met, extensive SAR measurement uncertainty analysis described in IEEE 1528-2013 is not required in the SAR report and submitted for equipment approval. For this device, both the 1-g SAR is less than 1.5 W/kg and 10-g extremity SAR less than 3.75 W/kg. Therefore the measurement uncertainty table is not required in this report.



Annex A General Information

1. Identification of the Responsible Testing Laboratory

Laboratory Name:	Shenzhen Morlab Communications Technology Co., Ltd.
Laboratory Address:	FL.3, Building A, FeiYang Science Park, No.8 LongChang Road, Block 67, BaoAn District, ShenZhen, Guangdong Province, P. R. China
Telephone:	+86 755 36698555
Facsimile:	+86 755 36698525

2. Identification of the Responsible Testing Location

Name:	Shenzhen Morlab Communications Technology Co., Ltd.
Address:	FL.3, Building A, FeiYang Science Park, No.8 LongChang Road, Block 67, BaoAn District, ShenZhen, Guangdong Province, P. R. China

3. Facilities and Accreditations

The FCC designation number is CN1192, the test firm registration number is 226174.

Note:

The main report is end here and the other Annex (B,C,D,E,F) will be submitted separately.

***** END OF MAIN REPORT *****