



Mobile Antenna SEPC

HEYUAN XUNWEI MICROWAVE
COMMUNICATION CO.,LTD

RF: Chenchuanming

Date: 2023.10.20

Office address: Zone M, 8/F, Building 1, Baisha Xinxing Industrial Park, No. 3011,
Shahe West Road, Nanshan District, Shenzhen

Contents:

Test equipment

Modal information

Matching circuit

Active performance

Test data

Test equipment

Wireless communications test set: CMW500

Network Analyzer: Agilent 5071B

Anechoic Chamber : SATIMO SG24



Antenna information

Customer	Boat of wealth		
Antenna model	LTE-B,XW-G/W, LTE XW 59G-4-3-F10-T1		
Antenna type	PIFA		
Antenna band	GSM900/1800/850/1900 WCDMA-B2/B4/B5 LTE-B2/B4/B5/B12/B17/B25/ B26/B66/B71/B41		
frequency range (MHz)	617-960	1710-2170	2500-2700
VSWR	<3.0	<3.0	<3.0

Matching circuit (No modification)

RF modal

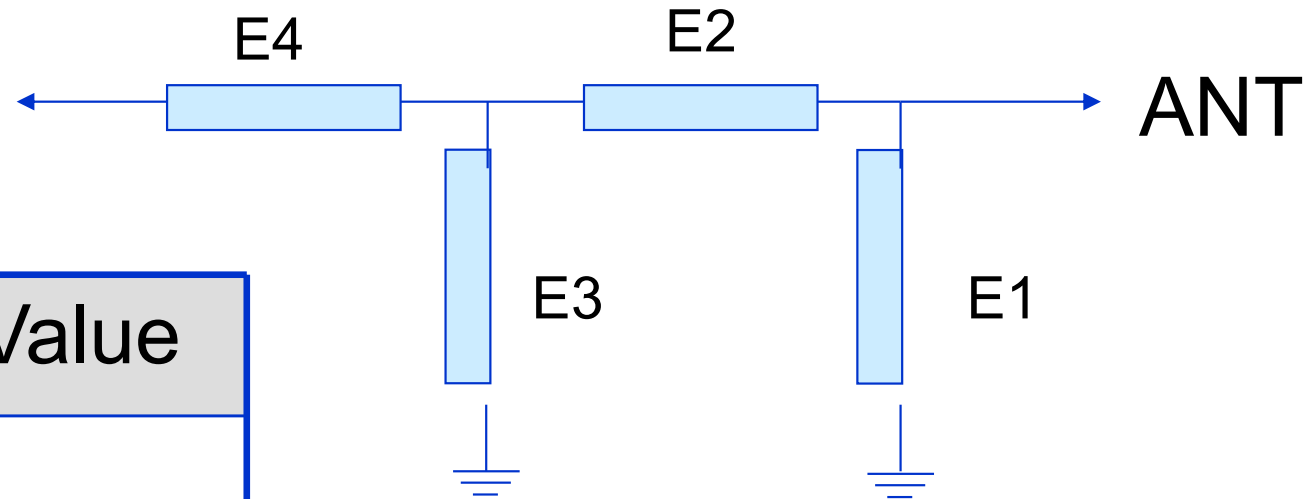

Element	Value
E1	
E2	
E3	
E4	

2.3 Main antenna Peak Gain(617~960M)

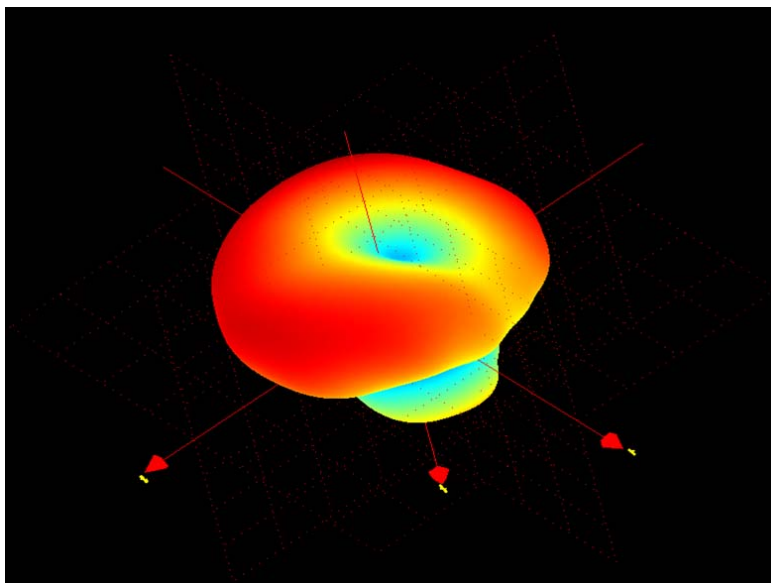
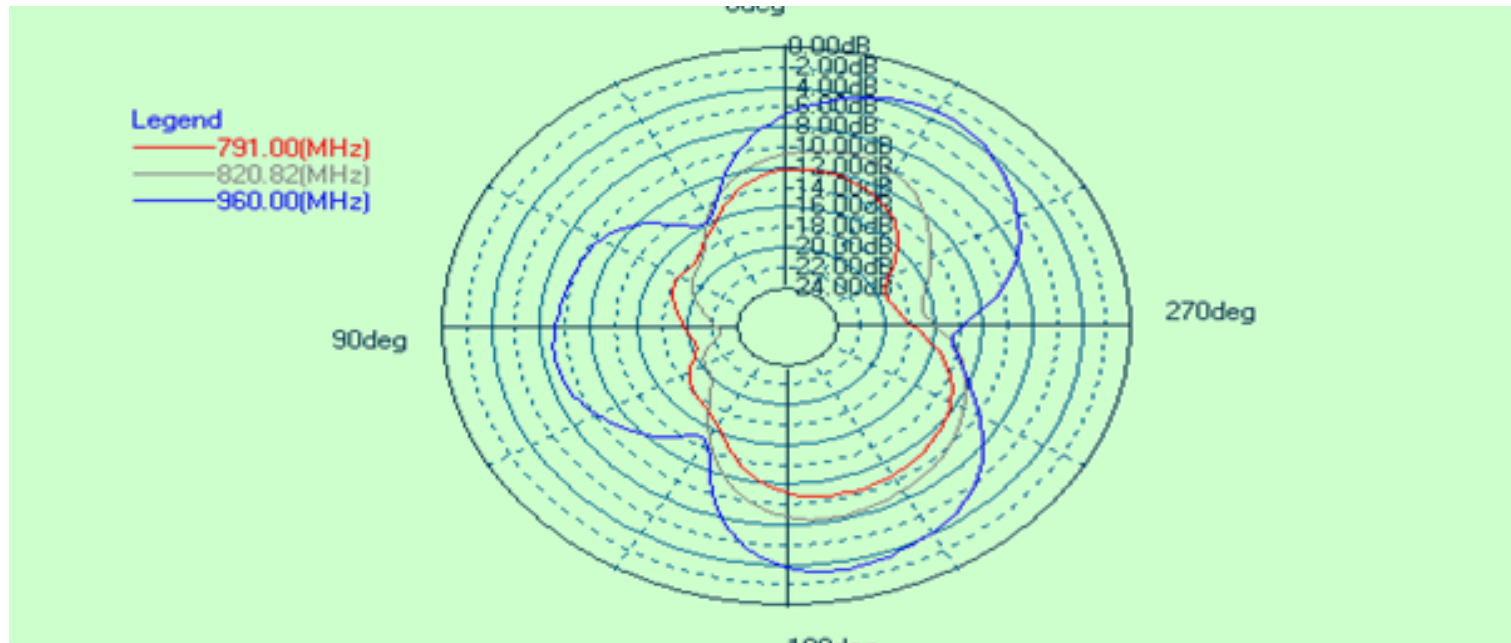

Freq.(MHZ)	Peak .Gain	Effi.(%)
900	-1.91	28

2.3 DIV antenna Peak Gain(1710~2170M)

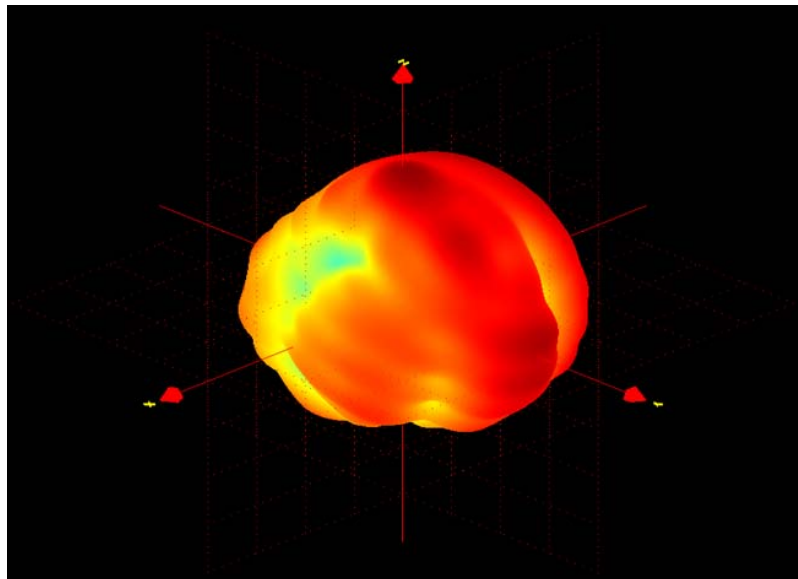
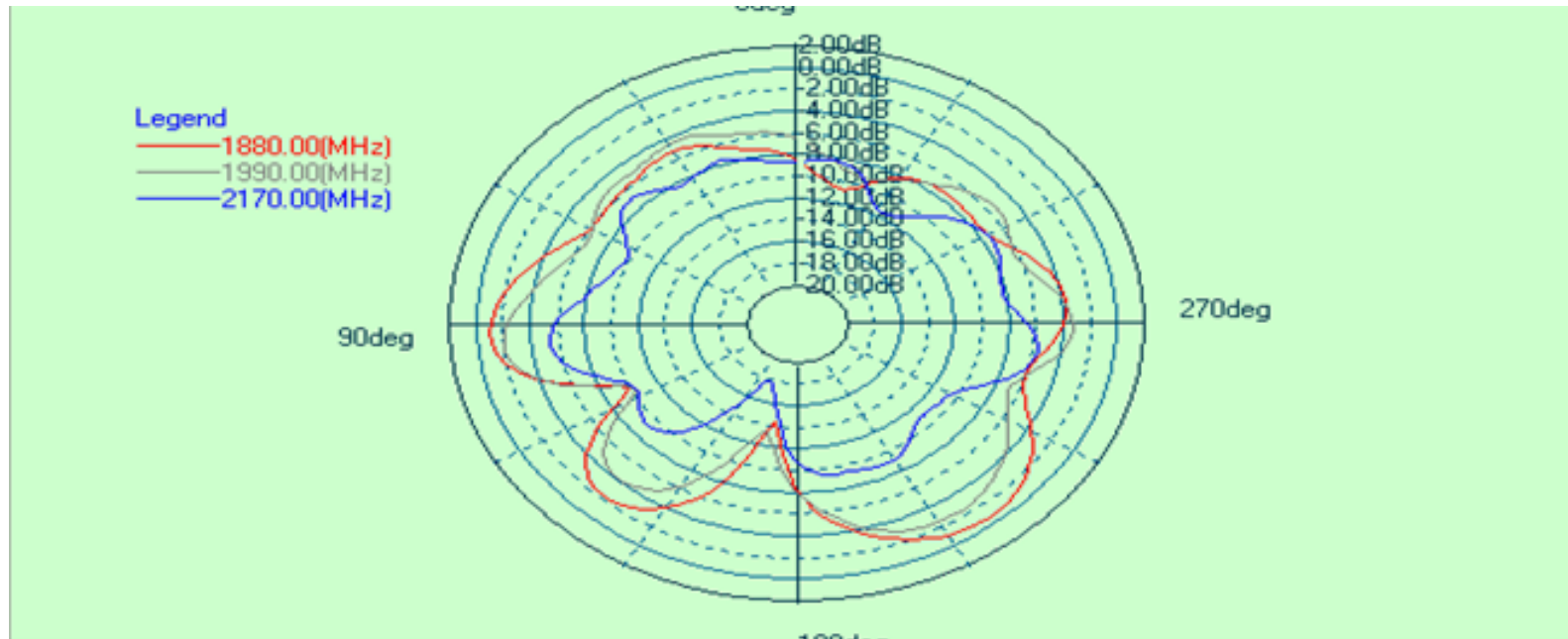

Freq.(MHZ)	Peak .Gain	Effi.(%)
1880	-1.23	37

2.3 DIV antenna Peak Gain(2490~2700M)

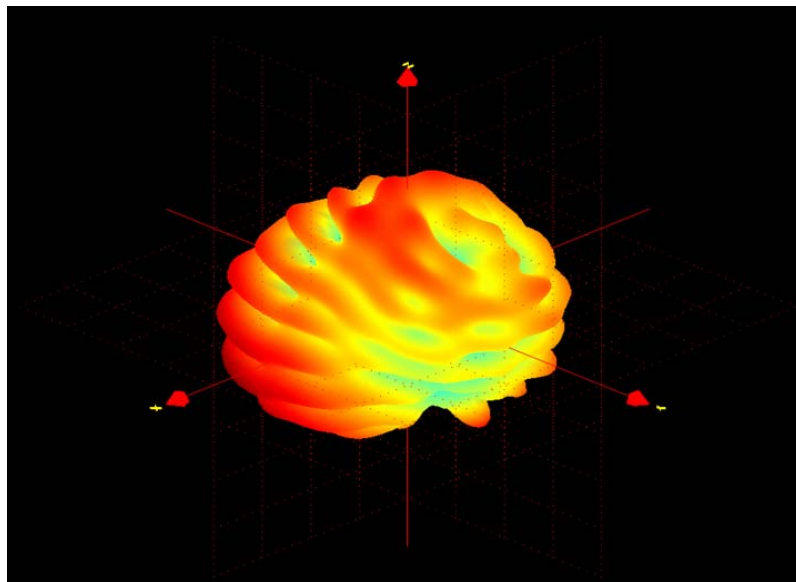
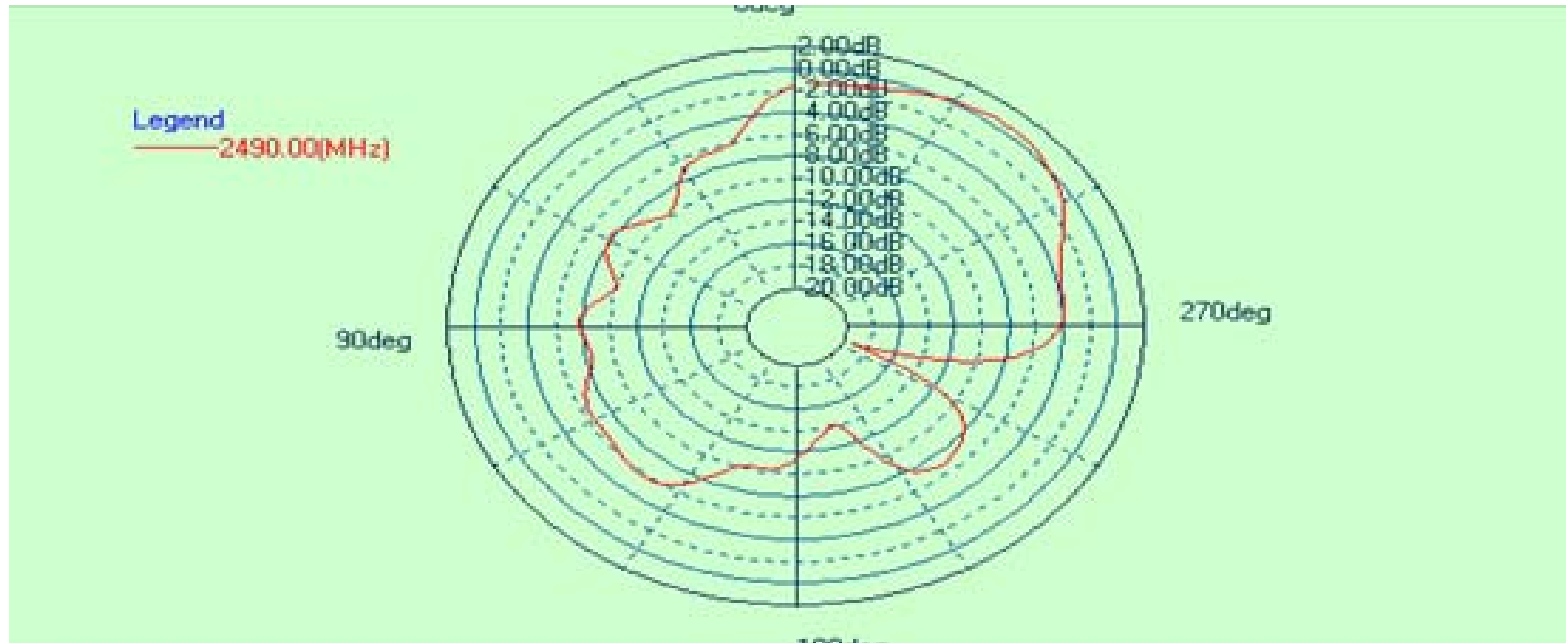

Freq.(MHZ)	Peak .Gain	Effi.(%)
2490	-1.58	27

2.3 G/W/B antenna Peak Gain(1575M)

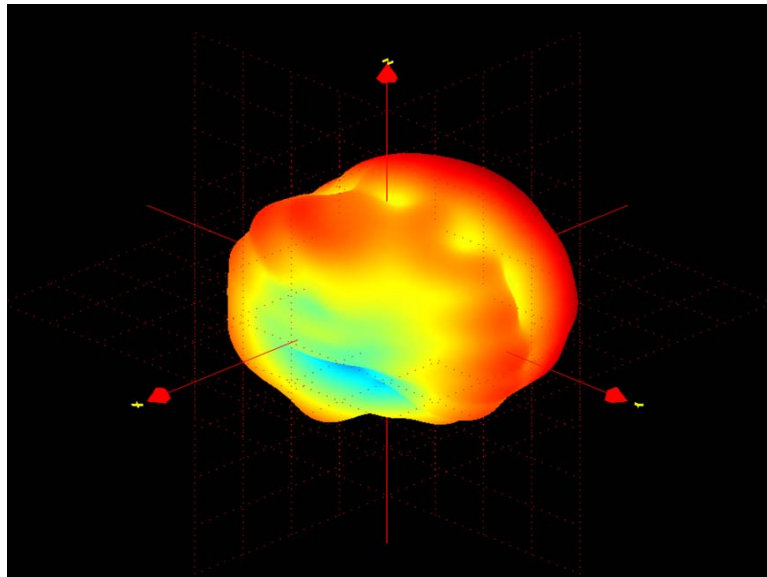
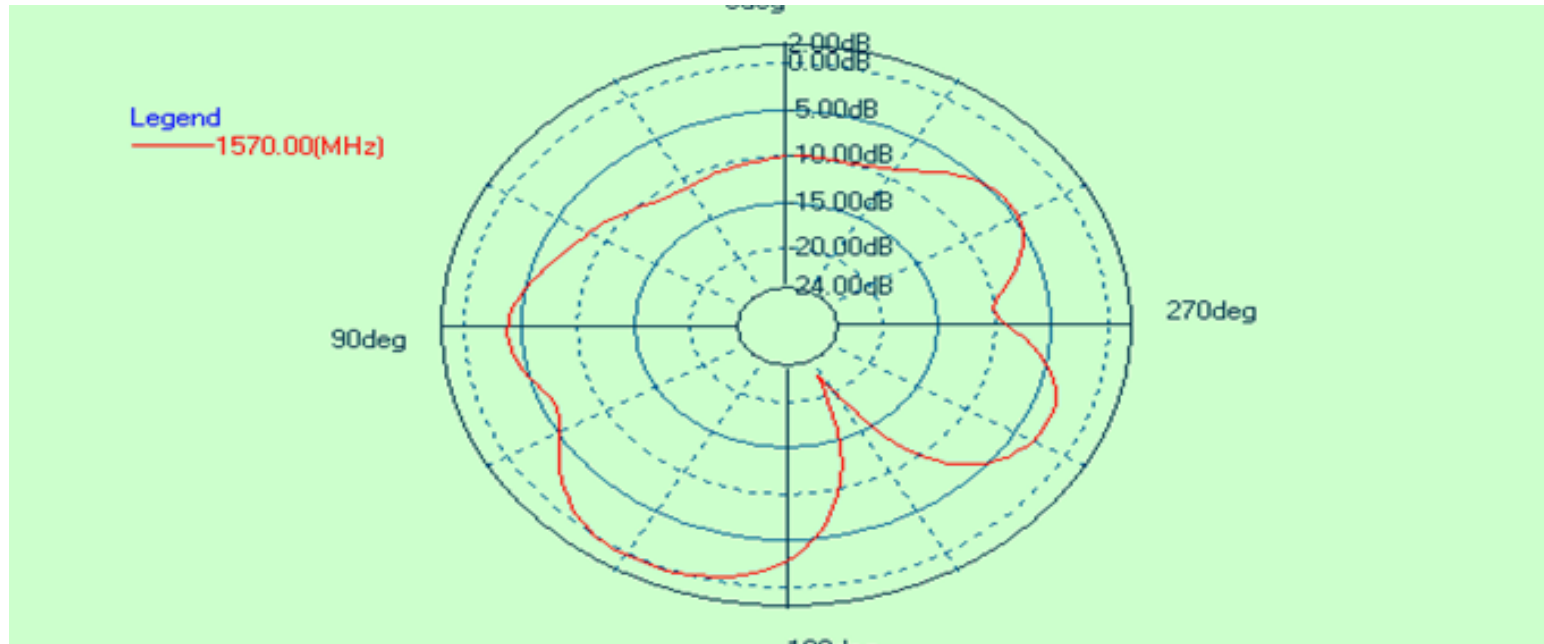

Freq.(MHZ)	Peak .Gain	Effi.(%)
1575	-1.12	37

2.3 G/W/B antenna Peak Gain(2400-2500M)

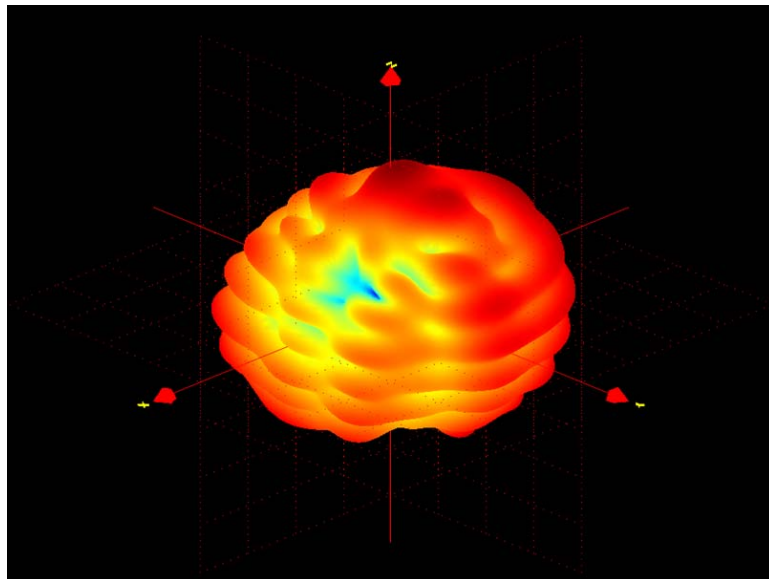
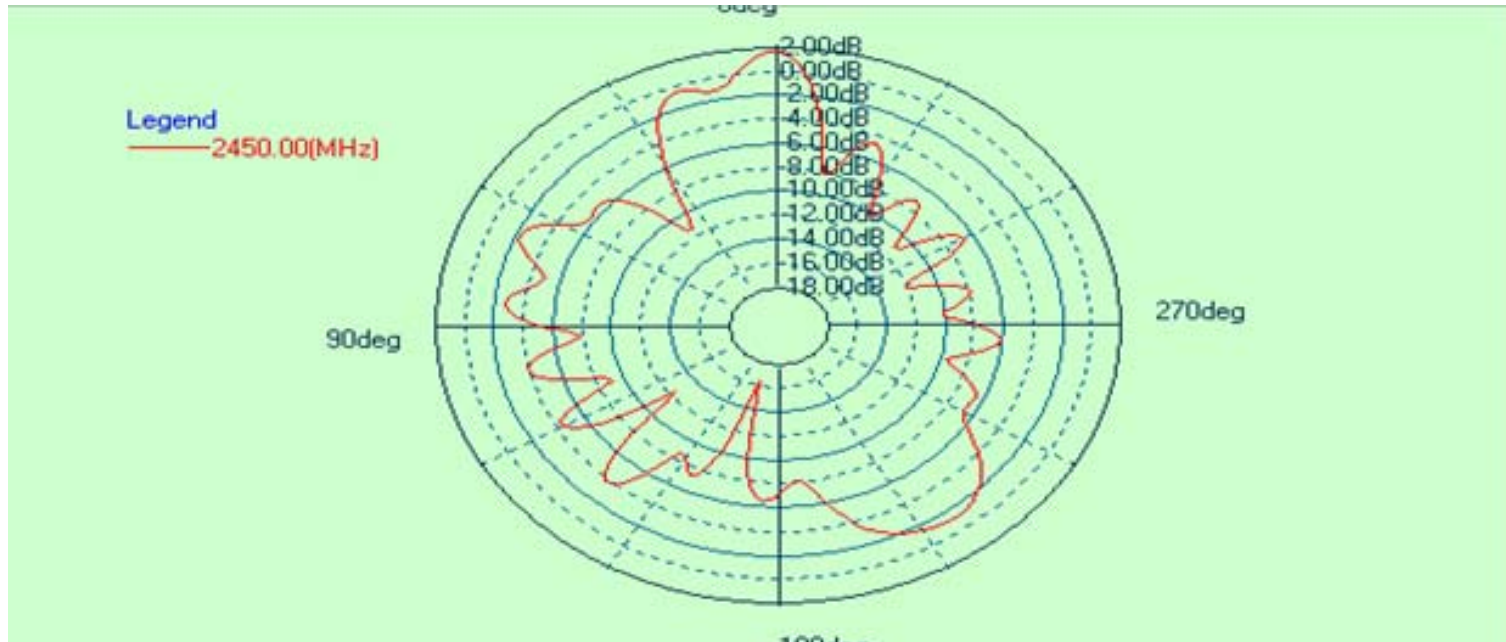

Freq.(MHZ)	Peak .Gain	Effi.(%)
2450	-1.45	35

2.3 G/W/B antenna Peak Gain(5100-5800M)

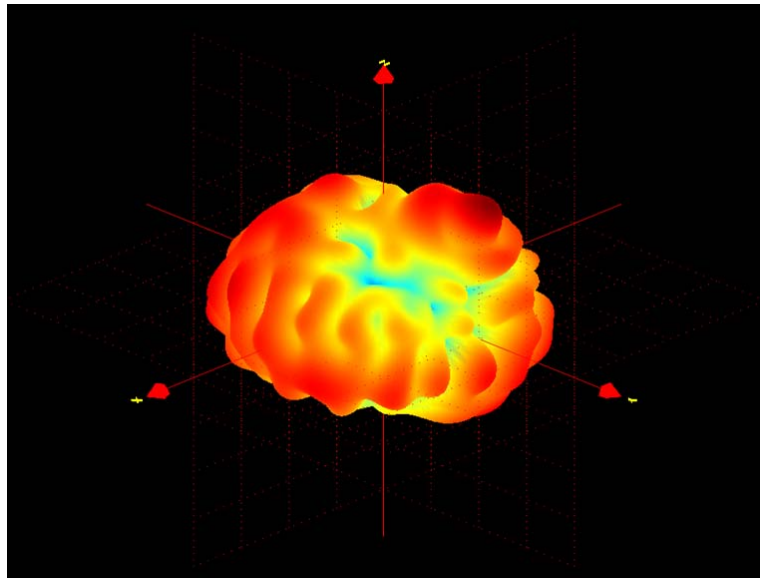
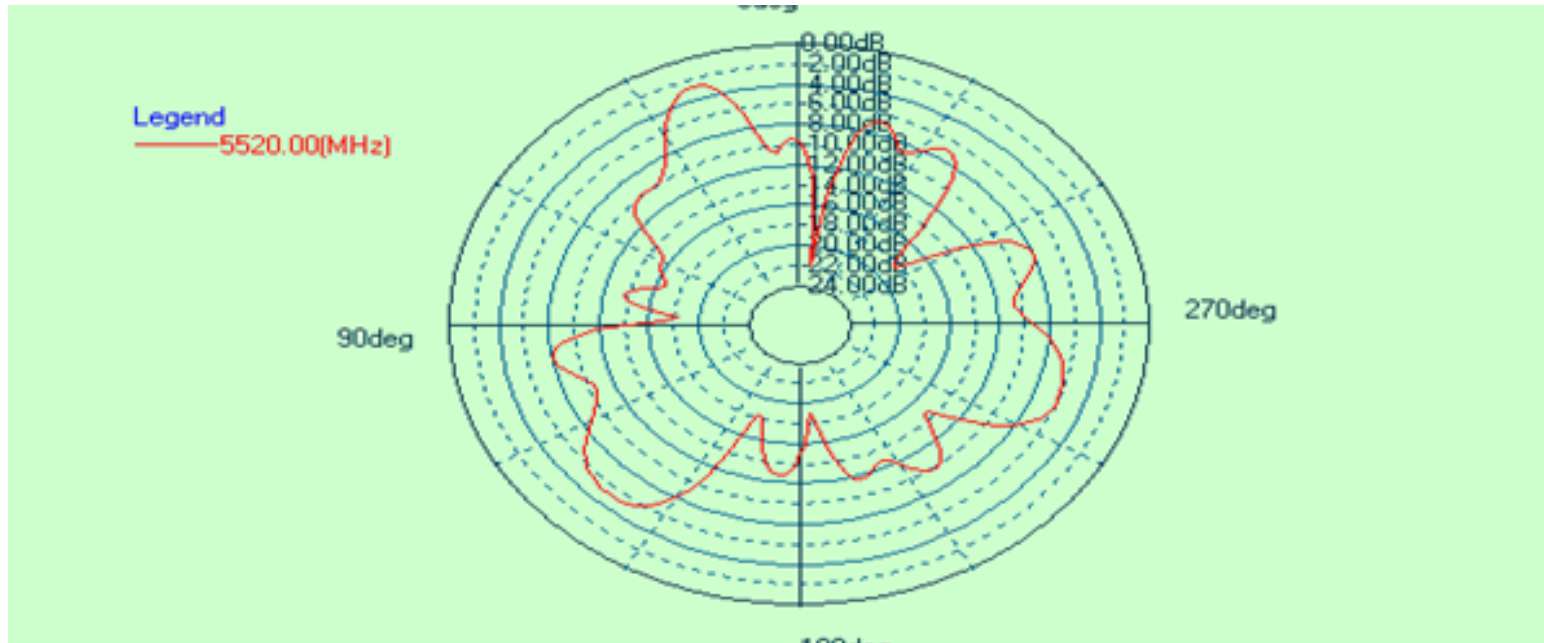

Freq.(MHZ)	Peak .Gain	Effi.(%)
5450	-2.01	28

LTE Antenna gain

All of Implementation antenna

Main antenna(Antenna Label:A):

LTE B5/B12/B17/B26/B71 RX&TX

WCDMA B5 RX&TX

GSM B5/B8 RX&TX

DIV antenna(Antenna Label:B):

LTE B2/B4/B25/B41/B66 RX&TX

WCDMA B2/B4 RX&TX

GSM B2/B3 RX&TX

WiFi/BT 2.4~2.5G/5.1~5.8G/2412MHz~2472MHz&/5100MHz~5800MHz

GPS: 1575.42 MHz

Antenna Max. Peak Gain:

GSM900: -1.91dBi

GSM850: -1.48dBi

DCS1800: -1.23dBi

PCS1900: -1.47dBi

W2: -1.47dBi

W4: -1.23dBi

W5: -1.48dBi

LTE-B2: -1.47dBi

LTE-B4: -1.23dBi

LTE-B5: -1.48dBi

LTE-B12: -1.74dBi

LTE-B17: -1.74dBi

LTE-B25: -1.47dBi

LTE-B26: -1.90dBi

LTE-B66: -1.23dBi

LTE-B71: -2.1dBi

LTE-B41: -1.58dBi

WIFI (5G) : -2.01dBi

WIFI (2.4G) : -1.45dBi

BT: -1.45dBi

GPS: -1.41dBi

TOP

