

### LTE Band XII (Part 27)

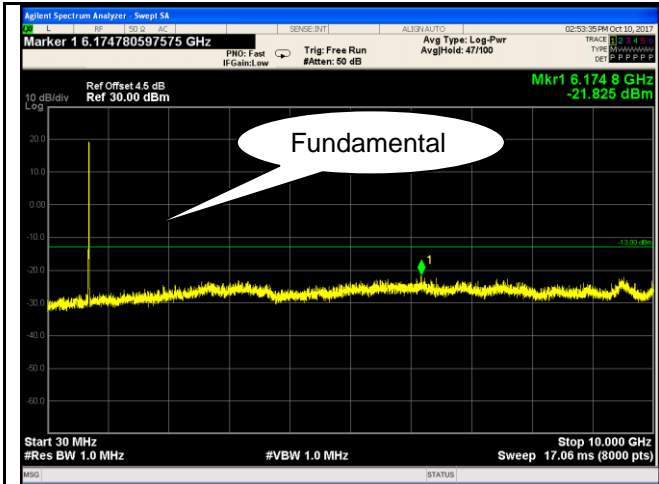

LTE Band XII - Low Channel-1

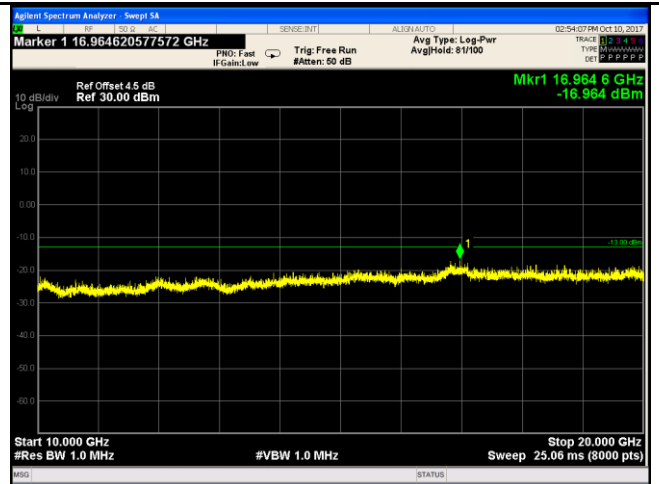

LTE Band XII - Low Channel-2

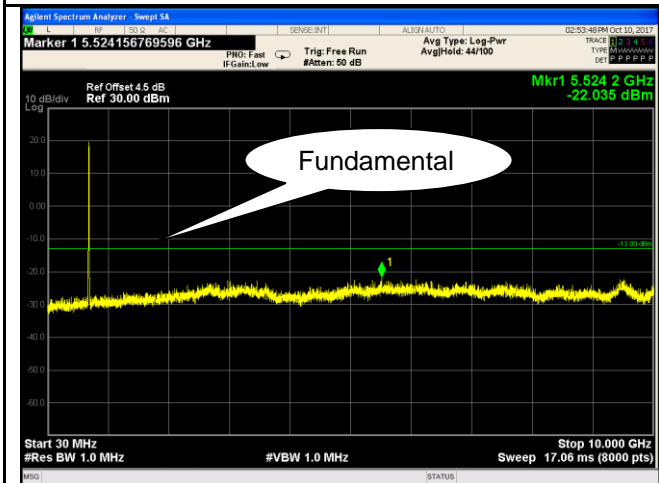

LTE Band XII - Middle Channel-1

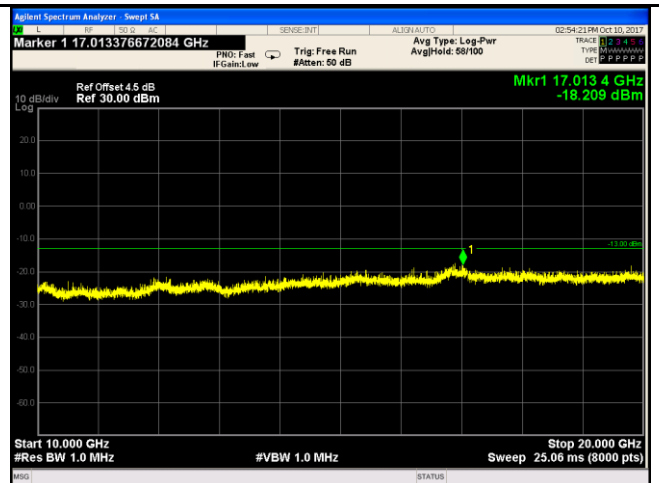

LTE Band XII - Middle Channel-2

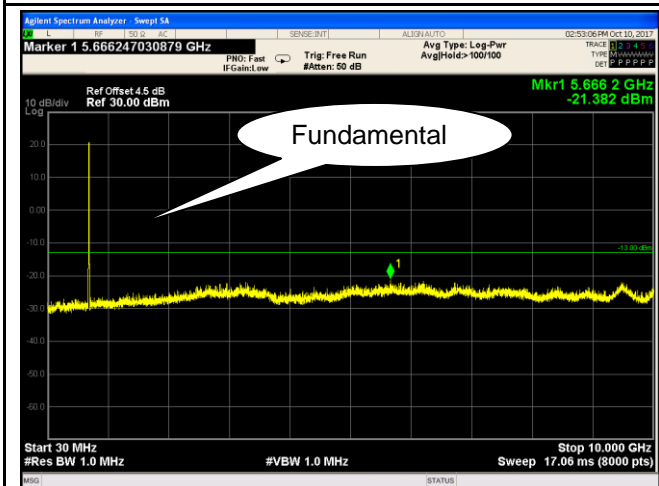

LTE Band XII - High Channel-1

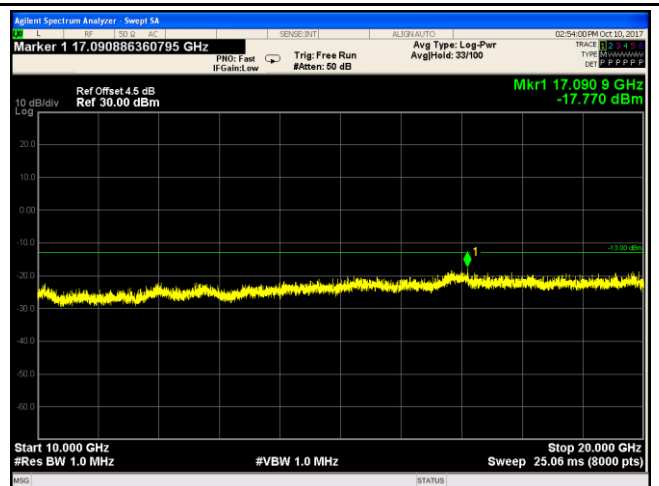

LTE Band XII - High Channel-2

### LTE Band XVII (Part 27)

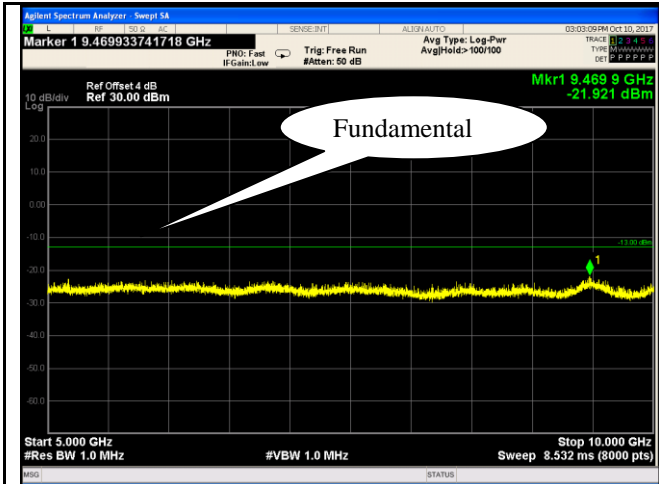

LTE Band XVII - Low Channel-1

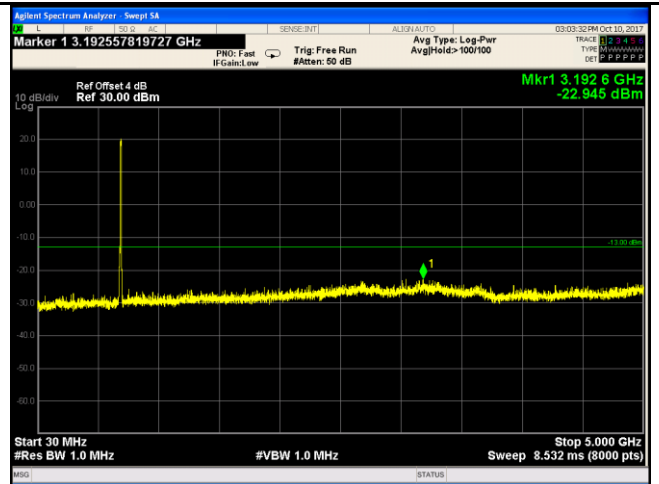

LTE Band XVII - Low Channel-2

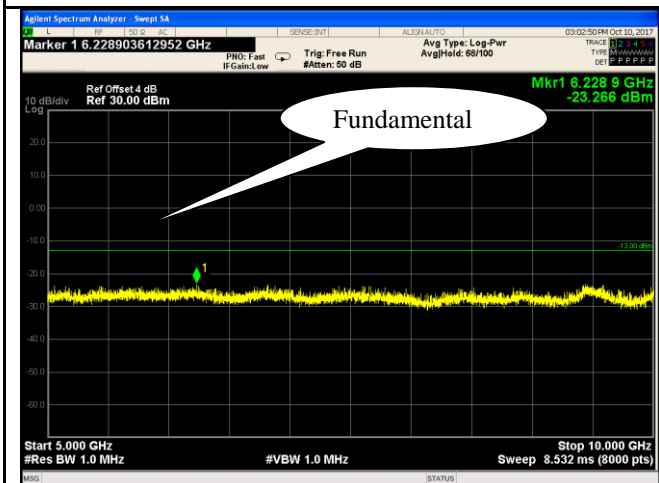

LTE Band XVII - Middle Channel-1

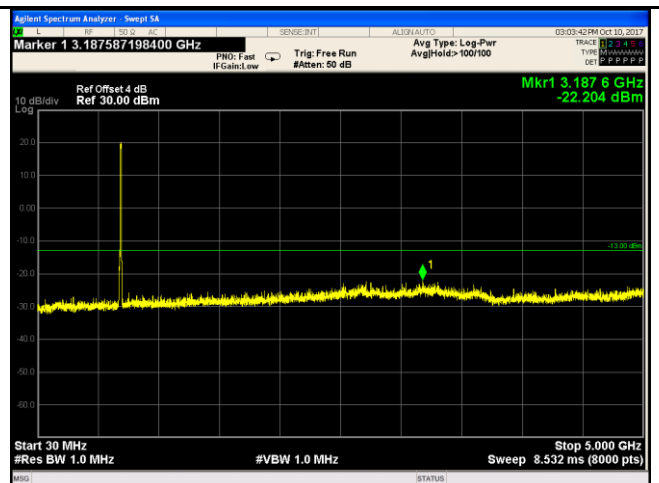

LTE Band XVII - Middle Channel-2

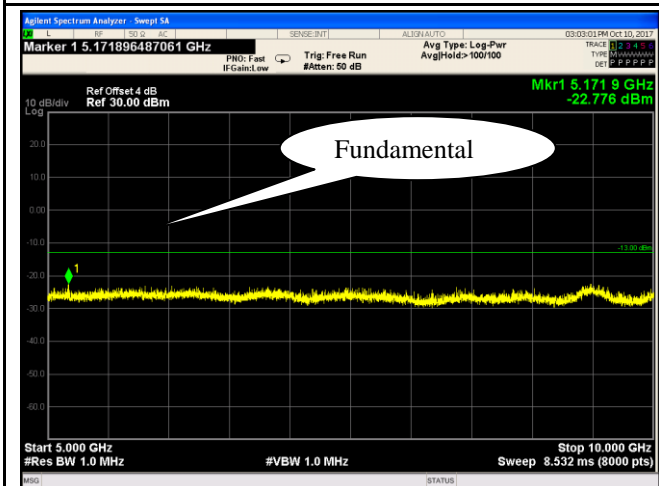

LTE Band XVII - High Channel-1

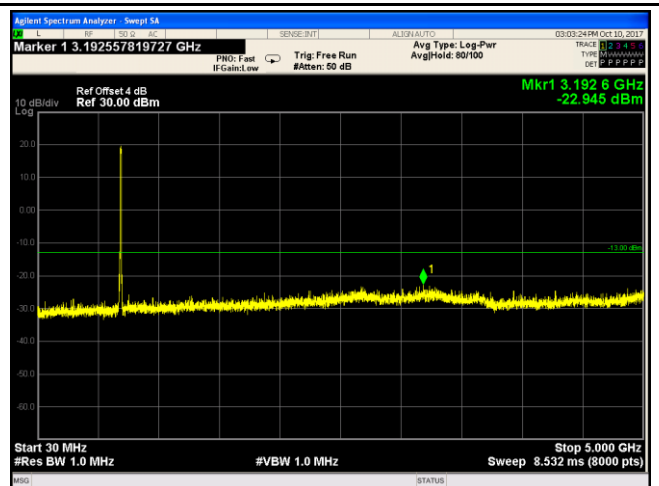

LTE Band XVII - High Channel-2

## 6.6 Spurious Radiated Emissions

Temperature	25°C
Relative Humidity	55%
Atmospheric Pressure	1012mbar
Test date :	October 10, 2017
Tested By :	Loren Luo

### Requirement(s):

Spec	Item	Requirement	Applicable
§2.1053, §22.917 & §24.238 § 27.53(h)	a)	The power of any emission outside of the authorized operating frequency ranges must be attenuated below the transmitter power (P) by a factor of at least $43 + 10 \log (P)$ dB. The spectrum is scanned from 30 MHz up to a frequency including its 10th harmonic.	<input checked="" type="checkbox"/>

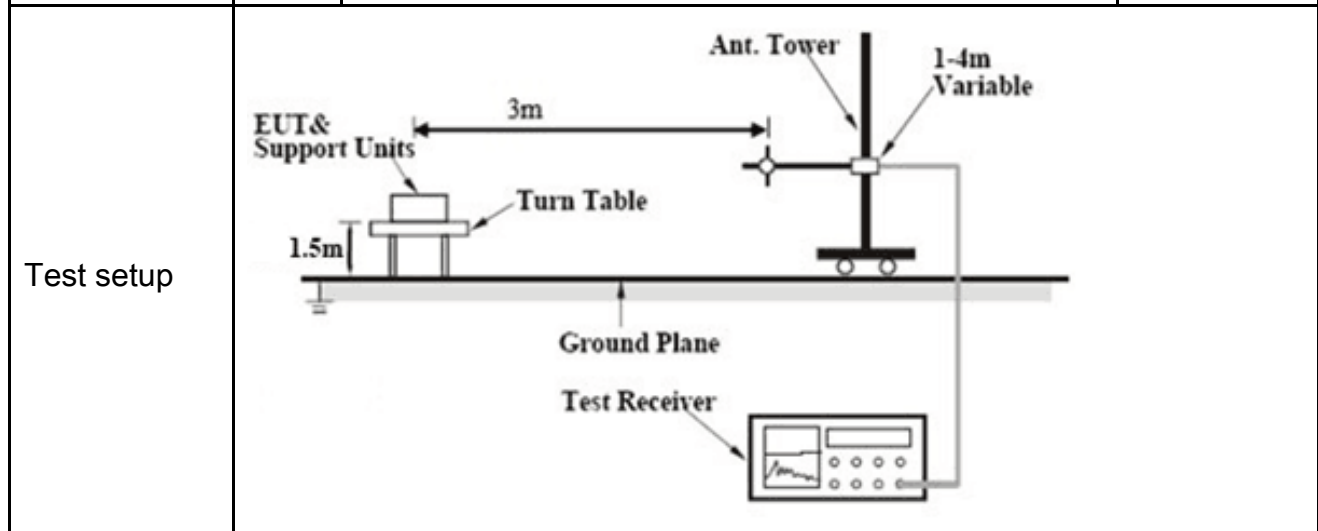

Test Procedure	<ol style="list-style-type: none"> <li>The transmitter was placed on a wooden turntable, and it was transmitting into a non-radiating load which was also placed on the turntable.</li> <li>The measurement antenna was placed at a distance of 3 meters from the EUT. During the tests, the antenna height and polarization as well as EUT azimuth were varied in order to identify the maximum level of emissions from the EUT. The test was performed by placing the EUT on 3-orthogonal axis.</li> <li>Remove the EUT and replace it with substitution antenna. A signal generator was connected to the substitution antenna by a non-radiating cable. The absolute levels of the spurious emissions were measured by the substitution.</li> </ol> <p>Sample Calculation:</p> $\text{EUT Field Strength} = \text{Raw Amplitude (dB}\mu\text{V/m)} - \text{Amplifier Gain (dB)} + \text{Antenna Factor (dB)} + \text{Cable Loss (dB)} + \text{Filter Attenuation (dB, if used)}$
----------------	---

Test Report	17070978-FCC-R5
Page	85 of 140

Remark	
Result	<input checked="" type="checkbox"/> Pass <input type="checkbox"/> Fail

Test Data  Yes  N/A  
 Test Plot  Yes (See below)  N/A

## LTE Band II (Part 24E) result

### Low channel

Frequency (MHz)	Substituted level (dBm)	Polarity (H/V)	Antenna Gain Correction (dB)	Cable Loss (dB)	Corrected Reading (dBm)	Limit (dBm)	Margin (dB)
3720	-45.68	V	10.25	2.73	-38.16	-13	-25.16
3720	-46.75	H	10.25	2.73	-39.23	-13	-26.23
101.8	-52.31	V	-0.09	0.16	-52.56	-13	-39.56
696.8	-53.92	H	6.34	0.44	-48.02	-13	-35.02

### Middle channel

Frequency (MHz)	Substituted level (dBm)	Polarity (H/V)	Antenna Gain Correction (dB)	Cable Loss (dB)	Corrected Reading (dBm)	Limit (dBm)	Margin (dB)
3760	-45.67	V	10.25	2.73	-38.15	-13	-25.15
3760	-46.85	H	10.25	2.73	-39.33	-13	-26.33
150.9	-56.31	V	0.97	0.14	-55.48	-13	-42.48
967.3	-54.27	H	6.4	0.42	-48.29	-13	-35.29

### High channel

Frequency (MHz)	Substituted level (dBm)	Polarity (H/V)	Antenna Gain Correction (dB)	Cable Loss (dB)	Corrected Reading (dBm)	Limit (dBm)	Margin (dB)
3800	-43.25	V	10.36	2.73	-35.62	-13	-22.62
3800	-44.87	H	10.36	2.73	-37.24	-13	-24.24
573.3	-54.12	V	6.34	0.4	-48.18	-13	-35.18
810.8	-53.29	H	6.2	0.46	-47.55	-13	-34.55

#### Note:

- 1, The testing has been conformed to  $10 \times 1907.5 \text{ MHz} = 19,075 \text{ MHz}$
- 2, All other emissions more than 30 dB below the limit
- 3, X-Axis, Y-Axis and Z-Axis were investigated. The results above show only the worst case.
- 4, The radiated spurious test above 18GHz is subcontracted to SIEMIC (Nanjing-China) Laboratories. and found 30dB below the limit at least.

## LTE Band IV (Part27) result

### Low channel

Frequency (MHz)	Substituted level (dBm)	Polarity (H/V)	Antenna Gain Correction (dB)	Cable Loss (dB)	Corrected Reading (dBm)	Limit (dBm)	Margin (dB)
3440	-44.95	V	10.06	2.52	-37.41	-13	-24.41
3440	-45.82	H	10.06	2.52	-38.28	-13	-25.28
277.8	-56.13	V	6.04	0.28	-50.37	-13	-37.37
760.8	-57.28	H	6.37	0.42	-51.33	-13	-38.33

### Middle channel

Frequency (MHz)	Substituted level (dBm)	Polarity (H/V)	Antenna Gain Correction (dB)	Cable Loss (dB)	Corrected Reading (dBm)	Limit (dBm)	Margin (dB)
3465	-46.32	V	10.09	2.52	-38.75	-13	-25.75
3465	-48.15	H	10.09	2.52	-40.58	-13	-27.58
107.2	-59.62	V	-0.12	0.13	-59.87	-13	-46.87
721.2	-57.22	H	6.27	0.44	-51.39	-13	-38.39

### High channel

Frequency (MHz)	Substituted level (dBm)	Polarity (H/V)	Antenna Gain Correction (dB)	Cable Loss (dB)	Corrected Reading (dBm)	Limit (dBm)	Margin (dB)
3490	-43.75	V	10.09	2.52	-36.18	-13	-23.18
3490	-44.61	H	10.09	2.52	-37.04	-13	-24.04
52.3	-53.16	V	-4.43	0.07	-57.66	-13	-44.66
836.9	-53.21	H	6.2	0.47	-47.48	-13	-34.48

#### Note:

- 1, The testing has been conformed to  $10 \times 1752.5 \text{MHz} = 17,525 \text{MHz}$
- 2, All other emissions more than 30 dB below the limit
- 3, X-Axis, Y-Axis and Z-Axis were investigated. The results above show only the worst case.

## LTE Band VII (Part27) result

### Low channel

Frequency (MHz)	Substituted level (dBm)	Polarity (H/V)	Antenna Gain Correction (dB)	Cable Loss (dB)	Corrected Reading (dBm)	Limit (dBm)	Margin (dB)
5020	-46.15	V	10.29	0.98	-36.84	-13	-23.84
5020	-49.32	H	10.29	0.98	-40.01	-13	-27.01
307	-51.26	V	5.62	0.23	-45.87	-13	-32.87
571.6	-54.77	H	6.45	0.35	-48.67	-13	-35.67

### Middle channel

Frequency (MHz)	Substituted level (dBm)	Polarity (H/V)	Antenna Gain Correction (dB)	Cable Loss (dB)	Corrected Reading (dBm)	Limit (dBm)	Margin (dB)
5070	-45.92	V	10.3	0.99	-36.61	-13	-23.61
5070	-46.83	H	10.3	0.99	-37.52	-13	-24.52
203.2	-56.34	V	3.71	0.21	-52.84	-13	-39.84
147.4	-51.28	H	0.96	0.19	-50.51	-13	-37.51

### High channel

Frequency (MHz)	Substituted level (dBm)	Polarity (H/V)	Antenna Gain Correction (dB)	Cable Loss (dB)	Corrected Reading (dBm)	Limit (dBm)	Margin (dB)
5120	-45.22	V	10.32	1	-35.9	-13	-22.9
5120	-46.37	H	10.32	1	-37.05	-13	-24.05
482.6	-56.52	V	6.16	0.37	-50.73	-13	-37.73
318.1	-55.28	H	5.63	0.22	-49.87	-13	-36.87

#### Note:

1, The testing has been conformed to  $10 \times 2567.5 \text{ MHz} = 25,675 \text{ MHz}$

2, All other emissions more than 30 dB below the limit

3, X-Axis, Y-Axis and Z-Axis were investigated. The results above show only the worst case.

4, The radiated spurious test above 18GHz is subcontracted to SIEMIC (Nanjing-China) Laboratories. and found 30dB below the limit at least.

## LTE Band XII (Part27) result

### Low channel

Frequency (MHz)	Substituted level (dBm)	Polarity (H/V)	Antenna Gain Correction (dB)	Cable Loss (dB)	Corrected Reading (dBm)	Limit (dBm)	Margin (dB)
1408	-44.26	V	7.65	0.75	-37.36	-13	-24.36
1408	-46.13	H	7.65	0.75	-39.23	-13	-26.23
799.6	-53.27	V	6.09	0.43	-47.61	-13	-34.61
364.4	-54.81	H	5.81	0.27	-49.27	-13	-36.27

### Middle channel

Frequency (MHz)	Substituted level (dBm)	Polarity (H/V)	Antenna Gain Correction (dB)	Cable Loss (dB)	Corrected Reading (dBm)	Limit (dBm)	Margin (dB)
1415	-46.55	V	7.65	0.75	-39.65	-13	-26.65
1415	-47.12	H	7.65	0.75	-40.22	-13	-27.22
80	-55.92	V	0.32	0.07	-55.67	-13	-42.67
91.4	-53.41	H	1.3	0.09	-52.2	-13	-39.20

### High channel

Frequency (MHz)	Substituted level (dBm)	Polarity (H/V)	Antenna Gain Correction (dB)	Cable Loss (dB)	Corrected Reading (dBm)	Limit (dBm)	Margin (dB)
1422	-45.18	V	7.65	0.75	-38.28	-13	-25.28
1422	-47.32	H	7.65	0.75	-40.42	-13	-27.42
102.8	-55.1	V	-0.07	0.15	-55.32	-13	-42.32
700	-53.28	H	6.39	0.41	-47.3	-13	-34.30

#### Note:

- 1, The testing has been conformed to  $10 \times 715.3 \text{ MHz} = 7,153 \text{ MHz}$
- 2, All other emissions more than 30 dB below the limit
- 3, X-Axis, Y-Axis and Z-Axis were investigated. The results above show only the worst case.



## LTE Band XVII (Part27) result

### Low channel

Frequency (MHz)	Substituted level (dBm)	Polarity (H/V)	Antenna Gain Correction (dB)	Cable Loss (dB)	Corrected Reading (dBm)	Limit (dBm)	Margin (dB)
1418	-44.65	V	7.65	0.75	-37.75	-13	-24.75
1418	-46.81	H	7.65	0.75	-39.91	-13	-26.91
658.4	-52.75	V	6.04	0.41	-47.12	-13	-34.12
413.1	-56.33	H	6.01	0.29	-50.61	-13	-37.61

### Middle channel

Frequency (MHz)	Substituted level (dBm)	Polarity (H/V)	Antenna Gain Correction (dB)	Cable Loss (dB)	Corrected Reading (dBm)	Limit (dBm)	Margin (dB)
1420	-46.29	V	7.65	0.75	-39.39	-13	-26.39
1420	-48.51	H	7.65	0.75	-41.61	-13	-28.61
213.8	-53.74	V	3.75	0.14	-50.13	-13	-37.13
138.2	-52.95	H	0.91	0.23	-52.27	-13	-39.27

### High channel

Frequency (MHz)	Substituted level (dBm)	Polarity (H/V)	Antenna Gain Correction (dB)	Cable Loss (dB)	Corrected Reading (dBm)	Limit (dBm)	Margin (dB)
1422	-44.32	V	7.65	0.75	-37.42	-13	-24.42
1422	-48.15	H	7.65	0.75	-41.25	-13	-28.25
307.3	-55.72	V	5.56	0.27	-50.43	-13	-37.43
542.4	-53.26	H	6.44	0.35	-47.17	-13	-34.17

**Note:**

- 1, The testing has been conformed to  $10 \times 713.5\text{MHz} = 7,135\text{MHz}$
- 2, All other emissions more than 30 dB below the limit
- 3, X-Axis, Y-Axis and Z-Axis were investigated. The results above show only the worst case.

## 6.7 Band Edge

Temperature	25°C
Relative Humidity	55%
Atmospheric Pressure	1012mbar
Test date :	October 10, 2017
Tested By :	Loren Luo

### Requirement(s):

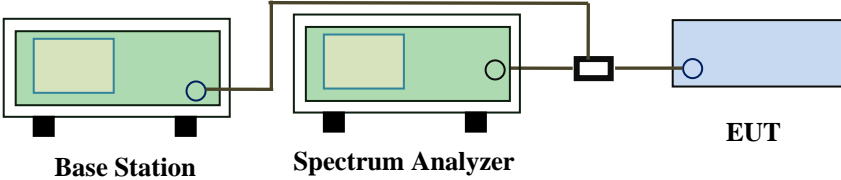
Spec	Item	Requirement	Applicable
§22.917(a) §24.238(a) § 27.53(h)	a)	The power of any emission outside of the authorized operating frequency ranges must be lower than the transmitter power (P) by a factor of at least $43 + 10 \log (P)$ dB.	<input checked="" type="checkbox"/>
Test setup	 <p>The diagram shows a Base Station (green box) connected to a Spectrum Analyzer (green box) and an EUT (blue box) via a power divider (black box). The Base Station and Spectrum Analyzer are connected to the power divider, which then splits the signal to the EUT.</p>		
Procedure	<ul style="list-style-type: none"> <li>- The EUT was connected to Spectrum Analyzer and Base Station via power divider.</li> <li>- The Band Edges of low and high channels for the highest RF powers were measured. Setting RBW as roughly BW/100.</li> </ul>		
Remark			
Result	<input checked="" type="checkbox"/> Pass <input type="checkbox"/> Fail		

Test Data  Yes       N/A

Test Plot  Yes (See below)       N/A

**LTE Band II (Part 24E) result**

BW(MHz)	Channel	Frequency (MHz)	Mode	Emission (dBm)	Limit (dBm)
1.4	18607	1850	QPSK	-19.583	-13
			16QAM	-20.384	-13
1.4	18900	1910	QPSK	-19.478	-13
			16QAM	-19.478	-13
3	18615	1850	QPSK	-17.430	-13
			16QAM	-17.430	-13
3	19185	1910	QPSK	-17.066	-13
			16QAM	-17.066	-13
5	18625	1850	QPSK	-17.680	-13
			16QAM	-16.899	-13
5	19175	1910	QPSK	-22.987	-13
			16QAM	-22.334	-13
10	18650	1850	QPSK	-20.346	-13
			16QAM	-20.346	-13
10	19150	1910	QPSK	-24.743	-13
			16QAM	-25.224	-13
15	18675	1850	QPSK	-21.826	-13
			16QAM	-21.838	-13
15	19125	1910	QPSK	-25.151	-13
			16QAM	-25.303	-13
20	18700	1850	QPSK	-22.865	-13
			16QAM	-22.865	-13
20	19100	1910	QPSK	-26.227	-13
			16QAM	-26.227	-13

### LTE Band IV (Part 27) result

BW(MHz)	Channel	Frequency (MHz)	Mode	Emission (dBm)	Limit (dBm)
1.4	19957	1709.9	QPSK	-24.236	-13
			16QAM	-24.163	-13
1.4	20393	1755	QPSK	-24.400	-13
			16QAM	-24.400	-13
3	19965	1709.9	QPSK	-21.080	-13
			16QAM	-21.535	-13
3	20385	1755	QPSK	-20.425	-13
			16QAM	-20.425	-13
5	19975	1709.9	QPSK	-20.026	-13
			16QAM	-20.328	-13
5	20375	1755	QPSK	-17.521	-13
			16QAM	-19.311	-13
10	20000	1709.9	QPSK	-20.026	-13
			16QAM	-21.250	-13
10	20350	1755	QPSK	-18.366	-13
			16QAM	-20.999	-13
15	20025	1709.9	QPSK	-21.803	-13
			16QAM	-21.602	-13
15	20325	1755	QPSK	-22.292	-13
			16QAM	-22.725	-13
20	20050	1709.9	QPSK	-26.385	-13
			16QAM	-26.036	-13
20	20300	1755	QPSK	-23.370	-13
			16QAM	-23.730	-13

### LTE Band XII (Part 27) result

BW(MHz)	Channel	Frequency (MHz)	Mode	Emission (dBm)	Limit (dBm)
1.4	23017	699	QPSK	-25.125	-13
			16QAM	-25.045	-13
1.4	23173	716	QPSK	-21.503	-13
			16QAM	-21.503	-13
3	23025	699	QPSK	-21.645	-13
			16QAM	-21.263	-13
3	23165	716	QPSK	-18.347	-13
			16QAM	-22.102	-13
5	23035	699	QPSK	-19.037	-13
			16QAM	-18.198	-13
5	23155	716	QPSK	-18.060	-13
			16QAM	-17.299	-13
10	23060	698	QPSK	-18.641	-13
			16QAM	-18.641	-13
10	23130	716	QPSK	-15.961	-13
			16QAM	-15.961	-13

### LTE Band XVII (Part 27) result

BW(MHz)	Channel	Frequency (MHz)	Mode	Emission (dBm)	Limit (dBm)
5	23755	704	QPSK	-18.197	-13
			16QAM	-17.772	-13
5	23825	716	QPSK	-21.293	-13
			16QAM	-19.388	-13
10	23780	704	QPSK	-17.974	-13
			16QAM	-18.572	-13
10	23800	716	QPSK	-21.609	-13
			16QAM	-17.150	-13

### Test Plots

#### LTE Band II (Part 24E)

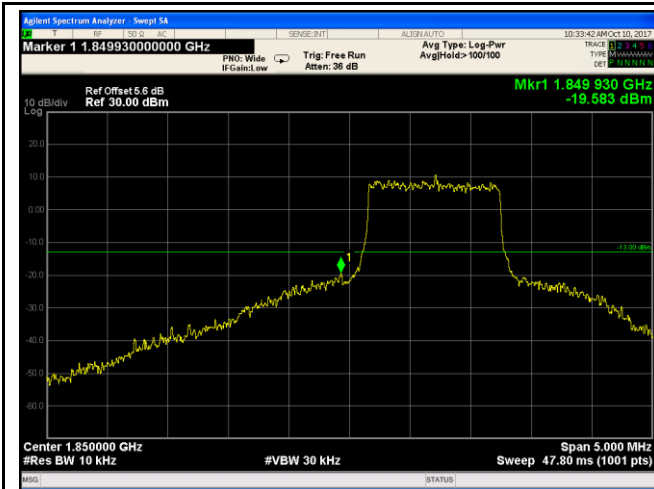

LTE Band II - Low Channel QPSK-1.4

Note: Offset=Cable loss (4.5) + 10log  
(12.76)=4.5+1.1=5.6dB

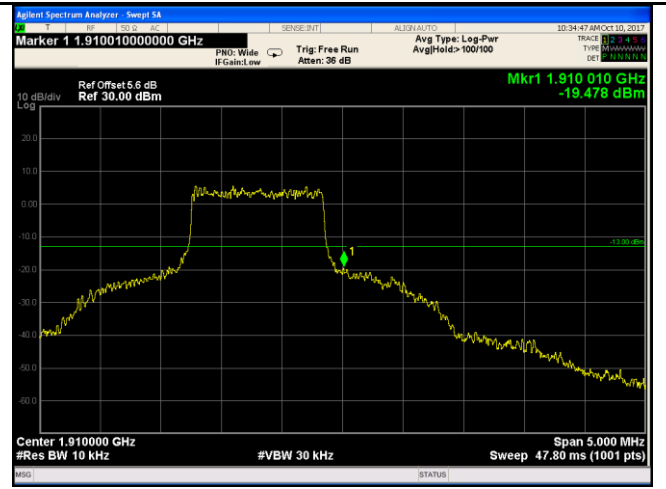

LTE Band II - High Channel QPSK-1.4

Note: Offset=Cable loss (4.5) + 10log  
(13.91)=4.5+1.2=5.6dB

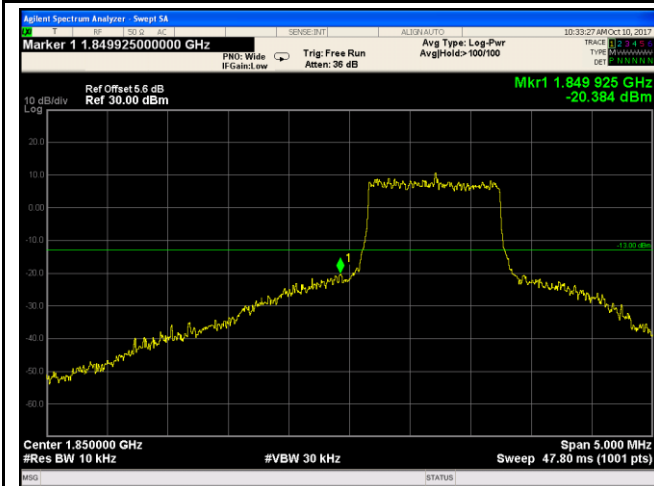

LTE Band II - Low Channel 16QAM-1.4

Note: Offset=Cable loss (4.5) + 10log  
(12.76/10)=4.5+1.1=5.6 dB

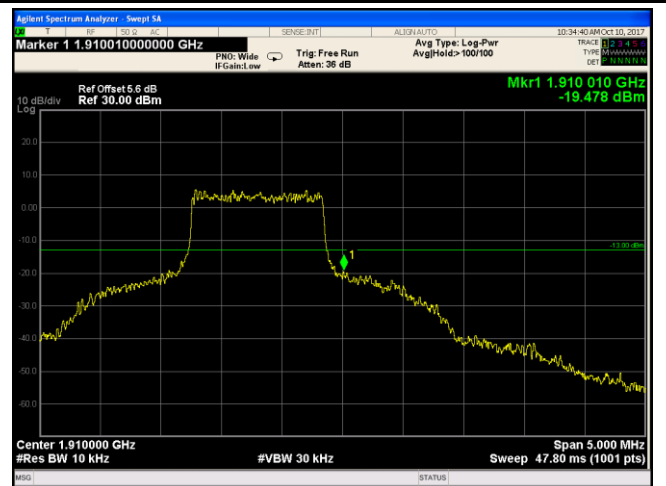

LTE Band II - High Channel 16QAM-1.4

Note: Offset=Cable loss (4.5) + 10log  
(13.08/10)=4.5+1.1=5.6 dB

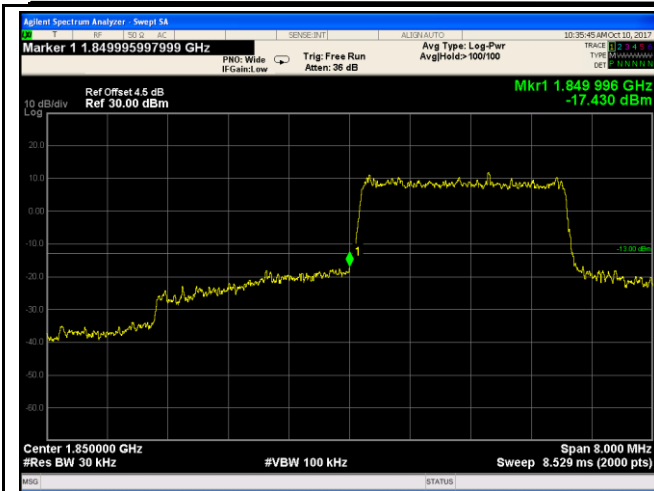

LTE Band II - Low Channel QPSK-3

Note: Offset=Cable loss (4.5) + 10log  
(30.27/30)=4.5+0.0=4.5 dB

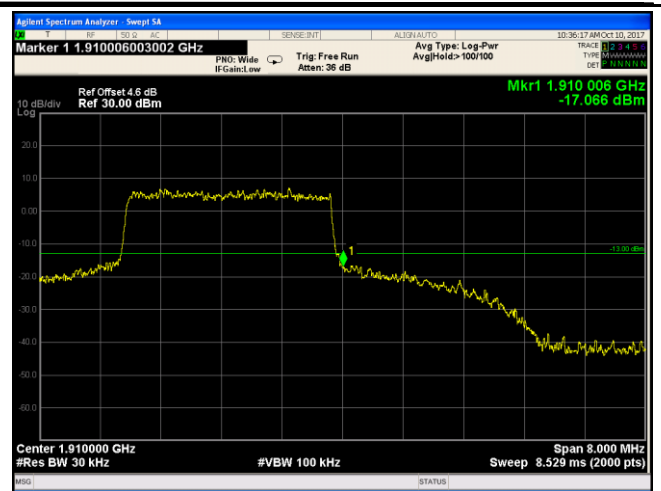

LTE Band II - High Channel QPSK-3

Note: Offset=Cable loss (4.5) + 10log  
(30.52/30)=4.5+0.0=4.5 dB

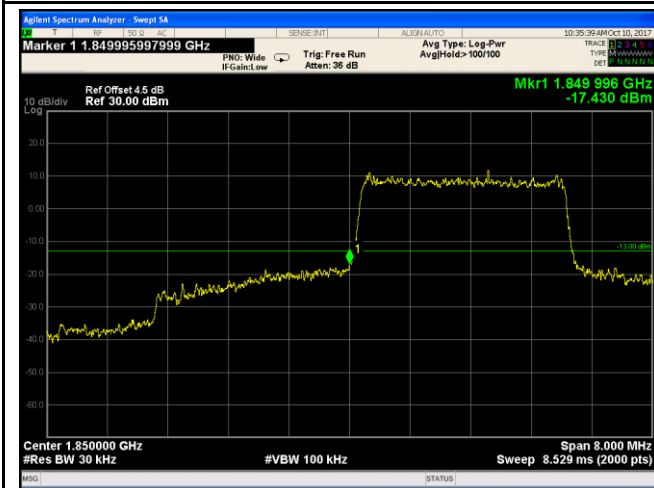

LTE Band II - Low Channel 16QAM-3

Note: Offset=Cable loss (4.5) + 10log  
(30.23/30)=4.5+0.0=4.5 dB

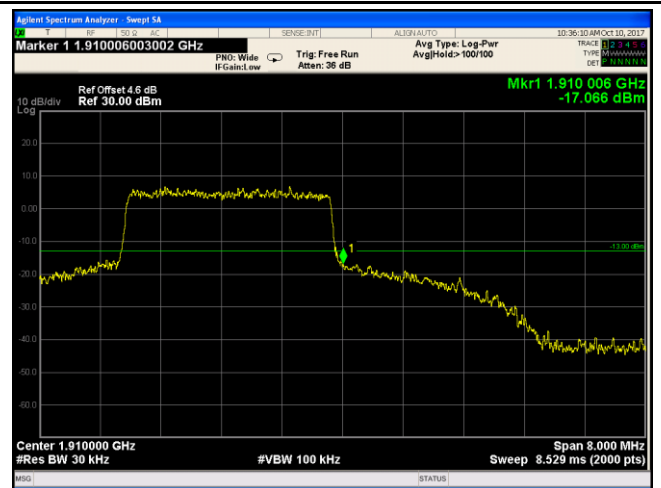

LTE Band II - High Channel 16QAM-3

Note: Offset=Cable loss (4.5) + 10log  
(30.87/30)=4.5+0.1=4.6 dB

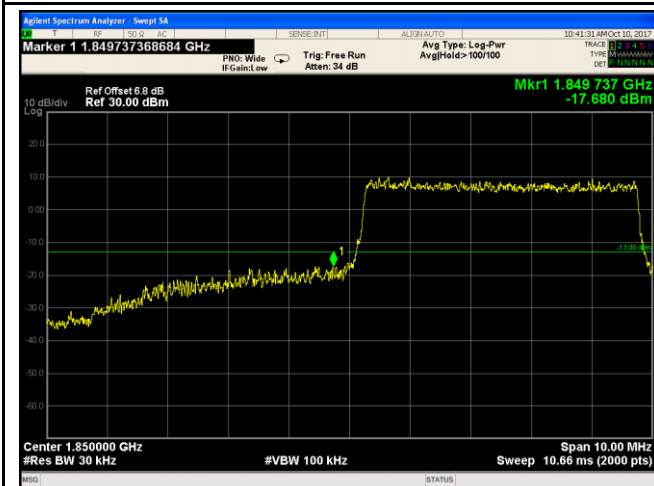

LTE Band II - Low Channel QPSK-5

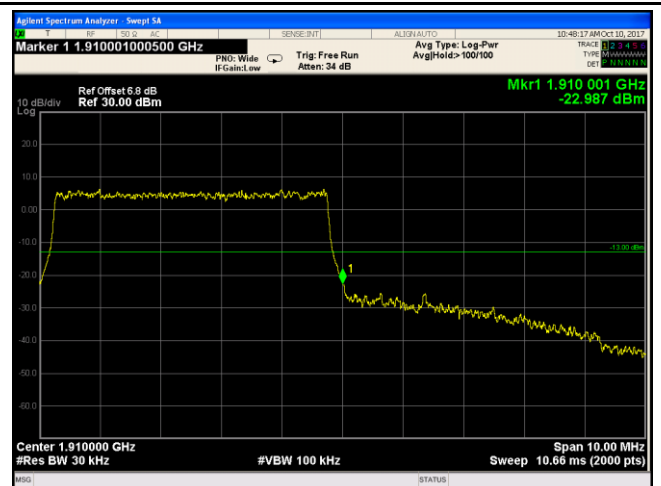

LTE Band II - High Channel QPSK-5

Note: Offset=Cable loss (4.5) + 10log  
(50.61/30)=4.5+2.3=6.8 dB

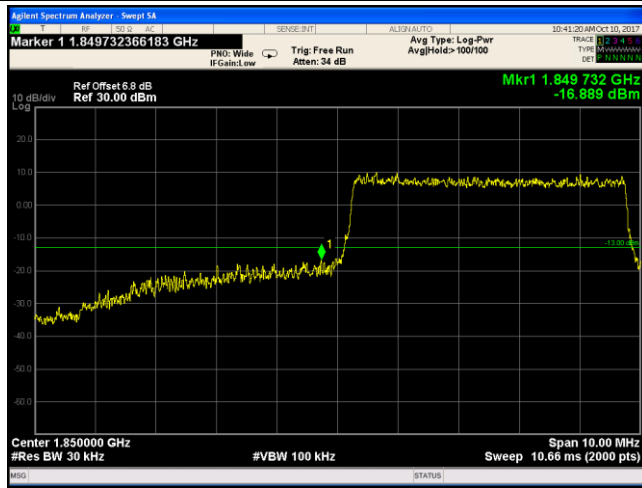

LTE Band II - Low Channel 16QAM-5

Note: Offset=Cable loss (4.5) + 10log  
(50.69/30)=4.5+2.3=6.8 dB

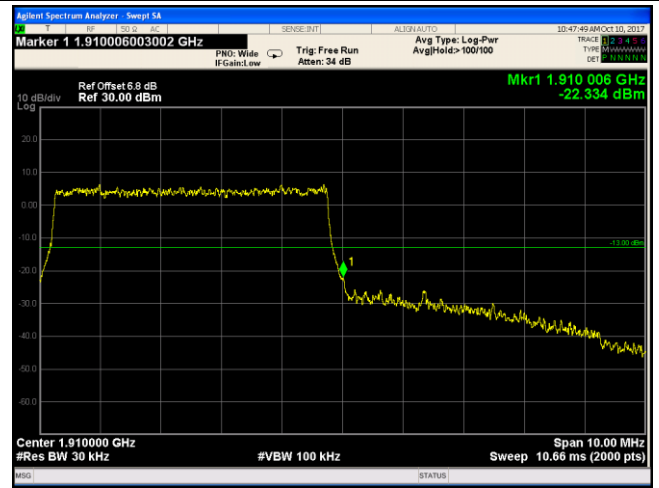

LTE Band II - High Channel 16QAM-5

Note: Offset=Cable loss (4.5) + 10log  
(50.38/30)=4.5+2.3=6.8 dB

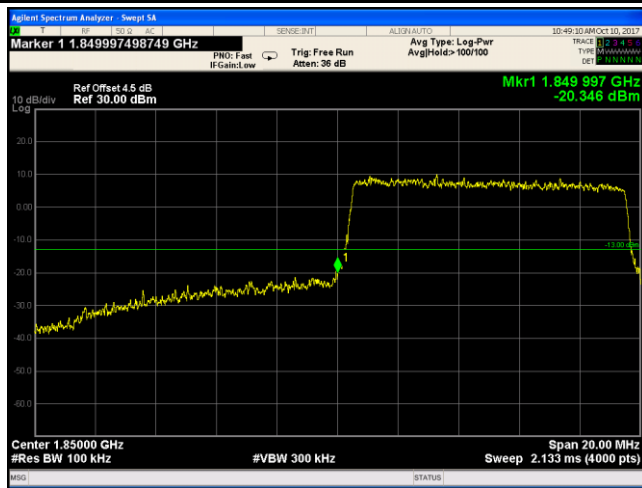

LTE Band II - Low Channel QPSK-10

Note: Offset=Cable loss (4.5) + 10log  
(50.42/30)=4.5+2.3=6.8 dB

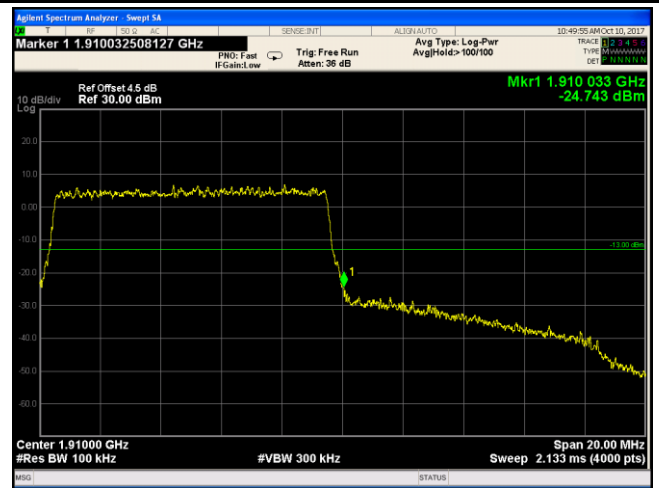

LTE Band II - High Channel QPSK-10

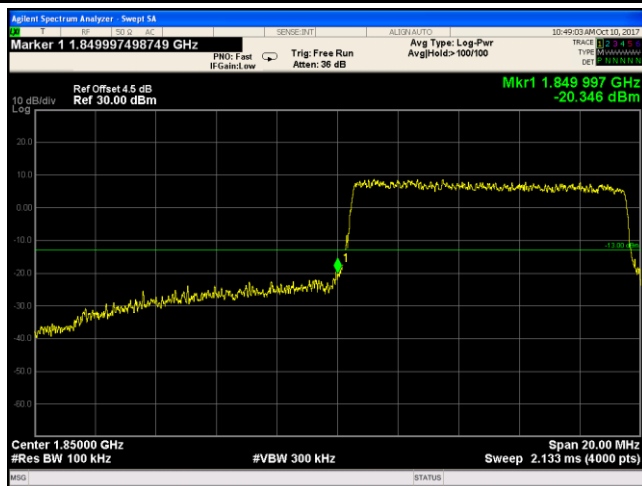

LTE Band II - Low Channel 16QAM-10

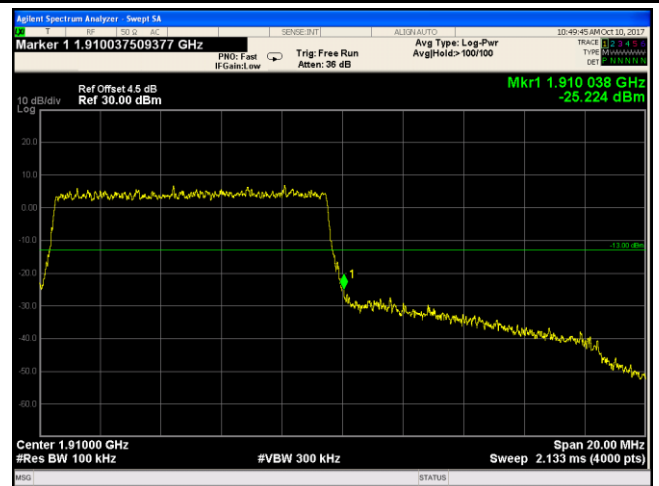

LTE Band II - High Channel 16QAM-10



Note: Offset=Cable loss (4.5) + 10log  
 (99.61/100)=4.5+0.0=4.5 dB



LTE Band II - Low Channel QPSK-15

Note: Offset=Cable loss (4.5) + 10log  
 (100.3/100)=4.5+0.0=4.5 dB

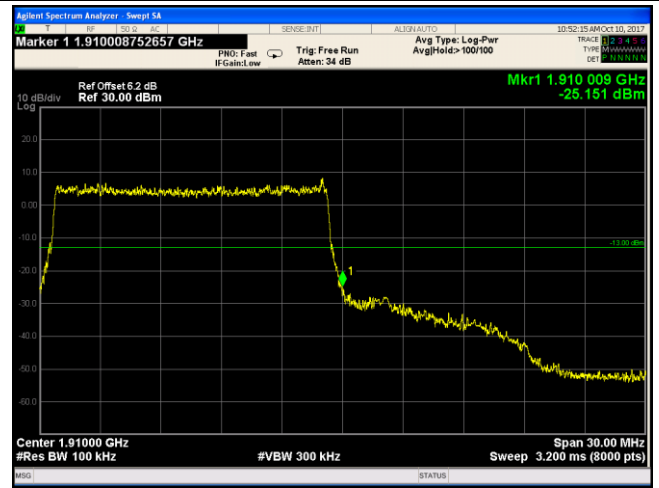

LTE Band II - High Channel QPSK-15

Note: Offset=Cable loss (4.5) + 10log  
 (147.6/100)=4.5+1.7=6.2 dB

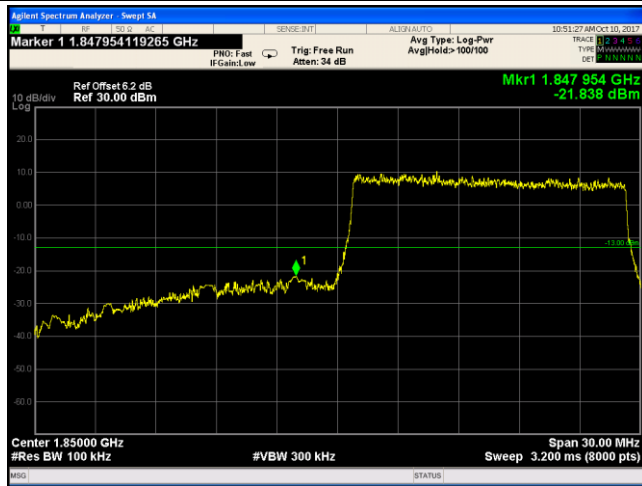

LTE Band II - Low Channel 16QAM-15

Note: Offset=Cable loss (4.5) + 10log  
 (148.8/100)=4.5+1.7=6.2 dB

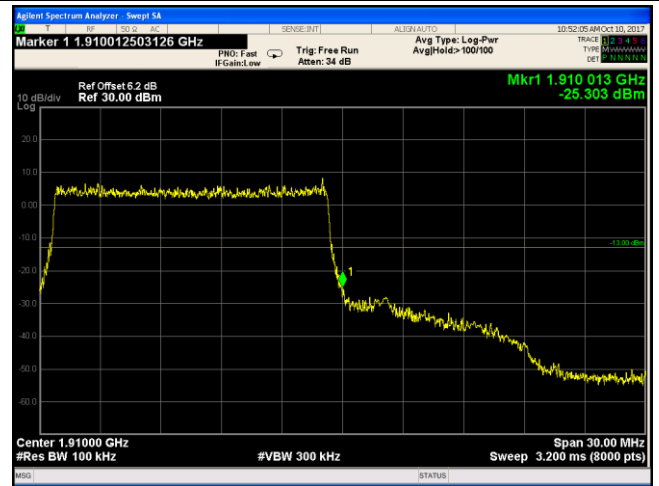

LTE Band II - High Channel 16QAM-15

Note: Offset=Cable loss (4.5) + 10log  
 (148/100)=4.5+1.7=6.2 dB

Note: Offset=Cable loss (4.5) + 10log  
 (149/100)=4.5+1.7=6.2 dB

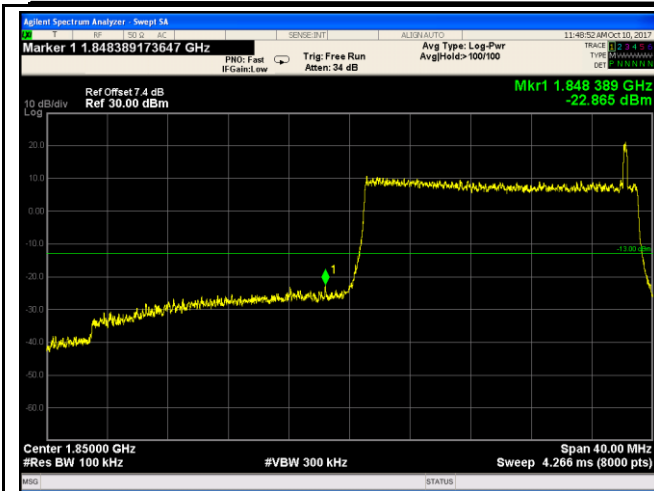

LTE Band II - Low Channel QPSK-20

Note: Offset=Cable loss (4.5) + 10log  
(194/100)=4.5+2.9=7.4 dB

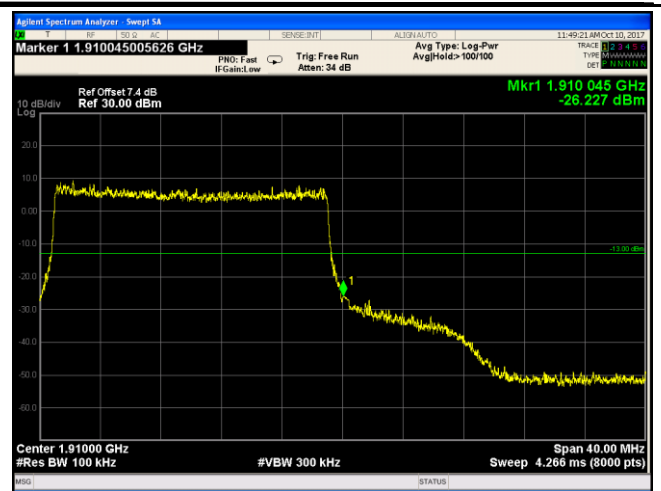

LTE Band II - High Channel QPSK-20

Note: Offset=Cable loss (4.5) + 10log  
(194/100)=4.5+2.9=7.4 dB

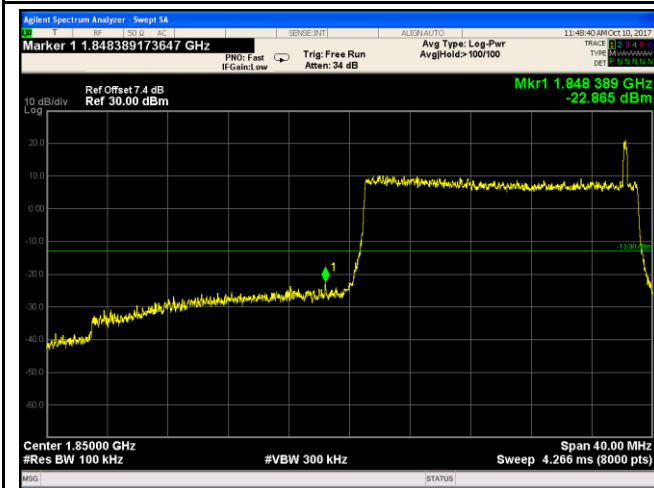

LTE Band II - Low Channel 16QAM-20

Note: Offset=Cable loss (4.5) + 10log  
(194/100)=4.5+2.9=7.4 dB

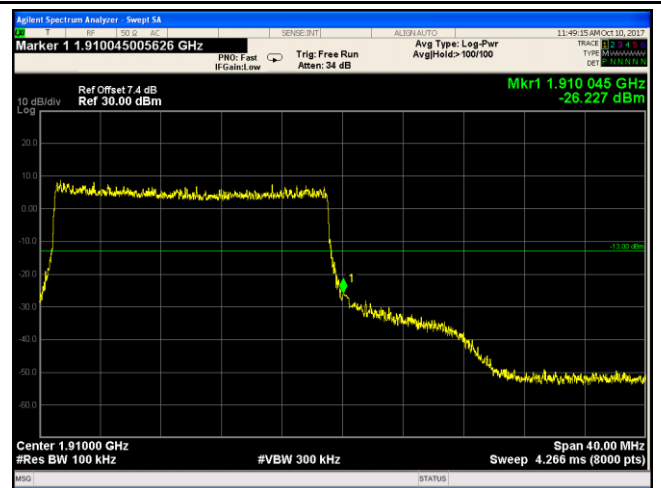

LTE Band II - High Channel 16QAM-20

Note: Offset=Cable loss (4.5) + 10log  
(195/100)=4.5+2.9=7.4 dB

### LTE Band IV (Part 27)

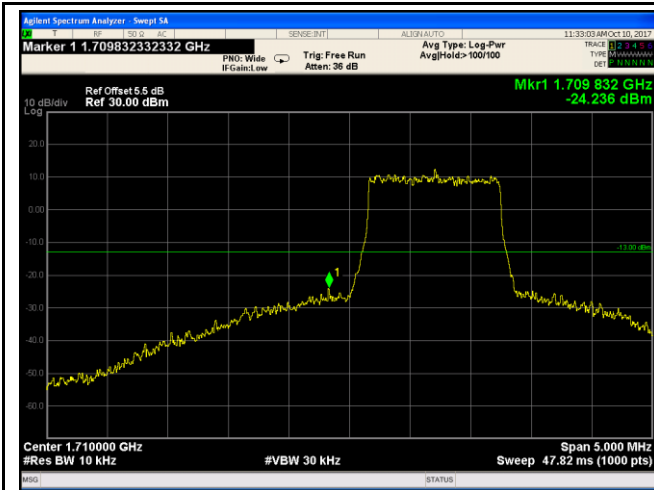

LTE Band IV - Low Channel QPSK-1.4

Note: Offset=Cable loss (4.5) + 10log  
(12.72/10)=4.5+1.0=5.6 dB

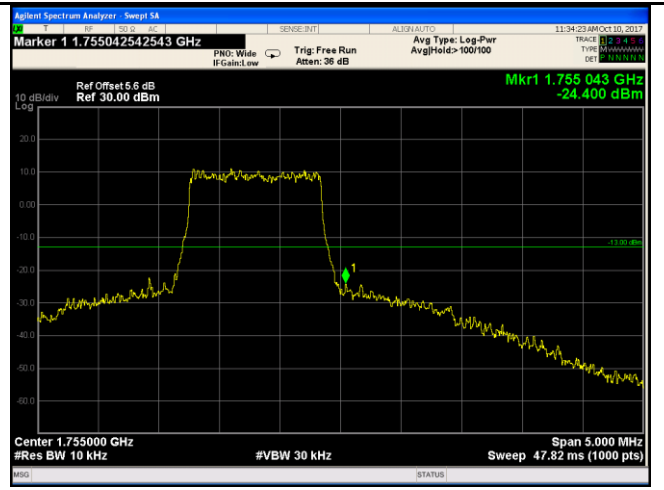

LTE Band IV - High Channel QPSK-1.4

Note: Offset=Cable loss (4.5) + 10log  
(12.92/10)=4.5+1.1=5.6 dB

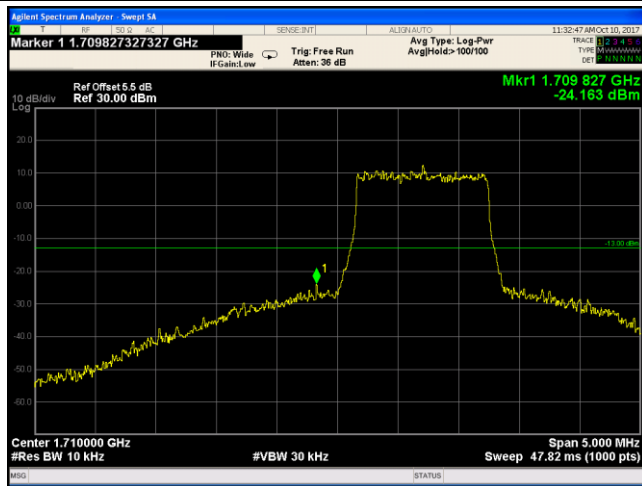

LTE Band IV - Low Channel 16QAM-1.4

Note: Offset=Cable loss (4.5) + 10log  
(12.63/10)=4.5+1.0=5.6 dB

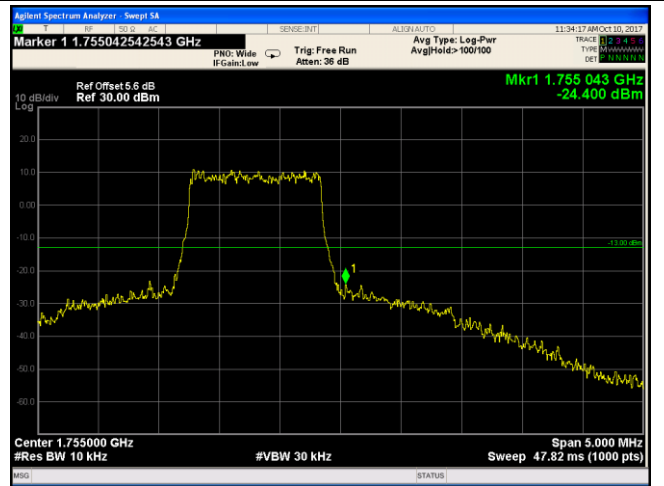

LTE Band IV - High Channel 16QAM-1.4

Note: Offset=Cable loss (4.5) + 10log  
((12.96/10)=4.5+1.1=5.6 dB

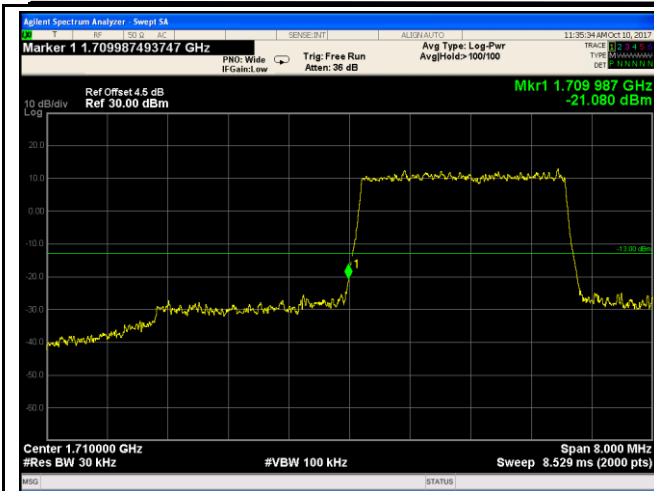

LTE Band IV - Low Channel QPSK-3

Note: Offset=Cable loss (4.5) + 10log  
(30.32/30)=4.5+0.0=4.5 dB

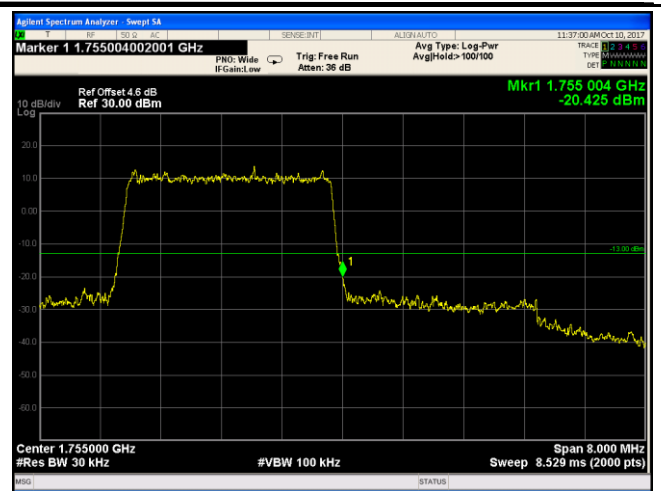

LTE Band IV - High Channel QPSK-3

Note: Offset=Cable loss (4.5) + 10log  
(30.70/30)=4.5+0.1=4.6 dB

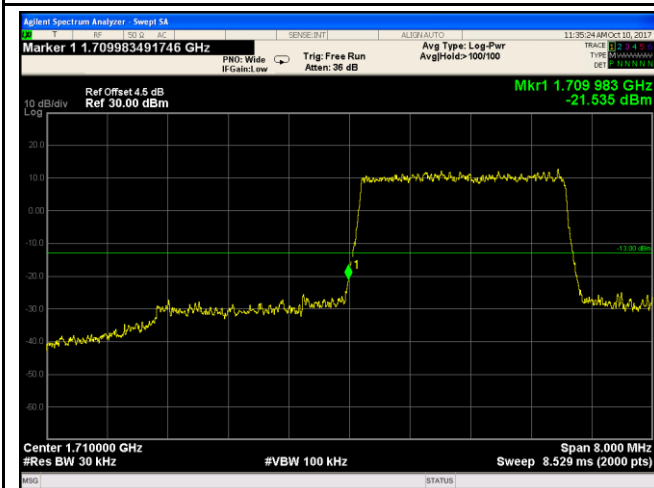

LTE Band IV - Low Channel 16QAM-3

Note: Offset=Cable loss (4.5) + 10log  
(30.25/30)=4.5+0.0=4.5 dB

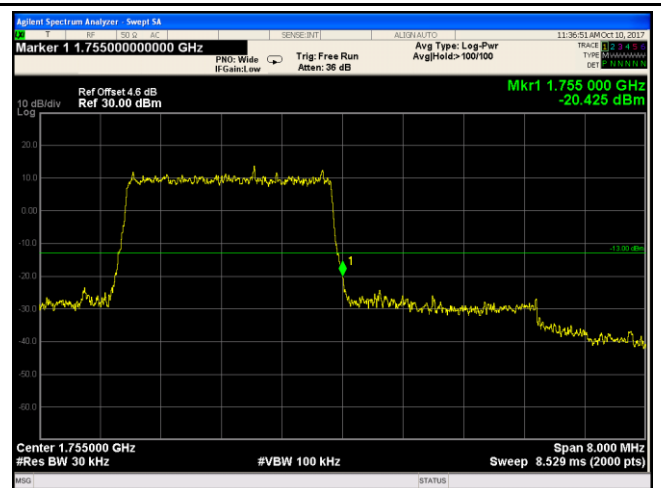

LTE Band IV - High Channel 16QAM-3

Note: Offset=Cable loss (4.5) + 10log  
(30.51/30)=4.5+0.1=4.6 dB

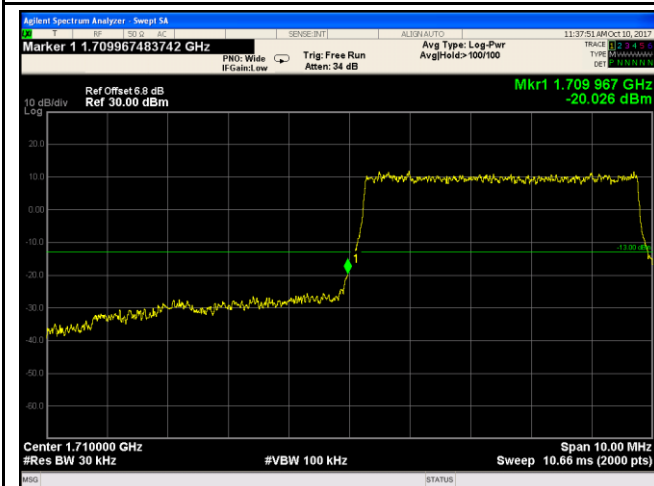

LTE Band IV - Low Channel QPSK-5

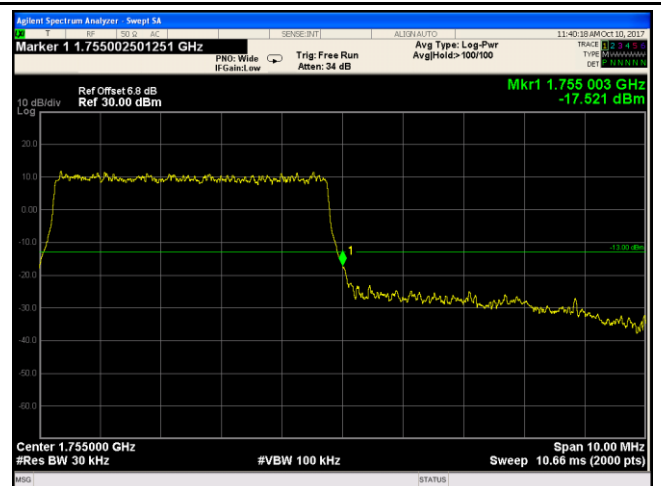

LTE Band IV - High Channel QPSK-5

Note: Offset=Cable loss (4.5) + 10log  
 $(50.77/30)=4.5+2.3=6.8$  dB

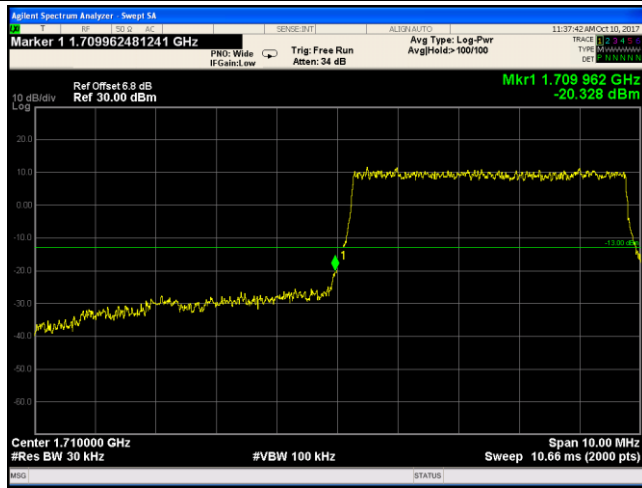

LTE Band IV - Low Channel 16QAM-5

Note: Offset=Cable loss (4.5) + 10log  
 $(50.45/30)=4.5+2.3=6.8$  dB

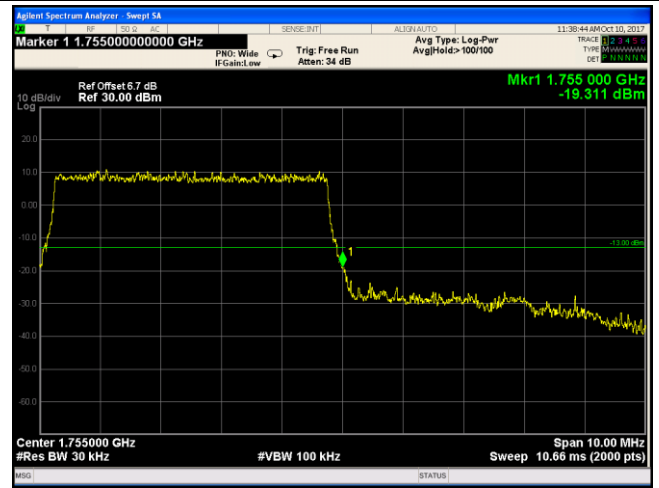

LTE Band IV - High Channel 16QAM-5

Note: Offset=Cable loss (4.5) + 10log  
 $(50.92/30)=4.5+2.3=6.8$  dB

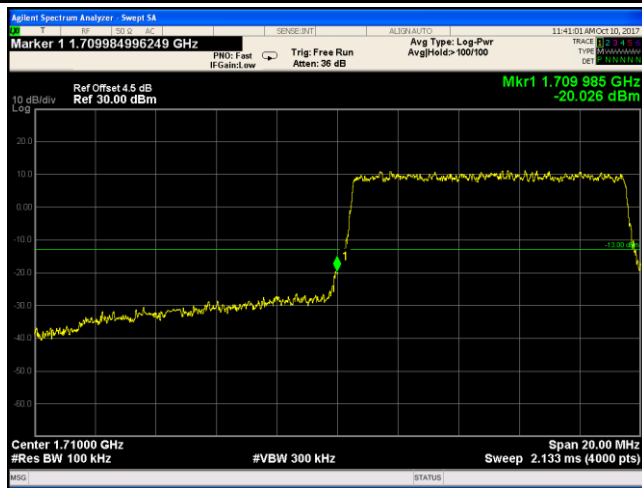

LTE Band IV - Low Channel QPSK-10

Note: Offset=Cable loss (4.5) + 10log  
 $(50.26/30)=4.5+2.2=6.7$  dB

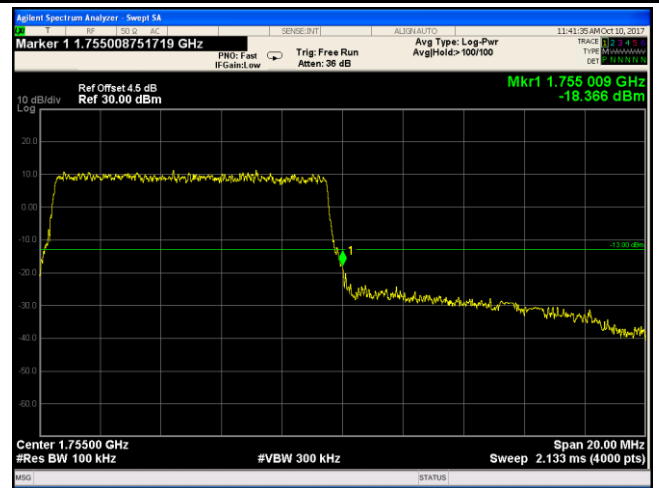

LTE Band IV - High Channel QPSK-10

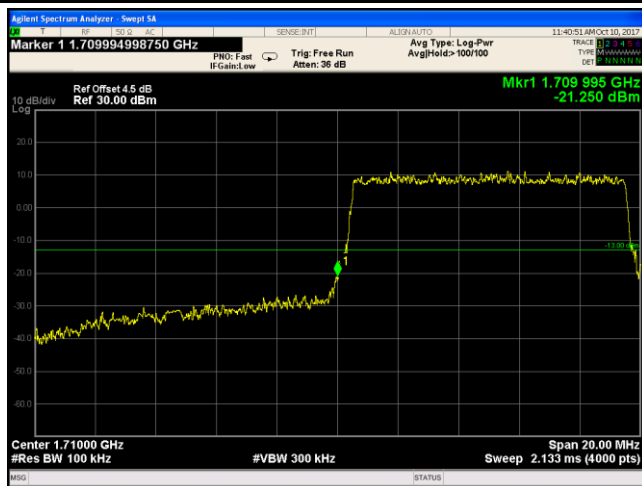

LTE Band IV - Low Channel 16QAM-10

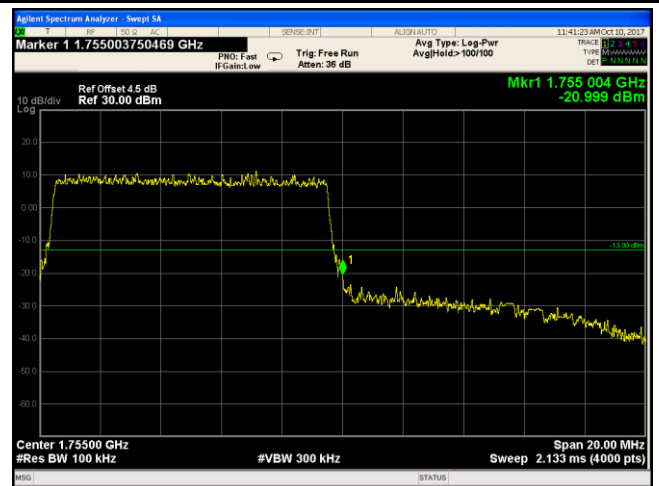

LTE Band IV - High Channel 16QAM-10

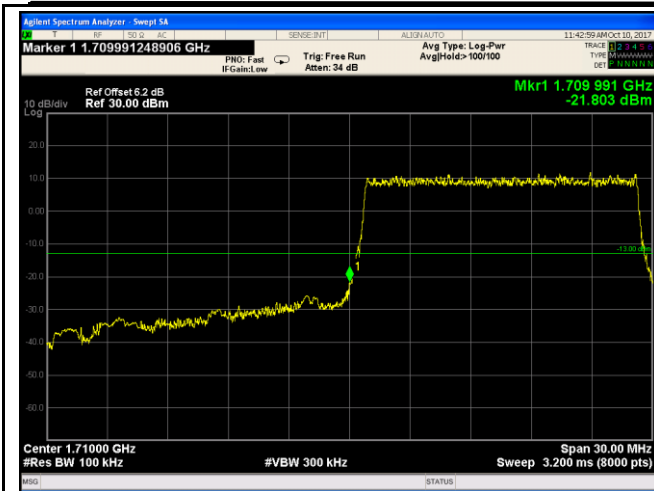

LTE Band IV - Low Channel QPSK-15

Note: Offset=Cable loss (4.5) + 10log  
(148/100)=4.5+1.7=6.2 dB

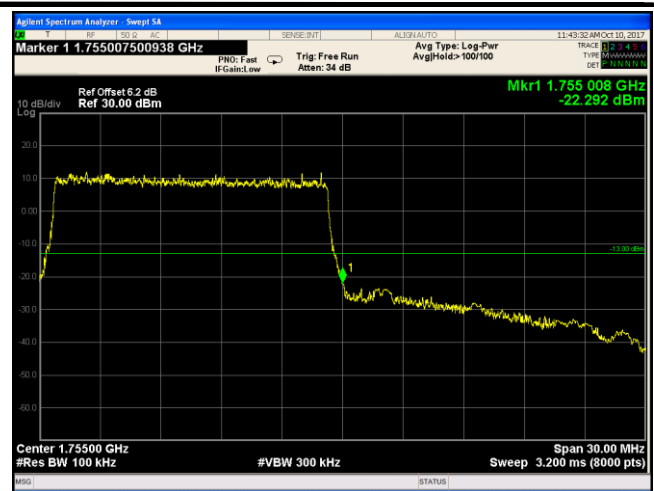

LTE Band IV - High Channel QPSK-15

Note: Offset=Cable loss (4.5) + 10log  
(147/100)=4.5+1.7=6.2 dB

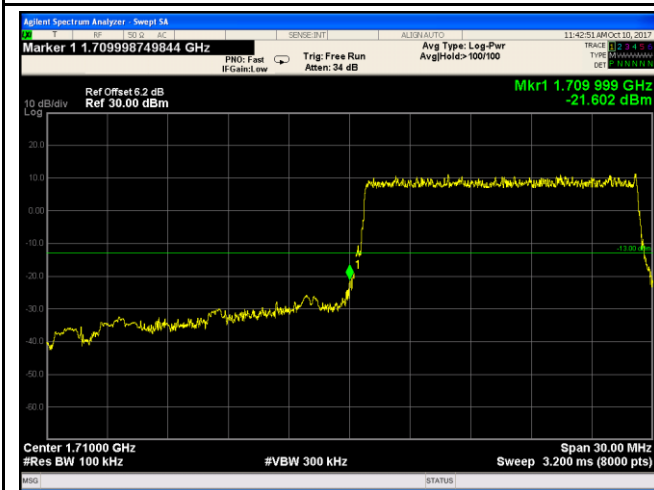

LTE Band IV - Low Channel 16QAM-15

Note: Offset=Cable loss (4.5) + 10log  
(148/100)=4.5+1.7=6.2 dB

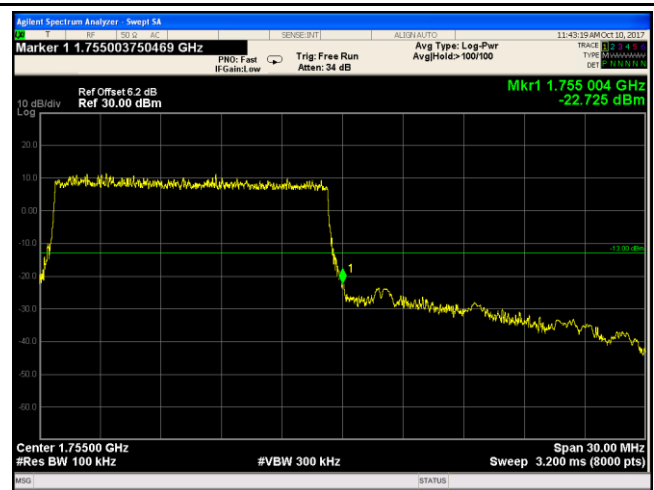

LTE Band IV - High Channel 16QAM-15

Note: Offset=Cable loss (4.5) + 10log  
(148/100)=4.5+1.7=6.2 dB

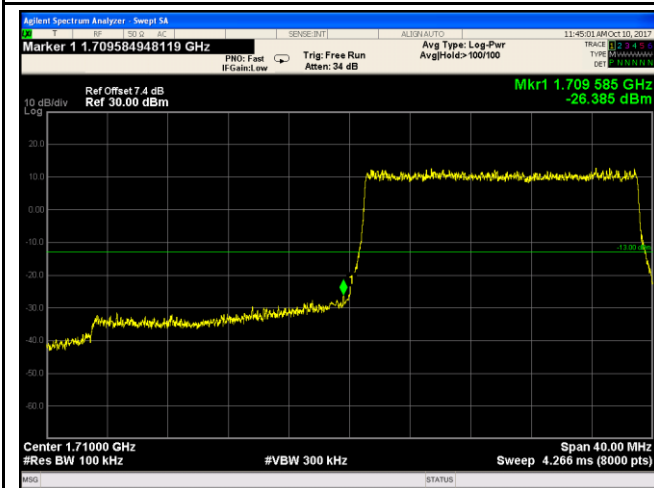

LTE Band IV - Low Channel QPSK-20

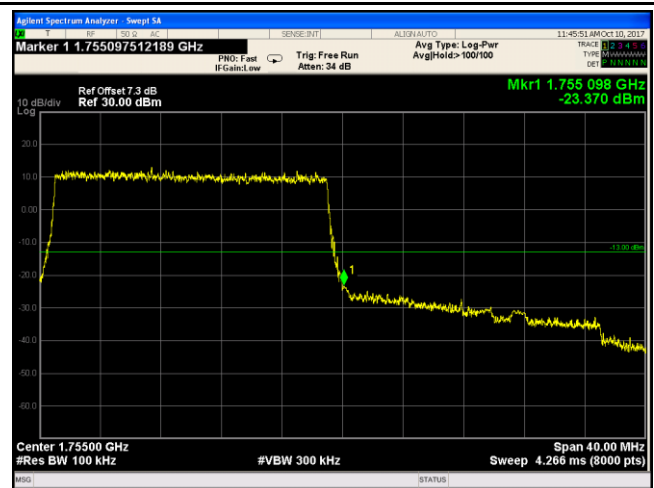

LTE Band IV - High Channel QPSK-20

Note: Offset=Cable loss (4.5) + 10log  
(194/100)=4.5+2.9=7.4 dB

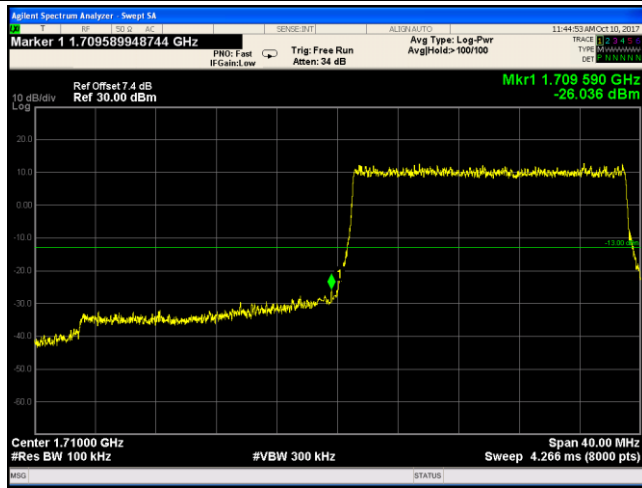

LTE Band IV - Low Channel 16QAM-20

Note: Offset=Cable loss (4.5) + 10log  
(194/100)=4.5+2.9=7.4dB

Note: Offset=Cable loss (4.5) + 10log  
(193/100)=4.5+2.8=7.3 dB

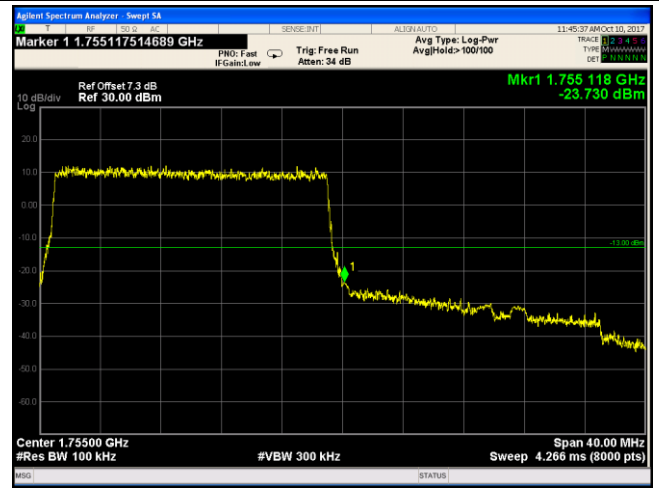

LTE Band IV - High Channel 16QAM-20

Note: Offset=Cable loss (4.5) + 10log  
(193/100)=4.5+2.8=7.3 dB

### LTE Band XII (Part 27)

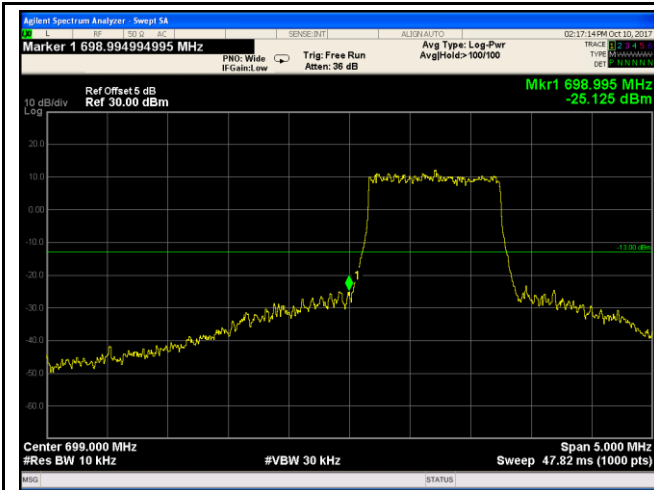

LTE Band XII - Low Channel QPSK-1.4

Note: Offset=Cable loss (4.5) + 10log  
(12.65/10)=4.0+1.0=5.0 dB

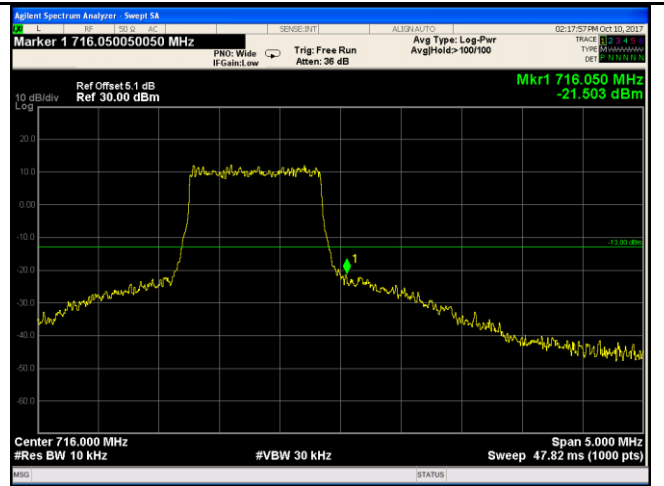

LTE Band XII - High Channel QPSK-1.4

Note: Offset=Cable loss (4.5) + 10log  
(13.01/10)=4.0+1.1=5.1 dB

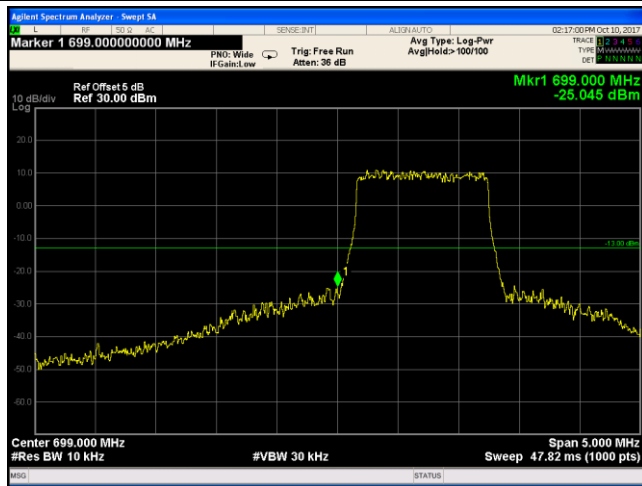

LTE Band XII - Low Channel 16QAM-1.4

Note: Offset=Cable loss (4.5) + 10log  
(12.61/10)=4.0+1.0=5.0 dB

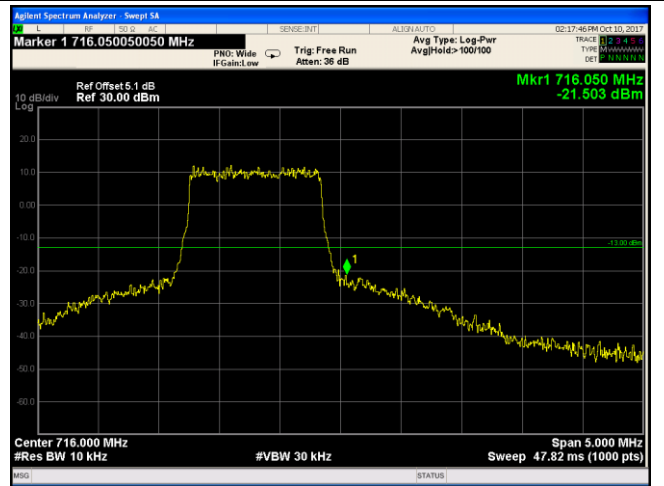

LTE Band XII - High Channel 16QAM-1.4

Note: Offset=Cable loss (4.5) + 10log  
(12.96/10)=4.0+1.1=5.1 dB



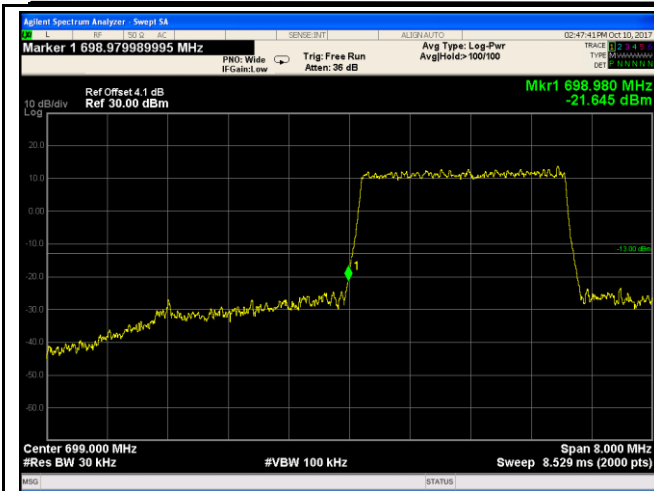

LTE Band XII - Low Channel QPSK-3

Note: Offset=Cable loss (4.5) + 10log  
(30.60/30)=4.0+0.1=4.1 dB

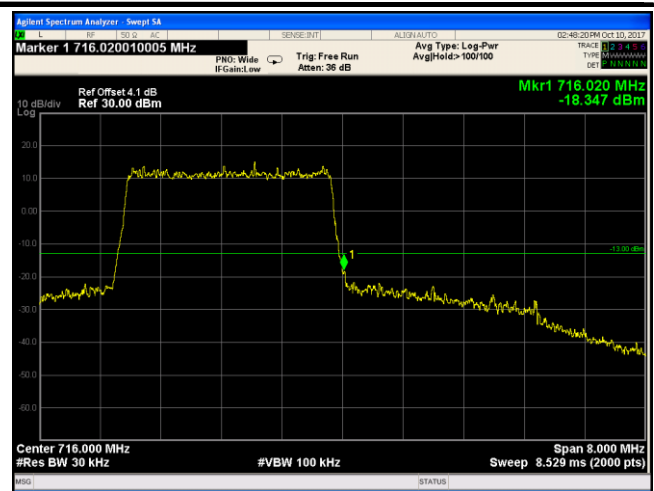

LTE Band XII - High Channel QPSK-3

Note: Offset=Cable loss (4.5) + 10log  
(30.66/30)=4.0+0.1=4.1 dB

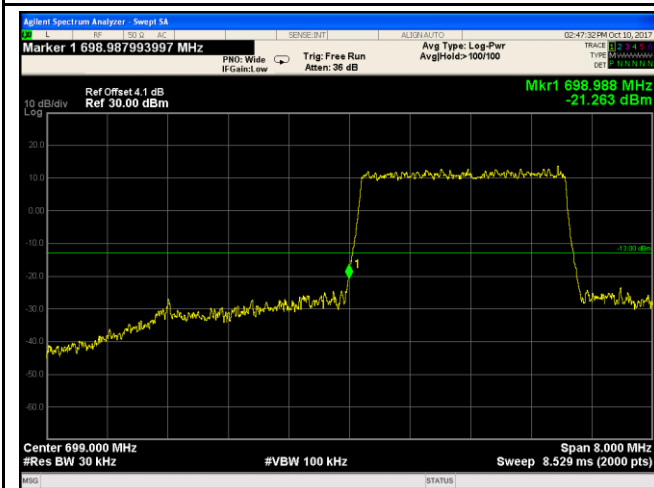

LTE Band XII - Low Channel 16QAM-3

Note: Offset=Cable loss (4.5) + 10log  
(30.59/30)=4.0+0.1=4.1 dB

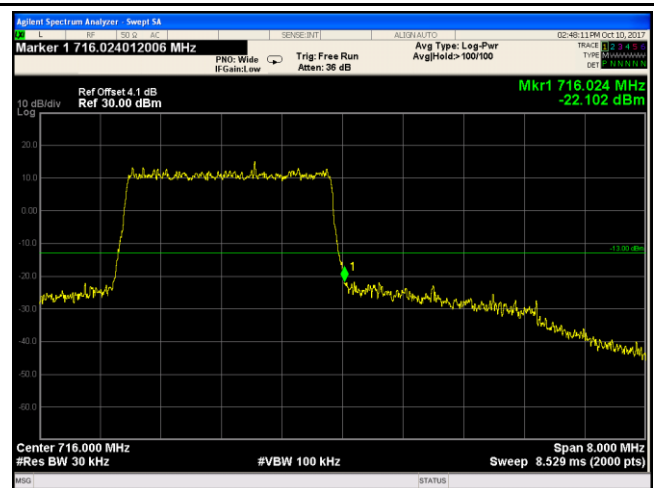

LTE Band XII - High Channel 16QAM-3

Note: Offset=Cable loss (4.5) + 10log  
(30.63/30)=4.0+0.1=4.1 dB

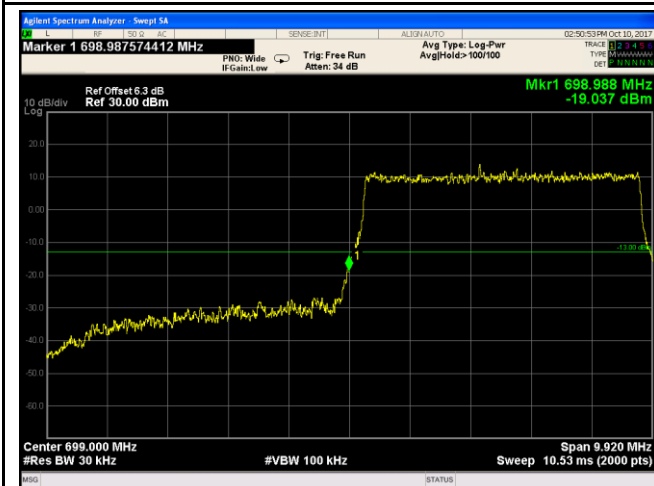

LTE Band XII - Low Channel QPSK-5

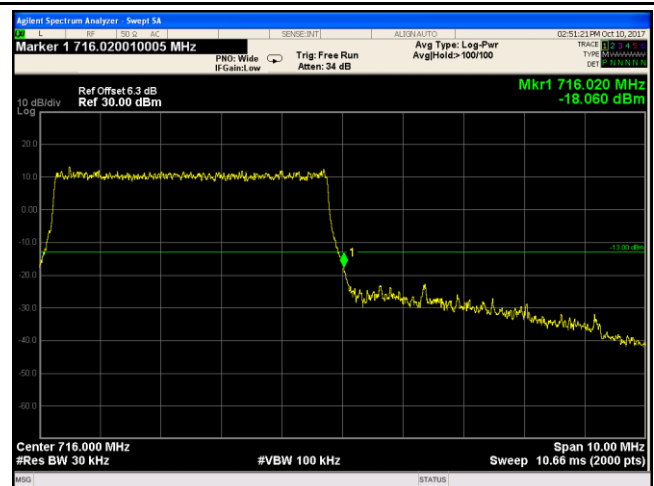

LTE Band XII - High Channel QPSK-5

Note: Offset=Cable loss (4.5) + 10log  
(50.77/30)=4.0+2.3=6.3 dB

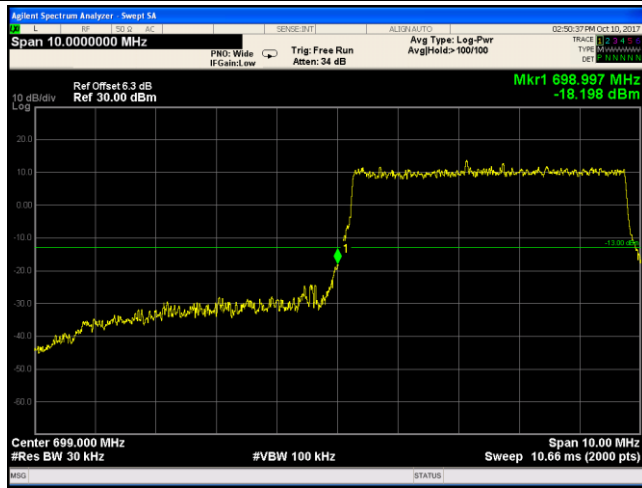

LTE Band XII - Low Channel 16QAM-5

Note: Offset=Cable loss (4.5) + 10log  
(50.87/30)=4.0+2.3=6.3 dB

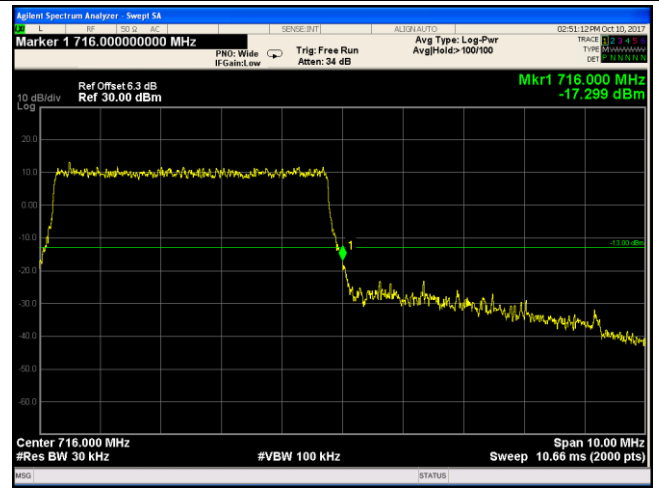

LTE Band XII - High Channel 16QAM-5

Note: Offset=Cable loss (4.5) + 10log  
(50.75/30)=4.0+2.3=6.3 dB

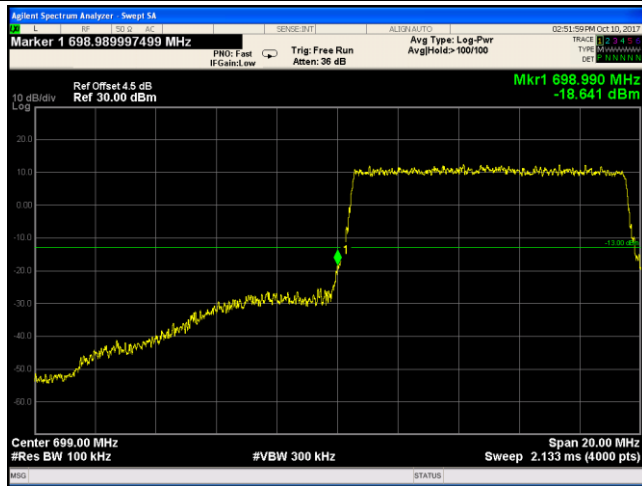

LTE Band XII - Low Channel QPSK-10

Note: Offset=Cable loss (4.5) + 10log  
(50.87/30)=4.0+2.3=6.3 dB

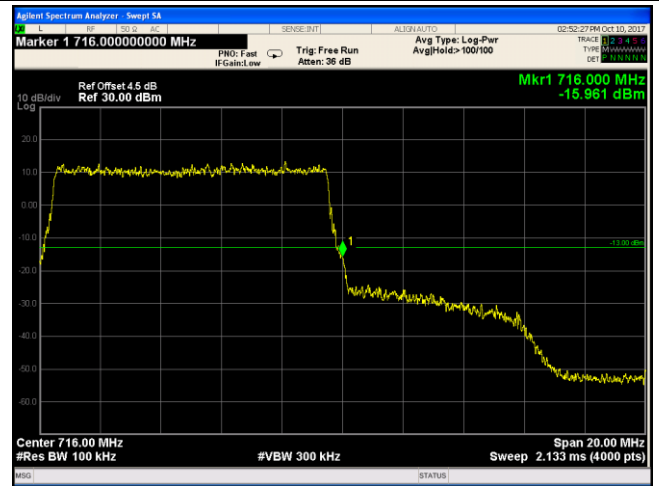

LTE Band XII - High Channel QPSK-10

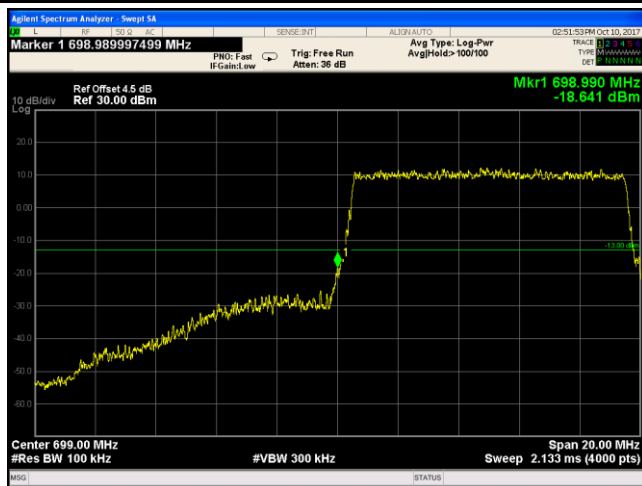

LTE Band XII - Low Channel 16QAM-10

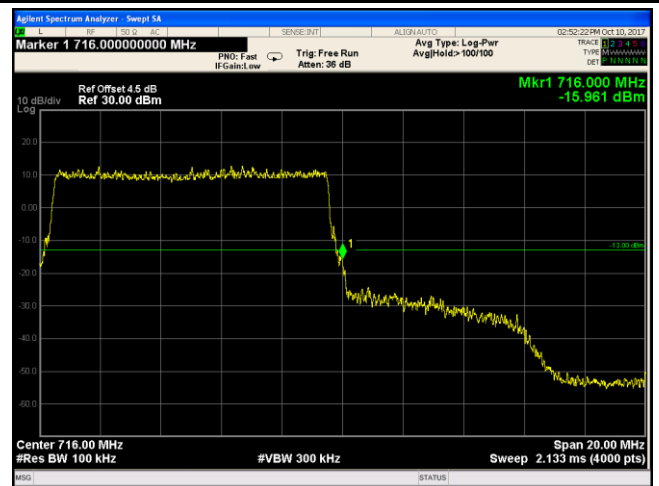

LTE Band XII - High Channel 16QAM-10

### LTE Band XVII (Part 27)

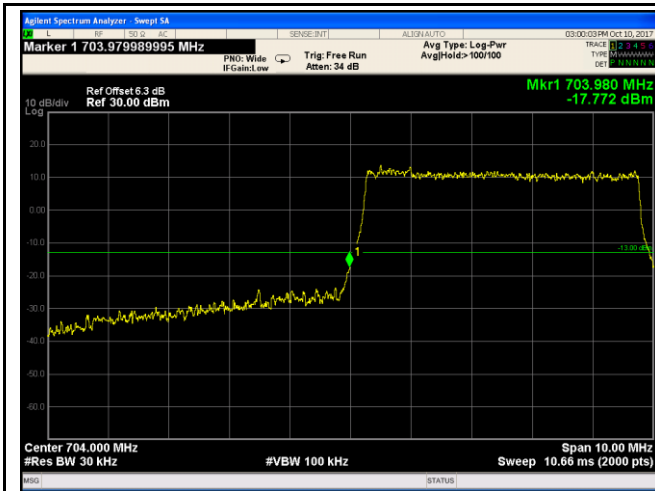

LTE Band XVII - Low Channel QPSK-5

Note: Offset=Cable loss (4.0) + 10log  
(50.73/30)=4.0+2.3=6.3 dB

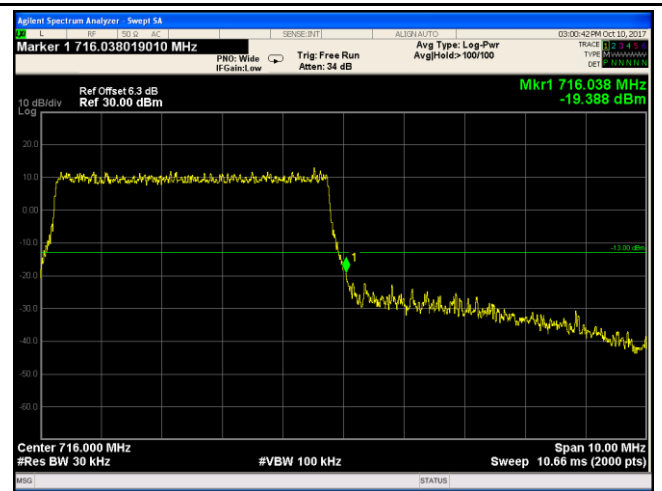

LTE Band XVII - High Channel QPSK-5

Note: Offset=Cable loss (4.0) + 10log  
(50.51/30)=4.0+2.3=6.3 dB

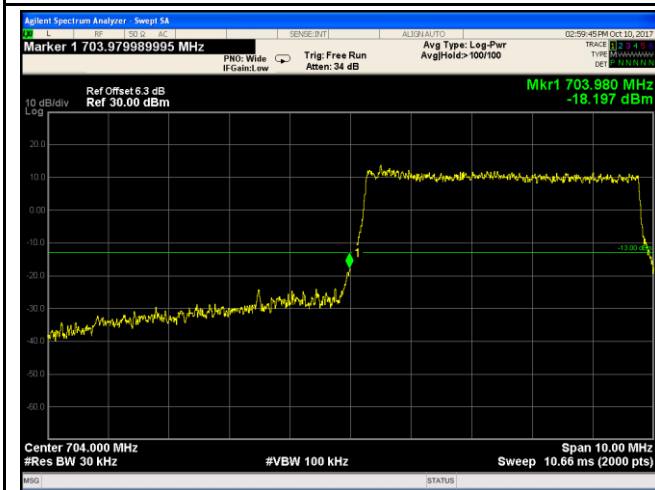

LTE Band XVII - Low Channel 16QAM-5

Note: Offset=Cable loss (4.0) + 10log  
(50.71/30)=4.0+2.3=6.3 dB

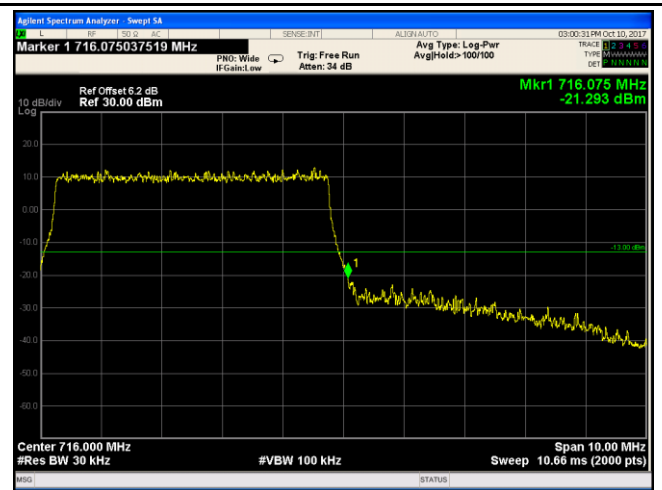

LTE Band XVII - High Channel 16QAM-5

Note: Offset=Cable loss (4.0) + 10log  
(50.27/30)=4.0+2.2=6.2 dB

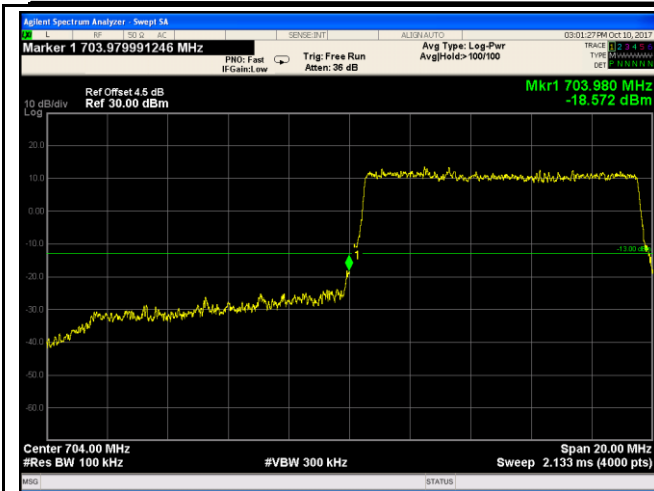

LTE Band XVII - Low Channel QPSK-10

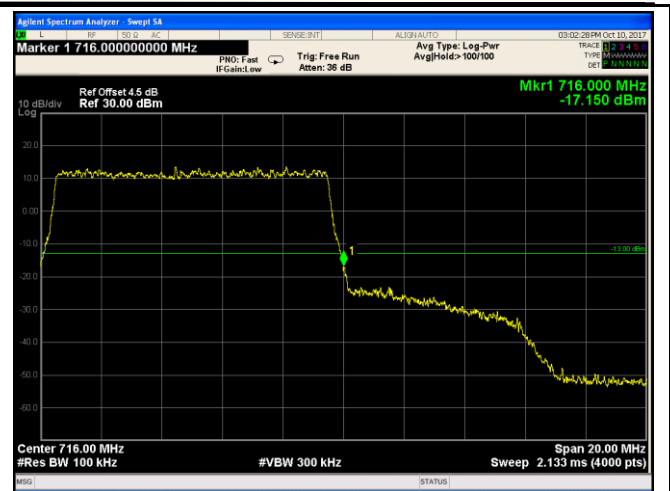

LTE Band XVII - High Channel QPSK-10

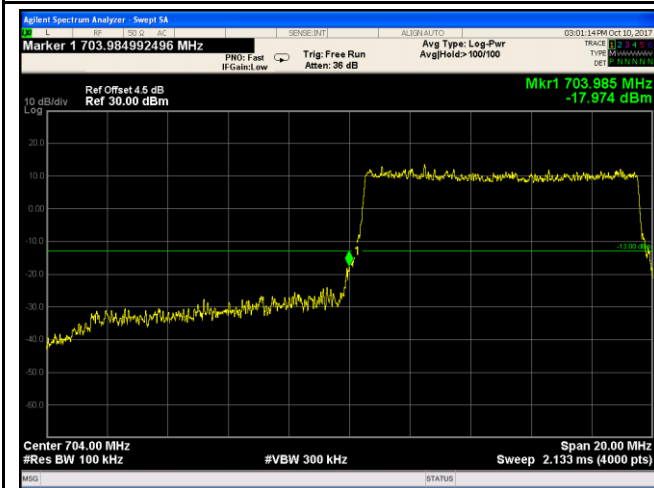

LTE Band XVII - Low Channel 16QAM-10

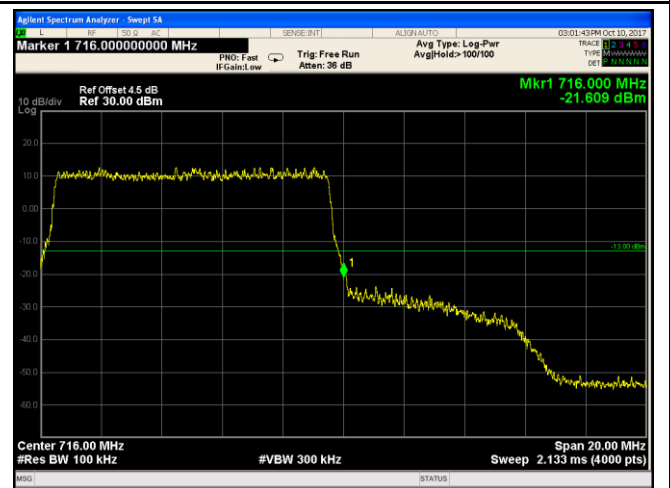

LTE Band XVII - High Channel 16QAM-10

## 6.8 Band Edge 27.53(m)

Temperature	25°C
Relative Humidity	55%
Atmospheric Pressure	1012mbar
Test date :	October 10, 2017
Tested By :	Loren Luo

### Requirement(s):

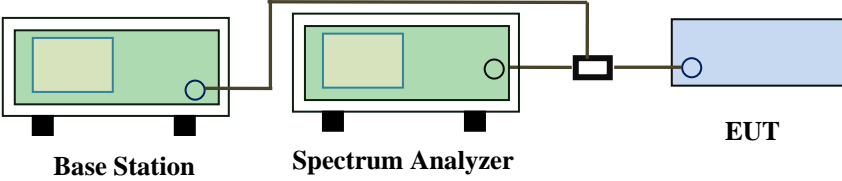
Spec	Requirement	Applicable
§27.53(m)	According to FCC 27.53(m)(4) specified that power of any emission outside of the channel edge must be attenuated below the transmitting power(P) by a factor shall be not less than $43+10\log(P)$ dB at the channel edge, the limit of emission equal to -13dBm. And $55+10\log(P)$ dB at 5.5MHz from the channel edges, the limit of emission equal to -25dBm. In the 1MHz bands immediately outside and adjacent to the frequency block a resolution bandwidth of at least one percent of the emission bandwidth of the fundamental emission of the transmitter may be employed.	<input checked="" type="checkbox"/>
Test Setup	 <p style="text-align: center;">Base Station      Spectrum Analyzer      EUT</p>	
Test Procedure	<ul style="list-style-type: none"> <li>- The EUT was connected to Spectrum Analyzer and Base Station via power divider.</li> <li>- The 99% and 26 dB occupied bandwidth (BW) of the middle channel for the highest RF powers.</li> </ul>	
Remark		
Result	<input checked="" type="checkbox"/> Pass <input type="checkbox"/> Fail	

Test Data     Yes       N/A

Test Plot     Yes (See below)       N/A

**LTE Band VII (Part 27) result**

BW(MHz)	Channel	Frequency (MHz)	Mode	Emission (dBm)	Limit (dBm)
5	20775	2500	QPSK	-19.366	-13
			16QAM	-19.366	-13
5	21425	2570	QPSK	-18.969	-13
			16QAM	-22.979	-13
10	20800	2500	QPSK	-22.926	-13
			16QAM	-23.065	-13
10	21400	2570	QPSK	-21.025	-13
			16QAM	-21.298	-13
15	20825	2500	QPSK	-23.020	-13
			16QAM	-23.608	-13
15	21400	2570	QPSK	-21.431	-13
			16QAM	-20.803	-13
20	20850	2500	QPSK	-25.607	-13
			16QAM	-25.607	-13
20	21350	2571	QPSK	-24.634	-13
			16QAM	-24.634	-13

### LTE Band VII (Part 27)

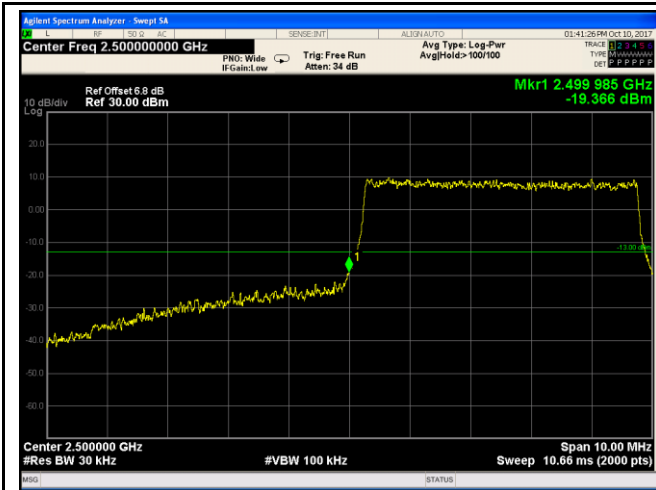

LTE Band VII - Low Channel QPSK-5

Note: Offset=Cable loss (4.5) + 10log  
 (50.78/30)=4.5+2.3=6.8 dB



LTE Band VII - High Channel QPSK-5

Note: Offset=Cable loss (4.5) + 10log  
 (50.30/30)=4.5+2.2=6.7 dB

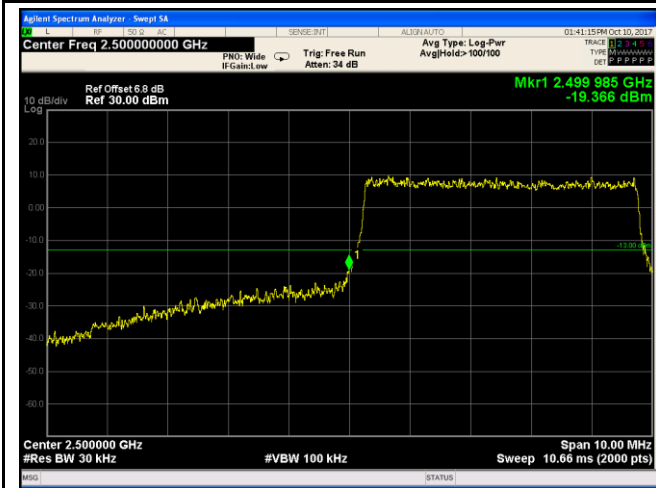

LTE Band VII - Low Channel 16QAM-5

Note: Offset=Cable loss (4.5) + 10log  
 (50.76/30)=4.5+2.3=6.8 dB

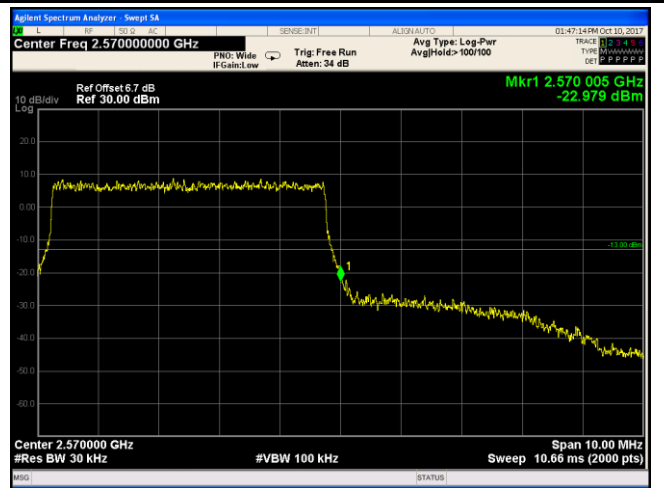

LTE Band VII - High Channel 16QAM-5

Note: Offset=Cable loss (4.5) + 10log  
 (50.13/30)=4.5+2.2=6.7 dB

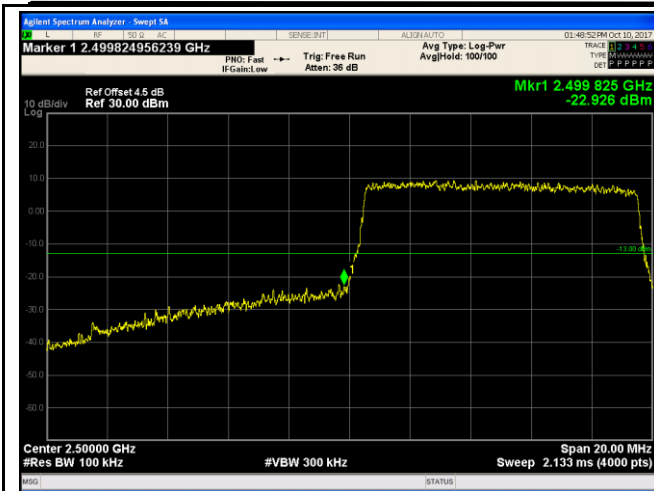

LTE Band VII - Low Channel QPSK-10

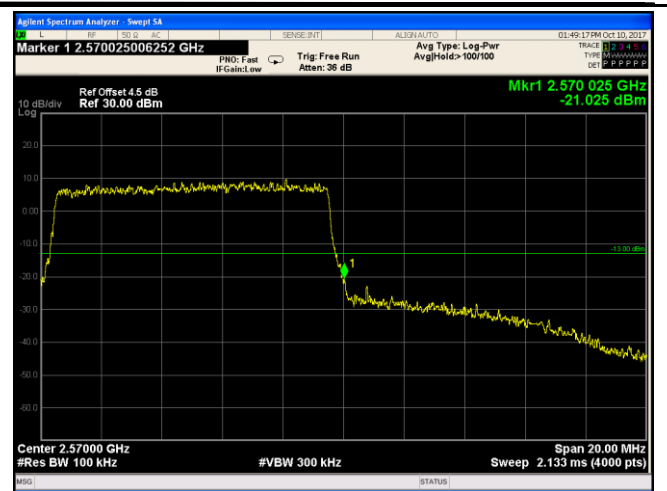

LTE Band VII - High Channel QPSK-10

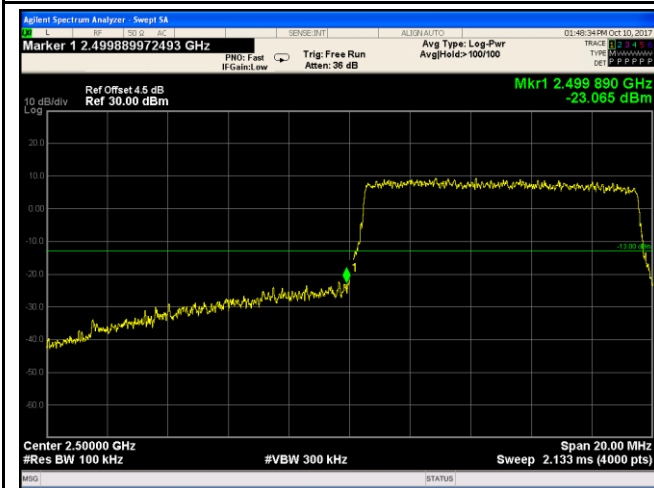

LTE Band VII - Low Channel 16QAM-10

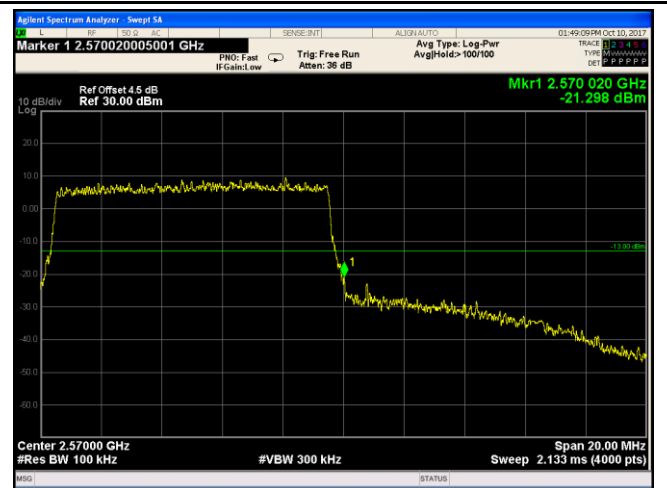

LTE Band VII - High Channel 16QAM-10



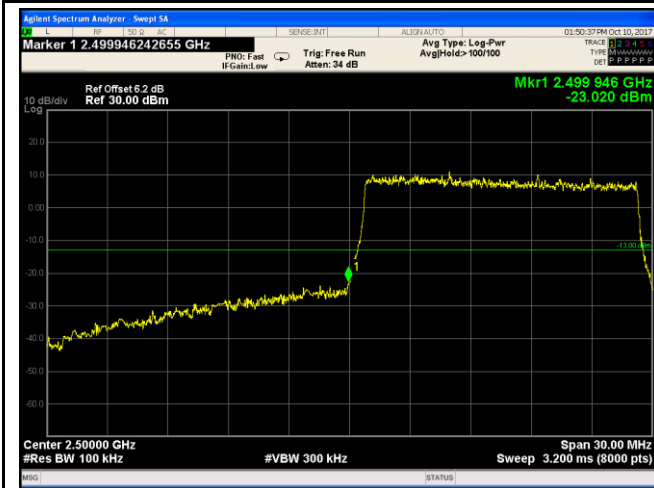

LTE Band VII - Low Channel QPSK-15

Note: Offset=Cable loss (4.5) + 10log  
(147.6/100)=4.5+1.7=6.2 dB

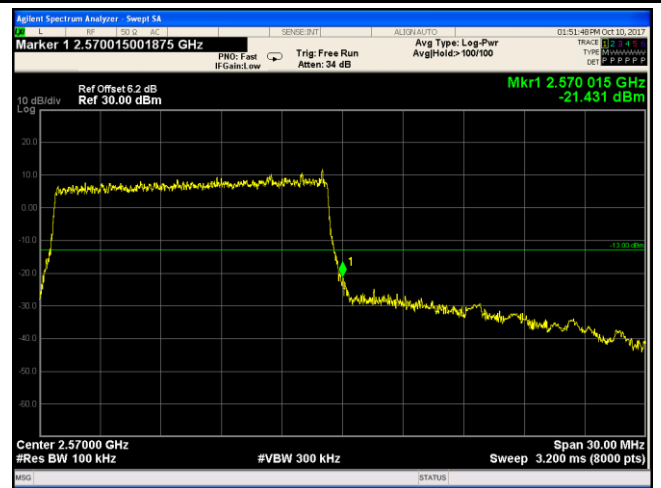

LTE Band VII - High Channel QPSK-15

Note: Offset=Cable loss (4.5) + 10log  
(147.2/100)=4.5+1.7=6.2 dB

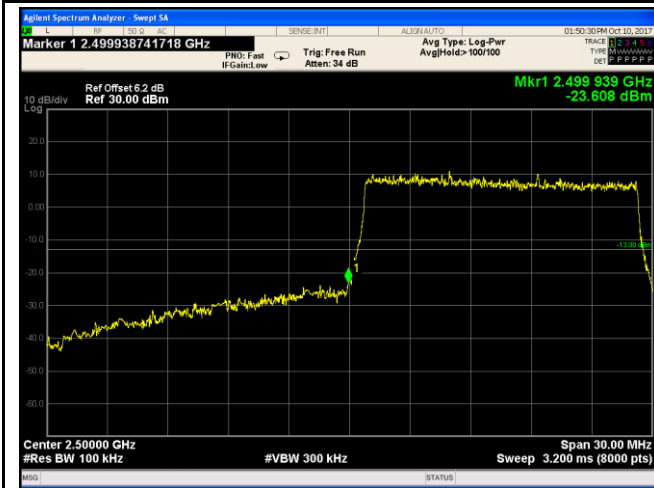

LTE Band VII - Low Channel 16QAM-15

Note: Offset=Cable loss (4.5) + 10log  
(148/100)=4.5+1.7=6.2dB

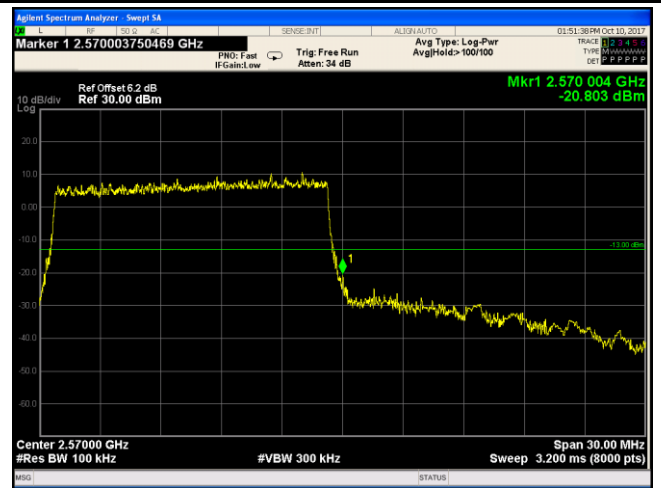

LTE Band VII - High Channel 16QAM-15

Note: Offset=Cable loss (4.5) + 10log  
(147/100)=4.5+1.8=6.2 dB

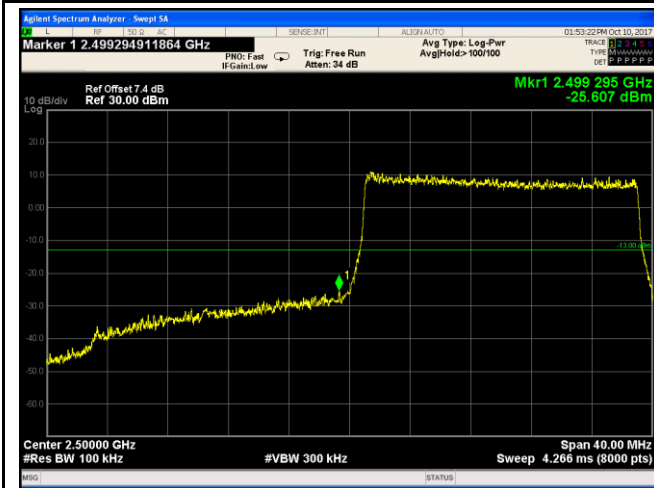

LTE Band VII - Low Channel QPSK-20

Note: Offset=Cable loss (4.5) + 10log  
(194/100)=4.5+2.9=7.4 dB

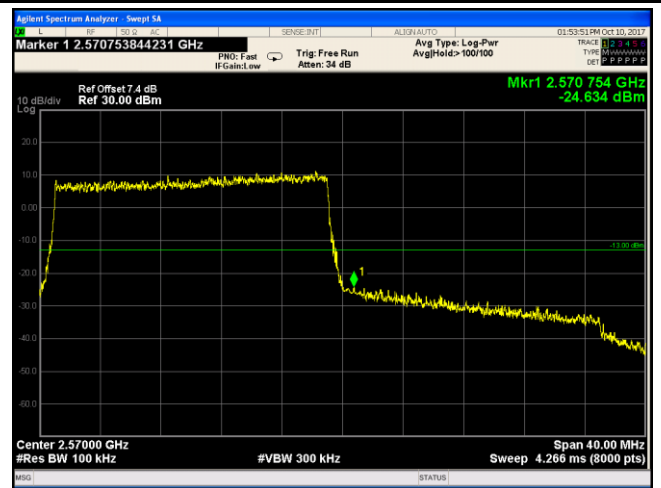

LTE Band VII - High Channel QPSK-20

Note: Offset=Cable loss (4.5) + 10log  
(194/100)=4.5+2.9=7.4dB

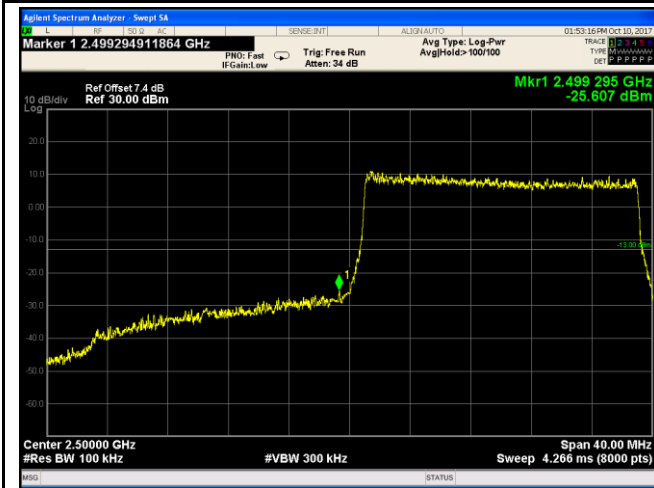

LTE Band VII - Low Channel 16QAM-20

Note: Offset=Cable loss (4.5) + 10log  
(197/100)=4.5+2.9=7.4 dB

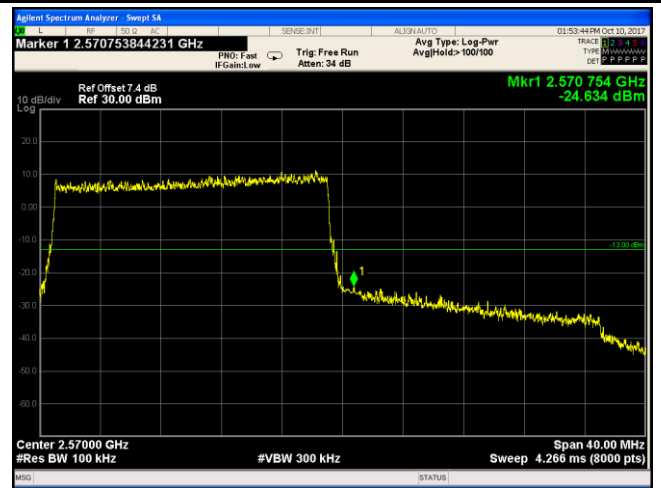

LTE Band VII - High Channel 16QAM-20

Note: Offset=Cable loss (4.5) + 10log  
(193/100)=4.5+2.9=7.4 dB

## 6.9 Frequency Stability

Temperature	25°C
Relative Humidity	55%
Atmospheric Pressure	1012mbar
Test date :	October 10, 2017
Tested By :	Loren Luo

### Requirement(s):

Spec	Item	Requirement	Applicable																																
§2.1055, §22.355 & §24.235 § 27.5(h); § 27.54	a)	According to §22.355, the carrier frequency of each transmitter in the Public Mobile Services must be maintained within the tolerances given in Table below:  Frequency Tolerance for Transmitters in the Public Mobile Services	<input checked="" type="checkbox"/>																																
		<table border="1"> <thead> <tr> <th>Frequency Range (MHz)</th> <th>Base, fixed (ppm)</th> <th>Mobile ≤ 3 watts (ppm)</th> <th>Mobile ≤ 3 watts (ppm)</th> </tr> </thead> <tbody> <tr> <td>25 to 50</td> <td>20.0</td> <td>20.0</td> <td>50.0</td> </tr> <tr> <td>□□to 450</td> <td>5.0</td> <td>5.0</td> <td>50.0</td> </tr> <tr> <td>450 to 512</td> <td>2.5</td> <td>5.0</td> <td>5□0</td> </tr> <tr> <td>821 to 896</td> <td>1.5</td> <td>2.5</td> <td>2.5</td> </tr> <tr> <td>928 to 929.</td> <td>5.0</td> <td>N/A</td> <td>N/A</td> </tr> <tr> <td>929 to 960.</td> <td>1.5</td> <td>N/A</td> <td>N/A</td> </tr> <tr> <td>2110 to 2220</td> <td>10.0</td> <td>N/A</td> <td>N/A</td> </tr> </tbody> </table>		Frequency Range (MHz)	Base, fixed (ppm)	Mobile ≤ 3 watts (ppm)	Mobile ≤ 3 watts (ppm)	25 to 50	20.0	20.0	50.0	□□to 450	5.0	5.0	50.0	450 to 512	2.5	5.0	5□0	821 to 896	1.5	2.5	2.5	928 to 929.	5.0	N/A	N/A	929 to 960.	1.5	N/A	N/A	2110 to 2220	10.0	N/A	N/A
		Frequency Range (MHz)		Base, fixed (ppm)	Mobile ≤ 3 watts (ppm)	Mobile ≤ 3 watts (ppm)																													
		25 to 50		20.0	20.0	50.0																													
		□□to 450		5.0	5.0	50.0																													
		450 to 512		2.5	5.0	5□0																													
		821 to 896		1.5	2.5	2.5																													
		928 to 929.		5.0	N/A	N/A																													
		929 to 960.		1.5	N/A	N/A																													
2110 to 2220	10.0	N/A	N/A																																
According to §24.235, the frequency stability shall be sufficient to ensure that the fundamental emissions stay within the authorized frequency block.																																			
According to §27.54, The frequency stability shall be sufficient to ensure that the fundamental emissions stay within the authorized bands of operation.																																			

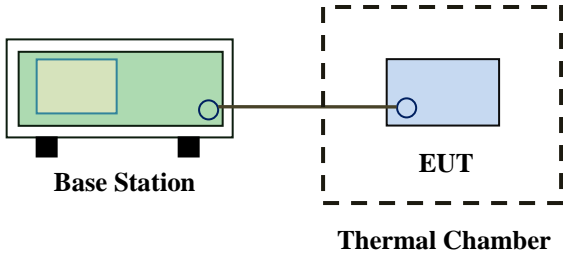
Test setup	 <p>The diagram illustrates the test setup. On the left, a green rectangular box labeled 'Base Station' is shown. A horizontal line connects it to a blue rectangular box labeled 'EUT' (Equipment Under Test) located inside a dashed-line rectangular box labeled 'Thermal Chamber'.</p>
Procedure	<p>A communication link was established between EUT and base station. The frequency error was monitored and measured by base station under variation of ambient temperature and variation of primary supply voltage.</p> <p>Limit: The frequency stability of the transmitter shall be maintained within <math>\pm 0.00025\%</math> (<math>\pm 2.5\text{ppm}</math>) of the center frequency.</p>
Remark	<p>Frequency Stability versus Temperature: The Frequency tolerance of the carrier signal shall be maintained within 2.5ppm of the operating frequency over a temperature variation of <math>-10^{\circ}\text{C}</math> to <math>+55^{\circ}\text{C}</math> at normal supply voltage.</p>
Result	<input checked="" type="checkbox"/> Pass <input type="checkbox"/> Fail

Test Data     Yes                       N/A

Test Plot     Yes (See below)             N/A

### LTE Band II (Part 24E) result

Middle Channel, $f_0 = 1880$ MHz				
Temperature (°C)	Power Supplied (V <sub>DC</sub> )	Frequency Error (Hz)	Frequency Error (ppm)	Limit (ppm)
-10	3.8	-12	0.0069	2.5
0		-17	0.0098	2.5
10		-12	0.0069	2.5
20		-12	0.0069	2.5
30		-8	0.0046	2.5
40		-9	0.0052	2.5
50		-16	0.0092	2.5
55		-14	0.0081	2.5
25	4.2	-14	0.0081	2.5
	3.6	-16	0.0092	2.5

### LTE Band IV (Part 27) result

Middle Channel, $f_0 = 1732.5$ MHz				
Temperature (°C)	Power Supplied (V <sub>DC</sub> )	Frequency Error (Hz)	Frequency Error (ppm)	Limit (ppm)
-10	3.8	-12	0.0069	2.5
0		-16	0.0092	2.5
10		-10	0.0058	2.5
20		-16	0.0092	2.5
30		-12	0.0069	2.5
40		-13	0.0075	2.5
50		-17	0.0098	2.5
55		-14	0.0081	2.5
25	4.2	-12	0.0069	2.5
	3.6	-12	0.0069	2.5

**LTE Band VII (Part 27) result**

Middle Channel, $f_0 = 2535$ MHz				
Temperature (°C)	Power Supplied (V <sub>DC</sub> )	Frequency Error (Hz)	Frequency Error (ppm)	Limit (ppm)
-10	3.8	-12	0.0069	2.5
0		-14	0.0081	2.5
10		-15	0.0087	2.5
20		-12	0.0069	2.5
30		-8	0.0046	2.5
40		-15	0.0087	2.5
50		-7	0.0040	2.5
55		-13	0.0075	2.5
25		4.2	-12	0.0069
	3.6	-17	0.0098	2.5

### LTE Band XII (Part 27) result

Middle Channel, $f_0 = 707.5\text{MHz}$				
Temperature (°C)	Power Supplied (V <sub>DC</sub> )	Frequency Error (Hz)	Frequency Error (ppm)	Limit (ppm)
-10	3.8	-12	0.0069	2.5
0		-12	0.0069	2.5
10		-11	0.0063	2.5
20		-16	0.0092	2.5
30		-11	0.0063	2.5
40		-7	0.0040	2.5
50		-13	0.0075	2.5
55		-10	0.0058	2.5
25	4.2	-8	0.0046	2.5
	3.6	-15	0.0087	2.5

### LTE Band XVII (Part 27) result

Middle Channel, $f_0 = 710\text{MHz}$				
Temperature (°C)	Power Supplied (V <sub>DC</sub> )	Frequency Error (Hz)	Frequency Error (ppm)	Limit (ppm)
-10	3.8	-12	0.0069	2.5
0		-13	0.0075	2.5
10		-13	0.0075	2.5
20		-7	0.0040	2.5
30		-14	0.0081	2.5
40		-8	0.0046	2.5
50		-13	0.0075	2.5
55		-11	0.0063	2.5
25	4.2	-8	0.0046	2.5
	3.6	-15	0.0087	2.5