



FCC RF Test Report

APPLICANT : CT Asia
EQUIPMENT : GSM Mobile Phone
BRAND NAME : BLU
MODEL NAME : Diva X
FCC ID : YHLBLUDIVAX
STANDARD : FCC Part 15 Subpart C §15.247
CLASSIFICATION : (DSS) Spread Spectrum Transmitter

The product was received on Apr. 01, 2013 and completely tested on May 15, 2013. We, SPORTON INTERNATIONAL (SHENZHEN) INC., would like to declare that the tested sample has been evaluated in accordance with the procedures and shown the compliance with the applicable technical standards.

The test results in this report apply exclusively to the tested model / sample. Without written approval of SPORTON INTERNATIONAL (SHENZHEN) INC., the test report shall not be reproduced except in full.

Reviewed by:

Jones Tsai / Manager



SPORTON INTERNATIONAL (SHENZHEN) INC.

No. 3 Building, the third floor of south, Shahe River west, Fengzeyuan warehouse, Nanshan District, Shenzhen, Guangdong, P.R.C



TABLE OF CONTENTS

REVISION HISTORY..... 3

SUMMARY OF TEST RESULT 4

1 GENERAL DESCRIPTION..... 5

 1.1 Applicant 5

 1.2 Manufacturer 5

 1.3 Feature of Equipment Under Test 5

 1.4 Product Specification of Equipment Under Test..... 5

 1.5 Testing Site 6

 1.6 Applied Standards 6

2 TEST CONFIGURATION OF EQUIPMENT UNDER TEST..... 7

 2.1 Descriptions of Test Mode 7

 2.2 Test Mode 8

 2.3 Connection Diagram of Test System 9

 2.4 Support Unit used in test configuration and system 10

 2.5 Description of RF Function Operation Test Setup 10

 2.6 Measurement Results Explanation Example 10

3 TEST RESULT 12

 3.1 Number of Channel Measurement 12

 3.2 Hopping Channel Separation Measurement 15

 3.3 Dwell Time Measurement 22

 3.4 20dB Bandwidth Measurement 24

 3.5 Peak Output Power Measurement 31

 3.6 Conducted Band Edges Measurement 34

 3.7 Conducted Spurious Emission Measurement 41

 3.8 Radiated Band Edges and Spurious Emission Measurement 45

 3.9 AC Conducted Emission Measurement 57

 3.10 Antenna Requirements 61

4 LIST OF MEASURING EQUIPMENT..... 62

5 UNCERTAINTY OF EVALUATION..... 63

APPENDIX A. PHOTOGRAPHS OF EUT

APPENDIX B. SETUP PHOTOGRAPHS

SUMMARY OF TEST RESULT

Report Section	FCC Rule	Description	Limit	Result	Remark
3.1	15.247(a)(1)	Number of Channels	≥ 15Chs	Pass	-
3.2	15.247(a)(1)	Hopping Channel Separation	≥ 2/3 of 20dB BW	Pass	-
3.3	15.247(a)(1)	Dwell Time of Each Channel	≤ 0.4sec in 31.6sec period	Pass	-
3.4	15.247(a)(1)	20dB Bandwidth	NA	Pass	-
3.5	15.247(b)(1)	Peak Output Power	≤ 1 w for 1Mbps ≤ 125 Mw for 2, 3Mbps	Pass	-
3.6	15.247(d)	Conducted Band Edges	≤ 20dBc	Pass	-
3.7	15.247(d)	Conducted Spurious Emission	≤ 20dBc	Pass	-
3.8	15.247(d)	Radiated Band Edges and Radiated Spurious Emission	15.209(a) & 15.247(d)	Pass	Under limit 11.1 dB at 2483.500 MHz
3.9	15.207	AC Conducted Emission	15.207(a)	Pass	Under limit 5.06 dB at 0.400 MHz
3.10	15.203 & 15.247(b)	Antenna Requirement	N/A	Pass	-

1 General Description

1.1 Applicant

CT Asia

Unit 01, 15/F, Seaview Centre, 139-141 Hoi bun road, Kwun Tong, Kowloon, Hongkong

1.2 Manufacturer

Tinno Mobile Technology Corp.

4/F., H-3 Building, OCT Eastern Industrial Park. NO.1 XiangShan East Road., Nan Shan

1.3 Feature of Equipment Under Test

Product Feature	
Equipment	GSM Mobile Phone
Brand Name	BLU
Model Name	Diva X
FCC ID	YHLBLUDIVAX
EUT supports Radios application	GSM/GPRS/Bluetooth
HW Version	V1.0
SW Version	B2060A_PP_F2F3F5F8_EN_28_01
EUT Stage	Identical Prototype

Remark: The above EUT's information was declared by manufacturer. Please refer to the specifications or user's manual for more detailed description.

1.4 Product Specification of Equipment Under Test

Product Specification subjective to this standard	
Tx/Rx Frequency Range	2402 MHz ~ 2480 MHz
Number of Channels	79
Carrier Frequency of Each Channel	2402+n*1 MHz; n=0~78
Maximum Output Power to Antenna	Bluetooth BDR (1Mbps) : 4.81 dBm (0.00303 W) Bluetooth EDR (2Mbps) : 4.52 dBm (0.00283 W) Bluetooth EDR (3Mbps) : 4.84 dBm (0.00305 W)
Antenna Type	PIFA Antenna type with gain 1.4 dBi
Type of Modulation	Bluetooth BDR (1Mbps) : GFSK Bluetooth EDR (2Mbps) : $\pi/4$ -DQPSK Bluetooth EDR (3Mbps) : 8-DPSK

1.5 Testing Site

Test Site	SPORTON INTERNATIONAL (KUNSHAN) INC.		
Test Site Location	No. 3 Building, the third floor of south, Shahe River west, Fengzeyuan warehouse, Nanshan District, Shenzhen, Guangdong, P.R.C. TEL: +86-755- 3320-2398		
Test Site No.	Sporton Site No.		FCC/IC Registration No.
	TH01-SZ	CO01-SZ	03CH01-SZ
			831040/4086F-1

The test site complies with ANSI C63.4 2003 requirement.

1.6 Applied Standards

According to the specifications of the manufacturer, the EUT must comply with the requirements of the following standards:

- FCC Part 15 Subpart C §15.247
- FCC Public Notice DA 00-705
- ANSI C63.10-2009

Remark:

1. All test items were verified and recorded according to the standards and without any deviation during the test.
2. This EUT has also been tested and complied with the requirements of FCC Part 15, Subpart B, recorded in a separate test report.

2 Test Configuration of Equipment Under Test

2.1 Descriptions of Test Mode

Preliminary tests were performed in different data rate and recorded the RF output power in the following table:

Channel	Frequency	Bluetooth RF Output Power		
		Data Rate / Modulation		
		GFSK	$\pi/4$ -DQPSK	8-DPSK
		1Mbps	2Mbps	3Mbps
Ch00	2402MHz	4.08 dBm	3.75 dBm	3.91 dBm
Ch39	2441MHz	4.81 dBm	4.52 dBm	4.84 dBm
Ch78	2480MHz	4.05 dBm	3.78 dBm	4.01 dBm

Remark:

1. All the test data for each data rate were verified, but only the worst case was reported.
 2. The data rate was set in 3Mbps for all the test items due to the highest RF output power.
-
- a. The EUT has been associated with peripherals pursuant to ANSI C63.10-2009 and configuration operated in a manner tended to maximize its emission characteristics in a typical application. Frequency range investigated: conduction (150 KHz to 30 MHz), radiation (9 KHz to the 10th harmonic of the highest fundamental frequency or to 40 GHz, whichever is lower). Pre-scanned tests, X, Y, Z in three orthogonal panels, and different data rates were conducted to determine the final configuration (Y plane as worst plane) from all possible combinations, and the worst mode of radiated spurious emissions is Bluetooth 3Mbps mode, and recorded in this report.
 - b. AC power line Conducted Emission was tested under maximum output power.

2.2 Test Mode

The following summary table is showing all test modes to demonstrate in compliance with the standard.

Summary table of Test Cases			
Test Item	Data Rate / Modulation		
	Bluetooth BDR 1Mbps GFSK	Bluetooth EDR 2Mbps $\pi/4$ -DQPSK	Bluetooth EDR 3Mbps 8-DPSK
Conducted Test Cases	Mode 1: CH00_2402 MHz	Mode 4: CH00_2402 MHz	Mode 7: CH00_2402 MHz
	Mode 2: CH39_2441 MHz	Mode 5: CH39_2441 MHz	Mode 8: CH39_2441 MHz
	Mode 3: CH78_2480 MHz	Mode 6: CH78_2480 MHz	Mode 9: CH78_2480 MHz
Radiated Test Cases	Bluetooth EDR 3Mbps 8-DPSK		
	Mode 1: CH00_2402 MHz		
	Mode 2: CH39_2441 MHz		
	Mode 3: CH78_2480 MHz		
AC Conducted Emission	Mode 1 :GSM850 Idle + Bluetooth Link + USB Cable (Charging from Adapter) + Earphone		
<p>Remark: For radiated test cases, the worst mode data rate 3Mbps was reported only, because this data rate has the highest RF output power at preliminary tests, and the conducted spurious emissions and conducted band edge measurement for each data rate are no worse than 3Mbps, and no other significantly frequencies found in conducted spurious emission.</p>			

2.3 Connection Diagram of Test System

<Bluetooth Tx Mode>

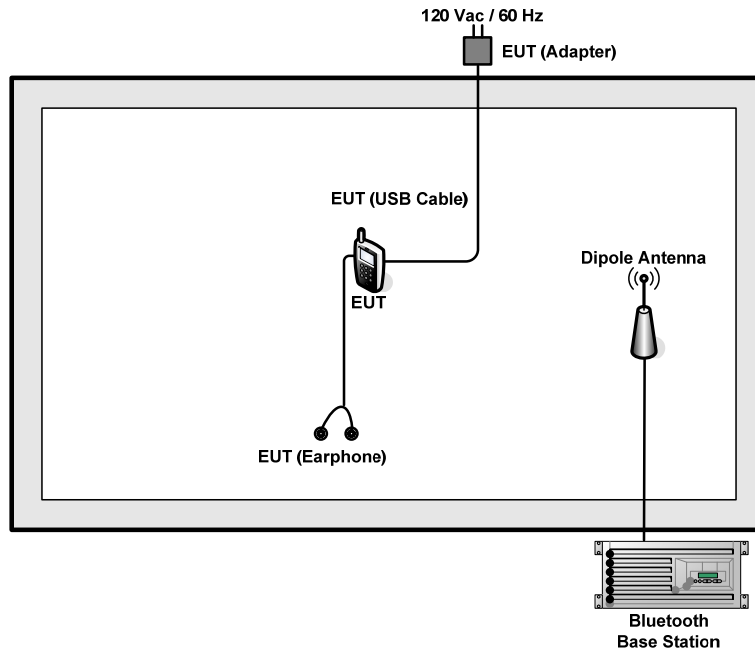

<AC Conducted Emission Mode>

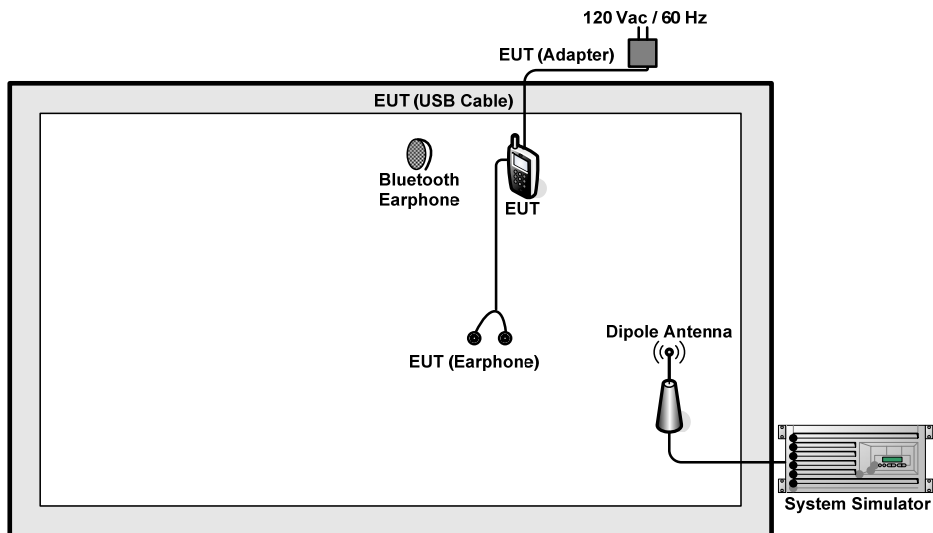

2.4 Support Unit used in test configuration and system

Item	Equipment	Trade Name	Model Name	FCC ID	Data Cable	Power Cord
1.	System Simulator	Agilent	E5515C	N/A	N/A	Unshielded, 1.8 m
2.	DC Power Supply	TOPWORD	3303DR	N/A	N/A	Unshielded, 1.8 m
3.	Bluetooth Earphone	Nokia	BH-108	N/A	N/A	N/A

2.5 Description of RF Function Operation Test Setup

For Bluetooth function, key in “* #84666364 #*” on the EUT directly. Then, the EUT will get into the engineering modes to contact with Bluetooth base station for continuous transmitting and receiving signals.

2.6 Measurement Results Explanation Example

For conducted test items:

The offset level is set in the spectrum analyzer to compensate the RF cable loss and 10dB attenuator between EUT conducted output port and spectrum analyzer. With the offset compensation, the spectrum analyzer reading level is exactly the EUT RF output level.

The spectrum analyzer offset is derived from RF cable loss and 10dB attenuator factor.

Offset = RF cable loss + attenuator factor.

Following table shows an offset computation example with cable loss 5.6 dB.

Example :

$$\begin{aligned} \text{Offset(dB)} &= \text{RF cable loss(dB)} + \text{attenuator factor(dB)}. \\ &= 5.6 + 10 = 15.6 \text{ (dB)} \end{aligned}$$

For radiated band edges and spurious emission test :

Per part 15.35(c), the EUT Bluetooth average emission level could be determined by the peak emission level applying duty cycle correction factor, to represent averaging over the whole pulse train.

The average level is derived from the peak level corrected with "Duty cycle correction factor".

$$\text{Average Emission Level(dBuV/m)} = \text{Peak Emission Level(dBuV/m)} + \text{Duty cycle correction factor(dB)}$$

$$\text{Duty cycle correction factor(dB)} = 20 * \log(\text{Duty cycle}).$$

$$\text{Duty cycle} = \text{On time} / 100 \text{ milliseconds}$$

$$\text{On time} = \text{dwell time} * \text{hopping number in } 100 \text{ ms}$$

For example : bluetooth with dwell time 2.9ms and 2 hops in 100 ms, then

$$\text{Duty cycle correction factor(dB)} = 20 * \log((2.9 * 2) / 100) = -24.73 \text{ dB}$$

Following shows an average computation example with duty cycle correction factor = -24.73dB, and the peak emission level is 45.61 dBuV/m.

Example :

$$\begin{aligned} \text{Average Emission Level(dBuV/m)} &= \text{Peak Emission Level(dBuV/m)} + \text{duty cycle correction factor(dB)} \\ &= 45.61 + (-24.73) = 20.88 \text{ (dBuV/m)} \end{aligned}$$

3 Test Result

3.1 Number of Channel Measurement

3.1.1 Limits of Number of Hopping Frequency

Frequency hopping systems in the 2400-2483.5 MHz band shall use at least 15 channels.

3.1.2 Measuring Instruments

See list of measuring instruments of this test report.

3.1.3 Test Procedure

1. The testing follows FCC Public Notice DA 00-705 Measurement Guidelines.
2. The RF output of EUT was connected to the spectrum analyzer by RF cable and attenuator. The path loss was compensated to the results for each measurement.
3. Set to the maximum power setting and enable the EUT transmit continuously.
4. Enable the EUT hopping function.
5. Use the following spectrum analyzer settings: Span = the frequency band of operation; RBW \geq 1% of the span; VBW \geq RBW; Sweep = auto; Detector function = peak; Trace = max hold.
6. The number of hopping frequency used is defined as the number of total channel.
7. Record the measurement data derived from spectrum analyzer.

3.1.4 Test Setup

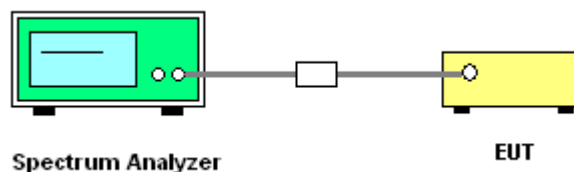



3.1.5 Test Result of Number of Hopping Frequency

Test Mode :	3Mbps	Temperature :	24~26°C
Test Engineer :	Blithe Li	Relative Humidity :	50~53%
Number of Hopping (Channel)	Adaptive Frequency Hopping (Channel)	Limits (Channel)	Pass/Fail
79	>= 20	> 15	Pass

Number of Hopping Channel Plot on Channel 00 - 78

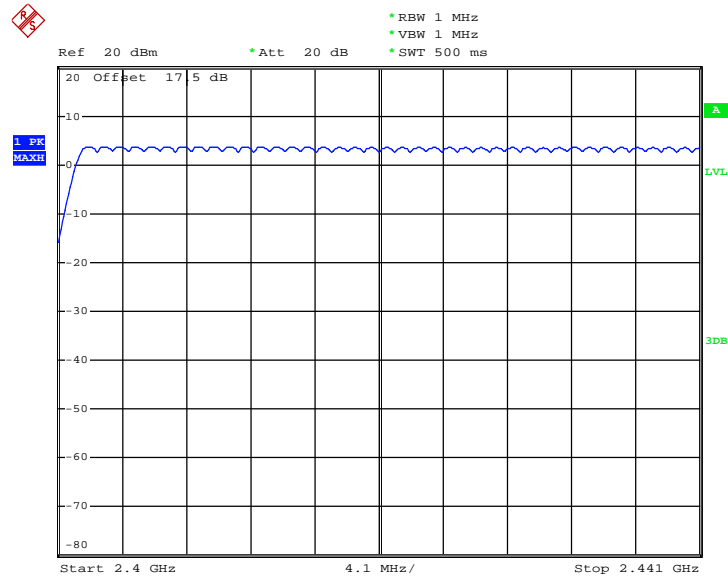

Date: 15.MAY.2013 16:25:34

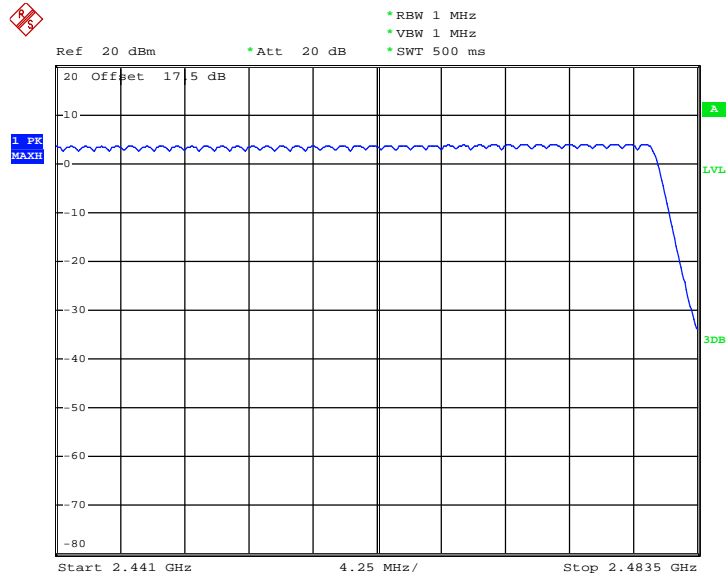

Date: 15.MAY.2013 16:31:20

3.2 Hopping Channel Separation Measurement

3.2.1 Limit of Hopping Channel Separation

Frequency hopping systems operating in the 2400-2483.5 MHz band may have hopping channel carrier frequencies that are separated by 25 KHz or two-thirds of the 20 dB bandwidth of the hopping channel, whichever is greater.

3.2.2 Measuring Instruments

See list of measuring instruments of this test report.

3.2.3 Test Procedures

1. The testing follows FCC Public Notice DA 00-705 Measurement Guidelines.
2. The RF output of EUT was connected to the spectrum analyzer by RF cable and attenuator. The path loss was compensated to the results for each measurement.
3. Set to the maximum power setting and enable the EUT transmit continuously.
4. Enable the EUT hopping function.
5. Use the following spectrum analyzer settings:
Span = wide enough to capture the peaks of two adjacent channels; RBW \geq 1% of the span;
VBW \geq RBW; Sweep = auto; Detector function = peak; Trace = max hold.
6. Measure and record the results in the test report.

3.2.4 Test Setup

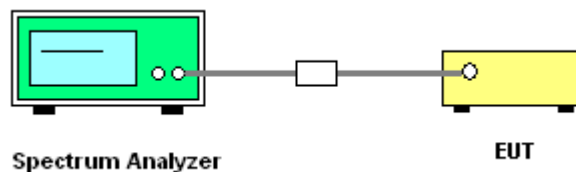

3.2.5 Test Result of Hopping Channel Separation

Test Mode :	1Mbps	Temperature :	24~26°C
Test Engineer :	Blithe Li	Relative Humidity :	50~53%

Channel	Frequency (MHz)	Frequency Separation (MHz)	(2/3 of 20dB BW) Limits (MHz)	Pass/Fail
00	2402	1.002	0.6320	Pass
39	2441	1.008	0.6347	Pass
78	2480	1.002	0.6320	Pass

Channel Separation Plot on Channel 00 - 01

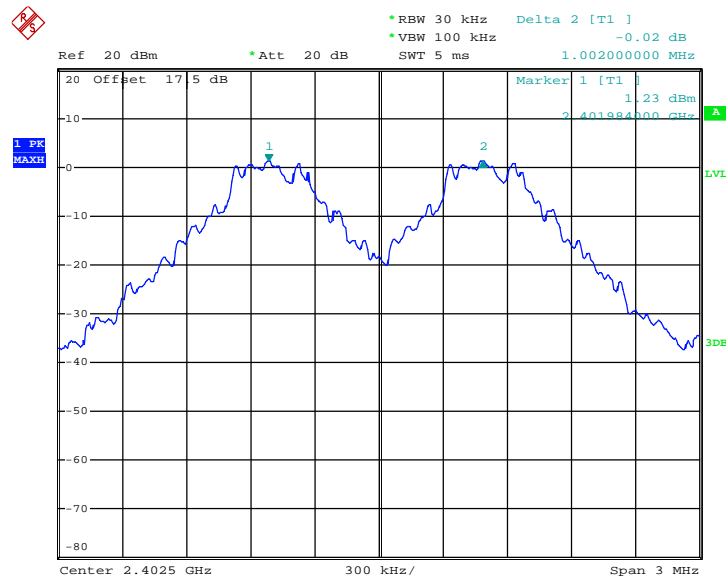

Date: 15.MAY.2013 16:00:23



Channel Separation Plot on Channel 39 - 40

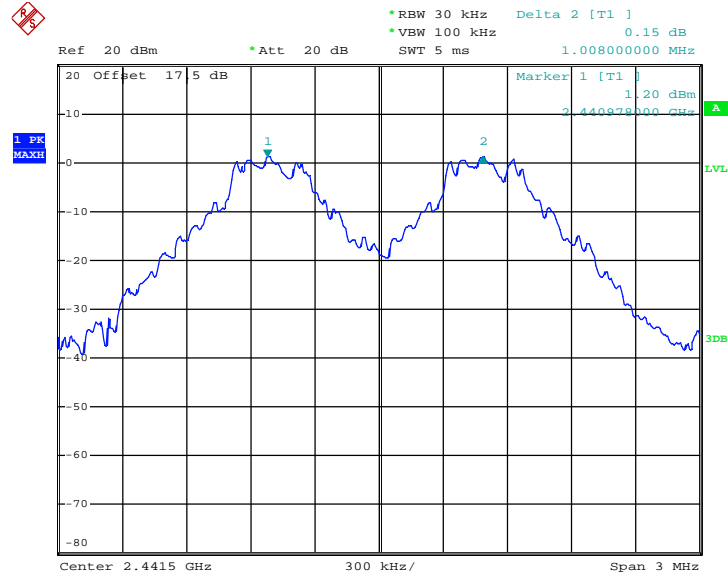

Date: 15.MAY.2013 15:54:23

Channel Separation Plot on Channel 77 - 78

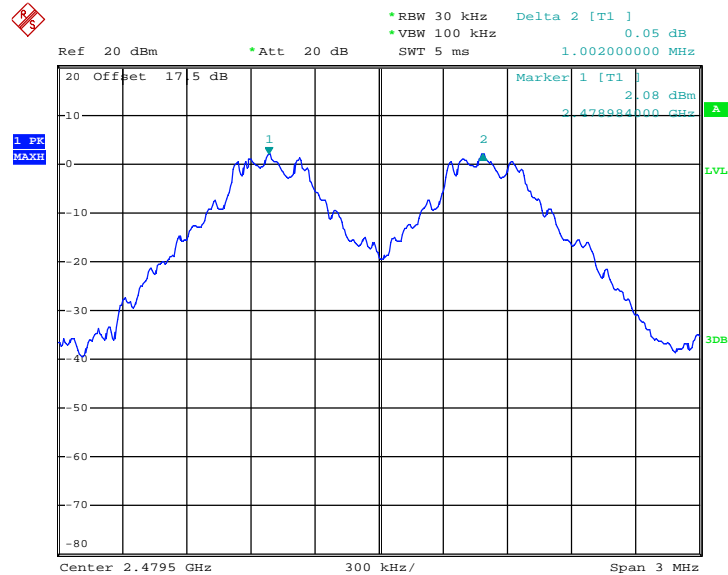

Date: 15.MAY.2013 15:54:50



Test Mode :	2Mbps	Temperature :	24~26°C
Test Engineer :	Blithe Li	Relative Humidity :	50~53%

Channel	Frequency (MHz)	Frequency Separation (MHz)	(2/3 of 20dB BW) Limits (MHz)	Pass/Fail
00	2402	1.008	0.8160	Pass
39	2441	1.002	0.8160	Pass
78	2480	1.008	0.8133	Pass

Channel Separation Plot on Channel 00 - 01

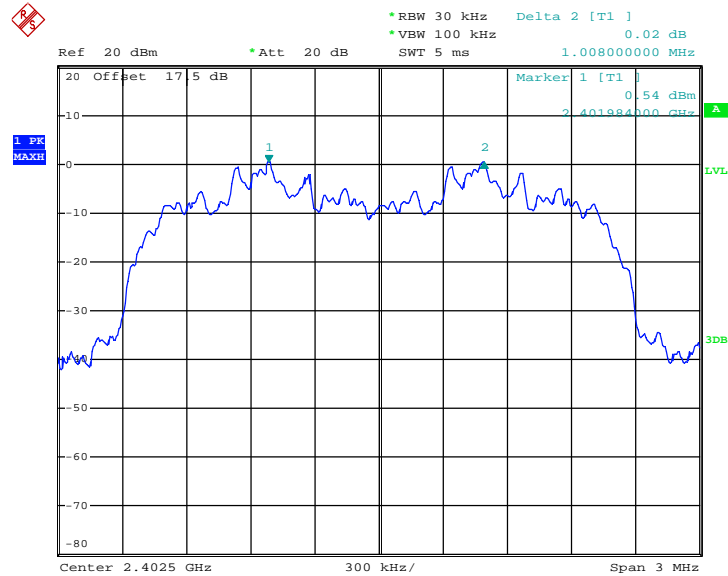

Date: 15.MAY.2013 15:59:24



Channel Separation Plot on Channel 39 - 40

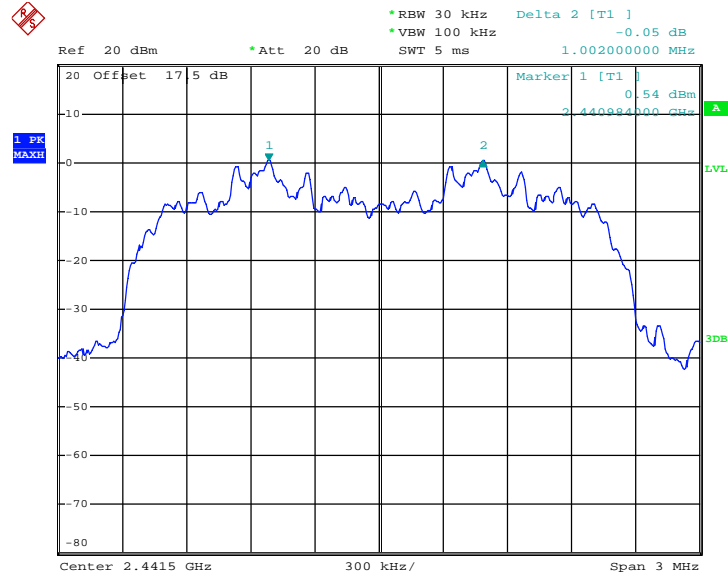

Date: 15.MAY.2013 15:55:54

Channel Separation Plot on Channel 77 - 78

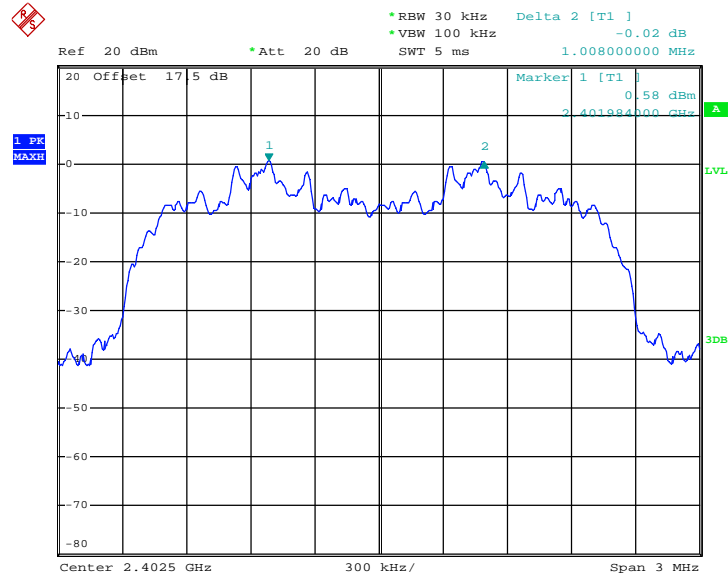

Date: 15.MAY.2013 15:56:39



Test Mode :	3Mbps	Temperature :	24~26°C
Test Engineer :	Blithe Li	Relative Humidity :	50~53%

Channel	Frequency (MHz)	Frequency Separation (MHz)	(2/3 of 20dB BW) Limits (MHz)	Pass/Fail
00	2402	1.002	0.8213	Pass
39	2441	1.002	0.8187	Pass
78	2480	1.002	0.8187	Pass

Channel Separation Plot on Channel 00 - 01

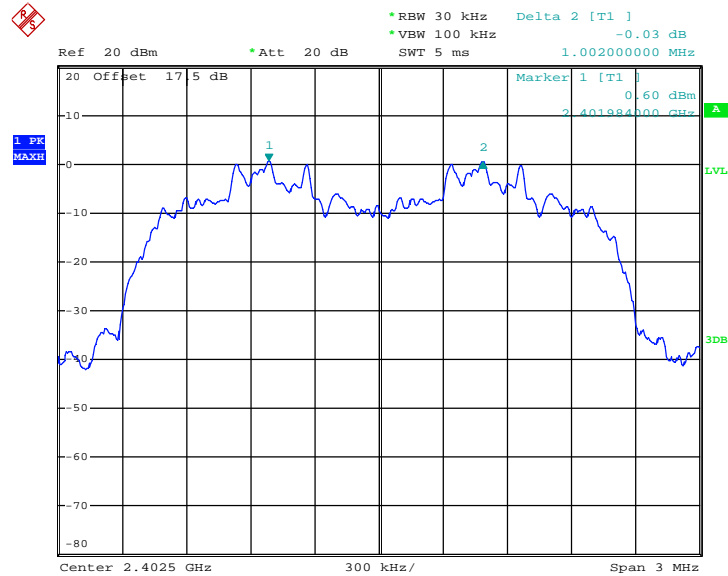

Date: 15.MAY.2013 15:57:31



Channel Separation Plot on Channel 39 - 40

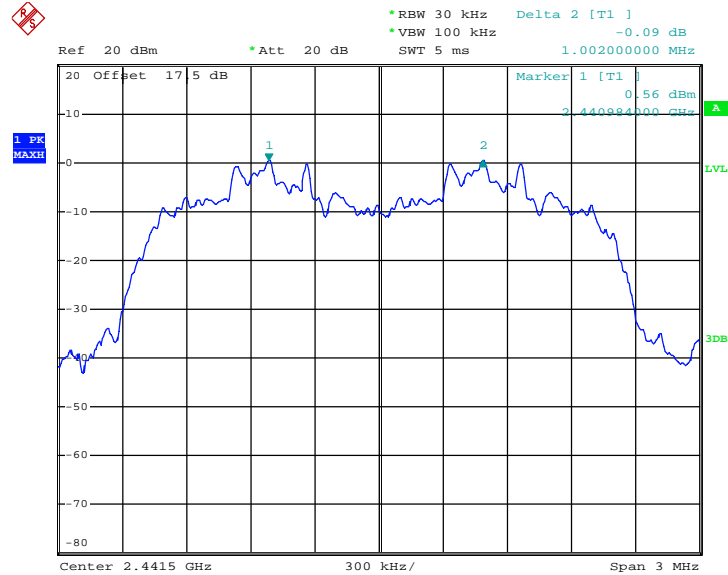

Date: 15.MAY.2013 15:58:02

Channel Separation Plot on Channel 77 - 78

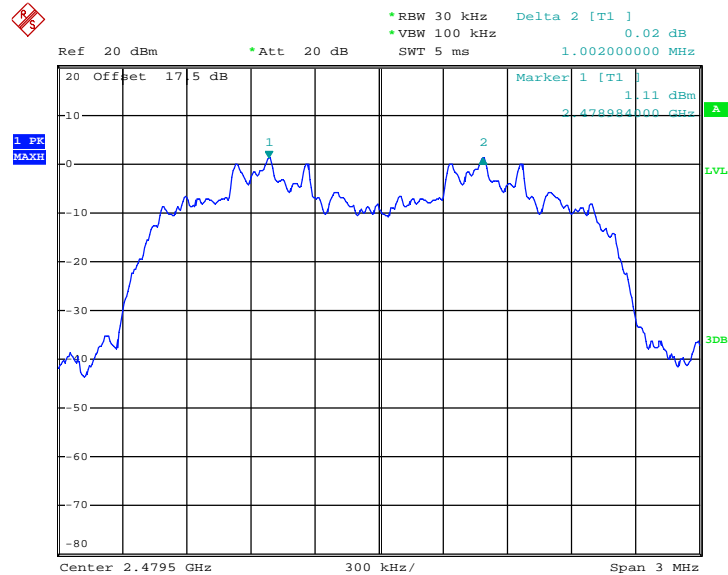

Date: 15.MAY.2013 15:58:35

3.3 Dwell Time Measurement

3.3.1 Limit of Dwell Time

The average time of occupancy on any channel shall not be greater than 0.4 seconds within a period of 0.4 seconds multiplied by the number of hopping channels employed.

3.3.2 Measuring Instruments

See list of measuring instruments of this test report.

3.3.3 Test Procedures

1. The testing follows FCC Public Notice DA 00-705 Measurement Guidelines.
2. The RF output of EUT was connected to the spectrum analyzer by RF cable and attenuator. The path loss was compensated to the results for each measurement.
3. Set to the maximum power setting and enable the EUT transmit continuously.
4. Enable the EUT hopping function.
5. Use the following spectrum analyzer settings: Span = zero span, centered on a hopping channel; RBW = 1 MHz; VBW \geq RBW; Sweep = as necessary to capture the entire dwell time per hopping channel; Detector function = peak; Trace = max hold.
6. Measure and record the results in the test report.

3.3.4 Test Setup

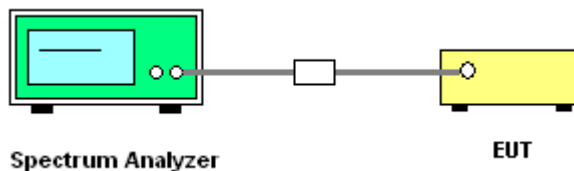

3.3.5 Test Result of Dwell Time

Test Mode :	3DH5	Temperature :	24~26°C
Test Engineer :	Blithe Li	Relative Humidity :	50~53%

Mode	Hopping Channel Number	Hops Over Occupancy Time(hops)	Package Transfer Time (msec)	Dwell Time (sec)	Limits (sec)	Pass/Fail
Normal	79	106.67	2.960	0.32	0.4	Pass
AFH	20	53.34	2.960	0.16	0.4	Pass

Remark:

1. In normal mode, hopping rate is 1600hops/s with 6 slots in 79 hopping channels.
 With channel hopping rate (1600 / 6 / 79) in Occupancy Time Limit (0.4 x 79) (s),
 Hops Over Occupancy Time comes to (1600 / 6 / 79) x (0.4 x 79) = 106.67 hops.

2. In AFH mode, hopping rate is 800hops/s with 6 slots in 20 hopping channels.
 With channel hopping rate (800 / 6 / 20) in Occupancy Time Limit (0.4 x 20) (s),
 Hops Over Occupancy Time comes to (800 / 6 / 20) x (0.4 x 20) = 53.34 hops.

3. Dwell Time(s) = Hops Over Occupancy Time (hops) x Package Transfer Time

Package Transfer Time Plot

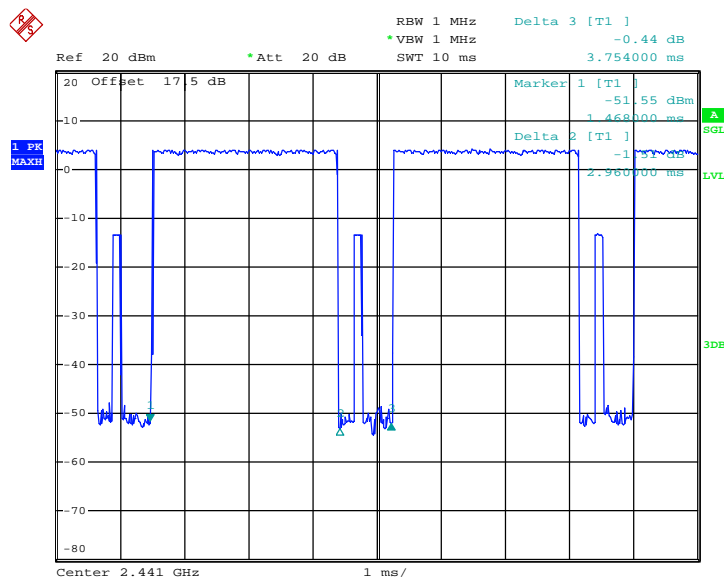

Date: 11.MAY.2013 10:59:36

3.4 20dB Bandwidth Measurement

3.4.1 Limit of 20dB Bandwidth

Reporting only

3.4.2 Measuring Instruments

See list of measuring instruments of this test report.

3.4.3 Test Procedures

1. The testing follows FCC Public Notice DA 00-705 Measurement Guidelines.
2. The RF output of EUT was connected to the spectrum analyzer by RF cable and attenuator. The path loss was compensated to the results for each measurement.
3. Set to the maximum power setting and enable the EUT transmit continuously.
4. Use the following spectrum analyzer settings for 20dB Bandwidth measurement.
Span = approximately 2 to 3 times the 20 dB bandwidth, centered on a hopping channel;
RBW \geq 1% of the 20 dB bandwidth; VBW \geq RBW; Sweep = auto; Detector function = peak;
Trace = max hold.
5. Measure and record the results in the test report.

3.4.4 Test Setup

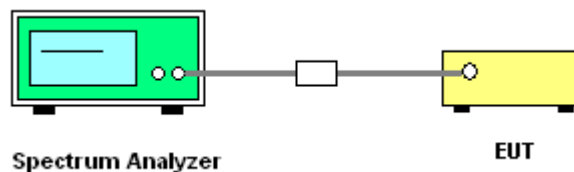

3.4.5 Test Result of 20dB Bandwidth

Test Mode :	1Mbps	Temperature :	24~26°C
Test Engineer :	Blithe Li	Relative Humidity :	50~53%

Channel	Frequency (MHz)	20dB Bandwidth (MHz)
00	2402	0.948
39	2441	0.952
78	2480	0.948

20 dB Bandwidth Plot on Channel 00

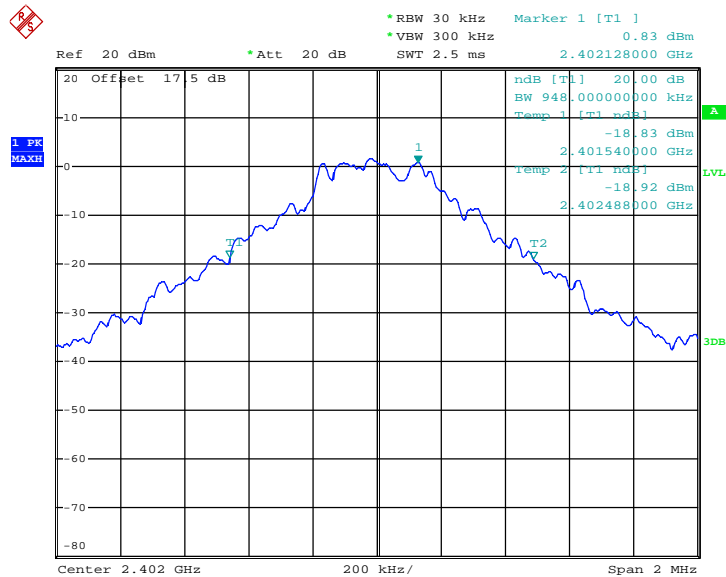

Date: 15.MAY.2013 15:38:49



20 dB Bandwidth Plot on Channel 39

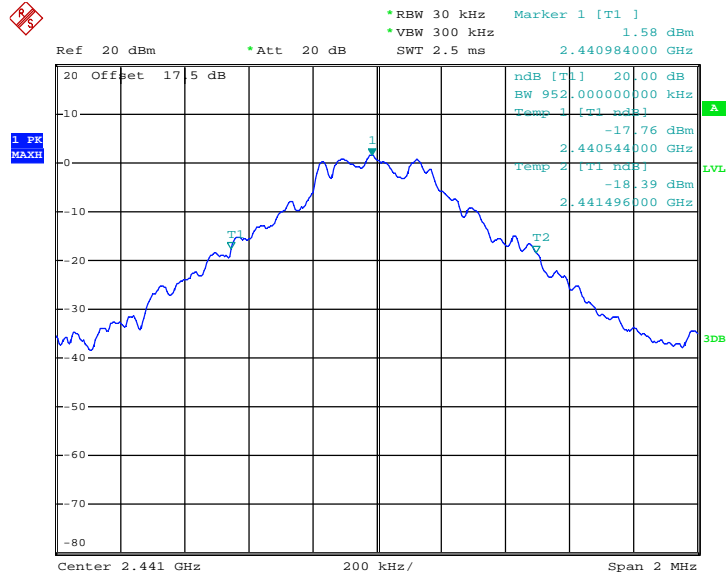

Date: 15.MAY.2013 15:36:08

20 dB Bandwidth Plot on Channel 78

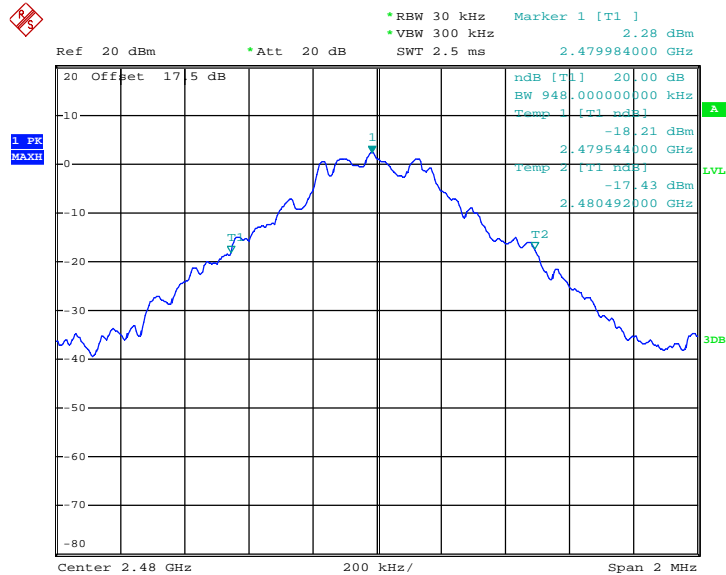

Date: 15.MAY.2013 15:39:30



Test Mode :	2Mbps	Temperature :	24~26°C
Test Engineer :	Blithe Li	Relative Humidity :	50~53%

Channel	Frequency (MHz)	20dB Bandwidth (MHz)
00	2402	1.224
39	2441	1.224
78	2480	1.220

20 dB Bandwidth Plot on Channel 00

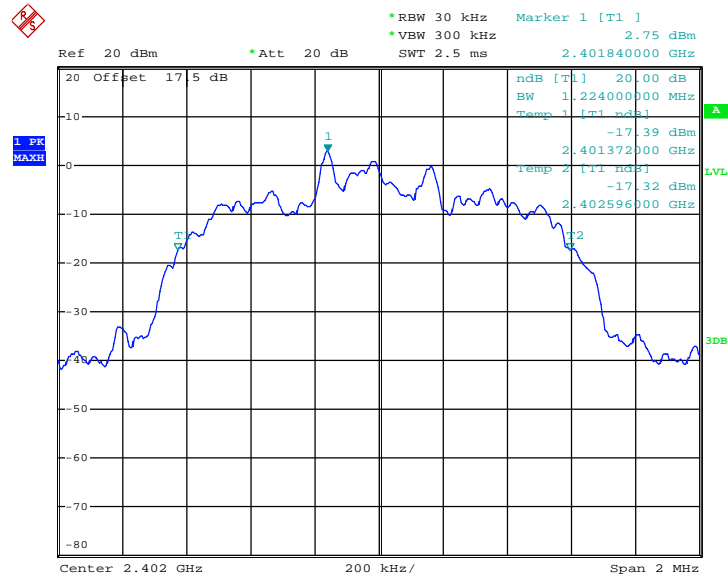

Date: 15.MAY.2013 15:32:57



20 dB Bandwidth Plot on Channel 39

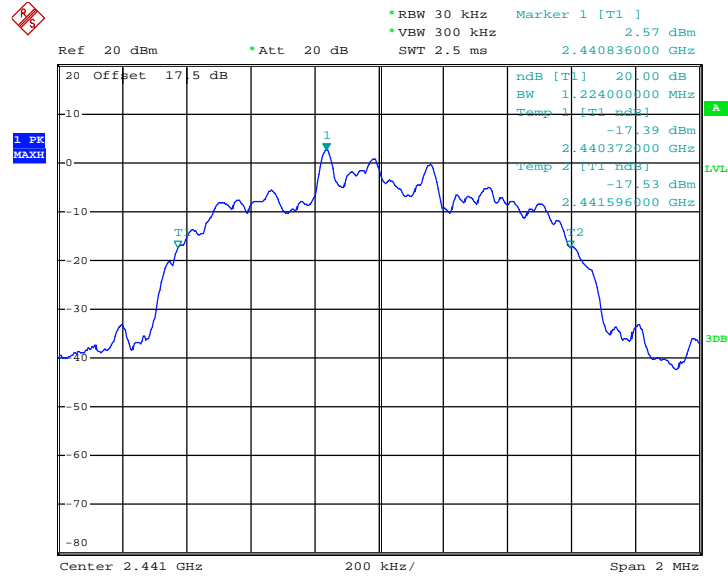

Date: 15.MAY.2013 15:37:11

20 dB Bandwidth Plot on Channel 78

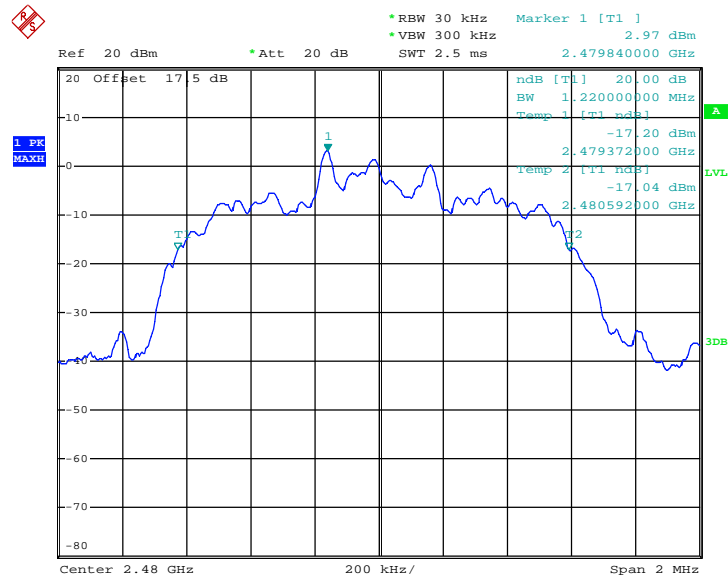

Date: 15.MAY.2013 15:40:00



Test Mode :	3Mbps	Temperature :	24~26°C
Test Engineer :	Blithe Li	Relative Humidity :	50~53%

Channel	Frequency (MHz)	20dB Bandwidth (MHz)
00	2402	1.232
39	2441	1.228
78	2480	1.228

20 dB Bandwidth Plot on Channel 00

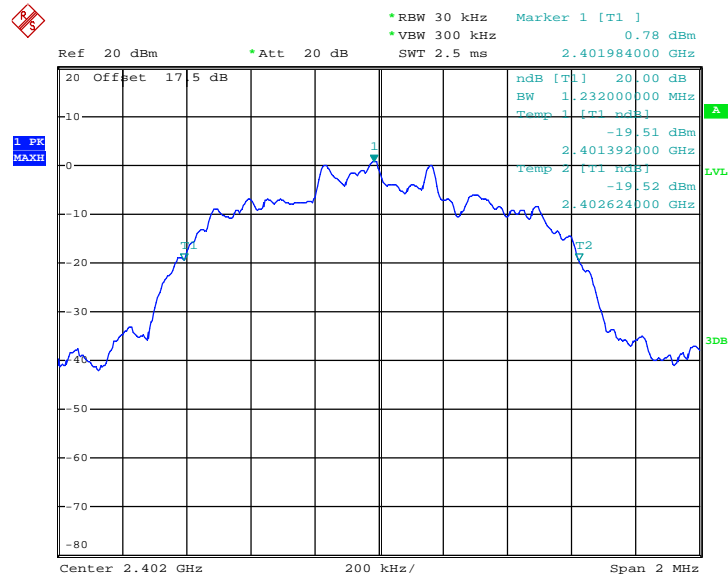

Date: 15.MAY.2013 15:32:29



20 dB Bandwidth Plot on Channel 39

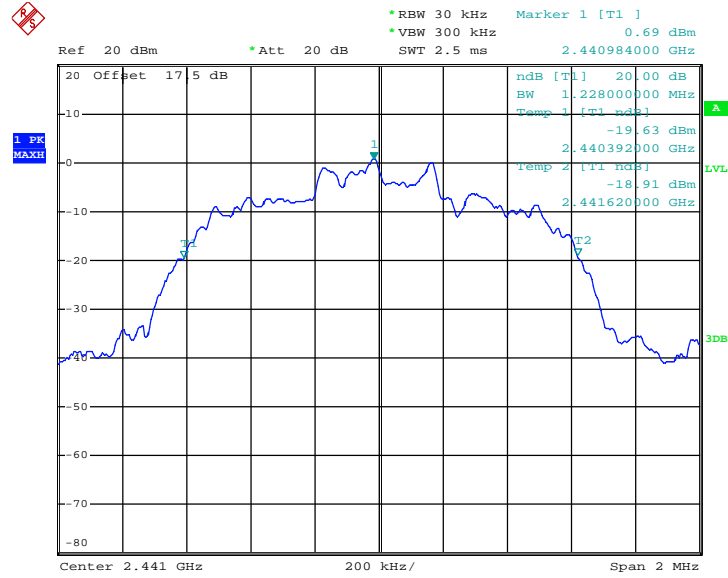

Date: 15.MAY.2013 15:37:33

20 dB Bandwidth Plot on Channel 78

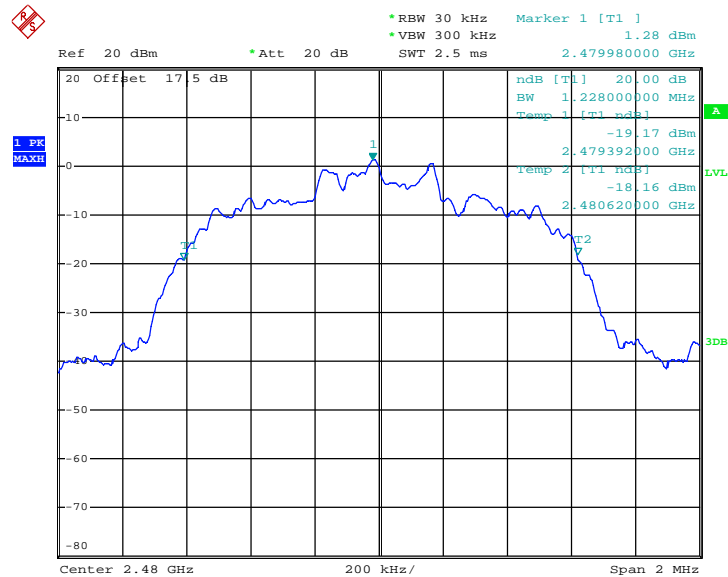

Date: 15.MAY.2013 15:40:23

3.5 Peak Output Power Measurement

3.5.1 Limit of Peak Output Power

Section 15.247 (b) The maximum peak conducted output power of the intentional radiator shall not exceed the following: (1) For frequency hopping systems operating in the 2400-2483.5 MHz band employing at least 75 non-overlapping hopping channels, and all frequency hopping systems in the 5725-5850 MHz band: 1 watt. For all other frequency hopping systems in the 2400-2483.5 MHz band 0.125 watts. The power limit for 1Mbps is 1watt, and for 2Mbps, and 3Mbps are 0.125 watts.

3.5.2 Measuring Instruments

See list of measuring instruments of this test report.

3.5.3 Test Procedures

1. The testing follows FCC Public Notice DA 00-705 Measurement Guidelines.
2. The RF output of EUT was connected to the spectrum analyzer by RF cable and attenuator. The path loss was compensated to the results for each measurement.
3. Set to the maximum power setting and enable the EUT transmit continuously.
4. Measure the conducted output power with cable loss and record the results in the test report.
5. Measure and record the results in the test report.

3.5.4 Test Setup

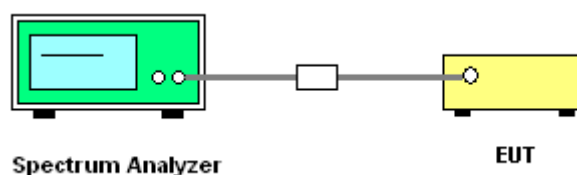



3.5.5 Test Result of Peak Output Power

Test Mode :	3Mbps	Temperature :	24~26°C
Test Engineer :	Blithe Li	Relative Humidity :	50~53%

Channel	Frequency (MHz)	RF Power (dBm)		
		8-DPSK	Max. Limits (dBm)	Pass/Fail
		3 Mbps		
00	2402	3.91	20.97	Pass
39	2441	4.84	20.97	Pass
78	2480	4.01	20.97	Pass

Peak Output Power Plot on Channel 00

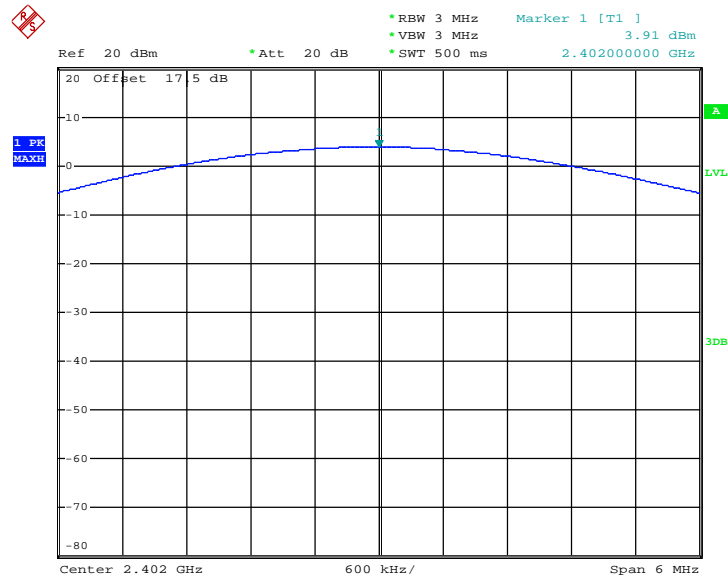

Date: 11.MAY.2013 10:29:07



Peak Output Power Plot on Channel 39

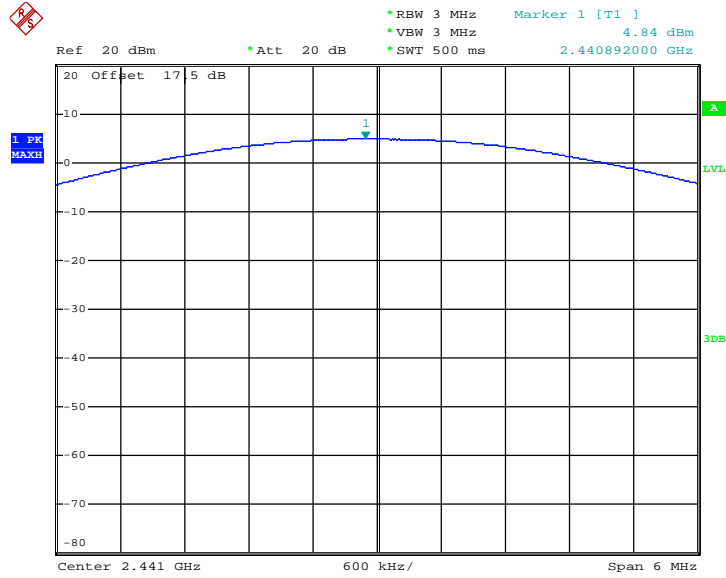

Date: 11.MAY.2013 10:18:18

Peak Output Power Plot on Channel 78

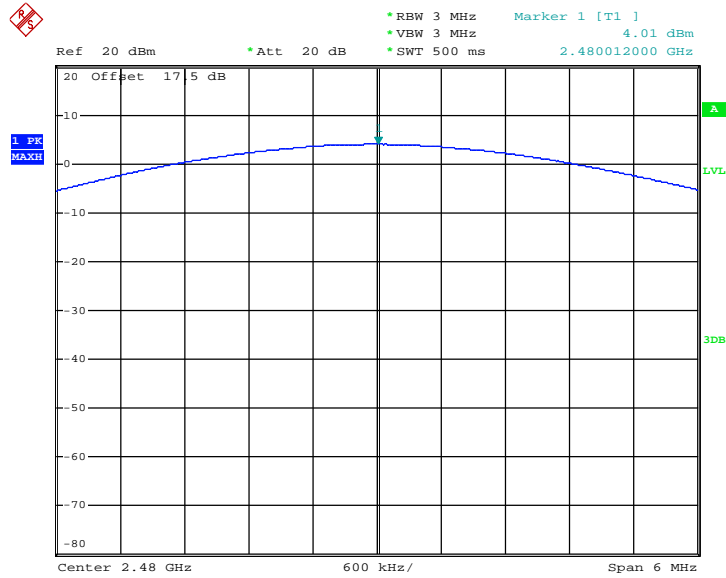

Date: 11.MAY.2013 10:43:07

3.6 Conducted Band Edges Measurement

3.6.1 Limit of Band Edges

In any 100 KHz bandwidth outside the intentional radiation frequency band, the radio frequency power shall be at least 20 dB below the highest level of the radiated power. In addition, radiated emissions which fall in the restricted bands must also comply with the radiated emission limits.

3.6.2 Measuring Instruments

See list of measuring instruments of this test report.

3.6.3 Test Procedures

1. The testing follows the guidelines in Band-edge Compliance of RF Conducted Emissions of FCC Public Notice DA 00-705 Measurement Guidelines.
2. Set to the maximum power setting and enable the EUT transmit continuously.
3. Set RBW = 300KHz ($\geq 1\%$ span=30MHz), VBW = 300KHz (\geq RBW). Band edge emissions must be at least 20 dB down from the highest emission level within the authorized band as measured with a 300KHz RBW. The attenuation shall be 30 dB instead of 20 dB when RMS conducted output power procedure is used.
4. Enable hopping function of the EUT and then repeat step 2. and 3.
5. Measure and record the results in the test report.

3.6.4 Test Setup

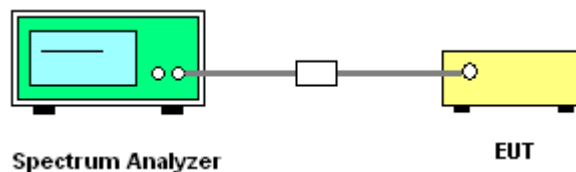

3.6.6 Test Result of Conducted Band Edges

Test Mode :	1Mbps	Temperature :	24~26°C
Test Channel :	00 and 78	Relative Humidity :	50~53%
		Test Engineer :	Blithe Li

Low Band Edge Plot on Channel 00

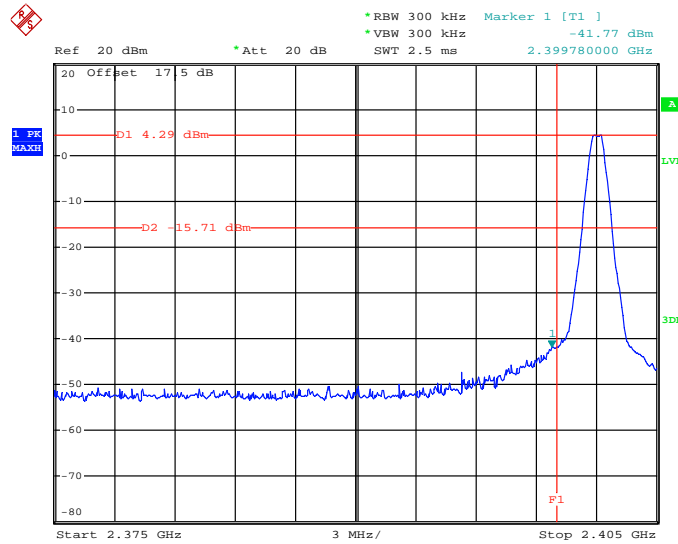

Date: 15.MAY.2013 16:02:28

High Band Edge Plot on Channel 78

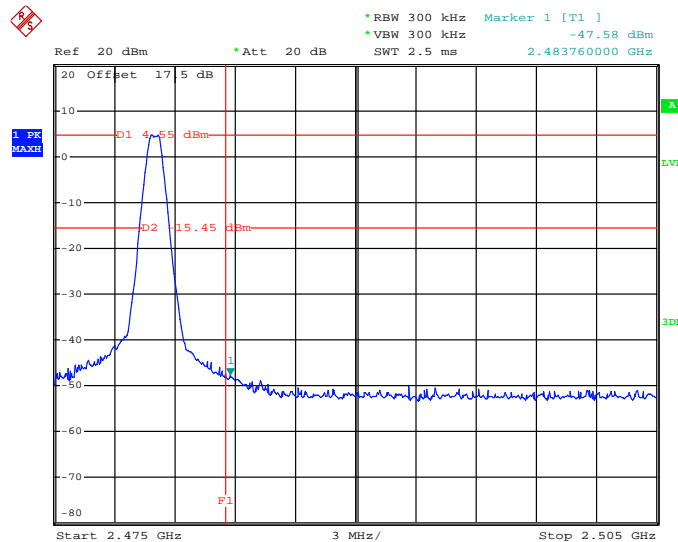

Date: 15.MAY.2013 16:01:39



Test Mode :	2Mbps	Temperature :	24~26°C
Test Channel :	00 and 78	Relative Humidity :	50~53%
		Test Engineer :	Blithe Li

Low Band Edge Plot on Channel 00

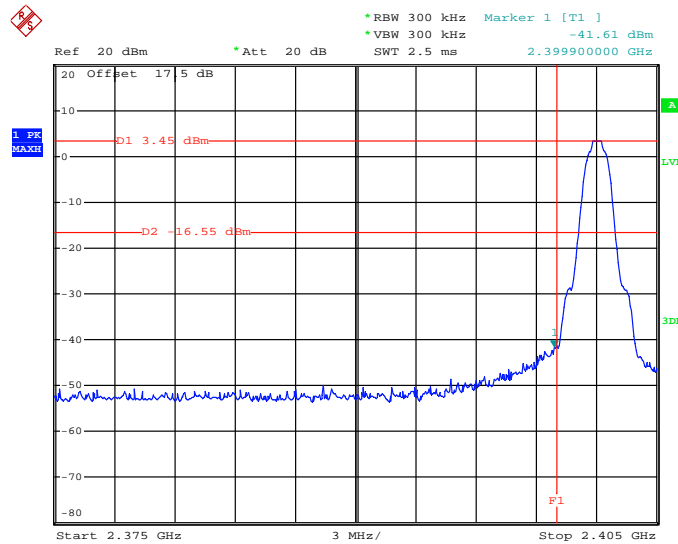

Date: 15.MAY.2013 16:04:49

High Band Edge Plot on Channel 78

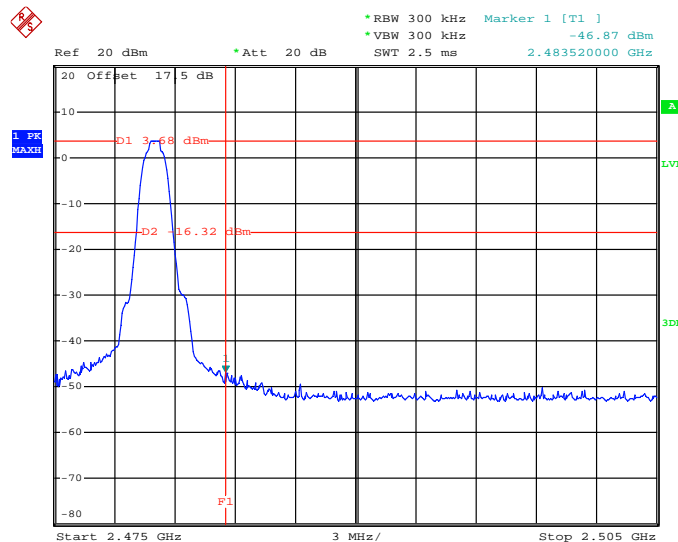

Date: 15.MAY.2013 16:04:08



Test Mode :	3Mbps	Temperature :	24~26°C
Test Channel :	00 and 78	Relative Humidity :	50~53%
		Test Engineer :	Blithe Li

Low Band Edge Plot on Channel 00

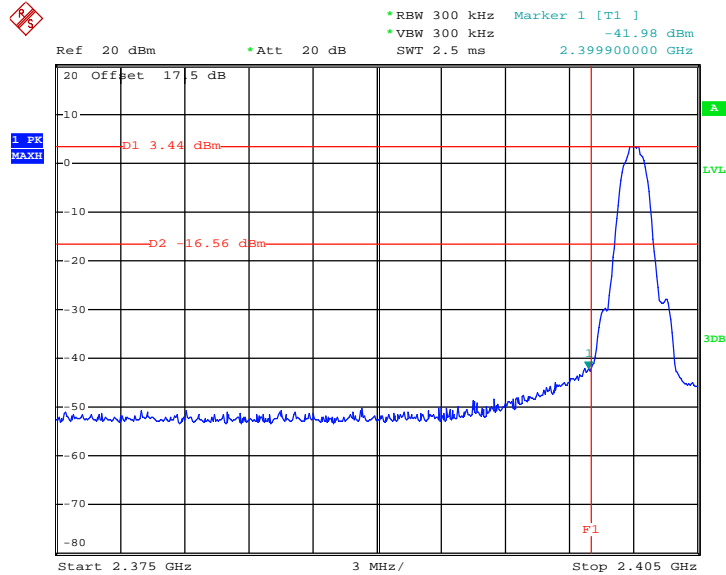

Date: 15.MAY.2013 16:07:07

High Band Edge Plot on Channel 78

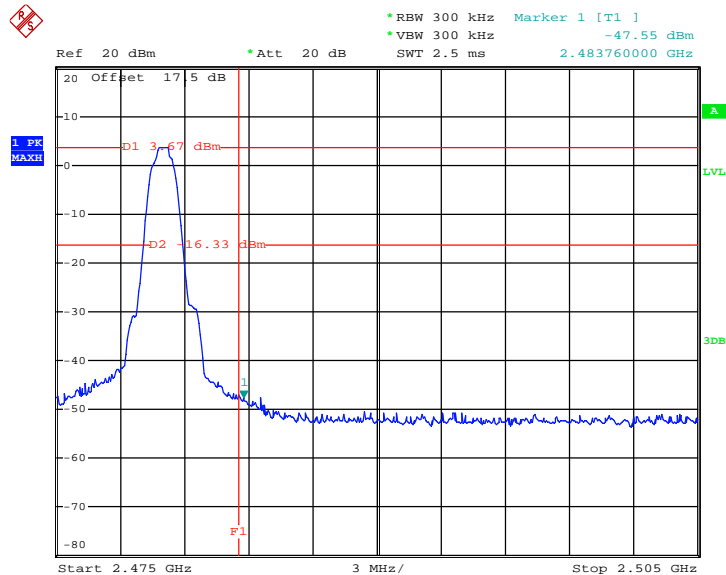

Date: 15.MAY.2013 16:06:14



3.6.7 Test Result of Conducted Hopping Mode Band Edges

Test Mode :	1Mbps	Temperature :	24~26°C
Test Engineer :	Blithe Li	Relative Humidity :	50~53%

Hopping Mode Low Band Edge Plot on Channel 00

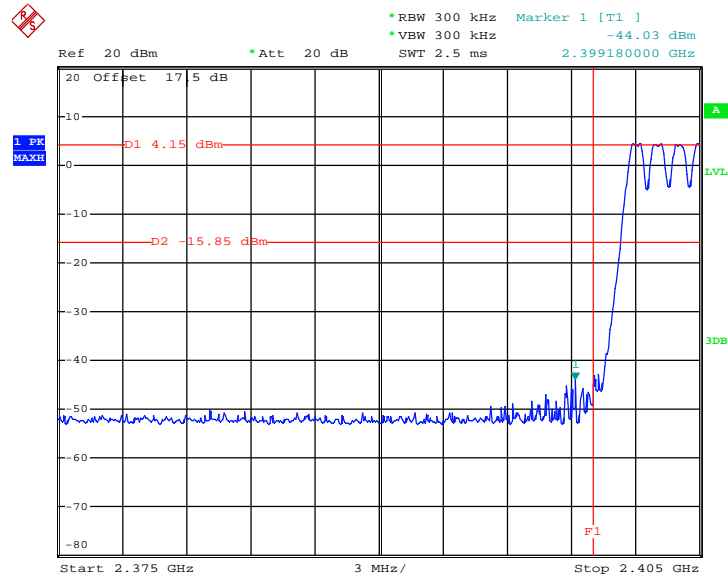

Date: 15.MAY.2013 16:10:33

Hopping Mode High Band Edge Plot on Channel 78

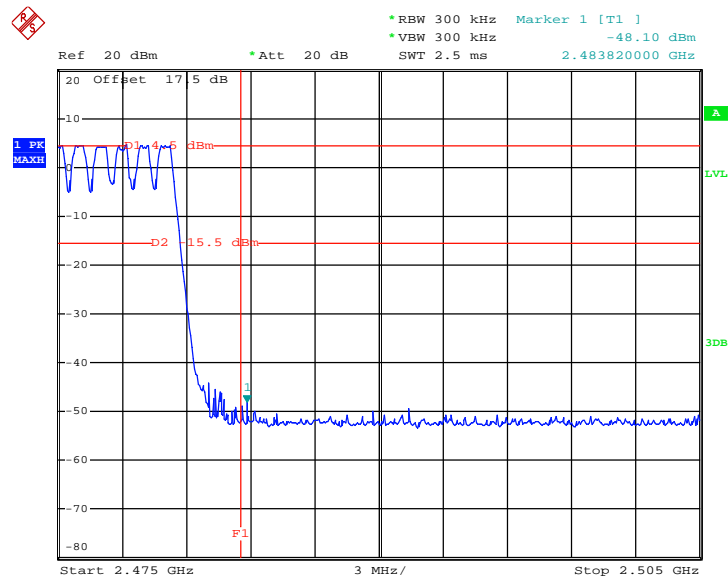

Date: 15.MAY.2013 16:09:26



Test Mode :	2Mbps	Temperature :	24~26°C
Test Engineer :	Blithe Li	Relative Humidity :	50~53%

Hopping Mode Low Band Edge Plot on Channel 00

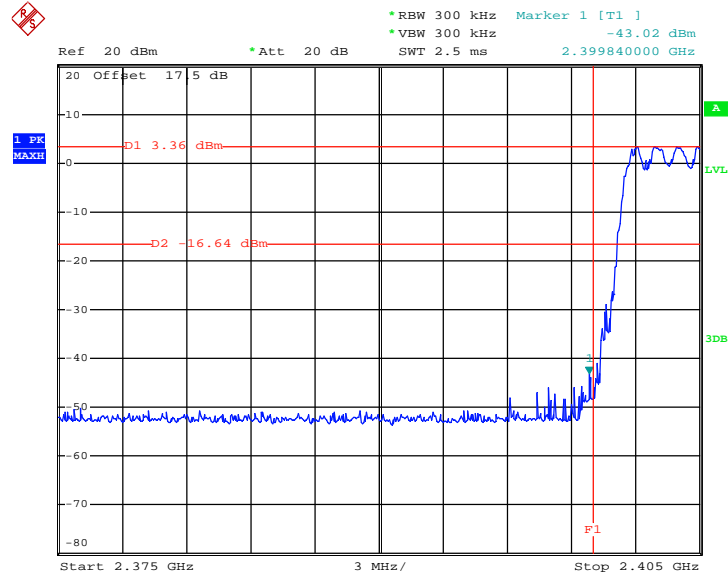

Date: 15.MAY.2013 16:12:49

Hopping Mode High Band Edge Plot on Channel 78

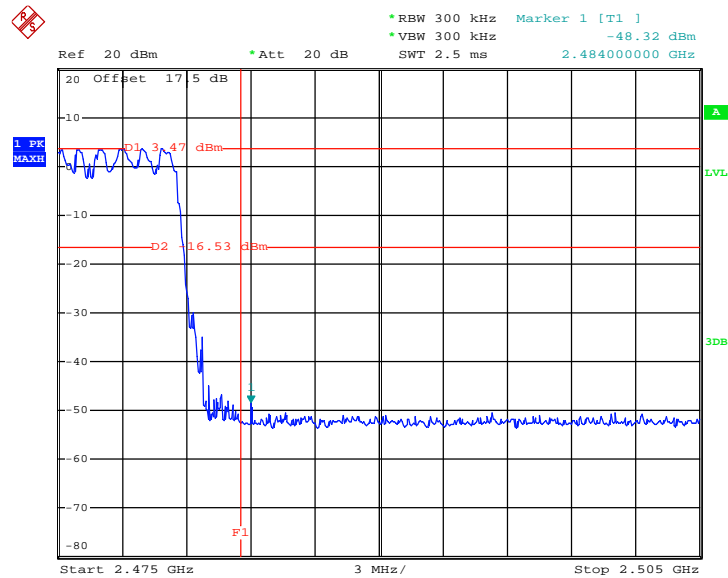

Date: 15.MAY.2013 16:11:59



Test Mode :	3Mbps	Temperature :	24~26°C
Test Engineer :	Blithe Li	Relative Humidity :	50~53%

Hopping Mode Low Band Edge Plot on Channel 00

720510

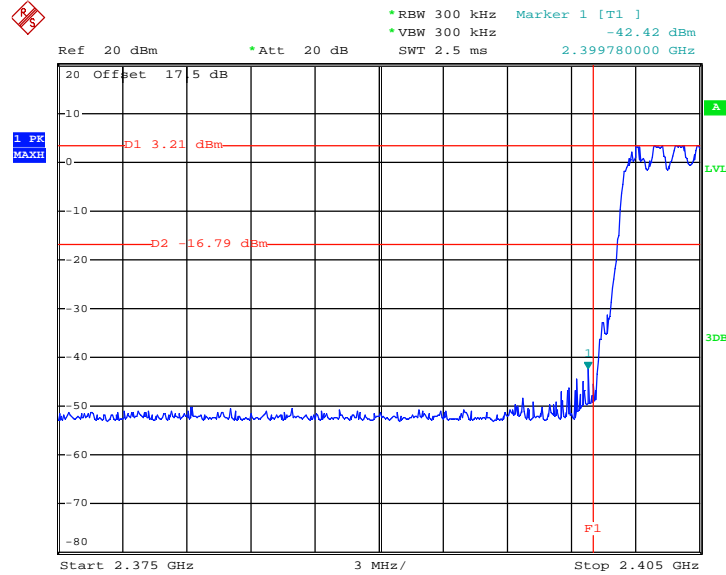

Date: 15.MAY.2013 16:15:21

Hopping Mode High Band Edge Plot on Channel 78

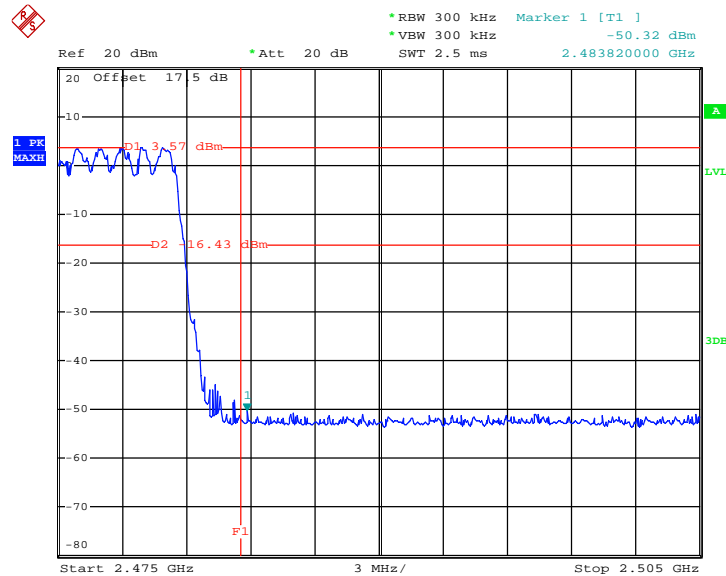

Date: 15.MAY.2013 16:14:11

3.7 Conducted Spurious Emission Measurement

3.7.1 Limit of Spurious Emission Measurement

In any 100 KHz bandwidth outside the intentional radiation frequency band, the radio frequency power shall be at least 20 dB below the highest level of the radiated power. In addition, radiated emissions which fall in the restricted bands must also comply with the radiated emission limits.

3.7.2 Measuring Instruments

See list of measuring instruments of this test report.

3.7.3 Test Procedure

1. The testing follows the guidelines in Spurious RF Conducted Emissions of FCC Public Notice DA 00-705 Measurement Guidelines
2. The RF output of EUT was connected to the spectrum analyzer by RF cable and attenuator. The path loss was compensated to the results for each measurement.
3. Set to the maximum power setting and enable the EUT transmit continuously.
4. Set RBW = 100 KHz, VBW = 300KHz, scan up through 10th harmonic. All harmonics / spurs must be at least 20 dB down from the highest emission level within the authorized band as measured with a 100 KHz RBW.
5. Measure and record the results in the test report.

3.7.4 Test Setup

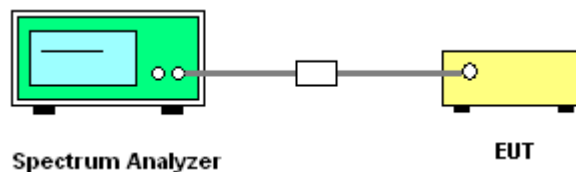



3.7.5 Test Results

Test Mode :	3Mbps	Temperature :	24~26°C
Test Channel :	00	Relative Humidity :	50~53%
		Test Engineer :	Blithe Li

Conducted Spurious Emission Plot between 30MHz ~ 3 GHz

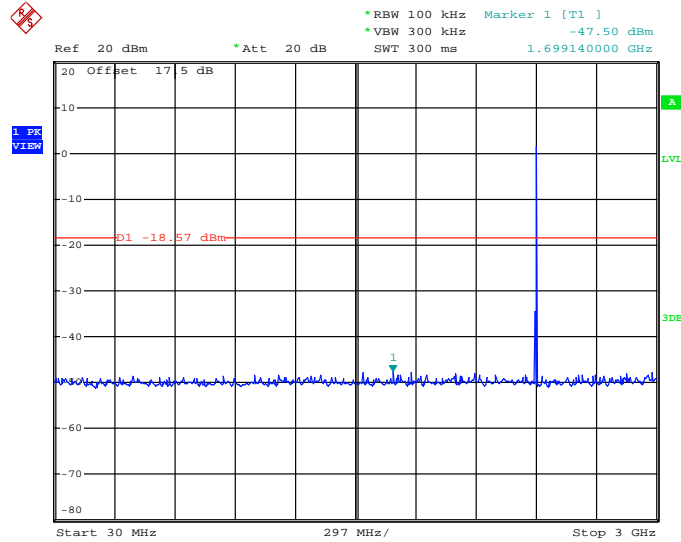

Date: 15.MAY.2013 16:34:14

Conducted Spurious Emission Plot between 2 GHz ~ 25 GHz

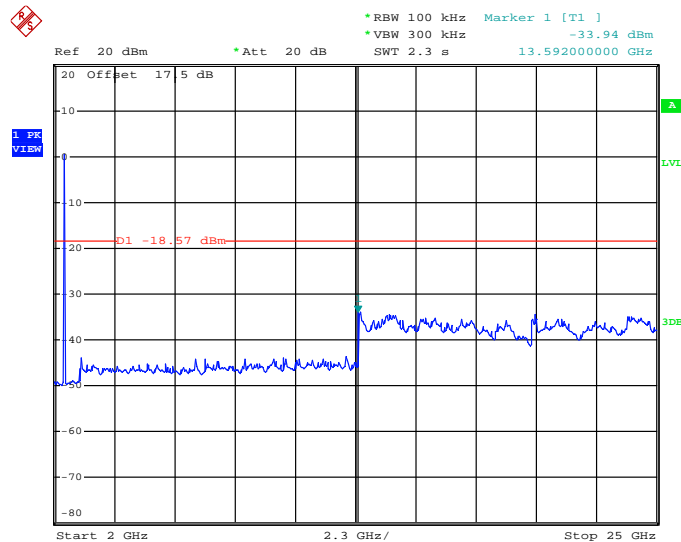

Date: 15.MAY.2013 16:34:51



Test Mode :	3Mbps	Temperature :	24~26°C
Test Channel :	39	Relative Humidity :	50~53%
		Test Engineer :	Blithe Li

Conducted Spurious Emission Plot between 30MHz ~ 3 GHz

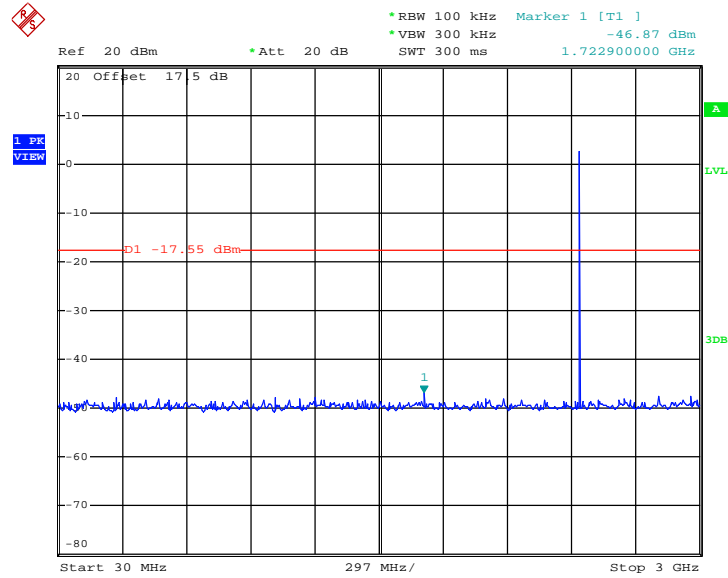

Date: 15.MAY.2013 16:35:54

Conducted Spurious Emission Plot between 2 GHz ~ 25 GHz

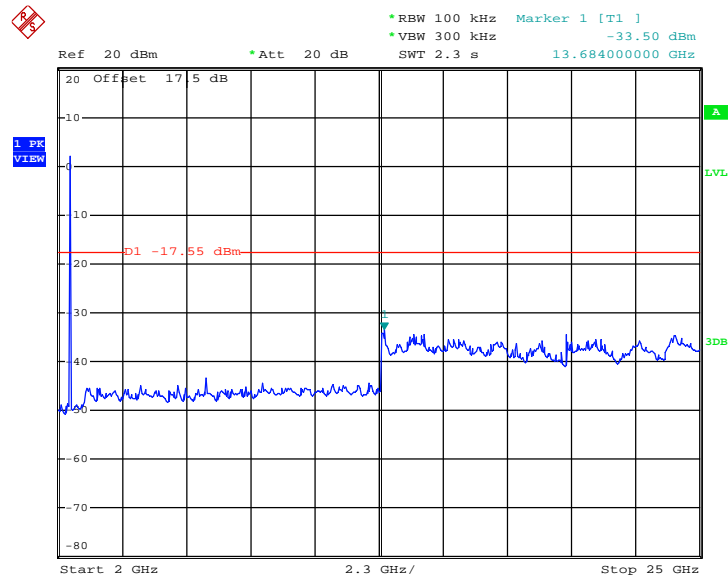

Date: 15.MAY.2013 16:36:22



Test Mode :	3Mbps	Temperature :	24~26°C
Test Channel :	78	Relative Humidity :	50~53%
		Test Engineer :	Blithe Li

Conducted Spurious Emission Plot between 30MHz ~ 3 GHz

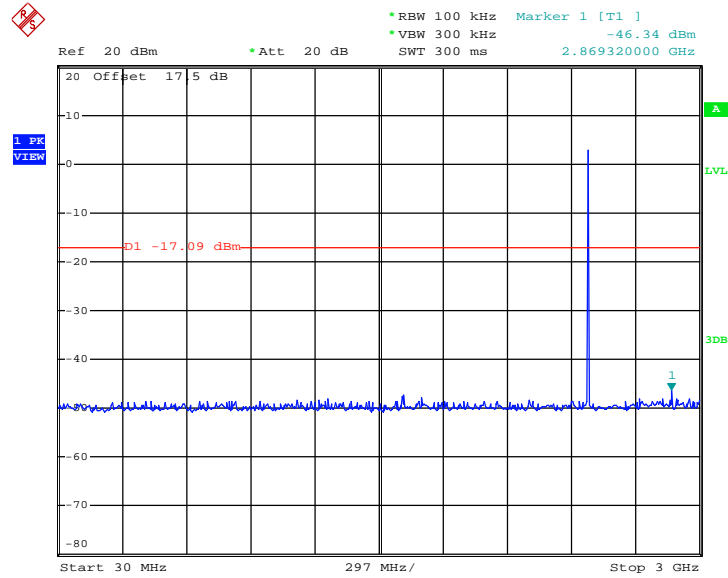

Date: 15.MAY.2013 16:37:13

Conducted Spurious Emission Plot between 2 GHz ~ 25 GHz

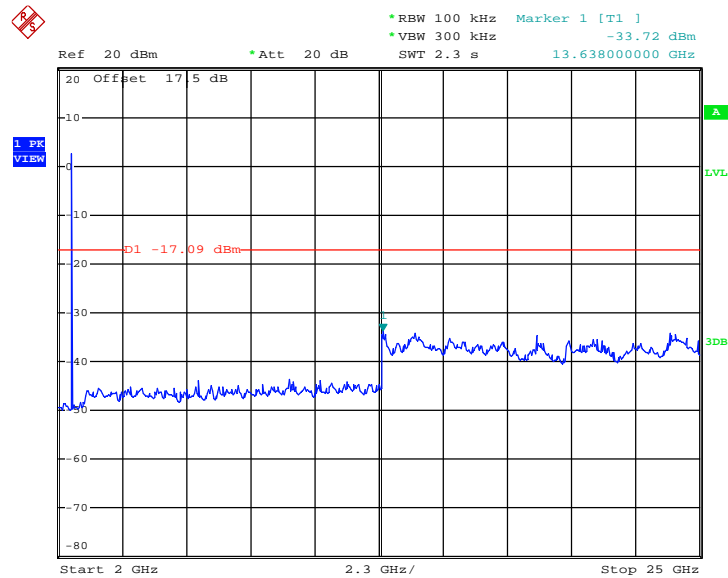

Date: 15.MAY.2013 16:38:03

3.8 Radiated Band Edges and Spurious Emission Measurement

3.8.1 Limit of Radiated Band Edges and Spurious Emission

In any 100 KHz bandwidth outside the intentional radiator frequency band, all harmonics/spurious must be at least 20 dB below the highest emission level within the authorized band. In addition, radiated emissions which fall in the restricted bands must also comply with the FCC section 15.209 limits as below.

Frequency (MHz)	Field Strength (microvolts/meter)	Measurement Distance (meters)
0.009 – 0.490	2400/F(KHz)	300
0.490 – 1.705	24000/F(KHz)	30
1.705 – 30.0	30	30
30 – 88	100	3
88 – 216	150	3
216 - 960	200	3
Above 960	500	3

3.8.2 Measuring Instruments

See list of measuring instruments of this test report.

3.8.3 Test Procedures

1. The testing follows the guidelines in Spurious Radiated Emissions of FCC Public Notice DA 00-705 Measurement Guidelines and fulfills ANSI C63.4-2003 and the guidelines in ANSI C63.10-2009 test site requirement.
2. The EUT was placed on a turntable with 0.8 meter above ground.
3. The EUT was set 3 meters from the interference receiving antenna, which was mounted on the top of a variable height antenna tower.
4. For each suspected emission, the EUT was arranged to its worst case and then tune the Antenna tower (from 1 m to 4 m) and turntable (from 0 degree to 360 degrees) to find the maximum reading. A pre-amp and a high pass filter are used for the test in order to get better signal level to comply with the guidelines.
5. Set to the maximum power setting and enable the EUT transmit continuously.
6. For measurement below 1GHz, If the emission level of the EUT measured by the peak detector is 3 dB lower than the applicable limit, the peak emission level will be reported. Otherwise, the emission measurement will be repeated using the quasi-peak detector and reported
7. Use the following spectrum analyzer settings:
 - (1) Span shall wide enough to fully capture the emission being measured;
 - (2) Set RBW=100 KHz for $f < 1$ GHz, RBW=1MHz for $f > 1$ GHz ; VBW \geq RBW; Sweep = auto; Detector function = peak; Trace = max hold for peak
 - (3) For average measurement: use duty cycle correction factor method per 15.35(c).
Duty cycle = On time/100 milliseconds
On time = $N_1 * L_1 + N_2 * L_2 + \dots + N_{n-1} * L_{n-1} + N_n * L_n$
Where N_1 is number of type 1 pulses, L_1 is length of type 1 pulses, etc.
Average Level = Peak Level + $20 * \log(\text{Duty cycle})$
8. Corrected Reading: Antenna Factor + Cable Loss + Read Level - Preamp Factor = Level

Note: The average levels were calculated from the peak level corrected with duty cycle correction factor (24.73dB) derived from $20 \log(\text{dwell time}/100\text{ms})$.

3.8.4 Test Setup

For radiated emissions below 30MHz

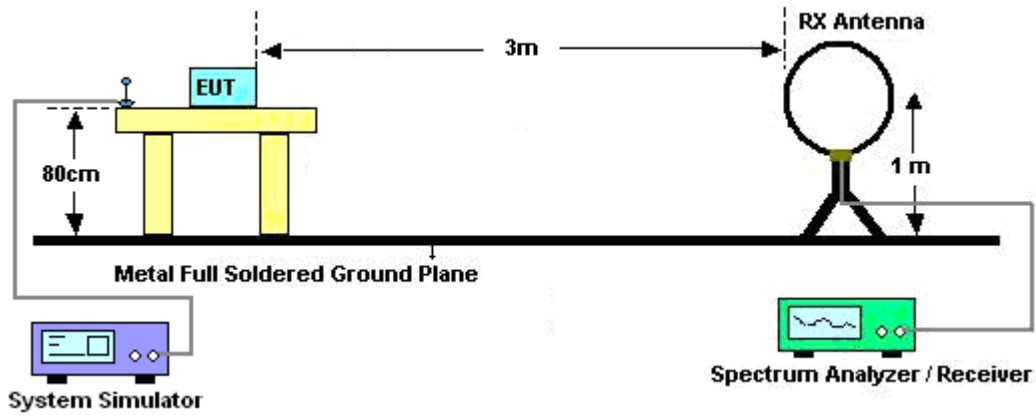

For radiated emissions from 30MHz to 1GHz

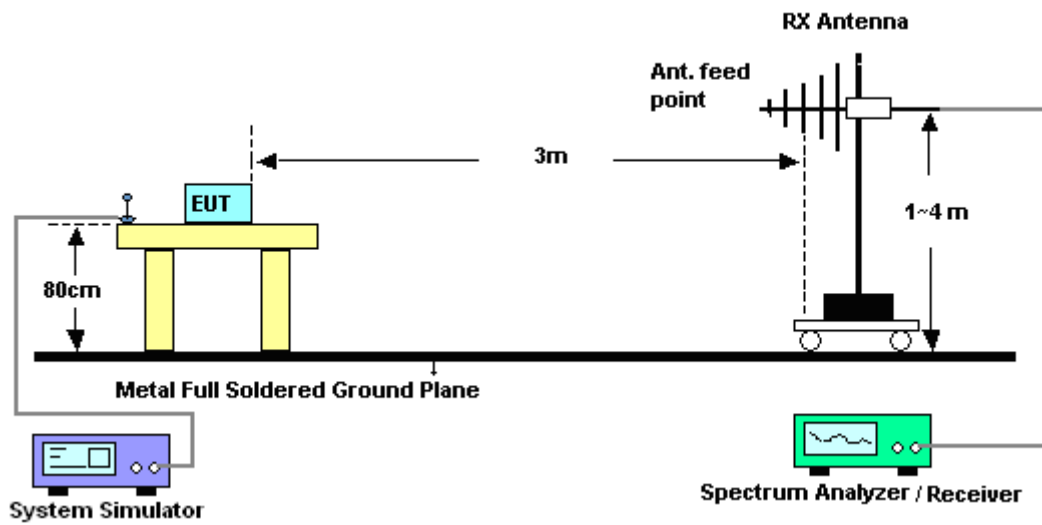

For radiated emissions above 1GHz

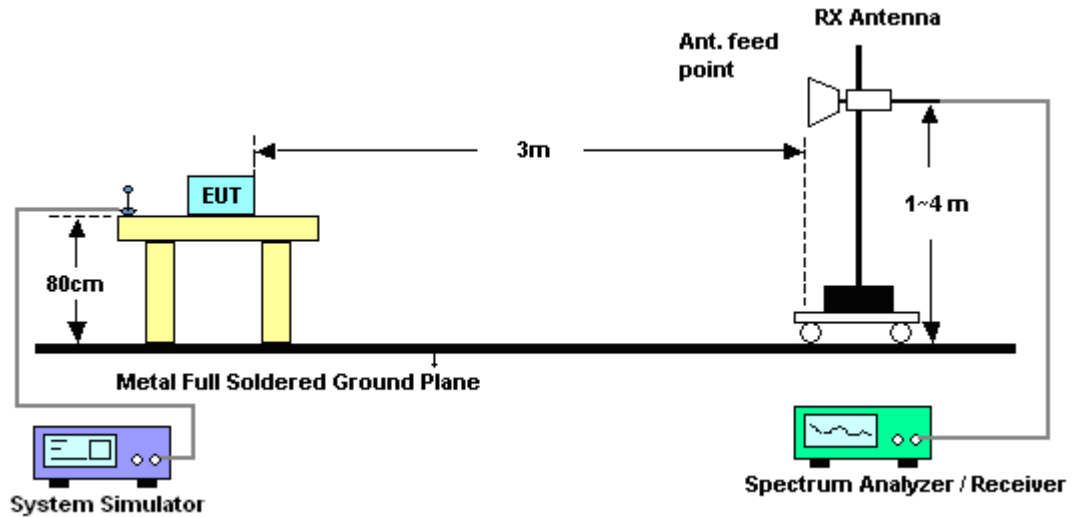

3.8.5 Test Results of Radiated Spurious Emission (9 KHz ~ 30 MHz)

The low frequency, which started from 9 KHz to 30MHz, was pre-scanned and the result which was 20dB lower than the limit line per 15.31(o) was not reported.

3.8.6 Duty cycle correction factor for average measurement

3DH5 on time/100ms (One Pulse) Plot on Channel 39

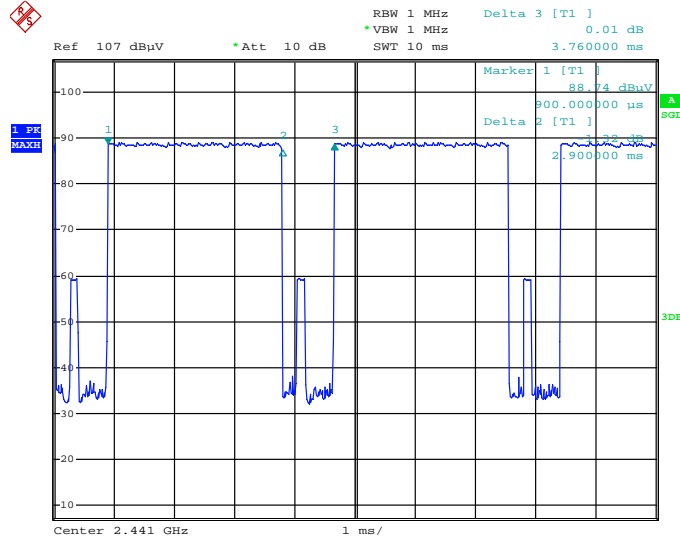

Date: 7.MAY.2013 00:48:37

3DH5 on time/100ms (Count Pulses) Plot on Channel 39

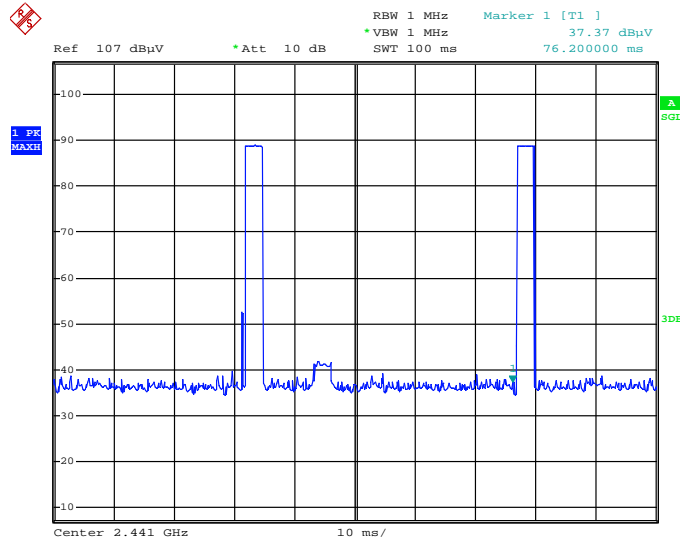

Date: 7.MAY.2013 00:58:07

Note:

1. Duty cycle = on time/100 milliseconds = $2 * 2.9 / 100 = 5.80 \%$
2. Duty cycle correction factor = $20 * \log(\text{Duty cycle}) = -24.73 \text{ dB}$
3. 3DH5 has the highest duty cycle and is reported.



3.8.7 Test Result of Radiated Band Edges

Test Mode :	3Mbps	Temperature :	24~25°C
Test Channel :	00	Relative Humidity :	49~51%
		Test Engineer :	Robin Luo

ANTENNA POLARITY : HORIZONTAL										
Frequency (MHz)	Level (dBμV/m)	Over Limit (dB)	Limit Line (dBμV/m)	Read Level (dBμV)	Antenna Factor (dB)	Cable Loss (dB)	Preamp Factor (dB)	Ant Pos (cm)	Table Pos (deg)	Remark
2318.82	51	-23	74	45.52	32.05	4.34	30.91	100	84	Peak
2318.82	26.27	-27.73	54	-	-	-	-	-	-	Average

ANTENNA POLARITY : VERTICAL										
Frequency (MHz)	Level (dBμV/m)	Over Limit (dB)	Limit Line (dBμV/m)	Read Level (dBμV)	Antenna Factor (dB)	Cable Loss (dB)	Preamp Factor (dB)	Ant Pos (cm)	Table Pos (deg)	Remark
2348.25	51.88	-22.12	74	46.31	32.07	4.38	30.88	100	310	Peak
2348.25	27.15	-26.85	54	-	-	-	-	-	-	Average

Note: The average levels were calculated from the peak level corrected with duty cycle correction factor (24.73dB) derived from 20log (dwell time/100ms).

For example: Average level = 51dBuV/m – 24.73 (dB) = 26.27dBuV/m.

Test Mode :	3Mbps	Temperature :	24~25°C
Test Channel :	78	Relative Humidity :	49~51%
		Test Engineer :	Robin Luo

ANTENNA POLARITY : HORIZONTAL										
Frequency (MHz)	Level (dBμV/m)	Over Limit (dB)	Limit Line (dBμV/m)	Read Level (dBμV)	Antenna Factor (dB)	Cable Loss (dB)	Preamp Factor (dB)	Ant Pos (cm)	Table Pos (deg)	Remark
2483.5	62.9	-11.1	74	56.94	32.27	4.47	30.78	107	359	Peak
2483.5	38.17	-15.83	54	-	-	-	-	-	-	Average

ANTENNA POLARITY : VERTICAL										
Frequency (MHz)	Level (dBμV/m)	Over Limit (dB)	Limit Line (dBμV/m)	Read Level (dBμV)	Antenna Factor (dB)	Cable Loss (dB)	Preamp Factor (dB)	Ant Pos (cm)	Table Pos (deg)	Remark
2483.5	62.6	-11.4	74	56.64	32.27	4.47	30.78	116	344	Peak
2483.5	37.87	-16.13	54	-	-	-	-	-	-	Average

3.8.8 Test Result of Radiated Spurious Emission (30 MHz ~ 10th Harmonic)

Note: Below 1GHz for radiated emission measurement, pre-scanned all test modes and only choose the worst case mode was recorded in the report.

Test Mode :	3Mbps	Temperature :	24~25°C
Test Channel :	00	Relative Humidity :	49~51%
Test Engineer :	Robin Luo	Polarization :	Horizontal
Remark :	1. 2402 MHz is fundamental signal which can be ignored. 2. 2399MHz and 7206MHz are not within a restricted band, and their limit line is 20dB below the highest emission level. For example, 95.93dBuV/m - 20dB = 75.93dBuV/m.		

Frequency (MHz)	Level (dBμV/m)	Over Limit (dB)	Limit Line (dBμV/m)	Read Level (dBμV)	Antenna Factor (dB)	Cable Loss (dB)	Preamp Factor (dB)	Ant Pos (cm)	Table Pos (deg)	Remark
2399	57.1	-18.83	75.93	51.39	32.14	4.42	30.85	100	84	Peak
2402	95.93	-	-	90.2	32.14	4.44	30.85	100	84	Peak
2402	71.2	-	-	-	-	-	-	189	0	Average
4804	45.78	-28.22	74	34.32	33.63	5.95	28.12	100	236	Peak
4804	21.05	-32.95	54	-	-	-	-	100	0	Average
7206	55.38	-20.55	75.93	40.83	35.27	7.47	28.19	100	256	Peak

Note: Other harmonics are lower than background noise.



Test Mode :	3Mbps	Temperature :	24~25°C
Test Channel :	00	Relative Humidity :	49~51%
Test Engineer :	Robin Luo	Polarization :	Vertical
Remark :	1. 2402 MHz is fundamental signal which can be ignored. 2. 2399MHz and 7206MHz are not within a restricted band, and their limit line is 20dB below the highest emission level.		

Frequency (MHz)	Level (dBμV/m)	Over Limit (dB)	Limit Line (dBμV/m)	Read Level (dBμV)	Antenna Factor (dB)	Cable Loss (dB)	Preamp Factor (dB)	Ant Pos (cm)	Table Pos (deg)	Remark
2399	57.97	-16.71	74.68	52.26	32.14	4.42	30.85	100	310	Peak
2402	94.68	-	-	88.95	32.14	4.44	30.85	100	310	Peak
2402	69.95	-	-	-	-	-	-	115	235	Average
4804	45.26	-28.74	74	33.8	33.63	5.95	28.12	100	321	Peak
4824	20.53	-33.47	54	-	-	-	-	100	0	Average
7206	54.71	-19.97	74.68	40.16	35.27	7.47	28.19	120	251	Peak

Note: Other harmonics are lower than background noise.



Test Mode :	3Mbps	Temperature :	24~25°C
Test Channel :	39	Relative Humidity :	49~51%
Test Engineer :	Robin Luo	Polarization :	Horizontal
Remark :	1. 2441 MHz is fundamental signal which can be ignored. 2. Average measurement was not performed if peak level went lower than the average limit.		

Frequency (MHz)	Level (dBμV/m)	Over Limit (dB)	Limit Line (dBμV/m)	Read Level (dBμV)	Antenna Factor (dB)	Cable Loss (dB)	Preamp Factor (dB)	Ant Pos (cm)	Table Pos (deg)	Remark
2441	98.8	-	-	92.94	32.22	4.45	30.81	100	201	Peak
2441	74.07	-	-	-	-	-	-	100	201	Average
4882	45.95	-28.05	74	33.93	33.8	6.02	27.8	120	56	Peak
7323	52.71	-21.29	74	37.5	35.32	7.9	28.01	100	247	Peak
7323	27.98	-26.02	54	-	-	-	-	100	247	Average

Note: Other harmonics are lower than background noise.



Test Mode :	3Mbps	Temperature :	24~25°C
Test Channel :	39	Relative Humidity :	49~51%
Test Engineer :	Robin Luo	Polarization :	Vertical
Remark :	1. 2441 MHz is fundamental signal which can be ignored. 2. Average measurement was not performed if peak level went lower than the average limit.		

Frequency (MHz)	Level (dBμV/m)	Over Limit (dB)	Limit Line (dBμV/m)	Read Level (dBμV)	Antenna Factor (dB)	Cable Loss (dB)	Preamp Factor (dB)	Ant Pos (cm)	Table Pos (deg)	Remark
2441	95.33	-	-	89.47	32.22	4.45	30.81	100	250	Peak
2441	70.6	-	-	-	-	-	-	100	250	Average
4882	46.56	-27.44	74	34.54	33.8	6.02	27.8	100	256	Peak
7323	54.6	-19.4	74	39.39	35.32	7.9	28.01	100	23	Peak
7323	29.87	-24.13	54	-	-	-	-	100	23	Average

Note: Other harmonics are lower than background noise.



Test Mode :	3Mbps	Temperature :	24~25°C
Test Channel :	78	Relative Humidity :	49~51%
Test Engineer :	Robin Luo	Polarization :	Horizontal
Remark :	1. 2480 MHz is fundamental signal which can be ignored. 2. Average measurement was not performed if peak level went lower than the average limit.		

Frequency (MHz)	Level (dBμV/m)	Over Limit (dB)	Limit Line (dBμV/m)	Read Level (dBμV)	Antenna Factor (dB)	Cable Loss (dB)	Preamp Factor (dB)	Ant Pos (cm)	Table Pos (deg)	Remark
43.81	17.25	-22.75	40	40.16	6.74	0.87	30.52	100	320	Peak
294.11	10.66	-35.34	46	43.54	-4.55	1.69	30.02	-	-	Peak
325.60	14.71	-31.29	46	46.15	-3.29	1.76	29.91	-	-	Peak
350.48	16.78	-29.22	46	46.35	-1.57	1.83	29.83	-	-	Peak
462.35	13.18	-32.82	46	41.91	-1.29	2.02	29.46	-	-	Peak
878.32	16.43	-29.57	46	38.34	4.21	2.71	28.83	-	-	Peak
2480	100.92	-	-	94.96	32.27	4.47	30.78	107	359	Peak
2480	76.19	-	-	-	-	-	-	107	359	Average
4960	46.51	-27.49	74	33.86	34.01	6.13	27.49	100	230	Peak
7440	55.26	-18.74	74	39.68	35.37	8.08	27.87	100	253	Peak
7440	30.53	-23.47	54	-	-	-	-	100	253	Average

Note: Other harmonics are lower than background noise.



Test Mode :	3Mbps	Temperature :	24~25°C
Test Channel :	78	Relative Humidity :	49~51%
Test Engineer :	Robin Luo	Polarization :	Vertical
Remark :	1. 2480 MHz is fundamental signal which can be ignored. 2. Average measurement was not performed if peak level went lower than the average limit.		

Frequency (MHz)	Level (dBμV/m)	Over Limit (dB)	Limit Line (dBμV/m)	Read Level (dBμV)	Antenna Factor (dB)	Cable Loss (dB)	Preamp Factor (dB)	Ant Pos (cm)	Table Pos (deg)	Remark
43.20	24.11	-15.89	40	47.15	6.63	0.87	30.54	200	258	Peak
104.17	9.27	-34.23	43.5	43.72	-4.97	1.17	30.65	-	-	Peak
181.28	7.79	-35.71	43.5	40.32	-3.42	1.29	30.4	-	-	Peak
326.74	13.84	-32.16	46	43.88	-1.9	1.77	29.91	-	-	Peak
541.37	19.23	-26.77	46	44.65	1.65	2.21	29.28	-	-	Peak
711.67	17.53	-28.47	46	40.55	3.57	2.46	29.05	-	-	Peak
2480	100.56	-	-	94.6	32.27	4.47	30.78	116	344	Peak
2480	75.83	-	-	-	-	-	-	116	344	Average
4960	47.47	-26.53	74	34.82	34.01	6.13	27.49	100	230	Peak
7440	54.87	-19.13	74	39.29	35.37	8.08	27.87	154	320	Peak
7440	30.14	-23.86	54	-	-	-	-	154	320	Average

Note: Other harmonics are lower than background noise.

3.9 AC Conducted Emission Measurement

3.9.1 Limit of AC Conducted Emission

For equipment that is designed to be connected to the public utility (AC) power line, the radio frequency voltage that is conducted back onto the AC power line on any frequency or frequencies within the band 150 KHz to 30 MHz shall not exceed the limits in the following table.

Frequency of emission (MHz)	Conducted limit (dBuV)	
	Quasi-peak	Average
0.15-0.5	66 to 56*	56 to 46*
0.5-5	56	46
5-30	60	50

*Decreases with the logarithm of the frequency.

3.9.2 Measuring Instruments

See list of measuring instruments of this test report.

3.9.3 Test Procedures

1. The test follows the guidelines in ANSI C63.10-2009 test site requirement.
2. The EUT was placed 0.4 meter from the conducting wall of the shielding room was kept at least 80 centimeters from any other grounded conducting surface.
3. Connect EUT to the power mains through a line impedance stabilization network (LISN).
4. All the support units are connecting to the other LISN.
5. The LISN provides 50 ohm coupling impedance for the measuring instrument.
6. The FCC states that a 50 ohm, 50 microhenry LISN should be used.
7. Both sides of AC line were checked for maximum conducted interference.
8. The frequency range from 150 KHz to 30 MHz was searched.
9. Set the test-receiver system to Peak Detect Function and specified bandwidth with Maximum Hold Mode.

3.9.4 Test Setup

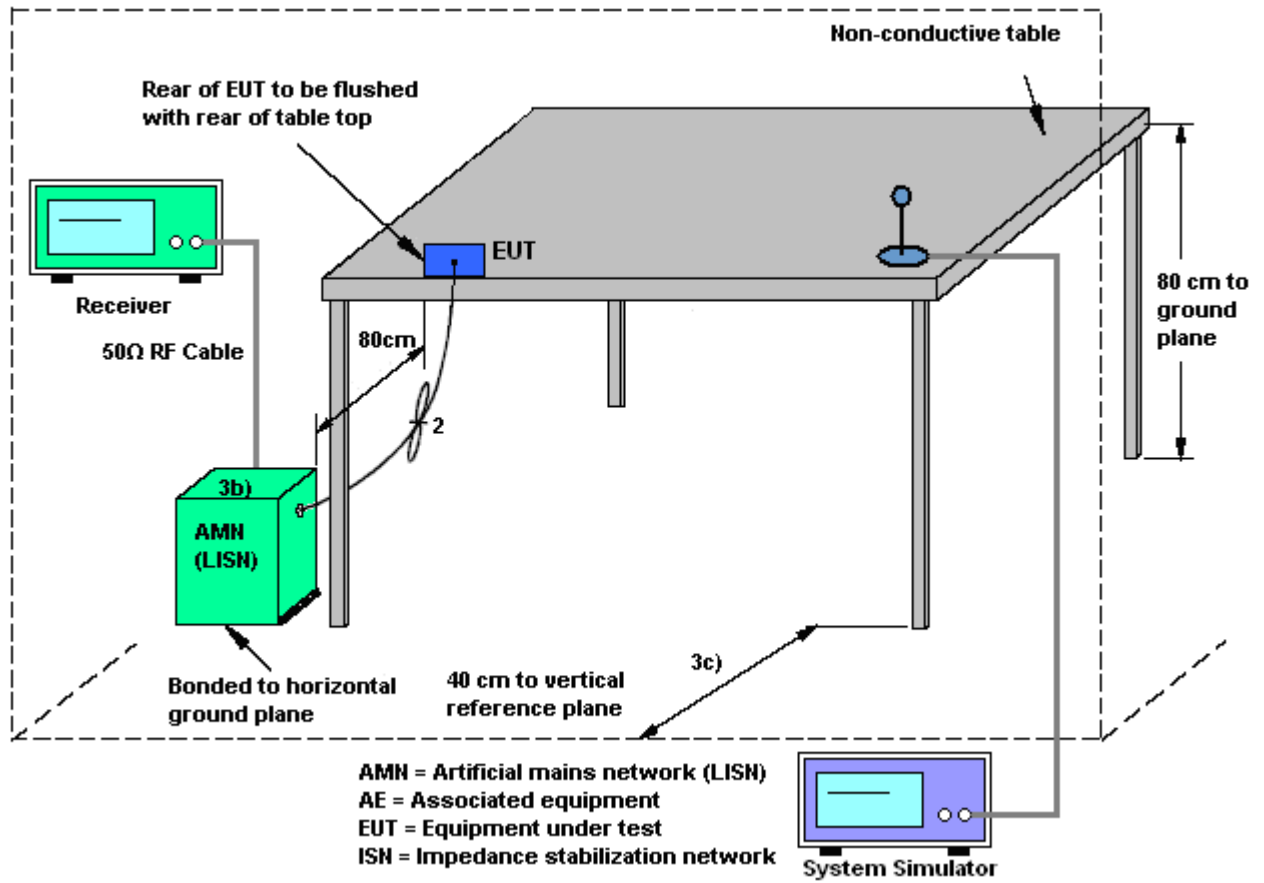

3.9.5 Test Result of AC Conducted Emission

Test Mode :	Mode 1	Temperature :	23~24°C
Test Engineer :	Leo Liao	Relative Humidity :	48~49%
Test Voltage :	120Vac / 60Hz	Phase :	Line
Function Type :	GSM850 Idle + Bluetooth Link + USB Cable (Charging from Adapter) + Earphone		
Remark :	All emissions not reported here are more than 10 dB below the prescribed limit.		

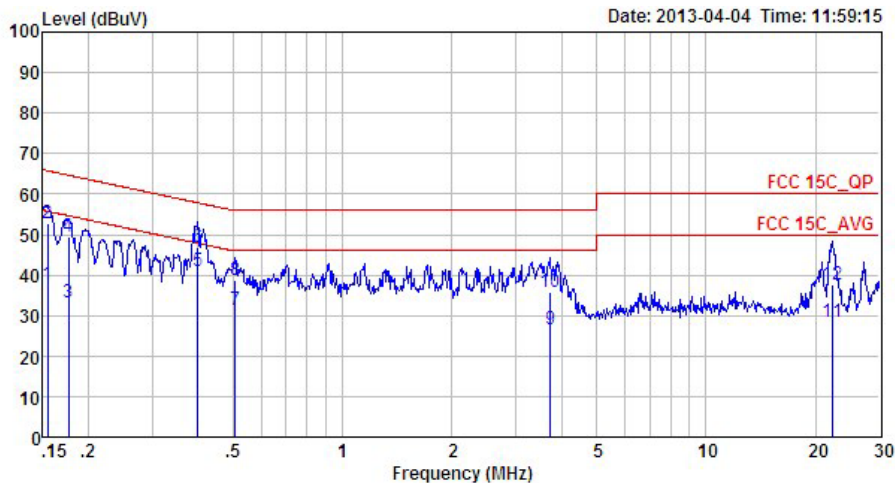

Site : CO01-SZ
 Condition: FCC 15C_QP LISN_L_2000601 LINE
 Project : (FR) 340101
 Mode : Mode 1

	Freq	Level	Over	Limit	Read	LISN	Cable	
	MHz	dBuV	Limit	Line	Level	Factor	Loss	Remark
			dB	dBuV	dBuV	dB	dB	
1	0.15	37.58	-18.16	55.74	27.50	0.03	10.05	Average
2	0.15	52.88	-12.86	65.74	42.80	0.03	10.05	QP
3	0.18	33.28	-21.36	54.64	23.20	0.03	10.05	Average
4	0.18	49.58	-15.06	64.64	39.50	0.03	10.05	QP
5 *	0.40	40.80	-7.06	47.86	30.71	0.02	10.07	Average
6	0.40	46.80	-11.06	57.86	36.71	0.02	10.07	QP
7	0.51	31.51	-14.49	46.00	21.40	0.02	10.09	Average
8	0.51	38.61	-17.39	56.00	28.50	0.02	10.09	QP
9	3.74	26.74	-19.26	46.00	16.50	0.05	10.19	Average
10	3.74	35.64	-20.36	56.00	25.40	0.05	10.19	QP
11	22.30	28.49	-21.51	50.00	17.61	0.42	10.46	Average
12	22.30	37.49	-22.51	60.00	26.61	0.42	10.46	QP



Test Mode :	Mode 1	Temperature :	23~24°C
Test Engineer :	Leo Liao	Relative Humidity :	48~49%
Test Voltage :	120Vac / 60Hz	Phase :	Neutral
Function Type :	GSM850 Idle + Bluetooth Link + USB Cable (Charging from Adapter) + Earphone		
Remark :	All emissions not reported here are more than 10 dB below the prescribed limit.		

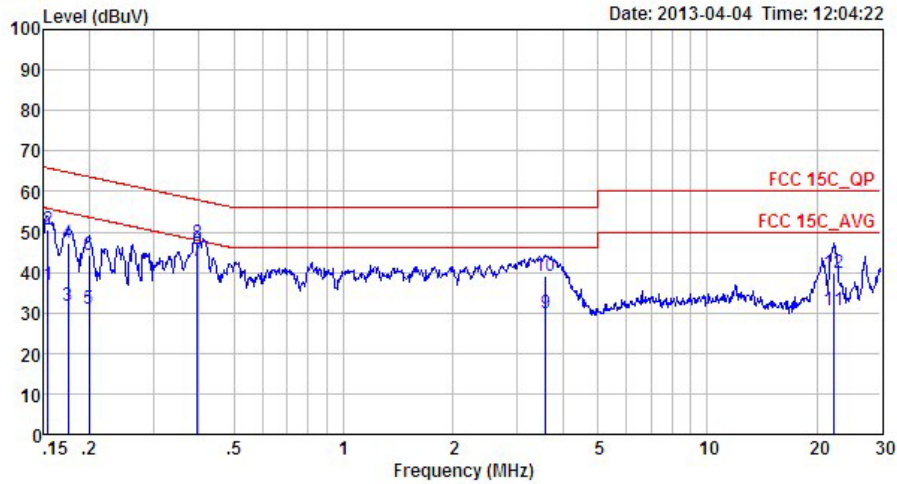

Site : CO01-SZ
 Condition: FCC 15C_QP LISN_N_2000601 NEUTRAL
 Project : (FR) 340101
 Mode : Mode 1

	Freq	Level	Over	Limit	Read	LISN	Cable	Remark
	MHz	dBuV	Limit	Line	Level	Factor	Loss	
			dB	dBuV	dBuV	dB	dB	
1	0.15	37.07	-18.71	55.78	27.00	0.02	10.05	Average
2	0.15	50.67	-15.11	65.78	40.60	0.02	10.05	QP
3	0.17	31.87	-22.85	54.72	21.80	0.02	10.05	Average
4	0.17	47.37	-17.35	64.72	37.30	0.02	10.05	QP
5	0.20	30.87	-22.75	53.62	20.79	0.02	10.06	Average
6	0.20	44.27	-19.35	63.62	34.19	0.02	10.06	QP
7 *	0.40	42.89	-5.06	47.95	32.80	0.02	10.07	Average
8	0.40	47.09	-10.86	57.95	37.00	0.02	10.07	QP
9	3.60	30.05	-15.95	46.00	19.80	0.06	10.19	Average
10	3.60	39.05	-16.95	56.00	28.80	0.06	10.19	QP
11	22.18	30.59	-19.41	50.00	19.50	0.62	10.47	Average
12	22.18	39.79	-20.21	60.00	28.70	0.62	10.47	QP

3.10 Antenna Requirements

3.10.1 Standard Applicable

If directional gain of transmitting antennas is greater than 6dBi, the power shall be reduced by the same level in dB comparing to gain minus 6dBi. The use of a permanently attached antenna or of an antenna that uses a unique coupling to the intentional radiator shall be considered sufficient to comply with the FCC rule.

3.10.2 Antenna Connected Construction

Non-standard connector used.

3.10.3 Antenna Gain

The antenna peak gain of EUT is less than 6 dBi. Therefore, it is not necessary to reduce maximum peak output power limit.

4 List of Measuring Equipment

Instrument	Manufacturer	Model No.	Serial No.	Characteristics	Calibration Date	Test Date	Due Date	Remark
Spectrum Analyzer	R&S	FSP30	101400	9kHz~30GHz	Mar. 28, 2013	May 11, 2013~ May 15, 2013	Mar. 27, 2014	Conducted (TH01-SZ)
Power Meter	Anritsu	ML2495A	1218010	N/A	Mar. 28, 2013	May 11, 2013~ May 15, 2013	Mar. 27, 2014	Conducted (TH01-SZ)
Power Sensor	Anritsu	MA2411B	1207253	N/A	Mar. 28, 2013	May 11, 2013~ May 15, 2013	Mar. 27, 2014	Conducted (TH01-SZ)
DC Power Supply	TOPWORD	3303DR	N/A714621	N/A	Mar. 28, 2013	May 11, 2013~ May 15, 2013	Mar. 27, 2014	Conducted (TH01-SZ)
Thermal Chamber	Hongzhan	LP-150U	HD20120425	N/A	Mar. 28, 2013	May 11, 2013~ May 15, 2013	Mar. 27, 2014	Conducted (TH01-SZ)
Bluetooth Base Station	ANRITSU	MT8852B	6K00004935	BT EDR	Oct. 12, 2012	May 11, 2013~ May 15, 2013	Oct. 11, 2013	Conducted (TH01-SZ)
ESCI TEST Receiver	R&S	ESCI	100724	9K-3GHz	Mar. 28, 2013	May 07, 2013	Mar. 27, 2014	Radiation (03CH01-SZ)
Spectrum Analyzer	R&S	FSP30	101362	9kHz~30GHz	Oct. 11, 2012	May 07, 2013	Oct. 10, 2013	Radiation (03CH01-SZ)
Bilog Antenna	SCHAFFNER	CBL6112B	2614	30Mhz~2Ghz	Nov. 03, 2012	May 07, 2013	Nov. 02, 2013	Radiation (03CH01-SZ)
Loop Antenna	R&S	HFH2-Z2	100321	9KHZ-30MHZ	Oct. 22, 2012	May 07, 2013	Oct. 21, 2013	Radiation (03CH01-SZ)
Double Ridge Horn Antenna	ETS Lindgren	3117	00119436	1GHz~18GHz	Oct. 12, 2012	May 07, 2013	Oct. 11, 2013	Radiation (03CH01-SZ)
Amplifier	ADVANTEST	BB525C	E9007003	9K-3000MHz GAIN 30db	Mar. 28, 2013	May 07, 2013	Mar. 27, 2014	Radiation (03CH01-SZ)
Amplifier	Yiai	AV3860B	04030	2GHz~26.5GHz	Mar. 28, 2013	May 07, 2013	Mar. 27, 2014	Radiation (03CH01-SZ)
SHF-EHF-Horn	Schwarzbeck	BBHA9170	BBHA9170249	14Ghz~40Ghz	Nov. 23, 2012	May 07, 2013	Nov. 22, 2013	Radiation (03CH01-SZ)
Bluetooth Base Station	ANRITSU	MT8852B	6K00004935	BT EDR	Oct. 12, 2012	May 07, 2013	Oct. 11, 2013	Radiation (03CH01-SZ)
ESCIO TEST Receiver	R&S	1142.8007.0 3	100724	9K-3GHz	Mar. 28, 2013	Apr. 04, 2013	Mar. 27, 2014	Conduction (CO01-SZ)
AC LISN	ETS-LINDGREN	3816/2SH	00103912	9KHZ~30MHz	Mar. 28, 2013	Apr. 04, 2013	Mar. 27, 2014	Conduction (CO01-SZ)
AC LISN	ETS-LINDGREN	3816/2SH	00103892	9KHZ~30MHz	Mar. 28, 2013	Apr. 04, 2013	Mar. 27, 2014	Conduction (CO01-SZ)
AC Source	Chroma	61602	616020000891	N/A	Nov.20, 2012	Apr. 04, 2013	Nov. 19, 2013	Conduction (CO01-SZ)
System Simulator	Agilent	E5515C	MY50264168	GSM/WCDMA /CDMA2000	Oct. 09, 2012	Apr. 04, 2013	Oct. 08, 2013	Conduction (CO01-SZ)

5 Uncertainty of Evaluation

Uncertainty of Conducted Emission Measurement (150 KHz ~ 30 MHz)

Measuring Uncertainty for a Level of Confidence of 95% ($U = 2Uc(y)$)	2.26
---	------

Uncertainty of Radiated Emission Measurement (30 MHz ~ 1000 MHz)

Measuring Uncertainty for a Level of Confidence of 95% ($U = 2Uc(y)$)	2.54
---	------

Uncertainty of Radiated Emission Measurement (1 GHz ~ 40 GHz)

Measuring Uncertainty for a Level of Confidence of 95% ($U = 2Uc(y)$)	4.72
---	------



Appendix A. Photographs of EUT

Please refer to Sporton report number EP340101 as below.