

# FCC SAR Test Report

APPLICANT : CT Asia (HK) Ltd.  
EQUIPMENT : Mobile phone  
BRAND NAME : BLU  
MODEL NAME : DASH L  
FCC ID : YHLBLUDASHL  
STANDARD : FCC 47 CFR Part 2 (2.1093)  
ANSI/IEEE C95.1-1992  
IEEE 1528-2013

We, SPORTON INTERNATIONAL (SHENZHEN) INC., would like to declare that the tested sample has been evaluated in accordance with the procedures and had been in compliance with the applicable technical standards.

The test results in this report apply exclusively to the tested model / sample. Without written approval of SPORTON INTERNATIONAL (SHENZHEN) INC., the test report shall not be reproduced except in full.

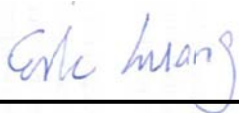

Reviewed by: Eric Huang / Deputy Manager



Approved by: Jones Tsai / Manager



**SPORTON INTERNATIONAL (SHENZHEN) INC.**  
1F & 2F, Building A, Morning Business Center, No. 4003 ShiGu Rd., Xili Town,  
Nanshan District, Shenzhen, Guangdong, P. R. China



Table of Contents

1. Statement of Compliance .....4
2. Administration Data .....5
3. Guidance Standard .....5
4. Equipment Under Test (EUT) .....6
4.1 General Information .....6
4.2 Maximum Tune-up Limit.....7
5. RF Exposure Limits .....8
5.1 Uncontrolled Environment.....8
5.2 Controlled Environment.....8
6. Specific Absorption Rate (SAR).....9
6.1 Introduction .....9
6.2 SAR Definition.....9
7. System Description and Setup .....10
8. Measurement Procedures .....11
8.1 Spatial Peak SAR Evaluation.....11
8.2 Power Reference Measurement.....12
8.3 Area Scan .....12
8.4 Zoom Scan.....13
8.5 Volume Scan Procedures.....13
8.6 Power Drift Monitoring.....13
9. Test Equipment List .....14
10. System Verification .....15
10.1 Tissue Verification .....15
10.2 System Performance Check Results.....16
11. RF Exposure Positions .....17
11.1 Ear and handset reference point .....17
11.2 Definition of the cheek position.....18
11.3 Definition of the tilt position.....19
11.4 Body Worn Accessory .....20
11.5 Wireless Router.....20
12. Conducted RF Output Power (Unit: dBm).....21
13. Bluetooth Exclusions Applied .....28
14. Antenna Location .....29
15. SAR Test Results .....30
15.1 Head SAR .....31
15.2 Hotspot SAR .....32
15.3 Body Worn Accessory SAR.....34
15.4 Repeated SAR Measurement .....35
16. Simultaneous Transmission Analysis.....36
16.1 Head Exposure Conditions .....37
16.2 Hotspot Exposure Conditions.....39
16.3 Body-Worn Accessory Exposure Conditions .....41
16.4 SPLSR Evaluation and Analysis .....42
17. Uncertainty Assessment .....43
18. References .....45
Appendix A. Plots of System Performance Check
Appendix B. Plots of High SAR Measurement
Appendix C. DASY Calibration Certificate
Appendix D. Test Setup Photos



**1. Statement of Compliance**

The maximum results of Specific Absorption Rate (SAR) found during testing for **CT Asia (HK) Ltd., Mobile phone, DASH L**, are as follows.

Equipment Class	Frequency Band	Highest SAR Summary			Highest Simultaneous Transmission 1g SAR (W/kg)
		Head (Separation 0mm)	Body-worn (Separation 10mm)	Wireless Router (Separation 10mm)	
		1g SAR (W/kg)	1g SAR (W/kg)	1g SAR (W/kg)	
PCE	GSM850	0.35	0.73	0.73	1.59
	GSM1900	0.29	0.70	0.70	
	WCDMA Band V	0.49	<b>1.03</b>	<b>1.03</b>	
	WCDMA Band IV	0.24	0.53	0.53	
	WCDMA Band II	0.54	0.95	0.95	
DTS	WLAN 2.4GHz Band	<b>1.18</b>	0.64	0.64	1.59
Date of Testing:		Aug. 07, 2015 ~ Aug. 11, 2015			

This device is in compliance with Specific Absorption Rate (SAR) for general population/uncontrolled exposure limits (1.6 W/kg) specified in FCC 47 CFR part 2 (2.1093) and ANSI/IEEE C95.1-1992, and had been tested in accordance with the measurement methods and procedures specified in IEEE 1528-2013 and FCC KDB publications.



## 2. Administration Data

Testing Laboratory	
Test Site	SPORTON INTERNATIONAL (SHENZHEN) INC.
Test Site Location	1F & 2F, Building A, Morning Business Center, No. 4003 ShiGu Rd., Xili Town, Nanshan District, Shenzhen, Guangdong, P. R. China TEL: +86-755-8637-9589 FAX: +86-755-8637-9595

Applicant	
Company Name	CT Asia (HK) Ltd.
Address	Unit1309-11, 13th Floor 9 Wing Hong Street Cheung Sha Wan Kowloon, Hong Kong

Manufacturer	
Company Name	CT Asia (HK) Ltd.
Address	Unit1309-11, 13th Floor 9 Wing Hong Street Cheung Sha Wan Kowloon, Hong Kong

## 3. Guidance Standard

The Specific Absorption Rate (SAR) testing specification, method, and procedure for this device is in accordance with the following standards:

- FCC 47 CFR Part 2 (2.1093)
- ANSI/IEEE C95.1-1992
- IEEE 1528-2013
- FCC KDB 865664 D01 SAR Measurement 100 MHz to 6 GHz v01r04
- FCC KDB 865664 D02 SAR Reporting v01r01
- FCC KDB 447498 D01 General RF Exposure Guidance v05r02
- FCC KDB 648474 D04 SAR Evaluation Considerations for Wireless Handsets v01r02
- FCC KDB 248227 D01 802.11 Wi-Fi SAR v02r01
- FCC KDB 941225 D01 3G SAR Procedures v03
- FCC KDB 941225 D06 Hotspot Mode SAR v02

## 4. Equipment Under Test (EUT)

### 4.1 General Information

Product Feature & Specification	
Equipment Name	Mobile phone
Brand Name	BLU
Model Name	DASH L
FCC ID	YHLBLUDASHL
IMEI Code	SIM1: 351771053501046 SIM2: 351771053502143
Wireless Technology and Frequency Range	GSM850: 824.2 MHz ~ 848.8 MHz GSM1900: 1850.2 MHz ~ 1909.8 MHz WCDMA Band V: 826.4 MHz ~ 846.6 MHz WCDMA Band IV: 1712.4 MHz ~ 1752.6 MHz WCDMA Band II: 1852.4 MHz ~ 1907.6 MHz WLAN 2.4GHz Band: 2412 MHz ~ 2462 MHz Bluetooth: 2402 MHz ~ 2480 MHz
Mode	<ul style="list-style-type: none"> <li>· GSM/GPRS</li> <li>· RMC/AMR 12.2Kbps</li> <li>· HSDPA</li> <li>· HSUPA</li> <li>· 802.11b/g/n HT20/HT40</li> <li>· Bluetooth v3.0+EDR, Bluetooth v4.0-LE</li> </ul>
HW Version	S4011-MB-V1.2
SW Version	BLU_4.0_V01_GENERIC_150709_163
GSM / GPRS Transfer mode	Class B – EUT cannot support Packet Switched and Circuit Switched Network simultaneously but can automatically switch between Packet and Circuit Switched Network.
EUT Stage	Production Unit
<b>Remark:</b> <ol style="list-style-type: none"> <li>1. This device 2.4GHz WLAN supports Hotspot operation.</li> <li>2. This device supported VoIP in GPRS, WCDMA (e.g. 3rd party VoIP).</li> <li>3. This device supports GRPS mode up to multi-slot class12.</li> <li>4. This device does not support EGPRS and DTM operation.</li> <li>5. This device has 2 SIM slots and supports dual SIM dual Standby. The WWAN radio transmission will be enabled by either one SIM at a time (Single active).</li> </ol>	



**4.2 Maximum Tune-up Limit**

Mode	Burst average power(dBm)	
	GSM 850	GSM 1900
GSM (GMSK, 1 Tx slot)	32.00	30.00
GPRS (GMSK, 1 Tx slot)	32.00	30.00
GPRS (GMSK, 2 Tx slots)	30.00	28.50
GPRS (GMSK, 3 Tx slots)	28.00	26.00
GPRS (GMSK, 4 Tx slots)	26.50	25.00

Mode	Average power(dBm)		
	WCDMA Band V	WCDMA Band II	WCDMA Band IV
AMR 12.2Kbps	22.00	22.00	22.00
RMC 12.2Kbps	22.00	22.00	22.00
HSDPA Subtest-1	21.00	20.50	20.50
HSDPA Subtest-2	21.00	20.50	20.50
HSDPA Subtest-3	20.50	20.00	20.00
HSDPA Subtest-4	20.50	20.00	20.00
HSUPA Subtest-1	19.00	18.50	18.50
HSUPA Subtest-2	19.00	18.50	18.50
HSUPA Subtest-3	20.00	19.50	19.50
HSUPA Subtest-4	18.50	18.00	18.00
HSUPA Subtest-5	20.50	20.50	20.50

Mode		Average Power (dBm)
2.4GHz	802.11b	16.00
	802.11g	11.00
	802.11n-HT20	11.00
	802.11n-HT40	10.00
Bluetooth v3.0+EDR		4.50
Bluetooth v4.0 LE		-4.00

**5. RF Exposure Limits**

**5.1 Uncontrolled Environment**

Uncontrolled Environments are defined as locations where there is the exposure of individuals who have no knowledge or control of their exposure. The general population/uncontrolled exposure limits are applicable to situations in which the general public may be exposed or in which persons who are exposed as a consequence of their employment may not be made fully aware of the potential for exposure or cannot exercise control over their exposure. Members of the general public would come under this category when exposure is not employment-related; for example, in the case of a wireless transmitter that exposes persons in its vicinity.

**5.2 Controlled Environment**

Controlled Environments are defined as locations where there is exposure that may be incurred by persons who are aware of the potential for exposure, (i.e. as a result of employment or occupation). In general, occupational/controlled exposure limits are applicable to situations in which persons are exposed as a consequence of their employment, who have been made fully aware of the potential for exposure and can exercise control over their exposure. The exposure category is also applicable when the exposure is of a transient nature due to incidental passage through a location where the exposure levels may be higher than the general population/uncontrolled limits, but the exposed person is fully aware of the potential for exposure and can exercise control over his or her exposure by leaving the area or by some other appropriate means.

**Limits for Occupational/Controlled Exposure (W/kg)**

Whole-Body	Partial-Body	Hands, Wrists, Feet and Ankles
0.4	8.0	20.0

**Limits for General Population/Uncontrolled Exposure (W/kg)**

Whole-Body	Partial-Body	Hands, Wrists, Feet and Ankles
0.08	1.6	4.0

1. Whole-Body SAR is averaged over the entire body, partial-body SAR is averaged over any 1gram of tissue defined as a tissue volume in the shape of a cube. SAR for hands, wrists, feet and ankles is averaged over any 10 grams of tissue defined as a tissue volume in the shape of a cube.



## **6. Specific Absorption Rate (SAR)**

### **6.1 Introduction**

SAR is related to the rate at which energy is absorbed per unit mass in an object exposed to a radio field. The SAR distribution in a biological body is complicated and is usually carried out by experimental techniques or numerical modeling. The standard recommends limits for two tiers of groups, occupational/controlled and general population/uncontrolled, based on a person's awareness and ability to exercise control over his or her exposure. In general, occupational/controlled exposure limits are higher than the limits for general population/uncontrolled.

### **6.2 SAR Definition**

The SAR definition is the time derivative (rate) of the incremental energy (dW) absorbed by (dissipated in) an incremental mass (dm) contained in a volume element (dv) of a given density ( $\rho$ ). The equation description is as below:

$$SAR = \frac{d}{dt} \left( \frac{dW}{dm} \right) = \frac{d}{dt} \left( \frac{dW}{\rho dv} \right)$$

SAR is expressed in units of Watts per kilogram (W/kg)

$$SAR = \frac{\sigma |E|^2}{\rho}$$

Where:  $\sigma$  is the conductivity of the tissue,  $\rho$  is the mass density of the tissue and E is the RMS electrical field strength.

## 7. System Description and Setup

The DASY system used for performing compliance tests consists of the following items:

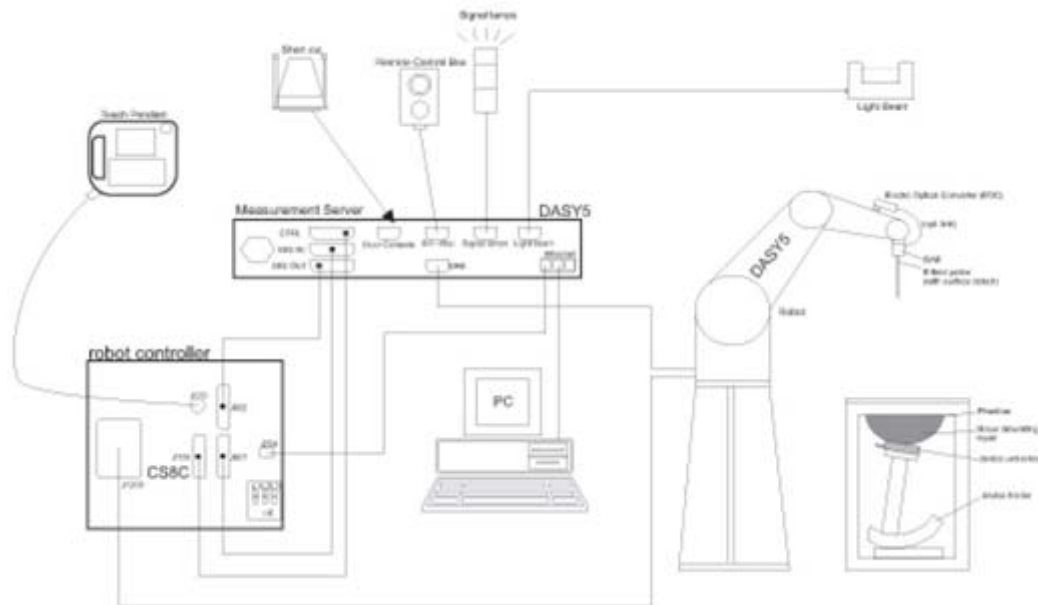

- A standard high precision 6-axis robot with controller, teach pendant and software. An arm extension for accommodating the data acquisition electronics (DAE).
- An isotropic Field probe optimized and calibrated for the targeted measurement.
- A data acquisition electronics (DAE) which performs the signal amplification, signal multiplexing, AD-conversion, offset measurements, mechanical surface detection, collision detection, etc. The unit is battery powered with standard or rechargeable batteries. The signal is optically transmitted to the EOC.
- The Electro-optical converter (EOC) performs the conversion from optical to electrical signals for the digital communication to the DAE. To use optical surface detection, a special version of the EOC is required. The EOC signal is transmitted to the measurement server.
- The function of the measurement server is to perform the time critical tasks such as signal filtering, control of the robot operation and fast movement interrupts.
- The Light Beam used is for probe alignment. This improves the (absolute) accuracy of the probe positioning.
- A computer running WinXP or Win7 and the DASY5 software.
- Remote control and teach pendant as well as additional circuitry for robot safety such as warning lamps, etc.
- The phantom, the device holder and other accessories according to the targeted measurement.

## **8. Measurement Procedures**

The measurement procedures are as follows:

### <Conducted power measurement>

- (a) For WWAN power measurement, use base station simulator to configure EUT WWAN transmission in conducted connection with RF cable, at maximum power in each supported wireless interface and frequency band.
- (b) Read the WWAN RF power level from the base station simulator.
- (c) For WLAN/BT power measurement, use engineering software to configure EUT WLAN/BT continuously transmission, at maximum RF power in each supported wireless interface and frequency band
- (d) Connect EUT RF port through RF cable to the power meter, and measure WLAN/BT output power

### <SAR measurement>

- (a) Use base station simulator to configure EUT WWAN transmission in radiated connection, and engineering software to configure EUT WLAN/BT continuously transmission, at maximum RF power, in the highest power channel.
- (b) Place the EUT in the positions as Appendix D demonstrates.
- (c) Set scan area, grid size and other setting on the DASY software.
- (d) Measure SAR results for the highest power channel on each testing position.
- (e) Find out the largest SAR result on these testing positions of each band
- (f) Measure SAR results for other channels in worst SAR testing position if the reported SAR of highest power channel is larger than 0.8 W/kg

According to the test standard, the recommended procedure for assessing the peak spatial-average SAR value consists of the following steps:

- (a) Power reference measurement
- (b) Area scan
- (c) Zoom scan
- (d) Power drift measurement

### **8.1 Spatial Peak SAR Evaluation**

The procedure for spatial peak SAR evaluation has been implemented according to the test standard. It can be conducted for 1g and 10g, as well as for user-specific masses. The DASY software includes all numerical procedures necessary to evaluate the spatial peak SAR value.

The base for the evaluation is a "cube" measurement. The measured volume must include the 1g and 10g cubes with the highest averaged SAR values. For that purpose, the center of the measured volume is aligned to the interpolated peak SAR value of a previously performed area scan.

The entire evaluation of the spatial peak values is performed within the post-processing engine (SEMCAD). The system always gives the maximum values for the 1g and 10g cubes. The algorithm to find the cube with highest averaged SAR is divided into the following stages:

- (a) Extraction of the measured data (grid and values) from the Zoom Scan
- (b) Calculation of the SAR value at every measurement point based on all stored data (A/D values and measurement parameters)
- (c) Generation of a high-resolution mesh within the measured volume
- (d) Interpolation of all measured values from the measurement grid to the high-resolution grid
- (e) Extrapolation of the entire 3-D field distribution to the phantom surface over the distance from sensor to surface
- (f) Calculation of the averaged SAR within masses of 1g and 10g

**8.2 Power Reference Measurement**

The Power Reference Measurement and Power Drift Measurements are for monitoring the power drift of the device under test in the batch process. The minimum distance of probe sensors to surface determines the closest measurement point to phantom surface. This distance cannot be smaller than the distance of sensor calibration points to probe tip as defined in the probe properties.

**8.3 Area Scan**

The area scan is used as a fast scan in two dimensions to find the area of high field values, before doing a fine measurement around the hot spot. The sophisticated interpolation routines implemented in DASY software can find the maximum found in the scanned area, within a range of the global maximum. The range (in dB) is specified in the standards for compliance testing. For example, a 2 dB range is required in IEEE standard 1528 and IEC 62209 standards, whereby 3 dB is a requirement when compliance is assessed in accordance with the ARIB standard (Japan), if only one zoom scan follows the area scan, then only the absolute maximum will be taken as reference. For cases where multiple maximums are detected, the number of zoom scans has to be increased accordingly.

Area scan parameters extracted from FCC KDB 865664 D01v01r04 SAR measurement 100 MHz to 6 GHz.

	≤ 3 GHz	> 3 GHz
Maximum distance from closest measurement point (geometric center of probe sensors) to phantom surface	5 ± 1 mm	$\frac{1}{2} \cdot \delta \cdot \ln(2) \pm 0.5$ mm
Maximum probe angle from probe axis to phantom surface normal at the measurement location	30° ± 1°	20° ± 1°
Maximum area scan spatial resolution: $\Delta x_{Area}, \Delta y_{Area}$	≤ 2 GHz: ≤ 15 mm 2 – 3 GHz: ≤ 12 mm	3 – 4 GHz: ≤ 12 mm 4 – 6 GHz: ≤ 10 mm
	When the x or y dimension of the test device, in the measurement plane orientation, is smaller than the above, the measurement resolution must be ≤ the corresponding x or y dimension of the test device with at least one measurement point on the test device.	

**8.4 Zoom Scan**

Zoom scans are used assess the peak spatial SAR values within a cubic averaging volume containing 1 gram and 10 gram of simulated tissue. The zoom scan measures points (refer to table below) within a cube shoes base faces are centered on the maxima found in a preceding area scan job within the same procedure. When the measurement is done, the zoom scan evaluates the averaged SAR for 1 gram and 10 gram and displays these values next to the job's label.

Zoom scan parameters extracted from FCC KDB 865664 D01v01r04 SAR measurement 100 MHz to 6 GHz.

		≤ 3 GHz	> 3 GHz	
Maximum zoom scan spatial resolution: $\Delta x_{Zoom}, \Delta y_{Zoom}$		$\leq 2$ GHz: $\leq 8$ mm 2 – 3 GHz: $\leq 5$ mm*	3 – 4 GHz: $\leq 5$ mm* 4 – 6 GHz: $\leq 4$ mm*	
Maximum zoom scan spatial resolution, normal to phantom surface	uniform grid: $\Delta z_{Zoom}(n)$	$\leq 5$ mm	3 – 4 GHz: $\leq 4$ mm 4 – 5 GHz: $\leq 3$ mm 5 – 6 GHz: $\leq 2$ mm	
	graded grid	$\Delta z_{Zoom}(1)$ : between 1 <sup>st</sup> two points closest to phantom surface	$\leq 4$ mm	3 – 4 GHz: $\leq 3$ mm 4 – 5 GHz: $\leq 2.5$ mm 5 – 6 GHz: $\leq 2$ mm
		$\Delta z_{Zoom}(n>1)$ : between subsequent points	$\leq 1.5 \cdot \Delta z_{Zoom}(n-1)$	
Minimum zoom scan volume	x, y, z	$\geq 30$ mm	3 – 4 GHz: $\geq 28$ mm 4 – 5 GHz: $\geq 25$ mm 5 – 6 GHz: $\geq 22$ mm	
Note: $\delta$ is the penetration depth of a plane-wave at normal incidence to the tissue medium; see draft standard IEEE P1528-2011 for details. * When zoom scan is required and the <i>reported</i> SAR from the <i>area scan based 1-g SAR estimation</i> procedures of KDB 447498 is $\leq 1.4$ W/kg, $\leq 8$ mm, $\leq 7$ mm and $\leq 5$ mm zoom scan resolution may be applied, respectively, for 2 GHz to 3 GHz, 3 GHz to 4 GHz and 4 GHz to 6 GHz.				

**8.5 Volume Scan Procedures**

The volume scan is used for assess overlapping SAR distributions for antennas transmitting in different frequency bands. It is equivalent to an oversized zoom scan used in standalone measurements. The measurement volume will be used to enclose all the simultaneous transmitting antennas. For antennas transmitting simultaneously in different frequency bands, the volume scan is measured separately in each frequency band. In order to sum correctly to compute the 1g aggregate SAR, the EUT remain in the same test position for all measurements and all volume scan use the same spatial resolution and grid spacing. When all volume scan were completed, the software, SEMCAD postprocessor can combine and subsequently superpose these measurement data to calculating the multiband SAR.

**8.6 Power Drift Monitoring**

All SAR testing is under the EUT install full charged battery and transmit maximum output power. In DASY measurement software, the power reference measurement and power drift measurement procedures are used for monitoring the power drift of EUT during SAR test. Both these procedures measure the field at a specified reference position before and after the SAR testing. The software will calculate the field difference in dB. If the power drifts more than 5%, the SAR will be retested.



### 9. Test Equipment List

Manufacturer	Name of Equipment	Type/Model	Serial Number	Calibration	
				Last Cal.	Due Date
SPEAG	835MHz System Validation Kit	D835V2	4d091	Nov. 21, 2014	Nov. 20, 2015
SPEAG	1750MHz System Validation Kit	D1750V2	1069	Nov. 21, 2014	Nov. 20, 2015
SPEAG	1900MHz System Validation Kit	D1900V2	5d118	Nov. 21, 2014	Nov. 20, 2015
SPEAG	2450MHz System Validation Kit	D2450V2	840	Nov. 19, 2014	Nov. 18, 2015
SPEAG	Data Acquisition Electronics	DAE4	1303	Dec. 11, 2014	Dec. 10, 2015
SPEAG	Dosimetric E-Field Probe	EX3DV4	3819	Nov. 13, 2014	Nov. 12, 2015
SPEAG	SAM Twin Phantom	QD 000 P40 CD	TP-1671	NCR	NCR
SPEAG	Phone Positioner	N/A	N/A	NCR	NCR
Agilent	Wireless Communication Test Set	E5515C	MY50267224	Aug. 07, 2015	Aug. 06, 2016
R&S	Network Analyzer	ZVB8	100106	Sep. 29, 2014	Sep. 28, 2015
Speag	Dielectric Assessment KIT	DAK-3.5	1032	NCR	NCR
R&S	Signal Generator	SMBV100A	258305	Jan. 23, 2015	Jan. 22, 2016
Anritsu	Power Sensor	MA2411B	1207253	Jan. 28, 2015	Jan. 27, 2016
Anritsu	Power Meter	ML2495A	1218010	Jan. 28, 2015	Jan. 27, 2016
Anritsu	Power Sensor	MA2411B	917070	Jan. 23, 2015	Jan. 22, 2016
Anritsu	Power Meter	ML2495A	1005002	Jan. 23, 2015	Jan. 22, 2016
ARRA	Power Divider	A3200-2	N/A	NA	NA
MCL	Attenuation	BW-S10W5	N/A	NA	NA
R&S	Spectrum Analyzer	FSP30	101362	Sep. 29, 2014	Sep. 28, 2015
Agilent	Dual Directional Coupler	778D	50422	Note1	
Woken	Attenuator 1	WK0602-XX	N/A	Note1	
PE	Attenuator 2	PE7005-10	N/A	Note1	
PE	Attenuator 3	PE7005- 3	N/A	Note1	
AR	Power Amplifier	5S1G4M2	0328767	Note1	
Mini-Circuits	Power Amplifier	ZVE-3W	162601250	Note1	
Mini-Circuits	Power Amplifier	ZHL-42W+	13440021344	Note1	

**General Note:**

1. Prior to system verification and validation, the path loss from the signal generator to the system check source and the power meter, which includes the amplifier, cable, attenuator and directional coupler, was measured by the network analyzer. The reading of the power meter was offset by the path loss difference between the path to the power meter and the path to the system check source to monitor the actual power level fed to the system check source.



## 10. System Verification

### 10.1 Tissue Verification

The following tissue formulations are provided for reference only as some of the parameters have not been thoroughly verified. The composition of ingredients may be modified accordingly to achieve the desired target tissue parameters required for routine SAR evaluation.

Frequency (MHz)	Water (%)	Sugar (%)	Cellulose (%)	Salt (%)	Preventol (%)	DGBE (%)	Conductivity ( $\sigma$ )	Permittivity ( $\epsilon_r$ )
For Head								
835	40.3	57.9	0.2	1.4	0.2	0	0.90	41.5
1750	55.2	0	0	0.3	0	44.5	1.37	40.1
1800, 1900, 2000	55.2	0	0	0.3	0	44.5	1.40	40.0
2450	55.0	0	0	0	0	45.0	1.80	39.2
For Body								
835	50.8	48.2	0	0.9	0.1	0	0.97	55.2
1750	70.2	0	0	0.4	0	29.4	1.49	53.4
1800, 1900, 2000	70.2	0	0	0.4	0	29.4	1.52	53.3
2450	68.6	0	0	0	0	31.4	1.95	52.7

### <Tissue Dielectric Parameter Check Results>

Frequency (MHz)	Tissue Type	Liquid Temp. (°C)	Conductivity ( $\sigma$ )	Permittivity ( $\epsilon_r$ )	Conductivity Target ( $\sigma$ )	Permittivity Target ( $\epsilon_r$ )	Delta ( $\sigma$ ) (%)	Delta ( $\epsilon_r$ ) (%)	Limit (%)	Date
835	Head	22.8	0.916	41.029	0.90	41.50	1.78	-1.13	±5	Aug. 09, 2015
1750	Head	22.8	1.385	39.708	1.37	40.10	1.09	-0.98	±5	Aug. 08, 2015
1900	Head	22.9	1.443	40.030	1.40	40.00	3.07	0.08	±5	Aug. 08, 2015
2450	Head	22.9	1.829	40.081	1.80	39.20	1.61	2.25	±5	Aug. 09, 2015
835	Body	22.8	0.968	57.458	0.97	55.20	-0.21	4.09	±5	Aug. 08, 2015
1750	Body	22.6	1.528	52.031	1.49	53.40	2.55	-2.56	±5	Aug. 07, 2015
1900	Body	22.7	1.580	54.631	1.52	53.30	3.95	2.50	±5	Aug. 07, 2015
2450	Body	22.6	1.991	52.320	1.95	52.70	2.10	-0.72	±5	Aug. 11, 2015



**10.2 System Performance Check Results**

Comparing to the original SAR value provided by SPEAG, the verification data should be within its specification of 10 %. Below table shows the target SAR and measured SAR after normalized to 1W input power. The table below indicates the system performance check can meet the variation criterion and the plots can be referred to Appendix A of this report.

Date	Frequency (MHz)	Tissue Type	Input Power (mW)	Dipole S/N	Probe S/N	DAE S/N	Measured SAR (W/kg)	Targeted SAR (W/kg)	Normalized SAR (W/kg)	Deviation (%)
Aug. 09, 2015	835	Head	250	4d091	3819	1303	2.34	9.11	9.36	2.74
Aug. 08, 2015	1750	Head	250	1069	3819	1303	10.00	37.10	40	7.82
Aug. 08, 2015	1900	Head	250	5d118	3819	1303	10.90	40.10	43.6	8.73
Aug. 09, 2015	2450	Head	250	840	3819	1303	13.30	52.30	53.2	1.72
Aug. 08, 2015	835	Body	250	4d091	3819	1303	2.41	9.60	9.64	0.42
Aug. 07, 2015	1750	Body	250	1069	3819	1303	10.20	38.10	40.8	7.09
Aug. 07, 2015	1900	Body	250	5d118	3819	1303	10.30	40.00	41.2	3.00
Aug. 11, 2015	2450	Body	250	840	3819	1303	12.70	51.00	50.8	-0.39

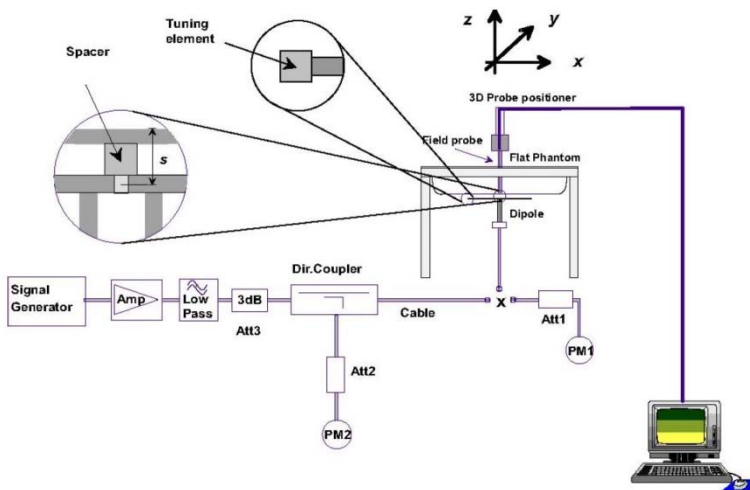

**Fig 8.3.1 System Performance Check Setup**



**Fig 8.3.2 Setup Photo**



## 11. RF Exposure Positions

### 11.1 Ear and handset reference point

Figure 9.1.1 shows the front, back, and side views of the SAM phantom. The center-of-mouth reference point is labeled “M,” the left ear reference point (ERP) is marked “LE,” and the right ERP is marked “RE.” Each ERP is 15 mm along the B-M (back-mouth) line behind the entrance-to-ear-canal (EEC) point, as shown in Figure 9.1.2 The Reference Plane is defined as passing through the two ear reference points and point M. The line N-F (neck-front), also called the reference pivoting line, is normal to the Reference Plane and perpendicular to both a line passing through RE and LE and the B-M line (see Figure 9.1.3). Both N-F and B-M lines should be marked on the exterior of the phantom shell to facilitate handset positioning. Posterior to the N-F line the ear shape is a flat surface with 6 mm thickness at each ERP, and forward of the N-F line the ear is truncated, as illustrated in Figure 9.1.2. The ear truncation is introduced to preclude the ear lobe from interfering with handset tilt, which could lead to unstable positioning at the cheek.

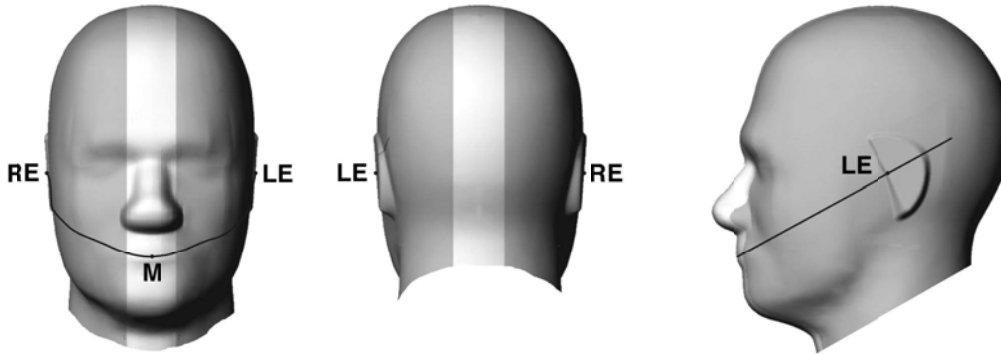

Fig 9.1.1 Front, back, and side views of SAM twin phantom

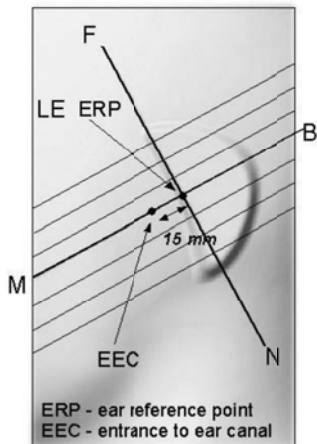

Fig 9.1.2 Close-up side view of phantom showing the ear region.

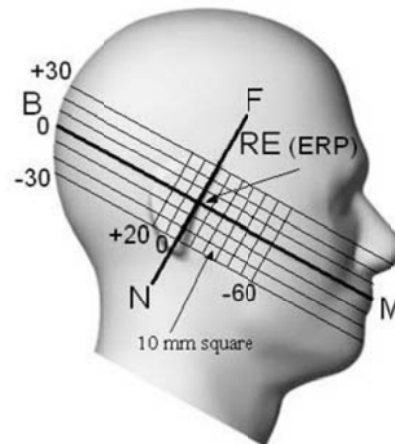
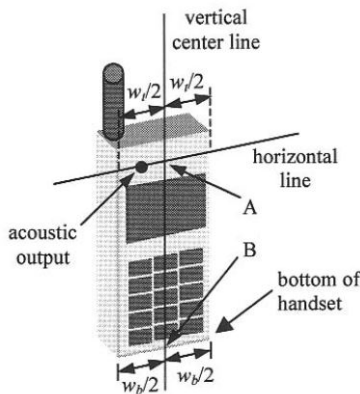

Fig 9.1.3 Side view of the phantom showing relevant markings and seven cross-sectional plane locations

**11.2 Definition of the cheek position**

1. Ready the handset for talk operation, if necessary. For example, for handsets with a cover piece (flip cover), open the cover. If the handset can transmit with the cover closed, both configurations must be tested.
2. Define two imaginary lines on the handset—the vertical centerline and the horizontal line. The vertical centerline passes through two points on the front side of the handset—the midpoint of the width  $w_t$  of the handset at the level of the acoustic output (point A in Figure 9.2.1 and Figure 9.2.2), and the midpoint of the width  $w_b$  of the bottom of the handset (point B). The horizontal line is perpendicular to the vertical centerline and passes through the center of the acoustic output (see Figure 9.2.1). The two lines intersect at point A. Note that for many handsets, point A coincides with the center of the acoustic output; however, the acoustic output may be located elsewhere on the horizontal line. Also note that the vertical centerline is not necessarily parallel to the front face of the handset (see Figure 9.2.2), especially for clamshell handsets, handsets with flip covers, and other irregularly-shaped handsets.
3. Position the handset close to the surface of the phantom such that point A is on the (virtual) extension of the line passing through points RE and LE on the phantom (see Figure 9.2.3), such that the plane defined by the vertical centerline and the horizontal line of the handset is approximately parallel to the sagittal plane of the phantom.
4. Translate the handset towards the phantom along the line passing through RE and LE until handset point A touches the pinna at the ERP.
5. While maintaining the handset in this plane, rotate it around the LE-RE line until the vertical centerline is in the plane normal to the plane containing B-M and N-F lines, i.e., the Reference Plane.
6. Rotate the handset around the vertical centerline until the handset (horizontal line) is parallel to the N-F line.
7. While maintaining the vertical centerline in the Reference Plane, keeping point A on the line passing through RE and LE, and maintaining the handset contact with the pinna, rotate the handset about the N-F line until any point on the handset is in contact with a phantom point below the pinna on the cheek. See Figure 9.2.3. The actual rotation angles should be documented in the test report.



**Fig 9.2.1 Handset vertical and horizontal reference lines—“fixed case”**

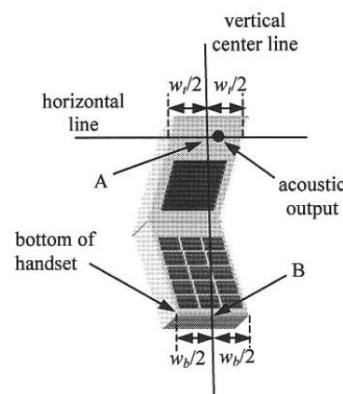

**Fig 9.2.2 Handset vertical and horizontal reference lines—“clam-shell case”**

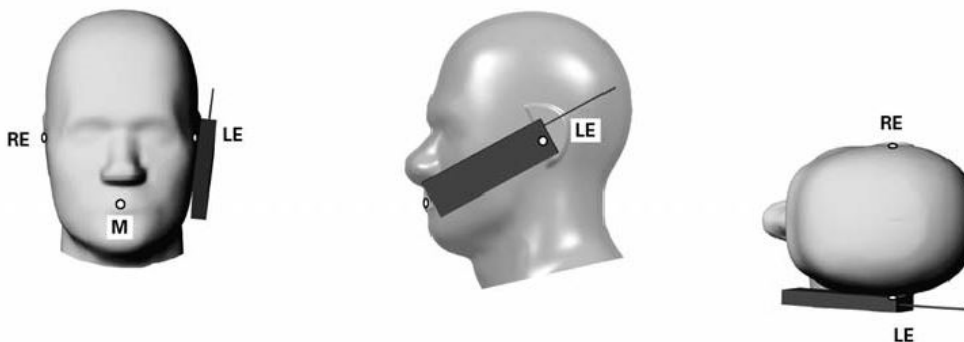

**Fig 9.2.3 cheek or touch position. The reference points for the right ear (RE), left ear (LE), and mouth (M), which establish the Reference Plane for handset positioning, are indicated.**

**11.3 Definition of the tilt position**

1. Ready the handset for talk operation, if necessary. For example, for handsets with a cover piece (flip cover), open the cover. If the handset can transmit with the cover closed, both configurations must be tested.
2. While maintaining the orientation of the handset, move the handset away from the pinna along the line passing through RE and LE far enough to allow a rotation of the handset away from the cheek by 15°.
3. Rotate the handset around the horizontal line by 15°.
4. While maintaining the orientation of the handset, move the handset towards the phantom on the line passing through RE and LE until any part of the handset touches the ear. The tilt position is obtained when the contact point is on the pinna. See Figure 9.3.1. If contact occurs at any location other than the pinna, e.g., the antenna at the back of the phantom head, the angle of the handset should be reduced. In this case, the tilt position is obtained if any point on the handset is in contact with the pinna and a second point

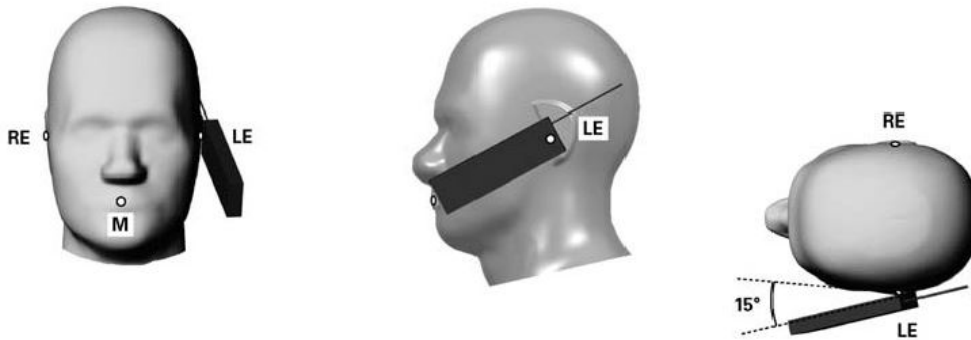
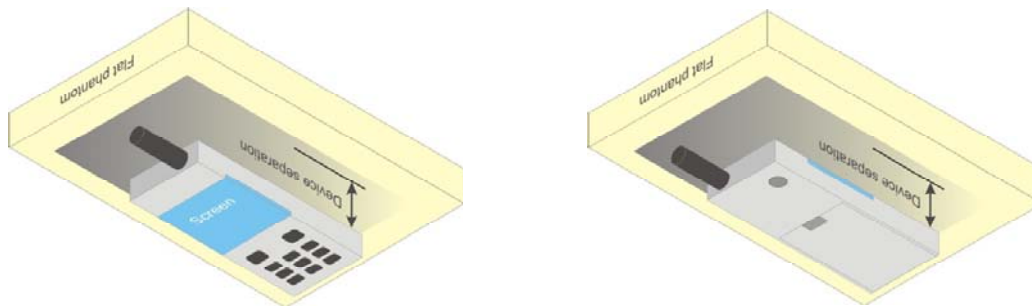

**Fig 9.3.1 Tilt position. The reference points for the right ear (RE), left ear (LE), and mouth (M), which define the Reference Plane for handset positioning, are indicated.**

**11.4 Body Worn Accessory**

Body-worn operating configurations are tested with the belt-clips and holsters attached to the device and positioned against a flat phantom in a normal use configuration (see Figure 9.4). Per KDB 648474 D04v01r02, body-worn accessory exposure is typically related to voice mode operations when handsets are carried in body-worn accessories. The body-worn accessory procedures in FCC KDB 447498 D01v05r02 should be used to test for body-worn accessory SAR compliance, without a headset connected to it. This enables the test results for such configuration to be compatible with that required for hotspot mode when the body-worn accessory test separation distance is greater than or equal to that required for hotspot mode, when applicable. When the reported SAR for body-worn accessory, measured without a headset connected to the handset is < 1.2 W/kg, the highest reported SAR configuration for that wireless mode and frequency band should be repeated for that body-worn accessory with a handset attached to the handset.

Accessories for body-worn operation configurations are divided into two categories: those that do not contain metallic components and those that do contain metallic components. When multiple accessories that do not contain metallic components are supplied with the device, the device is tested with only the accessory that dictates the closest spacing to the body. Then multiple accessories that contain metallic components are test with the device with each accessory. If multiple accessories share an identical metallic component (i.e. the same metallic belt-clip used with different holsters with no other metallic components) only the accessory that dictates the closest spacing to the body is tested.



**Fig 9.4 Body Worn Position**

**11.5 Wireless Router**

Some battery-operated handsets have the capability to transmit and receive user through simultaneous transmission of WIFI simultaneously with a separate licensed transmitter. The FCC has provided guidance in FCC HDB Publication 941225 D06 v02 where SAR test considerations for handsets (L x W ≥ 9 cm x 5 cm) are based on a composite test separation distance of 10mm from the front, back and edges of the device containing transmitting antennas within 2.5cm of their edges, determined from general mixed use conditions for this type of devices. Since the hotspot SAR results may overlap with the body-worn accessory SAR requirements, the more conservative configurations can be considered, thus excluding some body-worn accessory SAR tests.

When the user enables the personal wireless router functions for the handset, actual operations include simultaneous transmission of both the WIFI transmitter and another licensed transmitter. Both transmitters often do not transmit at the same transmitting frequency and thus cannot be evaluated for SAR under actual use conditions due to the limitations of the SAR assessment probes. Therefore, SAR must be evaluated for each frequency transmission and mode separately and spatially summed with the WIFI transmitter according to FCC KDB Publication 447498 D01v05r02 publication procedures. The "Portable Hotspot" feature on the handset was NOT activated during SAR assessments, to ensure the SAR measurements were evaluated for a single transmission frequency RF signal at a time.



## 12. Conducted RF Output Power (Unit: dBm)

### <GSM Conducted Power>

**General Note:**

1. Per KDB 447498 D01v05r02, the maximum output power channel is used for SAR testing and for further SAR test reduction.
2. Per KDB 941225 D01v03, considering the possibility of e.g. 3rd party VoIP operation for Head and body-worn SAR test reduction for GSM and GPRS modes is determined by the source-based time-averaged output power including tune-up tolerance. The mode with highest specified time-averaged output power should be tested for SAR compliance in the applicable exposure conditions. For modes with the same specified maximum output power and tolerance, the higher number time-slot configuration should be tested. Therefore, the EUT was set in GPRS (2Tx slots) for GSM850/GSM1900.
3. Per KDB 941225 D01v03, for Hotspot SAR test reduction for GPRS modes is determined by the source-based time-averaged output power including tune-up tolerance, for modes with the same specified maximum output power and tolerance, the higher number time-slot configuration should be tested, therefore, the EUT was set in GPRS (2Tx slots) for GSM850/GSM1900.

**SIM 1:**

Band GSM850	Burst Average Power (dBm)			Tune-up Limit (dBm)	Frame-Average Power (dBm)			Tune-up Limit (dBm)	
	128	189	251		128	189	251		
TX Channel	128	189	251		128	189	251		
Frequency (MHz)	824.2	836.4	848.8		824.2	836.4	848.8		
GSM (GMSK, 1 Tx slot)	31.46	31.51	31.62	32.00	22.46	22.51	22.62	23.00	
GPRS (GMSK, 1 Tx slot)	31.44	31.50	31.61	32.00	22.44	22.50	22.61	23.00	
GPRS (GMSK, 2 Tx slots)	29.25	29.30	29.42	30.00	23.25	23.30	23.42	24.00	
GPRS (GMSK, 3 Tx slots)	27.13	27.18	27.29	28.00	22.87	22.92	23.03	23.74	
GPRS (GMSK, 4 Tx slots)	26.00	26.04	26.14	26.50	23.00	23.04	23.14	23.50	
Band GSM1900		Burst Average Power (dBm)			Tune-up Limit (dBm)	Frame-Average Power (dBm)			Tune-up Limit (dBm)
TX Channel		512	661	810		512	661	810	
Frequency (MHz)		1850.2	1880	1909.8		1850.2	1880	1909.8	
GSM (GMSK, 1 Tx slot)		29.78	29.33	29.11	30.00	20.78	20.33	20.11	21.00
GPRS (GMSK, 1 Tx slot)		29.77	29.32	29.09	30.00	20.77	20.32	20.09	21.00
GPRS (GMSK, 2 Tx slots)		28.13	27.70	27.46	28.50	22.13	21.70	21.46	22.50
GPRS (GMSK, 3 Tx slots)		25.68	25.23	25.00	26.00	21.42	20.97	20.74	21.74
GPRS (GMSK, 4 Tx slots)		24.61	24.18	23.95	25.00	21.61	21.18	20.95	22.00

Remark: The frame-averaged power is linearly scaled the maximum burst averaged power over 8 time slots.

The calculated method are shown as below:

- Frame-averaged power = Maximum burst averaged power (1 Tx Slot) - 9 dB
- Frame-averaged power = Maximum burst averaged power (2 Tx Slots) - 6 dB
- Frame-averaged power = Maximum burst averaged power (3 Tx Slots) - 4.26 dB
- Frame-averaged power = Maximum burst averaged power (4 Tx Slots) - 3 dB



**SIM 2:**

Band GSM850	Burst Average Power (dBm)			Tune-up Limit (dBm)	Frame-Average Power (dBm)			Tune-up Limit (dBm)
	TX Channel	128	189		251	128	189	
Frequency (MHz)	824.2	836.4	848.8		824.2	836.4	848.8	
GSM (GMSK, 1 Tx slot)	31.30	31.40	31.54	32.00	22.30	22.40	22.54	23.00
GPRS (GMSK, 1 Tx slot)	31.29	31.38	31.53	32.00	22.29	22.38	22.53	23.00
GPRS (GMSK, 2 Tx slots)	29.13	29.23	29.35	30.00	23.13	23.23	23.35	24.00
GPRS (GMSK, 3 Tx slots)	27.02	27.11	27.21	28.00	22.76	22.85	22.95	23.74
GPRS (GMSK, 4 Tx slots)	25.88	25.96	26.06	26.50	22.88	22.96	23.06	23.50
Band GSM1900	Burst Average Power (dBm)			Tune-up Limit (dBm)	Frame-Average Power (dBm)			Tune-up Limit (dBm)
TX Channel	512	661	810		512	661	810	
Frequency (MHz)	1850.2	1880	1909.8		1850.2	1880	1909.8	
GSM (GMSK, 1 Tx slot)	29.63	29.21	29.03	30.00	20.63	20.21	20.03	21.00
GPRS (GMSK, 1 Tx slot)	29.62	29.19	29.00	30.00	20.62	20.19	20.00	21.00
GPRS (GMSK, 2 Tx slots)	27.98	27.53	27.34	28.50	21.98	21.53	21.34	22.50
GPRS (GMSK, 3 Tx slots)	25.54	25.08	24.89	26.00	21.28	20.82	20.63	21.74
GPRS (GMSK, 4 Tx slots)	24.48	24.03	23.83	25.00	21.48	21.03	20.83	22.00

Remark: The frame-averaged power is linearly scaled the maximum burst averaged power over 8 time slots.  
The calculated method are shown as below:  
Frame-averaged power = Maximum burst averaged power (1 Tx Slot) - 9 dB  
Frame-averaged power = Maximum burst averaged power (2 Tx Slots) - 6 dB  
Frame-averaged power = Maximum burst averaged power (3 Tx Slots) - 4.26 dB  
Frame-averaged power = Maximum burst averaged power (4 Tx Slots) - 3 dB



**<WCDMA Conducted Power>**

1. The following tests were conducted according to the test requirements outlines in 3GPP TS 34.121 specification.
2. The procedures in KDB 941225 D01 are applied for 3GPP Rel. 6 HSPA to configure the device in the required sub-test mode(s) to determine SAR test exclusion.

A summary of these settings are illustrated below:

**HSDPA Setup Configuration:**

- a. The EUT was connected to Base Station Agilent E5515C referred to the Setup Configuration.
- b. The RF path losses were compensated into the measurements.
- c. A call was established between EUT and Base Station with following setting:
  - i. Set Gain Factors ( $\beta_c$  and  $\beta_d$ ) and parameters were set according to each
  - ii. Specific sub-test in the following table, C10.1.4, quoted from the TS 34.121
  - iii. Set RMC 12.2Kbps + HSDPA mode.
  - iv. Set Cell Power = -86 dBm
  - v. Set HS-DSCH Configuration Type to FRC (H-set 1, QPSK)
  - vi. Select HSDPA Uplink Parameters
  - vii. Set Delta ACK, Delta NACK and Delta CQI = 8
  - viii. Set Ack-Nack Repetition Factor to 3
  - ix. Set CQI Feedback Cycle (k) to 4 ms
  - x. Set CQI Repetition Factor to 2
  - xi. Power Ctrl Mode = All Up bits
- d. The transmitted maximum output power was recorded.

**Table C.10.1.4:  $\beta$  values for transmitter characteristics tests with HS-DPCCH**

Sub-test	$\beta_c$	$\beta_d$	$\beta_d$ (SF)	$\beta_c/\beta_d$	$\beta_{HS}$ (Note 1, Note 2)	CM (dB) (Note 3)	MPR (dB) (Note 3)
1	2/15	15/15	64	2/15	4/15	0.0	0.0
2	12/15 (Note 4)	15/15 (Note 4)	64	12/15 (Note 4)	24/15	1.0	0.0
3	15/15	8/15	64	15/8	30/15	1.5	0.5
4	15/15	4/15	64	15/4	30/15	1.5	0.5

Note 1:  $\Delta_{ACK}, \Delta_{NACK}$  and  $\Delta_{CQI} = 30/15$  with  $\beta_{HS} = 30/15 * \beta_c$ .

Note 2: For the HS-DPCCH power mask requirement test in clause 5.2C, 5.7A, and the Error Vector Magnitude (EVM) with HS-DPCCH test in clause 5.13.1A, and HSDPA EVM with phase discontinuity in clause 5.13.1AA,  $\Delta_{ACK}$  and  $\Delta_{NACK} = 30/15$  with  $\beta_{HS} = 30/15 * \beta_c$ , and  $\Delta_{CQI} = 24/15$  with  $\beta_{HS} = 24/15 * \beta_c$ .

Note 3: CM = 1 for  $\beta_c/\beta_d = 12/15, \beta_{HS}/\beta_c = 24/15$ . For all other combinations of DPDCH, DPCCH and HS-DPCCH the MPR is based on the relative CM difference. This is applicable for only UEs that support HSDPA in release 6 and later releases.

Note 4: For subtest 2 the  $\beta_c/\beta_d$  ratio of 12/15 for the TFC during the measurement period (TF1, TF0) is achieved by setting the signalled gain factors for the reference TFC (TF1, TF1) to  $\beta_c = 11/15$  and  $\beta_d = 15/15$ .

**Setup Configuration**

**HSUPA Setup Configuration:**

- a. The EUT was connected to Base Station Agilent E5515C referred to the Setup Configuration.
- b. The RF path losses were compensated into the measurements.
- c. A call was established between EUT and Base Station with following setting \* :
  - i. Call Configs = 5.2B, 5.9B, 5.10B, and 5.13.2B with QPSK
  - ii. Set the Gain Factors ( $\beta_c$  and  $\beta_d$ ) and parameters (AG Index) were set according to each specific sub-test in the following table, C11.1.3, quoted from the TS 34.121
  - iii. Set Cell Power = -86 dBm
  - iv. Set Channel Type = 12.2k + HSPA
  - v. Set UE Target Power
  - vi. Power Ctrl Mode= Alternating bits
  - vii. Set and observe the E-TFCl
  - viii. Confirm that E-TFCl is equal to the target E-TFCl of 75 for sub-test 1, and other subtest's E-TFCl
- d. The transmitted maximum output power was recorded.

**Table C.11.1.3:  $\beta$  values for transmitter characteristics tests with HS-DPCCH and E-DCH**

Sub-test	$\beta_c$	$\beta_d$	$\beta_d$ (SF)	$\beta_c/\beta_d$	$\beta_{HS}$ (Note 1)	$\beta_{ec}$	$\beta_{ed}$ (Note 5) (Note 6)	$\beta_{ed}$ (SF)	$\beta_{ed}$ (Codes)	CM (dB) (Note 2)	MPR (dB) (Note 2)	AG Index (Note 6)	E-TFCl
1	11/15 (Note 3)	15/15 (Note 3)	64	11/15 (Note 3)	22/15	209/25	1309/225	4	1	1.0	0.0	20	75
2	6/15	15/15	64	6/15	12/15	12/15	94/75	4	1	3.0	2.0	12	67
3	15/15	9/15	64	15/9	30/15	30/15	$\beta_{ed1}: 47/15$ $\beta_{ed2}: 47/15$	4 4	2	2.0	1.0	15	92
4	2/15	15/15	64	2/15	4/15	2/15	56/75	4	1	3.0	2.0	17	71
5	15/15 (Note 4)	15/15 (Note 4)	64	15/15 (Note 4)	30/15	24/15	134/15	4	1	1.0	0.0	21	81

Note 1:  $\Delta_{ACK}, \Delta_{NACK}$  and  $\Delta_{CQI} = 30/15$  with  $\beta_{hs} = 30/15 * \beta_c$ .

Note 2: CM = 1 for  $\beta_c/\beta_d = 12/15, \beta_{hs}/\beta_c = 24/15$ . For all other combinations of DPDCH, DPCCH, HS-DPCCH, E-DPDCH and E-DPCCH the MPR is based on the relative CM difference.

Note 3: For subtest 1 the  $\beta_c/\beta_d$  ratio of 11/15 for the TFC during the measurement period (TF1, TF0) is achieved by setting the signalled gain factors for the reference TFC (TF1, TF1) to  $\beta_c = 10/15$  and  $\beta_d = 15/15$ .

Note 4: For subtest 5 the  $\beta_c/\beta_d$  ratio of 15/15 for the TFC during the measurement period (TF1, TF0) is achieved by setting the signalled gain factors for the reference TFC (TF1, TF1) to  $\beta_c = 14/15$  and  $\beta_d = 15/15$ .

Note 5: In case of testing by UE using E-DPDCH Physical Layer category 1, Sub-test 3 is omitted according to TS25.306 Table 5.1g.

Note 6:  $\beta_{ed}$  can not be set directly, it is set by Absolute Grant Value.

**Setup Configuration**





**<WCDMA Conducted Power>**

**General Note:**

1. Per KDB 941225 D01v03, SAR for Head / Hotspot / Body-worn exposure is measured using a 12.2 kbps RMC with TPC bits configured to all "1"s".
2. Per KDB 941225 D01v03, RMC 12.2kbps setting is used to evaluate SAR. If the maximum output power and tune-up tolerance specified for production units in HSDPA / HSUPA is  $\leq \frac{1}{4}$  dB higher than RMC 12.2Kbps or when the highest reported SAR of the RMC12.2Kbps is scaled by the ratio of specified maximum output power and tune-up tolerance of HSDPA / HSUPA to RMC12.2Kbps and the adjusted SAR is  $\leq 1.2$  W/kg, SAR measurement is not required for HSDPA / HSUPA.

**SIM 1:**

Band			WCDMA Band V			WCDMA Band II			WCDMA Band IV		
TX Channel			4132	4182	4233	9262	9400	9538	1312	1413	1513
Rx Channel			4357	4407	4458	9662	9800	9938	1537	1638	1738
Frequency (MHz)			826.4	836.4	846.6	1852.4	1880	1907.6	1712.4	1732.6	1752.6
MPR (dB)	3GPP Rel 99	AMR 12.2Kbps	21.32	21.78	21.01	21.40	21.52	21.56	21.50	21.62	21.52
	3GPP Rel 99	RMC 12.2Kbps	21.34	21.79	21.03	21.41	21.54	21.57	21.51	21.64	21.53
0	3GPP Rel 6	HSDPA Subtest-1	20.22	20.57	19.79	20.13	20.36	20.19	20.08	20.30	20.26
0	3GPP Rel 6	HSDPA Subtest-2	20.23	20.55	19.78	20.10	20.34	20.19	20.10	20.28	20.28
0.5	3GPP Rel 6	HSDPA Subtest-3	19.78	20.08	19.33	19.65	19.88	19.70	19.65	19.86	19.80
0.5	3GPP Rel 6	HSDPA Subtest-4	19.77	20.10	19.31	19.65	19.85	19.68	19.62	19.83	19.78
0	3GPP Rel 6	HSUPA Subtest-1	18.28	18.51	17.82	18.17	18.40	18.31	18.04	18.33	18.26
2	3GPP Rel 6	HSUPA Subtest-2	18.25	18.52	17.31	18.15	18.37	18.27	18.08	18.32	18.26
1	3GPP Rel 6	HSUPA Subtest-3	19.25	19.50	18.79	19.15	19.35	19.28	19.07	19.31	19.27
2	3GPP Rel 6	HSUPA Subtest-4	17.70	18.02	17.25	17.63	17.83	17.72	17.52	17.74	17.67
0	3GPP Rel 6	HSUPA Subtest-5	20.30	20.40	19.80	20.10	20.30	20.30	20.10	20.30	20.20

**SIM 2:**

Band			WCDMA Band V			WCDMA Band II			WCDMA Band IV		
TX Channel			4132	4182	4233	9262	9400	9538	1312	1413	1513
Rx Channel			4357	4407	4458	9662	9800	9938	1537	1638	1738
Frequency (MHz)			826.4	836.4	846.6	1852.4	1880	1907.6	1712.4	1732.6	1752.6
MPR (dB)	3GPP Rel 99	AMR 12.2Kbps	21.30	21.75	21.00	21.38	21.50	21.53	21.48	21.60	21.50
	3GPP Rel 99	RMC 12.2Kbps	21.32	21.76	21.01	21.39	21.52	21.54	21.50	21.62	21.51
0	3GPP Rel 6	HSDPA Subtest-1	20.08	20.50	19.61	20.05	20.27	20.13	20.01	20.24	20.20
0	3GPP Rel 6	HSDPA Subtest-2	20.09	20.51	19.67	20.05	20.26	20.10	20.03	20.24	20.19
0.5	3GPP Rel 6	HSDPA Subtest-3	19.64	20.03	19.20	19.58	19.79	19.62	19.57	19.79	19.72
0.5	3GPP Rel 6	HSDPA Subtest-4	19.63	20.02	19.17	19.56	19.76	19.62	19.54	19.77	19.73
0	3GPP Rel 6	HSUPA Subtest-1	18.27	18.64	17.89	18.24	18.51	18.39	18.27	18.41	18.39
2	3GPP Rel 6	HSUPA Subtest-2	18.23	18.63	17.37	18.25	18.44	18.38	18.26	18.39	18.42
1	3GPP Rel 6	HSUPA Subtest-3	19.27	19.64	18.84	19.22	19.45	19.34	19.26	19.39	19.42
2	3GPP Rel 6	HSUPA Subtest-4	17.71	18.10	17.32	17.66	17.91	17.79	17.70	17.81	17.86
0	3GPP Rel 6	HSUPA Subtest-5	20.30	20.60	19.90	20.20	20.50	20.30	20.20	20.30	20.40

**<WLAN Conducted Power>****General Note:**

1. Per KDB 248227 D01v02r01, SAR test reduction is determined according to 802.11 transmission mode configurations and certain exposure conditions with multiple test positions. In the 2.4 GHz band, separate SAR procedures are applied to DSSS and OFDM configurations to simplify DSSS test requirements. For OFDM, in both 2.4 and 5 GHz bands, an initial test configuration must be determined for each standalone and aggregated frequency band, according to the transmission mode configuration with the highest maximum output power specified for production units to perform SAR measurements. If the same highest maximum output power applies to different combinations of channel bandwidths, modulations and data rates, additional procedures are applied to determine which test configurations require SAR measurement. When applicable, an initial test position may be applied to reduce the number of SAR measurements required for next to the ear, UMPC mini-tablet or hotspot mode configurations with multiple test positions.
2. For 2.4 GHz 802.11b DSSS, either the initial test position procedure for multiple exposure test positions or the DSSS procedure for fixed exposure position is applied; these are mutually exclusive. For 2.4 GHz and 5 GHz OFDM configurations, the initial test configuration is applied to measure SAR using either the initial test position procedure for multiple exposure test position configurations or the initial test configuration procedures for fixed exposure test conditions. Based on the reported SAR of the measured configurations and maximum output power of the transmission mode configurations that are not included in the initial test configuration, the subsequent test configuration and initial test position procedures are applied to determine if SAR measurements are required for the remaining OFDM transmission configurations. In general, the number of test channels that require SAR measurement is minimized based on maximum output power measured for the test sample(s).
3. For OFDM transmission configurations in the 2.4 GHz and 5 GHz bands, When the same maximum power is specified for multiple transmission modes in a frequency band, the largest channel bandwidth, lowest order modulation, lowest data rate and lowest order 802.11a/g/n/ac mode is used for SAR measurement, on the highest measured output power channel for each frequency band.
4. DSSS and OFDM configurations are considered separately according to the required SAR procedures. SAR is measured in the initial test position using the 802.11 transmission mode configuration required by the DSSS procedure or initial test configuration and subsequent test configuration(s) according to the OFDM procedures.18 The initial test position procedure is described in the following:
  - a. When the reported SAR of the initial test position is  $\leq 0.4$  W/kg, further SAR measurement is not required for the other test positions in that exposure configuration and 802.11 transmission mode combinations within the frequency band or aggregated band.
  - b. When the reported SAR of the test position is  $> 0.4$  W/kg, SAR is repeated for the 802.11 transmission mode configuration tested in the initial test position to measure the subsequent next closet/smallest test separation distance and maximum coupling test position on the highest maximum output power channel, until the report SAR is  $\leq 0.8$  W/kg or all required test position are tested.
  - c. For all positions/configurations, when the reported SAR is  $> 0.8$  W/kg, SAR is measured for these test positions/configurations on the subsequent next highest measured output power channel(s) until the reported SAR is  $\leq 1.2$  W/kg or all required channels are tested.

<2.4GHz WLAN>

	Mode	Channel	Frequency (MHz)	Data Rate	Average power (dBm)	Duty Cycle %
2.4GHz WLAN	802.11b	CH 1	2412	1Mbps	15.31	98.25
		CH 6	2437		15.24	
		CH 11	2462		15.15	
	802.11g	CH 1	2412	6Mbps	10.35	88.21
		CH 6	2437		10.59	
		CH 11	2462		10.56	
	802.11n-HT20	CH 1	2412	MCS0	10.31	87.72
		CH 6	2437		10.52	
		CH 11	2462		10.46	
	802.11n-HT40	CH 3	2422	MCS0	9.20	79.08
		CH 6	2437		9.39	
		CH 9	2452		9.17	

### 13. Bluetooth Exclusions Applied

Mode Band	Average power(dBm)	
	Bluetooth v3.0+EDR	Bluetooth v4.0 LE
2.4GHz Bluetooth	4.50	-4.00

**Note:**

1. Per KDB 447498 D01v05r02, the 1-g and 10-g SAR test exclusion thresholds for 100 MHz to 6 GHz at *test separation distances* ≤ 50 mm are determined by:

$[(\text{max. power of channel, including tune-up tolerance, mW}) / (\text{min. test separation distance, mm})] \cdot [\sqrt{f(\text{GHz})}] \leq 3.0$  for 1-g SAR and ≤ 7.5 for 10-g extremity SAR

- f(GHz) is the RF channel transmit frequency in GHz
- Power and distance are rounded to the nearest mW and mm before calculation
- The result is rounded to one decimal place for comparison

Bluetooth Max Power (dBm)	Separation Distance (mm)	Frequency (GHz)	exclusion thresholds
4.50	< 5	2.48	0.9

**Note:**

Per KDB 447498 D01v05r02, when the minimum test separation distance is < 5 mm, a distance of 5 mm is applied to determine SAR test exclusion. The test exclusion threshold is 0.9 which is ≤ 3, SAR testing is not required.

### 14. Antenna Location

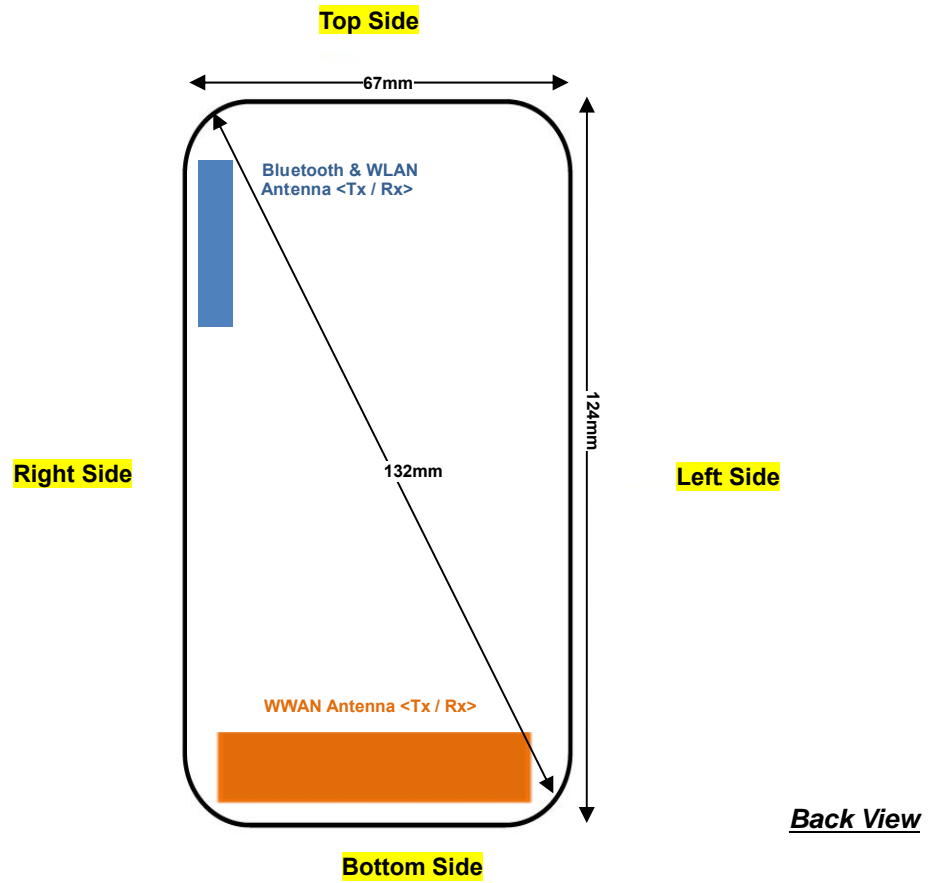

Distance of the Antenna to the EUT surface/edge						
Antennas	Back	Front	Top Side	Bottom Side	Right Side	Left Side
WWAN	≤ 25mm	≤ 25mm	106mm	≤ 25mm	≤ 25mm	≤ 25mm
BT&WLAN	≤ 25mm	≤ 25mm	≤ 25mm	86mm	≤ 25mm	58mm

Positions for SAR tests; Hotspot mode						
Antennas	Back	Front	Top Side	Bottom Side	Right Side	Left Side
WWAN	Yes	Yes	No	Yes	Yes	Yes
BT&WLAN	Yes	Yes	Yes	No	Yes	No

**General Note:**

Referring to KDB 941225 D06 v02, when the overall device length and width are ≥ 9cm\*5cm, the test distance is 10 mm. SAR must be measured for all sides and surfaces with a transmitting antenna located within 25mm from that surface or edge



## **15. SAR Test Results**

### **General Note:**

1. Per KDB 447498 D01v05r02, the reported SAR is the measured SAR value adjusted for maximum tune-up tolerance.
  - a. Tune-up scaling Factor = tune-up limit power (mW) / EUT RF power (mW), where tune-up limit is the maximum rated power among all production units.
  - b. For SAR testing of WLAN signal with non-100% duty cycle, the measured SAR is scaled-up by the duty cycle scaling factor which is equal to "1/(duty cycle)"
  - c. For WWAN: Reported SAR(W/kg)= Measured SAR(W/kg)\*Tune-up Scaling Factor
  - d. For WLAN: Reported SAR(W/kg)= Measured SAR(W/kg)\* Duty Cycle scaling factor \* Tune-up scaling factor
2. Per KDB 447498 D01v05r02, for each exposure position, testing of other required channels within the operating mode of a frequency band is not required when the *reported* 1-g or 10-g SAR for the mid-band or highest output power channel is:
  - $\leq 0.8$  W/kg or 2.0 W/kg, for 1-g or 10-g respectively, when the transmission band is  $\leq 100$  MHz
  - $\leq 0.6$  W/kg or 1.5 W/kg, for 1-g or 10-g respectively, when the transmission band is between 100 MHz and 200 MHz
  - $\leq 0.4$  W/kg or 1.0 W/kg, for 1-g or 10-g respectively, when the transmission band is  $\geq 200$  MHz

### **GSM Note:**

1. Per KDB 941225 D01v03, considering the possibility of e.g. 3rd party VoIP operation for Head and body-worn SAR test reduction for GSM and GPRS modes is determined by the source-based time-averaged output power including tune-up tolerance. The mode with highest specified time-averaged output power should be tested for SAR compliance in the applicable exposure conditions. For modes with the same specified maximum output power and tolerance, the higher number time-slot configuration should be tested. Therefore, the EUT was set in GPRS (2Tx slots) for GSM850/GSM1900.
2. Per KDB 941225 D01v03, for Hotspot SAR test reduction for GPRS modes is determined by the source-based time-averaged output power including tune-up tolerance, for modes with the same specified maximum output power and tolerance, the higher number time-slot configuration should be tested, therefore, the EUT was set in GPRS (2Tx slots) for GSM850/GSM1900.
3. Per KDB 648474 D04v01r02, when the reported SAR for a body-worn accessory measured without a headset connected to the handset is  $\leq 1.2$  W/kg, SAR testing with a headset connected to the handset is not required.

### **UMTS Note:**

1. Per KDB 941225 D01v03, SAR for Head / Hotspot / Body-worn exposure is measured using a 12.2 kbps RMC with TPC bits configured to all "1's".
2. Per KDB 941225 D01v03, RMC 12.2kbps setting is used to evaluate SAR. If the maximum output power and tune-up tolerance specified for production units in HSDPA / HSUPA is  $\leq \frac{1}{4}$  dB higher than RMC 12.2Kbps or when the highest reported SAR of the RMC12.2Kbps is scaled by the ratio of specified maximum output power and tune-up tolerance of HSDPA / HSUPA to RMC12.2Kbps and the adjusted SAR is  $\leq 1.2$  W/kg, SAR measurement is not required for HSDPA / HSUPA.

### **WLAN Note:**

1. Per KDB 248227 D01v02r01, for 2.4GHz 802.11g/n SAR testing is not required when the highest reported SAR for DSSS is adjusted by the ratio of OFDM to DSSS specified maximum output power and the adjusted SAR is  $\leq 1.2$  W/kg.
2. When the reported SAR of the test position is  $> 0.4$  W/kg, SAR is repeated for the 802.11 transmission mode configuration tested in the initial test position to measure the subsequent next closet/smallest test separation distance and maximum coupling test position on the highest maximum output power channel, until the report SAR is  $\leq 0.8$  W/kg or all required test position are tested.
3. For all positions / configurations, when the reported SAR is  $> 0.8$  W/kg, SAR is measured for these test positions / configurations on the subsequent next highest measured output power channel(s) until the reported SAR is  $\leq 1.2$  W/kg or all required channels are tested.



**15.1 Head SAR**

**<GSM SAR>**

Plot No.	Band	Mode	Test Position	Ch.	Freq. (MHz)	Average Power (dBm)	Tune-Up Limit (dBm)	Tune-up Scaling Factor	Power Drift (dB)	Measured 1g SAR (W/kg)	Reported 1g SAR (W/kg)
	GSM850	GPRS(2 Tx slots)	Right Cheek	251	848.8	29.42	30.00	1.143	0.09	0.273	0.312
	GSM850	GPRS(2 Tx slots)	Right Tilted	251	848.8	29.42	30.00	1.143	0.01	0.188	0.215
	GSM850	GPRS(2 Tx slots)	Left Cheek	251	848.8	29.42	30.00	1.143	0.03	0.278	0.318
	GSM850	GPRS(2 Tx slots)	Left Tilted	251	848.8	29.42	30.00	1.143	0.04	0.162	0.185
#01	GSM850	GPRS(2 Tx slots)	Left Cheek	128	824.2	29.25	30.00	1.189	0.09	0.298	0.354
	GSM850	GPRS(2 Tx slots)	Left Cheek	189	836.4	29.30	30.00	1.175	0.01	0.292	0.343
	GSM1900	GPRS(2 Tx slots)	Right Cheek	512	1850.2	28.13	28.50	1.089	-0.01	0.182	0.198
	GSM1900	GPRS(2 Tx slots)	Right Tilted	512	1850.2	28.13	28.50	1.089	-0.04	0.129	0.140
	GSM1900	GPRS(2 Tx slots)	Left Cheek	512	1850.2	28.13	28.50	1.089	-0.11	0.157	0.171
	GSM1900	GPRS(2 Tx slots)	Left Tilted	512	1850.2	28.13	28.50	1.089	-0.06	0.117	0.127
	GSM1900	GPRS(2 Tx slots)	Right Cheek	661	1880	27.70	28.50	1.202	0.06	0.21	0.252
#02	GSM1900	GPRS(2 Tx slots)	Right Cheek	810	1909.8	27.46	28.50	1.271	-0.04	0.225	0.286

**<WCDMA SAR>**

Plot No.	Band	Mode	Test Position	Ch.	Freq. (MHz)	Average Power (dBm)	Tune-Up Limit (dBm)	Tune-up Scaling Factor	Power Drift (dB)	Measured 1g SAR (W/kg)	Reported 1g SAR (W/kg)
	WCDMA Band V	RMC 12.2Kbps	Right Cheek	4182	836.4	21.79	22.00	1.050	0.02	0.309	0.324
	WCDMA Band V	RMC 12.2Kbps	Right Tilted	4182	836.4	21.79	22.00	1.050	0.02	0.220	0.231
	WCDMA Band V	RMC 12.2Kbps	Left Cheek	4182	836.4	21.79	22.00	1.050	0.03	0.300	0.315
	WCDMA Band V	RMC 12.2Kbps	Left Tilted	4182	836.4	21.79	22.00	1.050	0.02	0.181	0.190
	WCDMA Band V	RMC 12.2Kbps	Right Cheek	4132	826.4	21.34	22.00	1.164	0.09	0.333	0.388
#03	WCDMA Band V	RMC 12.2Kbps	Right Cheek	4233	846.6	21.03	22.00	1.250	0.02	0.390	0.488
	WCDMA Band IV	RMC 12.2Kbps	Right Cheek	1413	1732.6	21.64	22.00	1.086	-0.05	0.174	0.189
	WCDMA Band IV	RMC 12.2Kbps	Right Tilted	1413	1732.6	21.64	22.00	1.086	-0.03	0.094	0.102
	WCDMA Band IV	RMC 12.2Kbps	Left Cheek	1413	1732.6	21.64	22.00	1.086	-0.07	0.151	0.164
	WCDMA Band IV	RMC 12.2Kbps	Left Tilted	1413	1732.6	21.64	22.00	1.086	-0.01	0.092	0.100
	WCDMA Band IV	RMC 12.2Kbps	Right Cheek	1312	1712.4	21.51	22.00	1.119	-0.04	0.188	0.210
#04	WCDMA Band IV	RMC 12.2Kbps	Right Cheek	1513	1752.6	21.53	22.00	1.114	-0.03	0.214	0.238
	WCDMA Band II	RMC 12.2Kbps	Right Cheek	9538	1907.6	21.57	22.00	1.104	0.09	0.432	0.477
	WCDMA Band II	RMC 12.2Kbps	Right Tilted	9538	1907.6	21.57	22.00	1.104	0.06	0.315	0.348
#05	WCDMA Band II	RMC 12.2Kbps	Left Cheek	9538	1907.6	21.57	22.00	1.104	-0.01	0.491	0.542
	WCDMA Band II	RMC 12.2Kbps	Left Tilted	9538	1907.6	21.57	22.00	1.104	-0.07	0.277	0.306
	WCDMA Band II	RMC 12.2Kbps	Left Cheek	9262	1852.4	21.41	22.00	1.146	0.04	0.366	0.419
	WCDMA Band II	RMC 12.2Kbps	Left Cheek	9400	1880	21.54	22.00	1.112	0.01	0.457	0.508

**<WLAN SAR>**

Plot No.	Band	Mode	Test Position	Ch.	Freq. (MHz)	Average Power (dBm)	Tune-Up Limit (dBm)	Tune-up Scaling Factor	Duty Cycle %	Duty Cycle Scaling Factor	Power Drift (dB)	Measured 1g SAR (W/kg)	Reported 1g SAR (W/kg)
	WLAN2.4GHz	802.11b 1Mbps	Right Cheek	1	2412	15.31	16.00	1.173	98.25	1.018	0.09	0.476	0.568
	WLAN2.4GHz	802.11b 1Mbps	Right Tilted	1	2412	15.31	16.00	1.173	98.25	1.018	0.04	0.45	0.537
	WLAN2.4GHz	802.11b 1Mbps	Left Cheek	1	2412	15.31	16.00	1.173	98.25	1.018	0.06	0.792	0.946
	WLAN2.4GHz	802.11b 1Mbps	Left Tilted	1	2412	15.31	16.00	1.173	98.25	1.018	0.03	0.534	0.638
	WLAN2.4GHz	802.11b 1Mbps	Left Cheek	6	2437	15.24	16.00	1.192	98.25	1.018	0.04	0.961	1.166
#06	WLAN2.4GHz	802.11b 1Mbps	Left Cheek	11	2462	15.15	16.00	1.217	98.25	1.018	0.18	0.954	1.182

**15.2 Hotspot SAR**

Distance of the Antenna to the EUT surface/edge						
Antennas	Back	Front	Top Side	Bottom Side	Right Side	Left Side
WWAN	≤ 25mm	≤ 25mm	106mm	≤ 25mm	≤ 25mm	≤ 25mm
BT&WLAN	≤ 25mm	≤ 25mm	≤ 25mm	86mm	≤ 25mm	58mm

Positions for SAR tests; Hotspot mode						
Antennas	Back	Front	Top Side	Bottom Side	Right Side	Left Side
WWAN	Yes	Yes	No	Yes	Yes	Yes
BT&WLAN	Yes	Yes	Yes	No	Yes	No

**General Note:**

Referring to KDB 941225 D06 v02, when the overall device length and width are  $\geq 9\text{cm} \times 5\text{cm}$ , the test distance is 10 mm. SAR must be measured for all sides and surfaces with a transmitting antenna located within 25mm from that surface or edge

**<GSM SAR>**

Plot No.	Band	Mode	Test Position	Gap (cm)	Ch.	Freq. (MHz)	Average Power (dBm)	Tune-Up Limit (dBm)	Tune-up Scaling Factor	Power Drift (dB)	Measured 1g SAR (W/kg)	Reported 1g SAR (W/kg)
	GSM850	GPRS(2 Tx slots)	Front	1	251	848.8	29.42	30.00	1.143	-0.07	0.366	0.418
	GSM850	GPRS(2 Tx slots)	Back	1	251	848.8	29.42	30.00	1.143	-0.02	0.559	0.639
	GSM850	GPRS(2 Tx slots)	Left Side	1	251	848.8	29.42	30.00	1.143	-0.09	0.346	0.395
	GSM850	GPRS(2 Tx slots)	Right Side	1	251	848.8	29.42	30.00	1.143	-0.02	0.318	0.363
	GSM850	GPRS(2 Tx slots)	Bottom Side	1	251	848.8	29.42	30.00	1.143	-0.05	0.112	0.128
#07	GSM850	GPRS(2 Tx slots)	Back	1	128	824.2	29.25	30.00	1.189	-0.08	0.614	0.730
	GSM850	GPRS(2 Tx slots)	Back	1	189	836.4	29.30	30.00	1.175	-0.08	0.59	0.693
	GSM1900	GPRS(2 Tx slots)	Front	1	512	1850.2	28.13	28.50	1.089	-0.01	0.226	0.246
	GSM1900	GPRS(2 Tx slots)	Back	1	512	1850.2	28.13	28.50	1.089	-0.04	0.447	0.487
	GSM1900	GPRS(2 Tx slots)	Left Side	1	512	1850.2	28.13	28.50	1.089	-0.01	0.063	0.069
	GSM1900	GPRS(2 Tx slots)	Right Side	1	512	1850.2	28.13	28.50	1.089	-0.07	0.00466	0.005
	GSM1900	GPRS(2 Tx slots)	Bottom Side	1	512	1850.2	28.13	28.50	1.089	-0.07	0.073	0.079
	GSM1900	GPRS(2 Tx slots)	Back	1	661	1880	27.70	28.50	1.202	-0.09	0.379	0.456
#08	GSM1900	GPRS(2 Tx slots)	Back	1	810	1909.8	27.46	28.50	1.271	-0.06	0.552	0.701





<WCDMA SAR>

Plot No.	Band	Mode	Test Position	Gap (cm)	Ch.	Freq. (MHz)	Average Power (dBm)	Tune-Up Limit (dBm)	Tune-up Scaling Factor	Power Drift (dB)	Measured 1g SAR (W/kg)	Reported 1g SAR (W/kg)
	WCDMA Band V	RMC 12.2Kbps	Front	1	4182	836.4	21.79	22.00	1.050	-0.04	0.423	0.444
	WCDMA Band V	RMC 12.2Kbps	Back	1	4182	836.4	21.79	22.00	1.050	-0.06	0.761	0.799
	WCDMA Band V	RMC 12.2Kbps	Left Side	1	4182	836.4	21.79	22.00	1.050	-0.09	0.449	0.471
	WCDMA Band V	RMC 12.2Kbps	Right Side	1	4182	836.4	21.79	22.00	1.050	-0.02	0.384	0.403
	WCDMA Band V	RMC 12.2Kbps	Bottom Side	1	4182	836.4	21.79	22.00	1.050	-0.07	0.126	0.132
#09	WCDMA Band V	RMC 12.2Kbps	Back	1	4132	826.4	21.34	22.00	1.164	-0.18	0.886	1.031
	WCDMA Band V	RMC 12.2Kbps	Back	1	4233	846.6	21.03	22.00	1.250	-0.07	0.793	0.991
	WCDMA Band IV	RMC 12.2Kbps	Front	1	1413	1732.6	21.64	22.00	1.086	-0.01	0.184	0.200
	WCDMA Band IV	RMC 12.2Kbps	Back	1	1413	1732.6	21.64	22.00	1.086	-0.05	0.399	0.433
	WCDMA Band IV	RMC 12.2Kbps	Left Side	1	1413	1732.6	21.64	22.00	1.086	-0.01	0.056	0.061
	WCDMA Band IV	RMC 12.2Kbps	Right Side	1	1413	1732.6	21.64	22.00	1.086	-0.02	0.00141	0.002
	WCDMA Band IV	RMC 12.2Kbps	Bottom Side	1	1413	1732.6	21.64	22.00	1.086	-0.06	0.039	0.042
	WCDMA Band IV	RMC 12.2Kbps	Back	1	1312	1712.4	21.51	22.00	1.119	-0.02	0.389	0.435
#10	WCDMA Band IV	RMC 12.2Kbps	Back	1	1513	1752.6	21.53	22.00	1.114	-0.03	0.477	0.532
	WCDMA Band II	RMC 12.2Kbps	Front	1	9538	1907.6	21.57	22.00	1.104	-0.16	0.506	0.559
	WCDMA Band II	RMC 12.2Kbps	Back	1	9538	1907.6	21.57	22.00	1.104	-0.09	0.734	0.810
	WCDMA Band II	RMC 12.2Kbps	Left Side	1	9538	1907.6	21.57	22.00	1.104	-0.08	0.142	0.157
	WCDMA Band II	RMC 12.2Kbps	Right Side	1	9538	1907.6	21.57	22.00	1.104	-0.03	0.206	0.227
	WCDMA Band II	RMC 12.2Kbps	Bottom Side	1	9538	1907.6	21.57	22.00	1.104	-0.05	0.217	0.240
	WCDMA Band II	RMC 12.2Kbps	Back	1	9262	1852.4	21.41	22.00	1.146	-0.02	0.745	0.853
#11	WCDMA Band II	RMC 12.2Kbps	Back	1	9400	1880	21.54	22.00	1.112	-0.03	0.853	0.948

<WLAN SAR>

Plot No.	Band	Mode	Test Position	Gap (cm)	Ch.	Freq. (MHz)	Average Power (dBm)	Tune-Up Limit (dBm)	Tune-up Scaling Factor	Duty Cycle %	Duty Cycle Scaling Factor	Power Drift (dB)	Measured 1g SAR (W/kg)	Reported 1g SAR (W/kg)
	WLAN2.4GHz	802.11b 1Mbps	Front	1	1	2412	15.31	16.00	1.173	98.25	1.018	-0.06	0.164	0.196
	WLAN2.4GHz	802.11b 1Mbps	Back	1	1	2412	15.31	16.00	1.173	98.25	1.018	-0.18	0.496	0.592
	WLAN2.4GHz	802.11b 1Mbps	Right Side	1	1	2412	15.31	16.00	1.173	98.25	1.018	-0.07	0.325	0.388
	WLAN2.4GHz	802.11b 1Mbps	Top Side	1	1	2412	15.31	16.00	1.173	98.25	1.018	-0.08	0.199	0.238
#12	WLAN2.4GHz	802.11b 1Mbps	Back	1	6	2437	15.24	16.00	1.192	98.25	1.018	-0.02	0.526	0.638
	WLAN2.4GHz	802.11b 1Mbps	Back	1	11	2462	15.15	16.00	1.217	98.25	1.018	-0.03	0.498	0.617



**15.3 Body Worn Accessory SAR**

**<GSM SAR>**

Plot No.	Band	Mode	Test Position	Gap (cm)	Ch.	Freq. (MHz)	Average Power (dBm)	Tune-Up Limit (dBm)	Tune-up Scaling Factor	Power Drift (dB)	Measured 1g SAR (W/kg)	Reported 1g SAR (W/kg)
	GSM850	GPRS(2 Tx slots)	Front	1	251	848.8	29.42	30.00	1.143	-0.07	0.366	0.418
	GSM850	GPRS(2 Tx slots)	Back	1	251	848.8	29.42	30.00	1.143	-0.02	0.559	0.639
#07	GSM850	GPRS(2 Tx slots)	Back	1	128	824.2	29.25	30.00	1.189	-0.08	0.614	0.730
	GSM850	GPRS(2 Tx slots)	Back	1	189	836.4	29.30	30.00	1.175	-0.08	0.59	0.693
	GSM1900	GPRS(2 Tx slots)	Front	1	512	1850.2	28.13	28.50	1.089	-0.01	0.226	0.246
	GSM1900	GPRS(2 Tx slots)	Back	1	512	1850.2	28.13	28.50	1.089	-0.04	0.447	0.487
	GSM1900	GPRS(2 Tx slots)	Back	1	661	1880	27.70	28.50	1.202	-0.09	0.379	0.456
#08	GSM1900	GPRS(2 Tx slots)	Back	1	810	1909.8	27.46	28.50	1.271	-0.06	0.552	0.701

**<WCDMA SAR>**

Plot No.	Band	Mode	Test Position	Gap (cm)	Ch.	Freq. (MHz)	Average Power (dBm)	Tune-Up Limit (dBm)	Tune-up Scaling Factor	Power Drift (dB)	Measured 1g SAR (W/kg)	Reported 1g SAR (W/kg)
	WCDMA Band V	RMC 12.2Kbps	Front	1	4182	836.4	21.79	22.00	1.050	-0.04	0.423	0.444
	WCDMA Band V	RMC 12.2Kbps	Back	1	4182	836.4	21.79	22.00	1.050	-0.06	0.761	0.799
#09	WCDMA Band V	RMC 12.2Kbps	Back	1	4132	826.4	21.34	22.00	1.164	-0.18	0.886	1.031
	WCDMA Band V	RMC 12.2Kbps	Back	1	4233	846.6	21.03	22.00	1.250	-0.07	0.793	0.991
	WCDMA Band IV	RMC 12.2Kbps	Front	1	1413	1732.6	21.64	22.00	1.086	-0.01	0.184	0.200
	WCDMA Band IV	RMC 12.2Kbps	Back	1	1413	1732.6	21.64	22.00	1.086	-0.05	0.399	0.433
	WCDMA Band IV	RMC 12.2Kbps	Back	1	1312	1712.4	21.51	22.00	1.119	-0.02	0.389	0.435
#10	WCDMA Band IV	RMC 12.2Kbps	Back	1	1513	1752.6	21.53	22.00	1.114	-0.03	0.477	0.532
	WCDMA Band II	RMC 12.2Kbps	Front	1	9538	1907.6	21.57	22.00	1.104	-0.16	0.506	0.559
	WCDMA Band II	RMC 12.2Kbps	Back	1	9538	1907.6	21.57	22.00	1.104	-0.09	0.734	0.810
	WCDMA Band II	RMC 12.2Kbps	Back	1	9262	1852.4	21.41	22.00	1.146	-0.02	0.745	0.853
#11	WCDMA Band II	RMC 12.2Kbps	Back	1	9400	1880	21.54	22.00	1.112	-0.03	0.853	0.948

**<WLAN SAR>**

Plot No.	Band	Mode	Test Position	Gap (cm)	Ch.	Freq. (MHz)	Average Power (dBm)	Tune-Up Limit (dBm)	Tune-up Scaling Factor	Duty Cycle %	Duty Cycle Scaling Factor	Power Drift (dB)	Measured 1g SAR (W/kg)	Reported 1g SAR (W/kg)
	WLAN2.4GHz	802.11b 1Mbps	Front	1	1	2412	15.31	16.00	1.173	98.25	1.018	-0.06	0.164	0.196
	WLAN2.4GHz	802.11b 1Mbps	Back	1	1	2412	15.31	16.00	1.173	98.25	1.018	-0.18	0.496	0.592
#12	WLAN2.4GHz	802.11b 1Mbps	Back	1	6	2437	15.24	16.00	1.192	98.25	1.018	-0.02	0.526	0.638
	WLAN2.4GHz	802.11b 1Mbps	Back	1	11	2462	15.15	16.00	1.217	98.25	1.018	-0.03	0.498	0.617

**15.4 Repeated SAR Measurement**

No.	Band	Mode	Test Position	Gap (cm)	Ch.	Freq. (MHz)	Average Power (dBm)	Tune-Up Limit (dBm)	Tune-up Scaling Factor	Duty Cycle %	Duty Cycle Scaling Factor	Power Drift (dB)	Measured 1g SAR (W/kg)	Ratio	Reported 1g SAR (W/kg)
1st	WLAN2.4GHz	802.11b 1Mbps	Left Cheek	0	6	2437	15.24	16.00	1.192	98.25	1.018	0.04	0.961	1	1.166
2nd	WLAN2.4GHz	802.11b 1Mbps	Left Cheek	0	6	2437	15.24	16.00	1.192	98.25	1.018	0.07	0.952	1.009	1.155
1st	WCDMA Band V	RMC 12.2Kbps	Back	1	4132	826.4	21.34	22.00	1.164	-	1.000	-0.18	0.886	1	1.031
2nd	WCDMA Band V	RMC 12.2Kbps	Back	1	4132	826.4	21.34	22.00	1.164	-	1.000	-0.09	0.884	1.002	1.029
1st	WCDMA Band II	RMC 12.2Kbps	Back	1	9400	1880	21.54	22.00	1.112	-	1.000	-0.03	0.853	1	0.948
2nd	WCDMA Band II	RMC 12.2Kbps	Back	1	9400	1880	21.54	22.00	1.112	-	1.000	0.01	0.826	1.033	0.918

**General Note:**

1. Per KDB 865664 D01v01r04, for each frequency band, repeated SAR measurement is required only when the measured SAR is  $\geq 0.8W/kg$ .
2. Per KDB 865664 D01v01r04, if the ratio among the repeated measurement is  $\leq 1.2$  and the measured SAR  $< 1.45W/kg$ , only one repeated measurement is required.
3. The ratio is the difference in percentage between original and repeated *measured SAR*.
4. All measurement SAR result is scaled-up to account for tune-up tolerance and is compliant.

**16. Simultaneous Transmission Analysis**

NO.	Simultaneous Transmission Configurations	Mobile phone			Note
		Head	Body-worn	Hotspot	
1.	GSM(Voice) + WLAN2.4GHz(data)	Yes	Yes		
2.	WCDMA(Voice) + WLAN2.4GHz(data)	Yes	Yes		
3.	GSM(Voice) + Bluetooth(data)	Yes	Yes		
4.	WCDMA((Voice) + Bluetooth(data)	Yes	Yes		
5.	GPRS (Data) + WLAN2.4GHz(data)	Yes	Yes	Yes	2.4GHz Hotspot
6.	WCDMA(Data) + WLAN2.4GHz(data)	Yes	Yes	Yes	2.4GHz Hotspot
7.	GPRS (Data) + Bluetooth(data)	Yes	Yes	Yes	Bluetooth Tethering
8.	WCDMA(Data) + Bluetooth(data)	Yes	Yes	Yes	Bluetooth Tethering

**General Note:**

1. This device supported VoIP in GPRS, WCDMA (e.g. 3rd party VoIP).
2. This device 2.4GHz WLAN supports Hotspot operation.
3. WLAN and Bluetooth share the same antenna, and cannot transmit simultaneously.
4. EUT will choose each GSM and WCDMA according to the network signal condition; therefore, they will not operate simultaneously at any moment.
5. The Reported SAR summation is calculated based on the same configuration and test position.
6. Per KDB 447498 D01v05r02, simultaneous transmission SAR is compliant if,
  - i) Scalar SAR summation < 1.6W/kg.
  - ii)  $SPLSR = (SAR1 + SAR2)^{1.5} / (\text{min. separation distance, mm})$ , and the peak separation distance is determined from the square root of  $[(x1-x2)^2 + (y1-y2)^2 + (z1-z2)^2]$ , where (x1, y1, z1) and (x2, y2, z2) are the coordinates of the extrapolated peak SAR locations in the zoom scan.
  - iii) If  $SPLSR \leq 0.04$ , simultaneously transmission SAR measurement is not necessary.
  - iv) Simultaneously transmission SAR measurement, and the reported multi-band SAR < 1.6W/kg.
  - v) The SPLSR calculated results please refer to section 16.4.
7. For simultaneous transmission analysis, Bluetooth SAR is estimated per KDB 447498 D01v05r02 based on the formula below.
  - i)  $(\text{max. power of channel, including tune-up tolerance, mW}) / (\text{min. test separation distance, mm}) \cdot [\sqrt{f(\text{GHz})} / x] \text{ W/kg}$  for test separation distances  $\leq 50 \text{ mm}$ ; where  $x = 7.5$  for 1-g SAR, and  $x = 18.75$  for 10-g SAR.
  - ii) When the minimum separation distance is < 5mm, the distance is used 5mm to determine SAR test exclusion.
  - iii) 0.4 W/kg for 1-g SAR and 1.0 W/kg for 10-g SAR, when the test separation distances is > 50 mm.

Bluetooth Max Power	Exposure Position	Head	Hotspot	Body worn
	Test separation	0 mm	10 mm	10 mm
4.50 dBm	Estimated SAR (W/kg)	0.126 W/kg	0.063 W/kg	0.063 W/kg



**16.1 Head Exposure Conditions**

<WWAN + WLAN>

WWAN Band		Exposure Position	WWAN	WLAN 2.4GHz	Summed SAR (W/kg)	SPLSR	Case No
			SAR (W/kg)	SAR (W/kg)			
GSM	GSM850	Right Cheek	0.312	0.568	0.88		
		Right Tilted	0.215	0.537	0.75		
		Left Cheek	0.354	1.182	1.54		
		Left Tilted	0.185	0.638	0.82		
	GSM1900	Right Cheek	0.286	0.568	0.85		
		Right Tilted	0.140	0.537	0.68		
		Left Cheek	0.171	1.182	1.35		
		Left Tilted	0.127	0.638	0.77		
WCDMA	Band V	Right Cheek	0.488	0.568	1.06		
		Right Tilted	0.231	0.537	0.77		
		Left Cheek	0.315	1.182	1.50		
		Left Tilted	0.190	0.638	0.83		
	Band IV	Right Cheek	0.238	0.568	0.81		
		Right Tilted	0.102	0.537	0.64		
		Left Cheek	0.164	1.182	1.35		
		Left Tilted	0.100	0.638	0.74		
	Band II	Right Cheek	0.477	0.568	1.05		
		Right Tilted	0.348	0.537	0.89		
		Left Cheek	0.542	1.182	1.72	0.03	#01
		Left Tilted	0.306	0.638	0.94		



**<WWAN + Bluetooth>**

WWAN Band		Exposure Position	WWAN	Bluetooth	Summed SAR (W/kg)	SPLSR	Case No
			SAR (W/kg)	Estimated SAR (W/kg)			
GSM	GSM850	Right Cheek	0.312	0.126	0.44		
		Right Tilted	0.215	0.126	0.34		
		Left Cheek	0.354	0.126	0.48		
		Left Tilted	0.185	0.126	0.31		
	GSM1900	Right Cheek	0.286	0.126	0.41		
		Right Tilted	0.140	0.126	0.27		
		Left Cheek	0.171	0.126	0.30		
		Left Tilted	0.127	0.126	0.25		
WCDMA	Band V	Right Cheek	0.488	0.126	0.61		
		Right Tilted	0.231	0.126	0.36		
		Left Cheek	0.315	0.126	0.44		
		Left Tilted	0.190	0.126	0.32		
	Band IV	Right Cheek	0.238	0.126	0.36		
		Right Tilted	0.102	0.126	0.23		
		Left Cheek	0.164	0.126	0.29		
		Left Tilted	0.100	0.126	0.23		
	Band II	Right Cheek	0.477	0.126	0.60		
		Right Tilted	0.348	0.126	0.47		
		Left Cheek	0.542	0.126	0.67		
		Left Tilted	0.306	0.126	0.43		



**16.2 Hotspot Exposure Conditions**

**<WWAN + WLAN>**

WWAN Band		Exposure Position	WWAN	WLAN 2.4GHz	Summed SAR (W/kg)	SPLSR	Case No
			SAR (W/kg)	SAR (W/kg)			
GSM	GSM850	Front	0.418	0.196	0.61		
		Back	0.730	0.638	1.37		
		Left Side	0.395		0.40		
		Right Side	0.363	0.388	0.75		
		Top Side		0.238	0.24		
		Bottom Side	0.128		0.13		
	GSM1900	Front	0.246	0.196	0.44		
		Back	0.701	0.638	1.34		
		Left Side	0.069		0.07		
		Right Side	0.005	0.388	0.39		
		Top Side		0.238	0.24		
		Bottom Side	0.079		0.08		
WCDMA	Band V	Front	0.444	0.196	0.64		
		Back	1.031	0.638	1.67	0.03	#02
		Left Side	0.471		0.47		
		Right Side	0.403	0.388	0.79		
		Top Side		0.238	0.24		
		Bottom Side	0.132		0.13		
	Band IV	Front	0.200	0.196	0.40		
		Back	0.532	0.638	1.17		
		Left Side	0.061		0.06		
		Right Side	0.002	0.388	0.39		
		Top Side		0.238	0.24		
		Bottom Side	0.042		0.04		
	Band II	Front	0.559	0.196	0.76		
		Back	0.948	0.638	1.59		
		Left Side	0.157		0.16		
		Right Side	0.227	0.388	0.62		
		Top Side		0.238	0.24		
		Bottom Side	0.240		0.24		

**<WWAN + Bluetooth>**

WWAN Band		Exposure Position	WWAN	Bluetooth	Summed SAR (W/kg)	SPLSR	Case No
			SAR (W/kg)	Estimated SAR (W/kg)			
GSM	GSM850	Front	0.418	0.063	0.48		
		Back	0.730	0.063	0.79		
		Left Side	0.395		0.40		
		Right Side	0.363	0.063	0.43		
		Top Side		0.063	0.06		
		Bottom Side	0.128		0.13		
	GSM1900	Front	0.246	0.063	0.31		
		Back	0.701	0.063	0.76		
		Left Side	0.069		0.07		
		Right Side	0.005	0.063	0.07		
	Top Side		0.063	0.06			
	Bottom Side	0.079		0.08			
WCDMA	Band V	Front	0.444	0.063	0.51		
		Back	1.031	0.063	1.09		
		Left Side	0.471		0.47		
		Right Side	0.403	0.063	0.47		
		Top Side		0.063	0.06		
		Bottom Side	0.132		0.13		
	Band IV	Front	0.200	0.063	0.26		
		Back	0.532	0.063	0.60		
		Left Side	0.061		0.06		
		Right Side	0.002	0.063	0.07		
		Top Side		0.063	0.06		
		Bottom Side	0.042		0.04		
	Band II	Front	0.559	0.063	0.62		
		Back	0.948	0.063	1.01		
		Left Side	0.157		0.16		
		Right Side	0.227	0.063	0.29		
		Top Side		0.063	0.06		
		Bottom Side	0.240		0.24		





**16.3 Body-Worn Accessory Exposure Conditions**

**< WWAN + WLAN >**

WWAN Band		Exposure Position	WWAN	WLAN 2.4GHz	Summed SAR (W/kg)	SPLSR	Case No
			SAR (W/kg)	SAR (W/kg)			
GSM	GSM850	Front	0.418	0.196	0.61		
		Back	0.730	0.638	1.37		
	GSM1900	Front	0.246	0.196	0.44		
		Back	0.701	0.638	1.34		
WCDMA	Band V	Front	0.444	0.196	0.64		
		Back	1.031	0.638	1.67	0.03	#02
	Band IV	Front	0.200	0.196	0.40		
		Back	0.532	0.638	1.17		
	Band II	Front	0.559	0.196	0.76		
		Back	0.948	0.638	1.59		

**< WWAN + Bluetooth >**

WWAN Band		Exposure Position	WWAN	Bluetooth	Summed SAR (W/kg)	SPLSR	Case No
			SAR (W/kg)	Estimated SAR (W/kg)			
GSM	GSM850	Front	0.418	0.063	0.48		
		Back	0.730	0.063	0.79		
	GSM1900	Front	0.246	0.063	0.31		
		Back	0.701	0.063	0.76		
WCDMA	Band V	Front	0.444	0.063	0.51		
		Back	1.031	0.063	1.09		
	Band IV	Front	0.200	0.063	0.26		
		Back	0.532	0.063	0.60		
	Band II	Front	0.559	0.063	0.62		
		Back	0.948	0.063	1.01		

16.4 SPLSR Evaluation and Analysis

General Note:

$SPLSR = (SAR_1 + SAR_2)^{1.5} / (min. \text{ separation distance, mm})$ . If  $SPLSR \leq 0.04$ , simultaneously transmission SAR measurement is not necessary

Case #01	Band	Position	SAR (W/kg)	Gap (cm)	SAR peak location (m)			3D distance (mm)	Summed SAR (W/kg)	SPLSR Results	Simultaneous SAR
					X	Y	Z				
	WCDMA Band II	Left Cheek	0.542	0	0.0672	0.265	-0.173	72.3	1.72	0.03	Not required
	WLAN2.4GHz		1.182	0	0.024	0.323	-0.173				

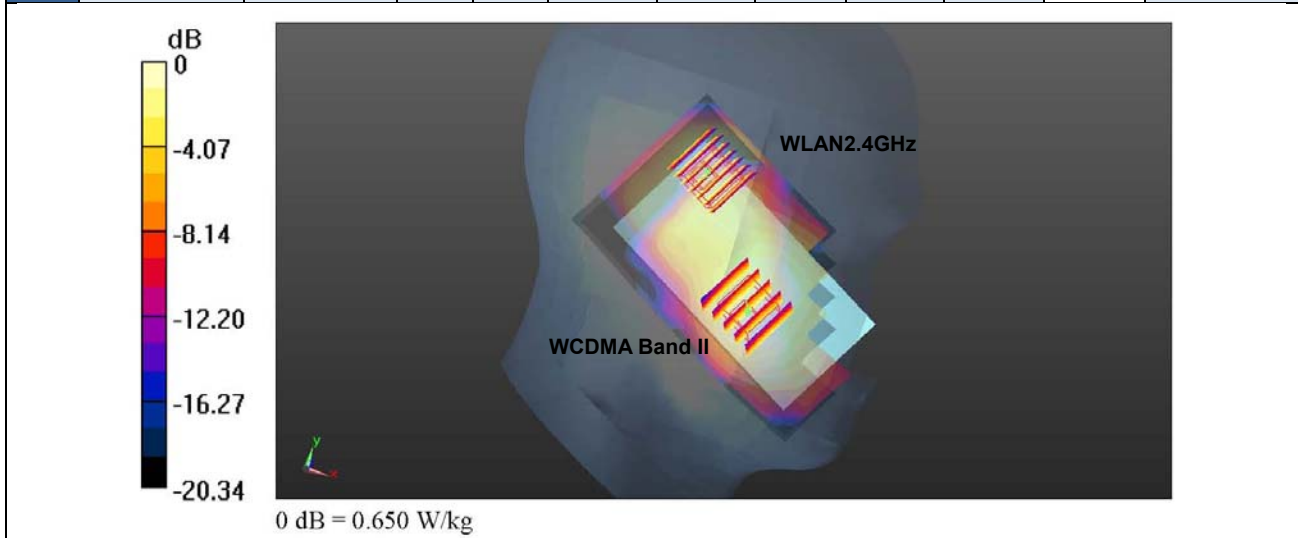

Case #02	Band	Position	SAR (W/kg)	Gap (cm)	SAR peak location (m)			3D distance (mm)	Summed SAR (W/kg)	SPLSR Results	Simultaneous SAR
					X	Y	Z				
	WCDMA Band V	Back	1.031	1	-0.0245	-0.0165	-0.206	66.3	1.67	0.03	Not required
	WLAN2.4GHz		0.638	1	-0.0442	0.0468	-0.207				

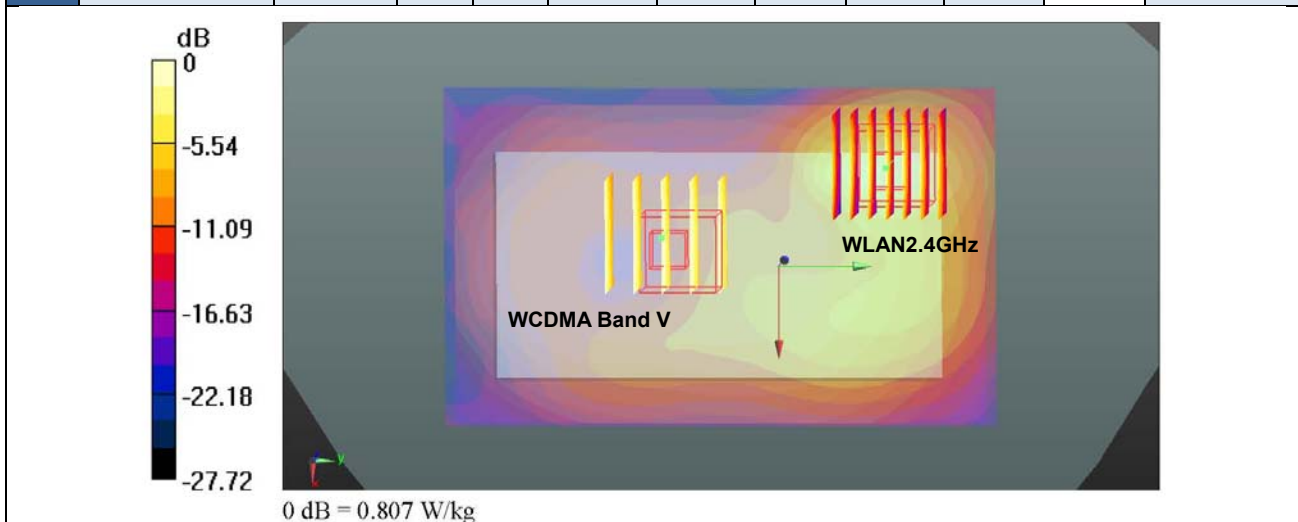

Test Engineer : Luke Lu

## 17. Uncertainty Assessment

The component of uncertainty may generally be categorized according to the methods used to evaluate them. The evaluation of uncertainty by the statistical analysis of a series of observations is termed a Type A evaluation of uncertainty. The evaluation of uncertainty by means other than the statistical analysis of a series of observation is termed a Type B evaluation of uncertainty. Each component of uncertainty, however evaluated, is represented by an estimated standard deviation, termed standard uncertainty, which is determined by the positive square root of the estimated variance.

A Type A evaluation of standard uncertainty may be based on any valid statistical method for treating data. This includes calculating the standard deviation of the mean of a series of independent observations; using the method of least squares to fit a curve to the data in order to estimate the parameter of the curve and their standard deviations; or carrying out an analysis of variance in order to identify and quantify random effects in certain kinds of measurement.

A type B evaluation of standard uncertainty is typically based on scientific judgment using all of the relevant information available. These may include previous measurement data, experience, and knowledge of the behavior and properties of relevant materials and instruments, manufacture’s specification, data provided in calibration reports and uncertainties assigned to reference data taken from handbooks. Broadly speaking, the uncertainty is either obtained from an outdoor source or obtained from an assumed distribution, such as the normal distribution, rectangular or triangular distributions indicated in table below.

Uncertainty Distributions	Normal	Rectangular	Triangular	U-Shape
Multi-plying Factor <sup>(a)</sup>	1/k <sup>(b)</sup>	1/√3	1/√6	1/√2

(a) standard uncertainty is determined as the product of the multiplying factor and the estimated range of variations in the measured quantity

(b)  $\kappa$  is the coverage factor

**Table 17.1. Standard Uncertainty for Assumed Distribution**

The combined standard uncertainty of the measurement result represents the estimated standard deviation of the result. It is obtained by combining the individual standard uncertainties of both Type A and Type B evaluation using the usual “root-sum-squares” (RSS) methods of combining standard deviations by taking the positive square root of the estimated variances.

Expanded uncertainty is a measure of uncertainty that defines an interval about the measurement result within which the measured value is confidently believed to lie. It is obtained by multiplying the combined standard uncertainty by a coverage factor. Typically, the coverage factor ranges from 2 to 3. Using a coverage factor allows the true value of a measured quantity to be specified with a defined probability within the specified uncertainty range. For purpose of this document, a coverage factor two is used, which corresponds to confidence interval of about 95 %. The DASY uncertainty Budget is shown in the following tables.

DASY Uncertainty Budget According to IEEE 1528-2013							
Error Description	Uncertainty Value (±%)	Probability	Divisor	(Ci) 1g	(Ci) 10g	Standard Uncertainty (1g) (±%)	Standard Uncertainty (10g) (±%)
<b>Measurement System</b>							
Probe Calibration	6.0	N	1	1	1	6.0	6.0
Axial Isotropy	4.7	R	1.732	0.7	0.7	1.9	1.9
Hemispherical Isotropy	9.6	R	1.732	0.7	0.7	3.9	3.9
Boundary Effects	1.0	R	1.732	1	1	0.6	0.6
Linearity	4.7	R	1.732	1	1	2.7	2.7
System Detection Limits	1.0	R	1.732	1	1	0.6	0.6
Modulation Response	3.2	R	1.732	1	1	1.8	1.8
Readout Electronics	0.3	N	1	1	1	0.3	0.3
Response Time	0.0	R	1.732	1	1	0.0	0.0
Integration Time	2.6	R	1.732	1	1	1.5	1.5
RF Ambient Noise	3.0	R	1.732	1	1	1.7	1.7
RF Ambient Reflections	3.0	R	1.732	1	1	1.7	1.7
Probe Positioner	0.4	R	1.732	1	1	0.2	0.2
Probe Positioning	2.9	R	1.732	1	1	1.7	1.7
Max. SAR Eval.	2.0	R	1.732	1	1	1.2	1.2
<b>Test Sample Related</b>							
Device Positioning	1.4	N	1	1	1	1.4	1.4
Device Holder	2.5	N	1	1	1	2.5	2.5
Power Drift	5.0	R	1.732	1	1	2.9	2.9
Power Scaling	0.0	R	1.732	1	1	0.0	0.0
<b>Phantom and Setup</b>							
Phantom Uncertainty	6.1	R	1.732	1	1	3.5	3.5
SAR correction	0.0	R	1.732	1	0.84	0.0	0.0
Liquid Conductivity Repeatability	0.2	N	1	0.78	0.71	0.1	0.1
Liquid Conductivity (target)	5.0	R	1.732	0.78	0.71	2.3	2.0
Liquid Conductivity (mea.)	2.5	R	1.732	0.78	0.71	1.1	1.0
Temp. unc. - Conductivity	3.4	R	1.732	0.78	0.71	1.5	1.4
Liquid Permittivity Repeatability	0.15	N	1	0.23	0.26	0.0	0.0
Liquid Permittivity (target)	5.0	R	1.732	0.23	0.26	0.7	0.8
Liquid Permittivity (mea.)	2.5	R	1.732	0.23	0.26	0.3	0.4
Temp. unc. - Permittivity	0.83	R	1.732	0.23	0.26	0.1	0.1
<b>Combined Std. Uncertainty</b>						10.8%	10.7%
<b>Coverage Factor for 95 %</b>						K=2	K=2
<b>Expanded STD Uncertainty</b>						21.6%	21.5%

**Table 17.2. Uncertainty Budget for frequency range 300 MHz to 3 GHz**



## **18. References**

- [1] FCC 47 CFR Part 2 "Frequency Allocations and Radio Treaty Matters; General Rules and Regulations"
- [2] ANSI/IEEE Std. C95.1-1992, "IEEE Standard for Safety Levels with Respect to Human Exposure to Radio Frequency Electromagnetic Fields, 3 kHz to 300 GHz", September 1992
- [3] IEEE Std. 1528-2013, "IEEE Recommended Practice for Determining the Peak Spatial-Average Specific Absorption Rate (SAR) in the Human Head from Wireless Communications Devices: Measurement Techniques", Sep 2013
- [4] SPEAG DASY System Handbook
- [5] FCC KDB 248227 D01 v02r01, "SAR Guidance for IEEE 802.11 (WiFi) Transmitters", Jun 2015.
- [6] FCC KDB 447498 D01 v05r02, "Mobile and Portable Device RF Exposure Procedures and Equipment Authorization Policies", Feb 2014
- [7] FCC KDB 648474 D04 v01r02, "SAR Evaluation Considerations for Wireless Handsets", Dec 2013.
- [8] FCC KDB 941225 D01 v03, "3G SAR MEAUREMENT PROCEDURES", Oct 2014
- [9] FCC KDB 941225 D06 v02, "SAR Evaluation Procedures for Portable Devices with Wireless Router Capabilities", Oct 2014.
- [10] FCC KDB 865664 D01 v01r04, "SAR Measurement Requirements for 100 MHz to 6 GHz", Aug 2015.
- [11] FCC KDB 865664 D02 v01r01, "RF Exposure Compliance Reporting and Documentation Considerations" May 2013.



---

**Appendix A. Plots of System Performance Check**

The plots are shown as follows.

### System Check\_Head\_835MHz\_150809

**DUT: D835V2-SN:4d091**

Communication System: UID 0, CW; Frequency: 835 MHz;Duty Cycle: 1:1

Medium: HSL\_835\_150809 Medium parameters used:  $f = 835 \text{ MHz}$ ;  $\sigma = 0.916 \text{ S/m}$ ;  $\epsilon_r = 41.029$ ;  $\rho = 1000 \text{ kg/m}^3$

**Ambient Temperature: 23.3 °C ; Liquid Temperature: 22.8 °C**

DASY5 Configuration:

- Probe: EX3DV4 - SN3819; ConvF(9.48, 9.48, 9.48); Calibrated: 2014.11.13;
- Sensor-Surface: 2mm (Mechanical Surface Detection)
- Electronics: DAE4 Sn1303; Calibrated: 2014.12.11
- Phantom: SAM2; Type: QD000P40CD; Serial: TP:1671
- Measurement SW: DASY52, Version 52.8 (8);SEMCAD X Version 14.6.10 (7331)

**Pin=250mW/Area Scan (61x61x1):** Interpolated grid:  $dx=15\text{mm}$ ,  $dy=15\text{mm}$

Maximum value of SAR (interpolated) = 2.95 W/kg

**Pin=250mW/Zoom Scan (5x5x7)/Cube 0:** Measurement grid:  $dx=8\text{mm}$ ,  $dy=8\text{mm}$ ,  $dz=5\text{mm}$

Reference Value = 57.60 V/m; Power Drift = 0.01 dB

Peak SAR (extrapolated) = 3.46 W/kg

**SAR(1 g) = 2.34 W/kg; SAR(10 g) = 1.54 W/kg**

Maximum value of SAR (measured) = 2.96 W/kg

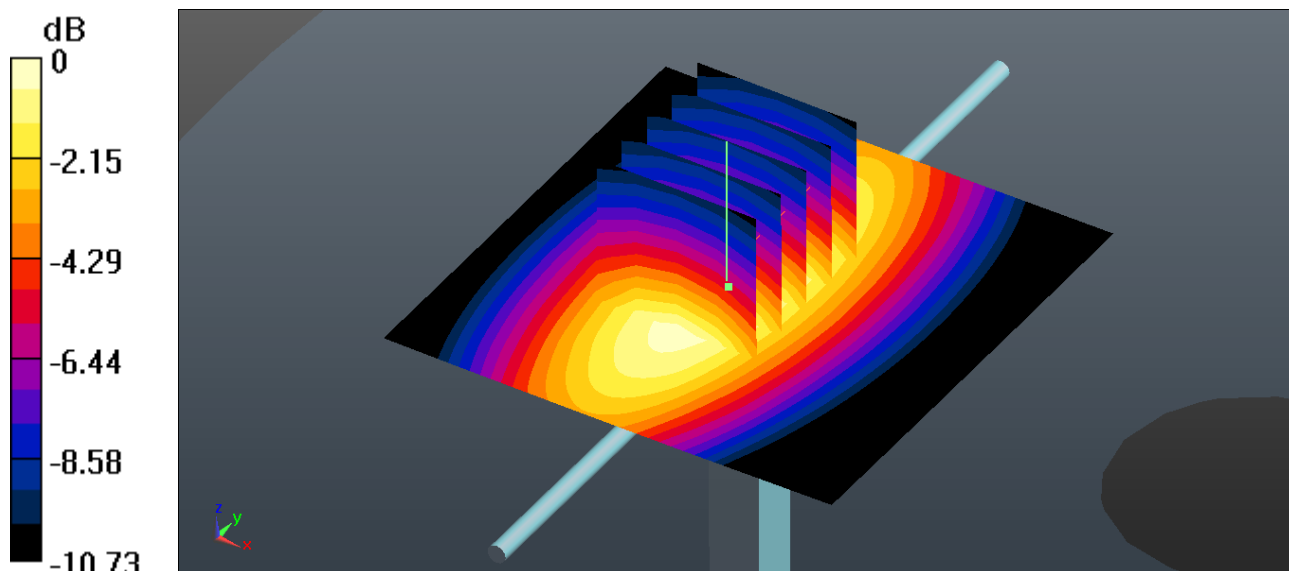

0 dB = 2.95 W/kg

### System Check\_Head\_1750MHz\_150808

**DUT: D1750V2-SN:1069**

Communication System: UID 0, CW; Frequency: 1750 MHz; Duty Cycle: 1:1

Medium: HSL\_1800\_150808 Medium parameters used:  $f = 1750$  MHz;  $\sigma = 1.385$  S/m;  $\epsilon_r = 39.708$ ;  $\rho = 1000$  kg/m<sup>3</sup>

**Ambient Temperature: 23.5 °C ; Liquid Temperature: 22.8 °C**

DASY5 Configuration:

- Probe: EX3DV4 - SN3819; ConvF(8.01, 8.01, 8.01); Calibrated: 2014.11.13;
- Sensor-Surface: 2mm (Mechanical Surface Detection)
- Electronics: DAE4 Sn1303; Calibrated: 2014.12.11
- Phantom: SAM2; Type: QD000P40CD; Serial: TP:1671
- Measurement SW: DASY52, Version 52.8 (8); SEMCAD X Version 14.6.10 (7331)

**Pin=250mW/Area Scan (61x61x1):** Interpolated grid: dx=15mm, dy=15mm

Maximum value of SAR (interpolated) = 16.3 W/kg

**Pin=250mW/Zoom Scan (5x5x7)/Cube 0:** Measurement grid: dx=8mm, dy=8mm, dz=5mm

Reference Value = 109.1 V/m; Power Drift = -0.01 dB

Peak SAR (extrapolated) = 20.4 W/kg

**SAR(1 g) = 10.0 W/kg; SAR(10 g) = 5.02 W/kg**

Maximum value of SAR (measured) = 16.0 W/kg

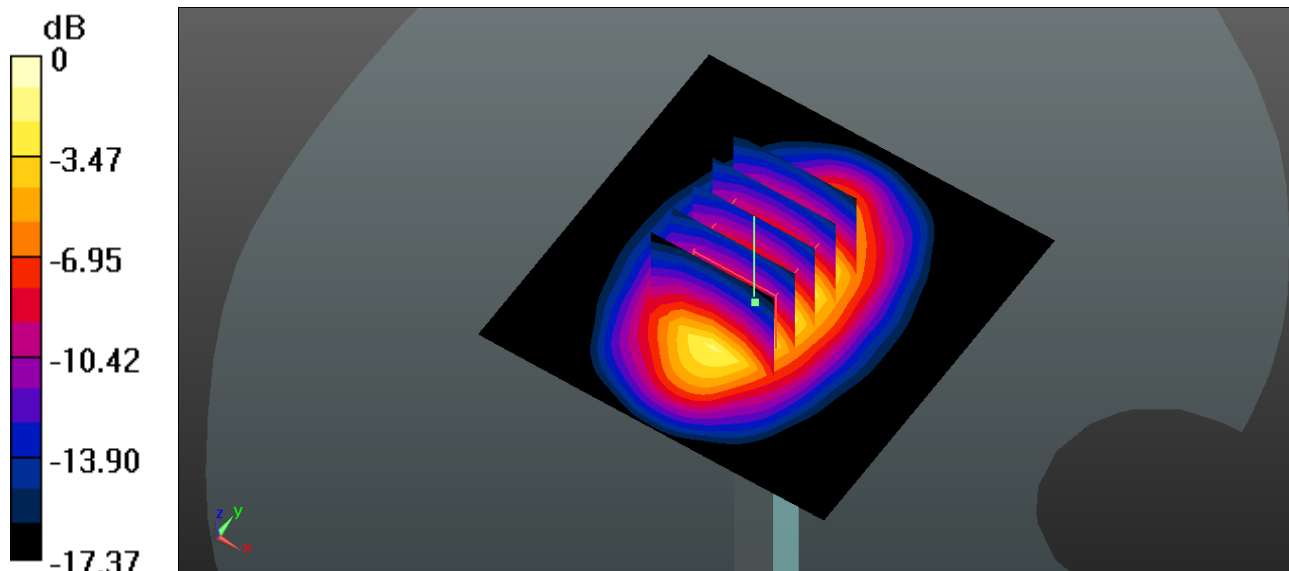

0 dB = 16.3 W/kg



### System Check\_Head\_1900MHz\_150808

**DUT: D1900V2-SN:5d118**

Communication System: UID 0, CW; Frequency: 1900 MHz; Duty Cycle: 1:1

Medium: HSL\_1900\_150808 Medium parameters used:  $f = 1900$  MHz;  $\sigma = 1.443$  S/m;  $\epsilon_r = 40.03$ ;  $\rho = 1000$  kg/m<sup>3</sup>

**Ambient Temperature: 23.5 °C ; Liquid Temperature: 22.9 °C**

DASY5 Configuration:

- Probe: EX3DV4 - SN3819; ConvF(7.66, 7.66, 7.66); Calibrated: 2014.11.13;
- Sensor-Surface: 2mm (Mechanical Surface Detection)
- Electronics: DAE4 Sn1303; Calibrated: 2014.12.11
- Phantom: SAM2; Type: QD000P40CD; Serial: TP:1671
- Measurement SW: DASY52, Version 52.8 (8); SEMCAD X Version 14.6.10 (7331)

**Pin=250mW/Area Scan (61x61x1):** Interpolated grid: dx=15mm, dy=15mm

Maximum value of SAR (interpolated) = 17.2 W/kg

**Pin=250mW/Zoom Scan (5x5x7)/Cube 0:** Measurement grid: dx=8mm, dy=8mm, dz=5mm

Reference Value = 111.5 V/m; Power Drift = -0.05 dB

Peak SAR (extrapolated) = 21.8 W/kg

**SAR(1 g) = 10.9 W/kg; SAR(10 g) = 5.21 W/kg**

Maximum value of SAR (measured) = 17.0 W/kg

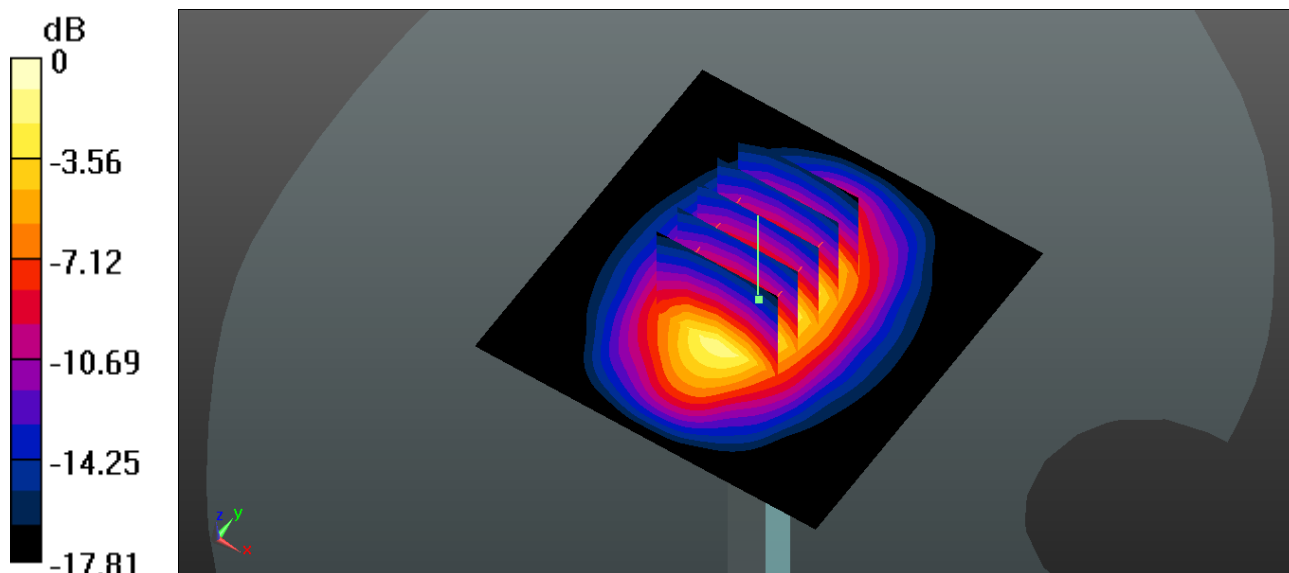

0 dB = 17.2 W/kg

### System Check\_Head\_2450MHz\_150809

**DUT: D2450V2-SN:840**

Communication System: UID 0, CW; Frequency: 2450 MHz;Duty Cycle: 1:1

Medium: HSL\_2450\_150809 Medium parameters used:  $f = 2450$  MHz;  $\sigma = 1.829$  S/m;  $\epsilon_r = 40.081$ ;  $\rho = 1000$  kg/m<sup>3</sup>

**Ambient Temperature:** 23.4 °C ; **Liquid Temperature:** 22.9 °C

DASY5 Configuration:

- Probe: EX3DV4 - SN3819; ConvF(7.01, 7.01, 7.01); Calibrated: 2014.11.13;
- Sensor-Surface: 2mm (Mechanical Surface Detection)
- Electronics: DAE4 Sn1303; Calibrated: 2014.12.11
- Phantom: SAM2; Type: QD000P40CD; Serial: TP:1671
- Measurement SW: DASY52, Version 52.8 (8);SEMCAD X Version 14.6.10 (7331)

**Pin=250mW/Area Scan (81x81x1):** Interpolated grid: dx=12mm, dy=12mm

Maximum value of SAR (interpolated) = 20.7 W/kg

**Pin=250mW/Zoom Scan (7x7x7)/Cube 0:** Measurement grid: dx=5mm, dy=5mm, dz=5mm

Reference Value = 89.99 V/m; Power Drift = -0.03 dB

Peak SAR (extrapolated) = 28.0 W/kg

**SAR(1 g) = 13.3 W/kg; SAR(10 g) = 6.12 W/kg**

Maximum value of SAR (measured) = 20.5 W/kg

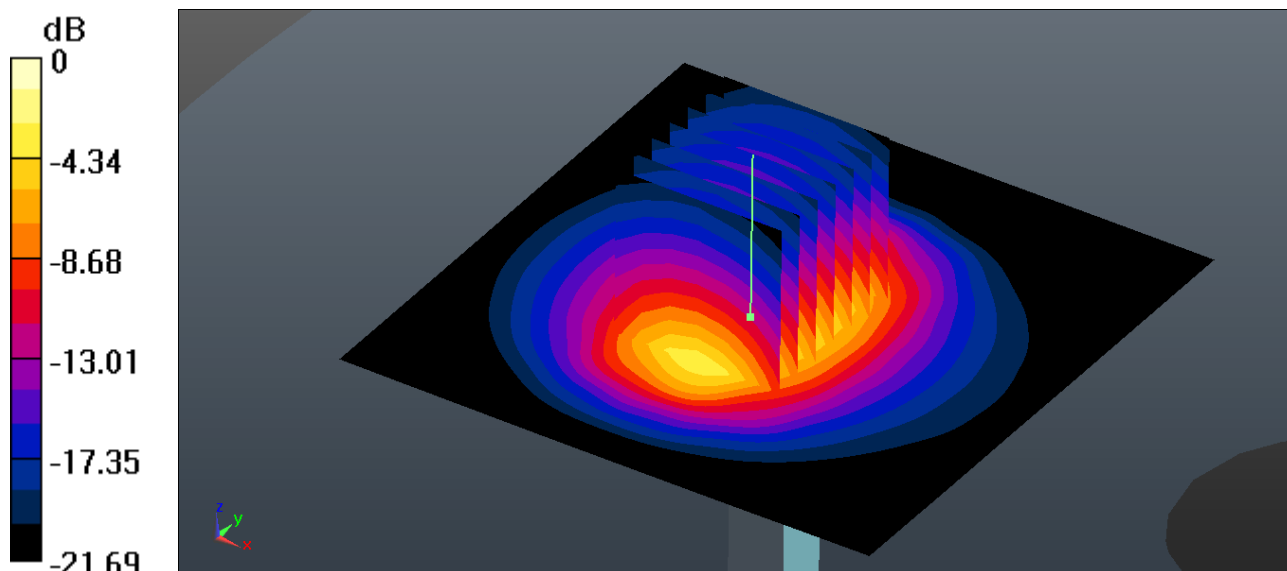

0 dB = 20.7 W/kg

### System Check\_Body\_835MHz\_150808

**DUT: D835V2-SN:4d091**

Communication System: UID 0, CW; Frequency: 835 MHz;Duty Cycle: 1:1

Medium: MSL\_835\_150808 Medium parameters used:  $f = 835 \text{ MHz}$ ;  $\sigma = 0.968 \text{ S/m}$ ;  $\epsilon_r = 57.458$ ;  $\rho = 1000 \text{ kg/m}^3$

**Ambient Temperature:** 23.4 °C ; **Liquid Temperature:** 22.8 °C

DASY5 Configuration:

- Probe: EX3DV4 - SN3819; ConvF(9.49, 9.49, 9.49); Calibrated: 2014.11.13;
- Sensor-Surface: 2mm (Mechanical Surface Detection)
- Electronics: DAE4 Sn1303; Calibrated: 2014.12.11
- Phantom: SAM2; Type: QD000P40CD; Serial: TP:1671
- Measurement SW: DASY52, Version 52.8 (8);SEMCAD X Version 14.6.10 (7331)

**Pin=250mW/Area Scan (61x61x1):** Interpolated grid: dx=15mm, dy=15mm

Maximum value of SAR (interpolated) = 2.60 W/kg

**Pin=250mW/Zoom Scan (5x5x7)/Cube 0:** Measurement grid: dx=8mm, dy=8mm, dz=5mm

Reference Value = 51.63 V/m; Power Drift = 0.01 dB

Peak SAR (extrapolated) = 3.56 W/kg

**SAR(1 g) = 2.41 W/kg; SAR(10 g) = 1.59 W/kg**

Maximum value of SAR (measured) = 2.58 W/kg

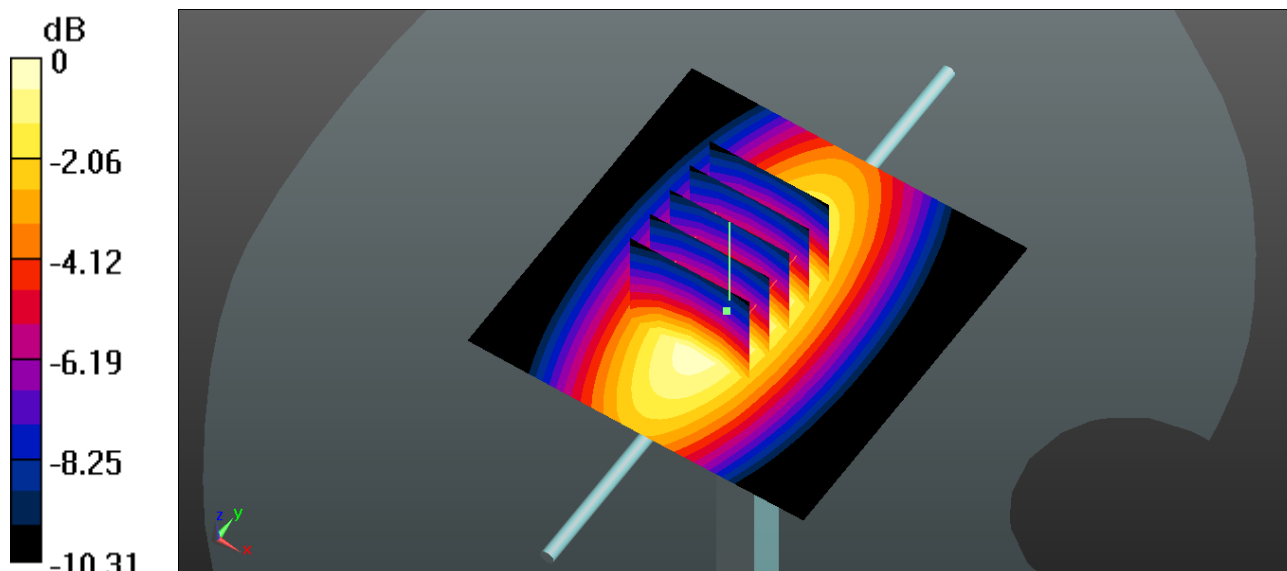

0 dB = 2.60 W/kg

### System Check\_Body\_1750MHz\_150807

**DUT: D1750V2-SN:1069**

Communication System: UID 0, CW; Frequency: 1750 MHz; Duty Cycle: 1:1

Medium: MSL\_1800\_150807 Medium parameters used:  $f = 1750$  MHz;  $\sigma = 1.528$  S/m;  $\epsilon_r = 52.031$ ;  $\rho = 1000$  kg/m<sup>3</sup>

**Ambient Temperature: 23.3 °C ; Liquid Temperature: 22.6 °C**

DASY5 Configuration:

- Probe: EX3DV4 - SN3819; ConvF(7.74, 7.74, 7.74); Calibrated: 2014.11.13;
- Sensor-Surface: 2mm (Mechanical Surface Detection)
- Electronics: DAE4 Sn1303; Calibrated: 2014.12.11
- Phantom: SAM2; Type: QD000P40CD; Serial: TP:1671
- Measurement SW: DASY52, Version 52.8 (8); SEMCAD X Version 14.6.10 (7331)

**Pin=250mW/Area Scan (61x61x1):** Interpolated grid: dx=15mm, dy=15mm

Maximum value of SAR (interpolated) = 14.7 W/kg

**Pin=250mW/Zoom Scan (5x5x7)/Cube 0:** Measurement grid: dx=8mm, dy=8mm, dz=5mm

Reference Value = 98.95 V/m; Power Drift = 0.02 dB

Peak SAR (extrapolated) = 18.3 W/kg

**SAR(1 g) = 10.2 W/kg; SAR(10 g) = 5.58 W/kg**

Maximum value of SAR (measured) = 14.6 W/kg

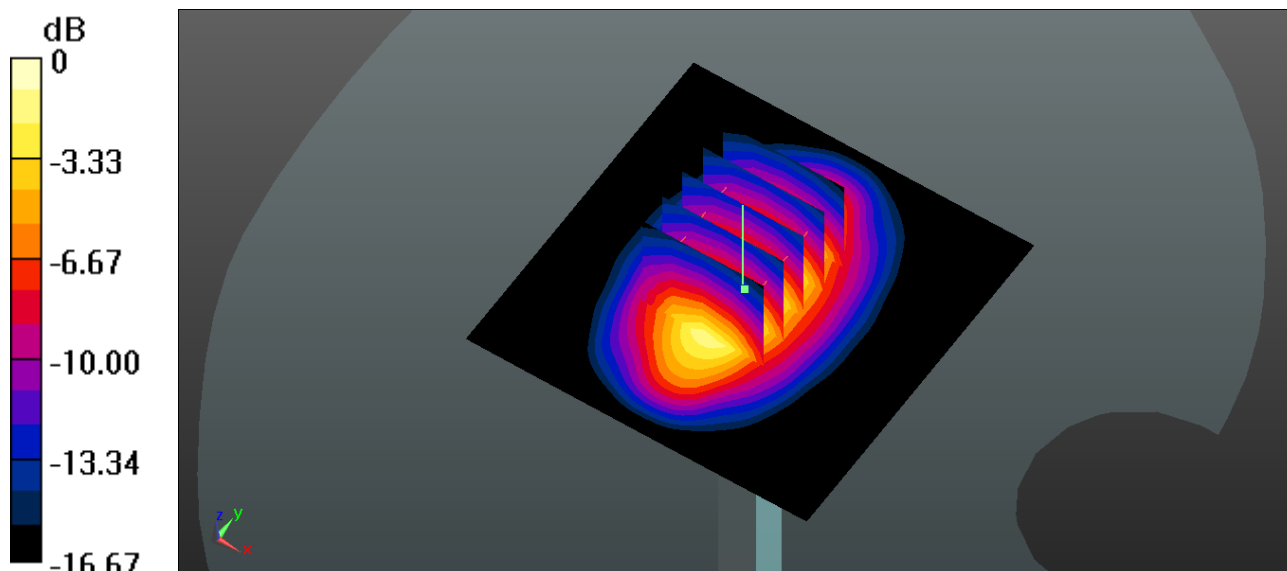

0 dB = 14.7 W/kg

### System Check\_Body\_1900MHz\_150807

#### DUT: D1900V2-SN:5d1118

Communication System: UID 0, CW; Frequency: 1900 MHz;Duty Cycle: 1:1

Medium: MSL\_1900\_150807 Medium parameters used:  $f = 1900$  MHz;  $\sigma = 1.58$  S/m;  $\epsilon_r = 54.631$ ;  $\rho = 1000$  kg/m<sup>3</sup>

**Ambient Temperature:** 23.3 °C ; **Liquid Temperature:** 22.7 °C

#### DASY5 Configuration:

- Probe: EX3DV4 - SN3819; ConvF(7.39, 7.39, 7.39); Calibrated: 2014.11.13;
- Sensor-Surface: 2mm (Mechanical Surface Detection)
- Electronics: DAE4 Sn1303; Calibrated: 2014.12.11
- Phantom: SAM2; Type: QD000P40CD; Serial: TP:1671
- Measurement SW: DASY52, Version 52.8 (8);SEMCAD X Version 14.6.10 (7331)

**Pin=250mW/Area Scan (61x61x1):** Interpolated grid: dx=15mm, dy=15mm

Maximum value of SAR (interpolated) = 16.1 W/kg

**Pin=250mW/Zoom Scan (5x5x7)/Cube 0:** Measurement grid: dx=8mm, dy=8mm, dz=5mm

Reference Value = 89.28 V/m; Power Drift = -0.01 dB

Peak SAR (extrapolated) = 20.5 W/kg

**SAR(1 g) = 10.3 W/kg; SAR(10 g) = 5.06 W/kg**

Maximum value of SAR (measured) = 16.2 W/kg

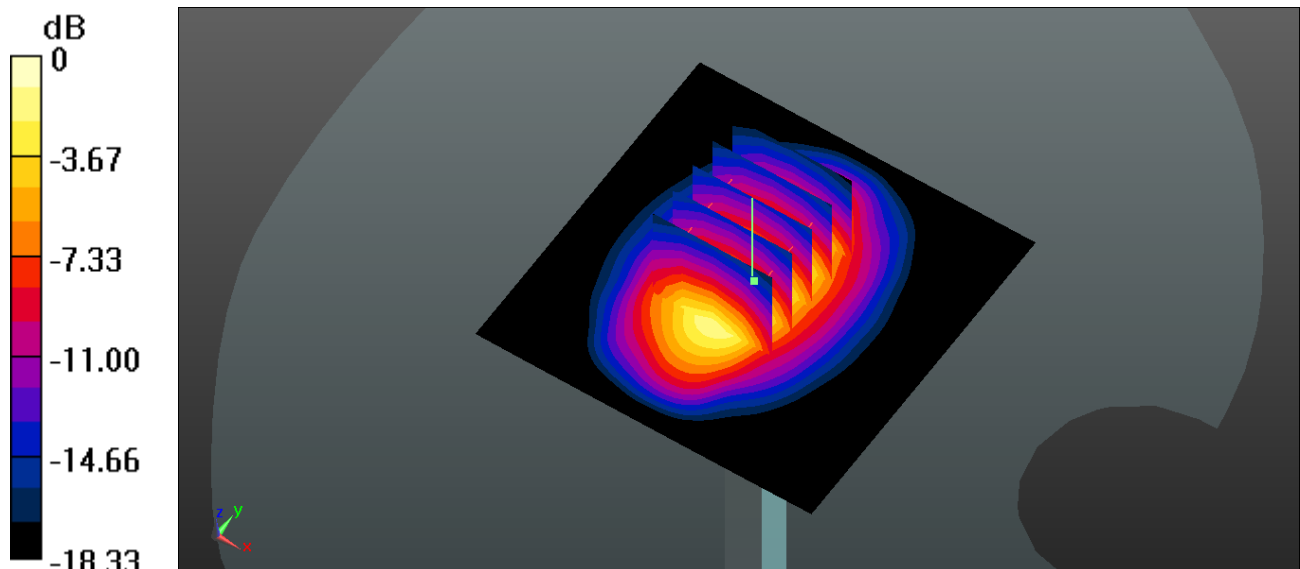

0 dB = 16.1 W/kg

### System Check\_Body\_2450MHz\_150811

**DUT: D2450V2-SN:840**

Communication System: UID 0, CW; Frequency: 2450 MHz; Duty Cycle: 1:1

Medium: MSL\_2450\_150811 Medium parameters used:  $f = 2450$  MHz;  $\sigma = 1.991$  S/m;  $\epsilon_r = 52.32$ ;  $\rho = 1000$  kg/m<sup>3</sup>

**Ambient Temperature: 23.5 °C ; Liquid Temperature: 22.6 °C**

DASY5 Configuration:

- Probe: EX3DV4 - SN3819; ConvF(6.95, 6.95, 6.95); Calibrated: 2014.11.13;
- Sensor-Surface: 2mm (Mechanical Surface Detection)
- Electronics: DAE4 Sn1303; Calibrated: 2014.12.11
- Phantom: SAM2; Type: QD000P40CD; Serial: TP:1671
- Measurement SW: DASY52, Version 52.8 (8); SEMCAD X Version 14.6.10 (7331)

**Pin=250mW/Area Scan (81x81x1):** Interpolated grid: dx=12mm, dy=12mm

Maximum value of SAR (interpolated) = 19.5 W/kg

**Pin=250mW/Zoom Scan (7x7x7)/Cube 0:** Measurement grid: dx=5mm, dy=5mm, dz=5mm

Reference Value = 84.03 V/m; Power Drift = 0.10 dB

Peak SAR (extrapolated) = 26.9 W/kg

**SAR(1 g) = 12.7 W/kg; SAR(10 g) = 5.78 W/kg**

Maximum value of SAR (measured) = 19.7 W/kg

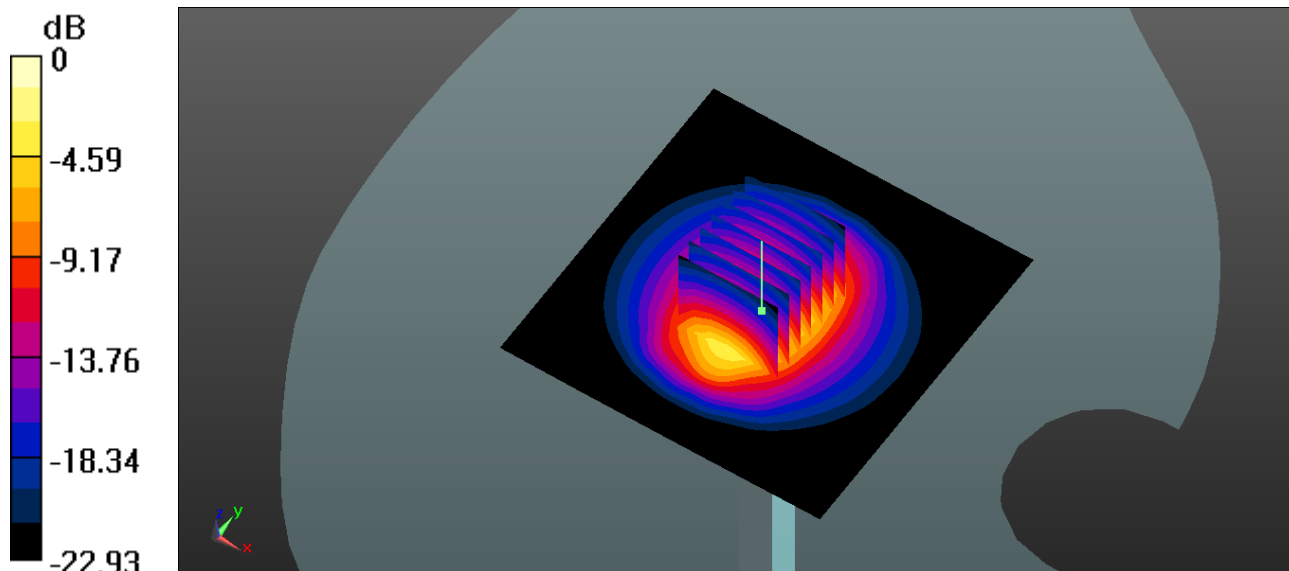

0 dB = 19.5 W/kg



---

**Appendix B. Plots of SAR Measurement**

The plots are shown as follows.

### #01\_GSM850\_GPRS(2 Tx slots)\_Left Cheek\_Ch128

Communication System: UID 0, GPRS/EDGE10 (0); Frequency: 824.2 MHz; Duty Cycle: 1:4.15  
Medium: HSL\_835\_150809 Medium parameters used:  $f = 824.2$  MHz;  $\sigma = 0.906$  S/m;  $\epsilon_r = 41.145$ ;  $\rho = 1000$  kg/m<sup>3</sup>

**Ambient Temperature:** 23.3 °C ; **Liquid Temperature:** 22.8 °C

#### DASY5 Configuration:

- Probe: EX3DV4 - SN3819; ConvF(9.48, 9.48, 9.48); Calibrated: 2014.11.13;
- Sensor-Surface: 2mm (Mechanical Surface Detection)
- Electronics: DAE4 Sn1303; Calibrated: 2014.12.11
- Phantom: SAM2; Type: QD000P40CD; Serial: TP:1671
- Measurement SW: DASY52, Version 52.8 (8); SEMCAD X Version 14.6.10 (7331)

**Ch128/Area Scan (61x101x1):** Interpolated grid: dx=15mm, dy=15mm  
Maximum value of SAR (interpolated) = 0.348 W/kg

**Ch128/Zoom Scan (5x5x7)/Cube 0:** Measurement grid: dx=8mm, dy=8mm, dz=5mm  
Reference Value = 6.936 V/m; Power Drift = 0.09 dB  
Peak SAR (extrapolated) = 0.359 W/kg  
**SAR(1 g) = 0.298 W/kg; SAR(10 g) = 0.230 W/kg**  
Maximum value of SAR (measured) = 0.334 W/kg

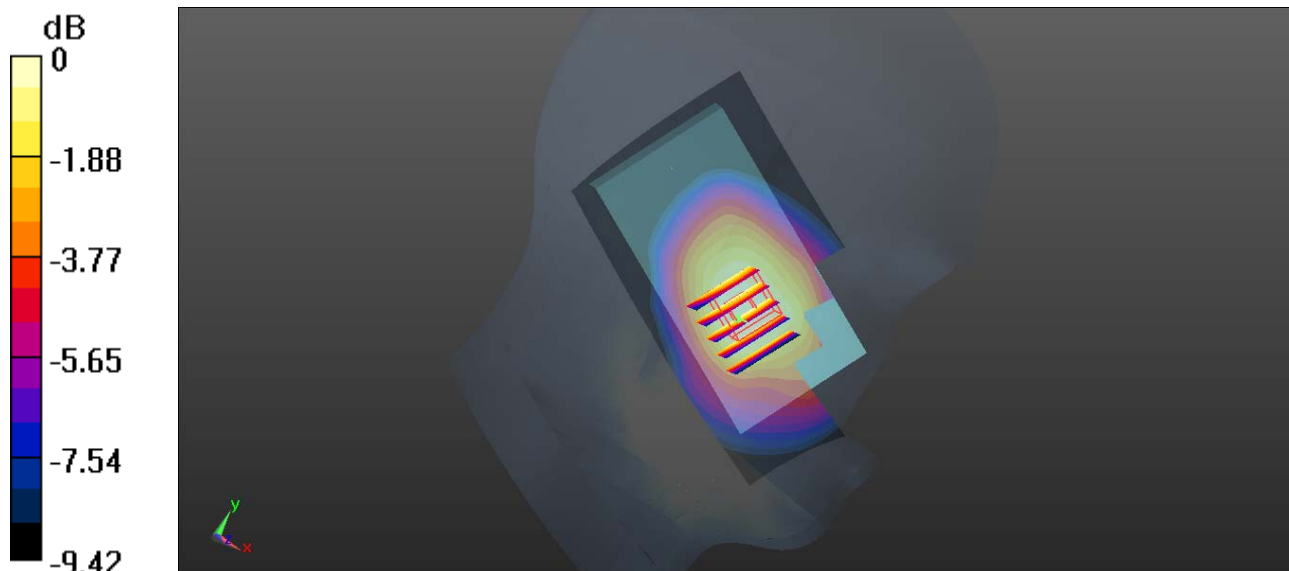

0 dB = 0.348 W/kg



## #02\_GSM1900\_GPRS(2 Tx slots)\_Right Cheek\_Ch810

Communication System: UID 0, GPRS/EDGE10 (0); Frequency: 1909.8 MHz; Duty Cycle: 1:4.15  
 Medium: HSL\_1900\_150808 Medium parameters used:  $f = 1909.8$  MHz;  $\sigma = 1.453$  S/m;  $\epsilon_r = 39.988$ ;  $\rho = 1000$  kg/m<sup>3</sup>

**Ambient Temperature:** 23.5 °C ; **Liquid Temperature:** 22.9 °C

### DASY5 Configuration:

- Probe: EX3DV4 - SN3819; ConvF(7.66, 7.66, 7.66); Calibrated: 2014.11.13;
- Sensor-Surface: 2mm (Mechanical Surface Detection)
- Electronics: DAE4 Sn1303; Calibrated: 2014.12.11
- Phantom: SAM2; Type: QD000P40CD; Serial: TP:1671
- Measurement SW: DASY52, Version 52.8 (8); SEMCAD X Version 14.6.10 (7331)

**Ch810/Area Scan (61x101x1):** Interpolated grid: dx=15mm, dy=15mm  
 Maximum value of SAR (interpolated) = 0.296 W/kg

**Ch810/Zoom Scan (5x5x7)/Cube 0:** Measurement grid: dx=8mm, dy=8mm, dz=5mm  
 Reference Value = 4.077 V/m; Power Drift = -0.04 dB  
 Peak SAR (extrapolated) = 0.334 W/kg  
**SAR(1 g) = 0.225 W/kg; SAR(10 g) = 0.145 W/kg**  
 Maximum value of SAR (measured) = 0.283 W/kg

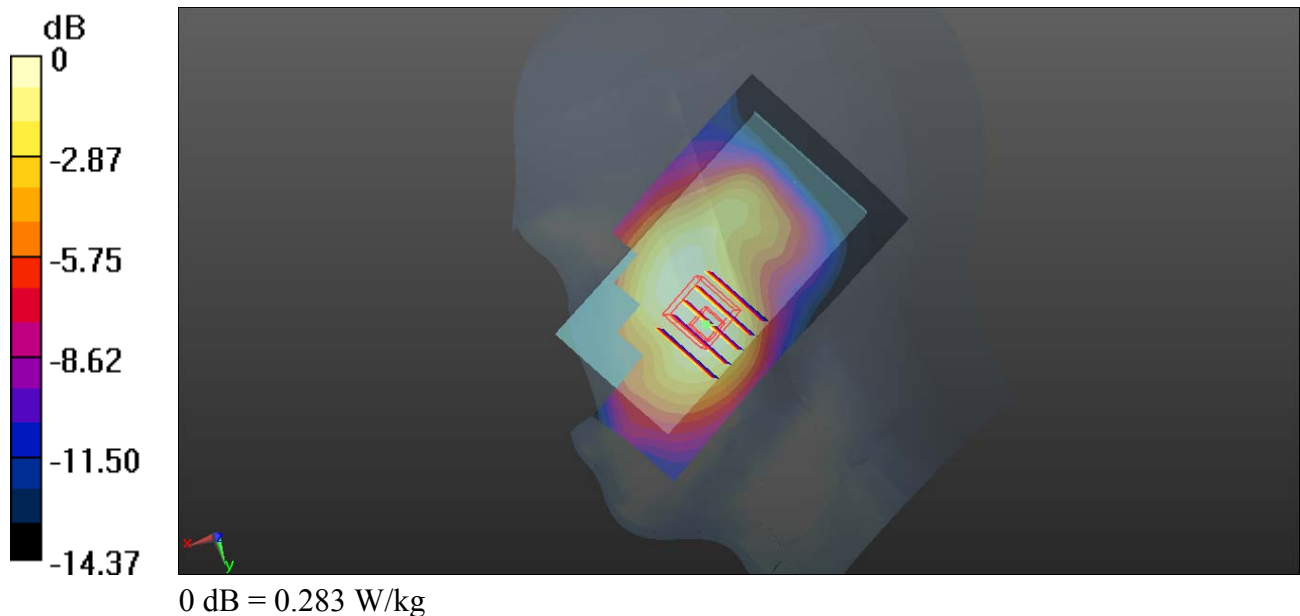

### #03\_WCDMA Band V\_RMC 12.2Kbps\_Right Cheek\_Ch4233

Communication System: UID 0, UMTS (0); Frequency: 846.6 MHz; Duty Cycle: 1:1  
Medium: HSL\_835\_150809 Medium parameters used:  $f = 846.6$  MHz;  $\sigma = 0.926$  S/m;  $\epsilon_r = 40.905$ ;  $\rho = 1000$  kg/m<sup>3</sup>

**Ambient Temperature:** 23.3 °C ; **Liquid Temperature:** 22.8 °C

#### DASY5 Configuration:

- Probe: EX3DV4 - SN3819; ConvF(9.48, 9.48, 9.48); Calibrated: 2014.11.13;
- Sensor-Surface: 2mm (Mechanical Surface Detection)
- Electronics: DAE4 Sn1303; Calibrated: 2014.12.11
- Phantom: SAM2; Type: QD000P40CD; Serial: TP:1671
- Measurement SW: DASY52, Version 52.8 (8); SEMCAD X Version 14.6.10 (7331)

**Ch4233/Area Scan (61x101x1):** Interpolated grid: dx=15mm, dy=15mm

Maximum value of SAR (interpolated) = 0.445 W/kg

**Ch4233/Zoom Scan (5x5x7)/Cube 0:** Measurement grid: dx=8mm, dy=8mm, dz=5mm

Reference Value = 5.563 V/m; Power Drift = 0.02 dB

Peak SAR (extrapolated) = 0.469 W/kg

**SAR(1 g) = 0.390 W/kg; SAR(10 g) = 0.301 W/kg**

Maximum value of SAR (measured) = 0.436 W/kg

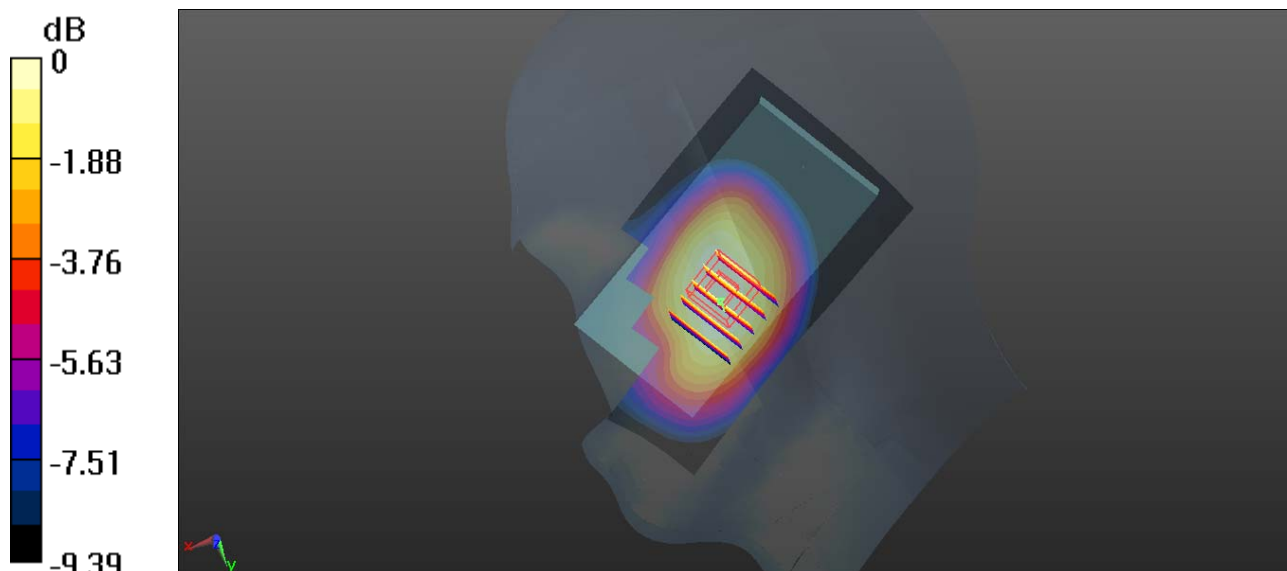

0 dB = 0.445 W/kg

### #04\_WCDMA Band IV\_RMC 12.2Kbps\_Right Cheek\_Ch1513

Communication System: UID 0, UMTS (0); Frequency: 1752.6 MHz; Duty Cycle: 1:1  
Medium: HSL\_1800\_150808 Medium parameters used:  $f = 1752.6$  MHz;  $\sigma = 1.387$  S/m;  $\epsilon_r = 39.691$ ;  $\rho = 1000$  kg/m<sup>3</sup>

**Ambient Temperature:** 23.5 °C ; **Liquid Temperature:** 22.8 °C

#### DASY5 Configuration:

- Probe: EX3DV4 - SN3819; ConvF(8.01, 8.01, 8.01); Calibrated: 2014.11.13;
- Sensor-Surface: 2mm (Mechanical Surface Detection)
- Electronics: DAE4 Sn1303; Calibrated: 2014.12.11
- Phantom: SAM2; Type: QD000P40CD; Serial: TP:1671
- Measurement SW: DASY52, Version 52.8 (8); SEMCAD X Version 14.6.10 (7331)

**Ch1513/Area Scan (61x101x1):** Interpolated grid: dx=15mm, dy=15mm  
Maximum value of SAR (interpolated) = 0.273 W/kg

**Ch1513/Zoom Scan (5x5x7)/Cube 0:** Measurement grid: dx=8mm, dy=8mm, dz=5mm  
Reference Value = 5.056 V/m; Power Drift = -0.03 dB  
Peak SAR (extrapolated) = 0.316 W/kg  
**SAR(1 g) = 0.214 W/kg; SAR(10 g) = 0.140 W/kg**  
Maximum value of SAR (measured) = 0.268 W/kg

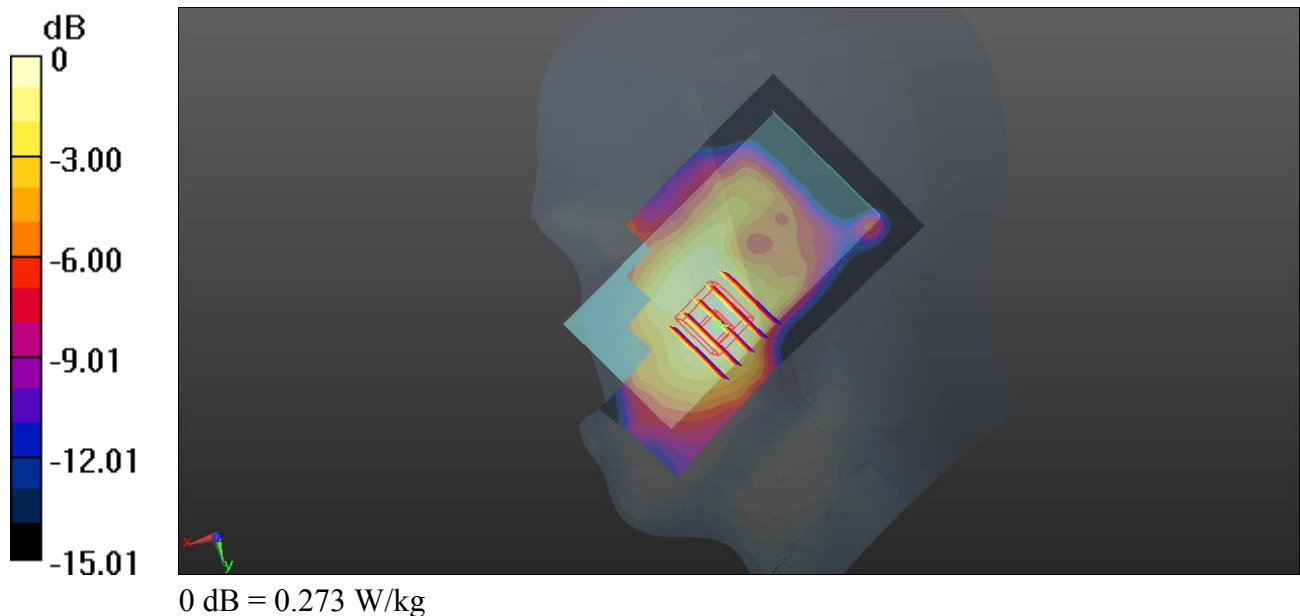

### #05\_WCDMA Band II\_RMC 12.2Kbps\_Left Cheek\_Ch9538

Communication System: UID 0, UMTS (0); Frequency: 1907.6 MHz; Duty Cycle: 1:1  
Medium: HSL\_1900\_150808 Medium parameters used:  $f = 1907.6$  MHz;  $\sigma = 1.451$  S/m;  $\epsilon_r = 39.996$ ;  $\rho = 1000$  kg/m<sup>3</sup>

**Ambient Temperature:** 23.5 °C ; **Liquid Temperature:** 22.9 °C

#### DASY5 Configuration:

- Probe: EX3DV4 - SN3819; ConvF(7.66, 7.66, 7.66); Calibrated: 2014.11.13;
- Sensor-Surface: 2mm (Mechanical Surface Detection)
- Electronics: DAE4 Sn1303; Calibrated: 2014.12.11
- Phantom: SAM2; Type: QD000P40CD; Serial: TP:1671
- Measurement SW: DASY52, Version 52.8 (8); SEMCAD X Version 14.6.10 (7331)

**Ch9538/Area Scan (61x101x1):** Interpolated grid: dx=15mm, dy=15mm

Maximum value of SAR (interpolated) = 0.650 W/kg

**Ch9538/Zoom Scan (5x5x7)/Cube 0:** Measurement grid: dx=8mm, dy=8mm, dz=5mm

Reference Value = 6.607 V/m; Power Drift = -0.01 dB

Peak SAR (extrapolated) = 0.741 W/kg

**SAR(1 g) = 0.491 W/kg; SAR(10 g) = 0.305 W/kg**

Maximum value of SAR (measured) = 0.607 W/kg

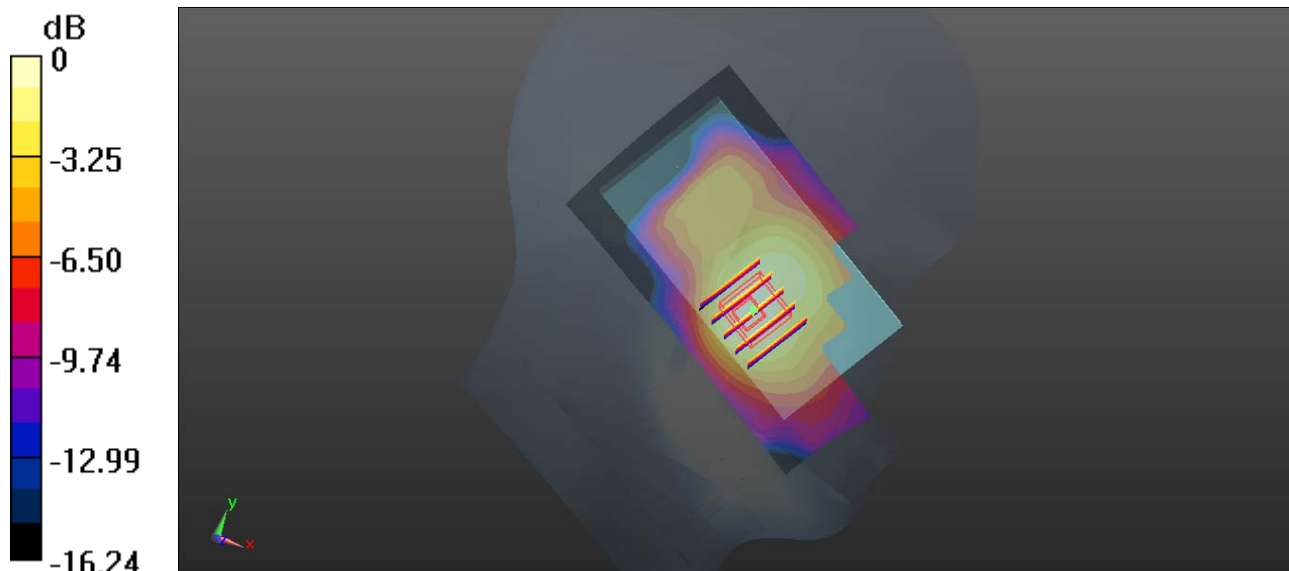

0 dB = 0.650 W/kg

### #06\_WLAN2.4GHz\_802.11b 1Mbps\_Left Cheek\_Ch11

Communication System: UID 0, WIFI (0); Frequency: 2462 MHz;Duty Cycle: 1:1.018  
Medium: HSL\_2450\_150809 Medium parameters used:  $f = 2462$  MHz;  $\sigma = 1.842$  S/m;  $\epsilon_r = 40.039$ ;  $\rho = 1000$  kg/m<sup>3</sup>

**Ambient Temperature:** 23.4 °C ; **Liquid Temperature:** 22.9 °C

#### DASY5 Configuration:

- Probe: EX3DV4 - SN3819; ConvF(7.01, 7.01, 7.01); Calibrated: 2014.11.13;
- Sensor-Surface: 2mm (Mechanical Surface Detection)
- Electronics: DAE4 Sn1303; Calibrated: 2014.12.11
- Phantom: SAM2; Type: QD000P40CD; Serial: TP:1671
- Measurement SW: DASY52, Version 52.8 (8);SEMCAD X Version 14.6.10 (7331)

**Ch11/Area Scan (81x131x1):** Interpolated grid: dx=12mm, dy=12mm

Maximum value of SAR (interpolated) = 1.50 W/kg

**Ch11/Zoom Scan (7x7x7)/Cube 0:** Measurement grid: dx=5mm, dy=5mm, dz=5mm

Reference Value = 1.715 V/m; Power Drift = 0.18 dB

Peak SAR (extrapolated) = 1.95 W/kg

**SAR(1 g) = 0.954 W/kg; SAR(10 g) = 0.485 W/kg**

Maximum value of SAR (measured) = 1.43 W/kg

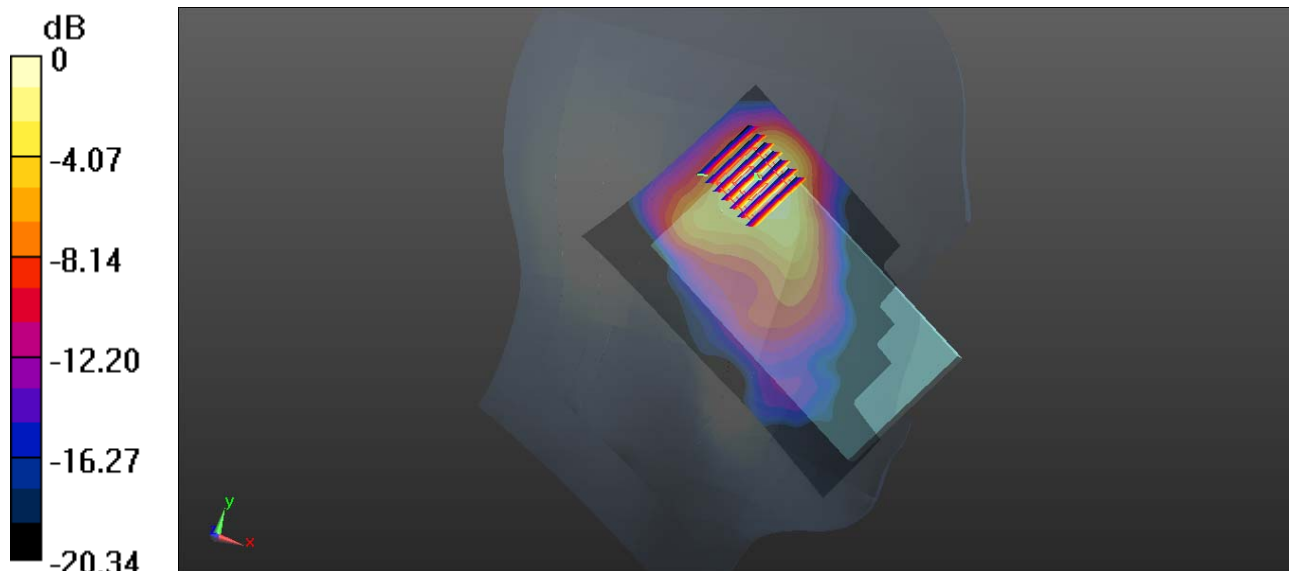

0 dB = 1.50 W/kg

### #07\_GSM850\_GPRS(2 Tx slots)\_Back\_10mm\_Ch128

Communication System: UID 0, GPRS/EDGE10 (0); Frequency: 824.2 MHz; Duty Cycle: 1:4.15  
Medium: MSL\_835\_150808 Medium parameters used:  $f = 824.2$  MHz;  $\sigma = 0.958$  S/m;  $\epsilon_r = 57.557$ ;  $\rho = 1000$  kg/m<sup>3</sup>

**Ambient Temperature:** 23.4 °C ; **Liquid Temperature:** 22.8 °C

#### DASY5 Configuration:

- Probe: EX3DV4 - SN3819; ConvF(9.49, 9.49, 9.49); Calibrated: 2014.11.13;
- Sensor-Surface: 2mm (Mechanical Surface Detection)
- Electronics: DAE4 Sn1303; Calibrated: 2014.12.11
- Phantom: SAM2; Type: QD000P40CD; Serial: TP:1671
- Measurement SW: DASY52, Version 52.8 (8); SEMCAD X Version 14.6.10 (7331)

**Ch128/Area Scan (61x101x1):** Interpolated grid: dx=15mm, dy=15mm  
Maximum value of SAR (interpolated) = 0.711 W/kg

**Ch128/Zoom Scan (5x5x7)/Cube 0:** Measurement grid: dx=8mm, dy=8mm, dz=5mm  
Reference Value = 3.556 V/m; Power Drift = -0.08 dB  
Peak SAR (extrapolated) = 0.791 W/kg  
**SAR(1 g) = 0.614 W/kg; SAR(10 g) = 0.457 W/kg**  
Maximum value of SAR (measured) = 0.712 W/kg

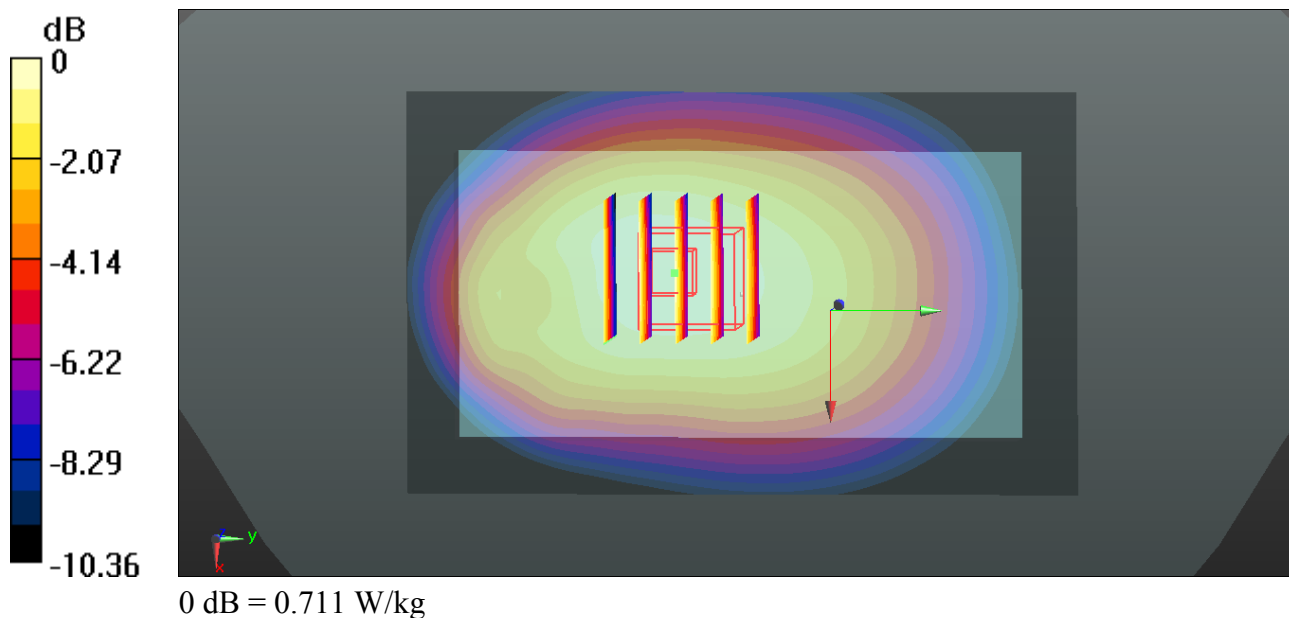

### #08\_GSM1900\_GPRS(2 Tx slots)\_Back\_10mm\_Ch810

Communication System: UID 0, GPRS/EDGE10 (0); Frequency: 1909.8 MHz; Duty Cycle: 1:4.15  
Medium: MSL\_1900\_150807 Medium parameters used:  $f = 1909.8$  MHz;  $\sigma = 1.589$  S/m;  $\epsilon_r = 54.611$ ;  $\rho = 1000$  kg/m<sup>3</sup>

**Ambient Temperature:** 23.3 °C ; **Liquid Temperature:** 22.7 °C

#### DASY5 Configuration:

- Probe: EX3DV4 - SN3819; ConvF(7.39, 7.39, 7.39); Calibrated: 2014.11.13;
- Sensor-Surface: 2mm (Mechanical Surface Detection)
- Electronics: DAE4 Sn1303; Calibrated: 2014.12.11
- Phantom: SAM2; Type: QD000P40CD; Serial: TP:1671
- Measurement SW: DASY52, Version 52.8 (8); SEMCAD X Version 14.6.10 (7331)

**Ch810/Area Scan (61x101x1):** Interpolated grid: dx=15mm, dy=15mm  
Maximum value of SAR (interpolated) = 0.781 W/kg

**Ch810/Zoom Scan (5x5x7)/Cube 0:** Measurement grid: dx=8mm, dy=8mm, dz=5mm  
Reference Value = 1.813 V/m; Power Drift = -0.06 dB  
Peak SAR (extrapolated) = 0.935 W/kg  
**SAR(1 g) = 0.552 W/kg; SAR(10 g) = 0.346 W/kg**  
Maximum value of SAR (measured) = 0.725 W/kg

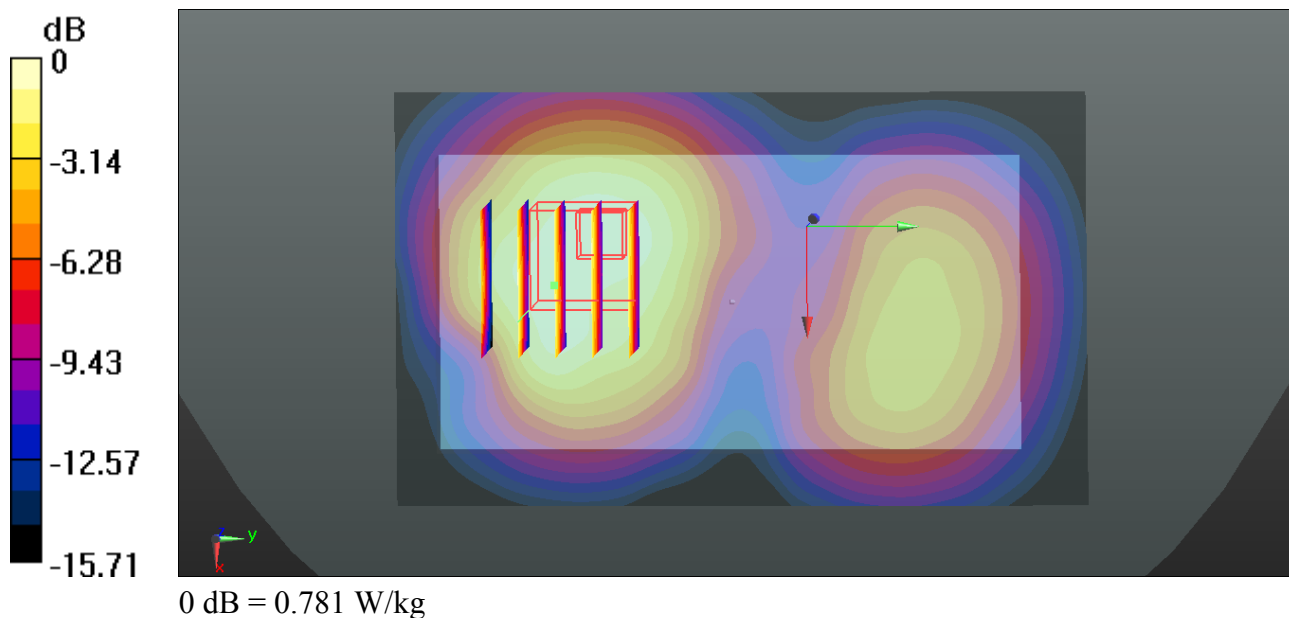

### #09\_WCDMA Band V\_RMC 12.2Kbps\_Back\_10mm\_Ch4132

Communication System: UID 0, UMTS (0); Frequency: 826.4 MHz; Duty Cycle: 1:1  
Medium: MSL\_835\_150808 Medium parameters used:  $f = 826.4$  MHz;  $\sigma = 0.96$  S/m;  $\epsilon_r = 57.537$ ;  $\rho = 1000$  kg/m<sup>3</sup>  
**Ambient Temperature:** 23.4 °C ; **Liquid Temperature:** 22.8 °C

#### DASY5 Configuration:

- Probe: EX3DV4 - SN3819; ConvF(9.49, 9.49, 9.49); Calibrated: 2014.11.13;
- Sensor-Surface: 2mm (Mechanical Surface Detection)
- Electronics: DAE4 Sn1303; Calibrated: 2014.12.11
- Phantom: SAM2; Type: QD000P40CD; Serial: TP:1671
- Measurement SW: DASY52, Version 52.8 (8); SEMCAD X Version 14.6.10 (7331)

**Ch4132/Area Scan (61x101x1):** Interpolated grid: dx=15mm, dy=15mm  
Maximum value of SAR (interpolated) = 1.02 W/kg

**Ch4132/Zoom Scan (5x5x7)/Cube 0:** Measurement grid: dx=8mm, dy=8mm, dz=5mm  
Reference Value = 4.161 V/m; Power Drift = -0.18 dB  
Peak SAR (extrapolated) = 1.15 W/kg  
**SAR(1 g) = 0.886 W/kg; SAR(10 g) = 0.660 W/kg**  
Maximum value of SAR (measured) = 1.03 W/kg

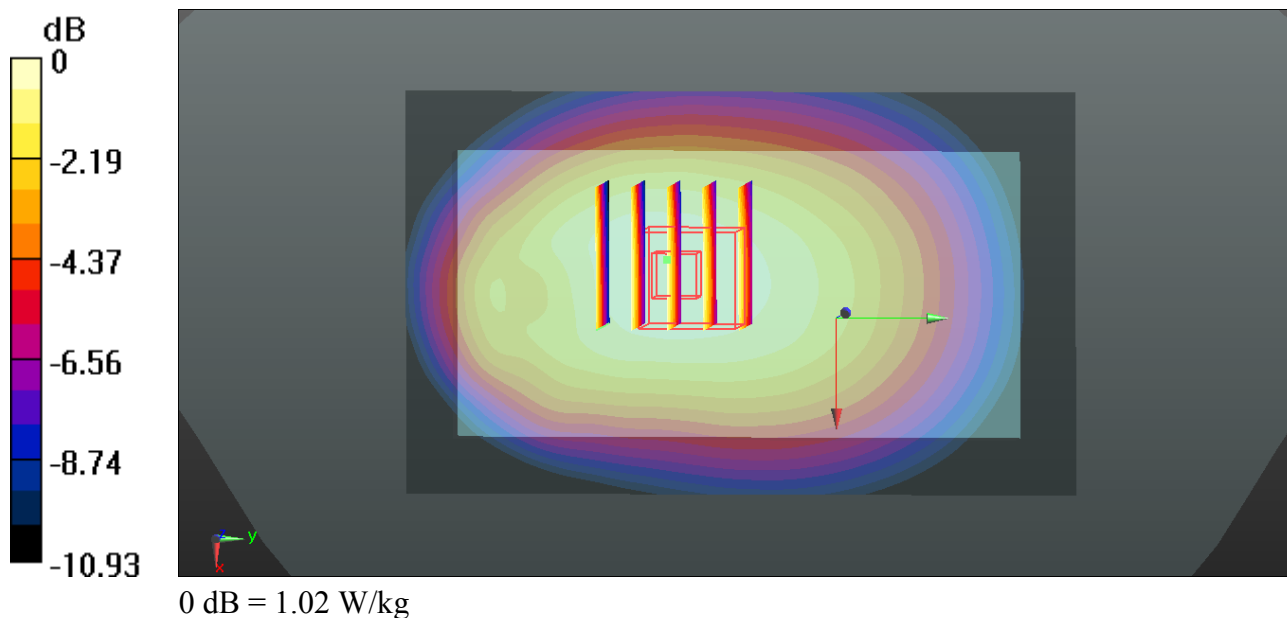



### #10\_WCDMA Band IV\_RMC 12.2Kbps\_Back\_10mm\_Ch1513

Communication System: UID 0, UMTS (0); Frequency: 1752.6 MHz; Duty Cycle: 1:1  
Medium: MSL\_1800\_150807 Medium parameters used:  $f = 1752.6$  MHz;  $\sigma = 1.532$  S/m;  $\epsilon_r = 52.023$ ;  $\rho = 1000$  kg/m<sup>3</sup>

**Ambient Temperature:** 23.3 °C ; **Liquid Temperature:** 22.6 °C

#### DASY5 Configuration:

- Probe: EX3DV4 - SN3819; ConvF(7.74, 7.74, 7.74); Calibrated: 2014.11.13;
- Sensor-Surface: 2mm (Mechanical Surface Detection)
- Electronics: DAE4 Sn1303; Calibrated: 2014.12.11
- Phantom: SAM2; Type: QD000P40CD; Serial: TP:1671
- Measurement SW: DASY52, Version 52.8 (8); SEMCAD X Version 14.6.10 (7331)

**Ch1513/Area Scan (61x101x1):** Interpolated grid: dx=15mm, dy=15mm

Maximum value of SAR (interpolated) = 0.681 W/kg

**Ch1513/Zoom Scan (5x5x7)/Cube 0:** Measurement grid: dx=8mm, dy=8mm, dz=5mm

Reference Value = 3.206 V/m; Power Drift = -0.03 dB

Peak SAR (extrapolated) = 0.774 W/kg

**SAR(1 g) = 0.477 W/kg; SAR(10 g) = 0.305 W/kg**

Maximum value of SAR (measured) = 0.644 W/kg

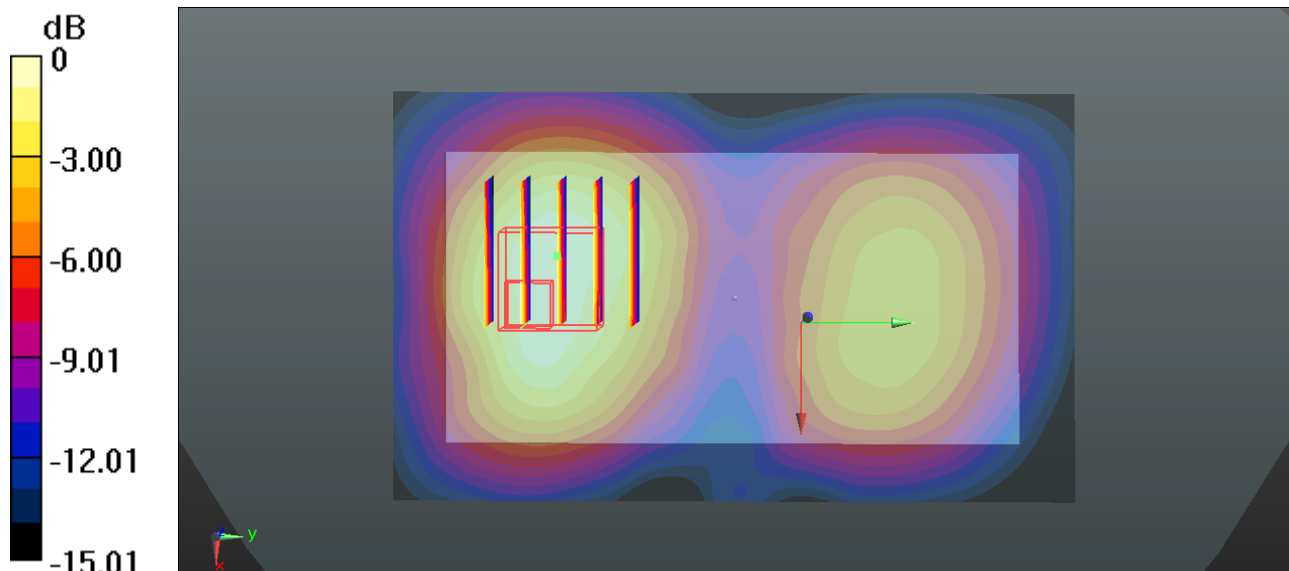

0 dB = 0.681 W/kg

### #11\_WCDMA Band II\_RMC 12.2Kbps\_Back\_10mm\_Ch9400

Communication System: UID 0, UMTS (0); Frequency: 1880 MHz; Duty Cycle: 1:1  
Medium: MSL\_1900\_150807 Medium parameters used:  $f = 1880$  MHz;  $\sigma = 1.557$  S/m;  $\epsilon_r = 54.666$ ;  $\rho = 1000$  kg/m<sup>3</sup>

**Ambient Temperature:** 23.3 °C ; **Liquid Temperature:** 22.7 °C

#### DASY5 Configuration:

- Probe: EX3DV4 - SN3819; ConvF(7.39, 7.39, 7.39); Calibrated: 2014.11.13;
- Sensor-Surface: 2mm (Mechanical Surface Detection)
- Electronics: DAE4 Sn1303; Calibrated: 2014.12.11
- Phantom: SAM2; Type: QD000P40CD; Serial: TP:1671
- Measurement SW: DASY52, Version 52.8 (8); SEMCAD X Version 14.6.10 (7331)

**Ch9400/Area Scan (61x101x1):** Interpolated grid: dx=15mm, dy=15mm

Maximum value of SAR (interpolated) = 1.18 W/kg

**Ch9400/Zoom Scan (5x5x7)/Cube 0:** Measurement grid: dx=8mm, dy=8mm, dz=5mm

Reference Value = 3.437 V/m; Power Drift = -0.03 dB

Peak SAR (extrapolated) = 1.46 W/kg

**SAR(1 g) = 0.853 W/kg; SAR(10 g) = 0.510 W/kg**

Maximum value of SAR (measured) = 1.11 W/kg

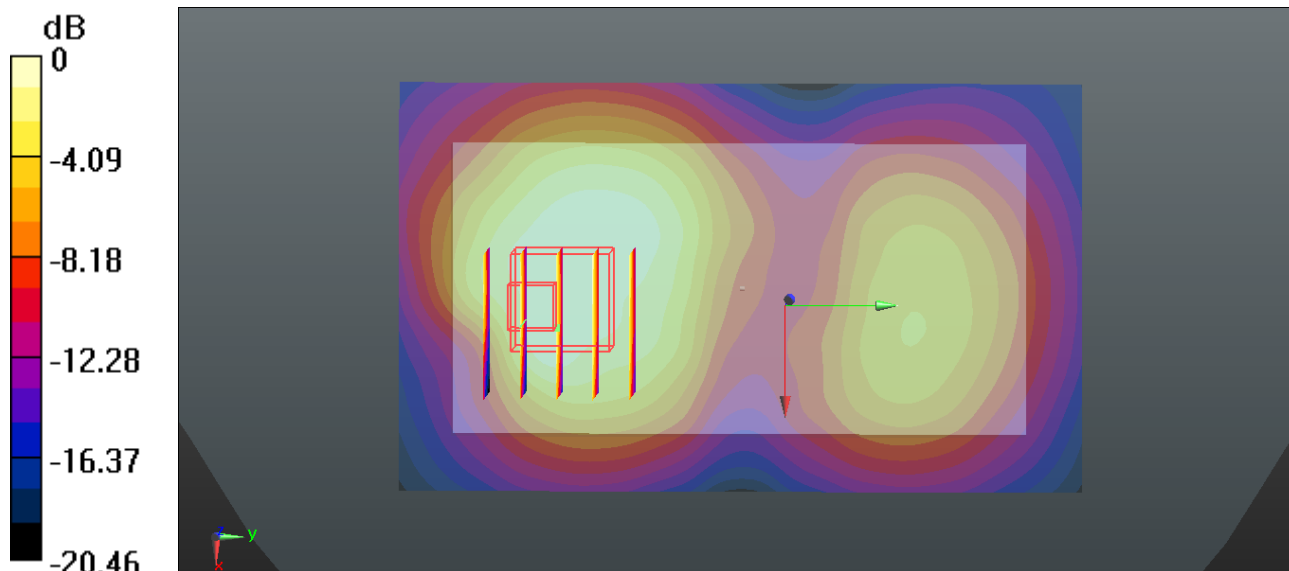

0 dB = 1.18 W/kg

### #12\_WLAN2.4GHz\_802.11b 1Mbps\_Back\_10mm\_Ch6

Communication System: UID 0, WIFI (0); Frequency: 2437 MHz; Duty Cycle: 1:1.018  
Medium: MSL\_2450\_150811 Medium parameters used:  $f = 2437$  MHz;  $\sigma = 1.973$  S/m;  $\epsilon_r = 52.403$ ;  $\rho = 1000$  kg/m<sup>3</sup>

**Ambient Temperature:** 23.5 °C ; **Liquid Temperature:** 22.6 °C

#### DASY5 Configuration:

- Probe: EX3DV4 - SN3819; ConvF(6.95, 6.95, 6.95); Calibrated: 2014.11.13;
- Sensor-Surface: 2mm (Mechanical Surface Detection)
- Electronics: DAE4 Sn1303; Calibrated: 2014.12.11
- Phantom: SAM2; Type: QD000P40CD; Serial: TP:1671
- Measurement SW: DASY52, Version 52.8 (8); SEMCAD X Version 14.6.10 (7331)

**Ch6/Area Scan (81x131x1):** Interpolated grid: dx=12mm, dy=12mm

Maximum value of SAR (interpolated) = 0.816 W/kg

**Ch6/Zoom Scan (7x7x7)/Cube 0:** Measurement grid: dx=5mm, dy=5mm, dz=5mm

Reference Value = 3.319 V/m; Power Drift = -0.02 dB

Peak SAR (extrapolated) = 1.11 W/kg

**SAR(1 g) = 0.526 W/kg; SAR(10 g) = 0.243 W/kg**

Maximum value of SAR (measured) = 0.807 W/kg

