



FCC PART 27  
FCC PART 22H, PART 24E  
TEST REPORT

For

**BLU Products, Inc.**

10814 NW 33rd St # 100 Doral, FL 33172, United States

**FCC ID: YHLBLUC6X**

<b>Report Type:</b> Original Report	<b>Product Type:</b> Mobile phone
<b>Report Number:</b>	RSZ190507004-00DM1
<b>Report Date:</b>	2019-06-11
<b>Reviewed By:</b>	Nancy Wang RF Engineer 
<b>Prepared By:</b>	Bay Area Compliance Laboratories Corp. (Shenzhen) 6/F., West Wing, Third Phase of Wanli Industrial Building, Shihua Road, Futian Free Trade Zone, Shenzhen, Guangdong, China Tel: +86-755-33320018 Fax: +86-755-33320008 <a href="http://www.baclcorp.com.cn">www.baclcorp.com.cn</a>

**Note:** This report must not be used by the customer to claim product certification, approval, or endorsement by A2LA\* or any agency of the Federal Government. \* This report may contain data that are not covered by the A2LA accreditation and are marked with an asterisk “\*”.

The information marked # is provided by the applicant, the laboratory is not responsible for its authenticity.

## TABLE OF CONTENTS

<b>GENERAL INFORMATION.....</b>	<b>3</b>
PRODUCT DESCRIPTION FOR EQUIPMENT UNDER TEST (EUT) .....	3
OBJECTIVE .....	3
RELATED SUBMITTAL(S)/GRANT(S).....	3
TEST METHODOLOGY .....	4
MEASUREMENT UNCERTAINTY .....	4
TEST FACILITY .....	4
<b>SYSTEM TEST CONFIGURATION.....</b>	<b>5</b>
DESCRIPTION OF TEST CONFIGURATION .....	5
EQUIPMENT MODIFICATIONS .....	5
SUPPORT EQUIPMENT LIST AND DETAILS .....	5
BLOCK DIAGRAM OF TEST SETUP .....	5
<b>SUMMARY OF TEST RESULTS.....</b>	<b>6</b>
<b>TEST EQUIPMENT LIST .....</b>	<b>7</b>
<b>FCC §1.1307(B) &amp; §2.1093 - RF EXPOSURE INFORMATION.....</b>	<b>9</b>
APPLICABLE STANDARD .....	9
TEST RESULT .....	9
<b>FCC §2.1047 - MODULATION CHARACTERISTIC .....</b>	<b>10</b>
<b>FCC § 2.1046, § 22.913 (A) &amp; § 24.232 (C); §27.50 (D) (H) - RF OUTPUT POWER .....</b>	<b>11</b>
APPLICABLE STANDARD .....	11
TEST PROCEDURE .....	11
TEST DATA .....	11
<b>FCC §2.1049, §22.917, §22.905 &amp; §24.238 &amp; §27.53 - OCCUPIED BANDWIDTH.....</b>	<b>17</b>
APPLICABLE STANDARD .....	17
TEST PROCEDURE .....	17
TEST DATA .....	17
<b>FCC §2.1051, §22.917(A) &amp; §24.238(A); §27.53 (H) (M) - SPURIOUS EMISSIONS AT ANTENNA TERMINALS.....</b>	<b>25</b>
APPLICABLE STANDARD .....	25
TEST PROCEDURE .....	25
TEST DATA .....	25
<b>FCC § 2.1053; § 22.917 (A);§ 24.238 (A); §27.53 (H)(M) SPURIOUS RADIATED EMISSIONS.....</b>	<b>33</b>
APPLICABLE STANDARD .....	33
TEST PROCEDURE .....	33
TEST DATA .....	33
<b>FCC § 22.917 (A);§ 24.238 (A); §27.53 (H)(M) - BAND EDGES .....</b>	<b>36</b>
APPLICABLE STANDARD .....	36
TEST PROCEDURE .....	36
TEST DATA .....	36
<b>FCC § 2.1055; § 22.355; § 24.235; §27.54 - FREQUENCY STABILITY .....</b>	<b>48</b>
APPLICABLE STANDARD .....	48
TEST PROCEDURE .....	48
TEST DATA .....	49

## GENERAL INFORMATION

### Product Description for Equipment under Test (EUT)

Product	Mobile Phone
Tested Model	C6
Multiple Model <sup>#</sup>	C6x
Frequency Range	Cellular: 824-849 MHz PCS: 1850-1910 MHz WCDMA B2: 1850-1910 MHz WCDMA B5: 824-849 MHz WCDMA B4: 1710- 1755 MHz
Transmit Power	GSM850: 32.15dBm, PCS1900: 39.12dBm WCDMA850: 22.32dBm, WCDMA1900: 22.75dBm, WCDMA1700: 22.49dBm
Modulation Technique	2G: GMSK 3G: BPSK, QPSK, 16QAM
Antenna Specification	2G/3G: FPC Antennas
Voltage Range	DC 3.8V from battery or DC 5.0V from adapter
Date of Test	2019-05-17~2019-05-20
Sample serial number	1234567890123
Received date	2019-05-07
Sample/EUT Status	Good condition
Adapter information	Model: TPA-46B050100UU Input: AC 100-240V, 50/60Hz, 0.2A Output: DC 5V, 1000mA

*Notes: This series products model: C6x and C6 are identical; they have the same or similar appearance, structure, PCB, Material and function to the testing products, Model C6 was selected for fully testing, the detailed information can be referred to the attached declaration which was stated and guaranteed by the applicant.*

### Objective

This test report is prepared on behalf of *BLU Products, Inc.* in accordance with Part 2-Subpart J, Part 22-Subpart H and Part 24-Subpart E and Subpart 27 of the Federal Communication Commissions rules.

The objective is to determine the compliance of the EUT with FCC rules for output power, modulation characteristic, occupied bandwidth, and spurious emission at antenna terminal, spurious radiated emission, frequency stability and band edge.

### Related Submittal(s)/Grant(s)

FCC Part 15.247 DSS, Part 15.247 DTS and Part 15B JBP submissions with FCC ID: YHLBLUC6X.

## Test Methodology

All tests and measurements indicated in this document were performed in accordance with the Code of Federal Regulations Title 47 Part 2-Subpart J as well as the following parts:

Part 22 Subpart H - Public Mobile Services  
 Part 24 Subpart E - Personal Communication Services  
 Part 27 – Miscellaneous wireless communications services

Applicable Standards: TIA/EIA 603-D.

All emissions measurement was performed at Bay Area Compliance Laboratories Corp. (Shenzhen). The radiated testing was performed at an antenna-to-EUT distance of 3 meters.

## Measurement Uncertainty

Parameter		Uncertainty
Occupied Channel Bandwidth		±5%
RF output power, conducted		±0.73dB
Unwanted Emission, conducted		±1.6dB
Emissions, Radiated	Below 1GHz	±4.75dB
	Above 1GHz	±4.88dB
Temperature		±1 °C
Humidity		±6%
Supply voltages		±0.4%

*Note: Otherwise required by the applicant or Product Regulations, Decision Rule in this report did not consider the uncertainty.*

## Test Facility

The Test site used by Bay Area Compliance Laboratories Corp. (Shenzhen) to collect test data is located on the 6/F., West Wing, Third Phase of Wanli Industrial Building, Shihua Road, Futian Free Trade Zone, Shenzhen, Guangdong, China.

The test site has been approved by the FCC under the KDB 974614 D01 and is listed in the FCC Public Access Link (PAL) database, FCC Registration No.: 342867, the FCC Designation No.: CN1221.

The test site has been registered with ISED Canada under ISED Canada Registration Number 3062B.

## SYSTEM TEST CONFIGURATION

### Description of Test Configuration

The EUT was configured for testing according to TIA/EIA-603-D.

The final qualification test was performed with the EUT operating at normal mode.

### Equipment Modifications

No modification was made to the EUT.

### Support Equipment List and Details

Manufacturer	Description	Model	Serial Number
Rohde & Schwarz	Wideband Radio Communication Tester	CMW500	1201.002K50-116218-UY
Rohde & Schwarz	Universal Radio Communication Tester	CMU200	110605

### Block Diagram of Test Setup

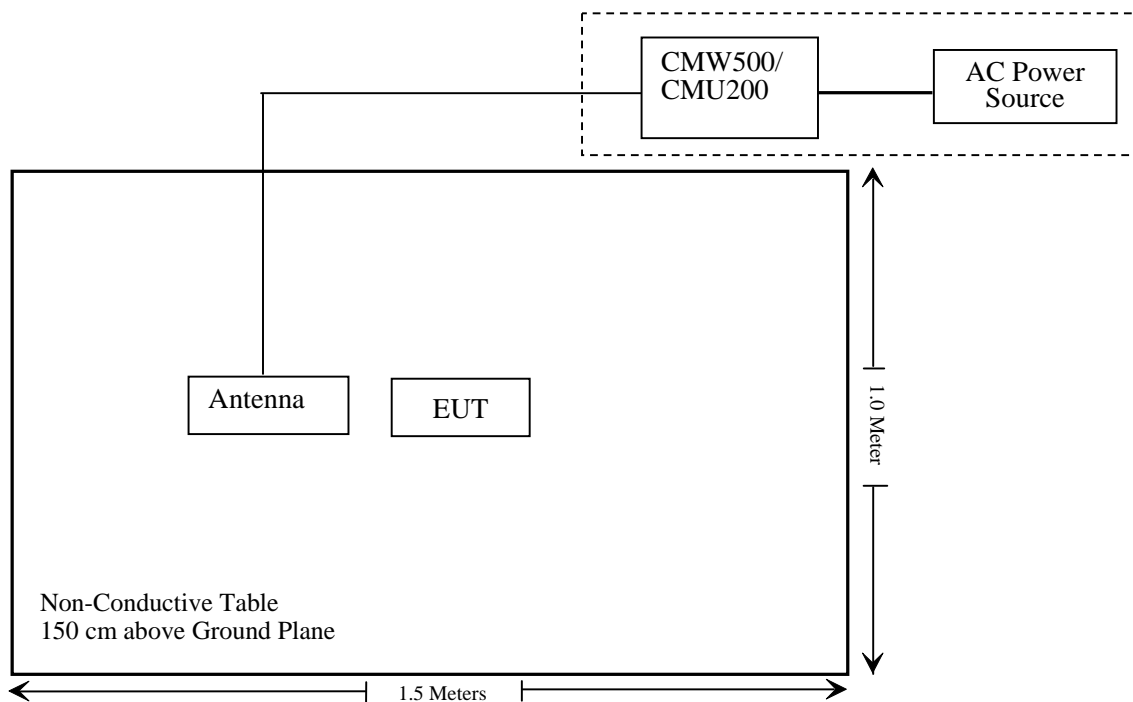

**SUMMARY OF TEST RESULTS**

<b>FCC Rules</b>	<b>Description of Test</b>	<b>Result</b>
§ 1.1307 , §2.1093	RF Exposure (SAR)	Compliance*
§2.1046; § 22.913 (a); § 24.232 (c); §27.50 (d) (h)	RF Output Power	Compliance
§ 2.1047	Modulation Characteristics	Not Applicable
§ 2.1049; § 22.905; § 22.917; § 24.238; §27.53	Occupied Bandwidth	Compliance
§ 2.1051; § 22.917 (a); § 24.238 (a); §27.53 (h)(m)	Spurious Emissions at Antenna Terminal	Compliance
§ 2.1053; § 22.917 (a); § 24.238 (a); §27.53 (h)(m)	Field Strength of Spurious Radiation	Compliance
§ 22.917 (a); § 24.238 (a); §27.53 (h)(m)	Band Edge	Compliance
§ 2.1055; § 22.355; § 24.235; §27.54;	Frequency stability	Compliance

Note: \* Please refer to SAR report released by BACL, report number: RSZ190507004-20.

**TEST EQUIPMENT LIST**

Manufacturer	Description	Model	Serial Number	Calibration Date	Calibration Due Date
<b>Radiated Emission Test</b>					
Sunol Sciences	Horn Antenna	DRH-118	A052604	2017-12-22	2020-12-21
Rohde & Schwarz	Signal Analyzer	FSEM	845987/005	2018-06-23	2019-06-23
Sunol Sciences	Broadband Antenna	JB1	A040904-1	2017-12-22	2020-12-21
COM-POWER	Pre-amplifier	PA-122	181919	2018-11-12	2019-11-12
Sonoma Instrument	Amplifier	310N	186238	2018-11-12	2019-11-12
Agilent	Signal Generator	N5183A	MY51040755	2018-12-03	2019-12-03
Rohde & Schwarz	EMI Test Receiver	ESR	1316.3003K03-101746-zn	2018-07-11	2019-07-11
COM-POWER	Dipole Antenna	AD-100	41000	NCR	NCR
A.H. System	Horn Antenna	SAS-200/571	135	2018-09-01	2021-08-31
UTiFLEX MICRO-C0AX	RF Cable	UFA147A-2362-100100	MFR64639 231029-003	2018-11-12	2019-11-12
Ducommun Technologies	RF Cable	104PEA	218124002	2018-11-12	2019-11-12
Ducommun technologies	RF Cable	RG-214	1	2018-11-19	2019-05-21
Ducommun technologies	RF Cable	RG-214	2	2018-11-12	2019-11-12
Ducommun Technologies	Horn Antenna	ARH-4223-02	1007726-04	2017-12-29	2020-12-28
Ducommun technologies	Horn Antenna	ARH-4223-02	1007726-03	2017-12-29	2020-12-28
Heatsink Required	Amplifier	QLW-18405536-J0	15964001002	2018-11-12	2019-11-12

Manufacturer	Description	Model	Serial Number	Calibration Date	Calibration Due Date
<b>RF Conducted Test</b>					
Rohde & Schwarz	Spectrum Analyzer	FSU26	200120	2019-03-02	2020-03-01
ESPEC	Temperature & Humidity Chamber	EL-10KA	9107726	2019-01-05	2020-01-05
Long Wei	DC Power Supply	TPR-6420D	398363	NCR	NCR
Rohde & Schwarz	Universal Radio Communication Tester	CMU200	106891	2019-01-15	2020-01-15
Rohde & Schwarz	Wideband Radio Communication Tester	CMW500	1316.3003K03-101746-zn	2018-08-19	2019-08-19
Ducommun Technologies	RF Cable	RG-214	3	Each Time	
WEINSCHEL	10dB Attenuator	5324	AU 3842	Each Time	
Unknown	Power Splitter	1620	129	Each Time	

\* Statement of Traceability: Bay Area Compliance Laboratories Corp. (Shenzhen) attests that all calibrations have been performed in accordance to requirements that traceable to National Primary Standards and International System of Units (SI).



---

## **FCC §1.1307(b) & §2.1093 - RF EXPOSURE INFORMATION**

---

### **Applicable Standard**

FCC§1.1310 and §2.1093.

### **Test Result**

Compliance, please refer to the SAR report: RSZ190507004-20.

## **FCC §2.1047 - MODULATION CHARACTERISTIC**

---

According to FCC § 2.1047(d), Part 22H & 24E & 27 there is no specific requirement for digital modulation, therefore modulation characteristic is not presented.

## FCC § 2.1046, § 22.913 (a) & § 24.232 (c); §27.50 (d) (h) - RF OUTPUT POWER

### Applicable Standard

According to FCC §2.1046 and §22.913 (a), the ERP of mobile transmitters and auxiliary test transmitters must not exceed 7 watts.

According to FCC §2.1046 and §24.232 (C), mobile and portable stations are limited to 2 watts EIRP and the equipment must employ a means for limiting power to the minimum necessary for successful communications.

The peak-to-average power ratio (PAPR) of the transmitter output power must not exceed 13 dB.

According to §27.50(d), the maximum EIRP must not exceed 1Watts (30dBm) for 1710-1755MHz.

According to §27.50(h), the maximum EIRP must not exceed 2Watts (33dBm) for 2500-2570MHz.

### Test Procedure

*Conducted method:*

The RF output of the transmitter was connected to the CMW500/CMU200 through sufficient attenuation.

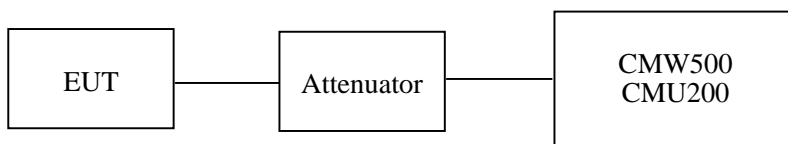

*Radiated method:*

TIA 603-D section 2.2.17

### Test Data

#### Environmental Conditions

<b>Temperature:</b>	25 °C
<b>Relative Humidity:</b>	50 %
<b>ATM Pressure:</b>	101.0 kPa

*The testing was performed by George Zhong on 2019-05-20.*

**Conducted Power**

**Cellular Band (Part 22H)**

Mode	Channel	Frequency (MHz)	Average Output Power (dBm)	Limit (dBm)
GSM	128	824.2	31.26	38.45
	190	836.6	31.34	38.45
	251	848.8	32.15	38.45

Mode	Channel	Frequency (MHz)	Average Output Power (dBm)				Limit (dBm)
			1 slot	2 slots	3 slots	4 slots	
GPRS	128	824.2	31.13	29.98	28.49	27.09	38.45
	190	836.6	31.33	30.03	28.76	27.18	38.45
	251	848.8	32.06	30.13	28.93	27.39	38.45

Mode	Test Condition	Test Mode	3GPP Sub Test	Average Output Power (dBm)		
				Low Frequency	Middle Frequency	High Frequency
WCDMA (Band V)	Normal	RMC12.2k		22.23	22.32	22.18
		HSDPA	1	21.32	21.02	21.05
			2	21.37	21.07	21.11
			3	21.43	21.10	21.14
			4	21.48	21.16	21.20
			5	21.42	21.11	21.10
		HSUPA	1	21.42	21.14	21.03
			2	21.46	21.20	21.06
			3	21.53	21.23	21.11
			4	21.59	21.30	21.14
			5	21.65	21.37	21.16

**PCS Band (Part 24E)**

Mode	Channel	Frequency (MHz)	Average Output Power (dBm)	Limit (dBm)
GSM	512	1850.2	28.86	33
	661	1880.0	28.91	33
	810	1909.8	29.12	33

Mode	Channel	Frequency (MHz)	Average Output Power (dBm)				Limit (dBm)
			1 slot	2 slots	3 slots	4 slots	
GPRS	512	1850.2	28.87	26.45	25.42	24.69	33
	661	1880.0	28.89	26.70	25.62	24.79	33
	810	1909.8	29.07	26.67	25.73	24.97	33

Mode	Test Condition	Test Mode	3GPP Sub Test	Average Output Power (dBm)		
				Low Frequency	Middle Frequency	High Frequency
WCDMA (Band II)	Normal	RMC12.2k		22.40	22.75	22.54
		HSDPA	1	21.49	21.72	21.37
			2	21.53	21.75	21.41
			3	21.36	21.83	21.45
			4	21.63	21.85	21.52
			5	21.63	21.85	21.55
		HSUPA	1	21.17	21.29	21.12
			2	21.21	21.36	21.19
			3	21.24	21.41	21.22
			4	21.34	21.44	21.30
			5	21.37	21.50	21.34

**AWS Band (Part 27)**

Mode	Test Condition	Test Mode	3GPP Sub Test	Average Output Power (dBm)		
				Low Frequency	Middle Frequency	High Frequency
WCDMA (Band IV)	Normal	RMC12.2k		22.37	22.41	22.49
		HSDPA	1	21.32	21.02	21.28
			2	21.37	21.07	21.11
			3	21.43	21.10	21.14
			4	21.48	21.64	21.20
			5	21.42	21.11	21.10
		HSUPA	1	21.86	21.14	21.03
			2	21.46	21.20	21.06
			3	21.53	21.23	21.11
			4	21.59	21.30	21.14
			5	21.65	21.37	21.16

**Peak-to-average ratio (PAR)**

**Cellular Band**

Mode	Channel	PAR (dB)	Limit (dB)
GSM	Low	1.21	13
	Middle	1.04	13
	High	1.14	13

Mode	Channel	PAR (dB)	Limit (dB)
RMC (BPSK)	Low	3.24	13
	Middle	3.33	13
	High	3.73	13
HSDPA (16QAM)	Low	3.62	13
	Middle	3.75	13
	High	3.43	13
HSUPA (BPSK)	Low	3.23	13
	Middle	3.14	13
	High	3.22	13

**PCS Band**

Mode	Channel	PAR (dB)	Limit (dB)
GSM	Low	1.32	13
	Middle	1.28	13
	High	1.22	13

Mode	Channel	PAR (dB)	Limit (dB)
RMC (BPSK)	Low	3.43	13
	Middle	3.35	13
	High	3.46	13
HSDPA (16QAM)	Low	3.76	13
	Middle	3.68	13
	High	3.82	13
HSUPA (BPSK)	Low	3.76	13
	Middle	3.91	13
	High	3.86	13

**AWS Band**

Mode	Channel	PAR (dB)	Limit (dB)
RMC (BPSK)	Low	3.24	13
	Middle	3.36	13
	High	3.11	13
HSDPA (16QAM)	Low	3.51	13
	Middle	3.36	13
	High	3.43	13
HSUPA (BPSK)	Low	3.22	13
	Middle	3.29	13
	High	3.45	13

**Radiated Power  
GSM Mode:**

Frequency (MHz)	Receiver Reading (dBµV)	Turntable Angle Degree	Rx Antenna		Substituted			Absolute Level (dBm)	Limit (dBm)	Margin (dB)
			Height (m)	Polar (H/V)	Level (dBm)	Cable loss (dB)	Antenna Gain (dBi)			
ERP for Cellular Band (Part 22H), Middle Channel										
836.6	92.37	69	2.1	H	30.0	0.7	0.0	29.30	38.45	9.15
836.6	87.29	285	1.9	V	26.9	0.7	0.0	26.20	38.45	12.25
EIRP for PCS Band (Part 24E), Middle Channel										
1880.00	89.32	348	1.2	H	19.6	1.30	9.40	27.70	33	5.30
1880.00	86.73	281	1.1	V	16.8	1.30	9.40	24.90	33	8.10

**WCDMA Mode:**

Frequency (MHz)	Receiver Reading (dBµV)	Turntable Angle Degree	Rx Antenna		Substituted			Absolute Level (dBm)	Limit (dBm)	Margin (dB)
			Height (m)	Polar (H/V)	Level (dBm)	Cable loss (dB)	Antenna Gain (dBi)			
ERP for WCDMA Band V (Part 22H), Middle Channel										
836.6	81.59	137	1.7	H	19.2	0.7	0.0	18.50	38.45	19.95
836.6	75.42	187	1.2	V	15.0	0.7	0.0	14.30	38.45	24.15
EIRP for WCDMA Band II (Part 24E), Middle Channel										
1880.00	79.94	95	1.6	H	10.3	1.30	9.40	18.40	33	14.60
1880.00	78.42	197	2.1	V	8.5	1.30	9.40	16.60	33	16.40
EIRP for WCDMA Band IV (Part 27), Middle Channel										
1732.60	85.71	323	1.3	H	12.4	1.30	8.90	20.00	30	10.00
1732.60	84.40	34	2.0	V	11.7	1.30	8.90	19.30	30	10.70

**Note:**

Absolute Level = Substituted Level - Cable loss + Antenna Gain

Margin = Limit - Absolute Level



## FCC §2.1049, §22.917, §22.905 & §24.238 & §27.53 - OCCUPIED BANDWIDTH

### Applicable Standard

FCC 47 §2.1049, §22.917, §22.905, §24.238 and §27.53.

### Test Procedure

The RF output of the transmitter was connected to the simulator and the spectrum analyzer through sufficient attenuation.

The resolution bandwidth of the spectrum analyzer was set at 1% to 5% of the anticipated emission bandwidth and the 26 dB & 99% bandwidth was recorded.

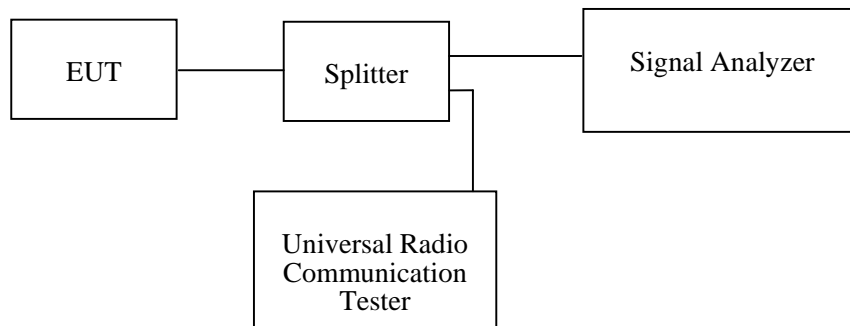

### Test Data

#### Environmental Conditions

<b>Temperature:</b>	25 °C
<b>Relative Humidity:</b>	55 %
<b>ATM Pressure:</b>	101.0 kPa

*The testing was performed by George Zhong on 2019-05-17.*

*EUT operation mode: Transmitting*

Test Result: Compliance. Please refer to the following tables and plots.

### Cellular Band (Part 22H)

Mode	Frequency (MHz)	99% Occupied Bandwidth (kHz)	26 dB Emission Bandwidth (kHz)
GSM(GMSK)	836.6	245.19	314.42

Mode	Frequency (MHz)	99% Occupied Bandwidth (MHz)	26 dB Emission Bandwidth (MHz)
RMC (BPSK)	836.6	4.15	4.70
HSUPA (BPSK)	836.6	4.17	4.68
HSDPA (16QAM)	836.6	4.17	4.71

### PCS Band (Part 24E)

Mode	Frequency (MHz)	99% Occupied Bandwidth (kHz)	26 dB Emission Bandwidth (kHz)
GSM(GMSK)	1880.0	245.19	322.44

Mode	Frequency (MHz)	99% Occupied Bandwidth (MHz)	26 dB Emission Bandwidth (MHz)
RMC (BPSK)	1880.0	4.15	4.70
HSUPA (BPSK)	1880.0	4.17	4.70
HSDPA (16QAM)	1880.0	4.17	4.70

### AWS Band (Part 27)

Mode	Frequency (MHz)	99% Occupied Bandwidth (MHz)	26 dB Emission Bandwidth (MHz)
RMC (BPSK)	1732.6	4.18	4.70
HSUPA (BPSK)	1732.6	4.18	4.70
HSDPA (16QAM)	1732.6	4.18	4.68

**Cellular Band (Part 22H)**

**26 dB Emissions & 99% Occupied Bandwidth for GSM (GMSK) Mode**

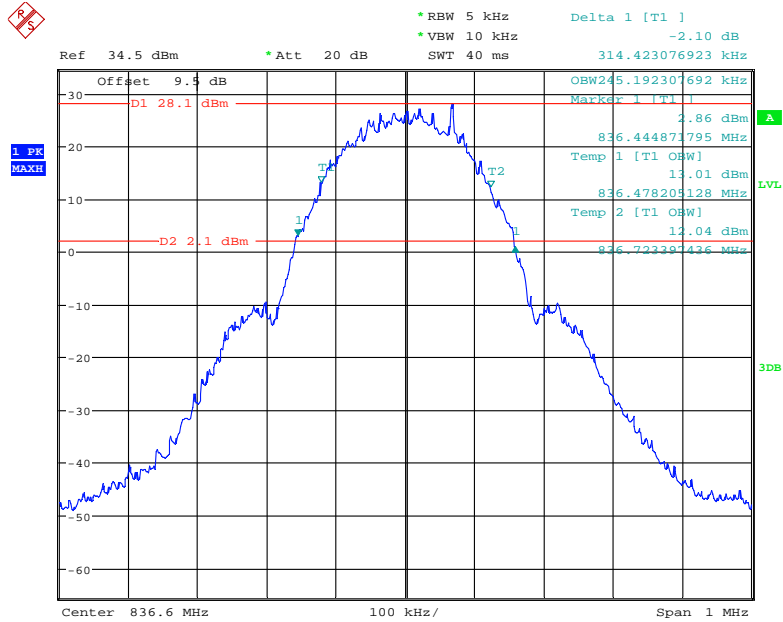

Date: 17.MAY.2019 09:32:04

**26 dB Emissions & 99% Occupied Bandwidth for RMC (BPSK) Mode**

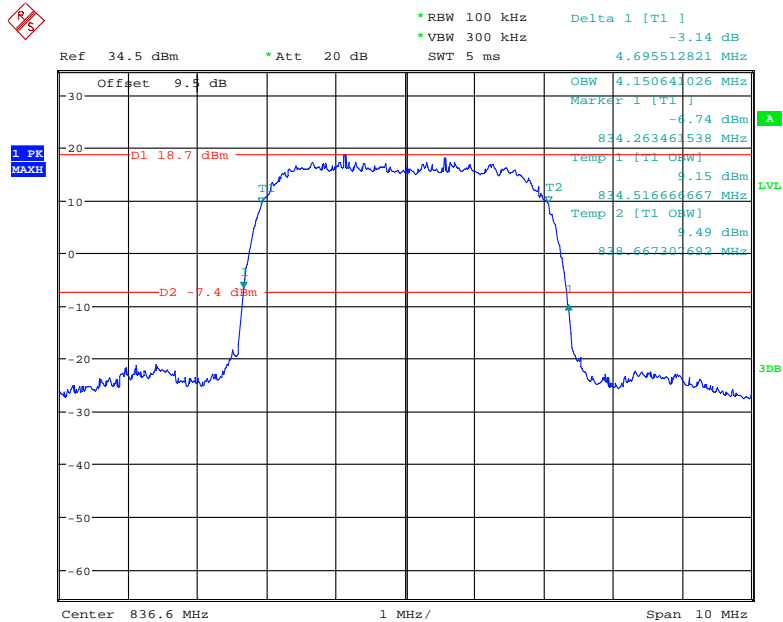

Date: 17.MAY.2019 11:53:13

**26 dB Emissions & 99% Occupied Bandwidth for HSUPA (BPSK) Mode**

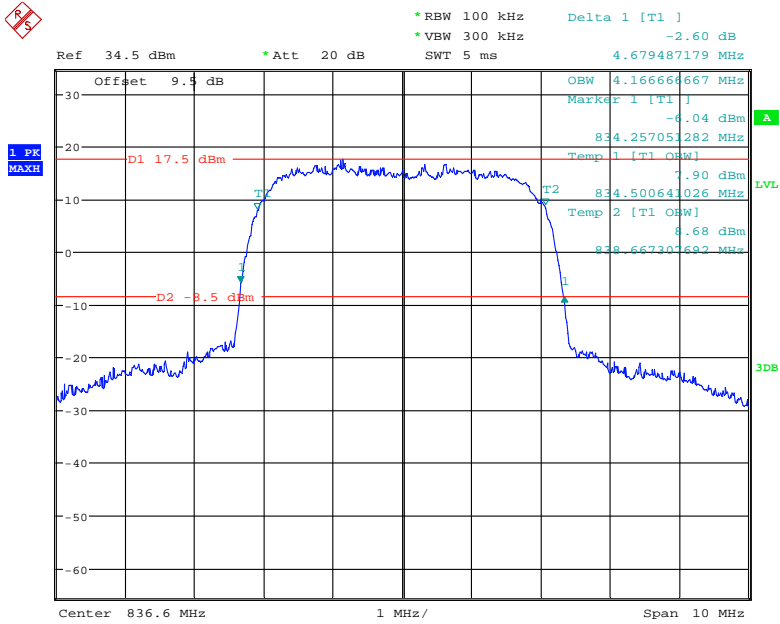

Date: 17.MAY.2019 13:28:09

**26 dB Emissions & 99% Occupied Bandwidth for HSDPA (16QAM) Mode**

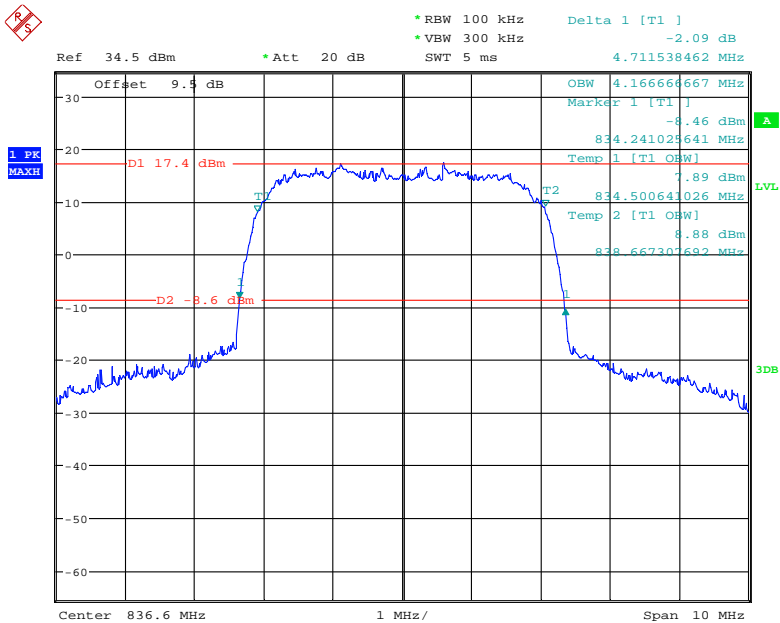

Date: 17.MAY.2019 13:24:35

PCS Band (Part 24E)

26 dB Emissions & 99% Occupied Bandwidth for GSM (GMSK) Mode

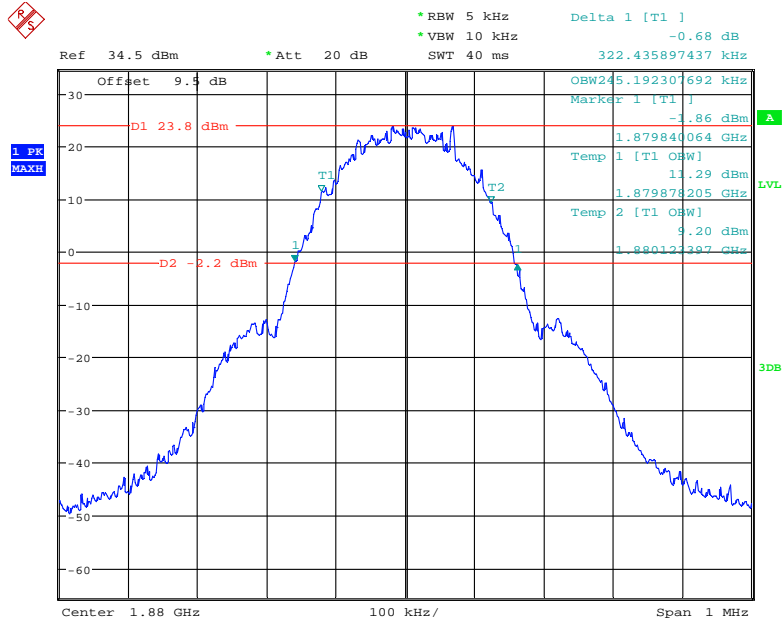

Date: 17.MAY.2019 10:26:31

26 dB Emissions & 99% Occupied Bandwidth for RMC (BPSK) Mode

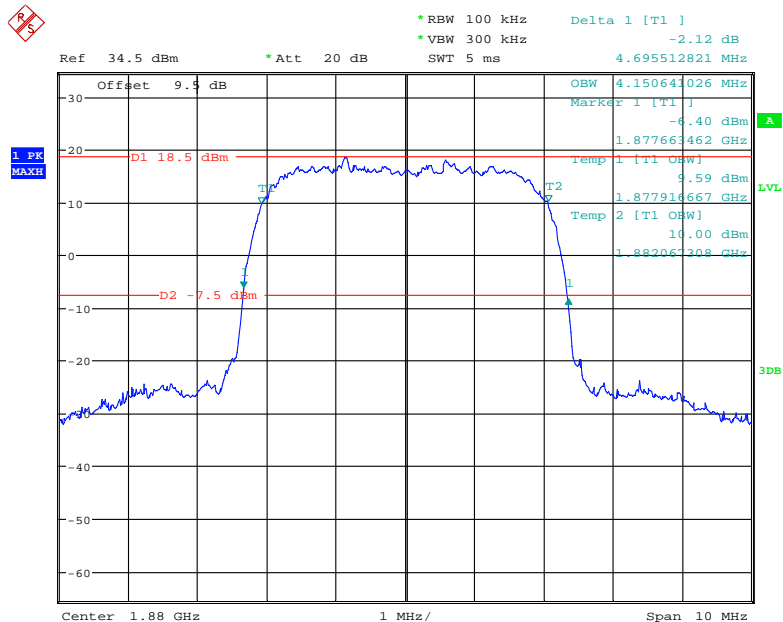

Date: 17.MAY.2019 13:34:26

**26 dB Emissions & 99% Occupied Bandwidth for HSUPA (BPSK) Mode**

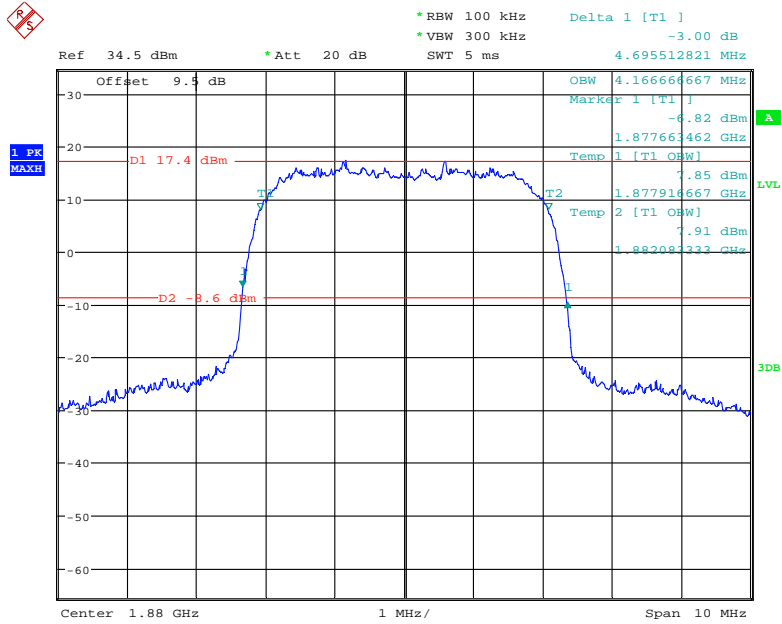

Date: 17.MAY.2019 14:14:08

**26 dB Emissions & 99% Occupied Bandwidth for HSDPA (16QAM) Mode**

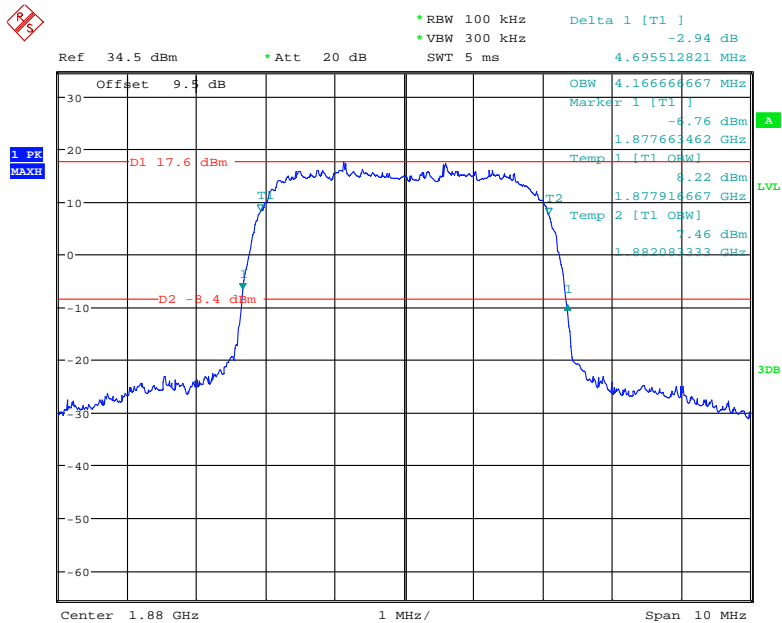

Date: 17.MAY.2019 14:11:40

**AWS Band (Part 27)**

**26 dB Emissions & 99% Occupied Bandwidth for GSM (GMSK) Mode**

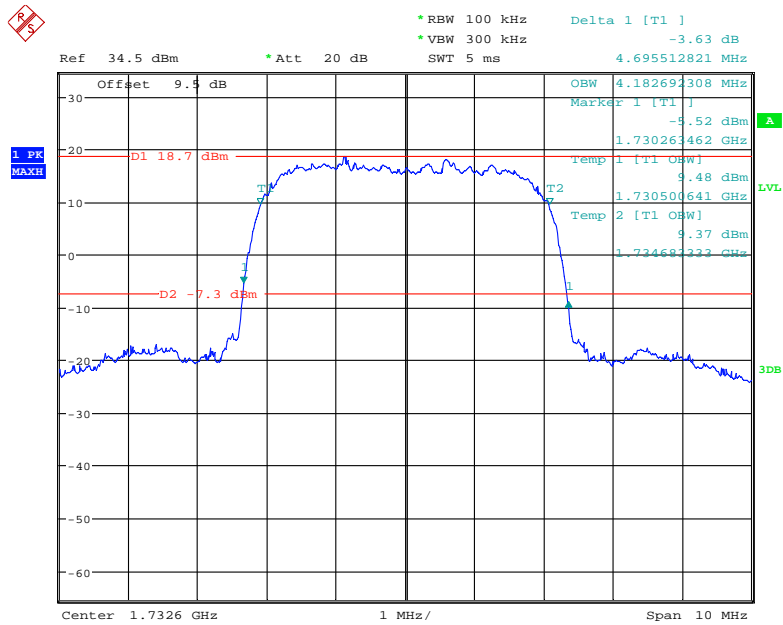

Date: 17.MAY.2019 14:22:21

**26 dB Emissions & 99% Occupied Bandwidth for HSUPA (BPSK) Mode**

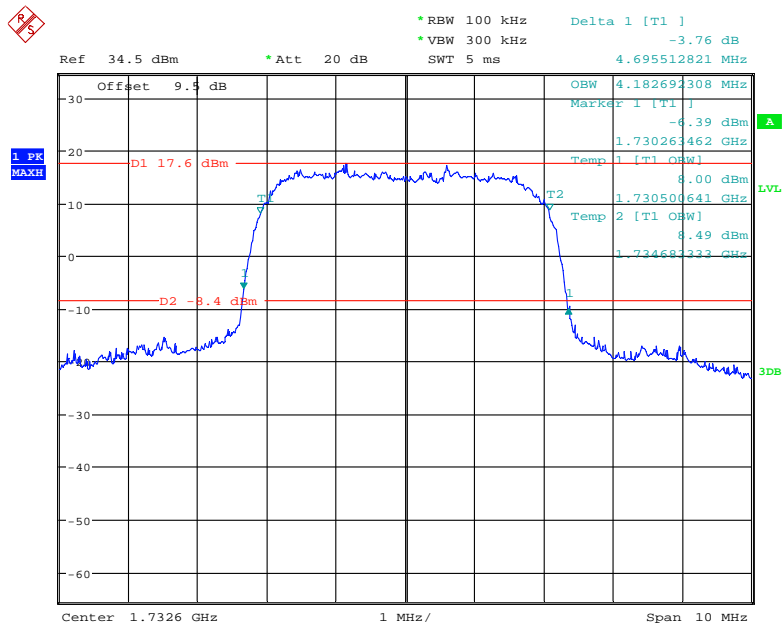

Date: 17.MAY.2019 14:34:20

**26 dB Emissions & 99% Occupied Bandwidth for HSDPA (16QAM) Mode**

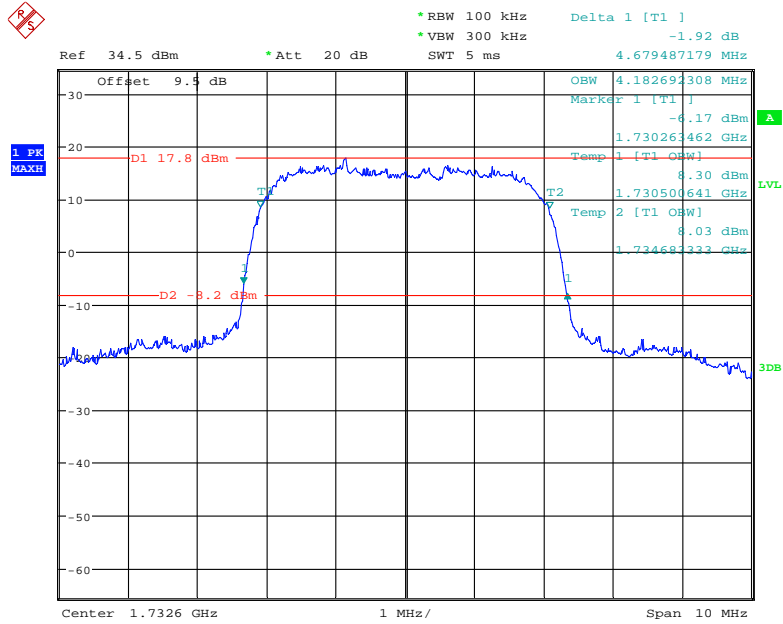

Date: 17.MAY.2019 14:36:54



**FCC §2.1051, §22.917(a) & §24.238(a); §27.53 (h) (m) - SPURIOUS EMISSIONS AT ANTENNA TERMINALS**

**Applicable Standard**

FCC §2.1051, §22.917(a) and §24.238(a) and §27.53(h) (m).

The spectrum was to be investigated to the tenth harmonics of the highest fundamental frequency as specified in § 2.1051.

**Test Procedure**

The RF output of the transceiver was connected to a spectrum analyzer and simulator through appropriate attenuation. The resolution bandwidth of the spectrum analyzer was set at 1MHz. Sufficient scans were taken to show any out of band emissions up to 10<sup>th</sup> harmonic.

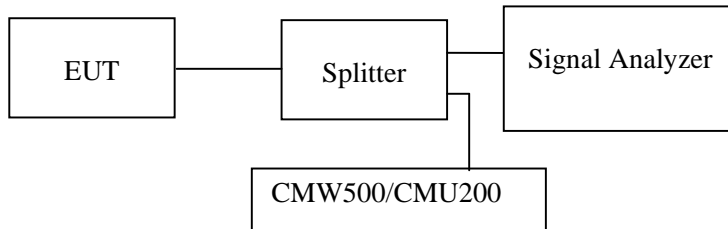

**Test Data**

**Environmental Conditions**

<b>Temperature:</b>	25 °C
<b>Relative Humidity:</b>	55 %
<b>ATM Pressure:</b>	101.0 kPa

*The testing was performed by George Zhong on 2019-05-17.*

*Test result: Compliance.*

*EUT operation mode: transmitting*

*Please refer to the following plots.*

Cellular Band (Part 22H)

30 MHz – 1 GHz (GSM Mode)

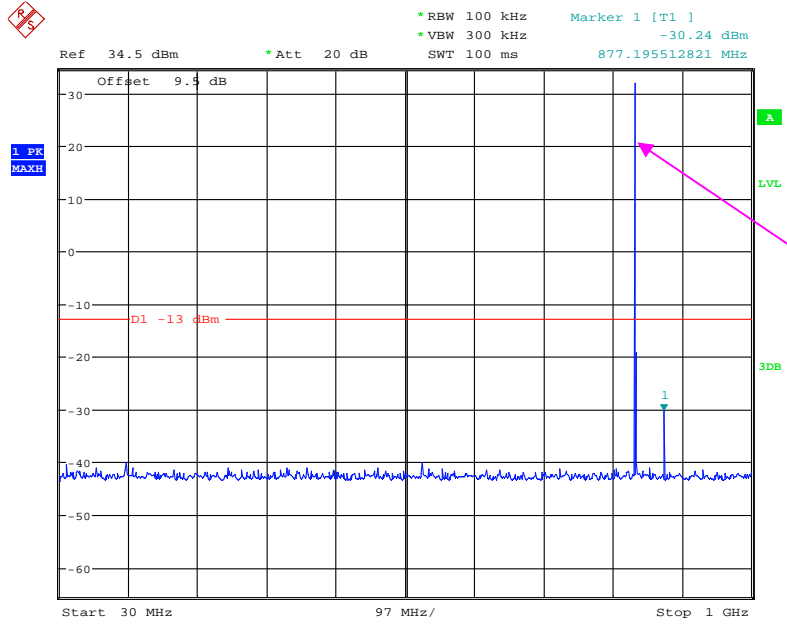

Fundamental test

Date: 17.MAY.2019 10:15:23

1 GHz – 10 GHz (GSM Mode)

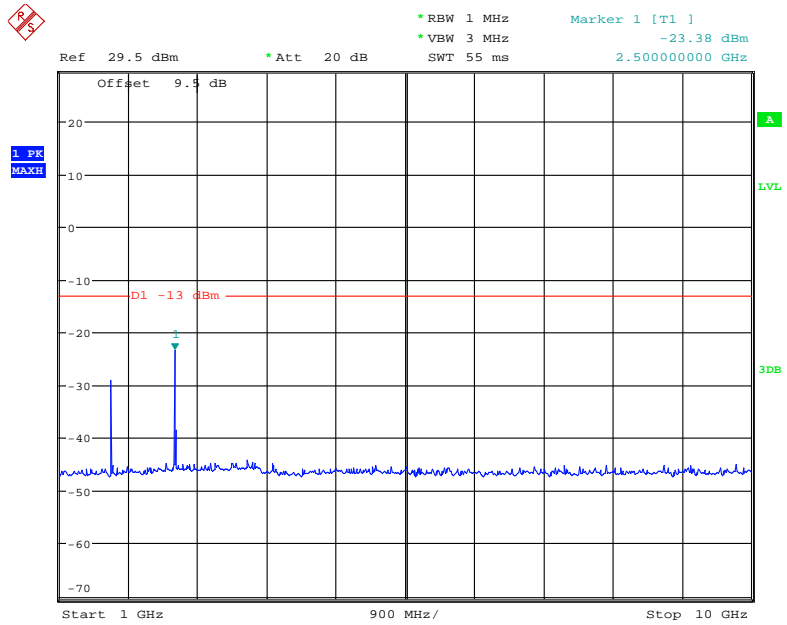

Date: 17.MAY.2019 09:55:16

### 30 MHz – 1 GHz (WCDMA Mode)

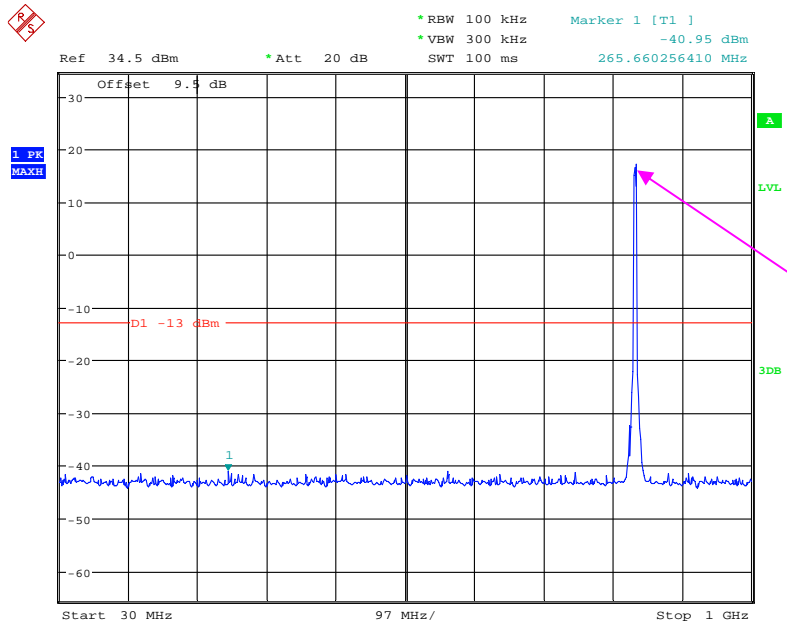

Date: 17.MAY.2019 11:56:10

### 1 GHz – 10 GHz (WCDMA Mode)

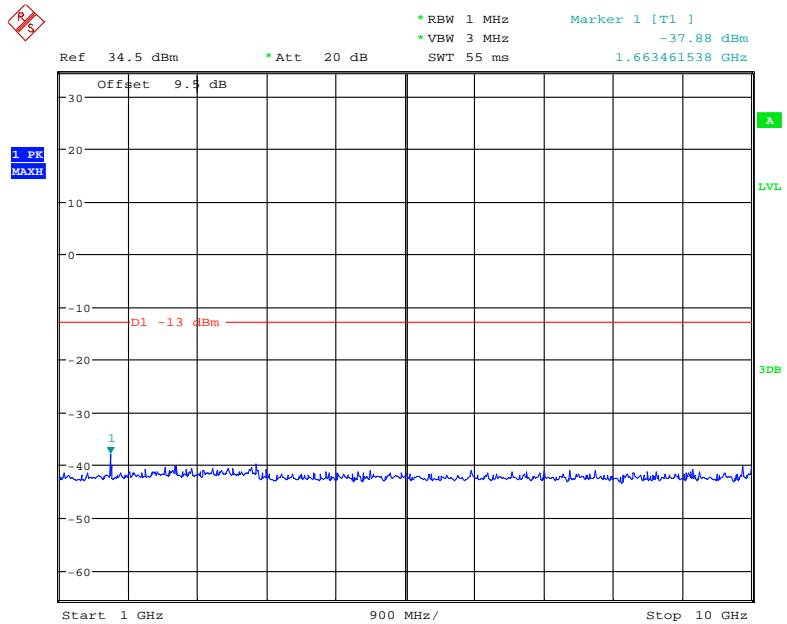

Date: 17.MAY.2019 11:45:55

PCS Band (Part 24E)

30 MHz – 1 GHz (GSM Mode)

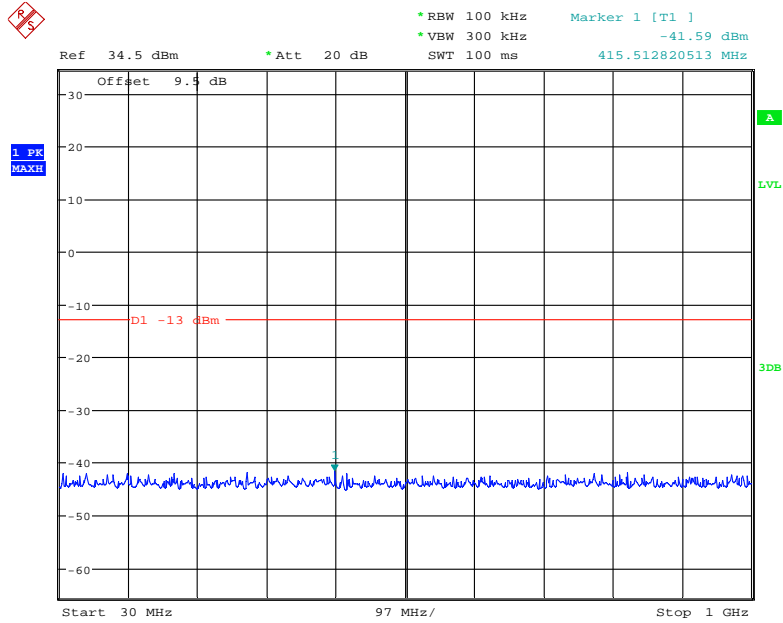

Date: 17.MAY.2019 10:13:10

1 GHz – 2 GHz (GSM Mode)

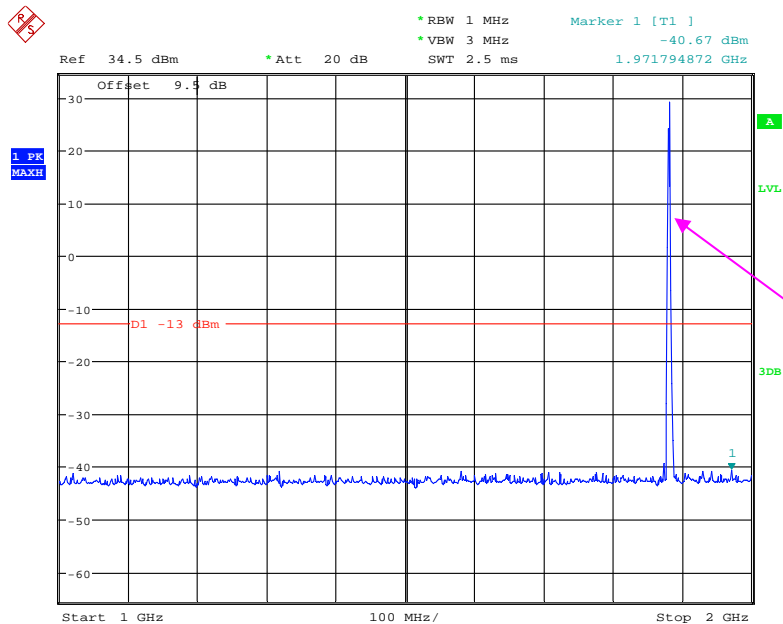

Date: 17.MAY.2019 10:10:49

### 2 GHz – 20 GHz (GSM Mode)

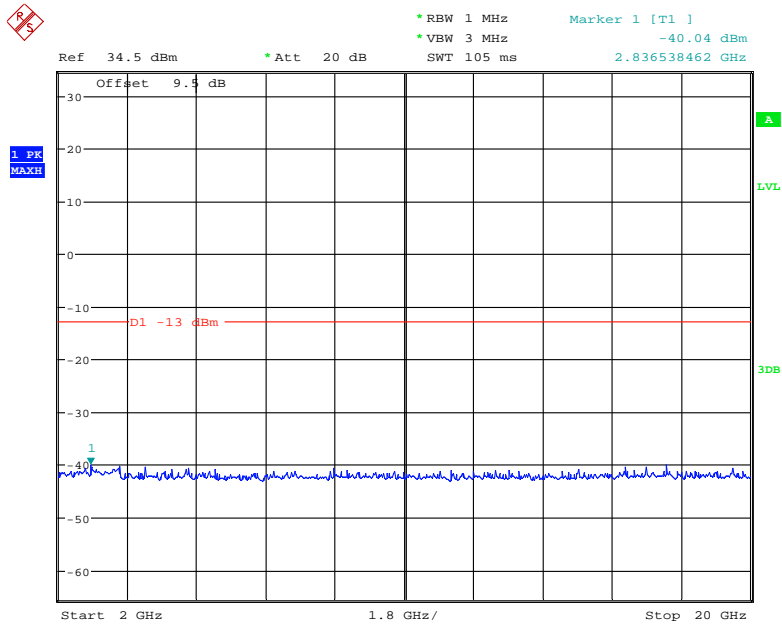

Date: 17.MAY.2019 10:12:08

### 30 MHz – 1 GHz (WCDMA Mode)

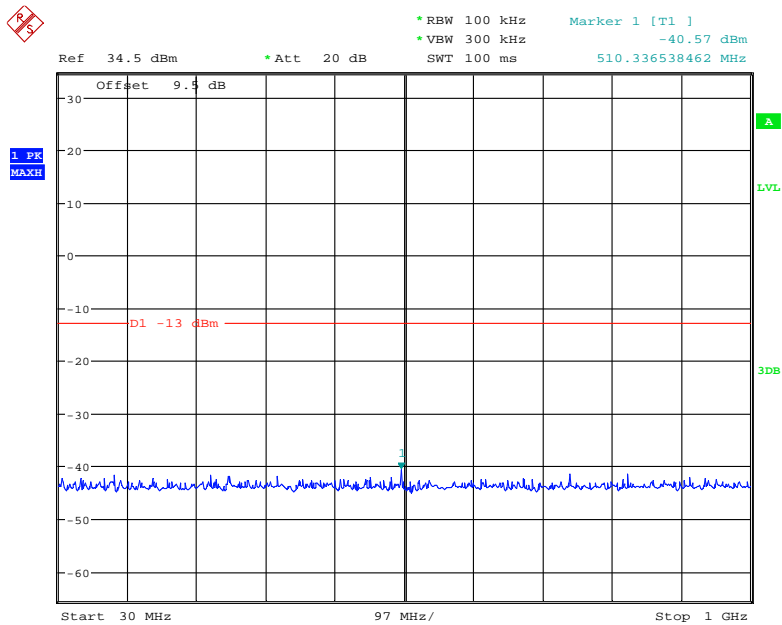

Date: 17.MAY.2019 11:17:43

### 1 GHz – 2 GHz (WCDMA Mode)

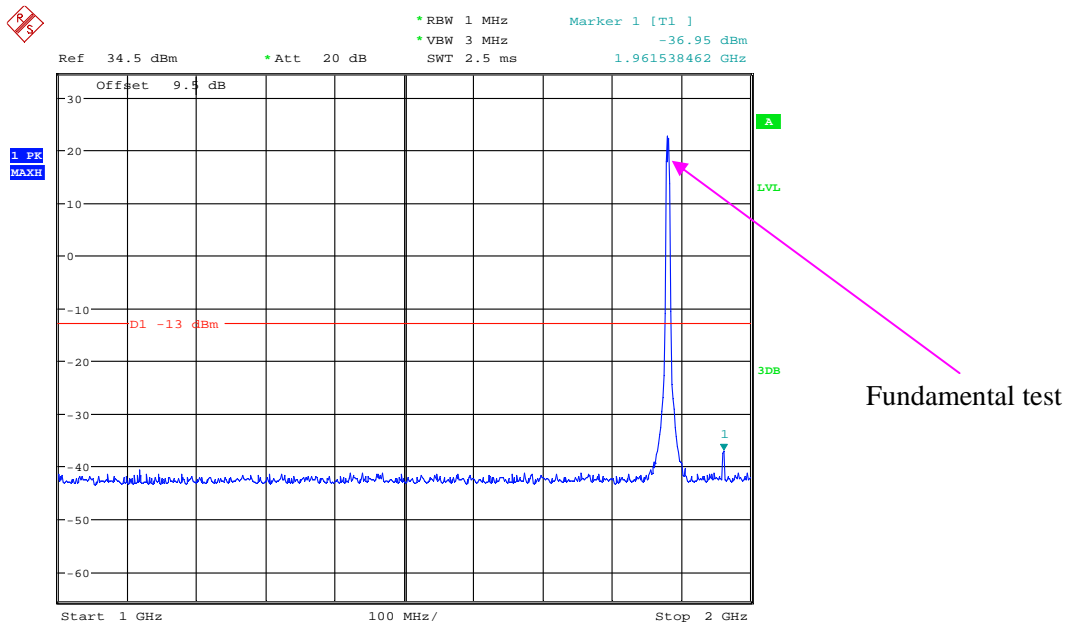

Date: 17.MAY.2019 11:15:06

### 2 GHz – 20 GHz (WCDMA Mode)

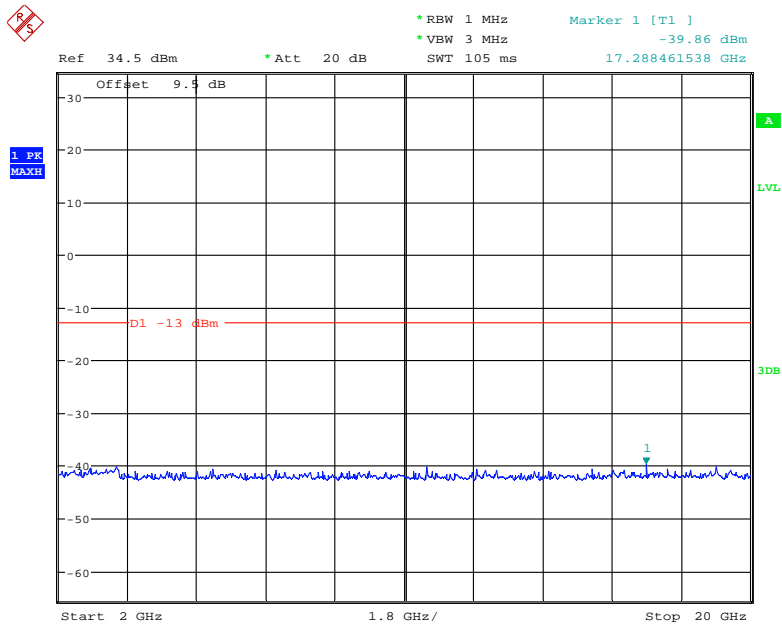

Date: 17.MAY.2019 11:16:55

AWS Band (Part 27)

30 MHz – 1 GHz (WCDMA Mode)

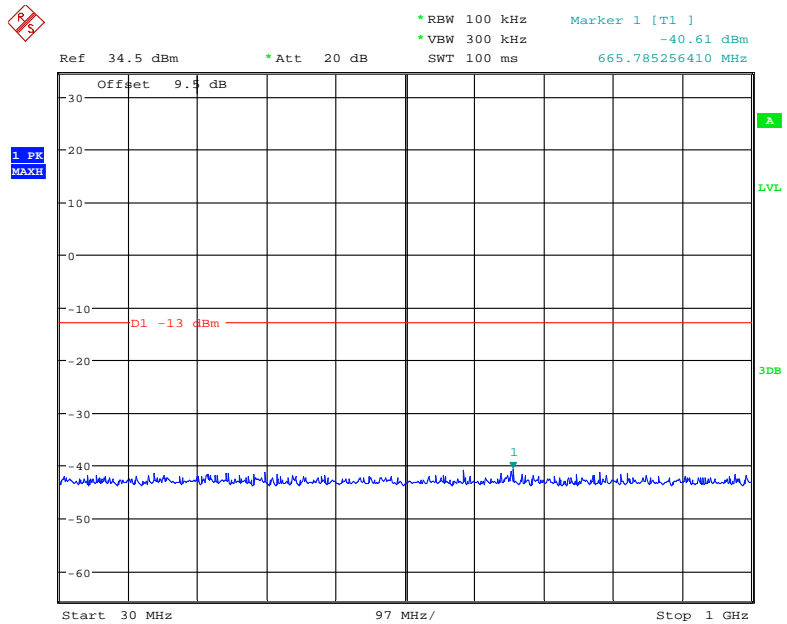

Date: 17.MAY.2019 11:39:08

1 GHz – 2 GHz (WCDMA Mode)

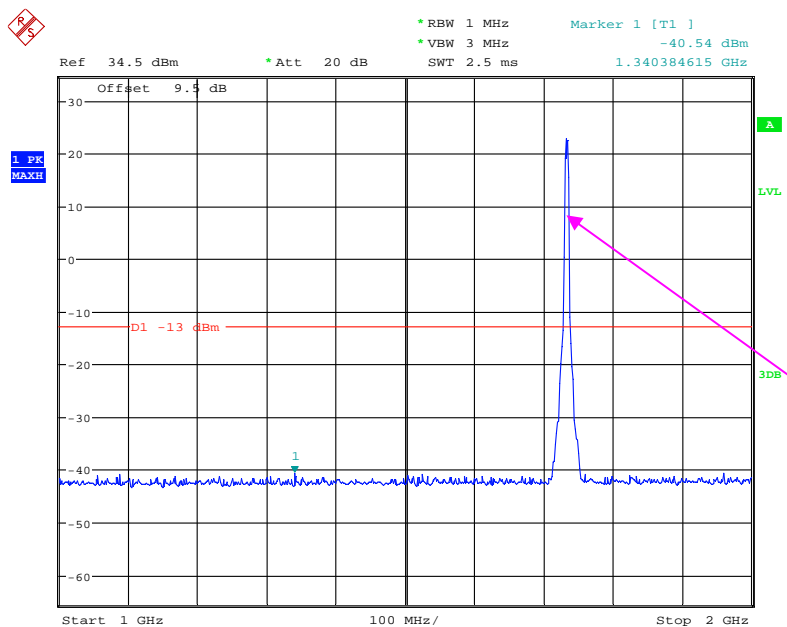

Date: 17.MAY.2019 11:41:16

### 2 GHz – 20 GHz (WCDMA Mode)

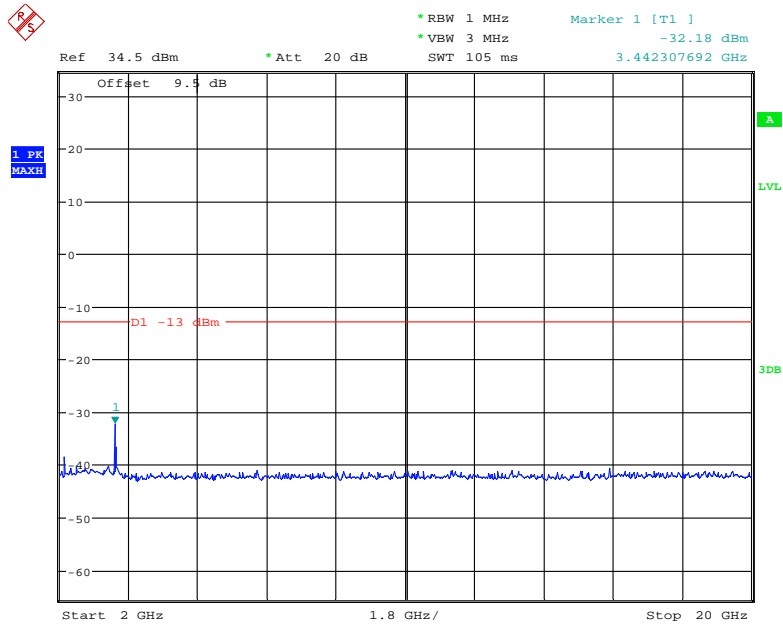

Date: 17.MAY.2019 11:42:50



**FCC § 2.1053; § 22.917 (a); § 24.238 (a); § 27.53 (h)(m) SPURIOUS RADIATED EMISSIONS****Applicable Standard**

FCC § 2.1053, § 22.917(a) and § 24.238(a) and § 27.53(h)(m)

**Test Procedure**

The transmitter was placed on a wooden turntable, and it was transmitting into a non-radiating load which was also placed on the turntable.

The measurement antenna was placed at a distance of 3 meters from the EUT. During the tests, the receiving antenna height and polarization as well as EUT azimuth were varied in order to identify the maximum level of emissions from the EUT. The test was performed by placing the EUT on 3-orthogonal axis.

The frequency range up to tenth harmonic of the fundamental frequency was investigated.

**Test Data****Environmental Conditions**

<b>Temperature:</b>	25 °C
<b>Relative Humidity:</b>	50 %
<b>ATM Pressure:</b>	101.0 kPa

*The testing was performed by George Zhong on 2019-05-20.*

*EUT operation mode: Transmitting*

Pre-scan with Low, Middle and High channel, the worst case as below:

30 MHz ~ 10 GHz:

**Cellular Band (Part 22H)**

Frequency (MHz)	Receiver Reading (dBµV)	Turntable Angle Degree	Rx Antenna		Substituted			Absolute Level (dBm)	FCC Part 22H	
			Height (m)	Polar (H/V)	Level (dBm)	Cable Loss (dB)	Antenna Gain (dBi)		Limit (dBm)	Margin (dB)
GSM Mode, middle channel										
256.00	33.89	32	2.3	H	-63.1	0.32	0	-63.42	-13	50.42
256.00	33.40	8	1.3	V	-63.6	0.32	0	-63.92	-13	50.92
1673.20	72.96	241	1.9	H	-33.4	1.30	8.90	-25.80	-13	12.80
1673.20	71.77	127	1.6	V	-34.0	1.30	8.90	-26.40	-13	13.40
2509.80	63.53	124	1.4	H	-39.8	2.60	10.20	-32.20	-13	19.20
2509.80	64.99	347	2.4	V	-37.8	2.60	10.20	-30.20	-13	17.20
3346.40	44.14	228	2.2	H	-56.8	1.50	11.70	-46.60	-13	33.60
3346.40	44.24	288	2.4	V	-56.7	1.50	11.70	-46.50	-13	33.50
WCDMA Mode, Middle channel										
256.00	33.59	173	1.3	H	-63.4	0.32	0	-63.72	-13	50.72
256.00	32.41	304	1.0	V	-64.6	0.32	0	-64.92	-13	51.92
1673.20	43.21	149	2.1	H	-63.1	1.30	8.90	-55.50	-13	42.50
1673.20	43.04	274	1.8	V	-62.7	1.30	8.90	-55.10	-13	42.10
2509.80	48.09	152	1.9	H	-55.3	2.60	10.20	-47.70	-13	34.70
2509.80	45.38	164	1.5	V	-57.4	2.60	10.20	-49.80	-13	36.80
3346.40	42.66	290	1.4	H	-58.2	1.50	11.70	-48.00	-13	35.00
3346.40	42.03	153	2.1	V	-58.9	1.50	11.70	-48.70	-13	35.70

**30 MHz ~ 20 GHz:**

**PCS Band (Part 24E)**

Frequency (MHz)	Receiver Reading (dBµV)	Turntable Angle Degree	Rx Antenna		Substituted			Absolute Level (dBm)	FCC Part 24E	
			Height (m)	Polar (H/V)	Level (dBm)	Cable Loss (dB)	Antenna Gain (dBi)		Limit (dBm)	Margin (dB)
GSM Mode, middle channel										
256.00	32.46	65	1.5	H	-64.5	0.32	0	-64.82	-13	51.82
256.00	33.30	346	1.1	V	-63.7	0.32	0	-64.02	-13	51.02
3760.00	45.29	235	1.3	H	-56.8	1.50	11.80	-46.50	-13	33.50
3760.00	46.74	202	1.9	V	-54.8	1.50	11.80	-44.50	-13	31.50
WCDMA Mode Band II, Middle channel										
256.00	32.77	23	2.0	H	-64.2	0.32	0	-64.52	-13	51.52
256.00	32.02	91	1.4	V	-65.0	0.32	0	-65.32	-13	52.32
3760.00	58.40	296	2.4	H	-43.7	1.50	11.80	-33.40	-13	20.40
3760.00	53.72	198	2.4	V	-47.9	1.50	11.80	-37.60	-13	24.60

**30 MHz ~ 20 GHz:**

**AWS Band (Part 27)**

Frequency (MHz)	Receiver Reading (dBµV)	Turntable Angle Degree	Rx Antenna		Substituted			Absolute Level (dBm)	FCC Part 27	
			Height (m)	Polar (H/V)	Level (dBm)	Cable Loss (dB)	Antenna Gain (dBi)		Limit (dBm)	Margin (dB)
WCDMA Mode Band IV, Middle channel										
256.00	32.66	12	1.4	H	-64.3	0.32	0	-64.62	-13	51.62
256.00	33.22	102	1.6	V	-63.8	0.32	0	-64.12	-13	51.12
3465.20	53.12	279	2.3	H	-47.6	1.50	12.00	-37.10	-13	24.10
3465.20	52.96	155	2.5	V	-48.5	1.50	12.00	-38.00	-13	25.00

**Note:**

- 1) Absolute Level = Substituted Level - Cable loss + Antenna Gain
- 2) Margin = Limit- Absolute Level

**FCC § 22.917 (a); § 24.238 (a); § 27.53 (h)(m) - BAND EDGES**

**Applicable Standard**

According to § 22.917(a), the power of any emissions outside of the authorized operating frequency ranges must be attenuated below the transmitting power (P) by a factor of at least  $43 + 10 \log(P)$  dB.

According to § 24.238(a), the power of any emissions outside of the authorized operating frequency ranges must be attenuated below the transmitting power (P) by a factor of at least  $43 + 10 \log(P)$  dB.

According to FCC § 27.53 (h)(m), the power of any emission outside of the authorized operating frequency ranges must be attenuated below the transmitting power (P) by a factor of at least  $43 + 10 \log(P)$  dB.

**Test Procedure**

The RF output of the transmitter was connected to the input of the spectrum analyzer through sufficient attenuation.

The center of the spectrum analyzer was set to block edge frequency

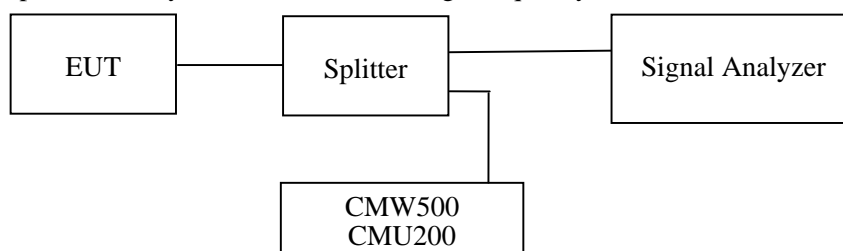

**Test Data**

**Environmental Conditions**

<b>Temperature:</b>	25 °C
<b>Relative Humidity:</b>	55 %
<b>ATM Pressure:</b>	101.0 kPa

*The testing was performed by George Zhong on 2019-05-17.*

*EUT operation mode: Transmitting*

*Test Result: Compliance. Please refer to the following plots.*

### Cellular Band, Left Band Edge for GSM (GMSK) Mode

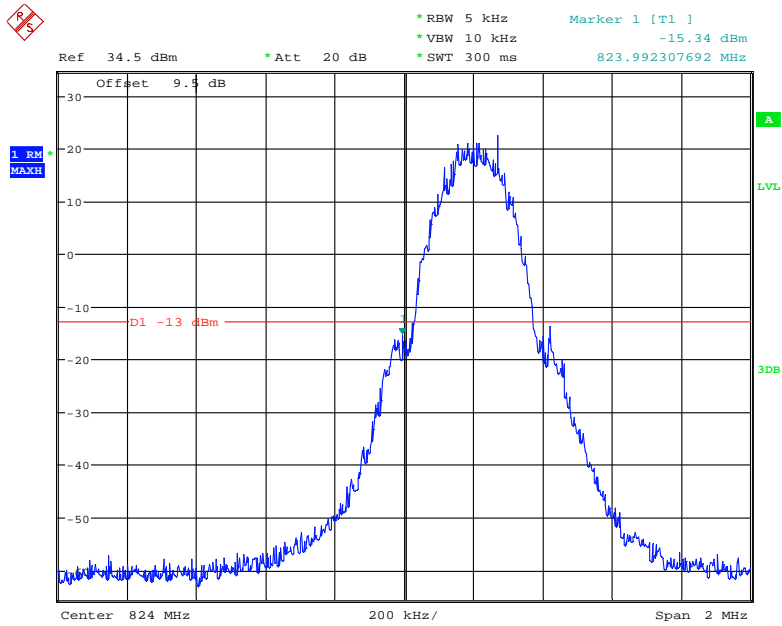

Date: 17.MAY.2019 09:22:32

### Cellular Band, Right Band Edge for GSM (GMSK) Mode

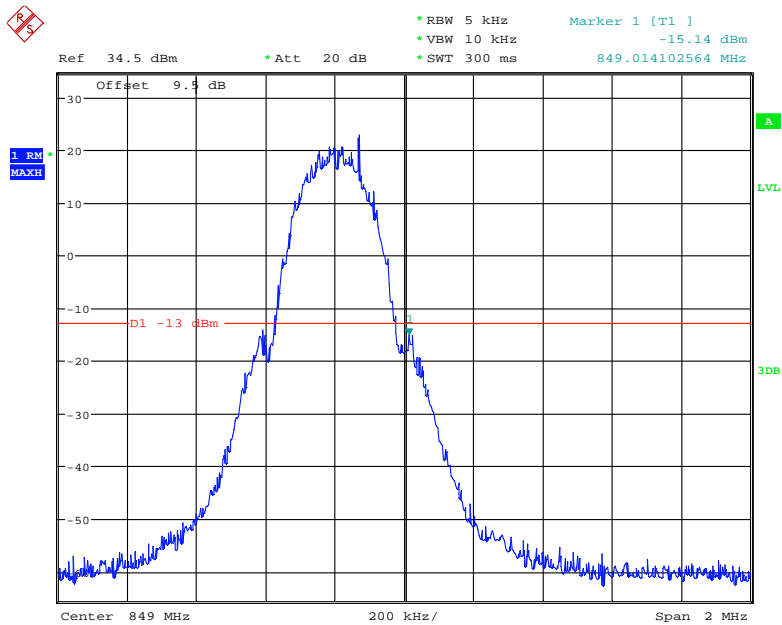

Date: 17.MAY.2019 09:26:34

### Cellular Band, Left Band Edge for WCDMA (BPSK) Mode

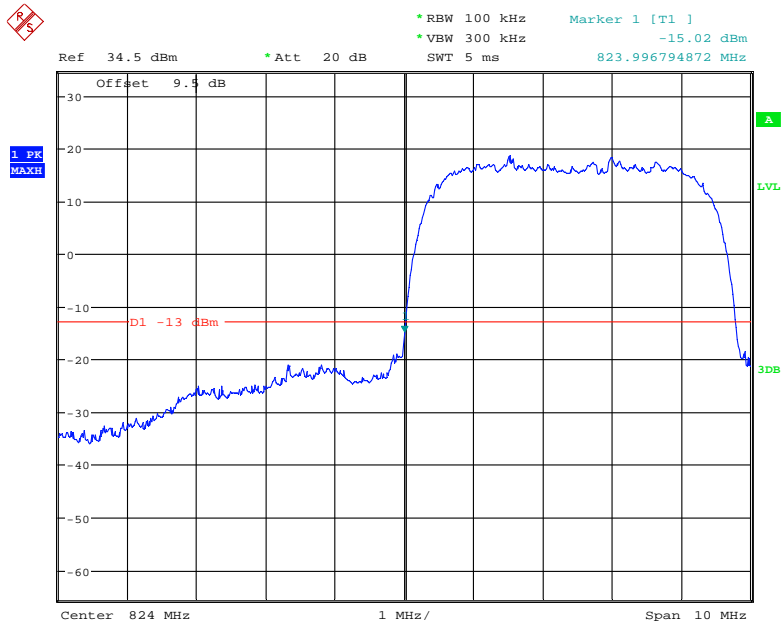

Date: 17.MAY.2019 12:00:37

### Cellular Band, Right Band Edge for WCDMA (BPSK) Mode

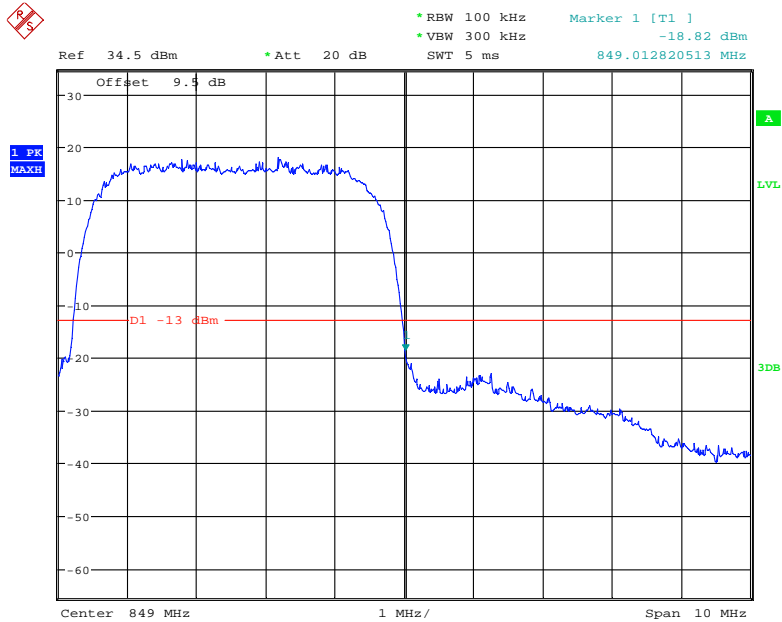

Date: 17.MAY.2019 12:02:08

### Cellular Band, Left Band Edge for HSDPA (16QAM) Mode

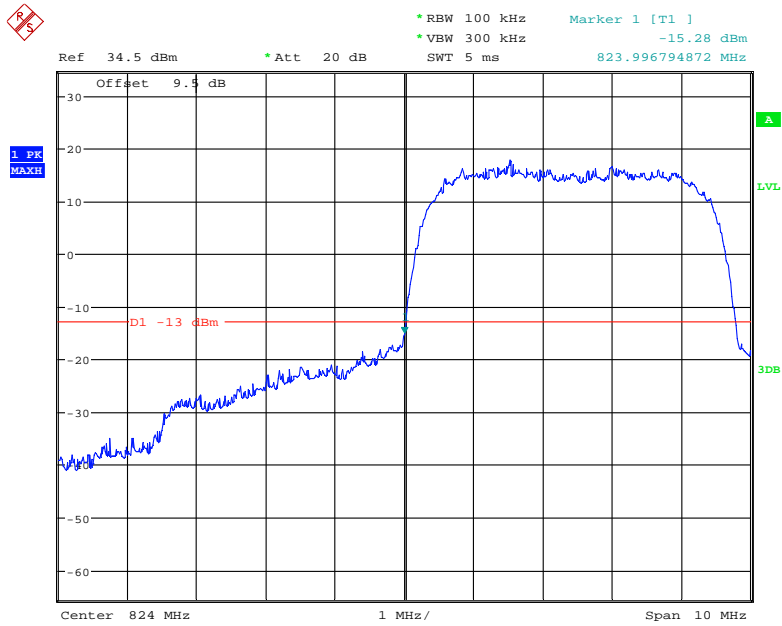

Date: 17.MAY.2019 13:19:14

### Cellular Band, Right Band Edge for HSDPA (16QAM) Mode

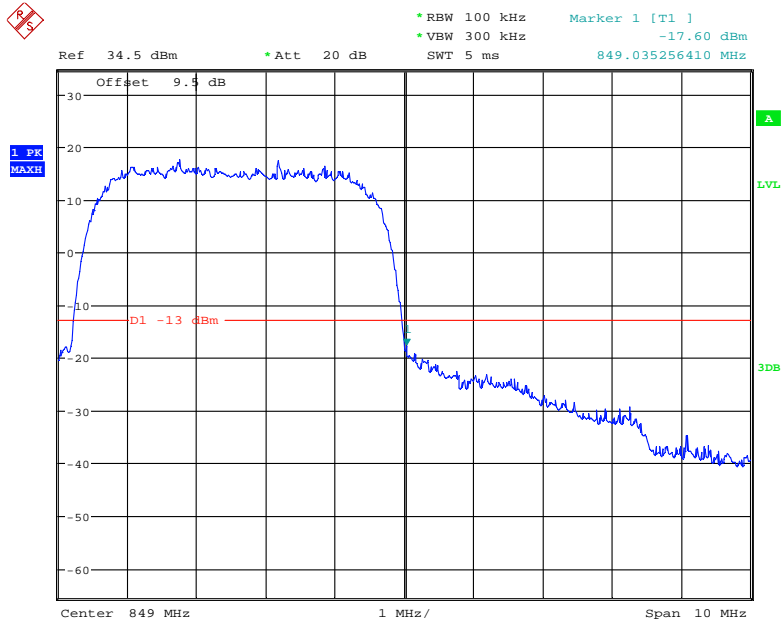

Date: 17.MAY.2019 13:20:44

### Cellular Band, Left Band Edge for HSUPA (BPSK) Mode

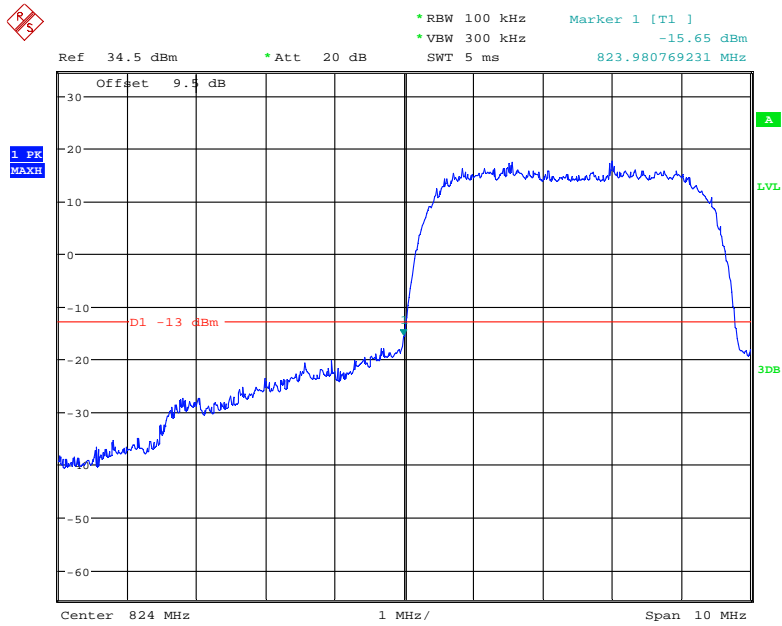

Date: 17.MAY.2019 13:17:13

### Cellular Band, Right Band Edge for HSUPA (BPSK) Mode

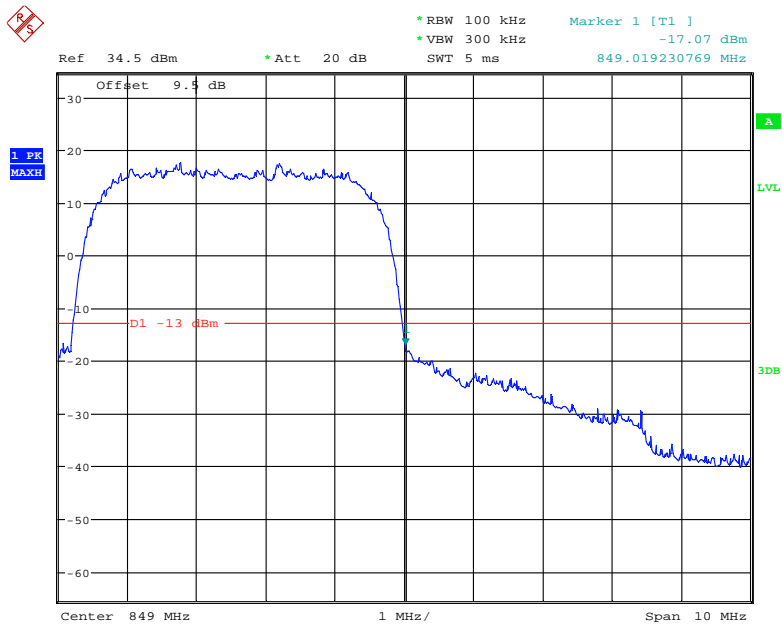

Date: 17.MAY.2019 13:14:28



### PCS Band, Left Band Edge for GSM (GMSK) Mode

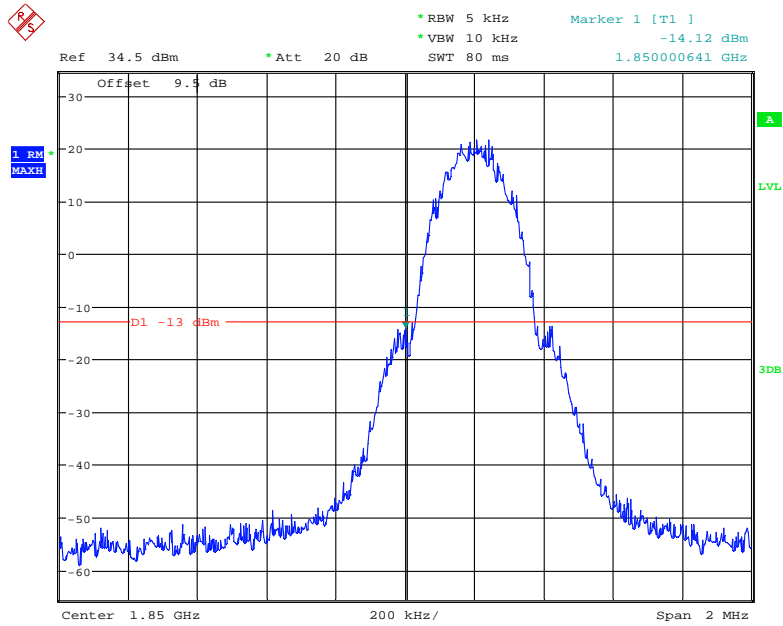

Date: 17.MAY.2019 10:32:48

### PCS Band, Right Band Edge for GSM (GMSK) Mode

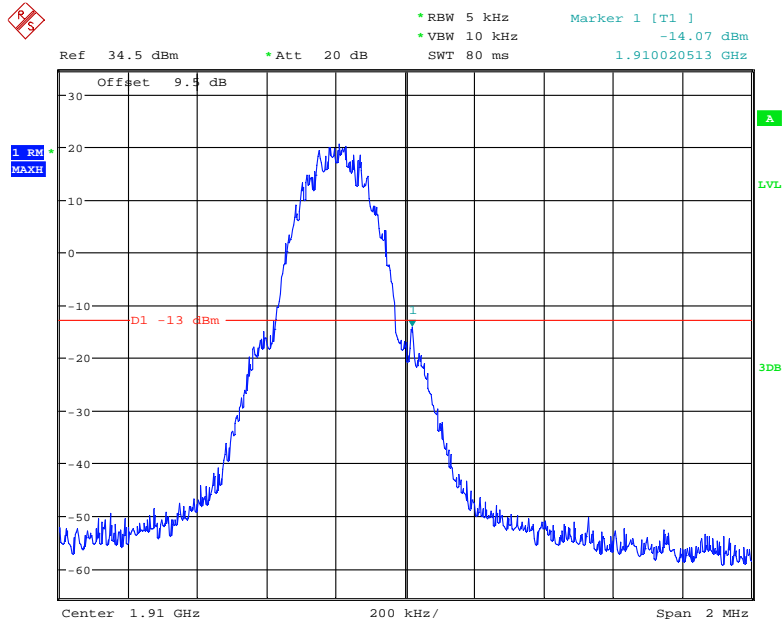

Date: 17.MAY.2019 10:31:51

### PCS Band, Left Band Edge for WCDMA (BPSK) Mode

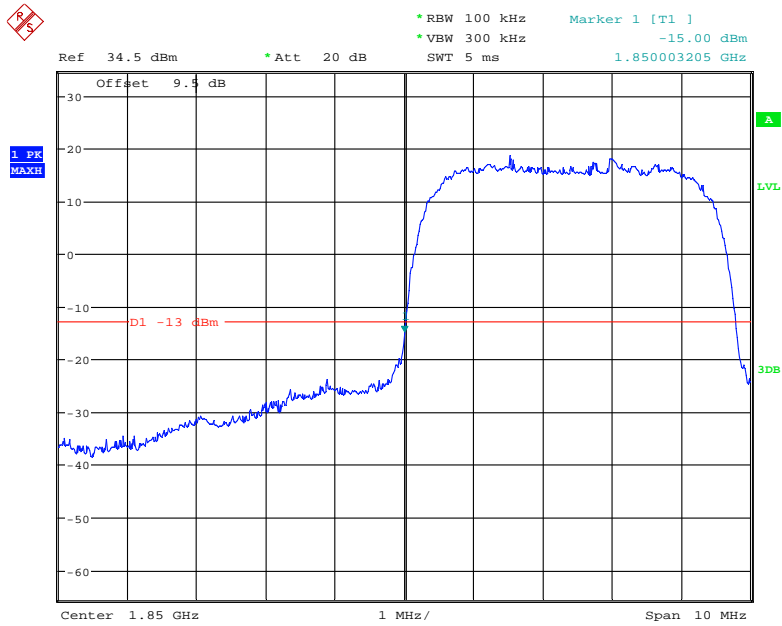

Date: 17.MAY.2019 13:36:50

### PCS Band, Right Band Edge for WCDMA (BPSK) Mode

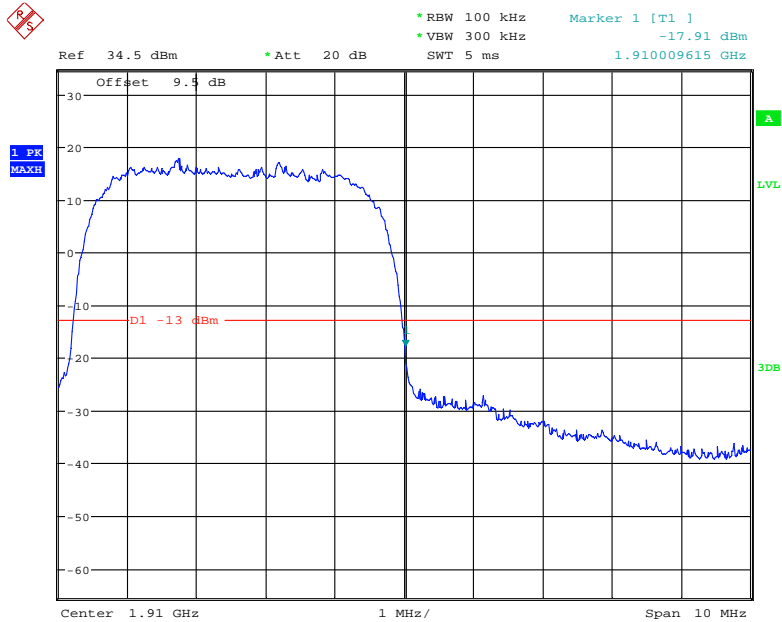

Date: 17.MAY.2019 13:41:07

### PCS Band, Left Band Edge for HSDPA (16QAM) Mode

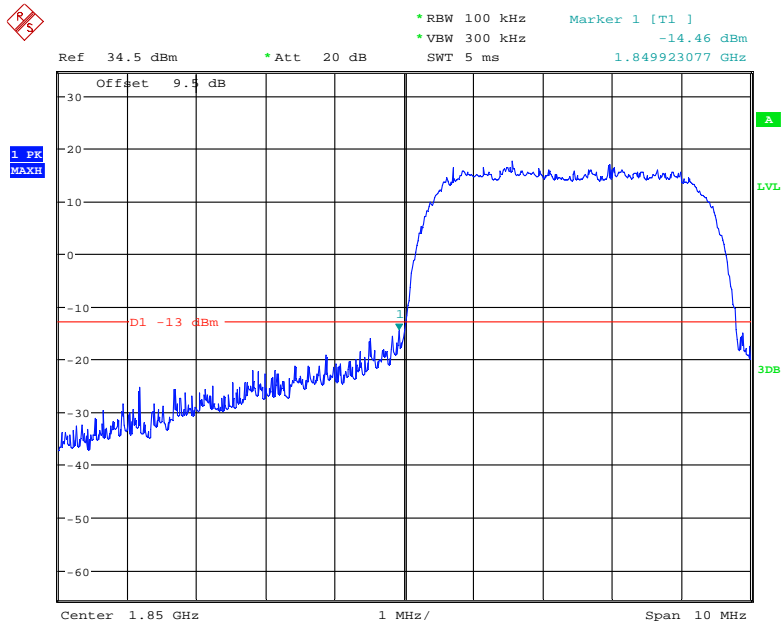

Date: 17.MAY.2019 13:51:58

### PCS Band, Right Band Edge for HSDPA (16QAM) Mode

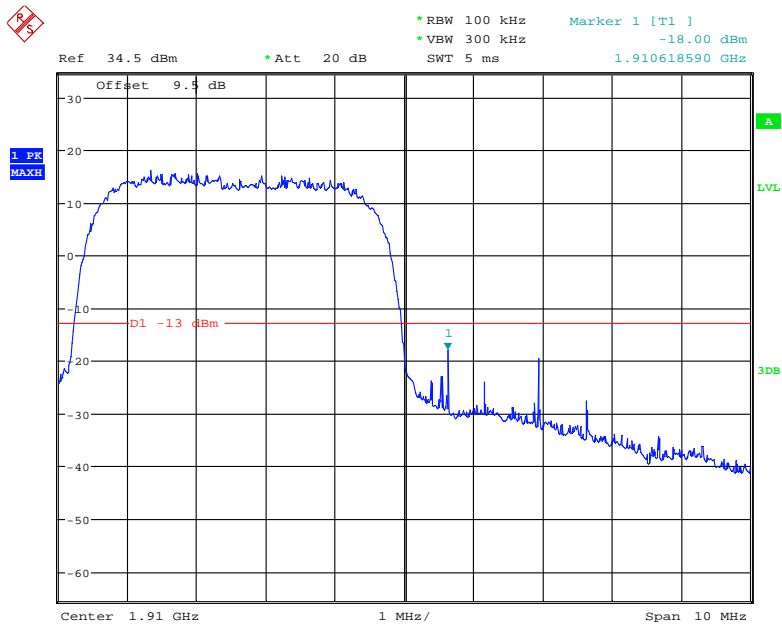

Date: 17.MAY.2019 13:50:29

### PCS Band, Left Band Edge for HSUPA (BPSK) Mode

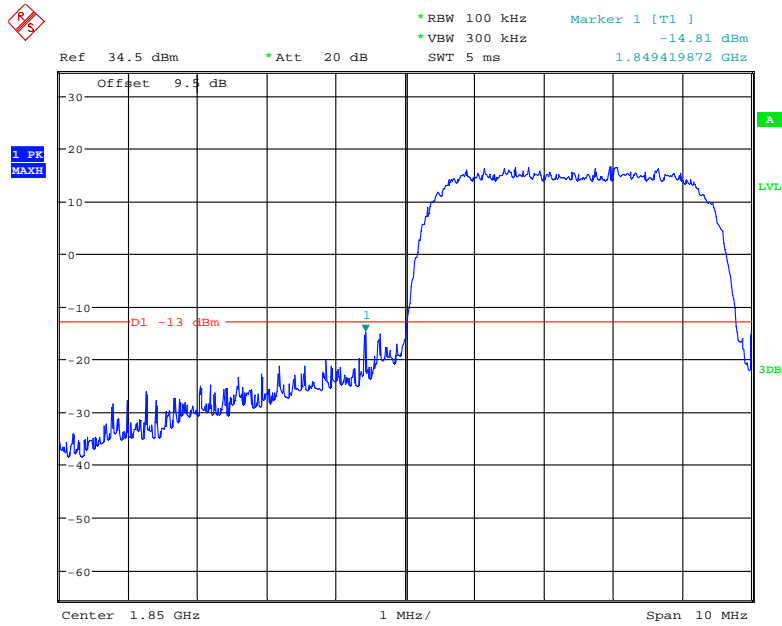

Date: 17.MAY.2019 13:46:09

### PCS Band, Right Band Edge for HSUPA (BPSK) Mode

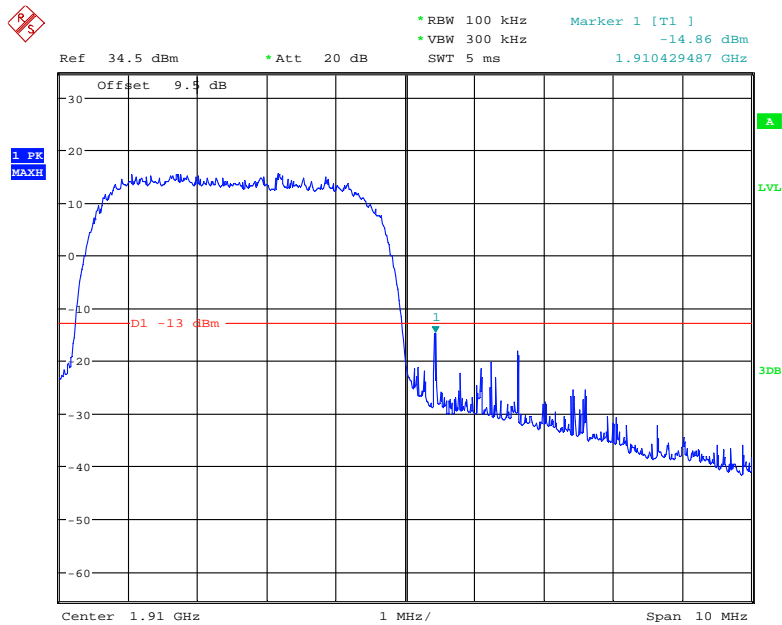

Date: 17.MAY.2019 13:48:19

### AWS Band, Left Band Edge for WCDMA (BPSK) Mode

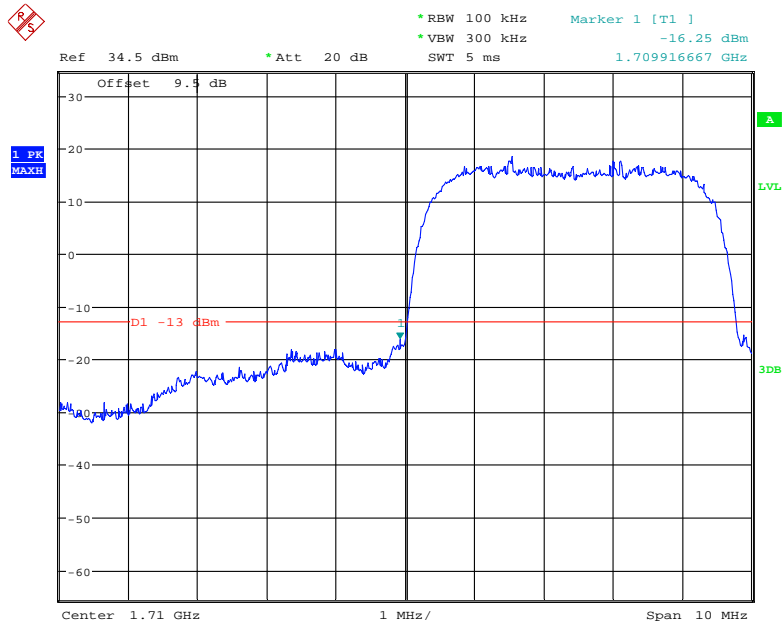

Date: 17.MAY.2019 14:25:07

### AWS Band, Right Band Edge for WCDMA (BPSK) Mode

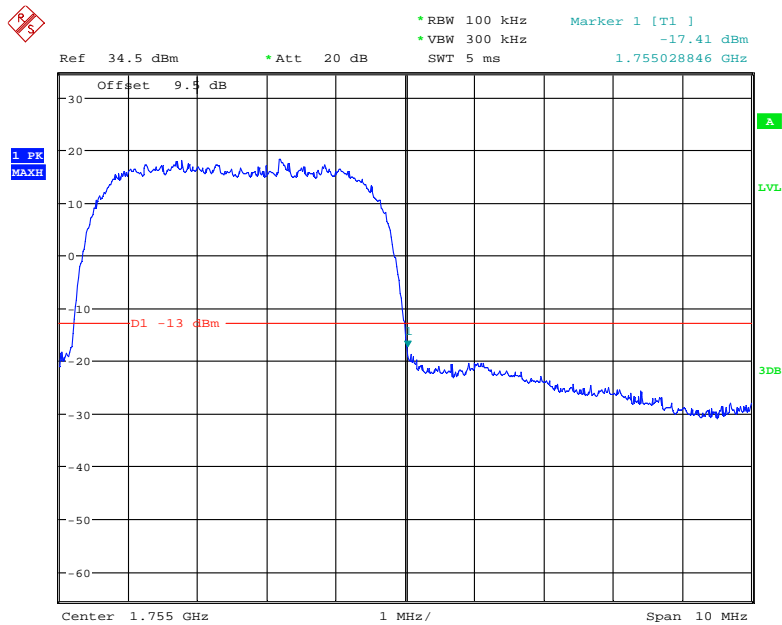

Date: 17.MAY.2019 14:27:21

### AWS Band, Left Band Edge for HSDPA (16QAM) Mode

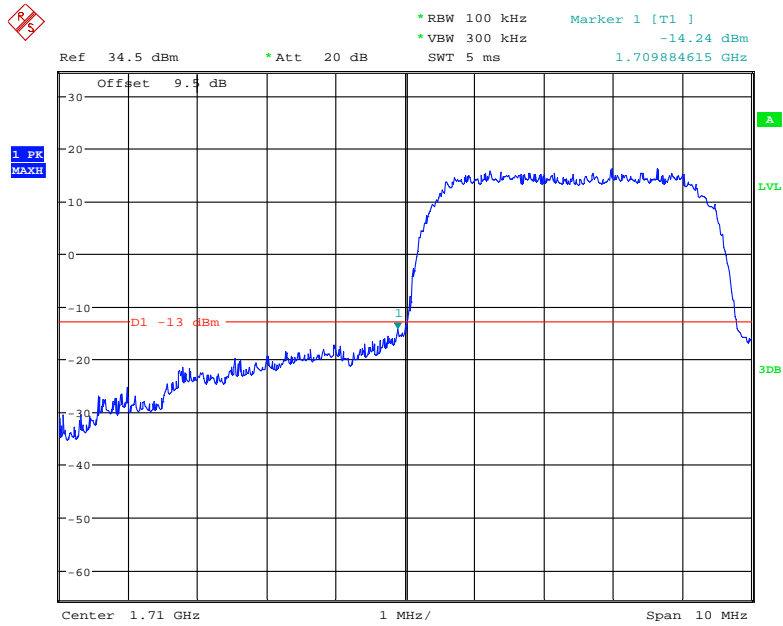

Date: 17.MAY.2019 14:38:05

### AWS Band, Right Band Edge for HSDPA (16QAM) Mode

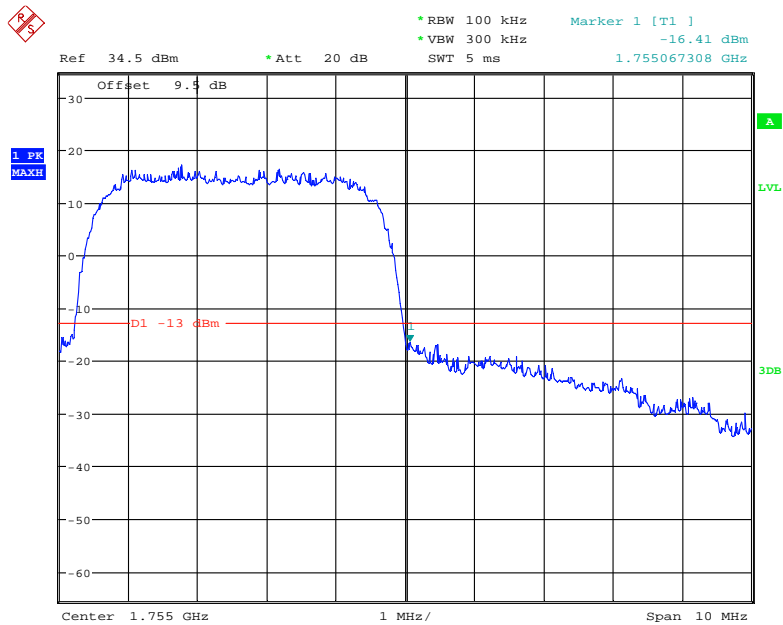

Date: 17.MAY.2019 14:39:04

### AWS Band, Left Band Edge for HSUPA (BPSK) Mode

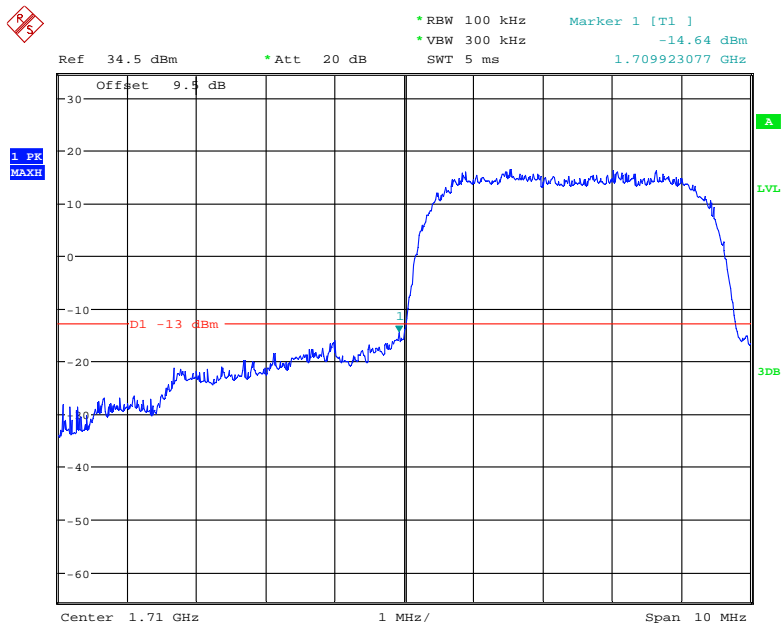

Date: 17.MAY.2019 14:31:02

### AWS Band, Right Band Edge for HSUPA (BPSK) Mode

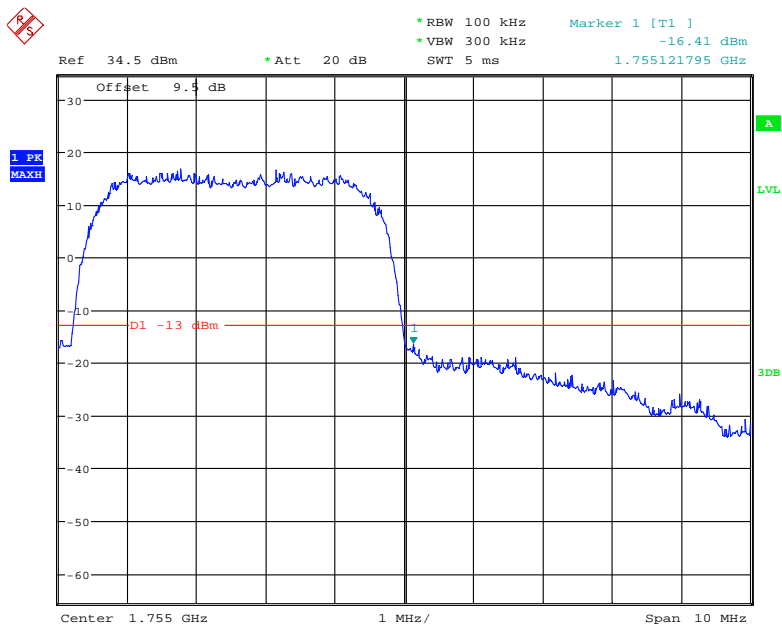

Date: 17.MAY.2019 14:29:33

**FCC § 2.1055; § 22.355; § 24.235; §27.54 - FREQUENCY STABILITY**

**Applicable Standard**

FCC § 2.1055, §22.355, §24.235 and & §27.54.

According to FCC §2.1055, the frequency stability shall be sufficient to ensure that the fundamental emissions stay within the authorized bands of operation.

According to §22.355, the carrier frequency of each transmitter in the Public Mobile Services must be maintained within the tolerances given in Table below:

Frequency Tolerance for Transmitters in the Public Mobile Services

Frequency Range (MHz)	Base, fixed (ppm)	Mobile ≤ 3 watts (ppm)	Mobile > 3 watts (ppm)
25 to 50	20.0	20.0	50.0
50 to 450	5.0	5.0	50.0
450 to 512	2.5	5.0	5.0
821 to 896	1.5	2.5	2.5
928 to 929.	5.0	N/A	N/A
929 to 960.	1.5	N/A	N/A
2110 to 2220	10.0	N/A	N/A

According to §24.235, the frequency stability shall be sufficient to ensure that the fundamental emissions stays within the authorized frequency block.

**Test Procedure**

Frequency Stability vs. Temperature: The equipment under test was connected to an external DC power supply and the RF output was connected to communication test set via feed-through attenuators. The EUT was placed inside the temperature chamber. The DC leads and RF output cable exited the chamber through an opening made for the purpose.

After the temperature stabilized for approximately 20 minutes, the frequency output was recorded from the communication test set.

Frequency Stability vs. Voltage: For hand carried, battery powered equipment; reduce primary supply voltage to the battery operating end point which shall be specified by the manufacturer.

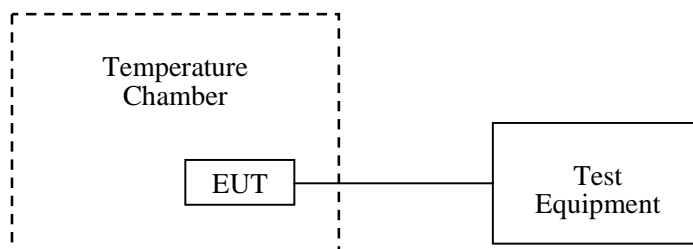



**Test Data**

**Environmental Conditions**

<b>Temperature:</b>	25 °C
<b>Relative Humidity:</b>	50 %
<b>ATM Pressure:</b>	101.0 kPa

*The testing was performed by George Zhong on 2019-05-20.*

*EUT operation mode: Transmitting*

*Test Result: Compliance. Please refer to the following tables.*

**Cellular Band (Part 22H)**

**GSM Mode**

<b>Middle Channel, <math>f_0 = 836.6\text{MHz}</math></b>				
<b>Temperature (°C)</b>	<b>Voltage Supplied (V<sub>DC</sub>)</b>	<b>Frequency Error (Hz)</b>	<b>Frequency Error (ppm)</b>	<b>Limit (ppm)</b>
-30	3.8	9	0.0108	2.5
-20		7	0.0084	2.5
-10		5	0.0060	2.5
0		8	0.0096	2.5
10		6	0.0072	2.5
20		4	0.0048	2.5
30		5	0.0060	2.5
40		3	0.0036	2.5
50		6	0.0072	2.5
20		V min.= 3.6	7	0.0084
	V max.= 4.35	8	0.0096	2.5

**WCDMA Mode**

Middle Channel, $f_0=836.6\text{MHz}$				
Temperature (°C)	Voltage Supplied (V <sub>DC</sub> )	Frequency Error (Hz)	Frequency Error (ppm)	Limit (ppm)
-30	3.8	-9	-0.0108	2.5
-20		3	0.0036	2.5
-10		-1	-0.0012	2.5
0		1	0.0012	2.5
10		0	0.0000	2.5
20		-5	-0.0060	2.5
30		-4	-0.0048	2.5
40		1	0.0012	2.5
50		5	0.0060	2.5
20		V min.= 3.6	1	0.0012
	V max.= 4.35	-6	-0.0072	2.5

**PCS Band (Part 24E)**

Middle Channel, $f_0=1880.0\text{ MHz}$				
Temperature (°C)	Voltage Supplied (V <sub>DC</sub> )	Frequency Error (Hz)	Frequency Error (ppm)	Result
-30	3.8	8	0.0043	pass
-20		5	0.0027	pass
-10		9	0.0048	pass
0		7	0.0037	pass
10		8	0.0043	pass
20		6	0.0032	pass
30		4	0.0021	pass
40		5	0.0027	pass
50		7	0.0037	pass
20		V min.= 3.6	6	0.0032
	V max.= 4.35	8	0.0043	pass

**WCDMA Mode**

Middle Channel, $f_0 = 1880.0$ MHz				
Temperature (°C)	Voltage Supplied (V <sub>DC</sub> )	Frequency Error (Hz)	Frequency Error (ppm)	Result
-30	3.8	4	0.0021	pass
-20		10	0.0053	pass
-10		8	0.0043	pass
0		6	0.0032	pass
10		4	0.0021	pass
20		6	0.0032	pass
30		12	0.0064	pass
40		4	0.0021	pass
50		-1	-0.0005	pass
20		V min.= 3.6	8	0.0043
	V max.= 4.35	1	0.0005	pass

**AWS Band (Part 27)**

Temperature (°C)	Power Supplied (V <sub>DC</sub> )	F <sub>L</sub> (MHz)	F <sub>H</sub> (MHz)	F <sub>L</sub> Limit (MHz)	F <sub>H</sub> Limit (MHz)
-30	3.8	1710.0071	1754.9974	1710	1755
-20		1710.0032	1754.9977	1710	1755
-10		1710.0058	1754.9973	1710	1755
0		1710.0021	1754.9954	1710	1755
10		1710.0021	1754.9973	1710	1755
20		1710.0047	1754.9989	1710	1755
30		1710.0054	1754.9966	1710	1755
40		1710.0031	1754.9975	1710	1755
50		1710.0070	1754.9985	1710	1755
20		V min.= 3.6	1710.0045	1754.9960	1710
	V max.= 4.35	1710.0015	1754.9981	1710	1755

**\*\*\*\*\* END OF REPORT \*\*\*\*\***