



FCC PART 27
 FCC PART 22H, PART 24E
 TEST REPORT

For

BLU Products, Inc.

10814 NW 33rd St # 100 Doral, FL 33172,USA

FCC ID: YHLBLUC5LP21

Report Type: Original Report	Product Type: Mobile phone
Report Number: <u>SZ1210715-29262E-RF-00A</u>	
Report Date: <u>2021-08-27</u>	
Reviewed By: <u>RF Engineer</u> <div style="display: flex; justify-content: space-between; margin-top: 5px;"> Jimmy Xiao <i>Jimmy Xiao</i> </div>	
Prepared By: Bay Area Compliance Laboratories Corp. (Shenzhen) 5F(B-West) , 6F, 7F, the 3rd Phase of Wan Li Industrial Building D, Shihua Rd, FuTian Free Trade Zone, Shenzhen, China Tel: +86-755-33320018 Fax: +86-755-33320008 www.baclcorp.com.cn	

Note: This report may contain data that are not covered by the A2LA accreditation and are marked with an asterisk “★”.

BACL is not responsible for the authenticity of any test data provided by the applicant. Data included from the applicant that may affect test results are marked with an asterisk “*”. Customer model name, addresses, names, trademarks etc. are not considered data.

This report cannot be reproduced except in full, without prior written approval of the Company. Unless otherwise stated the results shown in this test report refer only to the sample(s) tested. This report is valid only with a valid digital signature. The digital signature may be available only under the Adobe software above version 7.0.

TABLE OF CONTENTS

GENERAL INFORMATION	3
PRODUCT DESCRIPTION FOR EQUIPMENT UNDER TEST (EUT).....	3
OBJECTIVE.....	3
TEST METHODOLOGY.....	4
MEASUREMENT UNCERTAINTY.....	4
TEST FACILITY.....	4
SYSTEM TEST CONFIGURATION	5
DESCRIPTION OF TEST CONFIGURATION.....	5
EQUIPMENT MODIFICATIONS.....	6
SUPPORT EQUIPMENT LIST AND DETAILS.....	6
SUPPORT CABLE DESCRIPTION.....	6
BLOCK DIAGRAM OF TEST SETUP.....	7
SUMMARY OF TEST RESULTS	8
TEST EQUIPMENT LIST	9
FCC §1.1307(B) & §2.1093 - RF EXPOSURE INFORMATION	11
APPLICABLE STANDARD.....	11
TEST RESULT.....	11
FCC §2.1047 - MODULATION CHARACTERISTIC	12
FCC § 2.1046, § 22.913 (A) & § 24.232 (C); §27.50 (C) (D) (H) - RF OUTPUT POWER	13
APPLICABLE STANDARD.....	13
TEST PROCEDURE.....	13
TEST DATA.....	13
FCC §2.1049, §22.917, §22.905 & §24.238 & §27.53 - OCCUPIED BANDWIDTH	42
APPLICABLE STANDARD.....	42
TEST PROCEDURE.....	42
TEST DATA.....	42
FCC §2.1051, §22.917(A) & §24.238(A); §27.53 - SPURIOUS EMISSIONS AT ANTENNA TERMINALS	73
APPLICABLE STANDARD.....	73
TEST PROCEDURE.....	73
TEST DATA.....	73
FCC § 2.1053; § 22.917 (A);§ 24.238 (A); §27.53 SPURIOUS RADIATED EMISSIONS	91
APPLICABLE STANDARD.....	91
TEST PROCEDURE.....	91
TEST DATA.....	91
FCC § 22.917 (A);§ 24.238 (A); §27.53(C) (H)(M) - BAND EDGES	102
APPLICABLE STANDARD.....	102
TEST PROCEDURE.....	102
TEST DATA.....	102
FCC § 2.1055; § 22.355; § 24.235; §27.54 - FREQUENCY STABILITY	116
APPLICABLE STANDARD.....	116
TEST PROCEDURE.....	116
TEST DATA.....	117

GENERAL INFORMATION

Product Description for Equipment under Test (EUT)

Product	Mobile Phone
Tested Model	C5L+ 2021
Frequency Range	GSM 850: 824-849MHz(TX); 869-894MHz(RX) PCS 1900: 1850-1910MHz(TX); 1930-1990MHz(RX) WCDMA Band 2: 1850-1910MHz(TX); 1930-1990MHz(RX) WCDMA Band 4: 1710-1755MHz(TX); 2110-2155MHz(RX) WCDMA Band 5: 824-849MHz(TX); 869-894MHz(RX) LTE Band 2: 1850-1910MHz(TX); 1930-1990MHz(RX) LTE Band 4: 1710-1755MHz(TX); 2110-2155MHz(RX) LTE Band 5: 824-849MHz(TX); 869-894MHz(RX) LTE Band 7: 2500-2570MHz(TX); 2620-2690MHz(RX) LTE Band 12: 699-716MHz(TX); 729-746MHz(RX) LTE Band 17: 704-716MHz(TX); 734-746MHz(RX) LTE Band 66: 1710-1780MHz(TX), 2110-2180MHz(RX)
Modulation Technique	2G: GMSK, 8PSK 3G: BPSK, QPSK, 16QAM 4G: QPSK, 16QAM
Antenna Specification*	GSM850/WCDMA Band 5/LTE Band 5: -2.0dBi PCS1900/WCDMA Band 2/ LTE Band 2: 1.2dBi WCDMA Band 4/ LTE Band 4/LTE Band 66: 1.2dBi LTE Band 7: 1.8dBi LTE Band 12/LTE Band17: -2.0dBi (it was provided by the applicant)
Voltage Range	DC 3.8V from battery or DC 5.0V from adapter
Date of Test	2021-07-16 to 2021-08-14
Sample number	SZ1210715-29262E-RF-S1 (Assigned by BACL, Shenzhen)
Received date	2021-07-15
Sample/EUT Status	Good condition
Adapter information	Model: US-FC-0750 Input: AC 100-240V ~ 50/60Hz, 0.2A Output: DC 5.0V, 750mA

Objective

This test report is in accordance with Part 2-Subpart J, Part 22-Subpart H and Part 24-Subpart E and Subpart 27 of the Federal Communication Commissions rules.

The objective is to determine the compliance of the EUT with FCC rules for output power, modulation characteristic, occupied bandwidth, and spurious emission at antenna terminal, spurious radiated emission, frequency stability and band edge.

Test Methodology

All tests and measurements indicated in this document were performed in accordance with the Code of Federal Regulations Title 47 Part 2-Subpart J as well as the following parts:

Part 22 Subpart H - Public Mobile Services
 Part 24 Subpart E - Personal Communication Services
 Part 27 – Miscellaneous wireless communications services

ANSI C63.26-2015: American National Standard for Compliance Testing of Transmitters Used in Licensed Radio Services

All emissions measurement was performed at Bay Area Compliance Laboratories Corp. (Shenzhen). The radiated testing was performed at an antenna-to-EUT distance of 3 meters. Each test item follows test standards and with no deviation.

Measurement Uncertainty

Parameter		Uncertainty
Occupied Channel Bandwidth		±5%
RF output power, conducted		±0.73dB
Unwanted Emission, conducted		±1.6dB
Emissions, Radiated	Below 1GHz	±4.75dB
	Above 1GHz	±4.88dB
Temperature		±1°C
Humidity		±6%
Supply voltages		±0.4%

Note: The extended uncertainty given in this report is obtained by combining the standard uncertainty times the coverage factor K with the 95% confidence interval. Otherwise required by the applicant or Product Regulations, Decision Rule in this report did not consider the uncertainty.

Test Facility

The Test site used by Bay Area Compliance Laboratories Corp. (Shenzhen) to collect test data is located on the 5F(B-West) ,6F,7F,the 3rd Phase of Wan Li Industrial Building D,Shihua Rd, FuTian Free Trade Zone, Shenzhen, China.

The test site has been approved by the FCC under the KDB 974614 D01 and is listed in the FCC Public Access Link (PAL) database, FCC Registration No.: 342867, the FCC Designation No.: CN1221.

The test site has been registered with ISED Canada under ISED Canada Registration Number 3062B.

SYSTEM TEST CONFIGURATION

Description of Test Configuration

The final qualification test was performed with the EUT operating at normal mode.

Test was performed as below table:

Frequency band	Bandwidth (MHz)	Test Frequency(MHz)		
		Low	Middle	High
GSM850	0.25	824.2	836.6	848.8
DCS1900	0.25	1850.2	1880.0	1909.8
WCDMA B2	4.2	1852.4	1880.0	1907.6
WCDMA B4	4.2	1712.4	1732.6	1752.6
WCDMA B5	4.2	826.4	836.6	846.6
LTE B2	1.4	1850.7	1880.0	1909.3
	3	1851.5	1880.0	1908.5
	5	1852.5	1880.0	1907.5
	10	1855.0	1880.0	1905.0
	15	1857.5	1880.0	1902.5
	20	1860.0	1880.0	1900.0
LTE B4	1.4	1710.7	1732.5	1754.3
	3	1711.5	1732.5	1753.5
	5	1712.5	1732.5	1752.5
	10	1715.0	1732.5	1750.0
	15	1717.5	1732.5	1747.5
	20	1720.0	1732.5	1745.0
LTE B5	1.4	824.7	836.5	848.3
	3	825.5	836.5	847.5
	5	826.5	836.5	846.5
	10	829.0	836.5	844.0
LTE B7	5	2502.5	2535.0	2567.5
	10	2505.0	2535.0	2565
	15	2507.5	2535.0	2562.5
	20	2510.0	2535.0	2560.0
LTE B12	1.4	699.7	707.5	715.3
	3	700.5	707.5	714.5
	5	701.5	707.5	713.5
	10	704.0	707.5	711.0
LTE B17	5	706.5	710.0	713.5
	10	709.0	710.0	711.0

Frequency band	Bandwidth (MHz)	Test Frequency(MHz)		
		Low	Middle	High
LTE B66	1.4	1710.7	1745.0	1779.3
	3	1711.5	1745.0	1778.5
	5	1712.5	1745.0	1777.5
	10	1705.0	1745.0	1775.0
	15	1707.5	1745.0	1772.5
	20	1710.0	1745.0	1770.0

Equipment Modifications

No modification was made to the EUT.

Support Equipment List and Details

Manufacturer	Description	Model	Serial Number
Rohde & Schwarz	Wideband Radio Communication Tester	CMW500	1201.002K50-116218-U
Rohde & Schwarz	Universal Radio Communication Tester	CMU200	115500

Support Cable Description

Cable Description	Length (m)	From / Port	To
Unshielded Detachable AC Cable	1.2	AC Mains	CMW500/ CMU200

Block Diagram of Test Setup

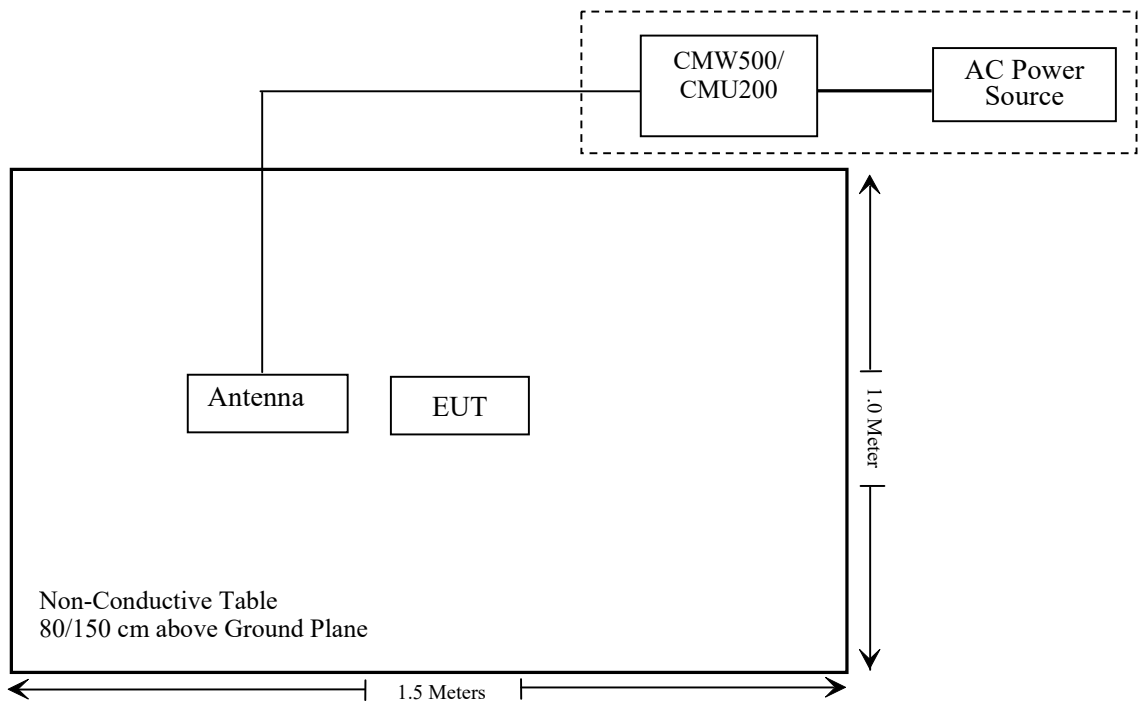

SUMMARY OF TEST RESULTS

FCC Rules	Description of Test	Result
§ 1.1307 , §2.1093	RF Exposure (SAR)	Compliant*
§2.1046; § 22.913 (a); § 24.232 (c); §27.50 (c) (d) (h)	RF Output Power	Compliant
§ 2.1047	Modulation Characteristics	Not Applicable
§ 2.1049; § 22.905; § 22.917; § 24.238; §27.53	Occupied Bandwidth	Compliant
§ 2.1051; § 22.917 (a); § 24.238 (a); §27.53	Spurious Emissions at Antenna Terminal	Compliant
§ 2.1053; § 22.917 (a); § 24.238 (a); §27.53	Field Strength of Spurious Radiation	Compliant
§ 22.917 (a); § 24.238 (a); §27.53(c)(h) (m)	Band Edge	Compliant
§ 2.1055; § 22.355; § 24.235; §27.54;	Frequency stability	Compliant

Note: * Please refer to SAR report released by BACL, report number: SZ1210715-29262E-SA.

TEST EQUIPMENT LIST

Manufacturer	Description	Model	Serial Number	Calibration Date	Calibration Due Date
Radiated Emission Test					
R&S	EMI Test Receiver	ESR3	102455	2020/08/04	2021/08/03
Sonoma instrument	Pre-amplifier	310 N	186238	2020/08/04	2021/08/03
Sunol Sciences	Broadband Antenna	JB1	A040904-2	2020/12/22	2023/12/21
COM-POWER	Dipole Antenna	AD-100	721027	NCR	NCR
Unknown	Cable 2	RF Cable 2	F-03-EM197	2020/11/29	2021/11/28
Unknown	Cable	Chamber Cable 1	F-03-EM236	2020/11/29	2021/11/28
Rohde & Schwarz	Spectrum Analyzer	FSV40-N	102259	2020/08/04	2021/08/03
COM-POWER	Pre-amplifier	PA-122	181919	2020/11/29	2021/11/28
Quinstar	Amplifier	QLW-18405536-J0	15964001002	2020/11/29	2021/11/28
Sunol Sciences	Horn Antenna	3115	9107-3694	2021/01/15	2024/01/14
A.H.System	Horn Antenna	SAS-200/571	135	2018/09/01	2021/08/31
Insulted Wire Inc.	RF Cable	SPS-2503-3150	02222010	2020/11/29	2021/11/28
Unknown	RF Cable	W1101-EQ1 OUT	F-19-EM005	2020/11/29	2021/11/28
MICRO-TRONICS	Passband filter	HPM50111	F-19-EM006	2021/04/20	2022/04/19
Unknown	High Pass filter	1.3GHz	101120	2021/04/20	2022/04/19
Ducommun Technologies	Horn antenna	ARH-4223-02	1007726-01 1304	2020/12/06	2023/12/05
Ducommun Technologies	Horn antenna	ARH-4223-02	1007726-02 1304	2020/12/06	2023/12/05
Agilent	Signal Generator	N5183A	MY51040755	2020/12/29	2021/12/28
Rohde & Schwarz	Wideband Radio Communication Tester	CMW500	1201.002K50-146520-wh	2020/08/04	2021/08/03
Rohde & Schwarz	Universal Radio Communication Tester	CMU200	115500	2020/07/31	2021/07/30

Manufacturer	Description	Model	Serial Number	Calibration Date	Calibration Due Date
RF Conducted Test					
Rohde & Schwarz	Signal and Spectrum Analyzer	FSV40	101473	2021/07/06	2022/07/05
Rohde & Schwarz	Wideband Radio Communication Tester	CMW500	1201.002K50-146520-wh	2021/07/06	2022/07/05
Unknown	RF Cable	Unknown	2301 276	2020/11/29	2021/11/28
Unknown	RF Cable	Unknown	DLO J5/W6102	2020/11/29	2021/11/28
Weinschel	Power divider	1515	MY628	2020/11/29	2021/11/28
Rohde & Schwarz	Universal Radio Communication Tester	CMU200	115500	2021/07/06	2022/07/05
instek	DC Power Supply	GPS-3030DD	EM832096	NCR	NCR
ESPEC	Temperature & Humidity Chamber	EL-10KA	9107726	2021/01/05	2022/01/05
Fluke	Digital Multimeter	287	19000011	2021/02/22	2022/02/21

* Statement of Traceability: Bay Area Compliance Laboratories Corp. (Shenzhen) attests that all calibrations have been performed in accordance to requirements that traceable to National Primary Standards and International System of Units (SI).

FCC §1.1307(b) & §2.1093 - RF EXPOSURE INFORMATION

Applicable Standard

FCC§1.1310 and §2.1093.

Test Result

Compliance, please refer to the SAR report: SZ1210715-29262E-SA.

FCC §2.1047 - MODULATION CHARACTERISTIC

According to FCC § 2.1047(d), Part 22H & 24E & 27 there is no specific requirement for digital modulation, therefore modulation characteristic is not presented.

FCC § 2.1046, § 22.913 (a) & § 24.232 (c); §27.50 (c) (d) (h) - RF OUTPUT POWER

Applicable Standard

According to FCC §2.1046 and §22.913 (a), the ERP of mobile transmitters and auxiliary test transmitters must not exceed 7 watts.

According to FCC §2.1046 and §24.232 (C), mobile and portable stations are limited to 2 watts EIRP and the equipment must employ a means for limiting power to the minimum necessary for successful communications.

The peak-to-average power ratio (PAPR) of the transmitter output power must not exceed 13 dB.

According to §27.50(c), Portable stations (hand-held devices) in the 600 MHz uplink band and the 698-746 MHz band, and fixed and mobile stations in the 600 MHz uplink band are limited to 3 watts ERP.

According to §27.50(d), the maximum EIRP must not exceed 1Watts (30dBm) for 1710-1780MHz.

According to §27.50(h), the maximum EIRP must not exceed 2Watts (33dBm) for 2500-2570MHz & 2496-2690MHz.

Test Procedure

Conducted method:

The RF output of the transmitter was connected to the CMW500/CMU200 through sufficient attenuation.

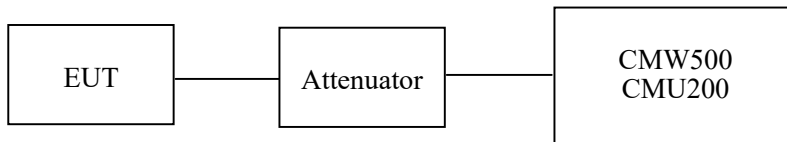

Test Data

Environmental Conditions

Temperature:	25 °C
Relative Humidity:	55 ~62 %
ATM Pressure:	101.0 kPa

The testing was performed by Orlo Yang from 2021-07-16 to 2021-07-22.

Conducted Power

Cellular Band (Part 22H)

Mode	Channel	Frequency (MHz)	Average Output Power (dBm)	ERP (dBm)	Limit (dBm)
GSM	128	824.2	31.80	27.15	38.45
	190	836.6	31.70	27.05	38.45
	251	848.8	31.70	27.05	38.45

Mode	Channel	Frequency (MHz)	Average Output Power (dBm)				ERP(dBm)				Limit (dBm)
			1 slot	2 slots	3 slots	4 slots	1 slot	2 slots	3 slots	4 slots	
GPRS	128	824.2	31.81	29.59	27.66	25.63	27.16	24.94	23.01	20.98	38.45
	190	836.6	31.71	29.59	27.94	25.76	27.06	24.94	23.29	21.11	38.45
	251	848.8	31.65	29.51	27.87	25.69	27.00	24.86	23.22	21.04	38.45

Mode	Channel	Frequency (MHz)	Average Output Power (dBm)				ERP(dBm)				Limit (dBm)
			1 slot	2 slots	3 slots	4 slots	1 slot	2 slots	3 slots	4 slots	
EGPRS	128	824.2	25.19	24.76	23.29	20.77	20.54	20.11	18.64	16.12	38.45
	190	836.6	25.01	24.63	23.21	20.68	20.36	19.98	18.56	16.03	38.45
	251	848.8	24.51	24.23	22.61	20.22	19.86	19.58	17.96	15.57	38.45

Mode	Test Mode	3GPP Sub Test	Average Output Power (dBm)			ERP(dBm)		
			Low	Mid	High	Low	Mid	High
WCDMA (Band 5)	RMC12.2k		22.42	22.45	22.47	17.77	17.80	17.82
	HSDPA	1	22.67	22.18	22.45	18.02	17.53	17.80
		2	22.19	21.85	22.12	17.54	17.20	17.47
		3	22.19	21.85	22.12	17.54	17.20	17.47
		4	22.19	21.85	22.12	17.54	17.20	17.47
	HSUPA	1	22.19	21.85	22.12	17.54	17.20	17.47
		2	22.23	21.90	22.16	17.58	17.25	17.51
		3	22.26	21.97	22.19	17.61	17.32	17.54
		4	22.33	22.01	22.25	17.68	17.36	17.60
		5	22.41	22.06	22.29	17.76	17.41	17.64
HSPA+	1	22.46	22.12	22.32	17.81	17.47	17.67	

Note: ERP(dBm) = Conducted Power(dBm) + Antenna Gain(dBd) - Cable Loss(dB)
 For GSM850/WCDMA Band5: Antenna Gain = -2.0dBi = -4.15dBd (0dBd=2.15dBi)
 Cable Loss=0.5dB
 The limit: ERP ≤ 38.45dBm

PCS Band (Part 24E)

Mode	Channel	Frequency (MHz)	Average Output Power (dBm)	EIRP(dBm)	Limit (dBm)
GSM	512	1850.2	29.0	29.2	33
	661	1880.0	29.1	29.3	33
	810	1909.8	29.0	29.2	33

Mode	Channel	Frequency (MHz)	Average Output Power (dBm)				EIRP(dBm)				Limit (dBm)
			1 slot	2 slots	3 slots	4 slots	1 slot	2 slots	3 slots	4 slots	
GPRS	512	1850.2	28.99	26.64	25.11	22.93	29.19	26.84	25.31	23.13	33
	661	1880.0	29.05	26.67	25.16	22.94	29.25	26.87	25.36	23.14	33
	810	1909.8	28.99	26.55	25.12	22.92	29.19	26.75	25.32	23.12	33

Mode	Channel	Frequency (MHz)	Average Output Power (dBm)				EIRP(dBm)				Limit (dBm)
			1 slot	2 slots	3 slots	4 slots	1 slot	2 slots	3 slots	4 slots	
EGPRS	512	1850.2	23.81	23.35	22.34	20.16	24.01	23.55	22.54	20.36	33
	661	1880.0	24.83	24.67	23.59	21.37	25.03	24.87	23.79	21.57	33
	810	1909.8	24.29	23.99	22.66	20.36	24.49	24.19	22.86	20.56	33

Mode	Test Mode	3GPP Sub Test	Average Output Power (dBm)			EIRP(dBm)		
			Low	Mid	High	Low	Mid	High
WCDMA (Band 2)	RMC12.2k		22.02	22.11	22.14	22.22	22.31	22.34
	HSDPA	1	21.04	21.09	21.18	21.24	21.29	21.38
		2	21.10	21.14	21.24	21.30	21.34	21.44
		3	21.15	21.20	21.31	21.35	21.40	21.51
		4	21.19	21.26	21.38	21.39	21.46	21.58
	HSUPA	1	21.11	21.05	21.00	21.31	21.25	21.20
		2	21.19	21.12	21.07	21.39	21.32	21.27
		3	21.23	21.15	21.10	21.43	21.35	21.30
		4	21.26	21.20	21.15	21.46	21.40	21.35
		5	21.30	21.26	21.21	21.50	21.46	21.41
	HSPA+	1	21.33	21.33	21.27	21.53	21.53	21.47

Note: EIRP(dBm) = Conducted Power(dBm) + Antenna Gain(dBi) - Cable loss(dB)
 For PCS1900/WCDMA Band2: Antenna Gain = 1.2dBi
 Cable Loss=1dB*(provided by the applicant)
 Limit: EIRP ≤ 33dBm

AWS Band (Part 27)

Mode	Test Mode	3GPP Sub Test	Average Output Power (dBm)			EIRP(dBm)		
			Low	Mid	High	Low	Mid	High
WCDMA (Band 4)	RMC12.2k		21.61	21.80	21.96	21.81	22.00	22.16
	HSDPA	1	21.21	21.38	21.08	21.41	21.58	21.28
		2	21.28	21.43	21.12	21.48	21.63	21.32
		3	21.31	21.48	21.16	21.51	21.68	21.36
		4	21.39	21.52	21.22	21.59	21.72	21.42
	HSUPA	1	20.82	20.83	20.81	21.02	21.03	21.01
		2	20.85	20.90	20.88	21.05	21.10	21.08
		3	20.93	20.98	20.92	21.13	21.18	21.12
		4	20.97	21.00	21.00	21.17	21.20	21.20
		5	21.04	21.03	21.05	21.24	21.23	21.25
	HSPA+	1	21.09	21.06	21.09	21.29	21.26	21.29

Note: EIRP(dBm) = Conducted Power(dBm) + Antenna Gain(dBi) - Cable loss(dB)

For WCDMA Band4: Antenna Gain = 1.2dBi

Cable Loss=1dB*(provided by the applicant)

Limit: EIRP ≤ 30dBm

Peak-to-average ratio (PAR)

Cellular Band

Mode	Channel	PAR (dB)	Limit (dB)
GSM	Low	3.19	13
	Middle	3.36	13
	High	3.46	13

Mode	Channel	PAR (dB)	Limit (dB)
EGPRS	Low	3.16	13
	Middle	3.10	13
	High	3.33	13

Mode	Channel	PAR (dB)	Limit (dB)
RMC (BPSK)	Low	3.20	13
	Middle	3.24	13
	High	3.36	13
HSDPA (16QAM)	Low	3.17	13
	Middle	3.46	13
	High	3.57	13
HSUPA (BPSK)	Low	3.28	13
	Middle	3.17	13
	High	3.37	13
HSPA+	Low	3.16	13
	Middle	3.19	13
	High	3.39	13

PCS Band

Mode	Channel	PAR (dB)	Limit (dB)
GSM	Low	3.28	13
	Middle	3.19	13
	High	3.35	13

Mode	Channel	PAR (dB)	Limit (dB)
EGPRS	Low	3.14	13
	Middle	3.23	13
	High	3.52	13

Mode	Channel	PAR (dB)	Limit (dB)
RMC (BPSK)	Low	3.58	13
	Middle	3.24	13
	High	3.54	13
HSDPA (16QAM)	Low	3.32	13
	Middle	3.29	13
	High	3.66	13
HSUPA (BPSK)	Low	2.91	13
	Middle	3.32	13
	High	3.63	13
HSPA+	Low	3.22	13
	Middle	3.30	13
	High	3.31	13

AWS Band

Mode	Channel	PAR (dB)	Limit (dB)
RMC (BPSK)	Low	3.67	13
	Middle	3.25	13
	High	3.44	13
HSDPA (16QAM)	Low	3.35	13
	Middle	3.23	13
	High	3.60	13
HSUPA (BPSK)	Low	3.05	13
	Middle	3.27	13
	High	3.69	13
HSPA+	Low	3.16	13
	Middle	3.30	13
	High	3.40	13

LTE Band 2:

Maximum Output Power

Bandwidth (MHz)	Modulation	RB size/ RB Offset	Conducted Average Output Power (dBm)			EIRP(dBm)		
			Low	Mid	High	Low	Mid	High
1.4	QPSK	RB1#0	23.66	23.54	23.66	23.86	23.74	23.86
		RB1#3	23.61	23.60	23.61	23.81	23.8	23.81
		RB1#5	23.61	23.54	23.61	23.81	23.74	23.81
		RB3#0	23.65	23.72	23.65	23.85	23.92	23.85
		RB3#3	23.64	23.59	23.64	23.84	23.79	23.84
		RB6#0	22.55	22.63	22.55	22.75	22.83	22.75
	16QAM	RB1#0	23.21	23.07	23.21	23.41	23.27	23.41
		RB1#3	23.23	23.01	23.23	23.43	23.21	23.43
		RB1#5	23.22	22.97	23.22	23.42	23.17	23.42
		RB3#0	22.67	22.78	22.67	22.87	22.98	22.87
		RB3#3	22.73	22.75	22.73	22.93	22.95	22.93
		RB6#0	21.91	21.73	21.91	22.11	21.93	22.11
3.0	QPSK	RB1#0	23.53	23.57	23.49	23.73	23.77	23.69
		RB1#8	23.54	23.57	23.51	23.74	23.77	23.71
		RB1#14	23.51	23.56	23.24	23.71	23.76	23.44
		RB6#0	22.55	22.58	22.49	22.75	22.78	22.69
		RB6#9	22.59	22.59	22.47	22.79	22.79	22.67
		RB15#0	22.59	22.63	22.55	22.79	22.83	22.75
	16QAM	RB1#0	23.05	22.87	22.22	23.25	23.07	22.42
		RB1#8	23.01	22.69	22.37	23.21	22.89	22.57
		RB1#14	22.99	22.78	22.22	23.19	22.98	22.42
		RB6#0	21.63	21.82	21.67	21.83	22.02	21.87
		RB6#9	21.62	21.70	21.63	21.82	21.9	21.83
		RB15#0	21.72	21.74	21.68	21.92	21.94	21.88

Bandwidth (MHz)	Modulation	RB size/ RB Offset	Conducted Average Output Power (dBm)			EIRP(dBm)		
			Low	Mid	High	Low	Mid	High
5	QPSK	RB1#0	23.58	23.74	23.38	23.78	23.94	23.58
		RB1#13	23.55	23.70	23.30	23.75	23.9	23.5
		RB1#24	23.53	23.70	23.07	23.73	23.9	23.27
		RB15#0	22.56	22.58	22.53	22.76	22.78	22.73
		RB15#10	22.68	22.57	22.53	22.88	22.77	22.73
		RB25#0	22.58	22.58	22.54	22.78	22.78	22.74
	16QAM	RB1#0	21.89	22.66	22.68	22.09	22.86	22.88
		RB1#13	21.93	22.61	22.59	22.13	22.81	22.79
		RB1#24	21.85	22.59	22.60	22.05	22.79	22.8
		RB15#0	21.75	21.57	21.57	21.95	21.77	21.77
		RB15#10	21.77	21.52	21.58	21.97	21.72	21.78
		RB25#0	21.78	21.73	21.71	21.98	21.93	21.91
10	QPSK	RB1#0	23.58	23.74	23.38	23.78	23.94	23.58
		RB1#0	23.52	23.52	23.55	23.72	23.72	23.75
		RB1#25	23.51	23.61	23.47	23.71	23.81	23.67
		RB1#49	23.60	23.53	23.43	23.8	23.73	23.63
		RB25#0	22.67	22.62	22.58	22.87	22.82	22.78
		RB25#25	22.58	22.50	22.45	22.78	22.7	22.65
	16QAM	RB50#0	22.69	22.56	22.59	22.89	22.76	22.79
		RB1#0	22.86	23.30	22.50	23.06	23.5	22.7
		RB1#25	22.85	23.32	22.46	23.05	23.52	22.66
		RB1#49	22.92	23.22	22.49	23.12	23.42	22.69
		RB25#0	21.69	21.77	21.82	21.89	21.97	22.02
		RB25#25	21.69	21.72	21.79	21.89	21.92	21.99
RB50#0	21.69	21.79	21.64	21.89	21.99	21.84		

Bandwidth (MHz)	Modulation	RB size/ RB Offset	Conducted Average Output Power (dBm)			EIRP(dBm)		
			Low	Mid	High	Low	Mid	High
15	QPSK	RB1#0	23.51	23.45	23.36	23.71	23.65	23.56
		RB1#38	23.50	23.46	23.30	23.7	23.66	23.5
		RB1#74	23.50	23.49	23.28	23.7	23.69	23.48
		RB36#0	22.67	22.50	22.51	22.87	22.7	22.71
		RB36#39	22.64	22.53	22.46	22.84	22.73	22.66
		RB75#0	22.57	22.67	22.56	22.77	22.87	22.76
	16QAM	RB1#0	22.84	22.82	22.73	23.04	23.02	22.93
		RB1#38	22.85	22.81	22.62	23.05	23.01	22.82
		RB1#74	22.86	22.80	22.63	23.06	23	22.83
		RB36#0	21.79	21.73	21.62	21.99	21.93	21.82
		RB36#39	21.76	21.70	21.57	21.96	21.9	21.77
		RB75#0	21.78	21.75	21.52	21.98	21.95	21.72
20	QPSK	RB1#0	23.67	23.72	23.48	23.87	23.92	23.68
		RB1#50	23.63	23.52	23.47	23.83	23.72	23.67
		RB1#99	23.58	23.51	23.39	23.78	23.71	23.59
		RB50#0	22.46	22.49	22.52	22.66	22.69	22.72
		RB50#50	22.49	22.58	22.50	22.69	22.78	22.7
		RB100#0	22.60	22.59	22.55	22.8	22.79	22.75
	16QAM	RB1#0	22.72	22.53	23.18	22.92	22.73	23.38
		RB1#50	22.75	22.57	23.16	22.95	22.77	23.36
		RB1#99	22.77	22.58	23.05	22.97	22.78	23.25
		RB50#0	21.69	21.70	21.61	21.89	21.9	21.81
		RB50#50	21.65	21.64	21.57	21.85	21.84	21.77
		RB100#0	21.63	21.68	21.52	21.83	21.88	21.72

Note: EIRP(dBm) = Conducted Power(dBm) + Antenna Gain(dBi) - Cable loss(dB)

For LTE Band 2: Antenna Gain = 1.2dBi

Cable Loss=1dB*(provided by the applicant)

Limit: EIRP ≤ 33dBm

Peak-to-average ratio (PAR)**20MHz Bandwidth**

Modulation	Low channel (dB)	Middle channel (dB)	High channel (dB)	PAR Limit (dB)	Result
QPSK (1RB Size)	4.04	3.78	3.14	13	Pass
QPSK (100RB Size)	5.22	5.29	5.22	13	Pass
16QAM (1RB Size)	4.52	4.81	4.26	13	Pass
16QAM (100RB Size)	6.15	6.15	6.06	13	Pass

LTE Band 4

Maximum Output Power

Bandwidth (MHz)	Modulation	RB size/ RB Offset	Conducted Average Output Power (dBm)			EIRP(dBm)		
			Low	Mid	High	Low	Mid	High
1.4	QPSK	RB1#0	23.60	23.49	23.52	23.8	23.69	23.72
		RB1#3	23.60	23.58	23.49	23.8	23.78	23.69
		RB1#5	23.63	23.58	23.54	23.83	23.78	23.74
		RB3#0	23.74	23.60	23.45	23.94	23.8	23.65
		RB3#3	23.71	23.53	23.39	23.91	23.73	23.59
		RB6#0	22.57	22.57	22.40	22.77	22.77	22.6
	16QAM	RB1#0	22.94	23.22	22.37	23.14	23.42	22.57
		RB1#3	23.01	23.20	22.30	23.21	23.4	22.5
		RB1#5	23.04	23.17	22.38	23.24	23.37	22.58
		RB3#0	22.59	22.36	22.29	22.79	22.56	22.49
		RB3#3	22.56	22.43	22.28	22.76	22.63	22.48
		RB6#0	21.75	21.71	21.72	21.95	21.91	21.92
3.0	QPSK	RB1#0	23.52	23.54	23.55	23.72	23.74	23.75
		RB1#8	23.52	23.57	23.52	23.72	23.77	23.72
		RB1#14	23.40	23.53	23.55	23.6	23.73	23.75
		RB6#0	22.69	22.44	22.44	22.89	22.64	22.64
		RB6#9	22.54	22.51	22.43	22.74	22.71	22.63
		RB15#0	22.60	22.46	22.47	22.8	22.66	22.67
	16QAM	RB1#0	23.20	22.87	22.37	23.4	23.07	22.57
		RB1#8	23.24	22.83	22.34	23.44	23.03	22.54
		RB1#14	23.16	22.86	22.37	23.36	23.06	22.57
		RB6#0	21.92	21.77	21.73	22.12	21.97	21.93
		RB6#9	21.80	21.79	21.64	22	21.99	21.84
		RB15#0	21.86	21.63	21.52	22.06	21.83	21.72

Bandwidth (MHz)	Modulation	RB size/ RB Offset	Conducted Average Output Power (dBm)			EIRP(dBm)		
			Low	Mid	High	Low	Mid	High
5.0	QPSK	RB1#0	23.51	23.60	23.22	23.71	23.8	23.42
		RB1#13	23.36	23.60	23.23	23.56	23.8	23.43
		RB1#24	23.40	23.64	23.18	23.6	23.84	23.38
		RB15#0	22.65	22.52	22.43	22.85	22.72	22.63
		RB15#10	22.52	22.51	22.39	22.72	22.71	22.59
		RB25#0	22.52	22.52	22.45	22.72	22.72	22.65
	16QAM	RB1#0	21.82	22.55	22.45	22.02	22.75	22.65
		RB1#13	21.69	22.57	22.47	21.89	22.77	22.67
		RB1#24	21.66	22.58	22.47	21.86	22.78	22.67
		RB15#0	21.81	21.50	21.44	22.01	21.7	21.64
		RB15#10	21.70	21.50	21.45	21.9	21.7	21.65
		RB25#0	21.81	21.55	21.58	22.01	21.75	21.78
10.0	QPSK	RB1#0	23.51	23.60	23.22	23.71	23.8	23.42
		RB1#0	23.50	23.46	23.59	23.7	23.66	23.79
		RB1#25	23.46	23.50	23.51	23.66	23.7	23.71
		RB1#49	23.43	23.52	23.54	23.63	23.72	23.74
		RB25#0	22.57	22.49	22.48	22.77	22.69	22.68
		RB25#25	22.48	22.53	22.44	22.68	22.73	22.64
	16QAM	RB50#0	22.41	22.59	22.53	22.61	22.79	22.73
		RB1#0	23.11	23.19	22.29	23.31	23.39	22.49
		RB1#25	22.92	23.24	22.22	23.12	23.44	22.42
		RB1#49	22.91	23.24	22.15	23.11	23.44	22.35
		RB25#0	21.69	21.69	21.69	21.89	21.89	21.89
		RB25#25	21.73	21.64	21.73	21.93	21.84	21.93
		RB50#0	21.63	21.71	21.68	21.83	21.91	21.88

Bandwidth (MHz)	Modulation	RB size/ RB Offset	Conducted Average Output Power (dBm)			EIRP(dBm)		
			Low	Mid	High	Low	Mid	High
15.0	QPSK	RB1#0	23.53	23.38	23.43	23.73	23.58	23.63
		RB1#38	23.38	23.46	23.46	23.58	23.66	23.66
		RB1#74	23.44	23.51	23.43	23.64	23.71	23.63
		RB36#0	22.47	22.42	22.58	22.67	22.62	22.78
		RB36#39	22.51	22.48	22.48	22.71	22.68	22.68
		RB75#0	22.52	22.51	22.47	22.72	22.71	22.67
	16QAM	RB1#0	23.02	23.18	22.78	23.22	23.38	22.98
		RB1#38	22.89	23.18	22.80	23.09	23.38	23
		RB1#74	22.88	23.27	22.84	23.08	23.47	23.04
		RB36#0	21.57	21.61	21.62	21.77	21.81	21.82
		RB36#39	21.55	21.69	21.67	21.75	21.89	21.87
		RB75#0	21.69	21.67	21.65	21.89	21.87	21.85
20.0	QPSK	RB1#0	23.68	23.63	23.62	23.88	23.83	23.82
		RB1#50	23.48	23.77	23.61	23.68	23.97	23.81
		RB1#99	23.71	23.73	23.64	23.91	23.93	23.84
		RB50#0	22.60	22.49	22.65	22.8	22.69	22.85
		RB50#50	22.48	22.62	22.61	22.68	22.82	22.81
		RB100#0	22.46	22.59	22.54	22.66	22.79	22.74
	16QAM	RB1#0	22.91	22.58	23.07	23.11	22.78	23.27
		RB1#50	22.71	22.93	23.12	22.91	23.13	23.32
		RB1#99	22.84	22.94	23.10	23.04	23.14	23.3
		RB50#0	21.74	21.73	21.55	21.94	21.93	21.75
		RB50#50	21.74	21.87	21.68	21.94	22.07	21.88
		RB100#0	21.67	21.65	21.81	21.87	21.85	22.01

Note: EIRP(dBm) = Conducted Power(dBm) + Antenna Gain(dBi) - Cable loss(dB)

For LTE Band 4: Antenna Gain = 1.2dBi

Cable Loss=1dB*(provided by the applicant)

Limit: EIRP ≤ 33dBm

Peak-to-average ratio (PAR)**20MHz Bandwidth**

Modulation	Low channel (dB)	Middle channel (dB)	High channel (dB)	PAR Limit (dB)	Result
QPSK (1RB Size)	4.81	4.52	3.49	13	Pass
QPSK (100RB Size)	5.64	5.35	5.32	13	Pass
16QAM (1RB Size)	5.90	5.35	4.65	13	Pass
16QAM (100RB Size)	6.41	6.25	6.19	13	Pass

LTE Band 5:

Maximum Output Power

Bandwidth (MHz)	Modulation	RB size/ RB Offset	Conducted Average Output Power (dBm)			ERP(dBm)		
			Low	Mid	High	Low	Mid	High
1.4	QPSK	RB1#0	23.56	23.45	23.71	18.91	18.80	19.06
		RB1#3	23.57	23.53	23.69	18.92	18.88	19.04
		RB1#5	23.61	23.45	23.67	18.96	18.80	19.02
		RB3#0	23.68	23.66	23.59	19.03	19.01	18.94
		RB3#3	23.70	23.53	23.57	19.05	18.88	18.92
		RB6#0	22.55	22.52	22.51	17.90	17.87	17.86
	16QAM	RB1#0	23.09	23.39	22.31	18.44	18.74	17.66
		RB1#3	23.19	23.23	22.30	18.54	18.58	17.65
		RB1#5	23.09	23.14	22.34	18.44	18.49	17.69
		RB3#0	22.45	22.49	22.26	17.80	17.84	17.61
		RB3#3	22.49	22.41	22.25	17.84	17.76	17.60
		RB6#0	21.53	21.52	21.50	16.88	16.87	16.85
3.0	QPSK	RB1#0	23.53	23.54	23.77	18.88	18.89	19.12
		RB1#8	23.51	23.56	23.72	18.86	18.91	19.07
		RB1#14	23.44	23.47	23.70	18.79	18.82	19.05
		RB6#0	22.61	22.59	22.52	17.96	17.94	17.87
		RB6#9	22.51	22.58	22.59	17.86	17.93	17.94
		RB15#0	22.65	22.63	22.51	18.00	17.98	17.86
	16QAM	RB1#0	22.71	23.20	22.23	18.06	18.55	17.58
		RB1#8	22.68	23.23	22.19	18.03	18.58	17.54
		RB1#14	22.66	23.16	22.28	18.01	18.51	17.63
		RB6#0	21.58	21.56	21.78	16.93	16.91	17.13
		RB6#9	21.55	21.54	21.66	16.90	16.89	17.01
		RB15#0	21.61	21.54	21.64	16.96	16.89	16.99

Bandwidth (MHz)	Modulation	RB size/ RB Offset	Conducted Average Output Power (dBm)			ERP(dBm)		
			Low	Mid	High	Low	Mid	High
5.0	QPSK	RB1#0	23.59	23.72	23.54	18.94	19.07	18.89
		RB1#13	23.59	23.66	23.62	18.94	19.01	18.97
		RB1#24	23.54	23.79	23.56	18.89	19.14	18.91
		RB15#0	22.68	22.55	22.66	18.03	17.90	18.01
		RB15#10	22.69	22.56	22.67	18.04	17.91	18.02
		RB25#0	22.65	22.54	22.71	18.00	17.89	18.06
	16QAM	RB1#0	21.88	22.68	22.66	17.23	18.03	18.01
		RB1#13	21.85	22.58	22.62	17.20	17.93	17.97
		RB1#24	21.85	22.64	22.66	17.20	17.99	18.01
		RB15#0	21.71	21.59	21.53	17.06	16.94	16.88
		RB15#10	21.70	21.41	21.66	17.05	16.76	17.01
		RB25#0	21.78	21.51	21.89	17.13	16.86	17.24
10.0	QPSK	RB1#0	23.63	23.59	23.55	18.98	18.94	18.90
		RB1#25	23.60	23.68	23.65	18.95	19.03	19.00
		RB1#49	23.54	23.77	23.60	18.89	19.12	18.95
		RB25#0	22.63	22.75	22.63	17.98	18.10	17.98
		RB25#25	22.62	22.61	22.67	17.97	17.96	18.02
		RB50#0	22.64	22.69	22.74	17.99	18.04	18.09
	16QAM	RB1#0	23.04	22.86	22.20	18.39	18.21	17.55
		RB1#25	22.98	22.83	22.16	18.33	18.18	17.51
		RB1#49	22.96	23.28	22.17	18.31	18.63	17.52
		RB25#0	21.66	21.73	21.79	17.01	17.08	17.14
		RB25#25	21.66	21.64	21.89	17.01	16.99	17.24
		RB50#0	21.65	21.56	21.70	17.00	16.91	17.05

Note: ERP(dBm) = Conducted Power(dBm) + Antenna Gain(dBd) - Cable Loss(dB)

For LTE Band5: Antenna Gain = -2.0dBi = -4.15dBd (0dBd=2.15dBi)

Cable Loss=0.5dB

The limit: ERP ≤ 38.45dBm

Peak-to-average ratio (PAR)**10MHz bandwidth**

Modulation	Low channel (dB)	Middle channel (dB)	High channel (dB)	PAR Limit (dB)	Result
QPSK (1RB Size)	3.65	4.10	4.29	13	Pass
QPSK (50RB Size)	5.26	5.45	5.29	13	Pass
16QAM (1RB Size)	4.49	5.13	4.84	13	Pass
16QAM (50RB Size)	6.15	6.28	6.15	13	Pass

LTE Band 7:

Maximum Output Power

Bandwidth (MHz)	Modulation	RB size/ RB Offset	Conducted Average Output Power (dBm)			EIRP(dBm)		
			Low	Mid	High	Low	Mid	High
5	QPSK	RB1#0	21.07	21.26	20.91	21.87	22.06	21.71
		RB1#13	21.08	21.23	20.86	21.88	22.03	21.66
		RB1#24	21.1	21.22	20.82	21.90	22.02	21.62
		RB15#0	20.21	20.25	20.14	21.01	21.05	20.94
		RB15#10	20.21	20.14	20.07	21.01	20.94	20.87
		RB25#0	20.11	20.11	20.28	20.91	20.91	21.08
	16QAM	RB1#0	19.6	20.28	20.29	20.40	21.08	21.09
		RB1#13	19.61	20.3	20.31	20.41	21.10	21.11
		RB1#24	19.58	20.32	20.24	20.38	21.12	21.04
		RB15#0	19.34	19.14	19.23	20.14	19.94	20.03
		RB15#10	19.33	19.19	19.21	20.13	19.99	20.01
		RB25#0	19.38	19.21	19.37	20.18	20.01	20.17
10	QPSK	RB1#0	21	21.02	21.33	21.80	21.82	22.13
		RB1#25	21	21	21.28	21.80	21.80	22.08
		RB1#49	20.99	21.06	21.22	21.79	21.86	22.02
		RB25#0	20.23	20.14	20.22	21.03	20.94	21.02
		RB25#25	20.08	20.21	20.27	20.88	21.01	21.07
		RB50#0	20.18	20.12	20.26	20.98	20.92	21.06
	16QAM	RB1#0	20.44	20.55	19.79	21.24	21.35	20.59
		RB1#25	20.45	20.44	19.83	21.25	21.24	20.63
		RB1#49	20.52	20.51	19.74	21.32	21.31	20.54
		RB25#0	19.26	19.42	19.43	20.06	20.22	20.23
		RB25#25	19.27	19.44	19.43	20.07	20.24	20.23
		RB50#0	19.35	19.33	19.45	20.15	20.13	20.25

Bandwidth (MHz)	Modulation	RB size/ RB Offset	Conducted Average Output Power (dBm)			EIRP(dBm)		
			Low	Mid	High	Low	Mid	High
15	QPSK	RB1#0	20.88	20.96	20.9	21.68	21.76	21.7
		RB1#38	20.91	20.92	20.99	21.71	21.72	21.79
		RB1#74	20.87	20.86	20.96	21.67	21.66	21.76
		RB36#0	20.03	20.06	20.06	20.83	20.86	20.86
		RB36#39	20.02	20.06	20.08	20.82	20.86	20.88
		RB75#0	20.02	20.04	20.04	20.82	20.84	20.84
	16QAM	RB1#0	20.26	20.52	20.46	21.06	21.32	21.26
		RB1#38	20.31	20.52	20.25	21.11	21.32	21.05
		RB1#74	20.37	20.5	20.21	21.17	21.30	21.01
		RB36#0	19.22	19.22	19.13	20.02	20.02	19.93
		RB36#39	19.24	19.23	19.24	20.04	20.03	20.04
		RB75#0	19.13	19.25	19.2	19.93	20.05	20.00
20	QPSK	RB1#0	21.14	21.28	21.01	21.94	22.08	21.81
		RB1#50	21.10	20.99	21.00	21.90	21.79	21.80
		RB1#99	21.17	20.94	21.05	21.97	21.74	21.85
		RB50#0	20.00	20.13	20.09	20.80	20.93	20.89
		RB50#50	20.07	20.15	20.15	20.87	20.95	20.95
		RB100#0	19.99	20.01	20.06	20.79	20.81	20.86
	16QAM	RB1#0	20.03	20.24	20.67	20.83	21.04	21.47
		RB1#50	20.03	20.21	20.64	20.83	21.01	21.44
		RB1#99	20.06	20.24	20.66	20.86	21.04	21.46
		RB50#0	19.27	19.39	19.14	20.07	20.19	19.94
		RB50#50	19.22	19.34	19.22	20.02	20.14	20.02
		RB100#0	19.21	19.18	19.19	20.01	19.98	19.99

Note: EIRP(dBm) = Conducted Power(dBm) + Antenna Gain(dBi) - Cable loss(dB)

For LTE Band 7: Antenna Gain = 1.8dBi

Cable Loss=1dB*(provided by the applicant)

Limit: EIRP ≤ 33dBm

Peak-to-average ratio (PAR)**20MHz bandwidth**

Modulation	Low channel (dB)	Middle channel (dB)	High channel (dB)	PAR Limit (dB)	Result
QPSK (1RB Size)	3.56	4.53	5.43	13	Pass
QPSK (100RB Size)	5.17	5.54	5.31	13	Pass
16QAM (1RB Size)	4.84	6.00	5.96	13	Pass
16QAM (100RB Size)	6.02	6.32	6.18	13	Pass

LTE Band 12:

Maximum Output Power

Bandwidth (MHz)	Modulation	RB size/ RB Offset	Conducted Average Output Power (dBm)			ERP(dBm)		
			Low	Mid	High	Low	Mid	High
1.4	QPSK	RB1#0	23.50	23.28	23.07	18.85	18.63	18.42
		RB1#3	23.47	23.20	23.20	18.82	18.55	18.55
		RB1#5	23.47	23.21	23.12	18.82	18.56	18.47
		RB3#0	23.41	23.38	23.11	18.76	18.73	18.46
		RB3#3	23.46	23.28	23.22	18.81	18.63	18.57
		RB6#0	22.31	22.05	22.18	17.66	17.4	17.53
	16QAM	RB1#0	22.80	22.69	23.23	18.15	18.04	18.58
		RB1#3	22.76	22.57	23.12	18.11	17.92	18.47
		RB1#5	22.78	22.57	23.00	18.13	17.92	18.35
		RB3#0	22.48	22.26	21.97	17.83	17.61	17.32
		RB3#3	22.47	22.31	22.08	17.82	17.66	17.43
		RB6#0	21.52	21.29	21.21	16.87	16.64	16.56
3.0	QPSK	RB1#0	23.25	23.17	23.40	18.6	18.52	18.75
		RB1#8	23.31	23.19	23.35	18.66	18.54	18.7
		RB1#14	23.30	23.18	23.37	18.65	18.53	18.72
		RB6#0	22.23	22.36	22.15	17.58	17.71	17.5
		RB6#9	22.32	22.22	22.25	17.67	17.57	17.6
		RB15#0	22.29	22.20	22.20	17.64	17.55	17.55
	16QAM	RB1#0	22.57	22.45	21.69	17.92	17.8	17.04
		RB1#8	22.34	22.37	21.63	17.69	17.72	16.98
		RB1#14	22.39	22.29	21.78	17.74	17.64	17.13
		RB6#0	21.29	21.27	21.17	16.64	16.62	16.52
		RB6#9	21.35	21.22	21.35	16.7	16.57	16.7
		RB15#0	21.24	21.16	21.00	16.59	16.51	16.35

Bandwidth (MHz)	Modulation	RB size/ RB Offset	Conducted Average Output Power (dBm)			ERP(dBm)		
			Low	Mid	High	Low	Mid	High
5.0	QPSK	RB1#0	23.33	23.36	23.15	18.68	18.71	18.5
		RB1#13	23.37	23.29	23.13	18.72	18.64	18.48
		RB1#24	23.26	23.38	23.16	18.61	18.73	18.51
		RB15#0	22.30	22.30	22.27	17.65	17.65	17.62
		RB15#10	22.23	22.22	22.32	17.58	17.57	17.67
		RB25#0	22.25	22.23	22.27	17.6	17.58	17.62
	16QAM	RB1#0	21.37	22.27	22.22	16.72	17.62	17.57
		RB1#13	21.47	22.25	22.18	16.82	17.6	17.53
		RB1#24	21.49	22.30	22.33	16.84	17.65	17.68
		RB15#0	21.27	21.13	21.15	16.62	16.48	16.5
		RB15#10	21.45	21.04	21.19	16.8	16.39	16.54
		RB25#0	21.45	21.20	21.27	16.8	16.55	16.62
10.0	QPSK	RB1#0	23.33	23.36	23.33	18.68	18.71	18.68
		RB1#25	23.29	23.28	23.31	18.64	18.63	18.66
		RB1#49	23.20	23.33	23.39	18.55	18.68	18.74
		RB25#0	22.37	22.39	22.27	17.72	17.74	17.62
		RB25#25	22.36	22.34	22.29	17.71	17.69	17.64
		RB50#0	22.32	22.30	22.29	17.67	17.65	17.64
	16QAM	RB1#0	22.61	22.46	21.95	17.96	17.81	17.3
		RB1#25	22.55	22.40	21.87	17.9	17.75	17.22
		RB1#49	22.53	22.49	21.92	17.88	17.84	17.27
		RB25#0	21.41	21.33	21.38	16.76	16.68	16.73
		RB25#25	21.25	21.25	21.41	16.6	16.6	16.76
		RB50#0	21.27	21.30	21.22	16.62	16.65	16.57

Note: ERP(dBm) = Conducted Power(dBm) + Antenna Gain(dBd) - Cable Loss(dB)
 For LTE Band12: Antenna Gain = -2.0dBi = -4.15dBd (0dBd=2.15dBi)
 Cable Loss=0.5dB
 The limit: ERP ≤ 34.77dBm

Peak-to-average ratio (PAR)**10MHz bandwidth**

Modulation	Low channel (dB)	Middle channel (dB)	High channel (dB)	PAR Limit (dB)	Result
QPSK (1RB Size)	4.12	4.11	4.55	13	Pass
QPSK (50RB Size)	5.35	5.47	5.40	13	Pass
16QAM (1RB Size)	5.33	5.01	5.66	13	Pass
16QAM (50RB Size)	6.27	6.21	6.28	13	Pass

LTE Band 17:

Maximum Output Power

Bandwidth (MHz)	Modulation	RB size/ RB Offset	Conducted Average Output Power (dBm)			ERP(dBm)		
			Low	Mid	High	Low	Mid	High
5.0	QPSK	RB1#0	23.30	23.35	23.49	18.65	18.70	18.84
		RB1#13	23.22	23.39	23.50	18.57	18.74	18.85
		RB1#24	23.18	23.26	23.56	18.53	18.61	18.91
		RB15#0	22.43	22.43	22.43	17.78	17.78	17.78
		RB15#10	22.37	22.28	22.34	17.72	17.63	17.69
		RB25#0	22.48	22.39	22.41	17.83	17.74	17.76
	16QAM	RB1#0	21.88	21.51	22.38	17.23	16.86	17.73
		RB1#13	21.90	21.54	22.34	17.25	16.89	17.69
		RB1#24	21.81	21.55	22.34	17.16	16.90	17.69
		RB15#0	21.36	21.26	21.24	16.71	16.61	16.59
10.0	QPSK	RB1#0	23.34	23.33	23.36	18.69	18.68	18.71
		RB1#25	23.17	23.37	23.36	18.52	18.72	18.71
		RB1#49	23.38	23.35	23.46	18.73	18.70	18.81
		RB25#0	22.43	22.27	22.38	17.78	17.62	17.73
		RB25#25	22.36	22.42	22.43	17.71	17.77	17.78
		RB50#0	22.29	22.37	22.25	17.64	17.72	17.60
	16QAM	RB1#0	22.31	23.13	21.93	17.66	18.48	17.28
		RB1#25	22.24	23.04	21.89	17.59	18.39	17.24
		RB1#49	22.40	23.02	22.00	17.75	18.37	17.35
		RB25#0	21.28	21.27	21.42	16.63	16.62	16.77
		RB25#25	21.39	21.39	21.43	16.74	16.74	16.78
		RB50#0	21.27	21.25	21.23	16.62	16.60	16.58

Note: ERP(dBm) = Conducted Power(dBm) + Antenna Gain(dBd) - Cable Loss(dB)
 For LTE Band17: Antenna Gain = -2.0dBi = -4.15dBd (0dBd=2.15dBi)
 Cable Loss=0.5dB
 The limit: ERP ≤ 34.77dBm

Peak-to-average ratio (PAR)**10MHz bandwidth**

Modulation	Low channel (dB)	Middle channel (dB)	High channel (dB)	PAR Limit (dB)	Result
QPSK (1RB Size)	5.11	5.24	4.63	13	Pass
QPSK (50RB Size)	5.43	5.34	5.40	13	Pass
16QAM (1RB Size)	6.33	6.30	5.69	13	Pass
16QAM (50RB Size)	6.15	6.20	6.23	13	Pass

LTE Band 66:

Bandwidth (MHz)	Modulation	RB size/ RB Offset	Conducted Average Output Power (dBm)			EIRP(dBm)		
			Low	Mid	High	Low	Mid	High
1.4	QPSK	RB1#0	23.86	23.61	23.61	24.06	23.81	23.81
		RB1#3	23.62	23.59	23.59	23.82	23.79	23.79
		RB1#5	23.60	23.54	23.60	23.8	23.74	23.8
		RB3#0	23.70	23.83	23.56	23.9	24.03	23.76
		RB3#3	23.64	23.78	23.50	23.84	23.98	23.7
		RB6#0	22.63	22.76	22.57	22.83	22.96	22.77
	16QAM	RB1#0	22.83	23.03	22.55	23.03	23.23	22.75
		RB1#3	22.85	23	22.1	23.05	23.2	22.3
		RB1#5	22.25	22.48	22.44	22.45	22.68	22.64
		RB3#0	22.3	22.42	22.37	22.5	22.62	22.57
		RB3#3	21.49	21.46	21.57	21.69	21.66	21.77
		RB6#0	23.55	23.3	23.3	23.75	23.5	23.5
3.0	QPSK	RB1#0	23.56	23.63	23.53	23.76	23.83	23.73
		RB1#8	23.53	23.59	23.45	23.73	23.79	23.65
		RB1#14	23.63	23.66	23.51	23.83	23.86	23.71
		RB6#0	22.71	22.72	22.63	22.91	22.92	22.83
		RB6#9	22.62	22.68	22.60	22.82	22.88	22.8
		RB15#0	22.69	22.73	22.65	22.89	22.93	22.85
	16QAM	RB1#0	22.81	22.72	22.08	23.01	22.92	22.28
		RB1#8	22.73	22.62	22.12	22.93	22.82	22.32
		RB1#14	21.47	21.58	21.58	21.67	21.78	21.78
		RB6#0	21.62	21.57	21.56	21.82	21.77	21.76
		RB6#9	21.55	21.47	21.46	21.75	21.67	21.66
		RB15#0	23.25	23.32	23.22	23.45	23.52	23.42

Bandwidth (MHz)	Modulation	RB size/ RB Offset	Conducted Average Output Power (dBm)			EIRP(dBm)		
			Low	Mid	High	Low	Mid	High
5.0	QP SK	RB1#0	23.59	23.83	23.40	23.79	24.03	23.6
		RB1#13	23.58	23.76	23.35	23.78	23.96	23.55
		RB1#24	23.62	23.83	23.37	23.82	24.03	23.57
		RB15#0	22.77	22.68	22.55	22.97	22.88	22.75
		RB15#10	22.65	22.64	22.57	22.85	22.84	22.77
		RB25#0	22.66	22.70	22.51	22.86	22.9	22.71
	16QAM	RB1#0	21.51	22.57	22.33	21.71	22.77	22.53
		RB1#13	21.5	22.59	22.33	21.7	22.79	22.53
		RB1#24	21.61	21.39	21.25	21.81	21.59	21.45
		RB15#0	21.57	21.4	21.34	21.77	21.6	21.54
		RB15#10	21.61	21.46	21.41	21.81	21.66	21.61
		RB25#0	23.28	23.52	23.09	23.48	23.72	23.29
10.0	QPSK	RB1#0	23.53	23.61	23.41	23.73	23.81	23.61
		RB1#25	23.57	23.65	23.63	23.77	23.85	23.83
		RB1#49	23.59	23.70	23.60	23.79	23.9	23.8
		RB25#0	22.75	22.66	22.59	22.95	22.86	22.79
		RB25#25	22.70	22.74	22.57	22.9	22.94	22.77
		RB50#0	22.60	22.72	22.64	22.8	22.92	22.84
	16QAM	RB1#0	22.58	23.21	21.79	22.78	23.41	21.99
		RB1#25	22.59	23.17	21.82	22.79	23.37	22.02
		RB1#49	21.46	21.53	21.55	21.66	21.73	21.75
		RB25#0	21.52	21.48	21.55	21.72	21.68	21.75
		RB25#25	21.5	21.5	21.46	21.7	21.7	21.66
		RB50#0	23.22	23.3	23.1	23.42	23.5	23.3

Bandwidth (MHz)	Modulation	RB size/ RB Offset	Conducted Average Output Power (dBm)			EIRP(dBm)		
			Low	Mid	High	Low	Mid	High
15.0	QPSK	RB1#0	23.54	23.65	23.44	23.74	23.85	23.64
		RB1#38	23.63	23.61	23.37	23.83	23.81	23.57
		RB1#74	23.60	23.66	23.40	23.8	23.86	23.6
		RB36#0	22.56	22.67	22.68	22.76	22.87	22.88
		RB36#39	22.63	22.64	22.60	22.83	22.84	22.8
		RB75#0	22.66	22.67	22.69	22.86	22.87	22.89
	16QAM	RB1#0	22.79	23.21	22.66	22.99	23.41	22.86
		RB1#38	22.72	23.21	22.45	22.92	23.41	22.65
		RB1#74	21.49	21.43	21.56	21.69	21.63	21.76
		RB36#0	21.58	21.42	21.43	21.78	21.62	21.63
		RB36#39	21.58	21.46	21.46	21.78	21.66	21.66
		RB75#0	23.23	23.34	23.13	23.43	23.54	23.33
20.0	QPSK	RB1#0	23.74	23.85	23.63	23.94	24.05	23.83
		RB1#50	23.65	23.63	23.66	23.85	23.83	23.86
		RB1#99	23.77	23.67	23.63	23.97	23.87	23.83
		RB50#0	22.58	22.60	22.71	22.78	22.8	22.91
		RB50#50	22.57	22.67	22.60	22.77	22.87	22.8
		RB100#0	22.68	22.80	22.72	22.88	23	22.92
	16QAM	RB1#0	22.53	22.3	23.09	22.73	22.5	23.29
		RB1#50	22.45	22.26	23.04	22.65	22.46	23.24
		RB1#99	21.56	21.4	21.53	21.76	21.6	21.73
		RB50#0	21.59	21.47	21.37	21.79	21.67	21.57
		RB50#50	21.52	21.4	21.52	21.72	21.6	21.72
		RB100#0	23.43	23.54	23.32	23.63	23.74	23.52

Note: EIRP(dBm) = Conducted Power(dBm) + Antenna Gain(dBi) - Cable Loss(dB)
 For LTE Band 66: Antenna Gain = 1.2dBi
 Cable Loss=1dB*(provided by the applicant)
 Limit: EIRP≤30dBm

Peak-to-average ratio (PAR)**20MHz bandwidth**

Modulation	Low channel (dB)	Middle channel (dB)	High channel (dB)	PAR Limit (dB)	Result
QPSK (1RB Size)	3.58	4.15	4.18	13	Pass
QPSK (100RB Size)	5.48	5.27	5.27	13	Pass
16QAM (1RB Size)	6.57	5.50	4.65	13	Pass
16QAM (100RB Size)	6.27	6.18	6.35	13	Pass

FCC §2.1049, §22.917, §22.905 & §24.238 & §27.53 - OCCUPIED BANDWIDTH

Applicable Standard

FCC 47 §2.1049, §22.917, §22.905, §24.238 and §27.53.

Test Procedure

The RF output of the transmitter was connected to the simulator and the spectrum analyzer through sufficient attenuation.

The resolution bandwidth of the spectrum analyzer was set at 1% to 5% of the anticipated emission bandwidth and the 26 dB & 99% bandwidth was recorded.

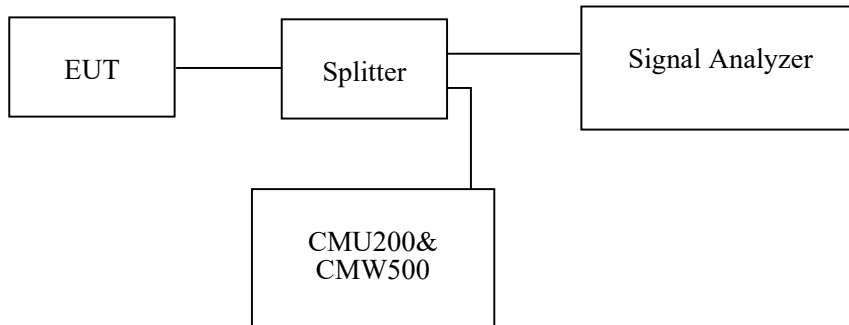

Test Data

Environmental Conditions

Temperature:	25 °C
Relative Humidity:	55 ~62 %
ATM Pressure:	101.0 kPa

The testing was performed by Orlo Yang from 2021-07-18 to 2021-07-20.

EUT operation mode: Transmitting

Test Result: Pass

Please refer to the following tables and plots.

Cellular Band (Part 22H)

Mode	Channel	Frequency (MHz)	99% Occupied Bandwidth (kHz)	26 dB Emission Bandwidth (kHz)
GSM(GMSK)	128	824.2	247.50	319.23
	190	836.6	245.19	314.42
	251	848.8	245.00	319.36
EGPRS(8PSK)	128	824.2	248.40	321.79
	190	836.6	250.00	319.87
	251	848.8	250.00	316.67

	Frequency (MHz)	Occupied Bandwidth (MHz)	26dB Bandwidth (MHz)
RMC	826.4	4.17	4.71
	836.6	4.15	4.69
	846.6	4.17	4.68
HSDPA	826.4	4.17	4.73
	836.6	4.17	4.71
	846.6	4.18	4.71
HSUPA	826.4	4.17	4.70
	836.6	4.15	4.68
	846.6	4.17	4.71

PCS Band (Part 24E)

Mode	Channel	Frequency (MHz)	99% Occupied Bandwidth (kHz)	26 dB Emission Bandwidth (kHz)
GSM(GMSK)	512	1850.2	243.59	314.42
	661	1880.0	246.79	317.63
	810	1909.8	246.79	319.23
EGPRS(8PSK)	512	1850.2	248.40	311.86
	661	1880.0	251.60	323.08
	810	1909.8	248.40	318.27

Frequency (MHz)		Occupied Bandwidth (MHz)	26dB Bandwidth (MHz)
RMC	1852.4	4.15	4.69
	1880.0	4.17	4.71
	1907.6	4.17	4.69
HSDPA	1852.4	4.15	4.69
	1880.0	4.15	4.68
	1907.6	4.17	4.70
HSUPA	1852.4	4.15	4.70
	1880.0	4.17	4.70
	1907.6	4.17	4.70

AWS Band (Part 27)

Frequency (MHz)		Occupied Bandwidth (MHz)	26dB Bandwidth (MHz)
RMC	1712.4	4.15	4.66
	1732.6	4.15	4.70
	1752.6	4.15	4.69
HSDPA	1712.4	4.13	4.72
	1732.6	4.15	4.70
	1752.6	4.15	4.68
HSUPA	1712.4	4.15	4.66
	1732.6	4.17	4.70
	1752.6	4.15	4.68

Cellular Band (Part 22H)

26 dB Emissions & 99% Occupied Bandwidth for GSM (GMSK) Mode, Low channel

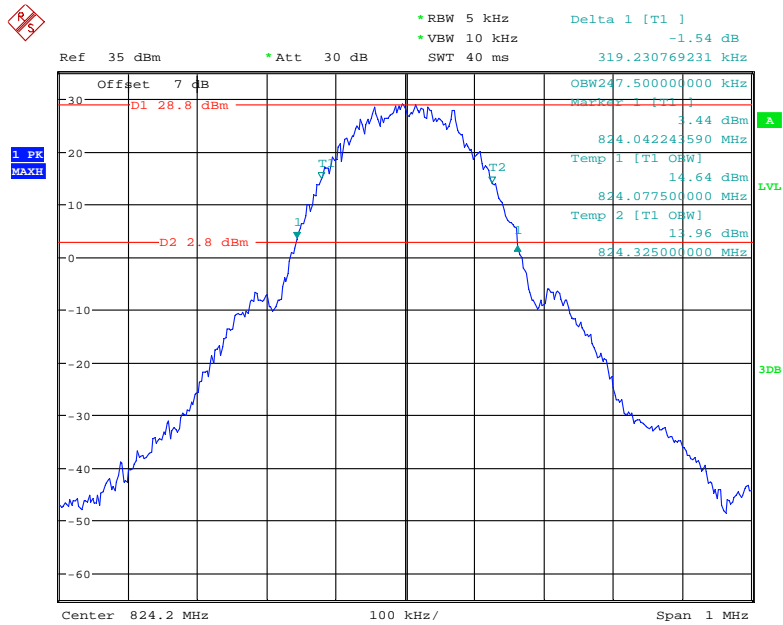

Date: 20.JUL.2021 19:59:40

26 dB Emissions & 99% Occupied Bandwidth for GSM (GMSK) Mode, Middle channel

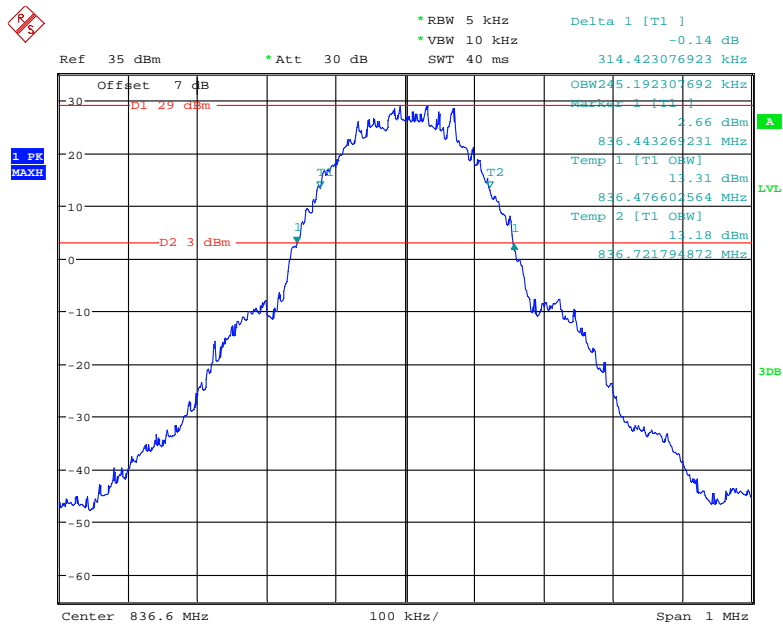

Date: 20.JUL.2021 01:32:41

26 dB Emissions & 99% Occupied Bandwidth for GSM (GMSK) Mode, High channel

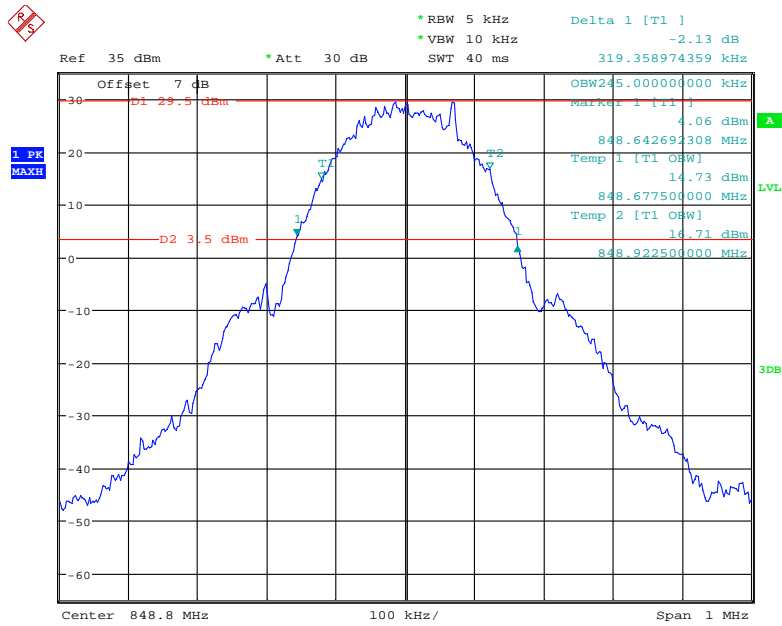

Date: 20.JUL.2021 20:02:14

26 dB Emissions & 99% Occupied Bandwidth for EGPRS (8PSK) Mode, Low channel

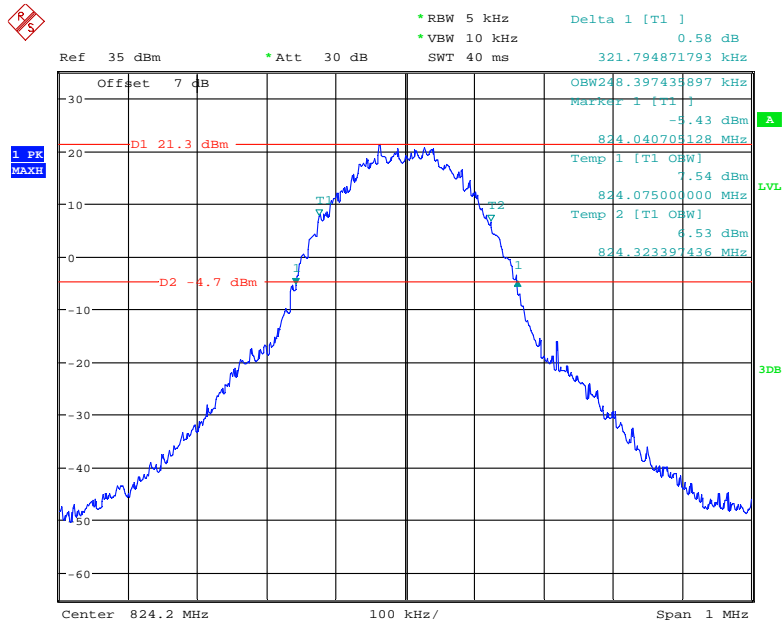

Date: 20.JUL.2021 01:20:39

26 dB Emissions & 99% Occupied Bandwidth for EGPRS (8PSK) Mode, Middle channel

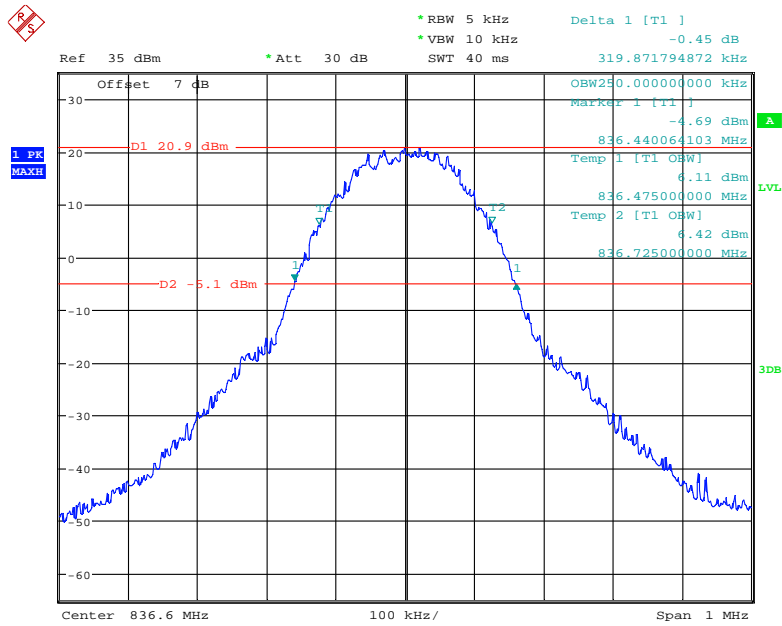

Date: 20.JUL.2021 01:24:39

26 dB Emissions & 99% Occupied Bandwidth for EGPRS (8PSK) Mode, High channel

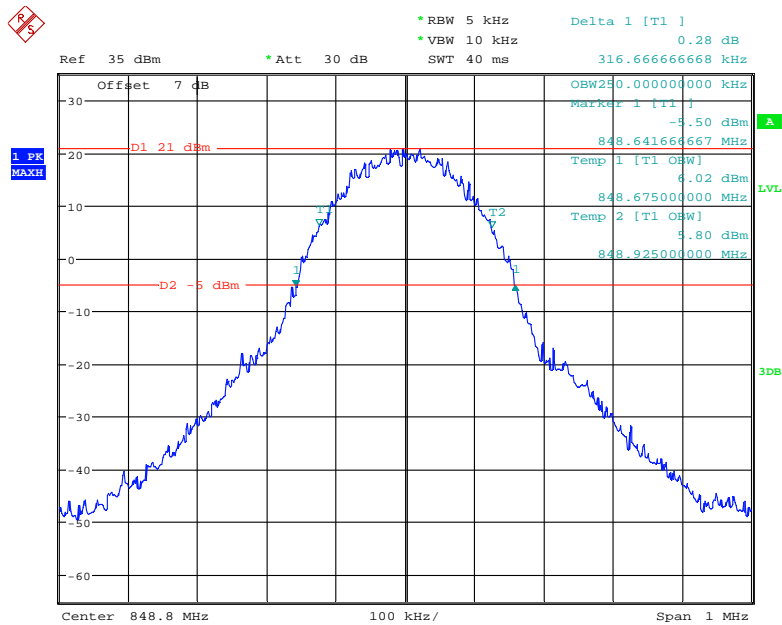

Date: 20.JUL.2021 01:26:02

26 dB Emissions & 99% Occupied Bandwidth for RMC (BPSK) Mode, Low channel

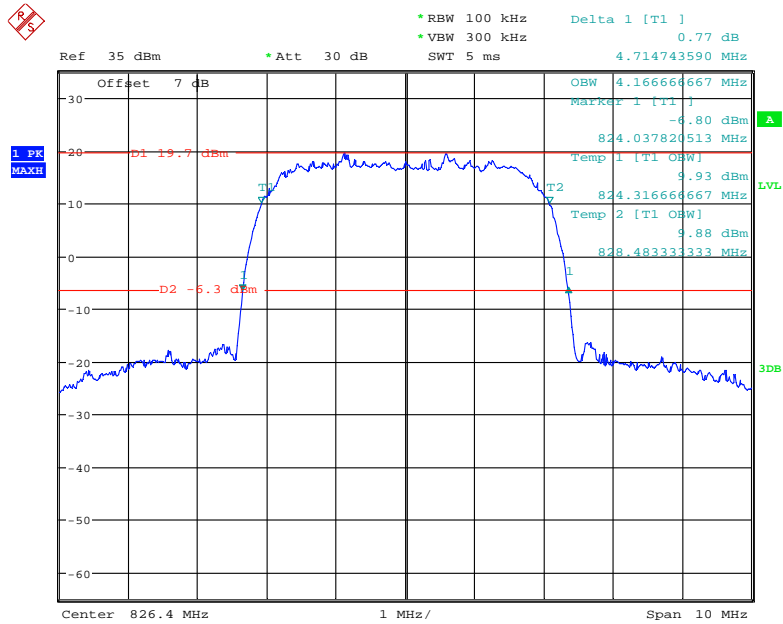

Date: 19.JUL.2021 23:54:45

26 dB Emissions & 99% Occupied Bandwidth for RMC (BPSK) Mode, Middle channel

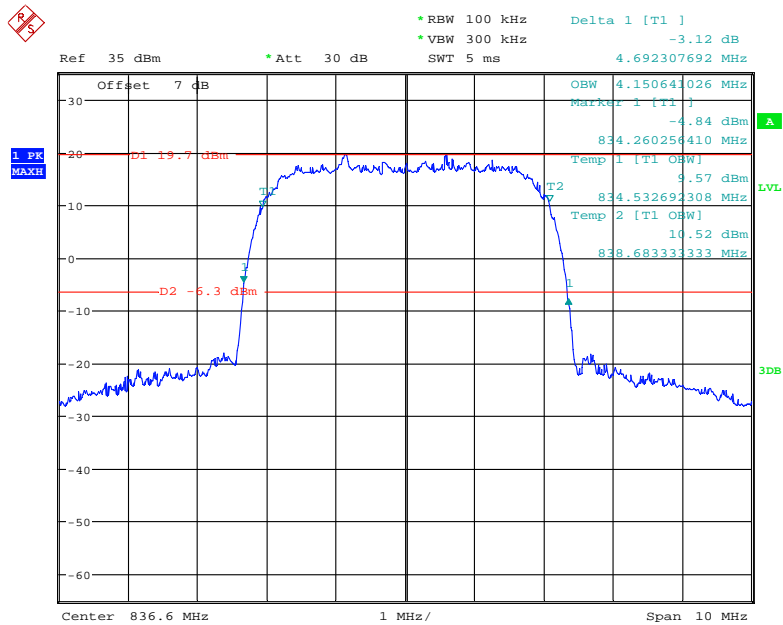

Date: 19.JUL.2021 23:56:27

26 dB Emissions & 99% Occupied Bandwidth for RMC (BPSK) Mode, High channel

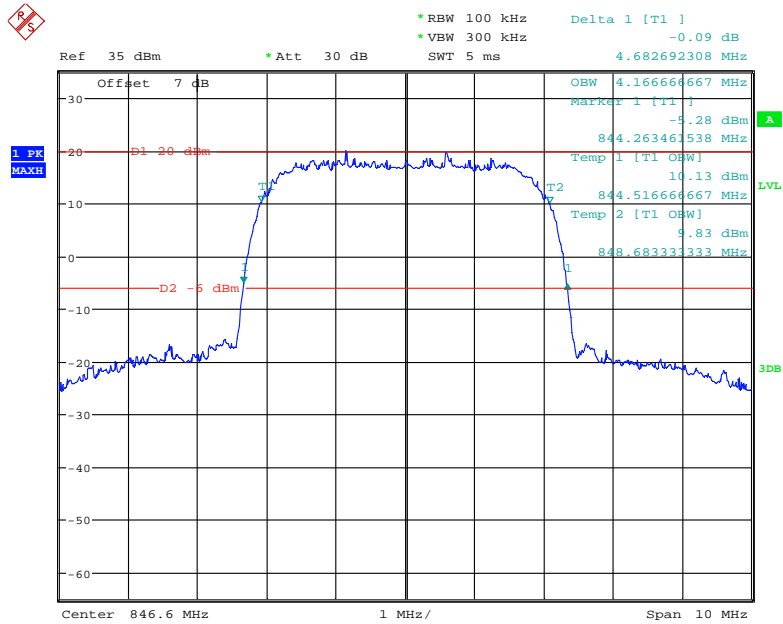

Date: 19.JUL.2021 23:57:30

26 dB Emissions & 99% Occupied Bandwidth for HSUPA (BPSK) Mode, Low channel

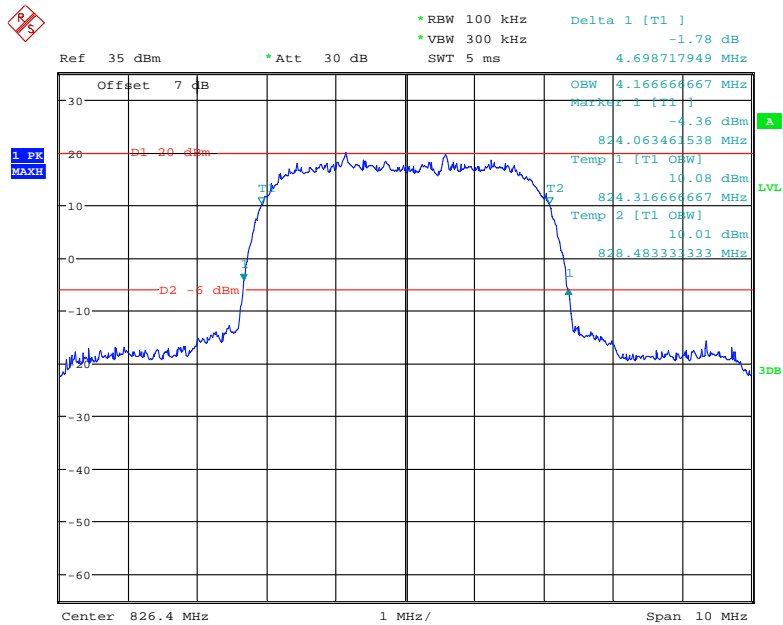

Date: 20.JUL.2021 00:03:49

26 dB Emissions & 99% Occupied Bandwidth for HSUPA (BPSK) Mode, Middle channel

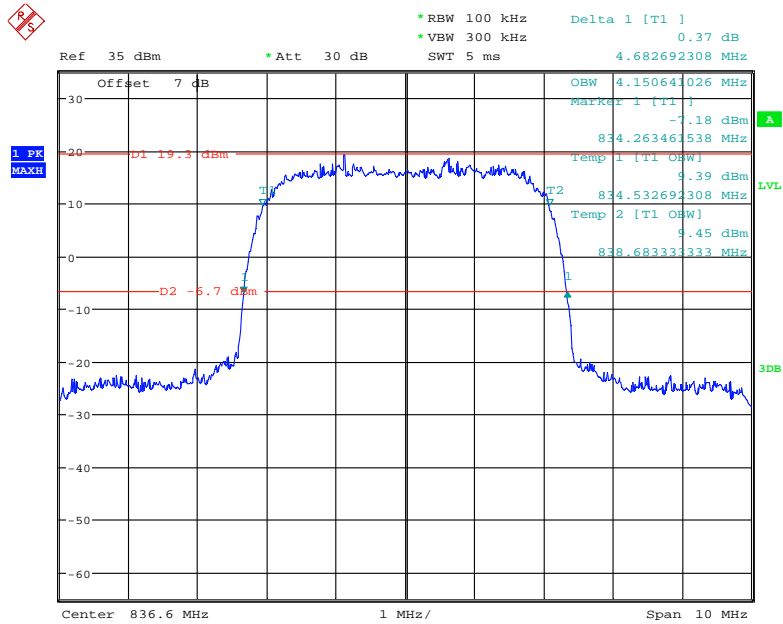

Date: 20.JUL.2021 00:02:29

26 dB Emissions & 99% Occupied Bandwidth for HSUPA (BPSK) Mode, High channel

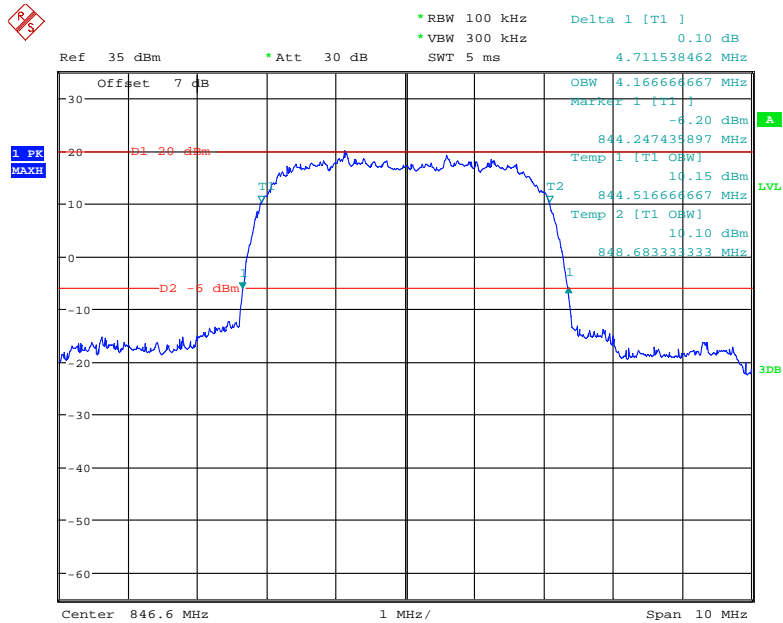

Date: 20.JUL.2021 00:01:08

26 dB Emissions & 99% Occupied Bandwidth for HSDPA (16QAM) Mode, Low channel

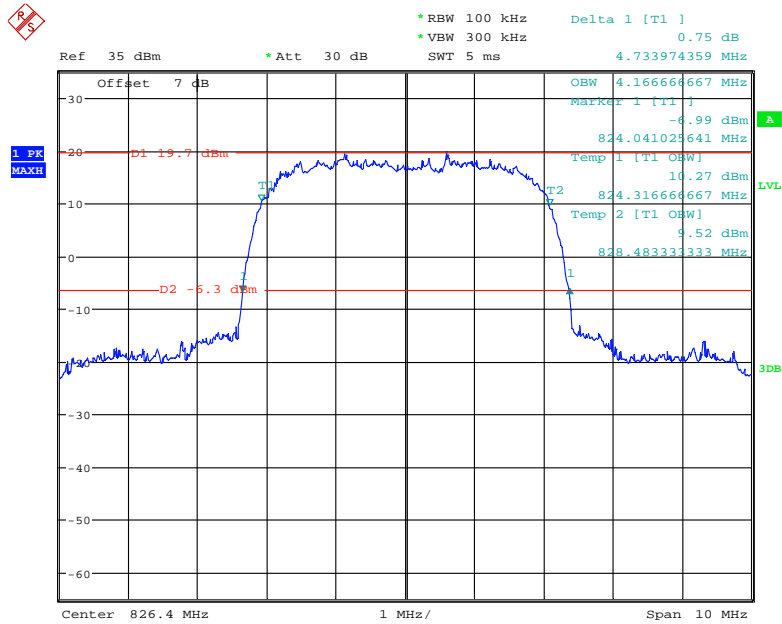

Date: 19.JUL.2021 23:09:17

26 dB Emissions & 99% Occupied Bandwidth for HSDPA (16QAM) Mode, Middle channel

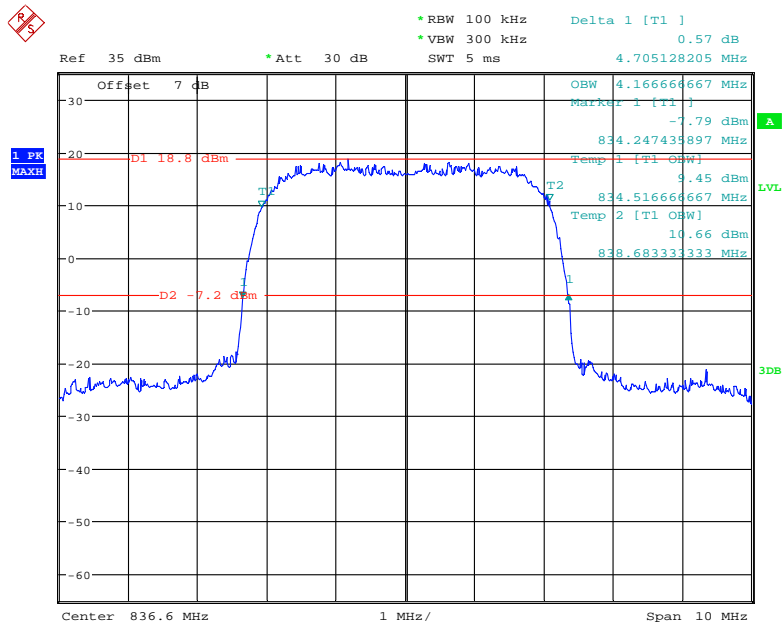

Date: 19.JUL.2021 23:07:48

26 dB Emissions & 99% Occupied Bandwidth for HSDPA (16QAM) Mode, High channel

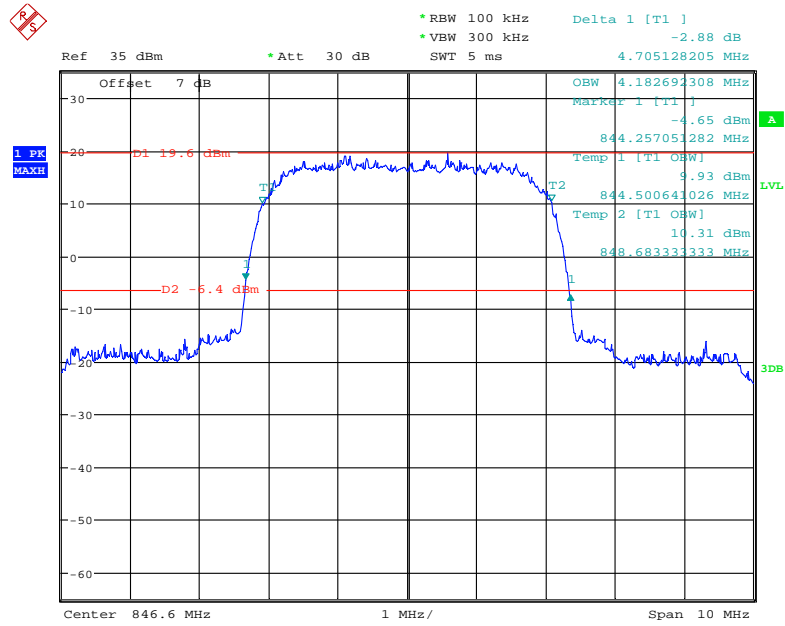

Date: 19.JUL.2021 23:05:47

PCS Band (Part 24E)

26 dB Emissions & 99% Occupied Bandwidth for GSM (GMSK) Mode, Low channel

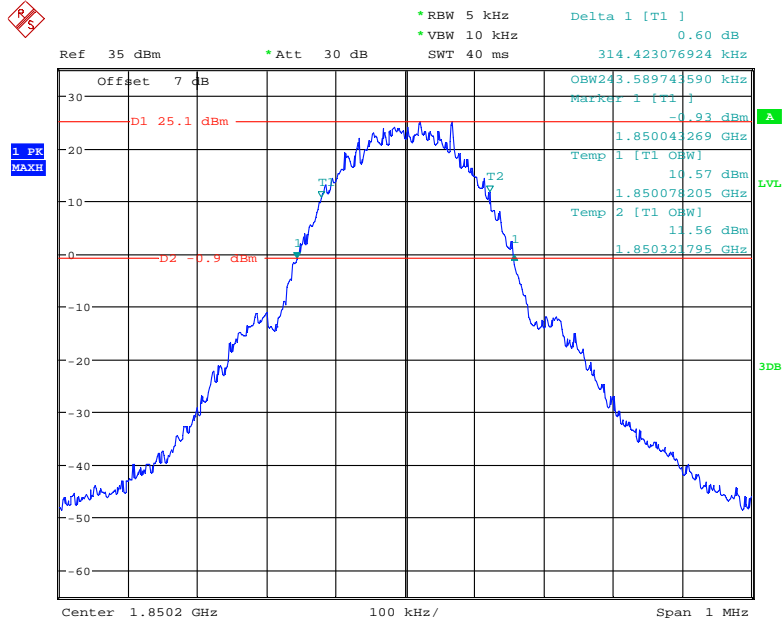

Date: 20.JUL.2021 01:05:05

26 dB Emissions & 99% Occupied Bandwidth for GSM (GMSK) Mode, Middle channel

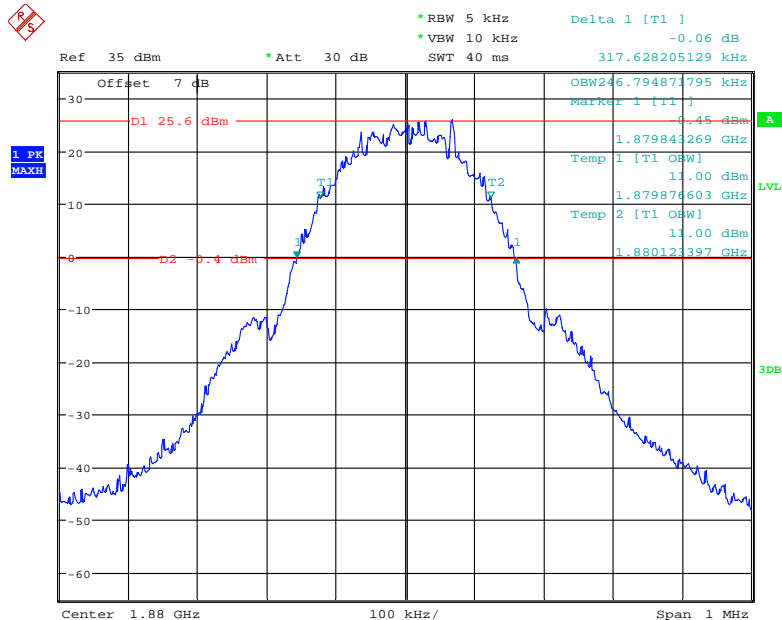

Date: 20.JUL.2021 01:06:25

26 dB Emissions & 99% Occupied Bandwidth for GSM (GMSK) Mode, High channel

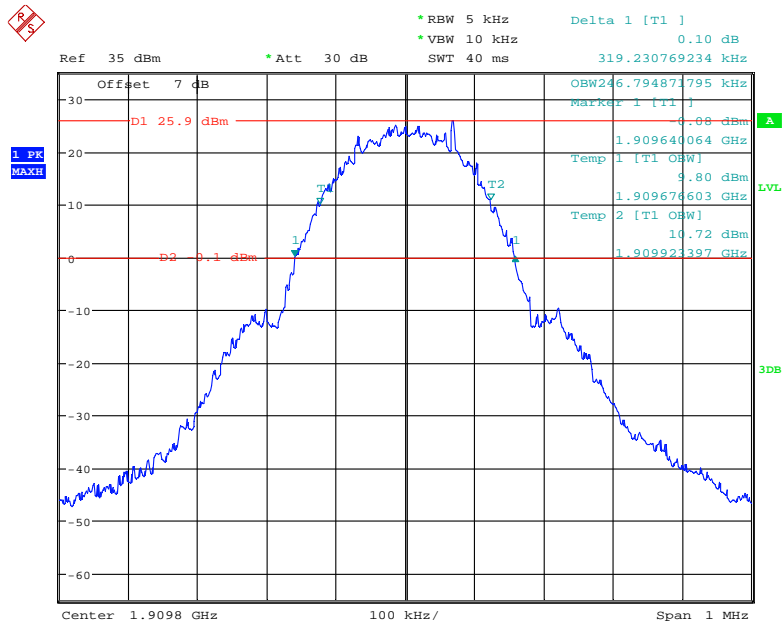

Date: 20.JUL.2021 01:08:01

26 dB Emissions & 99% Occupied Bandwidth for EGPRS (8PSK) Mode, Low channel

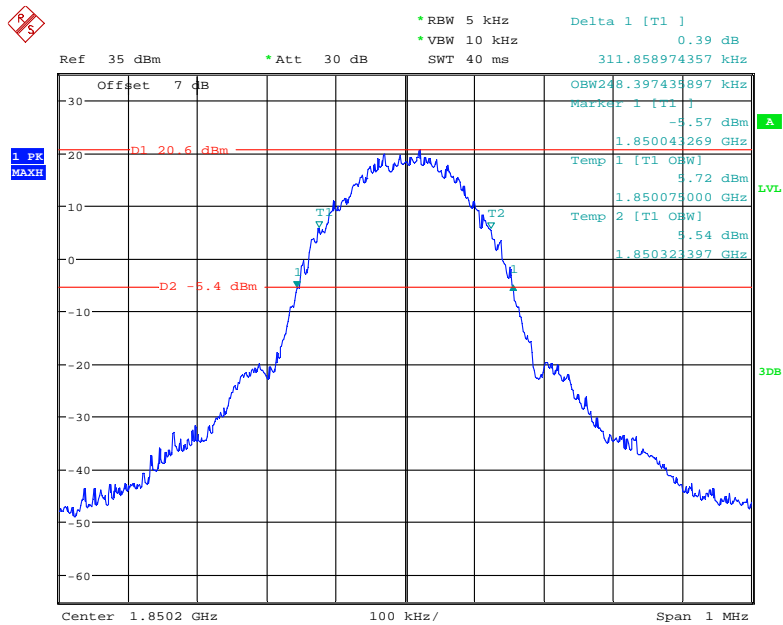

Date: 20.JUL.2021 01:14:12

26 dB Emissions & 99% Occupied Bandwidth for EGPRS (8PSK) Mode, Middle channel

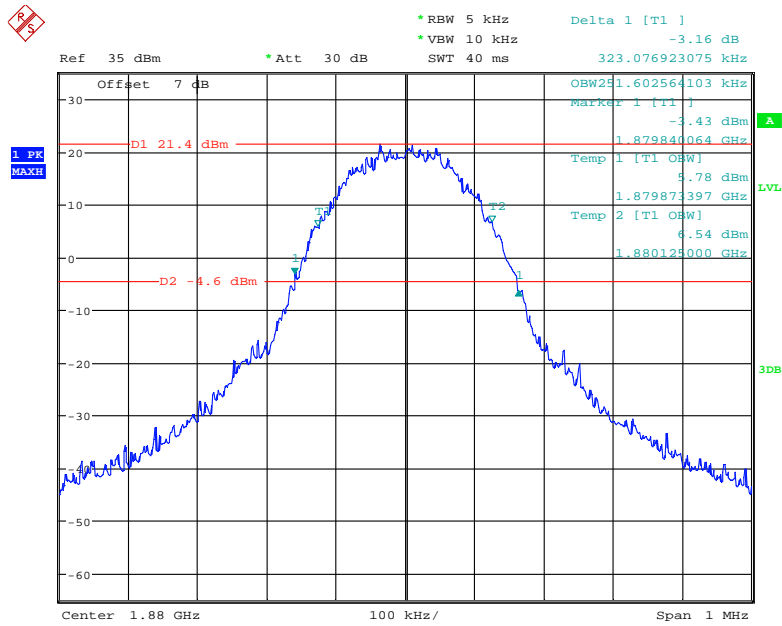

Date: 20.JUL.2021 01:12:54

26 dB Emissions & 99% Occupied Bandwidth for EGPRS (8PSK) Mode, High channel

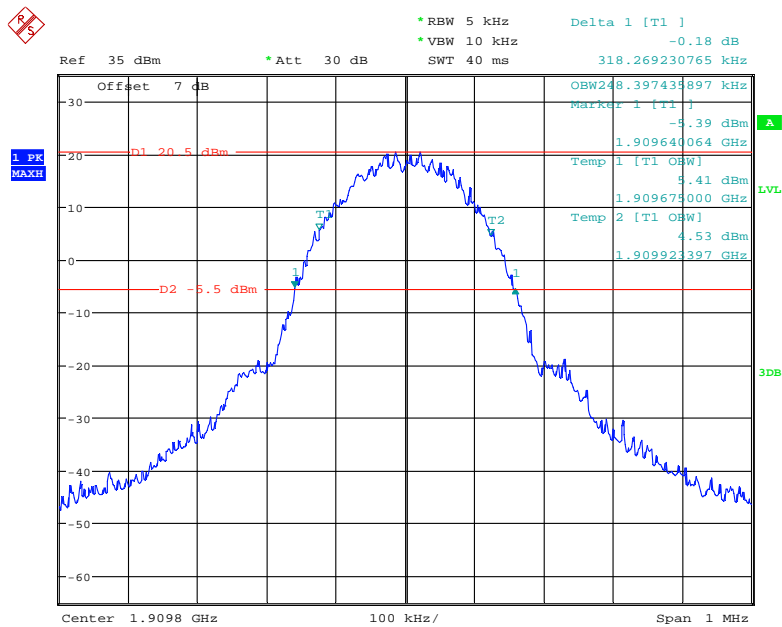

Date: 20.JUL.2021 01:10:31

26 dB Emissions & 99% Occupied Bandwidth for RMC (BPSK) Mode, Low channel

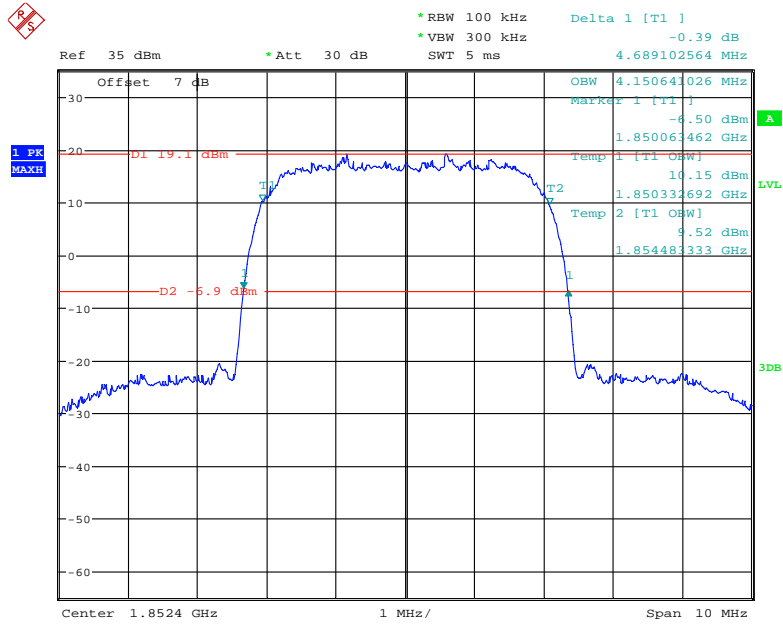

Date: 19.JUL.2021 23:20:28

26 dB Emissions & 99% Occupied Bandwidth for RMC (BPSK) Mode, Middle channel

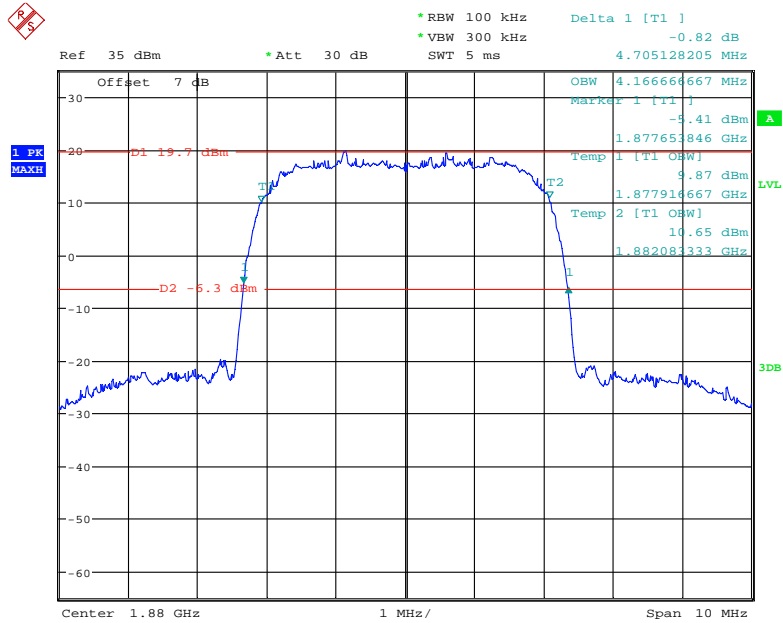

Date: 19.JUL.2021 23:23:33

26 dB Emissions & 99% Occupied Bandwidth for RMC (BPSK) Mode, High channel

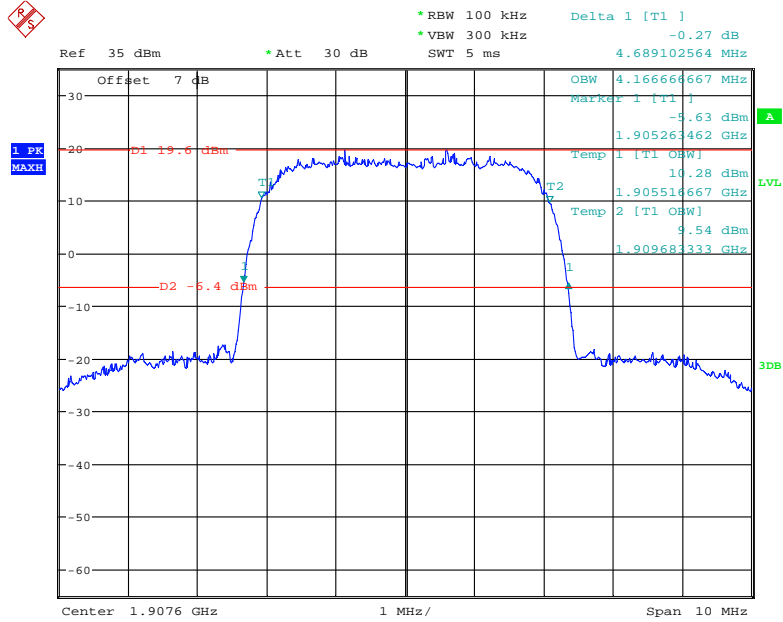

Date: 19.JUL.2021 23:24:47

26 dB Emissions & 99% Occupied Bandwidth for HSUPA (BPSK) Mode, Low channel

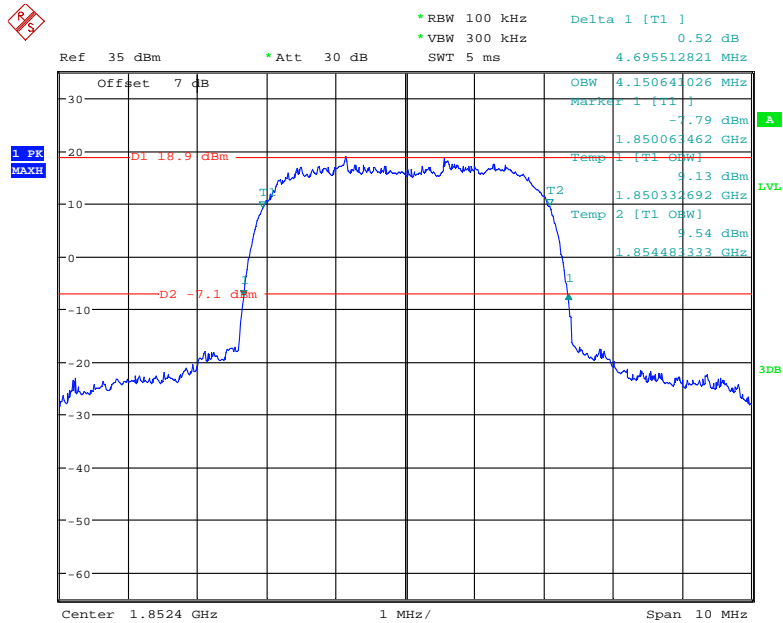

Date: 20.JUL.2021 00:14:47

26 dB Emissions & 99% Occupied Bandwidth for HSUPA (BPSK) Mode, Middle channel

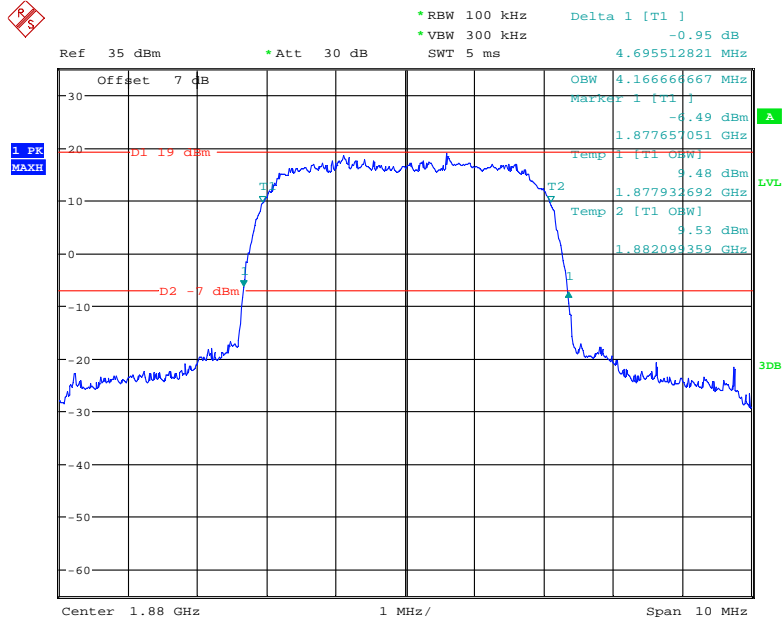

Date: 20.JUL.2021 00:13:10

26 dB Emissions & 99% Occupied Bandwidth for HSUPA (BPSK) Mode, High channel

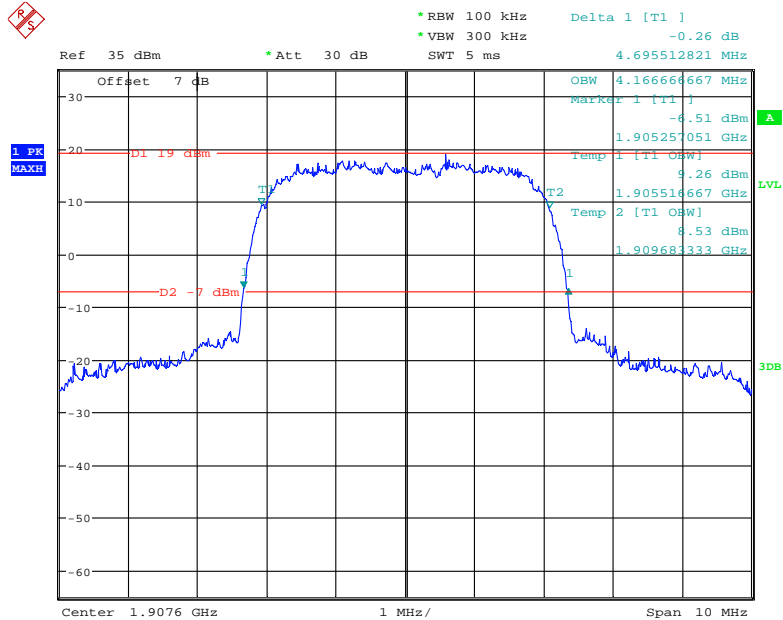

Date: 20.JUL.2021 00:11:44

26 dB Emissions & 99% Occupied Bandwidth for HSDPA (16QAM) Mode, Low channel

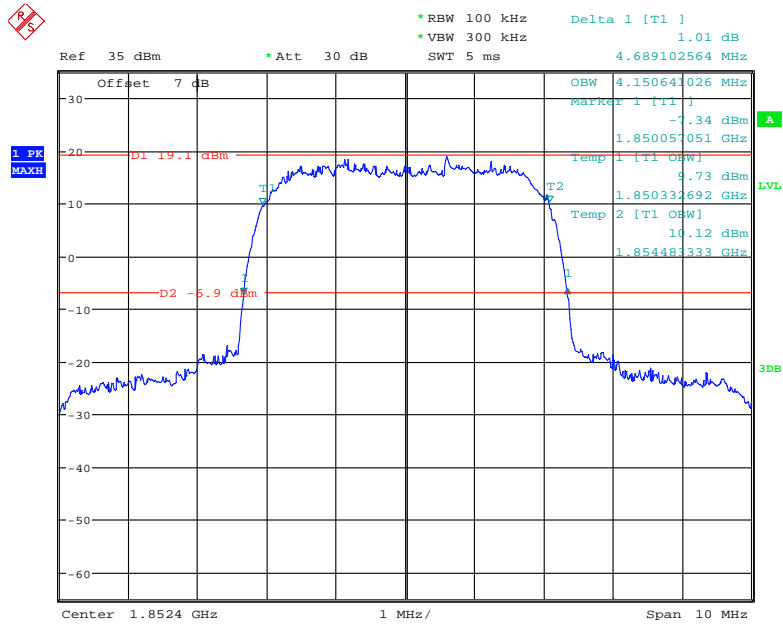

Date: 19.JUL.2021 23:19:15

26 dB Emissions & 99% Occupied Bandwidth for HSDPA (16QAM) Mode, Middle channel

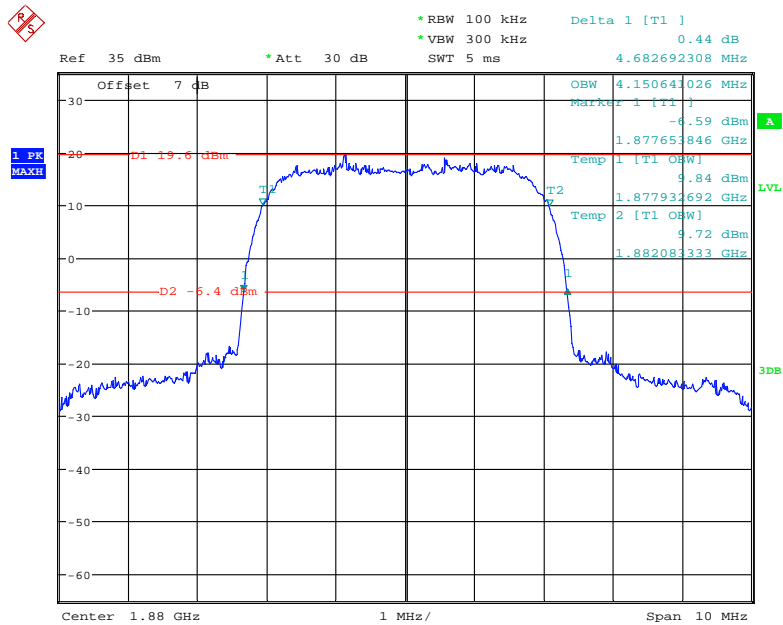

Date: 19.JUL.2021 23:17:47

26 dB Emissions & 99% Occupied Bandwidth for HSDPA (16QAM) Mode, High channel

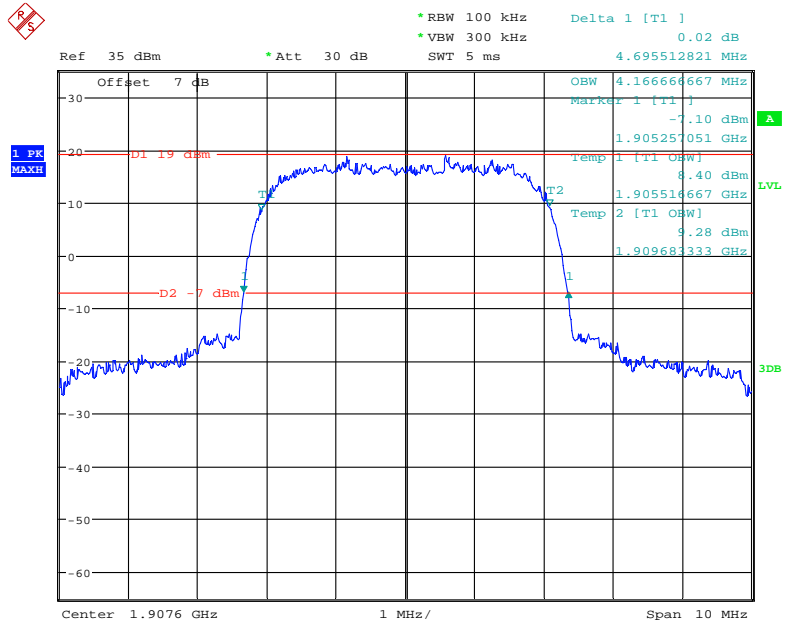

Date: 19.JUL.2021 23:16:29

AWS Band (Part 27)

26 dB Emissions & 99% Occupied Bandwidth for RMC (BPSK) Mode, Low channel

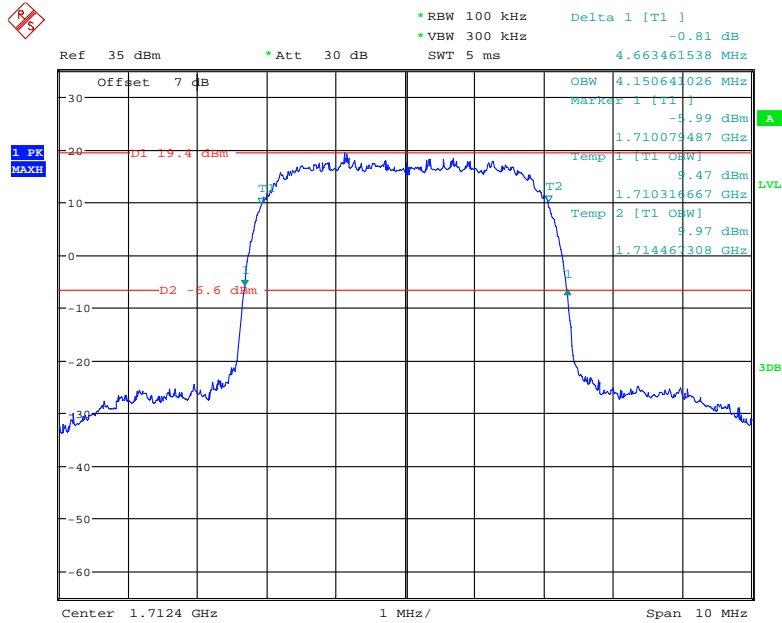

Date: 19.JUL.2021 23:50:35

26 dB Emissions & 99% Occupied Bandwidth for RMC (BPSK) Mode, Middle channel

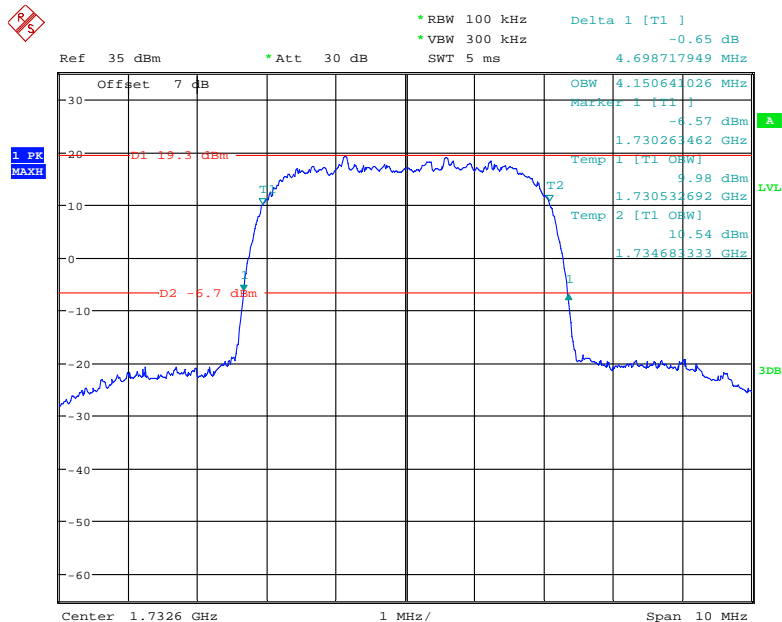

Date: 19.JUL.2021 23:52:11

26 dB Emissions & 99% Occupied Bandwidth for RMC (BPSK) Mode, High channel

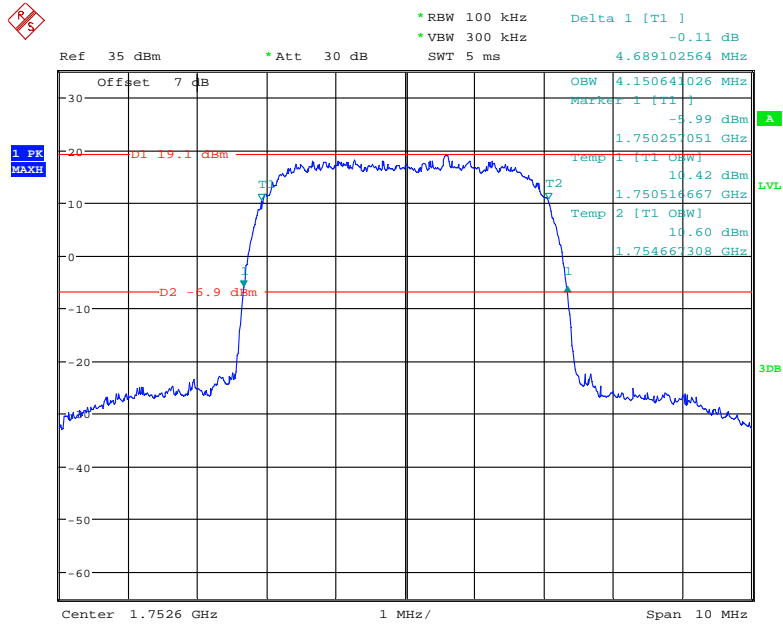

Date: 19.JUL.2021 23:53:13

26 dB Emissions & 99% Occupied Bandwidth for HSUPA (BPSK) Mode, Low channel

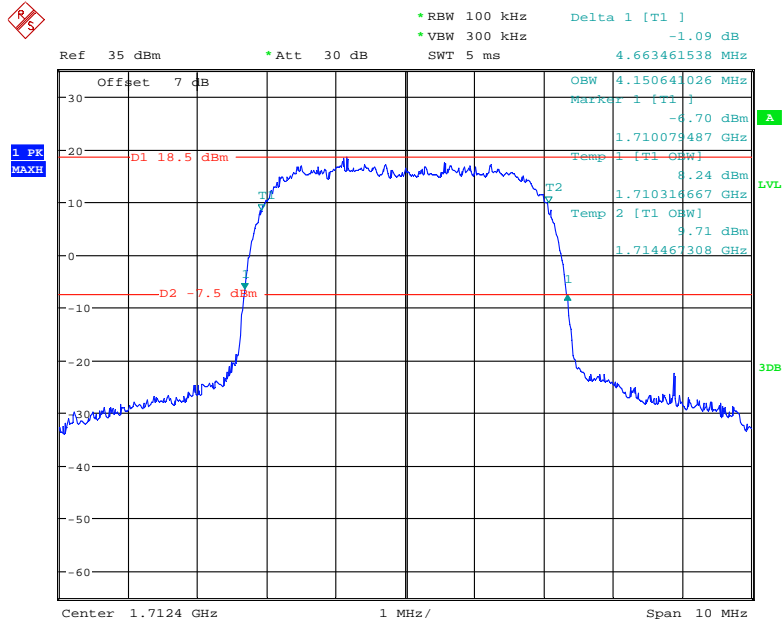

Date: 20.JUL.2021 00:09:46

26 dB Emissions & 99% Occupied Bandwidth for HSUPA (BPSK) Mode, Middle channel

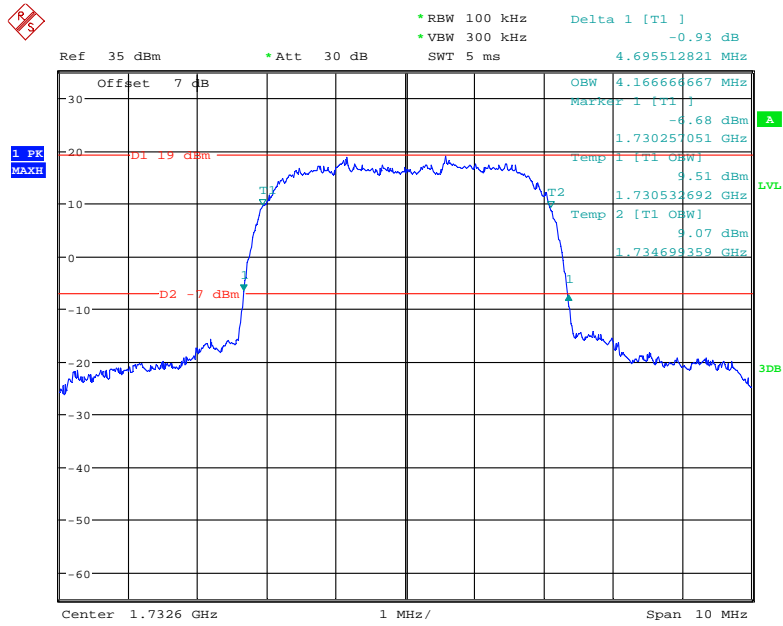

Date: 20.JUL.2021 00:07:43

26 dB Emissions & 99% Occupied Bandwidth for HSUPA (BPSK) Mode, High channel

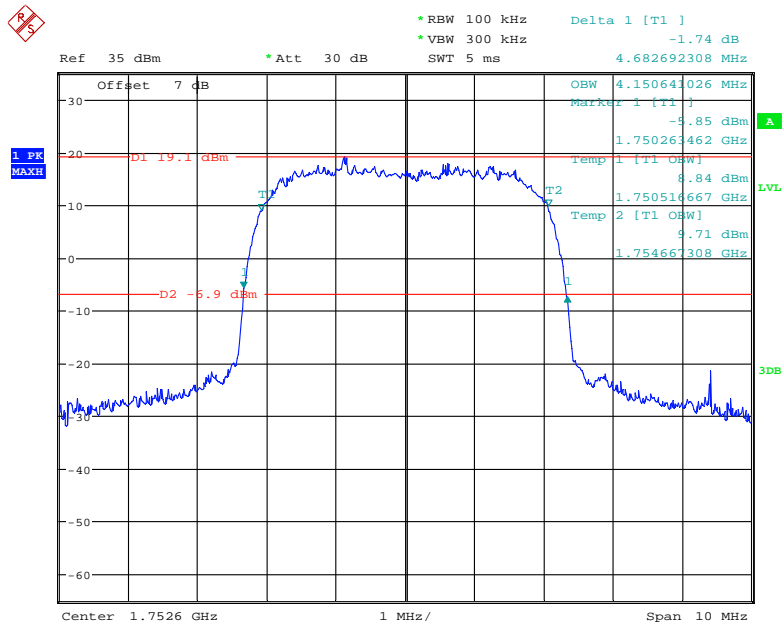

Date: 20.JUL.2021 00:05:39

26 dB Emissions & 99% Occupied Bandwidth for HSDPA (16QAM) Mode, Low channel

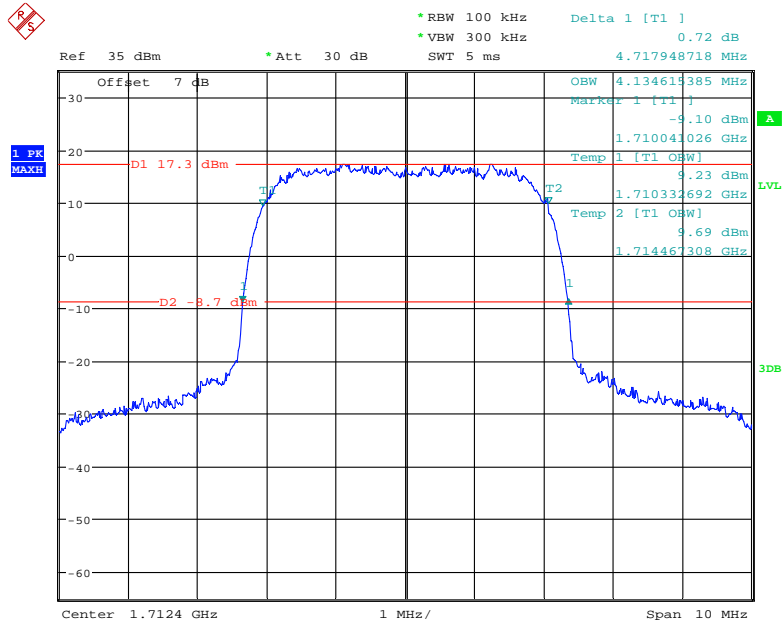

Date: 19.JUL.2021 23:13:40

26 dB Emissions & 99% Occupied Bandwidth for HSDPA (16QAM) Mode, Middle channel

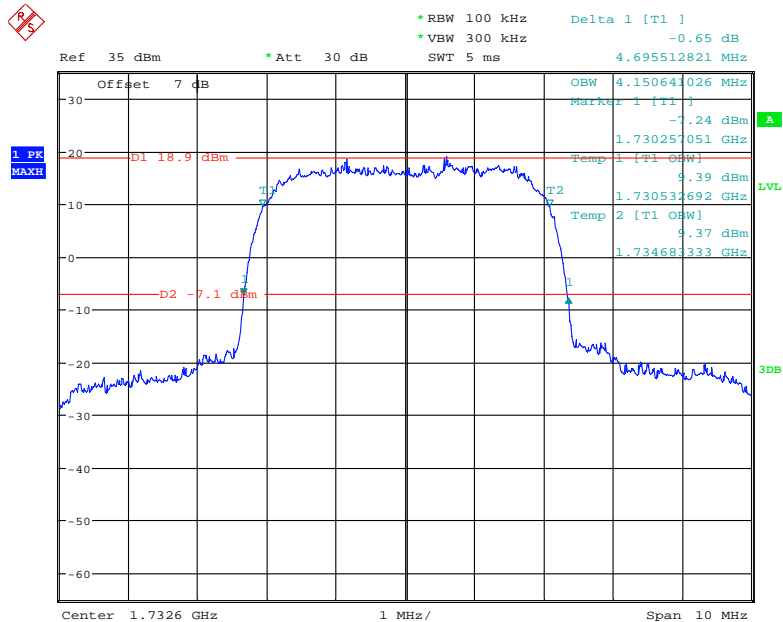

Date: 19.JUL.2021 23:11:45

26 dB Emissions & 99% Occupied Bandwidth for HSDPA (16QAM) Mode, High channel

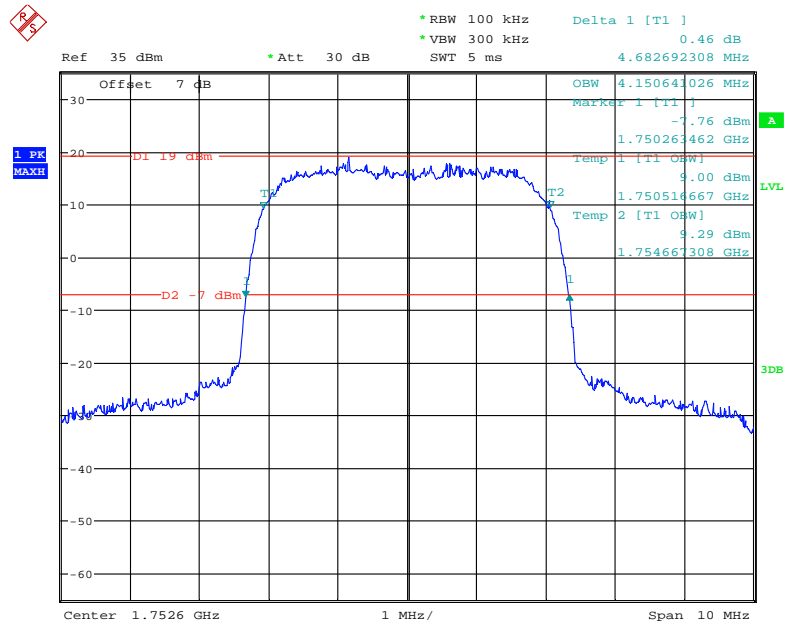

Date: 19.JUL.2021 23:10:21

LTE Band 2:

Bandwidth (MHz)	Modulation	Channel	99% Occupied Bandwidth (MHz)	26 dB Emission Bandwidth (MHz)
1.4	QPSK	Low	1.110	1.260
		Middle	1.104	1.260
		High	1.110	1.284
	16QAM	Low	1.116	1.266
		Middle	1.098	1.260
		High	1.110	1.278
3	QPSK	Low	2.700	3.000
		Middle	2.700	3.012
		High	2.700	3.048
	16QAM	Low	2.688	3.012
		Middle	2.688	3.012
		High	2.700	3.048
5	QPSK	Low	4.520	5.000
		Middle	4.520	5.020
		High	4.520	5.020
	16QAM	Low	4.520	5.000
		Middle	4.540	5.040
		High	4.540	5.040
10	QPSK	Low	8.960	9.840
		Middle	8.960	9.800
		High	9.000	9.720
	16QAM	Low	8.960	9.760
		Middle	8.960	9.840
		High	8.960	9.840
15	QPSK	Low	13.560	15.180
		Middle	13.560	15.060
		High	13.620	15.240
	16QAM	Low	13.500	15.000
		Middle	13.560	15.180
		High	13.560	15.060
20	QPSK	Low	18.000	19.600
		Middle	18.080	19.680
		High	18.080	19.920
	16QAM	Low	18.000	19.600
		Middle	18.000	19.840
		High	18.080	19.840

LTE Band 4:

Bandwidth (MHz)	Modulation	Channel	99% Occupied Bandwidth (MHz)	26 dB Emission Bandwidth (MHz)
1.4	QPSK	Low	1.104	1.260
		Middle	1.104	1.260
		High	1.104	1.260
	16QAM	Low	1.110	1.266
		Middle	1.098	1.260
		High	1.110	1.254
3	QPSK	Low	2.712	3.012
		Middle	2.700	2.988
		High	2.700	3.024
	16QAM	Low	2.700	3.024
		Middle	2.700	3.000
		High	2.700	3.024
5	QPSK	Low	4.520	4.960
		Middle	4.540	5.020
		High	4.520	4.860
	16QAM	Low	4.520	4.980
		Middle	4.540	5.020
		High	4.520	5.080
10	QPSK	Low	8.960	9.800
		Middle	8.960	9.720
		High	8.960	9.760
	16QAM	Low	8.960	9.840
		Middle	9.000	9.800
		High	8.960	9.760
15	QPSK	Low	13.620	15.120
		Middle	13.560	14.940
		High	13.560	15.060
	16QAM	Low	13.620	15.120
		Middle	13.560	15.000
		High	13.560	15.060
20	QPSK	Low	18.000	19.600
		Middle	18.000	19.520
		High	18.080	19.840
	16QAM	Low	18.000	19.680
		Middle	18.000	19.920
		High	18.000	19.760

LTE Band 5:

Bandwidth (MHz)	Modulation	Channel	99% Occupied Bandwidth (MHz)	26 dB Emission Bandwidth (MHz)
1.4	QPSK	Low	1.110	1.272
		Middle	1.104	1.272
		High	1.110	1.266
	16QAM	Low	1.116	1.266
		Middle	1.098	1.254
		High	1.110	1.254
3	QPSK	Low	2.712	3.012
		Middle	2.700	3.000
		High	2.712	3.048
	16QAM	Low	2.700	3.024
		Middle	2.700	2.988
		High	2.700	3.024
5	QPSK	Low	4.540	5.000
		Middle	4.520	5.000
		High	4.520	5.000
	16QAM	Low	4.520	5.000
		Middle	4.520	5.000
		High	4.560	5.040
10	QPSK	Low	8.960	9.800
		Middle	9.000	9.760
		High	8.960	9.760
	16QAM	Low	8.960	9.800
		Middle	8.960	9.720
		High	8.960	9.760

LTE Band 7:

Bandwidth (MHz)	Modulation	Channel	99% Occupied Bandwidth (MHz)	26 dB Emission Bandwidth (MHz)
5	QPSK	Low	4.540	5.000
		Middle	4.520	5.020
		High	4.520	5.000
	16QAM	Low	4.540	5.000
		Middle	4.540	5.020
		High	4.560	5.040
10	QPSK	Low	9.000	9.800
		Middle	9.039	9.840
		High	9.000	9.840
	16QAM	Low	9.000	9.840
		Middle	8.960	9.840
		High	8.960	9.840
15	QPSK	Low	13.500	14.520
		Middle	13.560	15.180
		High	13.620	15.360
	16QAM	Low	13.560	15.060
		Middle	13.620	15.060
		High	13.620	15.120
20	QPSK	Low	18.080	19.760
		Middle	18.000	19.680
		High	18.160	20.000
	16QAM	Low	18.080	19.760
		Middle	18.000	19.920
		High	18.080	19.840

LTE Band 12

Bandwidth (MHz)	Modulation	Channel	99% Occupied Bandwidth (MHz)	26 dB Emission Bandwidth (MHz)
1.4	QPSK	Low	1.104	1.254
		Middle	1.104	1.260
		High	1.098	1.254
	16QAM	Low	1.110	1.260
		Middle	1.098	1.254
		High	1.104	1.254
3	QPSK	Low	2.712	3.000
		Middle	2.700	3.012
		High	2.700	3.012
	16QAM	Low	2.700	3.000
		Middle	2.688	3.000
		High	2.712	3.036
5	QPSK	Low	4.560	4.980
		Middle	4.520	5.000
		High	4.520	4.980
	16QAM	Low	4.520	5.000
		Middle	4.520	4.960
		High	4.540	5.000
10	QPSK	Low	9.000	9.840
		Middle	9.000	9.680
		High	8.960	9.720
	16QAM	Low	9.000	9.840
		Middle	8.960	9.760
		High	9.000	9.720

LTE Band 17

Bandwidth (MHz)	Modulation	Channel	99% Occupied Bandwidth (MHz)	26 dB Emission Bandwidth (MHz)
5	QPSK	Low	4.540	5.000
		Middle	4.520	4.980
		High	4.520	5.000
	16QAM	Low	4.520	4.960
		Middle	4.540	5.020
		High	4.540	5.020
10	QPSK	Low	8.960	9.720
		Middle	8.960	9.720
		High	8.960	9.720
	16QAM	Low	8.960	9.640
		Middle	8.960	9.720
		High	8.960	9.800

LTE Band 66:

Bandwidth (MHz)	Modulation	Channel	99% Occupied Bandwidth (MHz)	26 dB Emission Bandwidth (MHz)
1.4	QPSK	Low	1.110	1.260
		Middle	1.104	1.266
		High	1.110	1.260
	16QAM	Low	1.110	1.254
		Middle	1.104	1.254
		High	1.104	1.248
3	QPSK	Low	2.700	3.000
		Middle	2.712	3.000
		High	2.700	3.012
	16QAM	Low	2.700	2.988
		Middle	2.700	3.012
		High	2.700	3.012
5	QPSK	Low	4.520	5.000
		Middle	4.520	5.000
		High	4.500	4.980
	16QAM	Low	4.520	4.980
		Middle	4.540	4.980
		High	4.520	5.000
10	QPSK	Low	8.960	9.800
		Middle	8.960	9.720
		High	8.960	9.800
	16QAM	Low	8.960	9.720
		Middle	8.960	9.760
		High	8.960	9.720
15	QPSK	Low	13.620	15.060
		Middle	13.560	15.000
		High	13.560	15.060
	16QAM	Low	13.620	15.120
		Middle	13.560	15.120
		High	13.500	15.120
20	QPSK	Low	18.000	19.600
		Middle	18.000	19.440
		High	18.000	19.680
	16QAM	Low	18.080	19.760
		Middle	18.080	19.680
		High	18.000	19.600

The test plots of LTE band please refer to the Appendix A.

FCC §2.1051, §22.917(a) & §24.238(a); §27.53 - SPURIOUS EMISSIONS AT ANTENNA TERMINALS

Applicable Standard

FCC §2.1051, §22.917(a) and §24.238(a) and §27.53.

The spectrum was to be investigated to the tenth harmonics of the highest fundamental frequency as specified in § 2.1051.

Test Procedure

The RF output of the transceiver was connected to a spectrum analyzer and simulator through appropriate attenuation. The resolution bandwidth of the spectrum analyzer was set at 1MHz. Sufficient scans were taken to show any out of band emissions up to 10th harmonic.

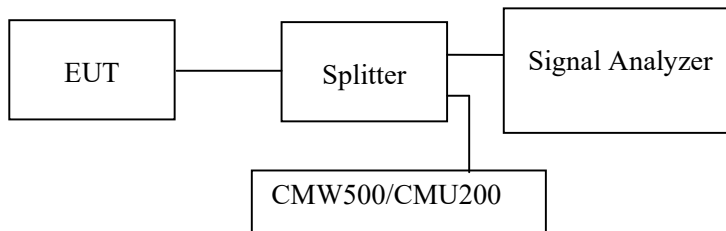

Test Data

Environmental Conditions

Temperature:	25 °C
Relative Humidity:	55 ~62 %
ATM Pressure:	101.0 kPa

The testing was performed by Orlo Yang from 2021-07-18 to 2021-07-20.

EUT operation mode: Transmitting

Test result: Pass

Please refer to the following plots.

**Cellular Band (Part 22H)
Low Channel:**

30 MHz – 1 GHz (GSM Mode)

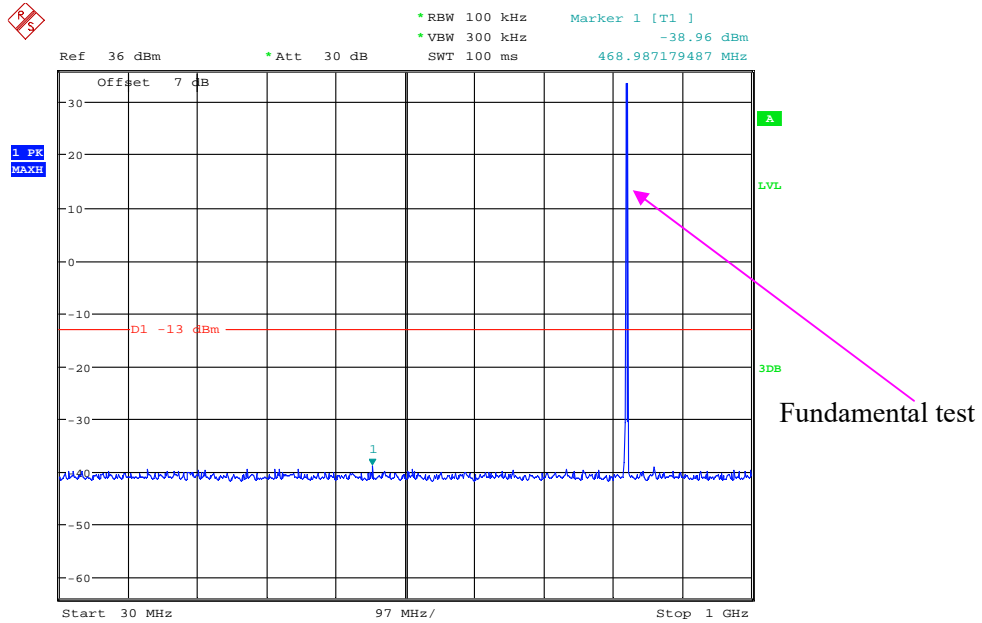

Date: 20.JUL.2021 01:39:45

1 GHz – 10 GHz (GSM Mode)

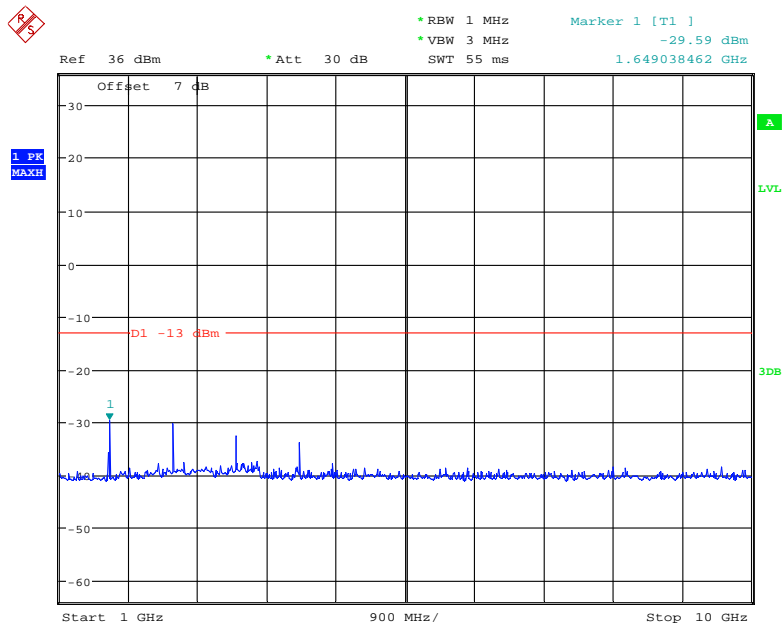

Date: 20.JUL.2021 01:43:55

30 MHz – 1 GHz (WCDMA Mode)

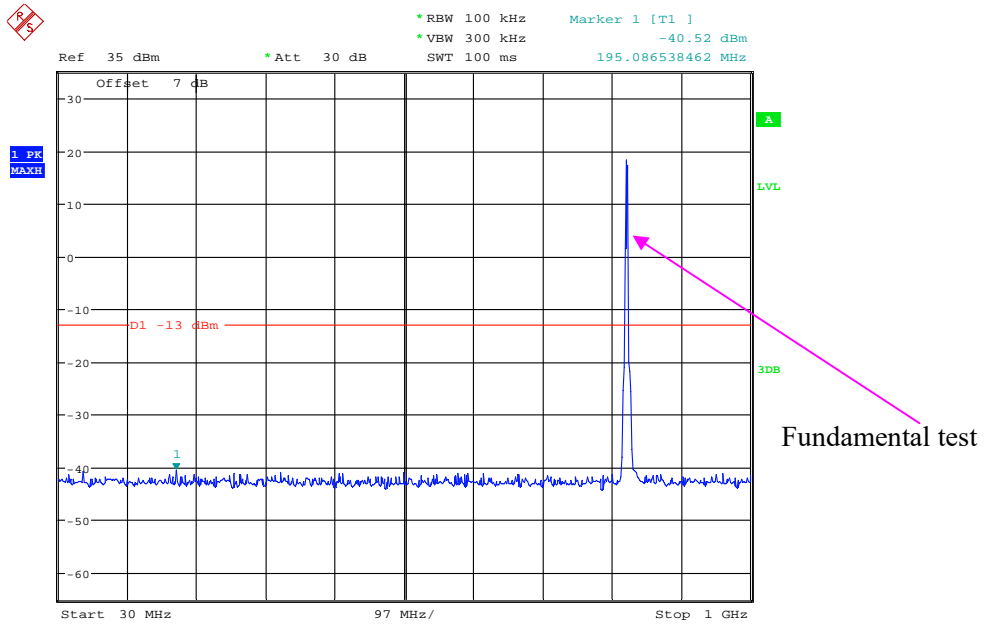

Date: 20.JUL.2021 00:25:20

1 GHz – 10 GHz (WCDMA Mode)

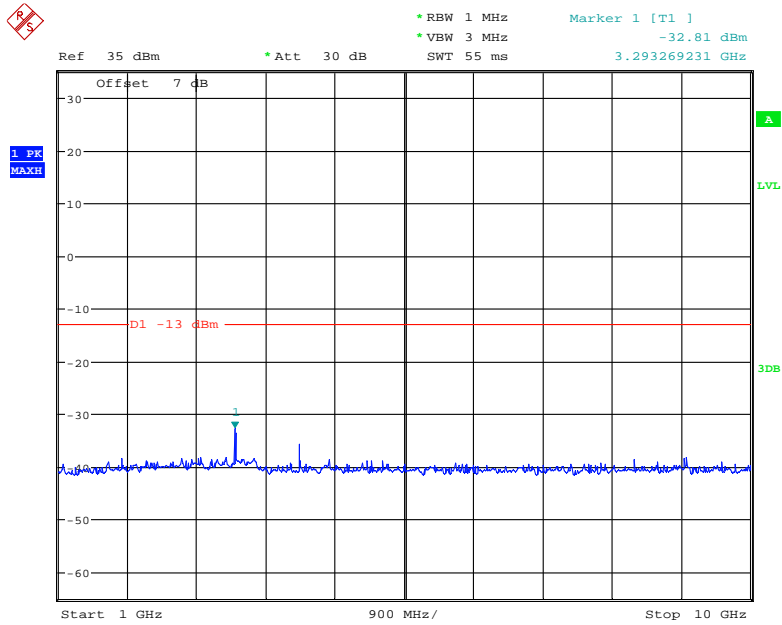

Date: 20.JUL.2021 00:30:23

Middle Channel:

30 MHz – 1 GHz (GSM Mode)

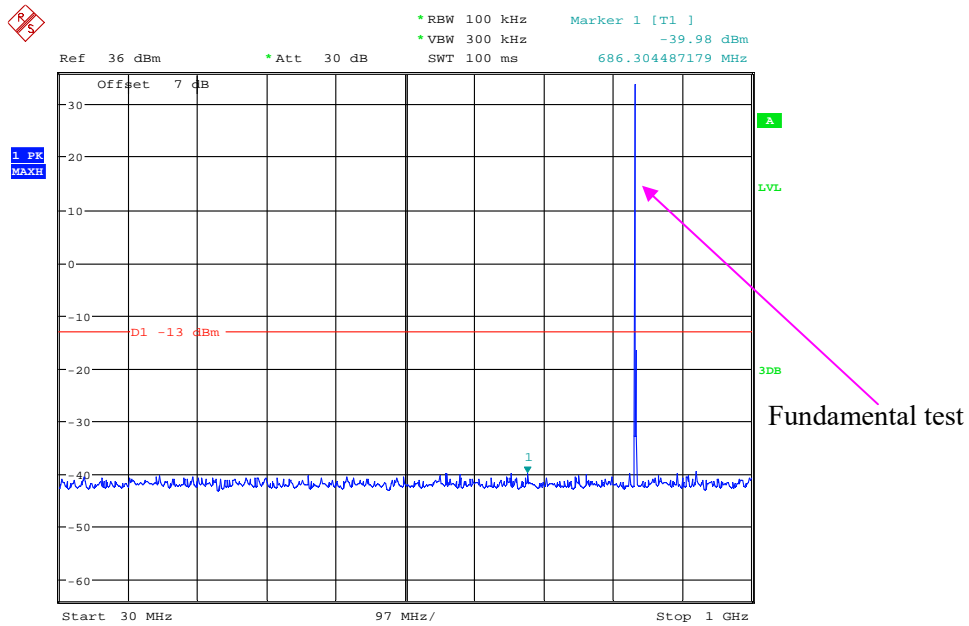

Date: 20.JUL.2021 01:40:53

1 GHz – 10 GHz (GSM Mode)

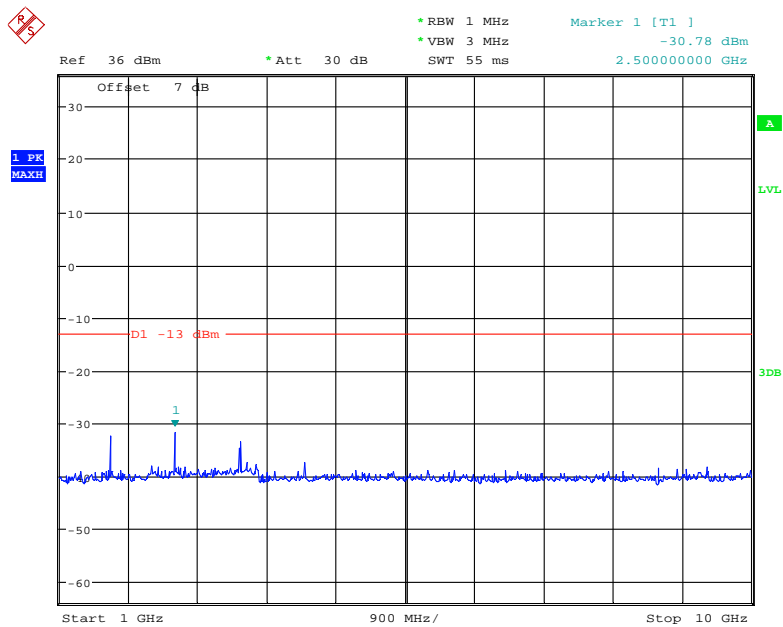

Date: 20.JUL.2021 01:43:36

30 MHz – 1 GHz (WCDMA Mode)

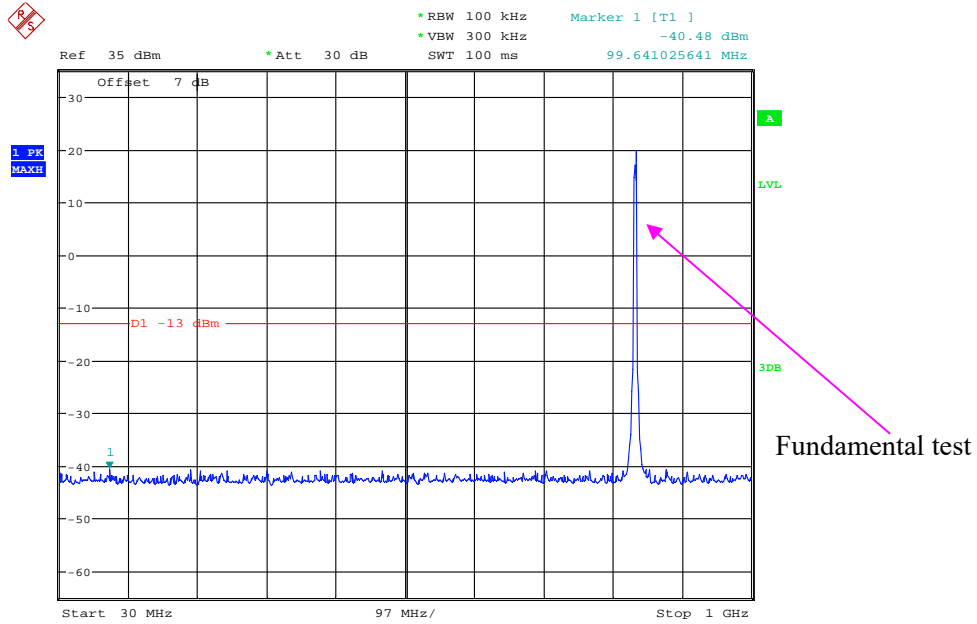

Date: 20.JUL.2021 00:26:43

1 GHz – 10 GHz (WCDMA Mode)

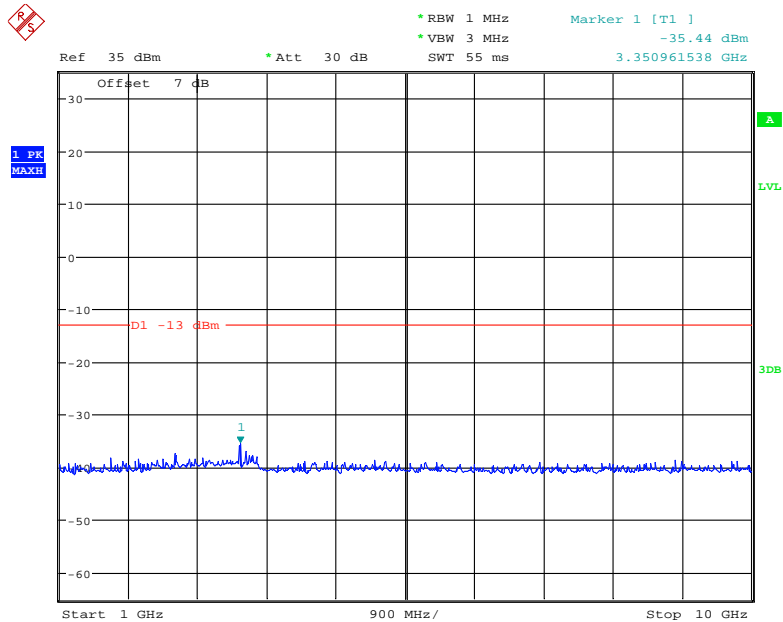

Date: 20.JUL.2021 00:29:27

High Channel:

30 MHz – 1 GHz (GSM Mode)

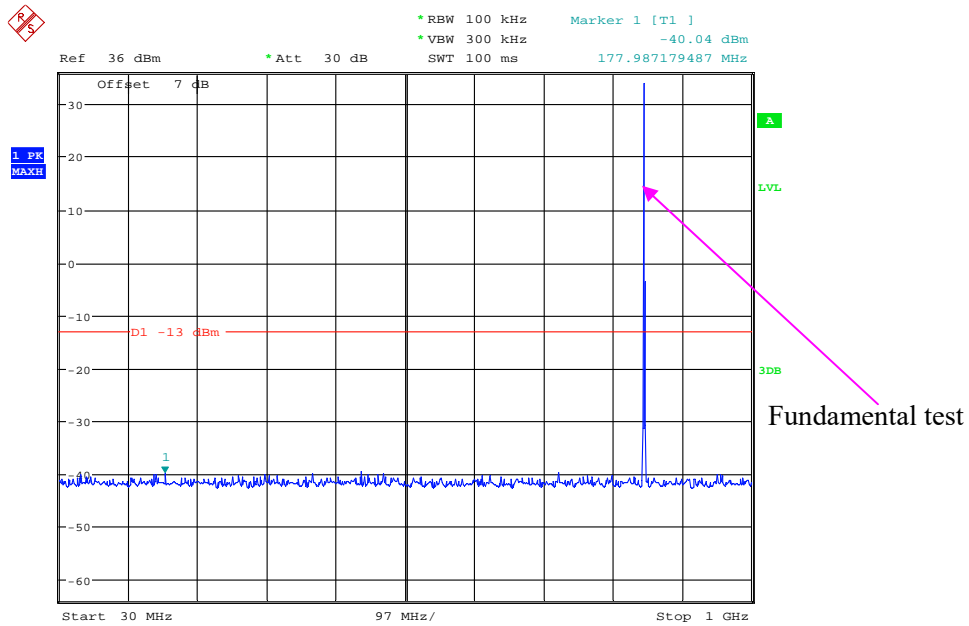

Date: 20.JUL.2021 01:41:34

1 GHz – 10 GHz (GSM Mode)

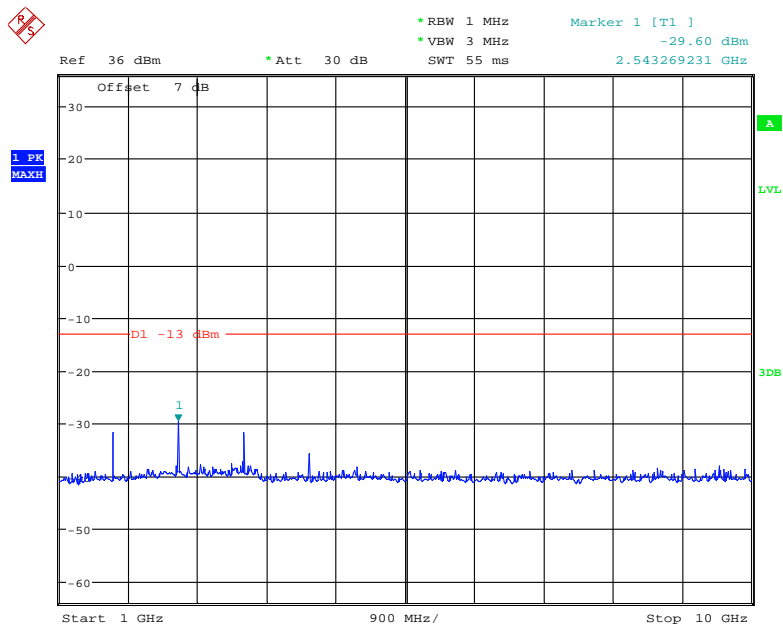

Date: 20.JUL.2021 01:43:03

30 MHz – 1 GHz (WCDMA Mode)

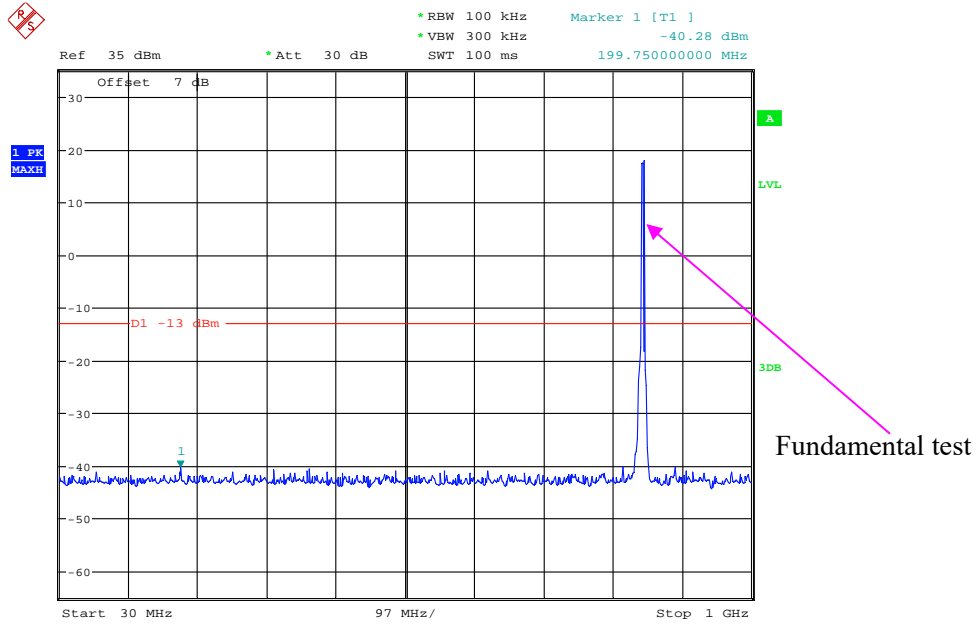

Date: 20.JUL.2021 00:27:24

1 GHz – 10 GHz (WCDMA Mode)

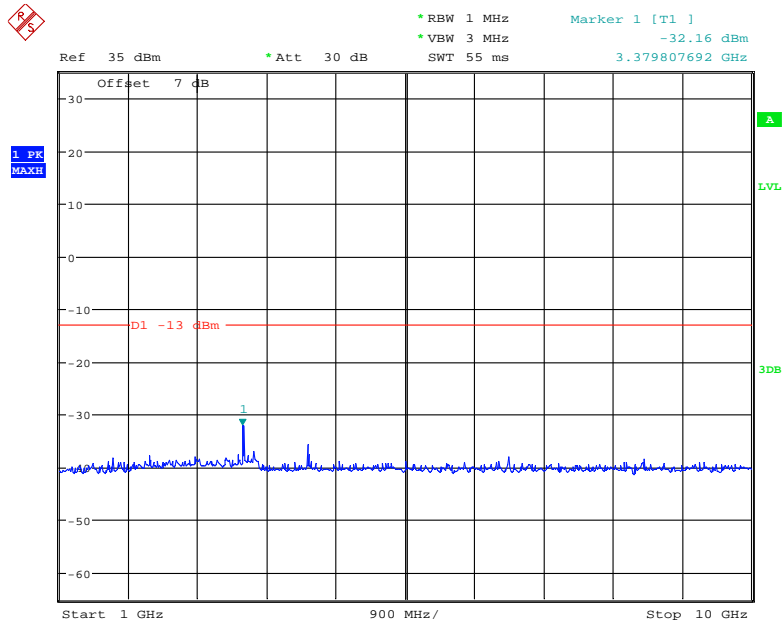

Date: 20.JUL.2021 00:28:34

PCS Band (Part 24E) Low Channel:

30 MHz – 1 GHz (GSM Mode)

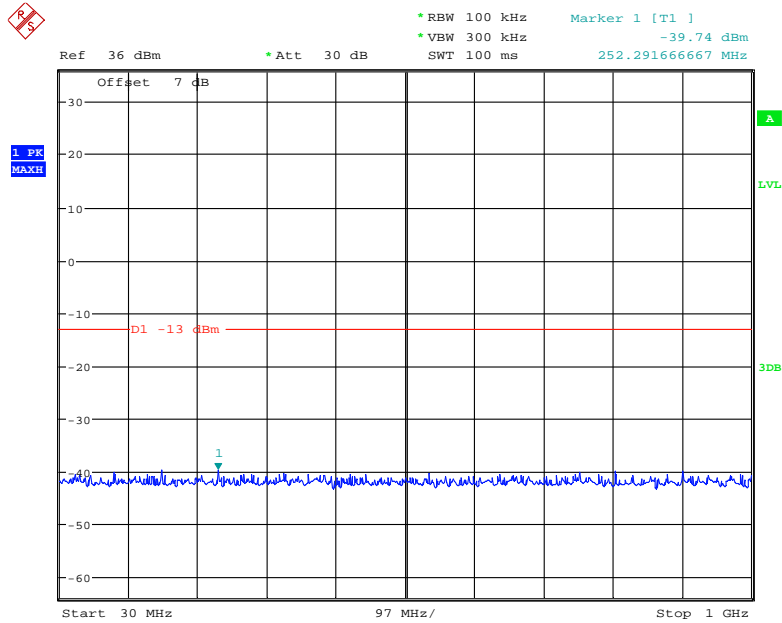

Date: 20.JUL.2021 01:47:22

1 GHz – 2 GHz (GSM Mode)

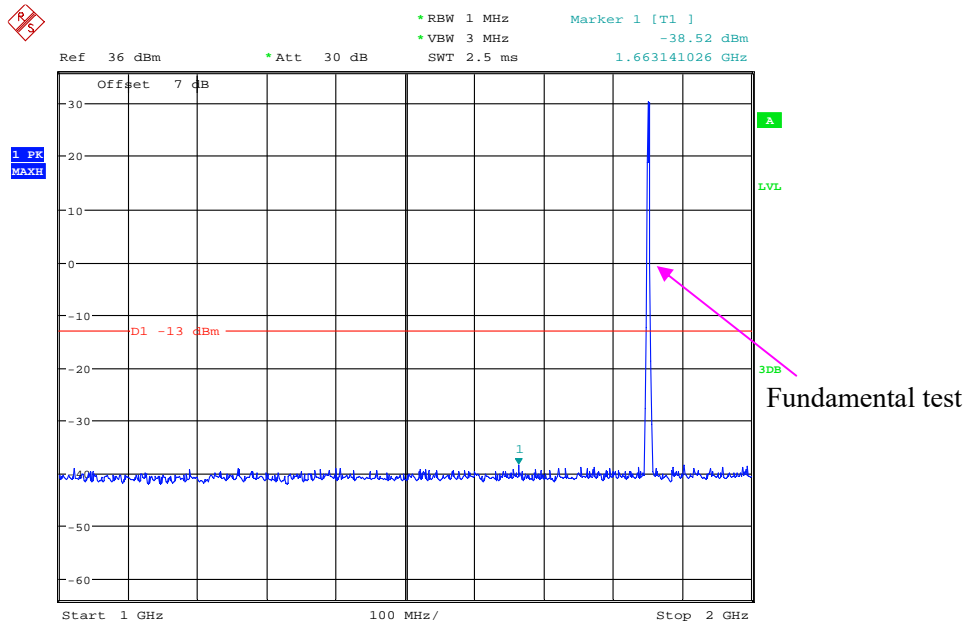

Date: 20.JUL.2021 01:54:19

2 GHz – 20 GHz (GSM Mode)

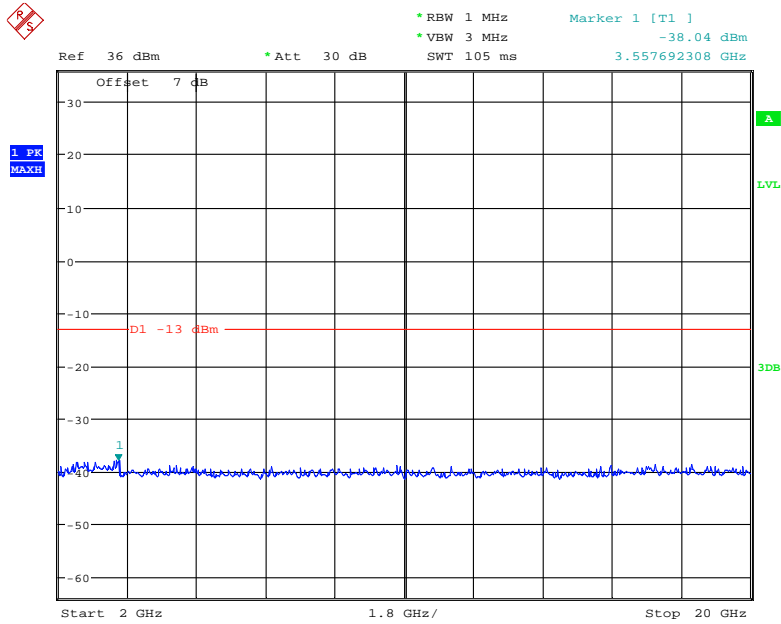

Date: 20.JUL.2021 01:52:49

30 MHz – 1 GHz (WCDMA Mode)

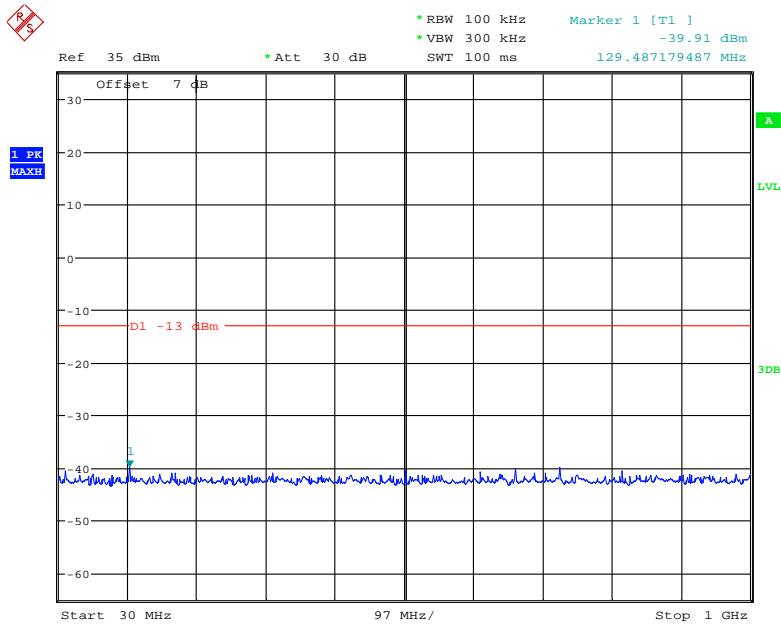

Date: 20.JUL.2021 00:19:28

1 GHz – 20 GHz (WCDMA Mode)

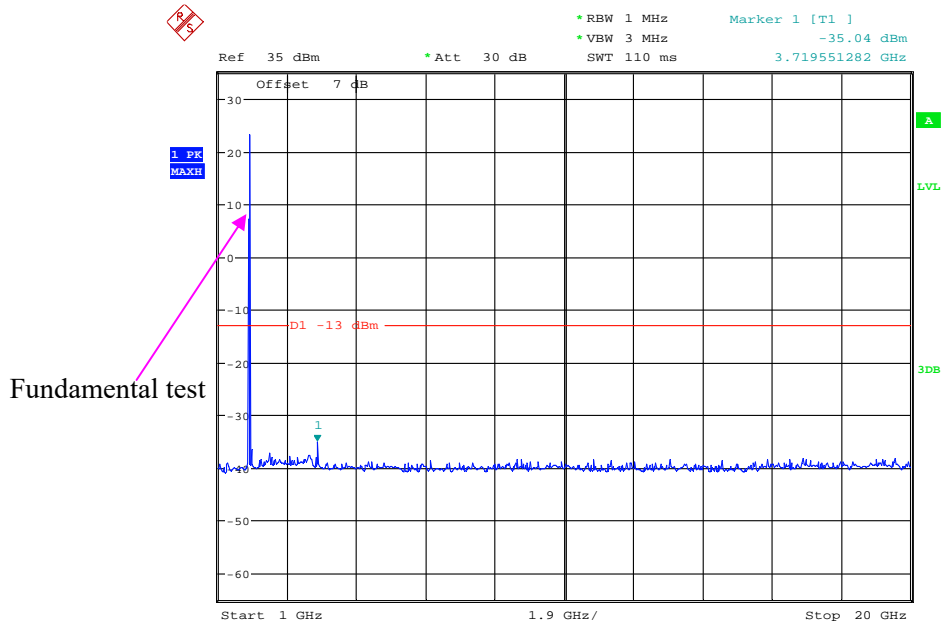

Date: 20.JUL.2021 00:35:48

Middle Channel:

30 MHz – 1 GHz (GSM Mode)

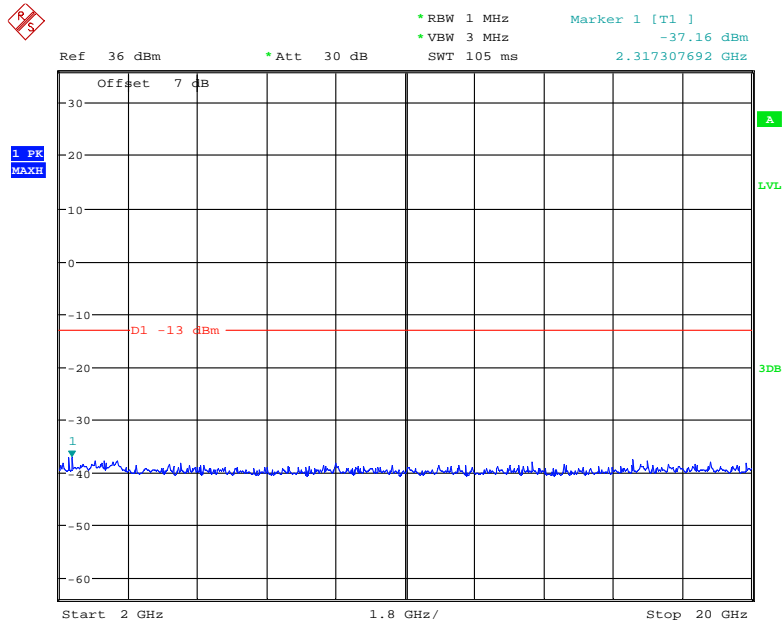

Date: 20.JUL.2021 01:51:27

1 GHz – 2 GHz (GSM Mode)

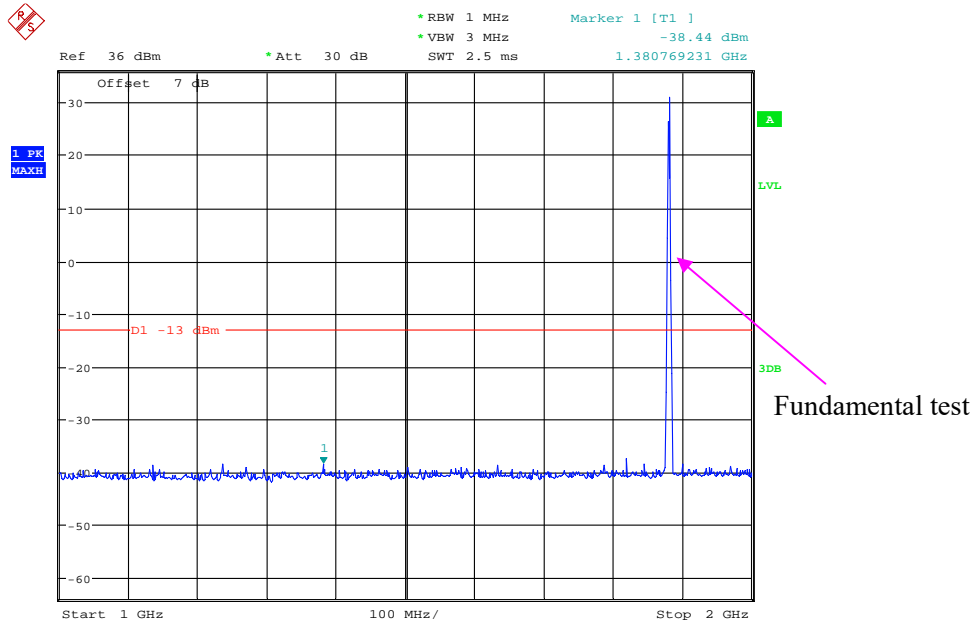

Date: 20.JUL.2021 01:53:51

2 GHz – 20 GHz (GSM Mode)

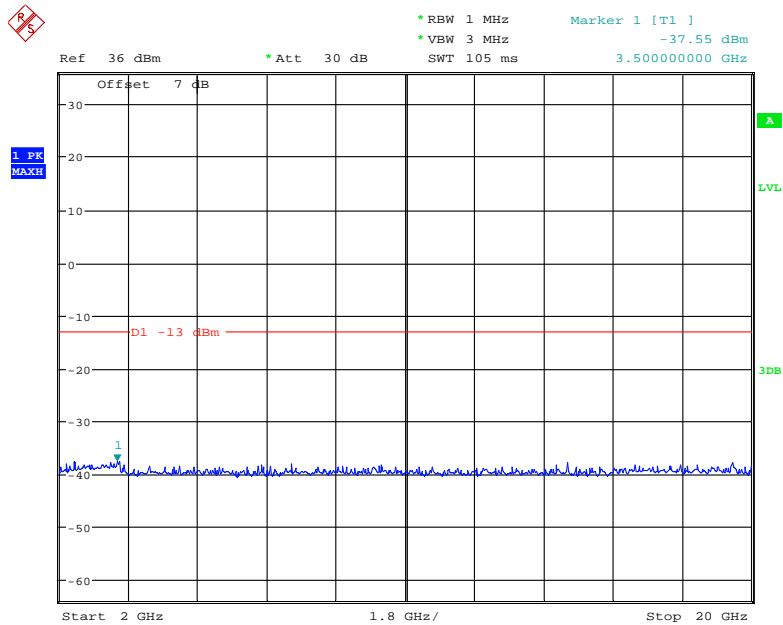

Date: 20.JUL.2021 01:52:20

30 MHz – 1 GHz (WCDMA Mode)

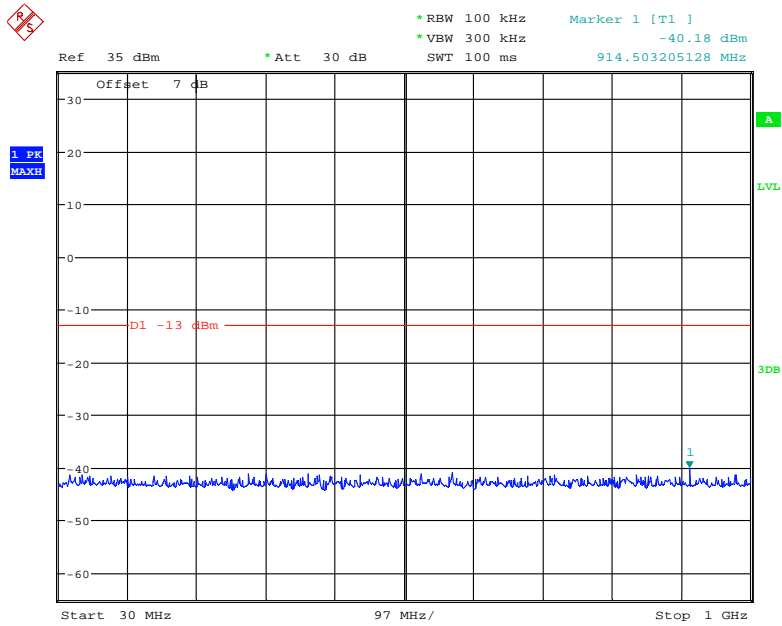

Date: 20.JUL.2021 00:20:19

1 GHz – 20 GHz (WCDMA Mode)

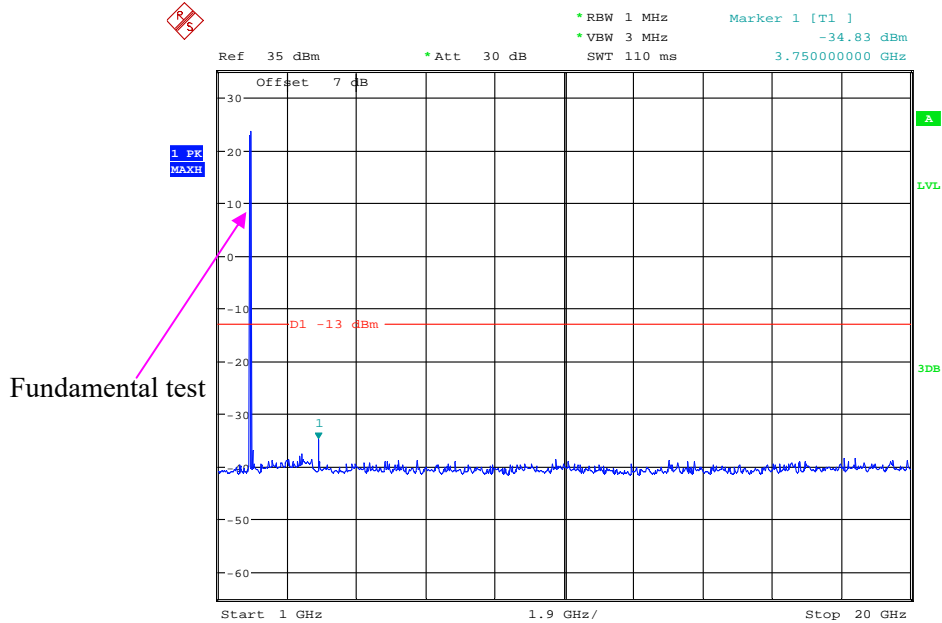

Date: 20.JUL.2021 00:34:46

High Channel:

30 MHz – 1 GHz (GSM Mode)

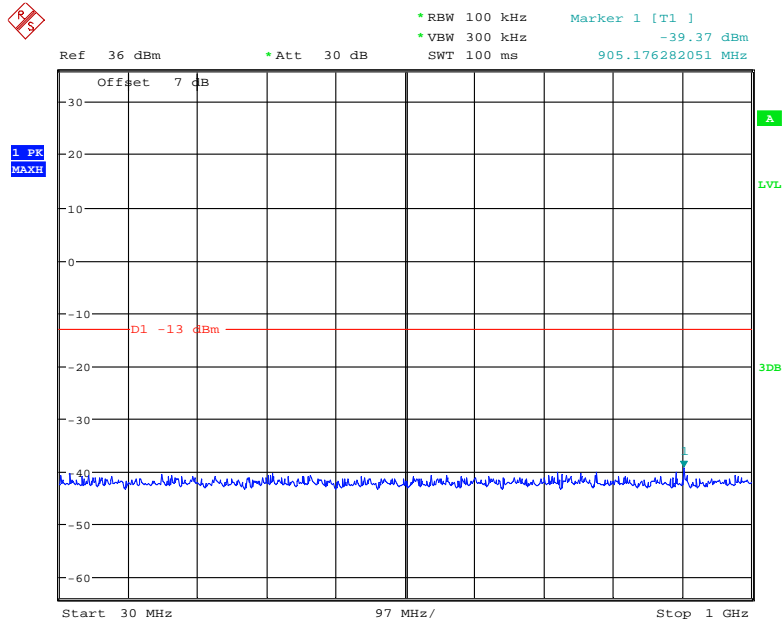

Date: 20.JUL.2021 01:48:24

1 GHz – 2 GHz (GSM Mode)

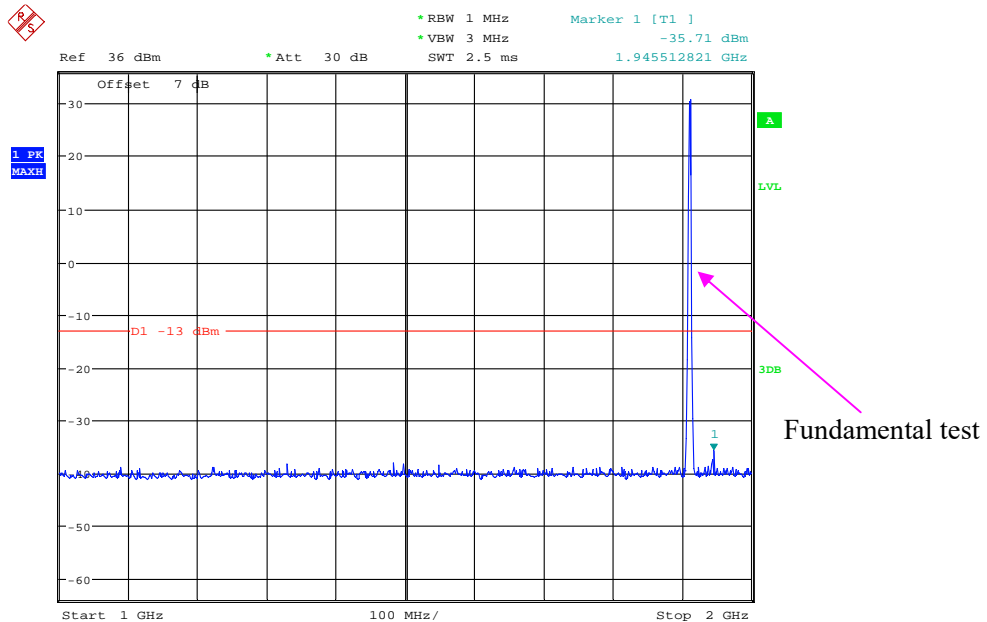

Date: 20.JUL.2021 01:49:28

2 GHz – 20 GHz (GSM Mode)

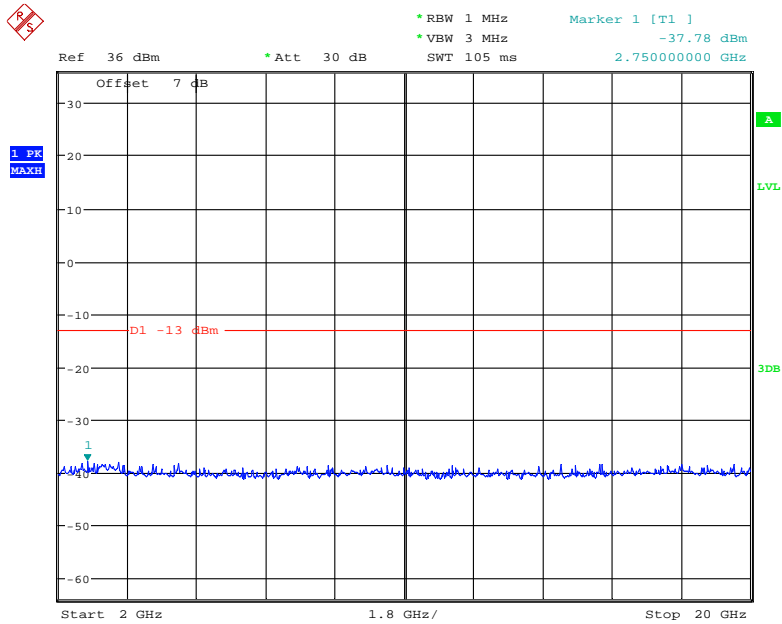

Date: 20.JUL.2021 01:53:08

30 MHz – 1 GHz (WCDMA Mode)

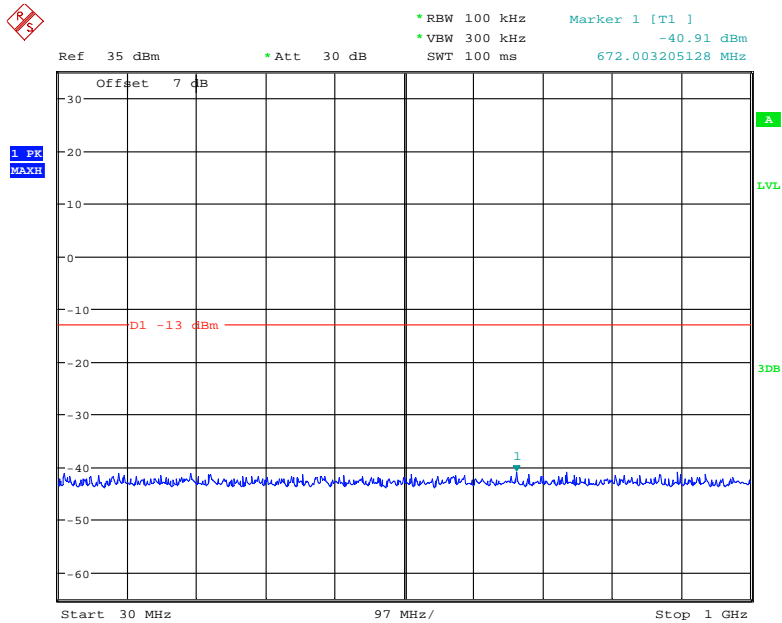

Date: 20.JUL.2021 00:21:23

1 GHz – 20 GHz (WCDMA Mode)

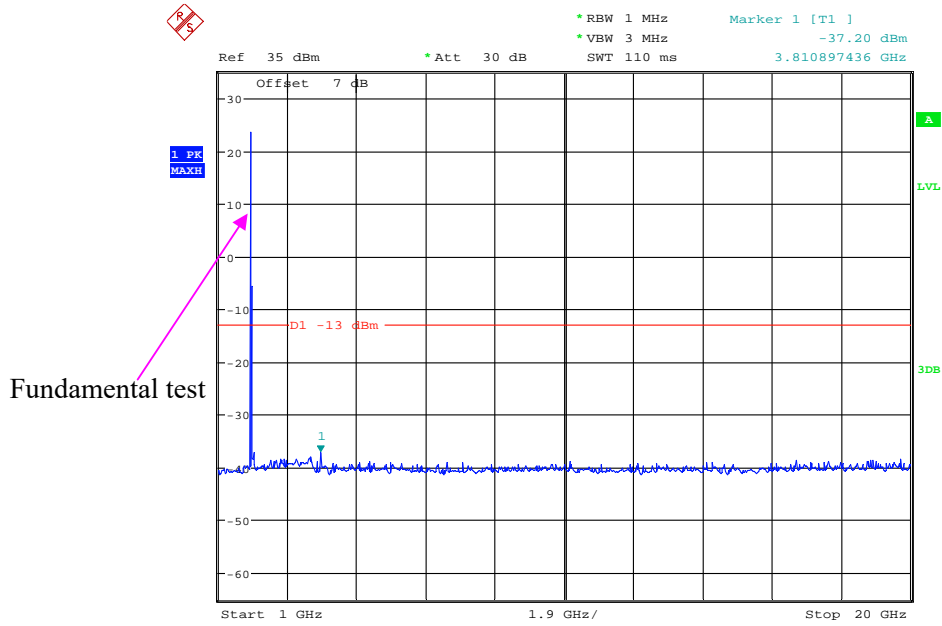

Date: 20.JUL.2021 00:34:13

**AWS Band (Part 27)
Low Channel:**

30 MHz – 1 GHz (WCDMA Mode)

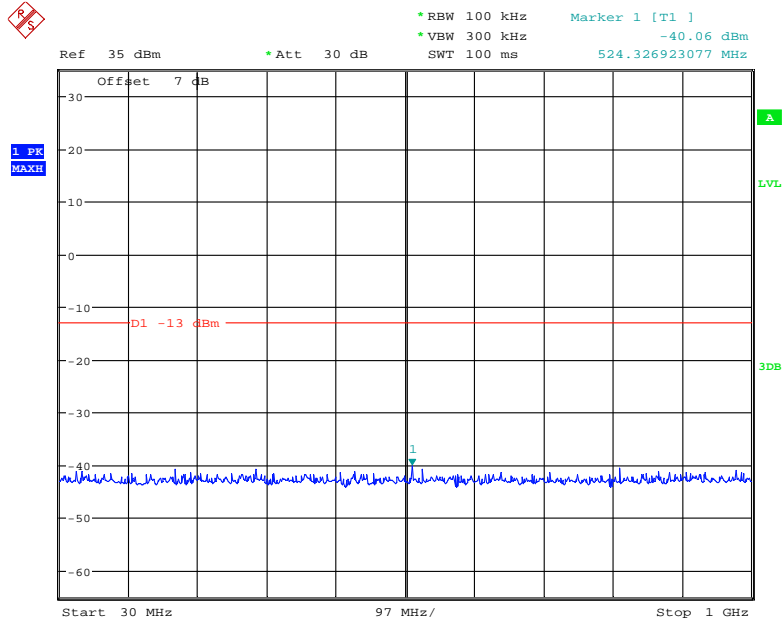

Date: 20.JUL.2021 00:22:02

1 GHz – 20 GHz (WCDMA Mode)

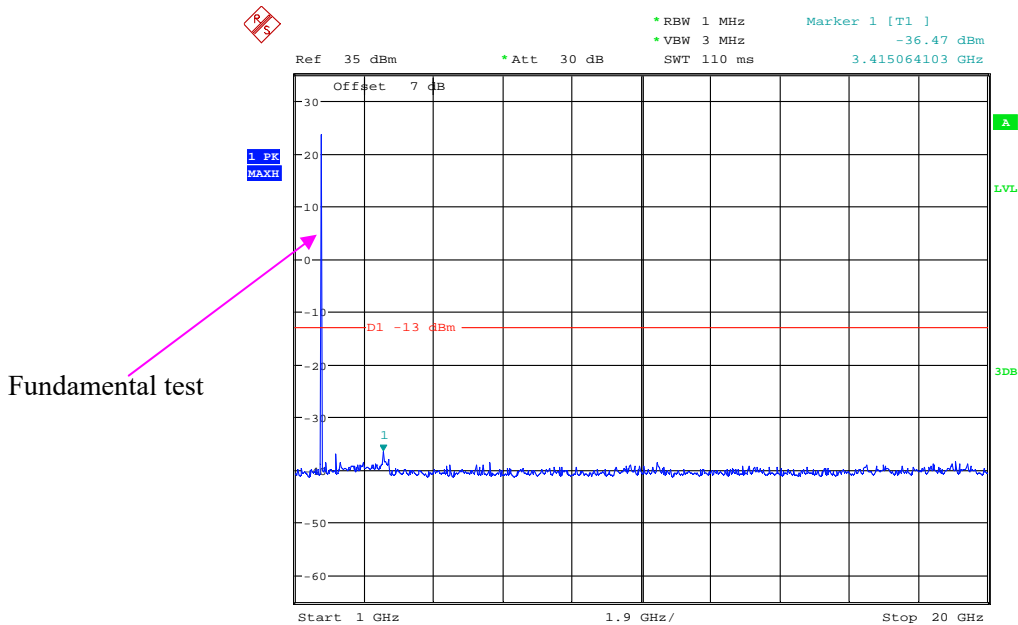

Date: 20.JUL.2021 00:32:53

Middle Channel

30 MHz – 1 GHz (WCDMA Mode)

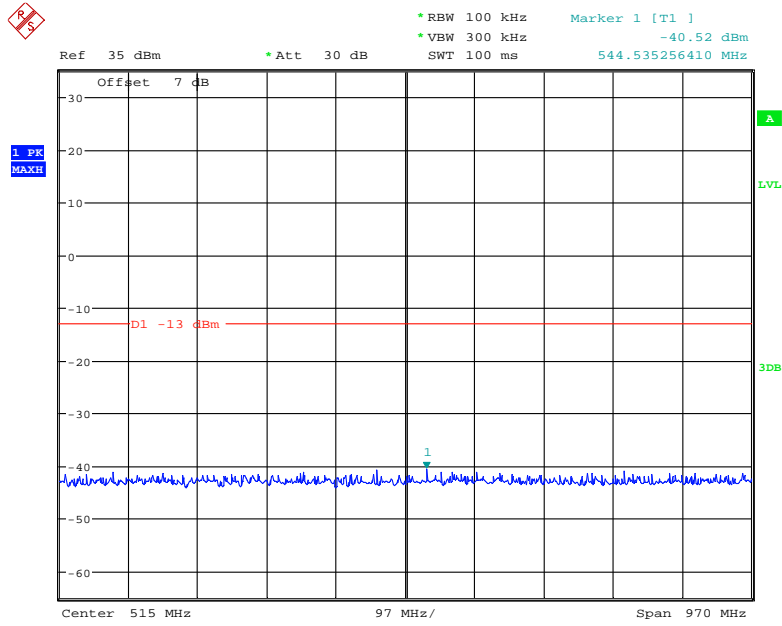

Date: 20.JUL.2021 00:22:58

1 GHz – 20 GHz (WCDMA Mode)

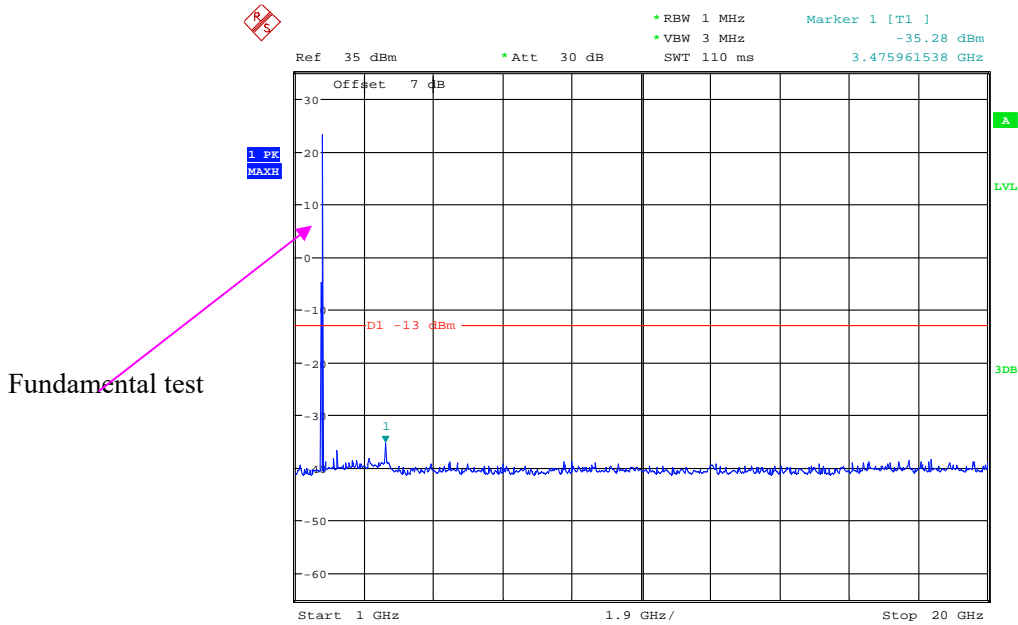

Date: 20.JUL.2021 00:32:17

High Channel:

30 MHz – 1 GHz (WCDMA Mode)

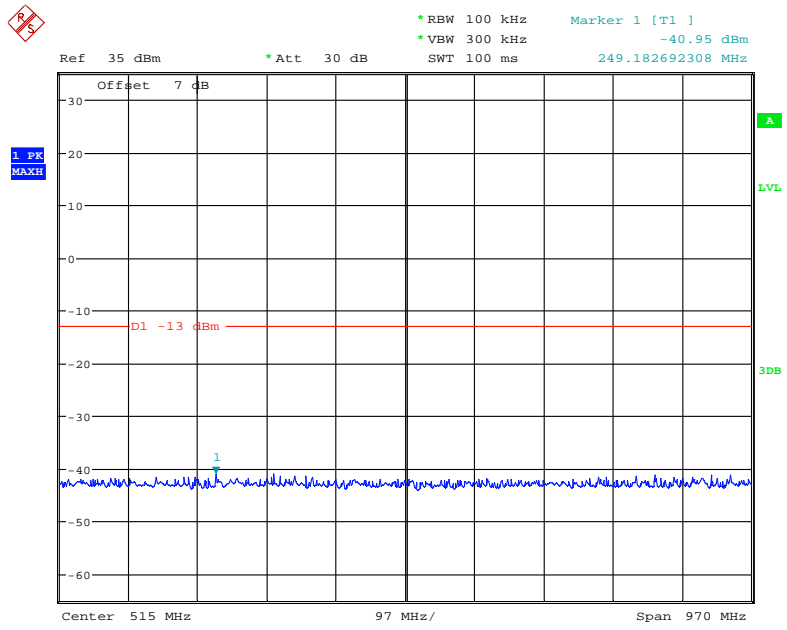

Date: 20.JUL.2021 00:24:28

1 GHz – 20 GHz (WCDMA Mode)

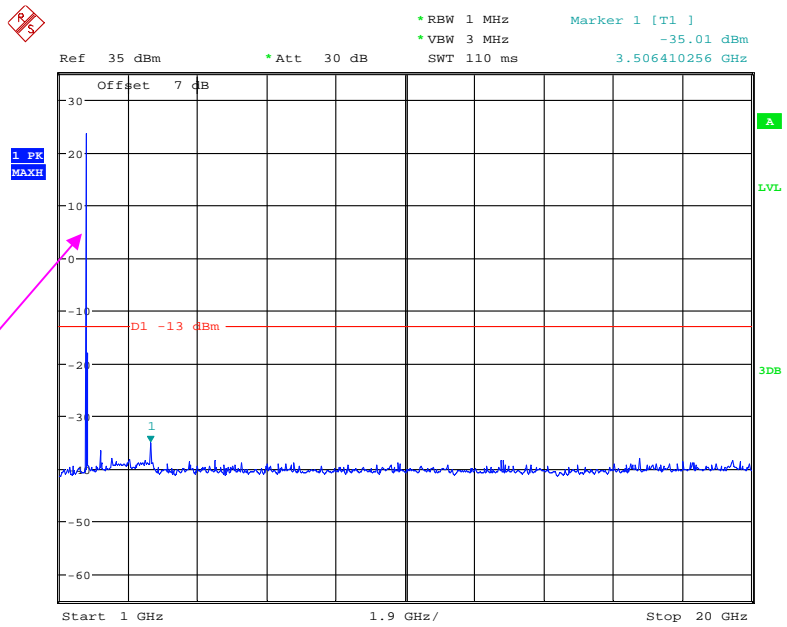

Fundamental test

Date: 20.JUL.2021 00:31:36

The test plots of LTE band please refer to the Appendix B.

FCC § 2.1053; § 22.917 (a); § 24.238 (a); §27.53 SPURIOUS RADIATED EMISSIONS**Applicable Standard**

FCC § 2.1053, §22.917(a) and § 24.238(a) and § 27.53

Test Procedure

The transmitter was placed on a wooden turntable, and it was transmitting into a non-radiating load which was also placed on the turntable.

The measurement antenna was placed at a distance of 3 meters from the EUT. During the tests, the receiving antenna height and polarization as well as EUT azimuth were varied in order to identify the maximum level of emissions from the EUT. The test was performed by placing the EUT on 3-orthogonal axis.

The frequency range up to tenth harmonic of the fundamental frequency was investigated.

Test Data**Environmental Conditions**

Temperature:	26 ~ 26.3 °C
Relative Humidity:	50~ 56 %
ATM Pressure:	101.0 ~101.1 kPa

The testing was performed by Cloud Qiu 2021-07-20 for below 1GHz, Hanic Pan on 2021-07-19 for above 1GHz.

EUT operation mode: Transmitting

30 MHz ~ 10 GHz:

Cellular Band (Part 22H)

Frequency (MHz)	Receiver Reading (dBµV)	Turntable Angle Degree	Rx Antenna		Substituted			Absolute Level (dBm)	FCC Part 22H	
			Height (m)	Polar (H/V)	Level (dBm)	Cable Loss (dB)	Antenna Gain (dBd/dBi)		Limit (dBm)	Margin (dB)
GSM Mode										
Low channel										
961.3	30.78	347	1.2	H	-65.7	1.36	0.0	-67.06	-13	54.06
961.3	31.88	25	1.1	V	-62.2	1.36	0.0	-63.56	-13	50.56
1648.40	50.36	269	2.4	H	-57.7	1.40	8.70	-50.40	-13	37.40
1648.40	50.01	357	1.7	V	-57.8	1.40	8.70	-50.50	-13	37.50
2472.60	46.33	181	1.8	H	-57.0	2.60	10.20	-49.40	-13	36.40
2472.60	46.62	311	1.4	V	-56.1	2.60	10.20	-48.50	-13	35.50
3296.80	45.26	330	2.4	H	-55.6	1.50	11.70	-45.40	-13	32.40
3296.80	45.14	227	1.0	V	-55.8	1.50	11.70	-45.60	-13	32.60
Middle channel										
960.2	30.45	17	2.2	H	-66.1	1.36	0.0	-67.46	-13	54.46
960.2	31.81	160	1.4	V	-62.2	1.36	0.0	-63.56	-13	50.56
1673.20	52.62	42	1.1	H	-53.7	1.30	8.90	-46.10	-13	33.10
1673.20	51.15	310	2.0	V	-54.6	1.30	8.90	-47.00	-13	34.00
2509.80	47.18	306	2.3	H	-56.2	2.60	10.20	-48.60	-13	35.60
2509.80	46.79	81	1.7	V	-56.0	2.60	10.20	-48.40	-13	35.40
3346.40	44.90	353	1.6	H	-56.0	1.50	11.70	-45.80	-13	32.80
3346.40	46.47	198	1.8	V	-54.5	1.50	11.70	-44.30	-13	31.30
High channel										
963.8	30.42	88	2.4	H	-66.1	1.36	0.0	-67.46	-13	54.46
963.8	31.84	249	2.3	V	-62.2	1.36	0.0	-63.56	-13	50.56
1695.60	51.74	208	2.1	H	-54.6	1.30	8.90	-47.00	-13	34.00
1695.60	51.02	299	2.3	V	-54.7	1.30	8.90	-47.10	-13	34.10
2543.40	47.68	84	2.4	H	-55.7	2.60	10.20	-48.10	-13	35.10
2543.40	47.21	268	2.3	V	-55.5	2.60	10.20	-47.90	-13	34.90
3391.20	46.32	20	1.4	H	-54.9	1.40	11.80	-44.50	-13	31.50
3391.20	46.71	279	1.6	V	-54.3	1.40	11.80	-43.90	-13	30.90

Frequency (MHz)	Receiver Reading (dBµV)	Turntable Angle Degree	Rx Antenna		Substituted			Absolute Level (dBm)	FCC Part 22H	
			Height (m)	Polar (H/V)	Level (dBm)	Cable Loss (dB)	Antenna Gain (dBd/dBi)		Limit (dBm)	Margin (dB)
WCDMA Mode										
Low channel										
962.3	30.29	125	1.8	H	-66.2	1.36	0.0	-67.56	-13	54.56
962.3	31.55	188	1.9	V	-62.5	1.36	0.0	-63.86	-13	50.86
1652.80	51.68	104	1.2	H	-54.7	1.30	8.90	-47.10	-13	34.10
1652.80	50.04	335	1.3	V	-55.7	1.30	8.90	-48.10	-13	35.10
2479.20	51.42	186	1.4	H	-51.9	2.60	10.20	-44.30	-13	31.30
2479.20	49.89	338	2.3	V	-52.9	2.60	10.20	-45.30	-13	32.30
3305.60	46.88	36	1.3	H	-54.0	1.50	11.70	-43.80	-13	30.80
3305.60	48.72	148	2.2	V	-52.2	1.50	11.70	-42.00	-13	29.00
Middle channel										
961.6	30.68	175	1.8	H	-65.8	1.36	0.0	-67.16	-13	54.16
961.6	31.59	169	1.4	V	-62.5	1.36	0.0	-63.86	-13	50.86
1673.20	52.83	359	1.4	H	-53.5	1.30	8.90	-45.90	-13	32.90
1673.20	50.83	218	1.6	V	-54.9	1.30	8.90	-47.30	-13	34.30
2509.80	52.45	81	1.2	H	-50.9	2.60	10.20	-43.30	-13	30.30
2509.80	50.80	134	2.2	V	-51.9	2.60	10.20	-44.30	-13	31.30
3346.40	47.65	34	2.2	H	-53.2	1.50	11.70	-43.00	-13	30.00
3346.40	49.60	107	2.1	V	-51.3	1.50	11.70	-41.10	-13	28.10
High channel										
964.5	30.72	135	1.4	H	-65.8	1.36	0.0	-67.16	-13	54.16
964.5	31.79	107	2.2	V	-62.3	1.36	0.0	-63.66	-13	50.66
1693.20	52.05	322	2.2	H	-54.3	1.30	8.90	-46.70	-13	33.70
1693.20	50.14	82	1.5	V	-55.6	1.30	8.90	-48.00	-13	35.00
2539.80	51.92	316	1.7	H	-51.4	2.60	10.20	-43.80	-13	30.80
2539.80	50.06	238	1.2	V	-52.7	2.60	10.20	-45.10	-13	32.10
3386.40	47.33	118	1.9	H	-53.9	1.40	11.80	-43.50	-13	30.50
3386.40	49.21	47	1.2	V	-51.8	1.40	11.80	-41.40	-13	28.40

30 MHz ~ 20 GHz:

PCS Band (Part 24E)

Frequency (MHz)	Receiver Reading (dBµV)	Turntable Angle Degree	Rx Antenna		Substituted			Absolute Level (dBm)	FCC Part 24E	
			Height (m)	Polar (H/V)	Level (dBm)	Cable Loss (dB)	Antenna Gain (dBd/dBi)		Limit (dBm)	Margin (dB)
GSM Mode										
Low channel										
962.3	30.57	348	2.5	H	-65.9	1.36	0.0	-67.26	-13	54.26
962.3	31.65	231	2.0	V	-62.4	1.36	0.0	-63.76	-13	50.76
3700.40	45.01	344	1.6	H	-56.8	1.60	11.90	-46.50	-13	33.50
3700.40	44.35	220	1.2	V	-56.9	1.60	11.90	-46.60	-13	33.60
Middle channel										
963.2	30.33	136	1.4	H	-66.2	1.36	0.0	-67.56	-13	54.56
963.2	31.69	330	1.2	V	-62.4	1.36	0.0	-63.76	-13	50.76
3760.00	45.13	136	2.1	H	-56.9	1.50	11.80	-46.60	-13	33.60
3760.00	44.14	53	2.3	V	-57.4	1.50	11.80	-47.10	-13	34.10
High channel										
960.5	30.39	23	2.2	H	-66.1	1.36	0.0	-67.46	-13	54.46
960.5	31.62	123	1.5	V	-62.4	1.36	0.0	-63.76	-13	50.76
3819.60	44.85	259	1.3	H	-57.2	1.50	11.80	-46.90	-13	33.90
3819.60	44.12	276	1.5	V	-57.5	1.50	11.80	-47.20	-13	34.20
WCDMA Mode Band 2										
Low Channel										
959.1	30.48	244	2.4	H	-66.0	1.36	0.0	-67.36	-13	54.36
959.1	31.61	326	1.3	V	-62.4	1.36	0.0	-63.76	-13	50.76
3704.80	48.33	168	1.2	H	-53.5	1.60	11.90	-43.20	-13	30.20
3704.80	55.14	357	1.6	V	-46.1	1.60	11.90	-35.80	-13	22.80
Middle channel										
960.8	30.41	294	2.2	H	-66.1	1.36	0.0	-67.46	-13	54.46
960.8	31.68	49	2.3	V	-62.4	1.36	0.0	-63.76	-13	50.76
3760.00	48.67	84	1.2	H	-53.4	1.50	11.80	-43.10	-13	30.10
3760.00	55.63	347	2.1	V	-46.0	1.50	11.80	-35.70	-13	22.70
High channel										
961.2	30.35	270	2.4	H	-66.2	1.36	0.0	-67.56	-13	54.56
961.2	31.77	223	1.2	V	-62.3	1.36	0.0	-63.66	-13	50.66
3815.20	47.38	14	2.3	H	-54.7	1.50	11.80	-44.40	-13	31.40
3815.20	54.22	187	1.3	V	-47.4	1.50	11.80	-37.10	-13	24.10

30 MHz ~ 20 GHz:

AWS Band

Frequency (MHz)	Receiver Reading (dBµV)	Turntable Angle Degree	Rx Antenna		Substituted			Absolute Level (dBm)	FCC Part 27	
			Height (m)	Polar (H/V)	Level (dBm)	Cable Loss (dB)	Antenna Gain (dBd/dBi)		Limit (dBm)	Margin (dB)
WCDMA Mode										
Low channel										
956.9	30.45	349	1.3	H	-66.1	1.36	0.0	-67.46	-13	54.46
956.9	31.72	126	2.0	V	-62.3	1.36	0.0	-63.66	-13	50.66
3424.80	47.59	33	1.6	H	-53.2	1.40	11.80	-42.80	-13	29.80
3424.80	47.62	11	1.6	V	-53.0	1.40	11.80	-42.60	-13	29.60
Middle channel										
964.7	30.31	266	1.0	H	-66.2	1.36	0.0	-67.56	-13	54.56
964.7	31.83	249	1.3	V	-62.2	1.36	0.0	-63.56	-13	50.56
3465.20	47.93	111	1.4	H	-52.8	1.50	12.00	-42.30	-13	29.30
3465.20	47.88	82	2.4	V	-53.6	1.50	12.00	-43.10	-13	30.10
High channel										
961.4	30.57	170	1.7	H	-65.9	1.36	0.0	-67.26	-13	54.26
961.4	31.87	257	2.2	V	-62.2	1.36	0.0	-63.56	-13	50.56
3505.20	47.84	154	1.1	H	-52.9	1.50	12.00	-42.40	-13	29.40
3505.20	47.78	223	1.6	V	-53.7	1.50	12.00	-43.20	-13	30.20

LTE Band: (Pre-scan with all the bandwidth, and worst case as below)

Frequency (MHz)	Receiver Reading (dBµV)	Turntable Angle Degree	Rx Antenna		Substituted			Absolute Level (dBm)	Limit (dBm)	Margin (dB)
			Height (m)	Polar (H/V)	Level (dBm)	Cable Loss (dB)	Antenna Gain (dBd/dBi)			
Band 2										
Test frequency range: 30 MHz ~ 20 GHz										
1.4MHz, Low channel										
960.6	30.63	8	1.6	H	-65.9	1.36	0.0	-67.26	-13	54.26
960.6	31.78	224	1.7	V	-62.3	1.36	0.0	-63.66	-13	50.66
3701.40	58.86	196	1.9	H	-42.9	1.60	11.90	-32.60	-13	19.60
3701.40	58.37	258	2.4	V	-42.9	1.60	11.90	-32.60	-13	19.60
1.4MHz, Middle channel										
961.1	30.54	57	1.2	H	-66.0	1.36	0.0	-67.36	-13	54.36
961.1	31.61	108	1.9	V	-62.4	1.36	0.0	-63.76	-13	50.76
3760.00	59.86	288	1.8	H	-42.2	1.50	11.80	-31.90	-13	18.90
3760.00	59.63	135	1.5	V	-42.0	1.50	11.80	-31.70	-13	18.70
1.4MHz, High channel										
958.4	30.51	313	1.1	H	-66.0	1.36	0.0	-67.36	-13	54.36
958.4	31.69	136	1.4	V	-62.4	1.36	0.0	-63.76	-13	50.76
3818.60	59.12	125	1.0	H	-42.9	1.50	11.80	-32.60	-13	19.60
3818.60	58.96	87	1.2	V	-42.6	1.50	11.80	-32.30	-13	19.30

Frequency (MHz)	Receiver Reading (dBµV)	Turntable Angle Degree	Rx Antenna		Substituted			Absolute Level (dBm)	Limit (dBm)	Margin (dB)
			Height (m)	Polar (H/V)	Level (dBm)	Cable Loss (dB)	Antenna Gain (dBd/dBi)			
Band 4										
Test frequency range:30 MHz ~ 20 GHz										
1.4MHz, Low channel										
963.2	30.34	4	2.0	H	-66.2	1.36	0.0	-67.56	-13	54.56
963.2	31.65	299	1.9	V	-62.4	1.36	0.0	-63.76	-13	50.76
3421.40	54.23	3	1.3	H	-46.6	1.40	11.80	-36.20	-13	23.20
3421.40	56.14	356	2.3	V	-44.5	1.40	11.80	-34.10	-13	21.10
1.4MHz, Middle channel										
956.6	30.46	27	1.9	H	-66.0	1.36	0.0	-67.36	-13	54.36
956.6	31.76	63	1.1	V	-62.3	1.36	0.0	-63.66	-13	50.66
3465.00	54.12	281	1.3	H	-46.6	1.50	12.00	-36.10	-13	23.10
3465.00	55.97	116	2.0	V	-45.5	1.50	12.00	-35.00	-13	22.00
1.4MHz, High channel										
959.3	30.58	126	1.1	H	-65.9	1.36	0.0	-67.26	-13	54.26
959.3	31.83	191	2.2	V	-62.2	1.36	0.0	-63.56	-13	50.56
3508.60	53.26	129	1.3	H	-47.5	1.50	12.00	-37.00	-13	24.00
3508.60	55.74	161	2.5	V	-45.8	1.50	12.00	-35.30	-13	22.30

Frequency (MHz)	Receiver Reading (dBμV)	Turntable Angle Degree	Rx Antenna		Substituted			Absolute Level (dBm)	Limit (dBm)	Margin (dB)
			Height (m)	Polar (H/V)	Level (dBm)	Cable Loss (dB)	Antenna Gain (dBd/dBi)			
Band 5										
Test frequency range:30 MHz ~ 10 GHz										
1.4MHz, Low channel										
955.8	30.53	294	2.4	H	-66.0	1.36	0.0	-67.36	-13	54.36
955.8	31.88	217	1.9	V	-62.2	1.36	0.0	-63.56	-13	50.56
1649.40	43.36	350	1.3	H	-64.7	1.40	8.70	-57.40	-13	44.40
1649.40	43.48	295	2.5	V	-64.4	1.40	8.70	-57.10	-13	44.10
2474.10	45.03	9	2.3	H	-58.3	2.60	10.20	-50.70	-13	37.70
2474.10	45.15	133	1.6	V	-57.6	2.60	10.20	-50.00	-13	37.00
3298.80	57.33	44	2.5	H	-43.6	1.50	11.70	-33.40	-13	20.40
3298.80	59.17	124	2.0	V	-41.8	1.50	11.70	-31.60	-13	18.60
1.4MHz, Middle channel										
961.7	30.41	243	2.2	H	-66.1	1.36	0.0	-67.46	-13	54.46
961.7	31.85	111	1.4	V	-62.2	1.36	0.0	-63.56	-13	50.56
1673.00	43.19	191	1.8	H	-63.1	1.30	8.90	-55.50	-13	42.50
1673.00	43.35	184	1.9	V	-62.4	1.30	8.90	-54.80	-13	41.80
2509.50	44.85	206	1.8	H	-58.5	2.60	10.20	-50.90	-13	37.90
2509.50	44.75	337	1.9	V	-58.0	2.60	10.20	-50.40	-13	37.40
3346.00	57.29	309	2.0	H	-43.6	1.50	11.70	-33.40	-13	20.40
3346.00	59.12	149	1.9	V	-41.8	1.50	11.70	-31.60	-13	18.60
1.4MHz, High channel										
964.2	30.38	356	2.4	H	-66.1	1.36	0.0	-67.46	-13	54.46
964.2	31.77	143	1.9	V	-62.3	1.36	0.0	-63.66	-13	50.66
1696.60	43.52	352	2.3	H	-62.8	1.30	8.90	-55.20	-13	42.20
1696.60	43.61	199	2.1	V	-62.1	1.30	8.90	-54.50	-13	41.50
2544.90	44.85	119	1.9	H	-58.5	2.60	10.20	-50.90	-13	37.90
2544.90	44.93	248	1.8	V	-57.8	2.60	10.20	-50.20	-13	37.20
3393.20	56.88	174	2.0	H	-44.4	1.40	11.80	-34.00	-13	21.00
3393.20	58.93	225	1.6	V	-42.1	1.40	11.80	-31.70	-13	18.70

Frequency (MHz)	Receiver Reading (dBµV)	Turntable Angle Degree	Rx Antenna		Substituted			Absolute Level (dBm)	Limit (dBm)	Margin (dB)
			Height (m)	Polar (H/V)	Level (dBm)	Cable Loss (dB)	Antenna Gain (dBd/dBi)			
Band 7										
Test frequency range: 30 MHz ~ 26.5 GHz										
5MHz, Low channel										
957.8	30.55	185	2.5	H	-66.0	1.36	0.0	-67.36	-25	42.36
957.8	31.65	297	2.2	V	-62.4	1.36	0.0	-63.76	-25	38.76
5005.00	47.85	107	2.1	H	-51.0	1.70	12.00	-40.70	-25	15.70
5005.00	45.99	84	2.0	V	-52.3	1.70	12.00	-42.00	-25	17.00
7507.50	46.69	268	1.1	H	-48.0	1.90	10.70	-39.20	-25	14.20
7507.50	49.75	56	1.8	V	-44.5	1.90	10.70	-35.70	-25	10.70
10010.0	53.22	292	1.8	H	-43.9	2.40	10.80	-35.50	-25	10.50
10010.0	52.09	13	1.1	V	-45.2	2.40	10.80	-36.80	-25	11.80
12512.5	50.31	269	2.0	H	-43.5	2.60	12.50	-33.60	-25	8.60
12512.5	49.17	268	1.4	V	-45.3	2.60	12.50	-35.40	-25	10.40
5MHz, Middle channel										
958.6	30.52	161	2.4	H	-66.0	1.36	0.0	-67.36	-25	42.36
958.6	31.63	220	1.6	V	-62.4	1.36	0.0	-63.76	-25	38.76
5070.00	46.14	264	1.3	H	-51.5	1.60	12.10	-41.00	-25	16.00
5070.00	46.46	91	1.5	V	-51.2	1.60	12.10	-40.70	-25	15.70
7605.00	46.46	314	2.5	H	-47.1	2.10	10.50	-38.70	-25	13.70
7605.00	48.38	36	1.9	V	-44.9	2.10	10.50	-36.50	-25	11.50
10140.0	51.41	225	1.8	H	-45.7	2.40	10.80	-37.30	-25	12.30
10140.0	53.99	308	1.5	V	-43.3	2.40	10.80	-34.90	-25	9.90
12675.0	49.36	108	1.9	H	-43.6	2.70	12.60	-33.70	-25	8.70
12675.0	50.14	308	1.6	V	-43.6	2.70	12.60	-33.70	-25	8.70
5MHz, High channel										
966.4	30.45	107	1.2	H	-66.1	1.36	0.0	-67.46	-25	42.46
966.4	31.81	297	1.9	V	-62.2	1.36	0.0	-63.56	-25	38.56
5135.00	45.79	280	1.2	H	-51.8	1.60	12.10	-41.30	-25	16.30
5135.00	47.55	44	2.3	V	-50.1	1.60	12.10	-39.60	-25	14.60
7702.50	48.91	352	2.5	H	-44.6	2.10	10.50	-36.20	-25	11.20
7702.50	47.33	355	2.3	V	-46.0	2.10	10.50	-37.60	-25	12.60
10270.0	50.64	24	2.2	H	-46.3	2.60	10.60	-38.30	-25	13.30
10270.0	54.79	64	2.4	V	-41.5	2.60	10.60	-33.50	-25	8.50
12837.5	52.66	230	2.4	H	-41.5	2.70	12.60	-31.60	-25	6.60
12837.5	52.87	26	1.8	V	-42.8	2.70	12.60	-32.90	-25	7.90

Frequency (MHz)	Receiver Reading (dBµV)	Turntable Angle Degree	Rx Antenna		Substituted			Absolute Level (dBm)	Limit (dBm)	Margin (dB)
			Height (m)	Polar (H/V)	Level (dBm)	Cable Loss (dB)	Antenna Gain (dBd/dBi)			
Band 12										
Test frequency range: 30 MHz ~ 10 GHz										
1.4MHz, Low channel										
962.9	30.39	345	1.5	H	-66.1	1.36	0.0	-67.46	-13	54.46
962.9	31.66	84	2.4	V	-62.4	1.36	0.0	-63.76	-13	50.76
1399.40	42.25	216	2.3	H	-65.9	1.60	7.90	-59.60	-13	46.60
1399.40	42.39	277	1.6	V	-66.0	1.60	7.90	-59.70	-13	46.70
2099.10	43.27	300	2.4	H	-57.9	1.30	9.70	-49.50	-13	36.50
2099.10	43.06	329	1.4	V	-58.9	1.30	9.70	-50.50	-13	37.50
2798.80	61.33	258	1.8	H	-42.6	1.80	10.50	-33.90	-13	20.90
2798.80	61.05	155	1.9	V	-42.6	1.80	10.50	-33.90	-13	20.90
1.4MHz, Middle channel										
965.7	30.34	317	1.6	H	-66.2	1.36	0.0	-67.56	-13	54.56
965.7	31.63	76	1.1	V	-62.4	1.36	0.0	-63.76	-13	50.76
1415.00	43.22	4	2.3	H	-65.0	1.60	7.90	-58.70	-13	45.70
1415.00	43.11	93	1.8	V	-65.3	1.60	7.90	-59.00	-13	46.00
2122.50	42.13	42	2.4	H	-59.0	1.30	9.70	-50.60	-13	37.60
2122.50	42.45	316	1.4	V	-59.5	1.30	9.70	-51.10	-13	38.10
2830.00	62.25	75	1.9	H	-41.7	1.80	10.50	-33.00	-13	20.00
2830.00	61.65	114	1.9	V	-42.0	1.80	10.50	-33.30	-13	20.30
1.4MHz, High channel										
957.6	30.31	238	1.3	H	-66.2	1.36	0.0	-67.56	-13	54.56
957.6	31.52	347	2.1	V	-62.5	1.36	0.0	-63.86	-13	50.86
1430.60	43.14	0	1.2	H	-65.0	1.60	7.90	-58.70	-13	45.70
1430.60	43.26	53	2.0	V	-65.2	1.60	7.90	-58.90	-13	45.90
2145.90	42.33	9	1.3	H	-58.8	1.30	9.70	-50.40	-13	37.40
2145.90	42.54	348	2.2	V	-59.4	1.30	9.70	-51.00	-13	38.00
2861.20	62.07	40	1.8	H	-42.6	1.70	10.70	-33.60	-13	20.60
2861.20	61.35	234	2.3	V	-43.4	1.70	10.70	-34.40	-13	21.40

Frequency (MHz)	Receiver Reading (dBμV)	Turntable Angle Degree	Rx Antenna		Substituted			Absolute Level (dBm)	Limit (dBm)	Margin (dB)
			Height (m)	Polar (H/V)	Level (dBm)	Cable Loss (dB)	Antenna Gain (dBd/dBi)			
Band 17										
Test frequency range: 30 MHz ~ 10GHz										
5MHz, Low channel										
962.3	30.55	48	2.4	H	-66.0	1.36	0.0	-67.36	-13	54.36
962.3	31.44	96	1.1	V	-62.6	1.36	0.0	-63.96	-13	50.96
1413.00	57.23	223	1.5	H	-50.9	1.60	7.90	-44.60	-13	31.60
1413.00	56.02	209	2.5	V	-52.4	1.60	7.90	-46.10	-13	33.10
2119.50	48.79	6	1.8	H	-52.3	1.30	9.70	-43.90	-13	30.90
2119.50	54.66	351	1.4	V	-47.3	1.30	9.70	-38.90	-13	25.90
2826.00	63.81	189	1.9	H	-40.1	1.80	10.50	-31.40	-13	18.40
2826.00	60.19	276	1.4	V	-43.4	1.80	10.50	-34.70	-13	21.70
3532.50	59.47	41	2.5	H	-41.4	1.50	12.00	-30.90	-13	17.90
3532.50	56.33	274	2.2	V	-45.3	1.50	12.00	-34.80	-13	21.80
4239.00	56.18	3	2.0	H	-45.8	1.50	11.80	-35.50	-13	22.50
4239.00	52.67	144	1.4	V	-48.5	1.50	11.80	-38.20	-13	25.20
5MHz, Middle channel										
959.3	30.42	337	1.7	H	-66.1	1.36	0.0	-67.46	-13	54.46
959.3	31.62	131	2.0	V	-62.4	1.36	0.0	-63.76	-13	50.76
1420.00	56.74	39	2.0	H	-51.4	1.60	7.90	-45.10	-13	32.10
1420.00	55.66	99	1.8	V	-52.8	1.60	7.90	-46.50	-13	33.50
2130.00	59.34	220	2.3	H	-41.8	1.30	9.70	-33.40	-13	20.40
2130.00	53.94	93	1.5	V	-48.0	1.30	9.70	-39.60	-13	26.60
2840.00	62.60	106	1.4	H	-41.4	1.80	10.50	-32.70	-13	19.70
2840.00	58.94	342	2.4	V	-44.7	1.80	10.50	-36.00	-13	23.00
3550.00	60.66	261	2.3	H	-41.1	1.50	12.10	-30.50	-13	17.50
3550.00	57.71	92	2.1	V	-43.5	1.50	12.10	-32.90	-13	19.90
4260.00	54.92	289	1.6	H	-46.5	1.50	11.70	-36.30	-13	23.30
4260.00	53.13	153	1.5	V	-47.6	1.50	11.70	-37.40	-13	24.40
5MHz, High channel										
960.3	30.53	108	2.1	H	-66.0	1.36	0.0	-67.36	-13	54.36
960.3	31.83	274	1.6	V	-62.2	1.36	0.0	-63.56	-13	50.56
1427.00	56.27	132	2.4	H	-51.9	1.60	7.90	-45.60	-13	32.60
1427.00	53.88	324	1.8	V	-54.6	1.60	7.90	-48.30	-13	35.30
2140.50	60.19	267	1.2	H	-40.9	1.30	9.70	-32.50	-13	19.50
2140.50	53.24	0	1.7	V	-48.7	1.30	9.70	-40.30	-13	27.30
2854.00	61.92	208	2.5	H	-42.8	1.70	10.70	-33.80	-13	20.80
2854.00	56.84	9	2.0	V	-47.9	1.70	10.70	-38.90	-13	25.90
3567.50	61.29	325	1.5	H	-40.4	1.50	12.10	-29.80	-13	16.80
3567.50	58.47	145	1.4	V	-42.7	1.50	12.10	-32.10	-13	19.10
4281.00	53.12	324	1.7	H	-48.3	1.50	11.70	-38.10	-13	25.10
4281.00	50.64	118	1.1	V	-50.0	1.50	11.70	-39.80	-13	26.80

Frequency (MHz)	Receiver Reading (dBμV)	Turntable Angle Degree	Rx Antenna		Substituted			Absolute Level (dBm)	Limit (dBm)	Margin (dB)
			Height (m)	Polar (H/V)	Level (dBm)	Cable Loss (dB)	Antenna Gain (dBd/dBi)			
Band 66										
Test frequency range: 30 MHz ~ 20GHz										
1.4MHz, Low channel										
963.2	30.26	273	2.0	H	-66.2	1.36	0.0	-67.56	-13	54.56
963.2	31.41	115	1.2	V	-62.6	1.36	0.0	-63.96	-13	50.96
3421.40	53.79	198	1.3	H	-47.0	1.40	11.80	-36.60	-13	23.60
3421.40	51.66	236	1.9	V	-48.9	1.40	11.80	-38.50	-13	25.50
5132.10	44.19	42	1.6	H	-55.8	1.60	12.10	-45.30	-13	32.30
5132.10	45.07	61	2.0	V	-54.9	1.60	12.10	-44.40	-13	31.40
1.4MHz, Middle Channel										
962.1	30.38	245	2.2	H	-66.1	1.36	0.0	-67.46	-13	54.46
962.1	31.48	21	1.9	V	-62.6	1.36	0.0	-63.96	-13	50.96
3490.00	52.95	233	2.2	H	-47.8	1.50	12.00	-37.30	-13	24.30
3490.00	53.21	335	2.4	V	-48.3	1.50	12.00	-37.80	-13	24.80
5235.00	44.31	120	2.4	H	-55.8	1.60	12.10	-45.30	-13	32.30
5235.00	44.43	318	1.0	V	-55.2	1.60	12.10	-44.70	-13	31.70
1.4MHz, High Channel										
964.5	30.52	208	1.6	H	-66.0	1.36	0.0	-67.36	-13	54.36
964.5	31.59	219	2.1	V	-62.5	1.36	0.0	-63.86	-13	50.86
3558.60	53.87	244	1.6	H	-47.7	1.50	12.10	-37.10	-13	24.10
3558.60	53.46	98	2.3	V	-47.6	1.50	12.10	-37.00	-13	24.00
5337.90	45.07	56	2.0	H	-54.7	1.60	12.20	-44.10	-13	31.10
5337.90	44.32	206	2.0	V	-54.8	1.60	12.20	-44.20	-13	31.20

Note:

Absolute Level = Substituted Level - Cable loss + Antenna Gain

Margin = Limit- Absolute Level

dBd is for the ERP, dBi is for EIRP.

FCC § 22.917 (a); § 24.238 (a); §27.53(c) (h)(m) - BAND EDGES

Applicable Standard

According to § 22.917(a), the power of any emissions outside of the authorized operating frequency ranges must be attenuated below the transmitting power (P) by a factor of at least $43 + 10 \log(P)$ dB.

According to §24.238(a), the power of any emissions outside of the authorized operating frequency ranges must be attenuated below the transmitting power (P) by a factor of at least $43 + 10 \log(P)$ dB.

According to FCC §27.53 (c)(h)(m), the power of any emission outside of the authorized operating frequency ranges must be attenuated below the transmitting power (P) by a factor of at least $43 + 10 \log(P)$ dB.

Test Procedure

The RF output of the transmitter was connected to the input of the spectrum analyzer through sufficient attenuation.

The center of the spectrum analyzer was set to block edge frequency

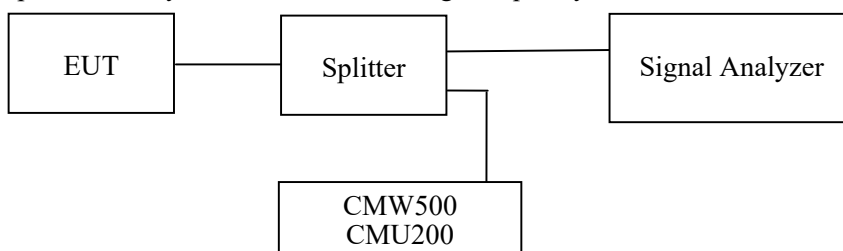

Test Data

Environmental Conditions

Temperature:	25 °C
Relative Humidity:	55 ~62 %
ATM Pressure:	101.0 kPa

The testing was performed by Orlo Yang from 2021-07-18 to 2021-08-14.

EUT operation mode: Transmitting (Worst case)

Test Result: Pass

Please refer to the following plots.

Cellular Band, Left Band Edge for GSM (GMSK) Mode

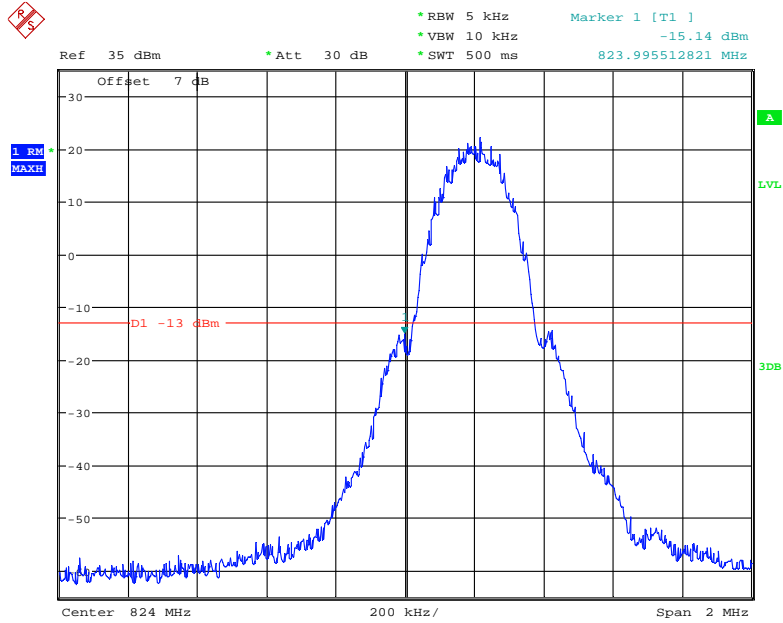

Date: 20.JUL.2021 00:41:51

Cellular Band, Right Band Edge for GSM (GMSK) Mode

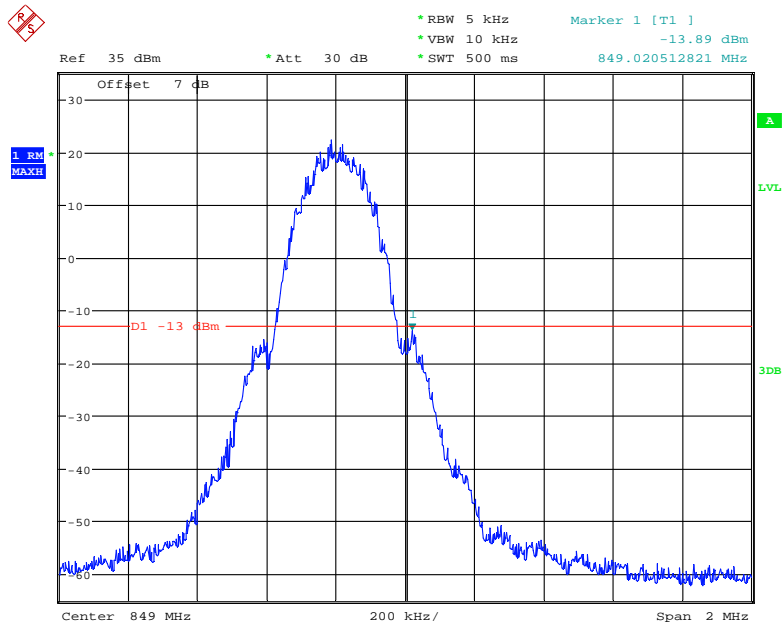

Date: 20.JUL.2021 00:45:10

Cellular Band, Left Band Edge for EGPRS (8PSK) Mode

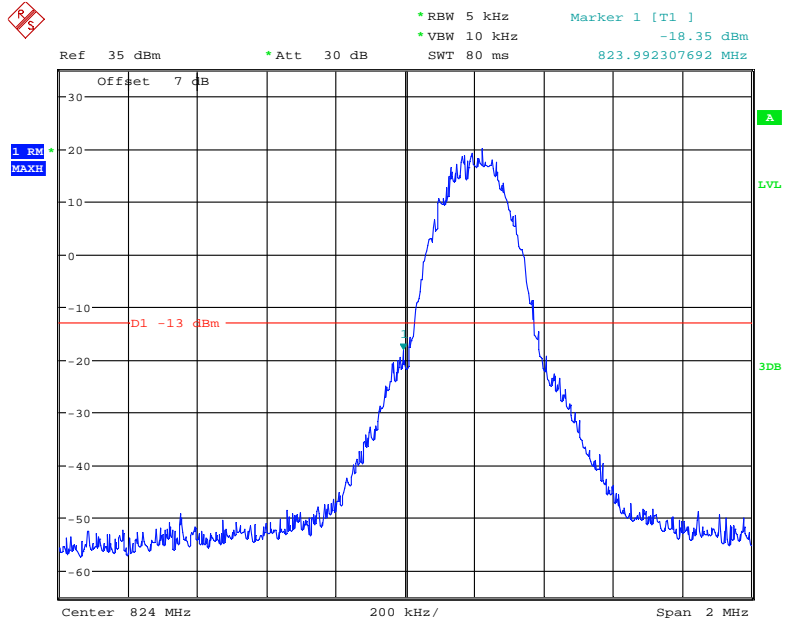

Date: 20.JUL.2021 00:48:13

Cellular Band, Right Band Edge for EGPRS (8PSK) Mode

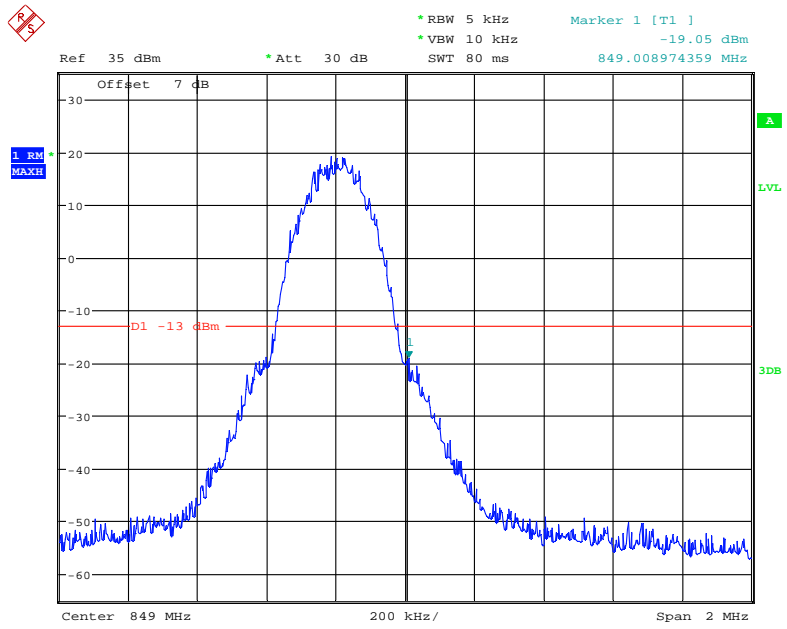

Date: 20.JUL.2021 00:50:16

Cellular Band, Left Band Edge for RMC (BPSK) Mode

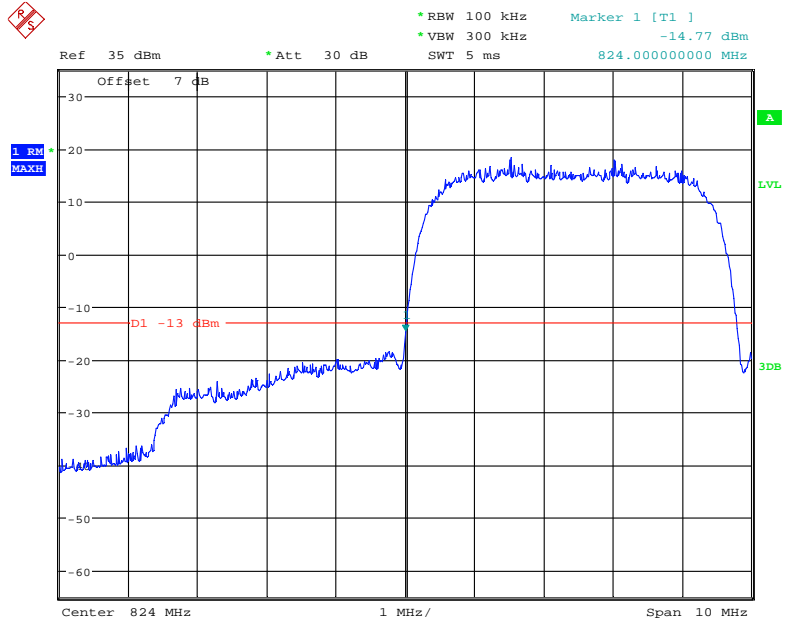

Date: 19.JUL.2021 22:36:57

Cellular Band, Right Band Edge for RMC (BPSK) Mode

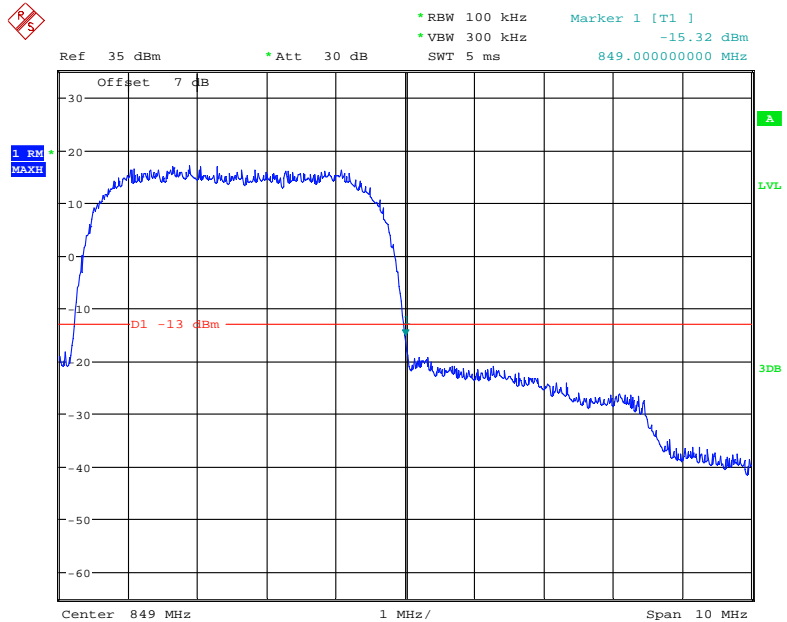

Date: 19.JUL.2021 22:36:14

Cellular Band, Left Band Edge for HSDPA (16QAM) Mode

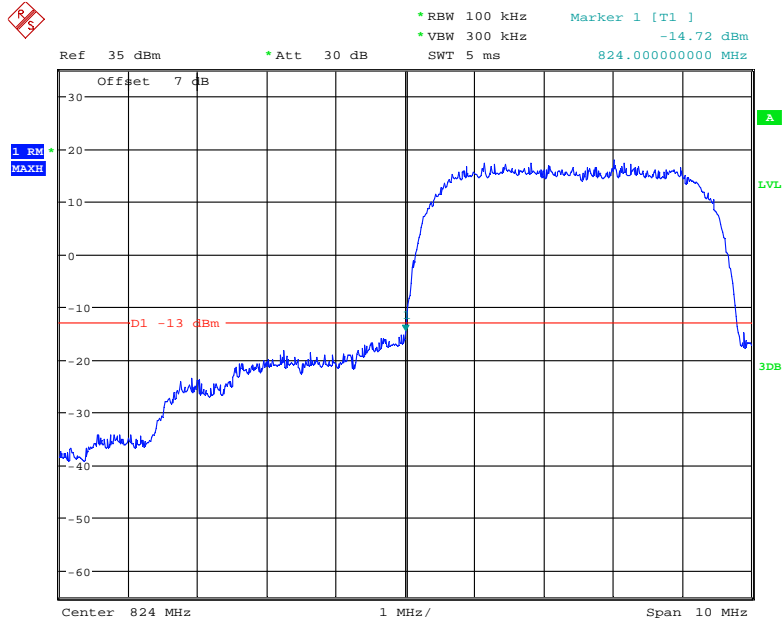

Date: 19.JUL.2021 22:59:29

Cellular Band, Right Band Edge for HSDPA (16QAM) Mode

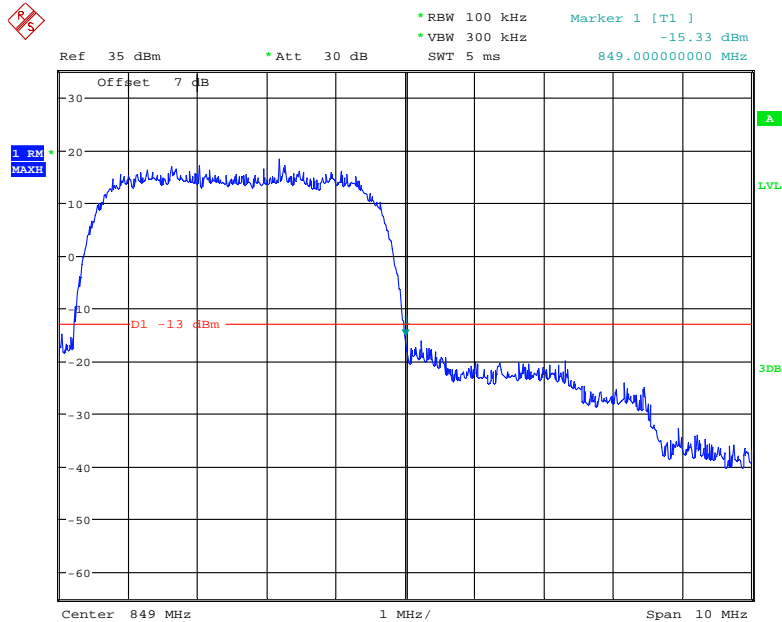

Date: 19.JUL.2021 23:00:39

Cellular Band, Left Band Edge for HSUPA (BPSK) Mode

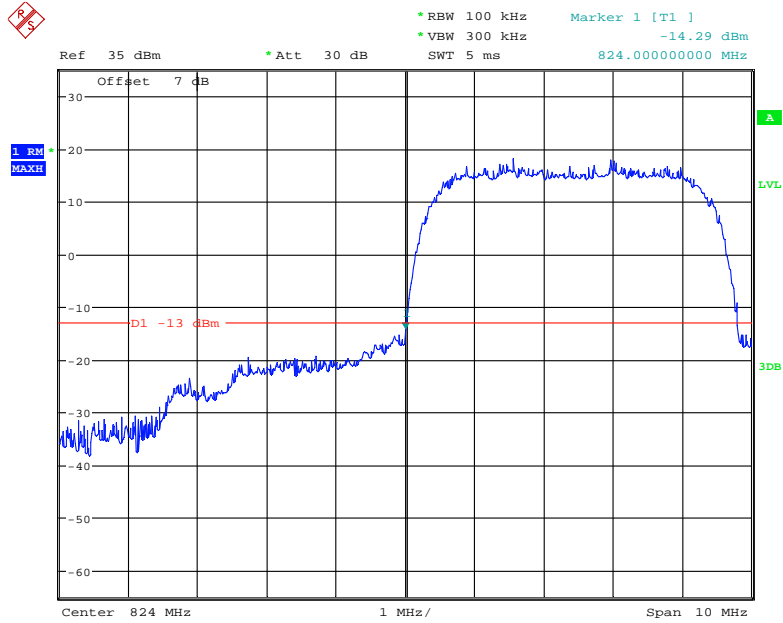

Date: 19.JUL.2021 22:42:21

Cellular Band, Right Band Edge for HSUPA (BPSK) Mode

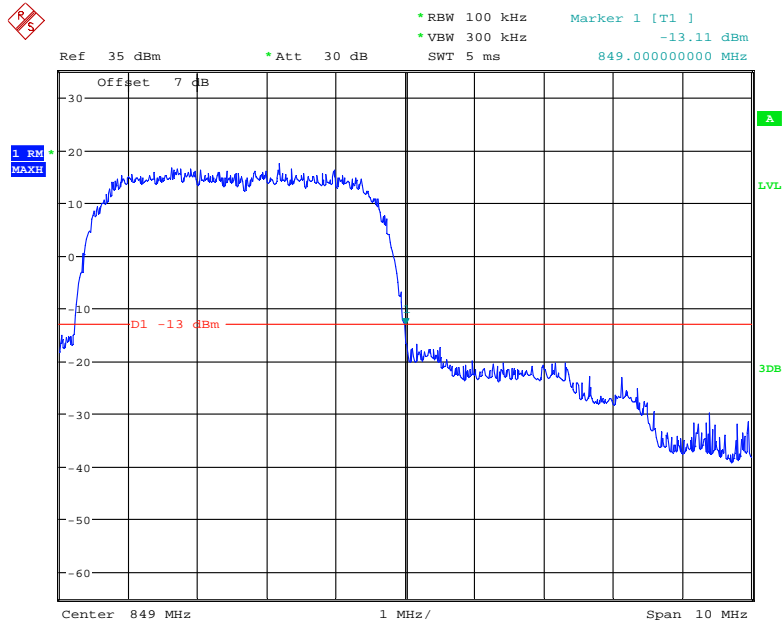

Date: 19.JUL.2021 22:43:28

PCS Band, Left Band Edge for GSM (GMSK) Mode

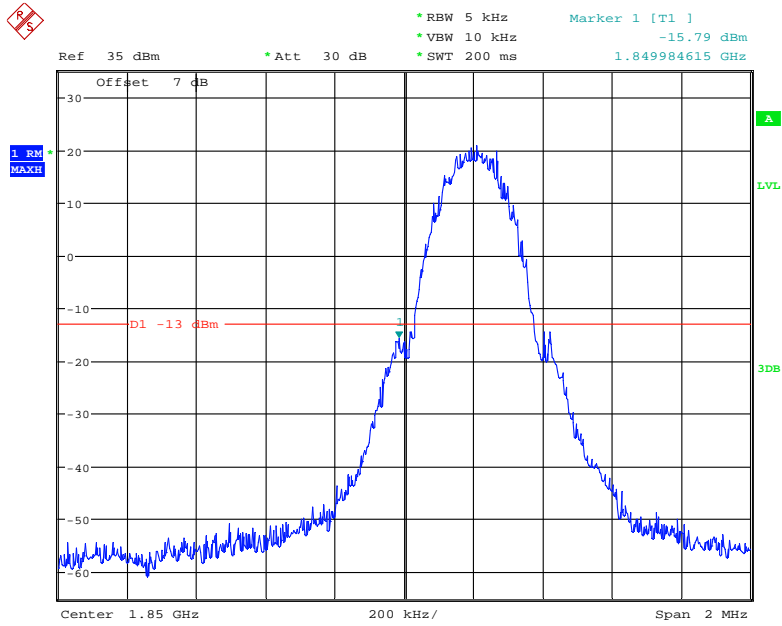

Date: 20.JUL.2021 01:02:39

PCS Band, Right Band Edge for GSM (GMSK) Mode

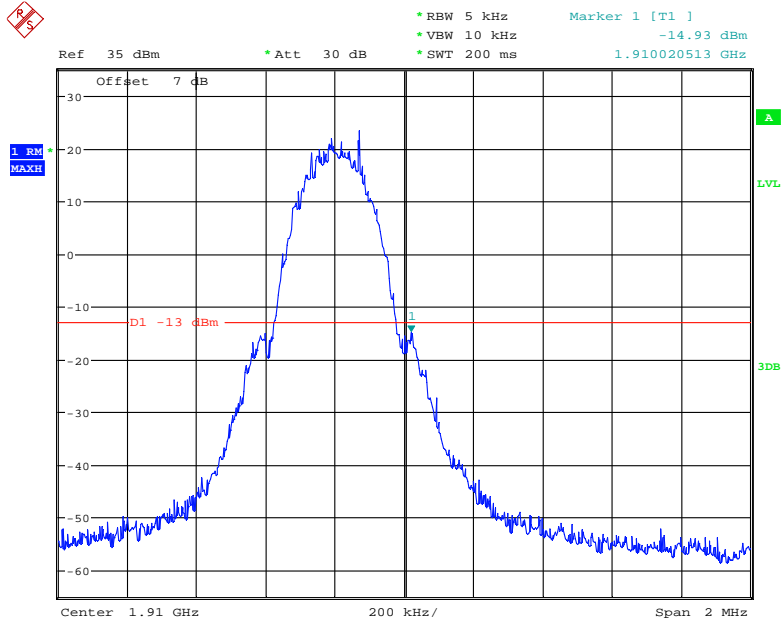

Date: 20.JUL.2021 01:01:05

PCS Band, Left Band Edge for EGPRS (8PSK) Mode

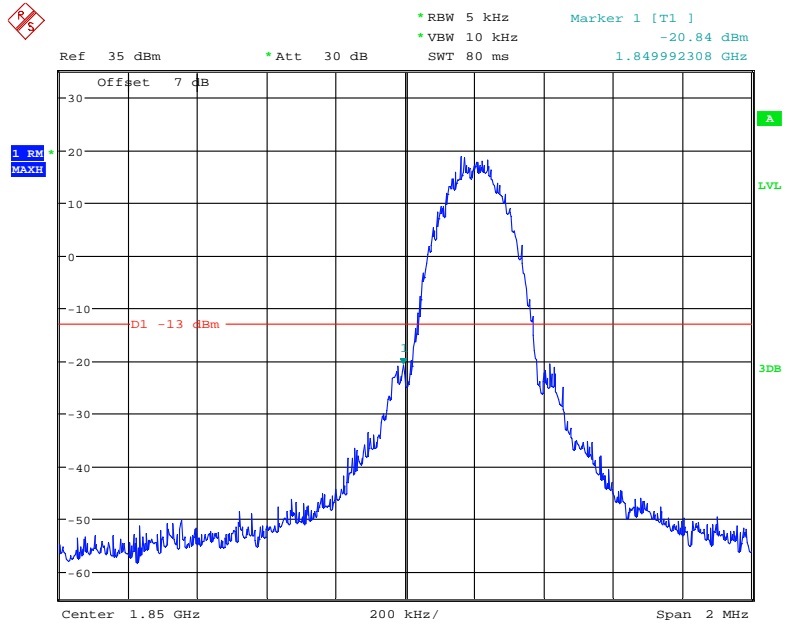

Date: 20.JUL.2021 00:54:06

PCS Band, Right Band Edge for EGPRS (8PSK) Mode

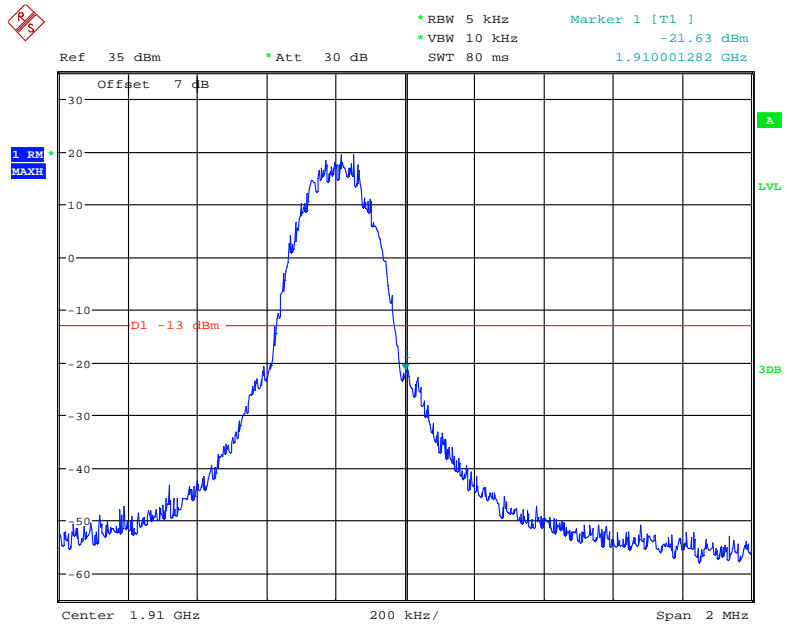

Date: 20.JUL.2021 00:55:10

PCS Band, Left Band Edge for RMC (BPSK) Mode

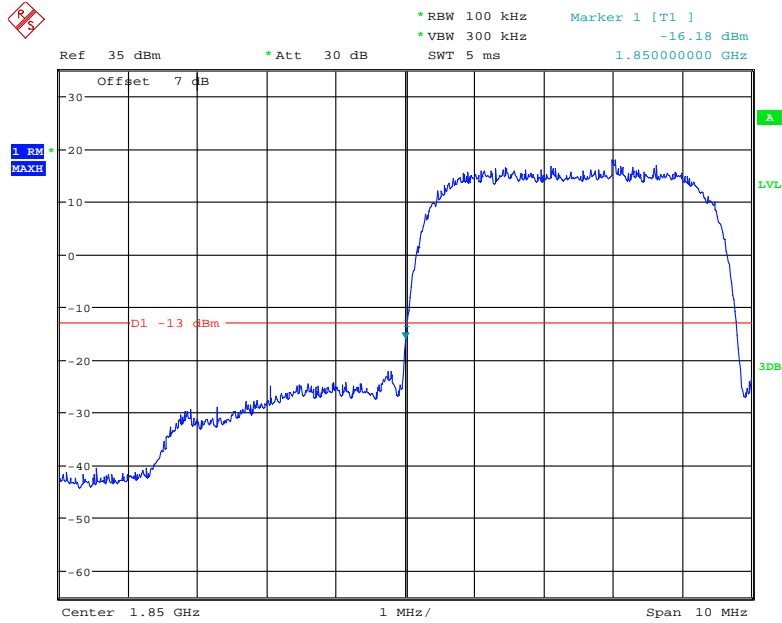

Date: 19.JUL.2021 22:31:32

PCS Band, Right Band Edge for RMC (BPSK) Mode

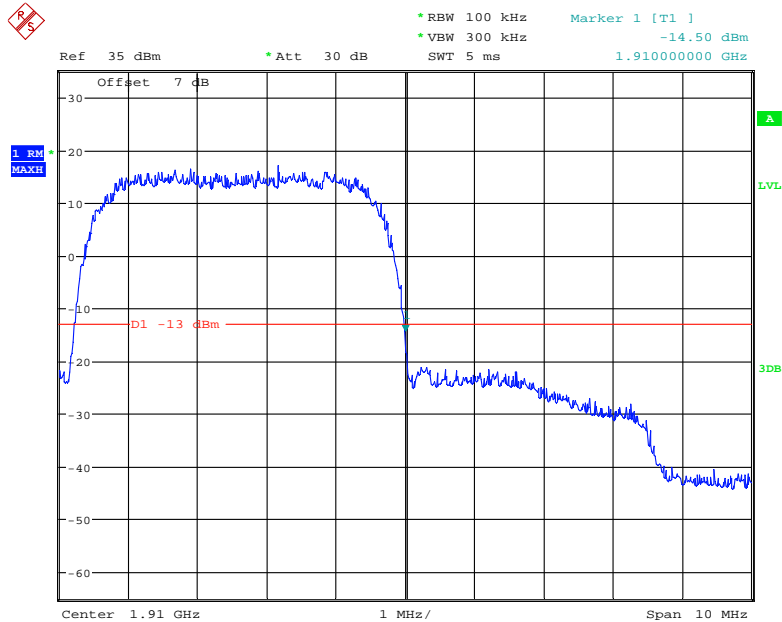

Date: 19.JUL.2021 22:32:45

PCS Band, Left Band Edge for HSDPA (16QAM) Mode

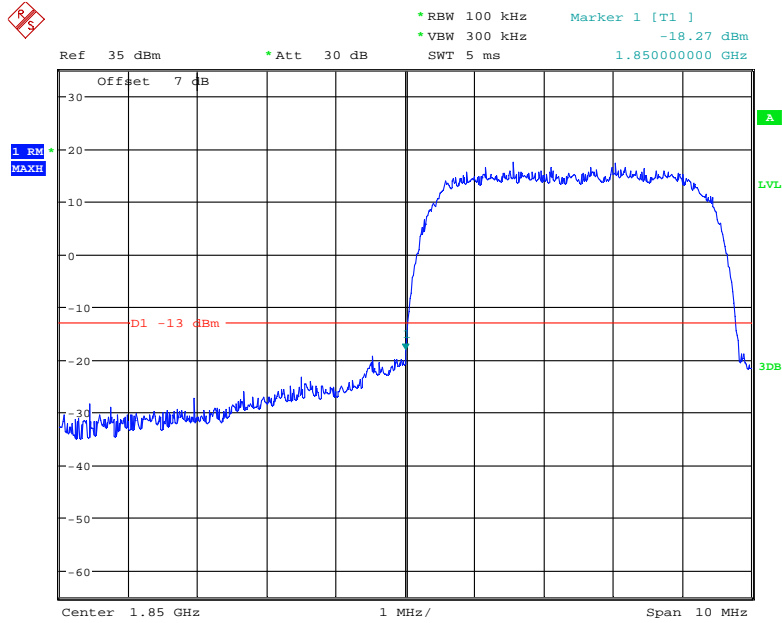

Date: 19.JUL.2021 22:52:11

PCS Band, Right Band Edge for HSDPA (16QAM) Mode

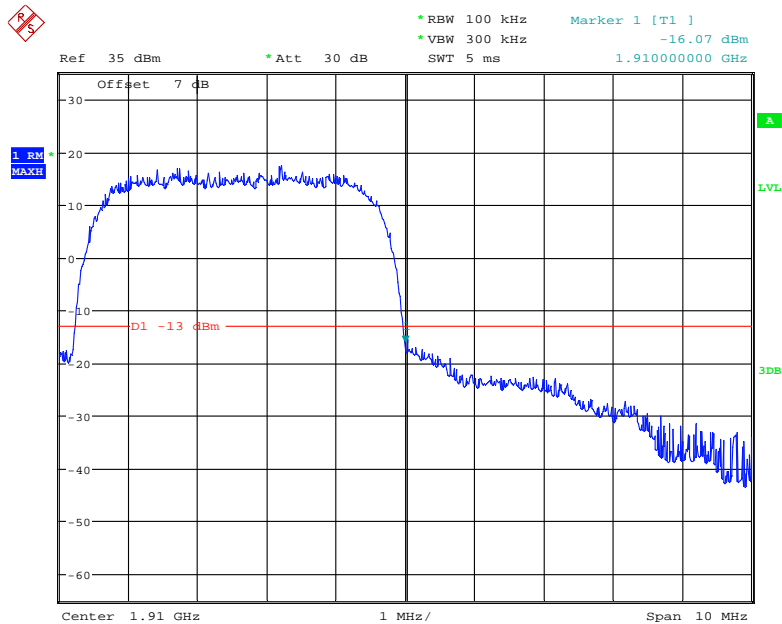

Date: 19.JUL.2021 22:53:47

PCS Band, Left Band Edge for HSUPA (BPSK) Mode

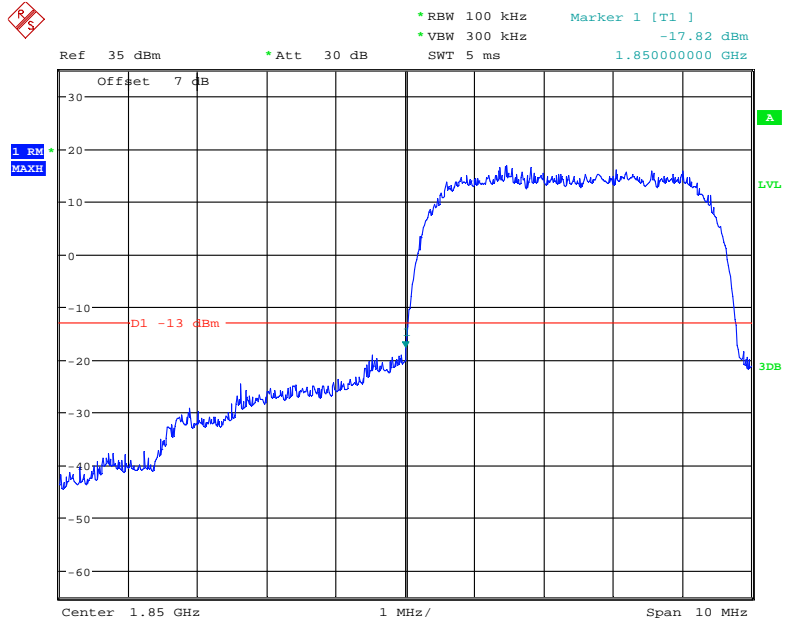

Date: 19.JUL.2021 22:49:16

PCS Band, Right Band Edge for HSUPA (BPSK) Mode

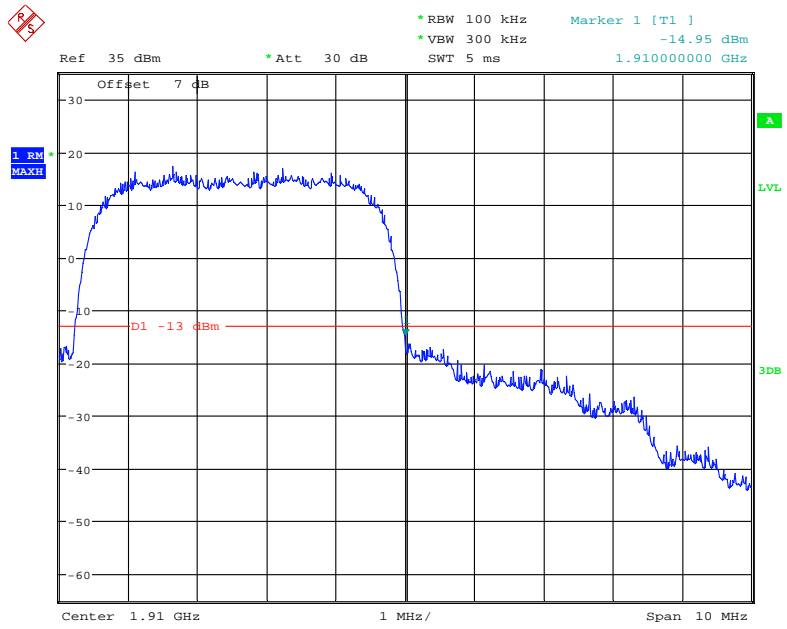

Date: 19.JUL.2021 22:48:04

AWS Band, Left Band Edge for RMC (BPSK) Mode

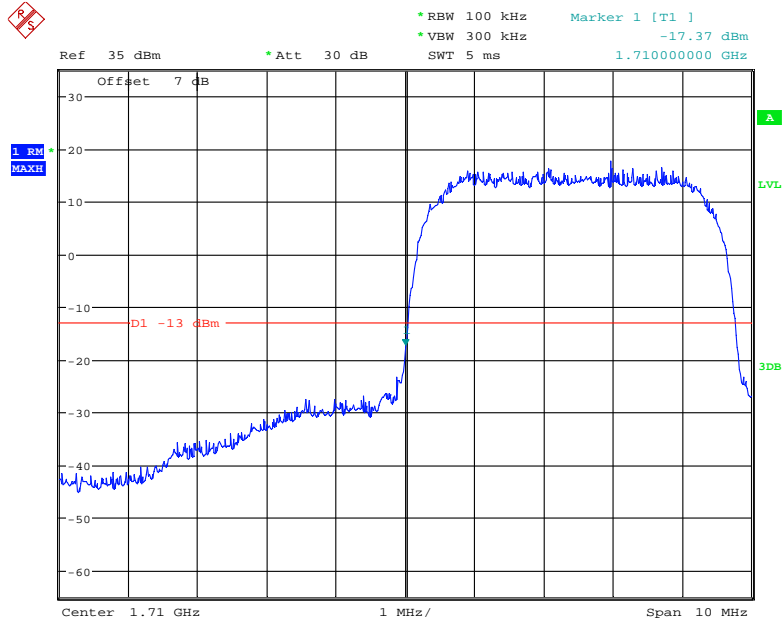

Date: 19.JUL.2021 22:34:42

AWS Band, Right Band Edge for RMC (BPSK) Mode

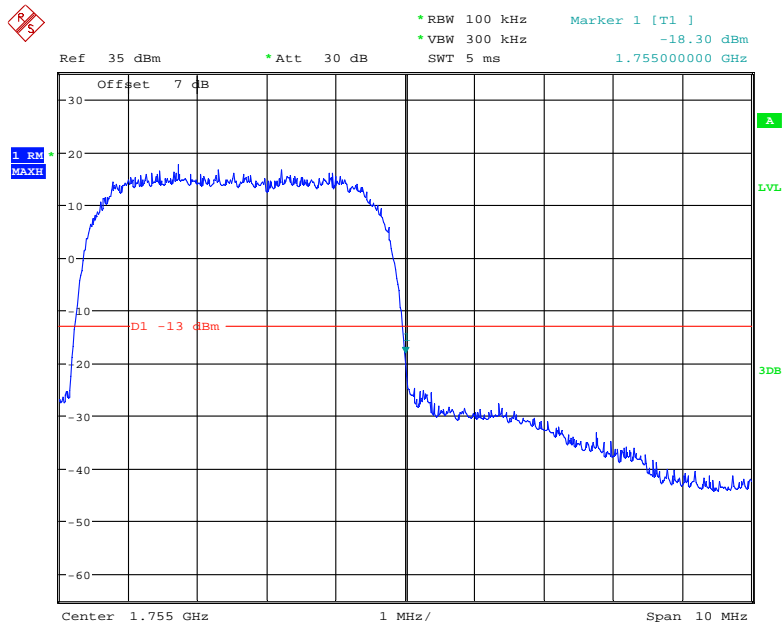

Date: 19.JUL.2021 22:33:43

AWS Band, Left Band Edge for HSDPA (16QAM) Mode

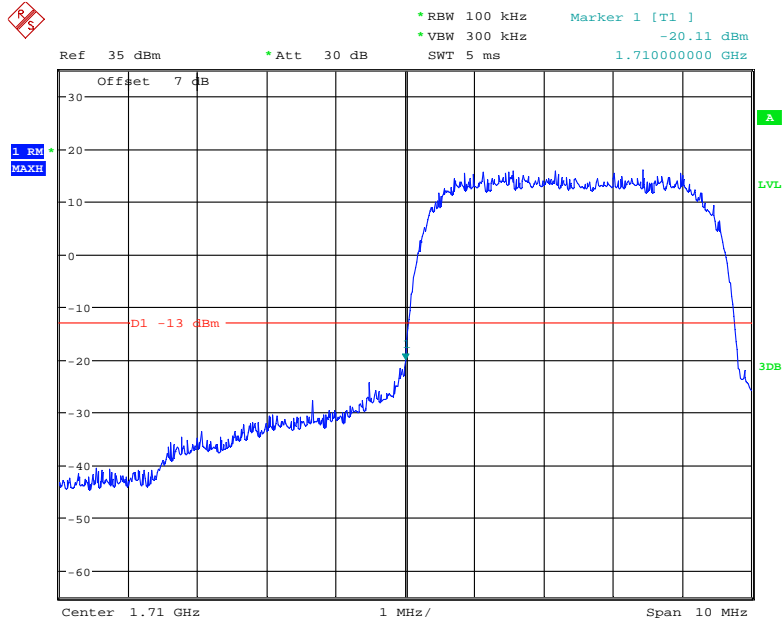

Date: 19.JUL.2021 22:56:02

AWS Band, Right Band Edge for HSDPA (16QAM) Mode

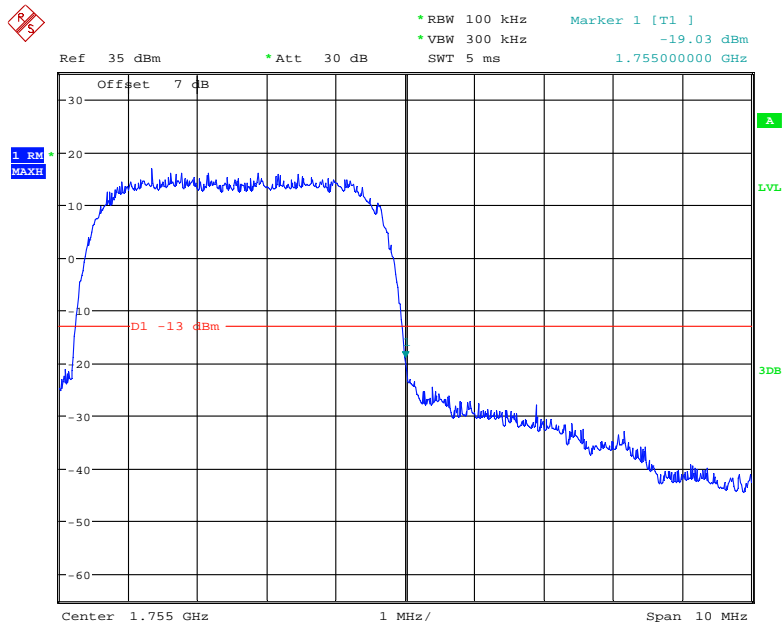

Date: 19.JUL.2021 22:56:49

AWS Band, Left Band Edge for HSUPA (BPSK) Mode

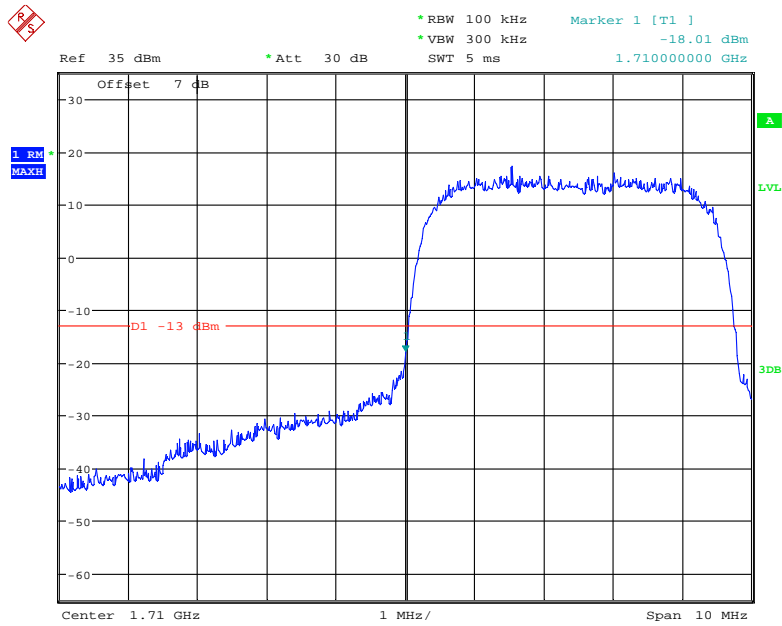

Date: 19.JUL.2021 22:46:51

AWS Band, Right Band Edge for HSUPA (BPSK) Mode

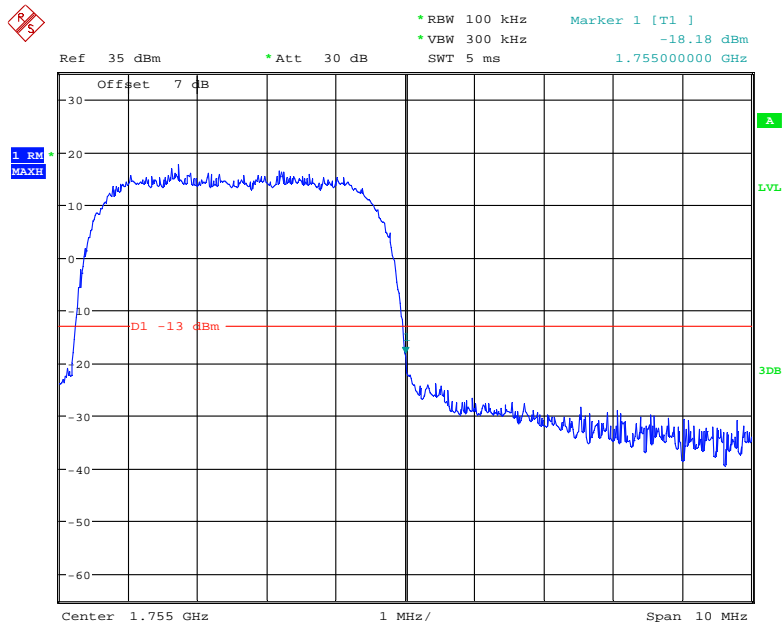

Date: 19.JUL.2021 22:45:50

The test plots of LTE bands please refer to the Appendix C.

FCC § 2.1055; § 22.355; § 24.235; §27.54 - FREQUENCY STABILITY

Applicable Standard

FCC § 2.1055, §22.355, §24.235 and & §27.54.

According to FCC §2.1055, the frequency stability shall be sufficient to ensure that the fundamental emissions stay within the authorized bands of operation.

According to §22.355, the carrier frequency of each transmitter in the Public Mobile Services must be maintained within the tolerances given in Table below:

Frequency Tolerance for Transmitters in the Public Mobile Services

Frequency Range (MHz)	Base, fixed (ppm)	Mobile ≤ 3 watts (ppm)	Mobile > 3 watts (ppm)
25 to 50	20.0	20.0	50.0
50 to 450	5.0	5.0	50.0
450 to 512	2.5	5.0	5.0
821 to 896	1.5	2.5	2.5
928 to 929.	5.0	N/A	N/A
929 to 960.	1.5	N/A	N/A
2110 to 2220	10.0	N/A	N/A

According to §24.235, the frequency stability shall be sufficient to ensure that the fundamental emissions stays within the authorized frequency block.

Test Procedure

Frequency Stability vs. Temperature: The equipment under test was connected to an external DC power supply and the RF output was connected to communication test set via feed-through attenuators. The EUT was placed inside the temperature chamber. The DC leads and RF output cable exited the chamber through an opening made for the purpose.

After the temperature stabilized for approximately 20 minutes, the frequency output was recorded from the communication test set.

Frequency Stability vs. Voltage: For hand carried, battery powered equipment; reduce primary supply voltage to the battery operating end point which shall be specified by the manufacturer.

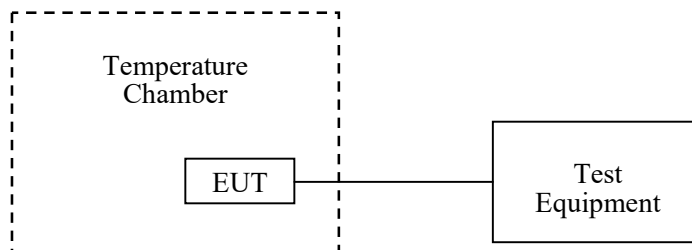

Test Data

Environmental Conditions

Temperature:	25 °C
Relative Humidity:	55 ~62 %
ATM Pressure:	101.0 kPa

The testing was performed by Orlo Yang from 2021-07-16 to 2021-07-22

EUT operation mode: Transmitting

Test Result: Pass

Please refer to the following tables.

Cellular Band (Part 22H)

GSM Mode

Middle Channel, $f_0=836.6\text{MHz}$				
Temperature (°C)	Voltage Supplied (V _{DC})	Frequency Error (Hz)	Frequency Error (ppm)	Limit (ppm)
-30	3.8	-8	-0.0096	2.5
-20		-5	-0.0060	2.5
-10		-3	-0.0036	2.5
0		-2	-0.0024	2.5
10		1	0.0012	2.5
20		6	0.0072	2.5
30		5	0.0060	2.5
40		7	0.0084	2.5
50		9	0.0108	2.5
20		3.55	11	0.0131
	4.35	14	0.0167	2.5

EDGE Mode

Middle Channel, $f_0 = 836.6\text{MHz}$				
Temperature (°C)	Voltage Supplied (V _{DC})	Frequency Error (Hz)	Frequency Error (ppm)	Limit (ppm)
-30	3.8	7	0.0084	2.5
-20		8	0.0096	2.5
-10		10	0.0120	2.5
0		5	0.0060	2.5
10		7	0.0084	2.5
20		9	0.0108	2.5
30		5	0.0060	2.5
40		8	0.0096	2.5
50		9	0.0108	2.5
20	3.55	7	0.0084	2.5
	4.35	3	0.0036	2.5

WCDMA Mode

Middle Channel, $f_0 = 836.6\text{MHz}$				
Temperature (°C)	Voltage Supplied (V _{DC})	Frequency Error (Hz)	Frequency Error (ppm)	Limit (ppm)
-30	3.8	5	0.0060	2.5
-20		6	0.0072	2.5
-10		-8	-0.0096	2.5
0		4	0.0048	2.5
10		5	0.0060	2.5
20		7	0.0084	2.5
30		-3	-0.0036	2.5
40		6	0.0072	2.5
50		7	0.0084	2.5
20	3.55	5	0.0060	2.5
	4.35	6	0.0072	2.5

PCS Band (Part 24E)

GSM Mode

Middle Channel, $f_0 = 1880.0$ MHz				
Temperature (°C)	Voltage Supplied (V _{DC})	Frequency Error (Hz)	Frequency Error (ppm)	Result
-30	3.8	5	0.0027	Pass
-20		-4	-0.0021	Pass
-10		3	0.0016	Pass
0		2	0.0011	Pass
10		-4	-0.0021	Pass
20		5	0.0027	Pass
30		6	0.0032	Pass
40		8	0.0043	Pass
50		9	0.0048	Pass
20		3.55	10	0.0053
	4.35	7	0.0037	Pass

EDGE Mode

Middle Channel, $f_0 = 1880.0$ MHz				
Temperature (°C)	Voltage Supplied (V _{DC})	Frequency Error (Hz)	Frequency Error (ppm)	Result
-30	3.8	7	0.0037	Pass
-20		4	0.0021	Pass
-10		5	0.0027	Pass
0		-4	-0.0021	Pass
10		3	0.0016	Pass
20		7	0.0037	Pass
30		8	0.0043	Pass
40		9	0.0048	Pass
50		-5	-0.0027	Pass
20		3.55	6	0.0032
	4.35	9	0.0048	Pass

WCDMA Mode

Middle Channel, $f_0 = 1880.0$ MHz				
Temperature (°C)	Voltage Supplied (V _{DC})	Frequency Error (Hz)	Frequency Error (ppm)	Result
-30	3.8	5	0.0027	Pass
-20		2	0.0011	Pass
-10		3	0.0016	Pass
0		-6	-0.0032	Pass
10		2	0.0011	Pass
20		5	0.0027	Pass
30		-5	-0.0027	Pass
40		7	0.0037	Pass
50		6	0.0032	Pass
20		3.55	4	0.0021
	4.35	7	0.0037	Pass

AWS Band (Part 27)

Temperature (°C)	Power Supplied (V _{DC})	F _L (MHz)	F _H (MHz)	F _L Limit (MHz)	F _H Limit (MHz)
-30	3.8	1710.0374	1754.9069	1710	1755
-20		1710.0053	1754.9919	1710	1755
-10		1710.0574	1754.9850	1710	1755
0		1710.0391	1754.9804	1710	1755
10		1710.0319	1754.9772	1710	1755
20		1710.0207	1754.9637	1710	1755
30		1710.0253	1754.9817	1710	1755
40		1710.0109	1754.9615	1710	1755
50		1710.0205	1754.9775	1710	1755
20		3.55	1710.0106	1754.9733	1710
	4.35	1710.0325	1754.9940	1710	1755

LTE:
QPSK:

Band 2:

10.0 MHz Middle Channel, f ₀ =1880MHz				
Temperature (°C)	Voltage Supplied (V _{DC})	Frequency Error (Hz)	Frequency Error (ppm)	Result
-30	3.8	4.47	0.0024	Pass
-20		0.36	0.0002	Pass
-10		3.59	0.0019	Pass
0		6.31	0.0034	Pass
10		7.15	0.0038	Pass
20		6.44	0.0034	Pass
30		3.24	0.0017	Pass
40		7.37	0.0039	Pass
50		0.75	0.0004	Pass
20		3.55	1.29	0.0007
	4.35	2.72	0.0014	Pass

Band 4:

10 MHz Bandwidth					
Temperature (°C)	Power Supplied (V _{DC})	F _L (MHz)	F _H (MHz)	F _L Limit (MHz)	F _H Limit (MHz)
-30	3.8	1710.0223	1754.6013	1710	1755
-20		1710.1467	1754.6510	1710	1755
-10		1710.2176	1754.6220	1710	1755
0		1710.2100	1754.7634	1710	1755
10		1710.4203	1754.6300	1710	1755
20		1710.2771	1754.6709	1710	1755
30		1710.3760	1754.4369	1710	1755
40		1710.0578	1754.6006	1710	1755
50		1710.2456	1754.7213	1710	1755
20		3.55	1710.5415	1754.7311	1710
	4.35	1710.2034	1754.4277	1710	1755

Band 5:

10.0 MHz Middle Channel, $f_0=836.5\text{MHz}$				
Temperature (°C)	Voltage Supplied (V _{DC})	Frequency Error (Hz)	Frequency Error (ppm)	Limit (ppm)
-30	3.8	-6.64	-0.0079	2.5
-20		6.27	0.0075	2.5
-10		8.23	0.0098	2.5
0		-5.29	-0.0063	2.5
10		-3.40	-0.0041	2.5
20		9.21	0.0110	2.5
30		-3.86	-0.0046	2.5
40		7.54	0.0090	2.5
50		8.53	0.0102	2.5
20		3.55	9.17	0.0110
	4.35	5.60	0.0067	2.5

Band 7:

10 MHz Bandwidth					
Temperature (°C)	Power Supplied (V _{DC})	F _L (MHz)	F _H (MHz)	F _L Limit (MHz)	F _H Limit (MHz)
-30	3.8	2500.2273	2569.8025	2500	2570
-20		2500.1085	2569.6236	2500	2570
-10		2500.0570	2569.5174	2500	2570
0		2500.0384	2569.6301	2500	2570
10		2500.1927	2569.4115	2500	2570
20		2500.3209	2569.6243	2500	2570
30		2500.0982	2569.7493	2500	2570
40		2500.2390	2569.6621	2500	2570
50		2500.2579	2569.6722	2500	2570
20		3.55	2500.1144	2569.6438	2500
	4.35	2500.0712	2569.6330	2500	2570

Band 12:

10 MHz Bandwidth					
Temperature (°C)	Power Supplied (V _{DC})	F _L (MHz)	F _H (MHz)	F _L Limit (MHz)	F _H Limit (MHz)
-30	3.8	699.0769	715.6463	699	716
-20		699.0559	715.4793	699	716
-10		699.2166	715.4860	699	716
0		699.2322	715.5834	699	716
10		699.2380	715.5019	699	716
20		699.2637	715.6701	699	716
30		699.1958	715.6786	699	716
40		699.1618	715.6414	699	716
50		699.2384	715.7637	699	716
20	3.55	699.1968	715.6100	699	716
	4.35	699.0525	715.5764	699	716

Band 17:

10 MHz Bandwidth					
Temperature (°C)	Power Supplied (V _{DC})	F _L (MHz)	F _H (MHz)	F _L Limit (MHz)	F _H Limit (MHz)
-30	3.8	704.4263	715.6788	704	716
-20		704.5028	715.7191	704	716
-10		704.4639	715.6613	704	716
0		704.4193	715.7067	704	716
10		704.3801	715.6990	704	716
20		704.3683	715.6788	704	716
30		704.4964	715.7483	704	716
40		704.4914	715.6124	704	716
50		704.4288	715.6477	704	716
20	3.55	704.3816	715.7128	704	716
	4.35	704.3991	715.6196	704	716

Band 66

10 MHz Bandwidth					
Temperature (°C)	Power Supplied (V _{DC})	F _L (MHz)	F _H (MHz)	F _L Limit (MHz)	F _H Limit (MHz)
-30	3.8	1710.1786	1779.6274	1710	1780
-20		1710.1901	1779.7060	1710	1780
-10		1710.2145	1779.6768	1710	1780
0		1710.0388	1779.5452	1710	1780
10		1710.1685	1779.5493	1710	1780
20		1710.0580	1779.7035	1710	1780
30		1710.1014	1779.7001	1710	1780
40		1710.2318	1779.6859	1710	1780
50		1710.2498	1779.6665	1710	1780
20	3.55	1710.1947	1779.5300	1710	1780
	4.35	1710.0300	1779.5476	1710	1780

16QAM:

Band 2:

10.0 MHz Middle Channel, $f_0 = 1880\text{MHz}$				
Temperature (°C)	Voltage Supplied (V _{DC})	Frequency Error (Hz)	Frequency Error (ppm)	Result
-30	3.8	4.47	0.0024	Pass
-20		0.34	0.0002	Pass
-10		3.56	0.0019	Pass
0		6.29	0.0033	Pass
10		7.13	0.0038	Pass
20		6.41	0.0034	Pass
30		3.21	0.0017	Pass
40		7.37	0.0039	Pass
50		0.74	0.0004	Pass
20		3.55	1.29	0.0007
	4.35	2.69	0.0014	Pass

Band 4:

10 MHz Bandwidth					
Temperature (°C)	Power Supplied (V _{DC})	F _L (MHz)	F _H (MHz)	F _L Limit (MHz)	F _H Limit (MHz)
-30	3.8	1710.0740	1754.6641	1710	1755
-20		1710.2831	1754.6969	1710	1755
-10		1710.2997	1754.5635	1710	1755
0		1710.1604	1754.5847	1710	1755
10		1710.3808	1754.4956	1710	1755
20		1710.1599	1754.7586	1710	1755
30		1710.1775	1754.6330	1710	1755
40		1710.1965	1754.5665	1710	1755
50		1710.2103	1754.5082	1710	1755
20		3.55	1710.0557	1754.4830	1710
	4.35	1710.0286	1754.6421	1710	1755

Band 5:

10.0 MHz Middle Channel, $f_0=836.5\text{MHz}$				
Temperature (°C)	Voltage Supplied (V _{DC})	Frequency Error (Hz)	Frequency Error (ppm)	Limit (ppm)
-30	3.8	-6.66	-0.0080	2.5
-20		6.25	0.0075	2.5
-10		8.23	0.0098	2.5
0		-5.29	-0.0063	2.5
10		-3.42	-0.0041	2.5
20		9.20	0.0110	2.5
30		-3.86	-0.0046	2.5
40		7.51	0.0090	2.5
50		8.52	0.0102	2.5
20		3.55	9.17	0.0110
	4.35	2.69	0.0032	2.5

Band 7:

10 MHz Bandwidth					
Temperature (°C)	Power Supplied (V _{DC})	F _L (MHz)	F _H (MHz)	F _L Limit (MHz)	F _H Limit (MHz)
-30	3.8	2500.0170	2569.7415	2500	2570
-20		2500.0189	2569.7034	2500	2570
-10		2500.1708	2569.6815	2500	2570
0		2500.2058	2569.6693	2500	2570
10		2500.2421	2569.7014	2500	2570
20		2500.1016	2569.7956	2500	2570
30		2500.0623	2569.6647	2500	2570
40		2500.0490	2569.7132	2500	2570
50		2500.1491	2569.7460	2500	2570
20		3.55	2500.1705	2569.6463	2500
	4.35	2500.2996	2569.6643	2500	2570

Band 12:

10 MHz Bandwidth					
Temperature (°C)	Power Supplied (V _{DC})	F _L (MHz)	F _H (MHz)	F _L Limit (MHz)	F _H Limit (MHz)
-30	3.8	699.0546	715.7144	699	716
-20		699.3028	715.5576	699	716
-10		699.2661	715.6894	699	716
0		699.0544	715.7192	699	716
10		699.2668	715.6042	699	716
20		699.1491	715.6710	699	716
30		699.2262	715.7776	699	716
40		699.1750	715.6471	699	716
50		699.1439	715.5846	699	716
20	3.55	699.0946	715.6306	699	716
	4.35	699.1291	715.6382	699	716

Band 17

10 MHz Bandwidth					
Temperature (°C)	Power Supplied (V _{DC})	F _L (MHz)	F _H (MHz)	F _L Limit (MHz)	F _H Limit (MHz)
-30	3.8	704.3831	715.5819	704	716
-20		704.3893	715.5366	704	716
-10		704.3769	715.5565	704	716
0		704.3823	715.5394	704	716
10		704.4545	715.5406	704	716
20		704.3876	715.4973	704	716
30		704.4575	715.5540	704	716
40		704.5006	715.6230	704	716
50		704.4040	715.6476	704	716
20		3.55	704.3888	715.6051	704
	4.35	704.4074	715.5811	704	716

Band 66

10 MHz Bandwidth					
Temperature (°C)	Power Supplied (V _{DC})	F _L (MHz)	F _H (MHz)	F _L Limit (MHz)	F _H Limit (MHz)
-30	3.8	1710.2250	1779.6817	1710	1780
-20		1710.0327	1779.4920	1710	1780
-10		1710.1335	1779.7289	1710	1780
0		1710.0584	1779.7914	1710	1780
10		1710.8167	1779.5659	1710	1780
20		1710.0179	1779.4910	1710	1780
30		1710.1823	1779.4931	1710	1780
40		1710.1986	1779.7767	1710	1780
50		1710.1713	1779.6855	1710	1780
20		3.55	1710.0333	1779.5640	1710
	4.35	1710.1110	1779.6318	1710	1780

******* END OF REPORT *******